

SERVICE MANUAL

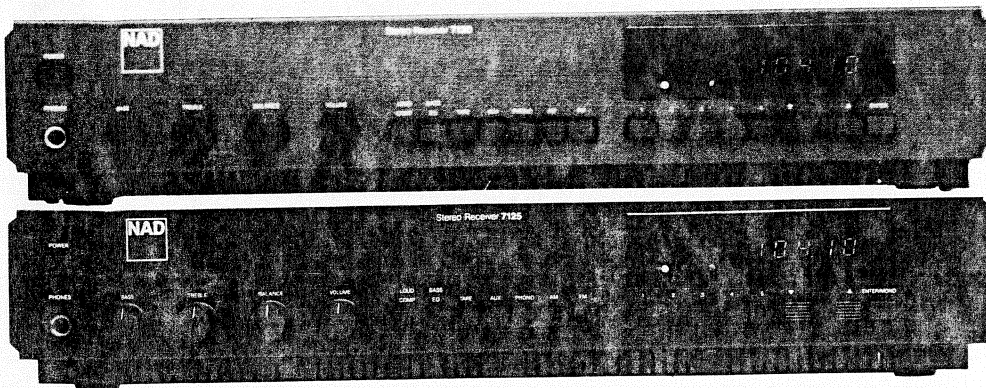

MODELS

7120

7125

1. Antenna Terminals
2. Phono Input
3. Phono Ground
4. Aux Input
5. Tape Rec/Play
6. DC Output
7. Speakers
8. Speaker Impedance
9. AC Power Cord
10. AC Convenience Outlet
(Not in U.K. Model)

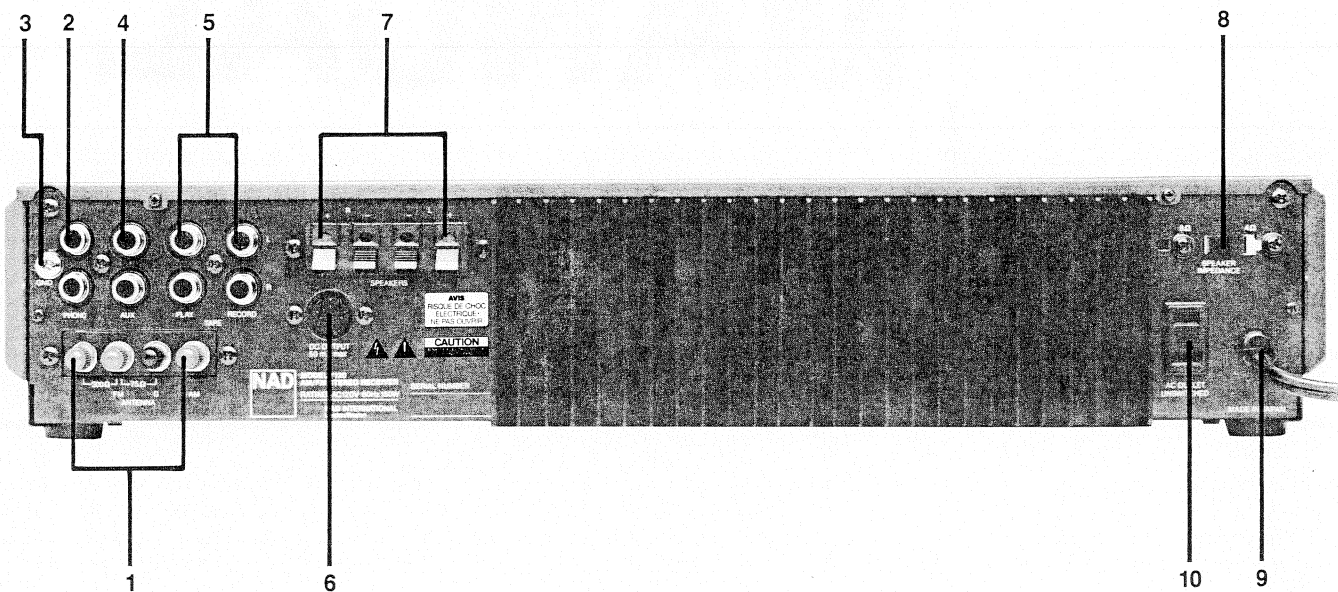

- | | |
|--------------------------|---|
| 1. Power | 9. Tape Monitor |
| 2. Phones | 10. Input Selector (Aux, Phono, AM, FM) |
| 3. Bass | 11. Tuning Pre-sets |
| 4. Treble | 12. Up/Down Tuning |
| 5. Balance | 13. Memory Enter |
| 6. Volume | 14. Tuning Display |
| 7. Loudness Compensation | 15. FM Stereo Beacon |
| 8. Bass Equalization | 16. Power Indicator |

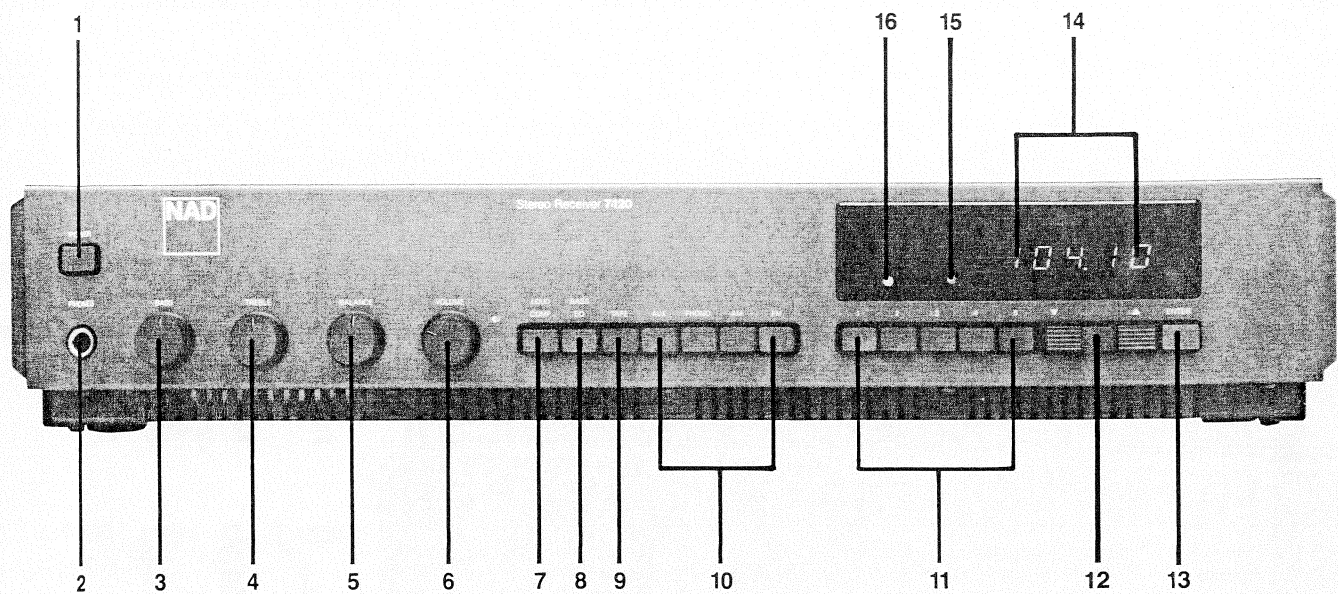

- 1. Antenna Terminals
- 2. Phono Input
- 3. Phono Ground
- 4. Aux Input
- 5. Tape Rec/Play
- 6. Speakers
- 7. Speaker Impedance
- 8. AC Power Cord
- 9. AC Convenience Outlet (Not in U.K. model)

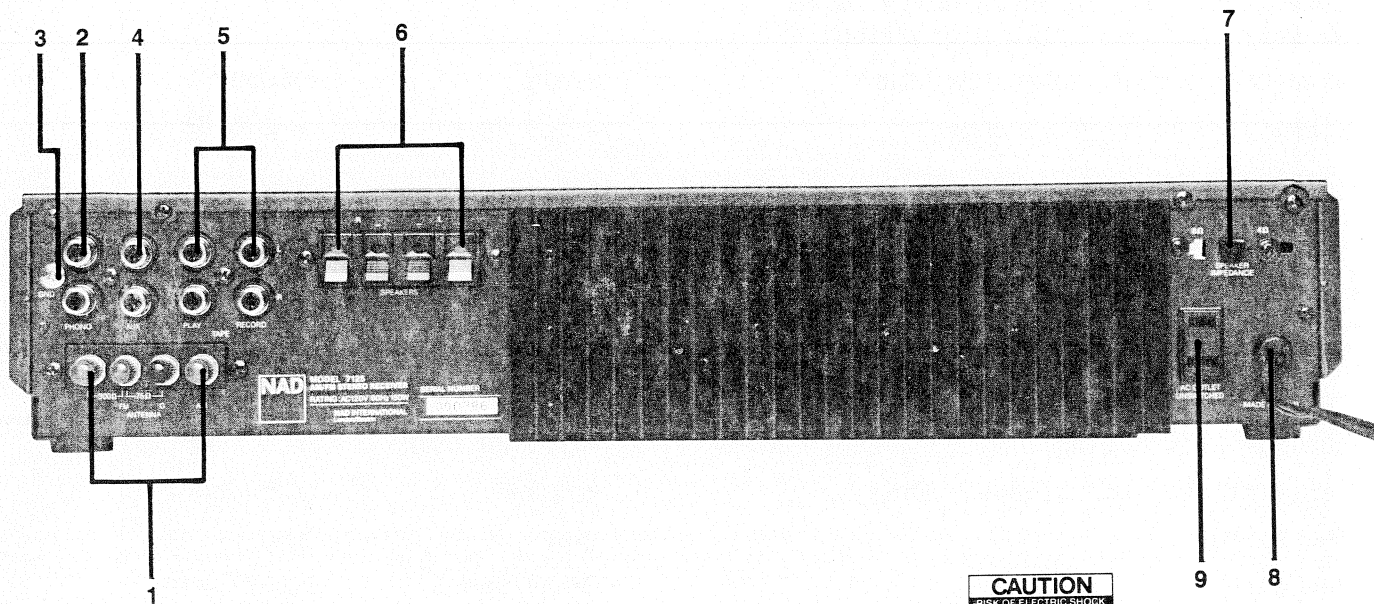

CAUTION
 RISK OF ELECTRIC SHOCK
 DO NOT OPEN

CAUTION: TO REDUCE THE RISK OF ELECTRIC SHOCK, DO NOT REMOVE COVER (OR BACK). NO USER-SERVICEABLE PARTS INSIDE. REFER SERVICING TO QUALIFIED SERVICE PERSONNEL.

- 1. Power
- 2. Phones
- 3. Bass
- 4. Treble
- 5. Balance
- 6. Volume
- 7. Loudness Compensation
- 8. Bass Equalization
- 9. Tape Monitor
- 10. Input Selector (Aux, Phono, AM, FM)
- 11. Tuning Pre-sets
- 12. Up/Down Tuning
- 13. Memory Enter/Mono
- 14. Tuning Display
- 15. FM Stereo Beacon
- 16. Power Indicator

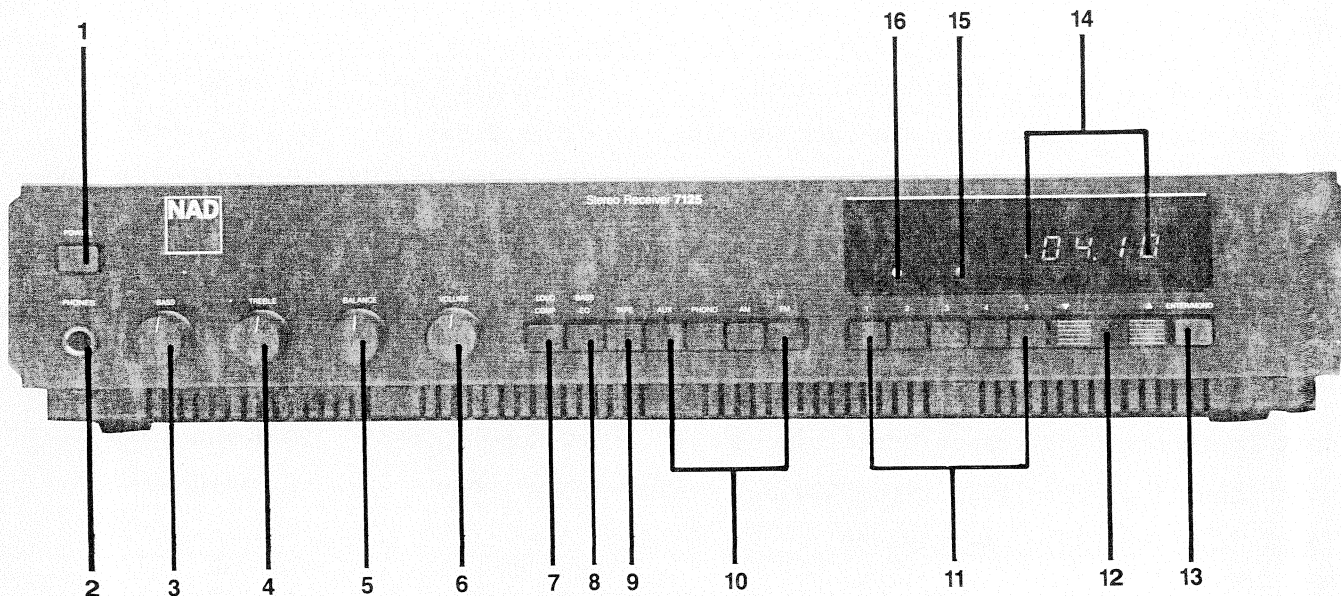

SPECIFICATIONS

<u>AMPLIFIER SECTION</u>		<u>7120</u>	<u>7125</u>
Continuous Average Power Output at 8 Ohms (min. RMS Power per Channel, 20-20 kHz, both channels drive, with no more than the Rated Distortion)		20W (13 dBW)	25W (13 dBW)
Rated Distortion, 20-20 kHz, THD		0.05%	0.05%
Clipping Headroom at 8 ohms		+ 1.5 dB	+ 2.5 dB
Clipping Power (Maximum Continuous Power per Channel)	8 ohms 4 ohms	28W 37W	36W 32W
Dynamic Headroom at 8 ohms		+ 4 dB	+ 3 dB
Dynamic Power (Maximum Short-term Power per channel)	8 ohms 4 ohms	50W 58W	50W 50W
Reactive Load Rating		+ 1.7 dB (30W)	+ 1.7 dB (30W)
Transient Overload Recovery Time		< 5μsec.	< 5μ sec.
Slew Factor		>50	>50
Slew Rate		>15V/μsec.	>15V/μsec.
Damping Factor (ref. 8 ohms)		>50	>50
THD (Total Harmonic Distortion, 20-20 kHz) from 250 mW to Rated Output		< 0.05%	< 0.05%
SMPTE IM (Intermodulation Distortion, 60Hz + 7kHz, 4:1), from 250mW to Rated Output.		< 0.02%	< 0.02%
IHF IM (CCIF IM Distortion, 19k + 20 kHz) at Rated Output.		< 0.02%	< 0.02%
T.I.M. (Transient Intermodulation Distortion, 15kHz sine + 3.18kHz Square Wave) at Rated Output.		< 0.02%	< 0.02%
PHONO INPUT			
Input Impedance (Resistance/Capacitance)		47 Kohm/100pF	47 Kohm/100pF
Input Sensitivity (1kHz) for 1W out/20W out		0.5mV/2.5mV	0.5mV/2.5mV
Input Overload at 20Hz/1kHz/20kHz		15mV/140mV/1.15V	15mV/140mV/1.15V
RIAA Response Accuracy		±0.3 dB	±0.3 dB
Signal-to-Noise Ratio, A-Weighted with Phono Cartridge Connected ref 5mV.		75 dB	75 dB
HIGH LEVEL INPUTS (AUX, TAPE)			
Input Impedance (Resistance/Capacitance)		20 Kohm/100pF	20 Kohm/100pF
Input Sensitivity for 1W out/for 20W out		30mV/150mV	30mV/150mV
Signal-to-Noise Ratio, A-weighted Ref. 1W out		>86 dB	>86 dB
Ref. 20W out		>96 dB	>96 dB
Frequency Response, 20-20kHz		±0.5 dB	±0.5 dB

TAPE OUTPUT

Output Impedance 350 ohm 350 ohm

CONTROLS

Bass Control Range		±10dB at 50Hz	±10dB at 50Hz
Treble Control Range		± 7dB at 10kHz	± 7dB at 10kHz
Infrasonic Filter	Turnover frequency	15 Hz	20 Hz
	Slope	12 dB/Octave	12 dB/Octave
Ultrasonic Filter	Turnover frequency	35kHz	35kHz
	Slope	12 dB/Octave	12 dB/Octave
Bass EQ		+5 dB at 35Hz	+ 5 dB at 50Hz

TUNER SECTION

FM SECTION

Input Sensitivity, IHF, usable sensitivity		1.9µV (10.8dBf)	1.9µV (10.8dBf)
	50dB quieting mono	3.0µV (14.8dBf)	3.0µV (14.8dBf)
	50dB quieting stereo	30 µV (34.8dBf)	30 µV (34.8dBf)
Signal-to-Noise Ratio (A-weighted, at 65dBf)			
	Mono/Stereo	80dB/75dB	80dB/75dB
Frequency Response	30-15 kHz	±0.5dB	± 0.5dB
De-emphasis Accuracy (75µsec.)		±0.3dB	± 0.3dB
Channel Separation,	1kHz	42dB	42dB
	30-15kHz	32dB	32dB
Selectivity, Alternate Channel (400kHz)		65dB	65dB
AM Suppression at 45dBf and 65dBf		60dB	65dB
Capture Ratio at 45dBf and 65dBf		1.5dB	1.5dB
Image Rejection		50dB	60dB
IF Rejection		75dB	75dB
SCA Rejection		70dB	70dB
Pilot Signal Suppression		65dB	65dB
THD at 100% Modulation:	1kHz Mono/Stereo	0.2%/0.3%	0.2%/0.3%
	100Hz Mono/Stereo	0.2%/0.3%	0.2%/0.3%
	6kHz Mono/Stereo	0.3%/0.4%	0.3%/0.4%

AM SECTION

Usable Sensitivity		250µV	250µV
Selectivity		30dB	30dB
Image Rejection		50dB	50dB
I.F. Rejection		40dB	40dB

PHYSICAL SPECIFICATION : (H) x (W) x (D) 8.3 cm x 42 cm x 28.8 cm
3.25in x 16.5in x 11.25in

Net Weight 5.2 kg. / 11.5 lbs.

Power Requirements : 50/60 Hz, 110-120V AC
(Not Convertible) 50 Hz, 220V AC
50 Hz, 240V AC

ALIGNMENT METHOD

AUDIO SECTION 7120/7125

IMPORTANT

Speaker Impedance switch should be in 8 ohm position while adjusting center voltage and idling current.

INITIAL ADJUSTMENT (No load connected)

CENTER VOLTAGE

1. Connect DC millivoltmeter to L channel output terminals. Turn on and adjust to $0\text{ V} \pm 30\text{mV}$ with VR101. Connect DC millivoltmeter to R channel output terminals and adjust VR201 to $0\text{ V} \pm 30\text{mV}$.

IDLING CURRENT

2. Connect DC millivoltmeter across R150 (output transistor's emitter resistor) and adjust VR102 for 2-4mV reading on meter. Repeat adjustment with VR202 connecting meter across R250.
3. Leave power on for minimum 5 minutes.

FINAL ADJUSTMENT

CENTER VOLTAGE

4. Repeat step 1 above.

IDLING CURRENT

5. Repeat step 2 and adjust with VR102 for 4mV reading on meter.

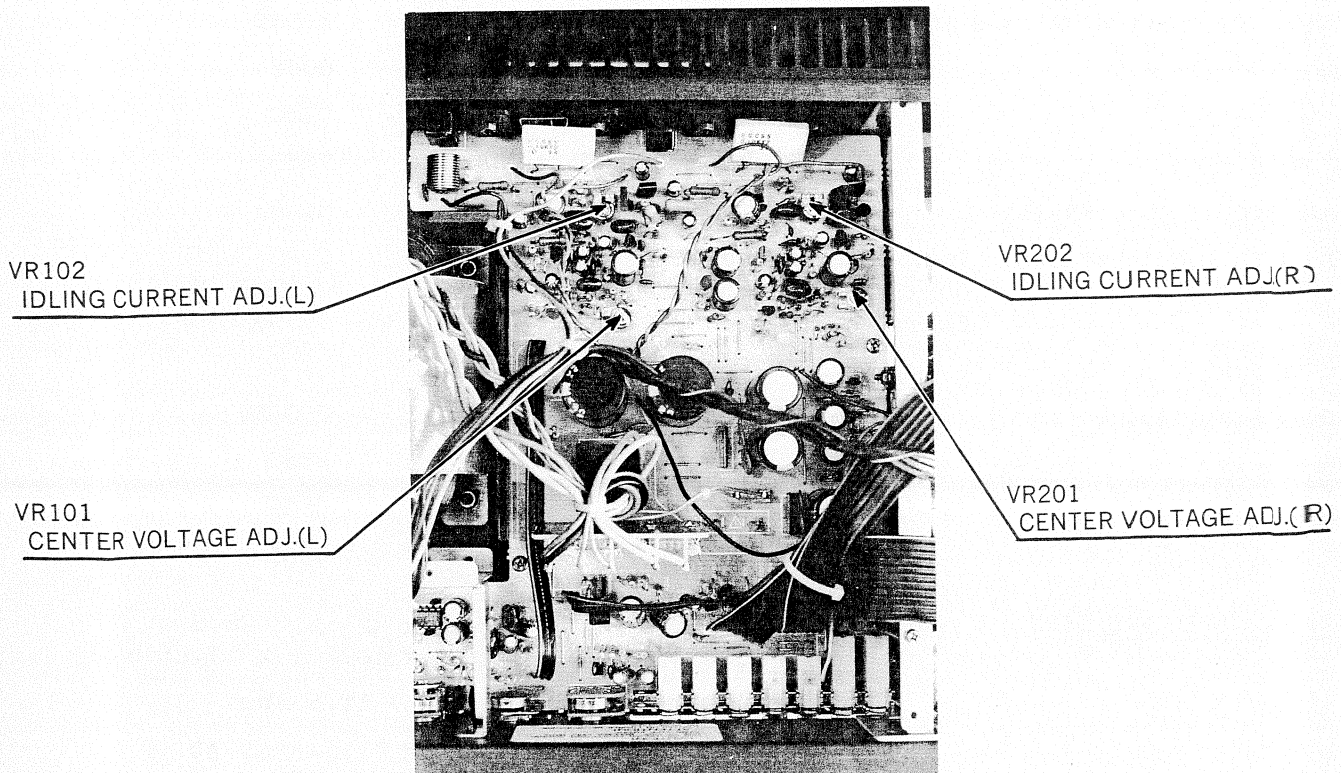

AM SECTION 7120/7125

Unless repairs have been done to Oscillator Section, do not adjust AM OSC coil or Trimming Capacitor.

If OSC Adjustment is needed, connect high impedance voltmeter (preferably DMM) between R42 and ground.

OSC ADJUSTMENT

1. Tune unit to show 1610KHz or 1602KHz on display and adjust L7 to read 7.5V on DMM.
2. Tune unit to show 520KHz or 522KHz on display and check if it reads $1V \pm 0.5V$ on DMM.

IF ADJUSTMENT

3. For IF adjustment and Tracking adjustment connect VTVM to loudspeaker output (or tape output), only one channel connection needed, and connect signal generator to antenna terminals. Adjust generator for 30% modulation and approx. 100 μ V input.

Tune both generator and receiver to approx. 1000KHz, and adjust generator frequency for maximum reading on VTVM. Then adjust L9 and L8 (A and B) for maximum reading on meter.

TRACKING ADJUSTMENT

4. Tune unit and generator to show approx. 620KHz and adjust L6 to maximum reading on VTVM.
5. Tune unit and generator to show approx. 1400KHz and adjust CT1 (Trimming Capacitor) for maximum reading on VTVM.
6. Repeat step 4 and 5 so that both are peaked.

WARNING:

Generator output should be low enough to avoid AGC circuit to function and determine the meter reading. This will mean that the output signal should sound and look (if observed on an oscilloscope) noisy.

9/10 KHz FILTER ADJUSTMENT

7. Modulate generator 9KHz and adjust L10 (Green Core) to minimum reading on VTVM.
8. Modulate generator 10KHz and adjust L10 (Black Core) to minimum reading on VTVM.

L7
OSC ADJ.

L6
TRACKING ADJ.

L8(A)
IF ADJ.

L8(B)
IF ADJ.

CT1
RF TRACKING ADJ.

L9
IF ADJ.

L10(G)
9KHz FILTER ADJ.

L10(B)
10KHz FILTER ADJ.

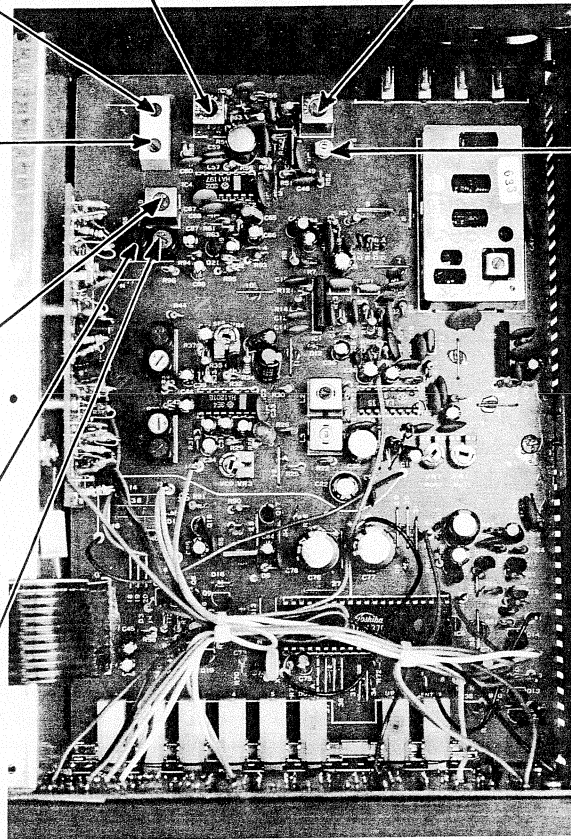

RF AND OSCILLATOR ADJUSTMENT

1. Tuner RF and Oscillator should not be adjusted, they are preset from the factory. If tuner front-end has been replaced, the new front-end needs only IF adjustment.

IF ADJUSTMENT

2. Connect FM generator to 300 ohm input via proper impedance matching transformer or network.
3. Connect VTVM's (and oscilloscope if so desired) and distortion analyzer to speaker outputs or tape outputs. Both channels needed, but not necessary at the same time.
4. To adjust IF output from front-end, set receiver and generator to approx. 98MHz and generator output to 1 μ V with 100% modulation, 1 KHz (or 400 Hz). Adjust IF coil to maximum output on VTVM, observing on oscilloscope that the curve should show considerable noise, however, it should be easy to observe audio signal level changes despite the noise.

WARNING:

This adjustment must be done below the tuners limiting point (This is the point where audio output does not increase even with increased output from generator).

DETECTOR ADJUSTMENT

5. Set output from generator to approx. 1mV. Adjust L2 for maximum output at 1KHz (or 400Hz) and adjust L3 for minimum distortion. Repeat the L2 and L3 adjustments until no further improvements. Typical output on tape-output will be 0.5 to 0.8V and 0.1% or less THD.
6. Turn VR1 fully anticlockwise.

MPX ADJUSTMENT

7. Connect high impedance frequency-counter (100K ohm or more) to test point VCO (between R28 and VR3) and generator input at 100 - 1000 μ V no modulation (not even 19KHz) and adjust VCO to 76KHz \pm 10Hz by means of VR3.
8. Set generator pilot-tone modulation to 6 - 8% (level has no effect on Stereo Separation) and while adjusting generator output from 1 μ V and up, adjust VR2 for stereo-light to turn on around 15 μ V. When adjusting generator output from high (approx. 100 μ V) and going down, stereo light should turn off between 5 - 10 μ V.
9. Set generator to 1mV 100% modulation, 1 KHz (or 400 Hz) Stereo L or R. Adjust VR4 for maximum level difference between left and right channel on the meter. Repeat adjustment until separation is approximately identical for L to R and R to L channel (Typical performance 45 - 55 dB separation).

HIGH-BLEND ADJUSTMENT

10. Set generator to 100 μ V and adjust VR801 (on center-wall mounted PCB) so that no blend is obtained. Turn generator down while observing both outputs. High blend should turn on around 50/60 μ V to obtain a separation reading of approx. 14dB at 1 KHz.(or 400 Hz). Make sure that high-blend turns off safely as generator output is increased to 100 μ V and above.

19/38KHz FILTERS ADJUSTMENT

11. With 19KHz modulation only and 1mV output from generator, adjust L4 (left channel) and L5 (right channel) for minimum THD on analyzer; or observed on an oscilloscope, adjust for minimum noise on the curve (a straight line); or observed on VTVM, adjust for minimum output.

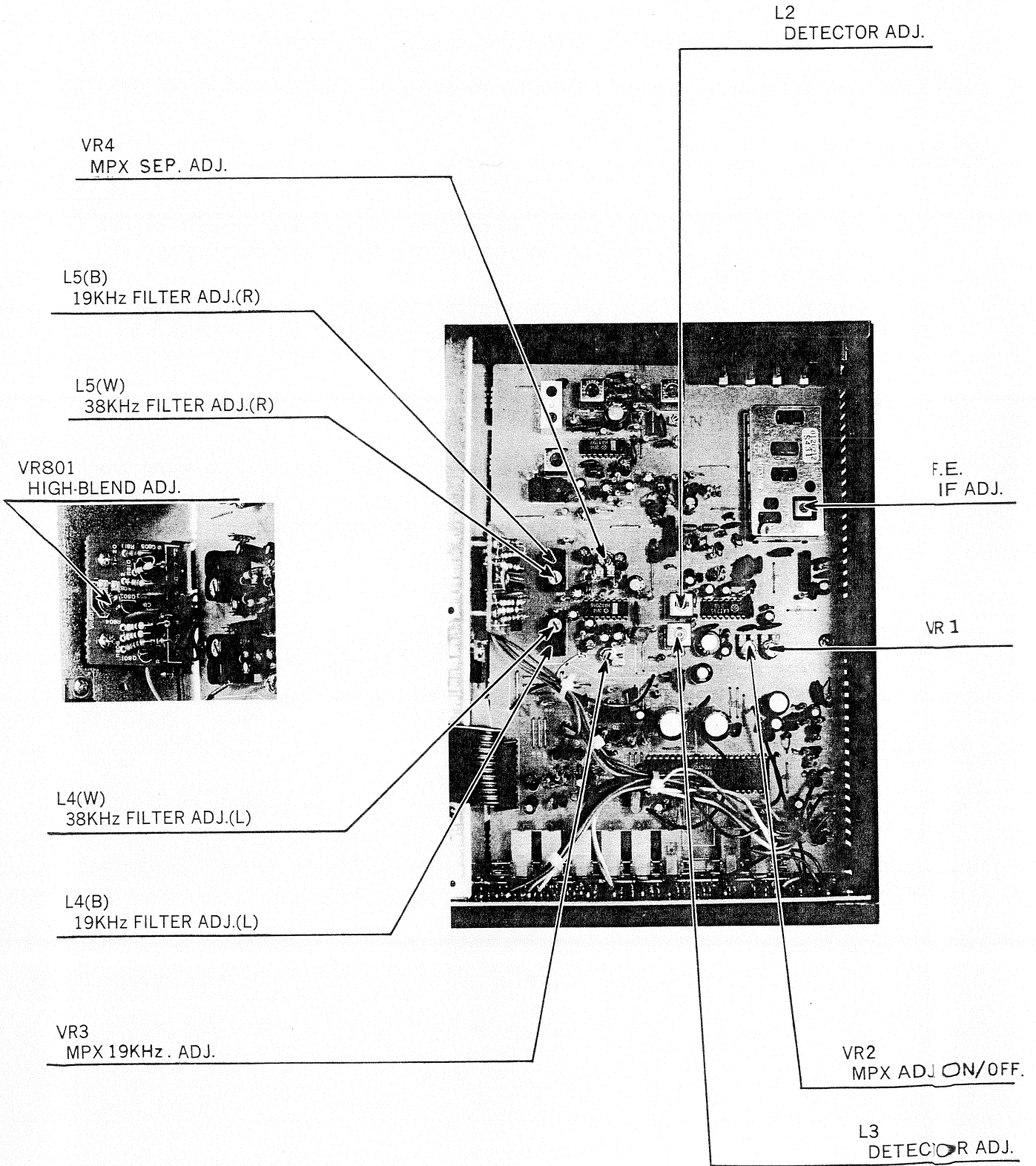

RF AND OSCILLATOR ADJUSTMENT

1. (Same as 7120)

IF ADJUSTMENT

2. (Same as 7120)
3. (Same as 7120)
4. (Same as 7120)

DETECTOR ADJUSTMENT

5. Set output from generator to approx. 1mV, and tune generator to the exact frequency of the receiver display. This requires either a digital readout generator or a frequency counter to set generator frequency. If neither is available (or inconvenient), tune receiver to a known station preferably around midband (98MHz). Adjust L2 so that decimal point on display stops flashing. By means of receiver tuning, go one step up (+50KHz) and one step down (-50KHz), check and make sure (by minor adjustment of L2) that decimal-point starts flashing on either side tune.
6. With 1 KHz 100% modulation and 1mV output from generator, adjust L3 for minimum distortion (0.08-0.12% typical). Do not adjust L2 again at this point, but go back and check decimal point as per step 5. If it reads incorrectly, repeat step 5 and 6.
7. Set output from generator to 2μV and adjust VR1 so that decimal point does not flash above 2μV (assuming of course that generator is tuned to correct frequency) At 3uV check decimal point flashing by side tuning ±50KHz again.

MPX ADJUSTMENT

8. (Same as step 7, 7120)
9. (Same as step 8, 7120)
10. (Same as step 9, 7120)

HIGH-BLEND ADJUSTMENT

11. (Same as step 10, 7120)

19/38 KHz FILTERS

12. (Same as step 11, 7120)

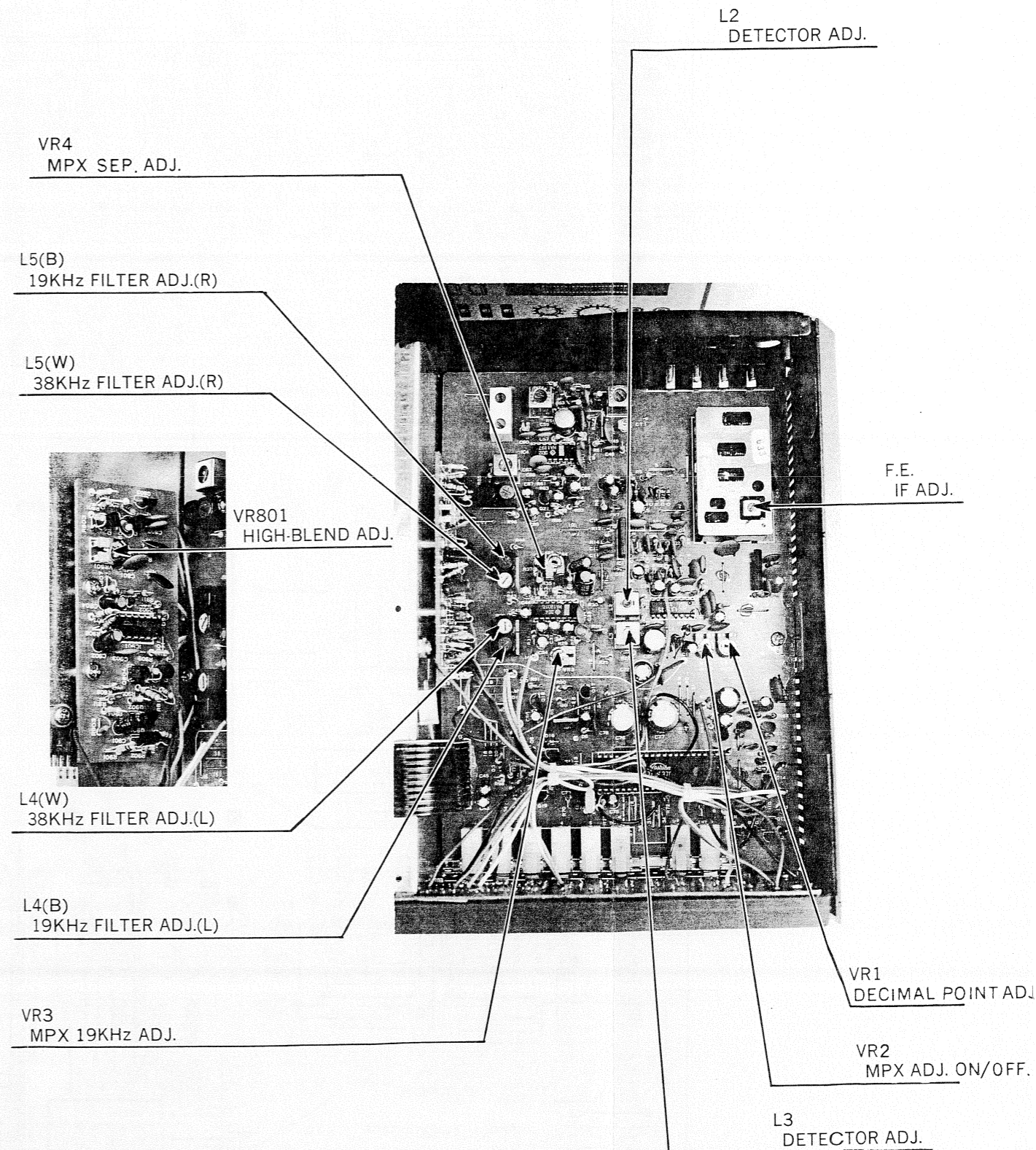

AMPLIFIER PCB NAD7120

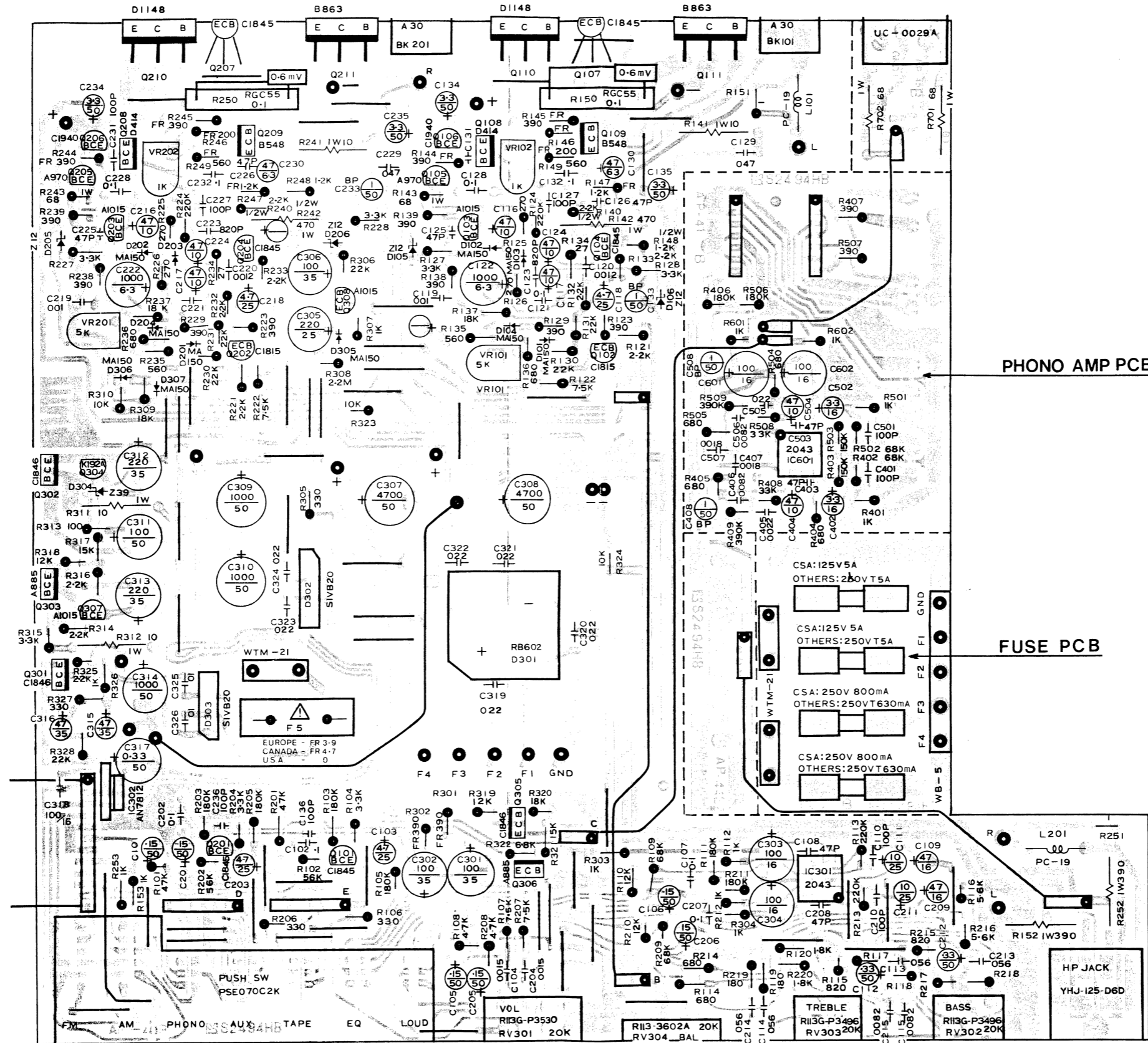

SCHEMATIC DIAGRAM NAD7120 AMPLIFIER

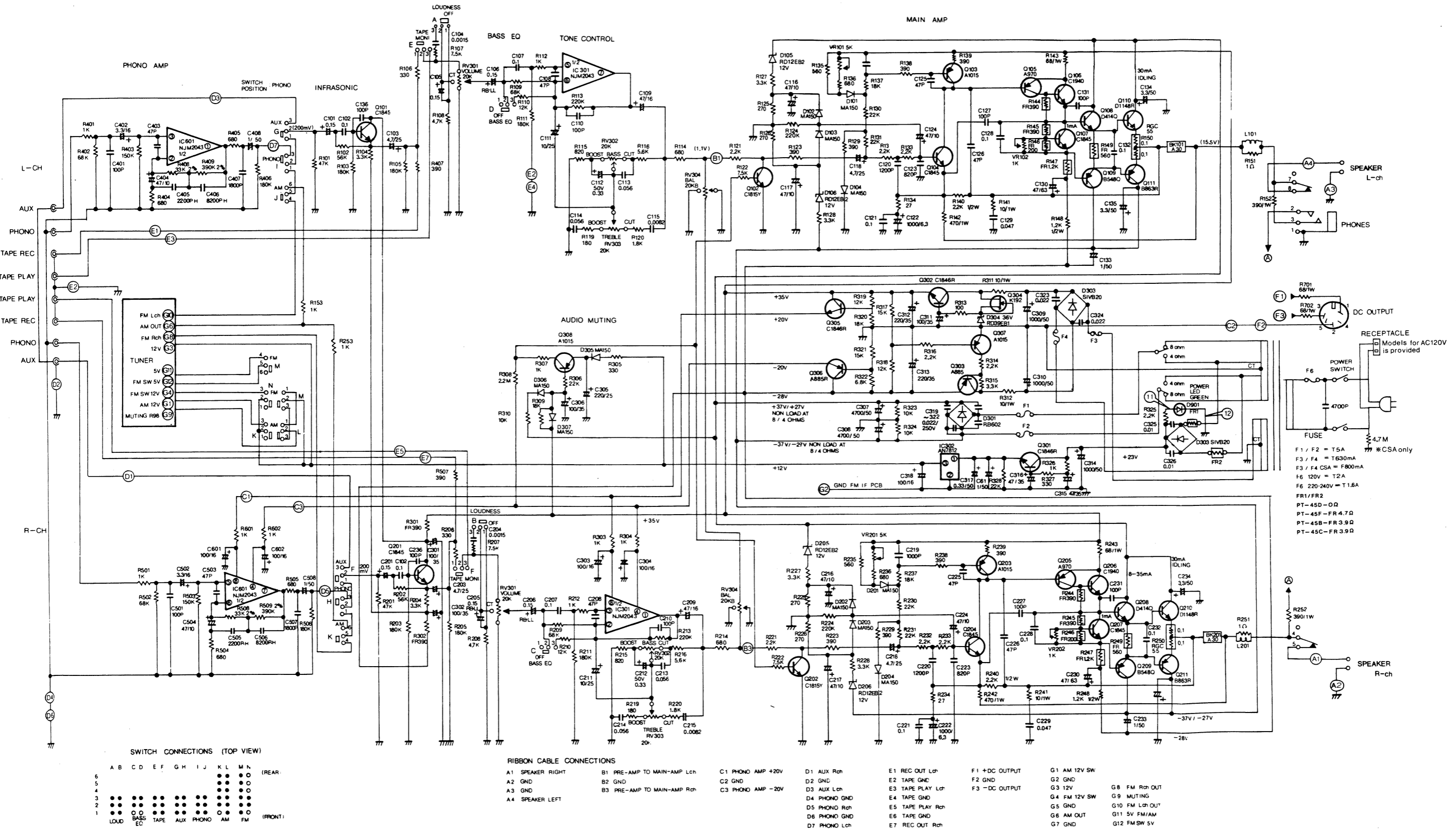

TUNER PCB NAD7120

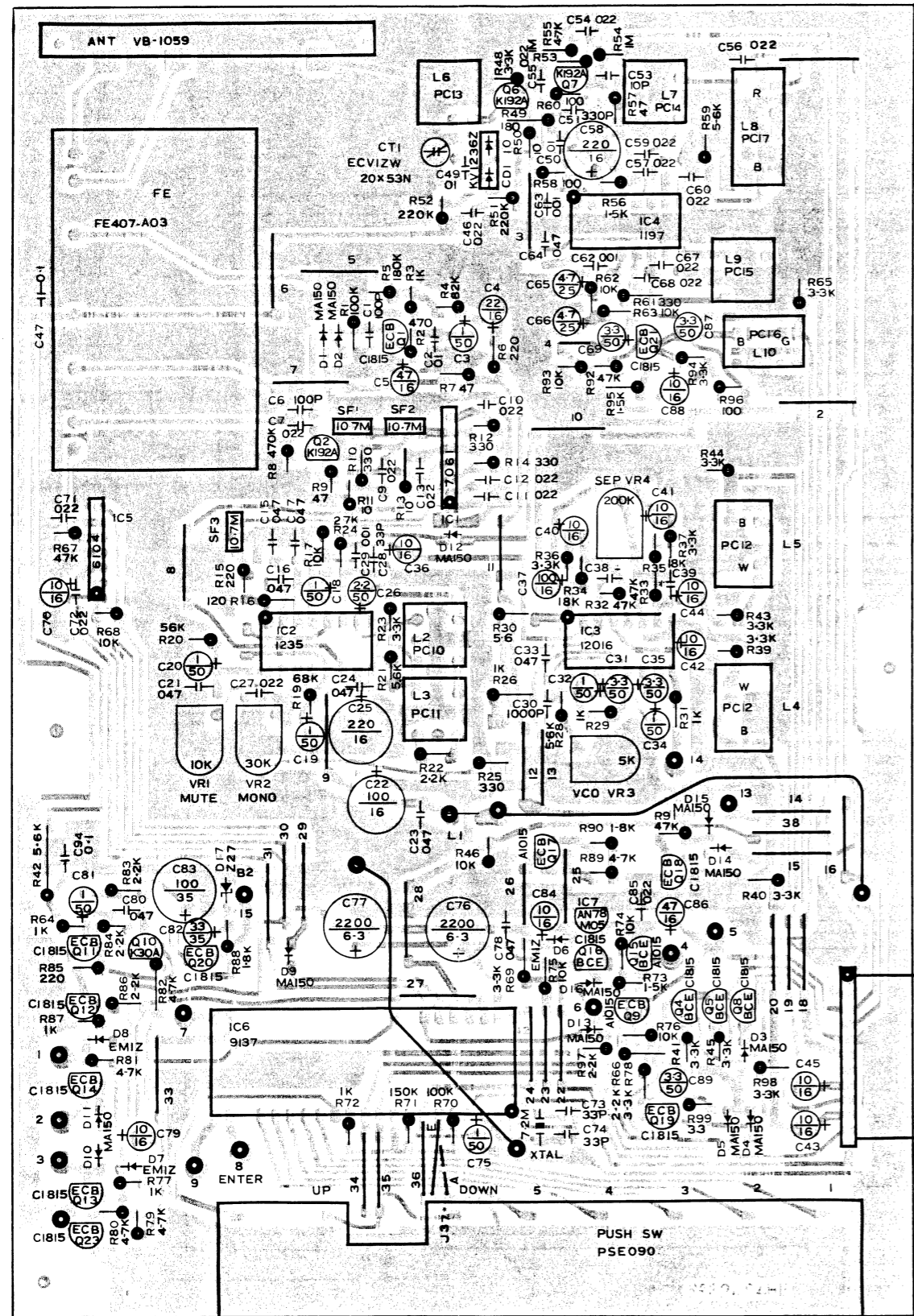

* EUROPE J37 E = R0 . C38, C39 = 0-001
 * AMERICA J37 A = R36K. C38, C39 = 0-0015

HI-BLEND PCB

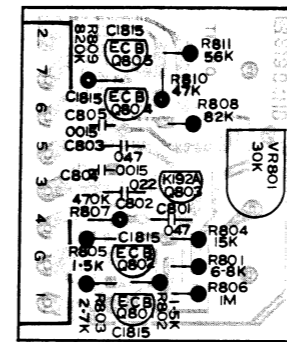

DISPLAY PCB

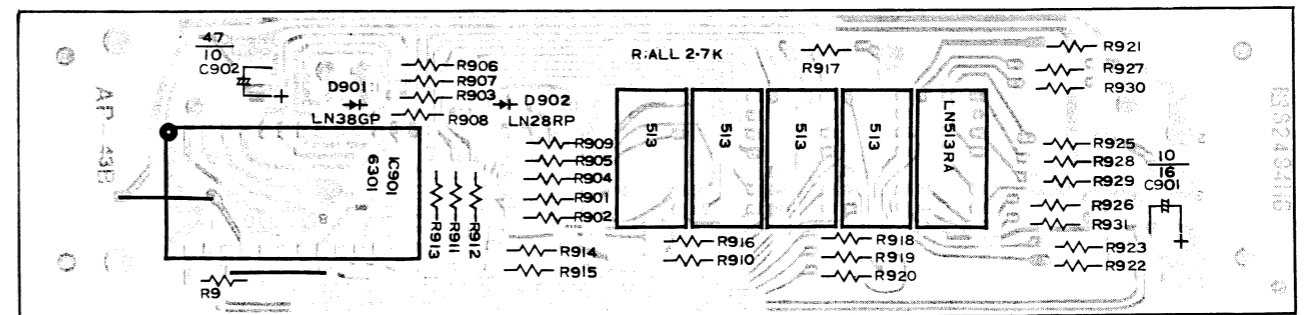

SCHEMATIC DIAGRAM NAD7120 TUNER

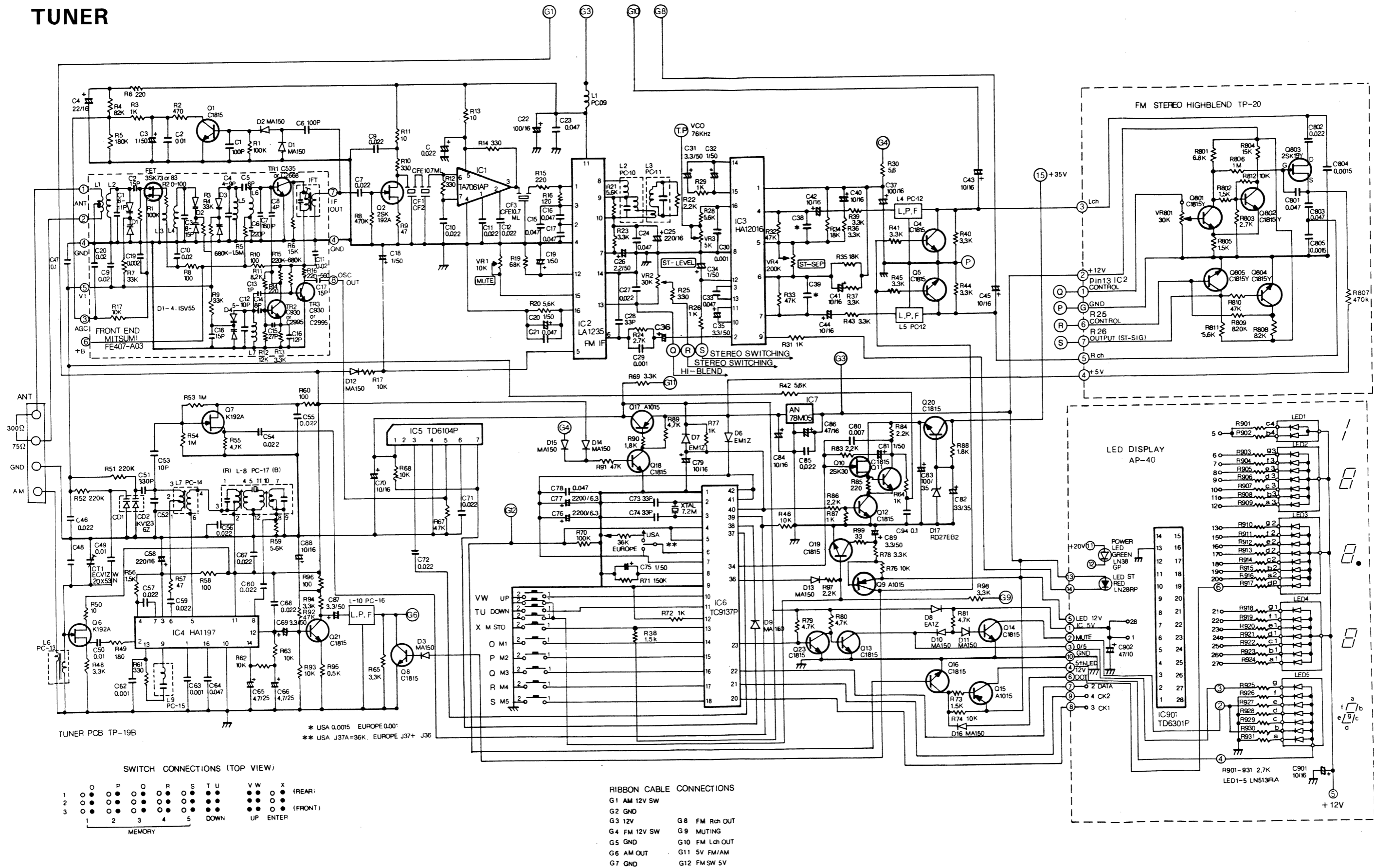

AMPLIFIER PCB NAD7125

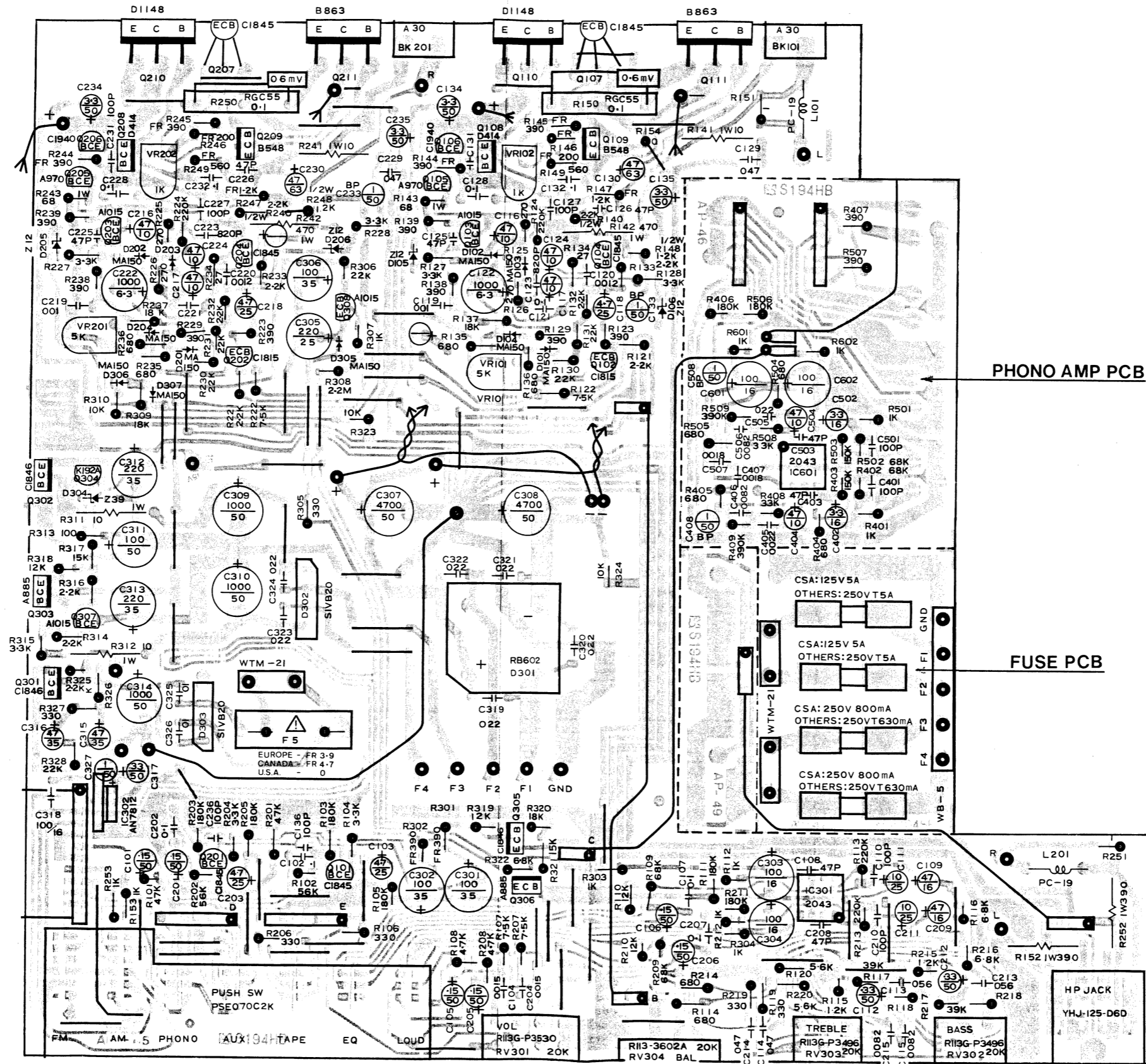

SCHEMATIC DIAGRAM NAD7125 AMPLIFIER

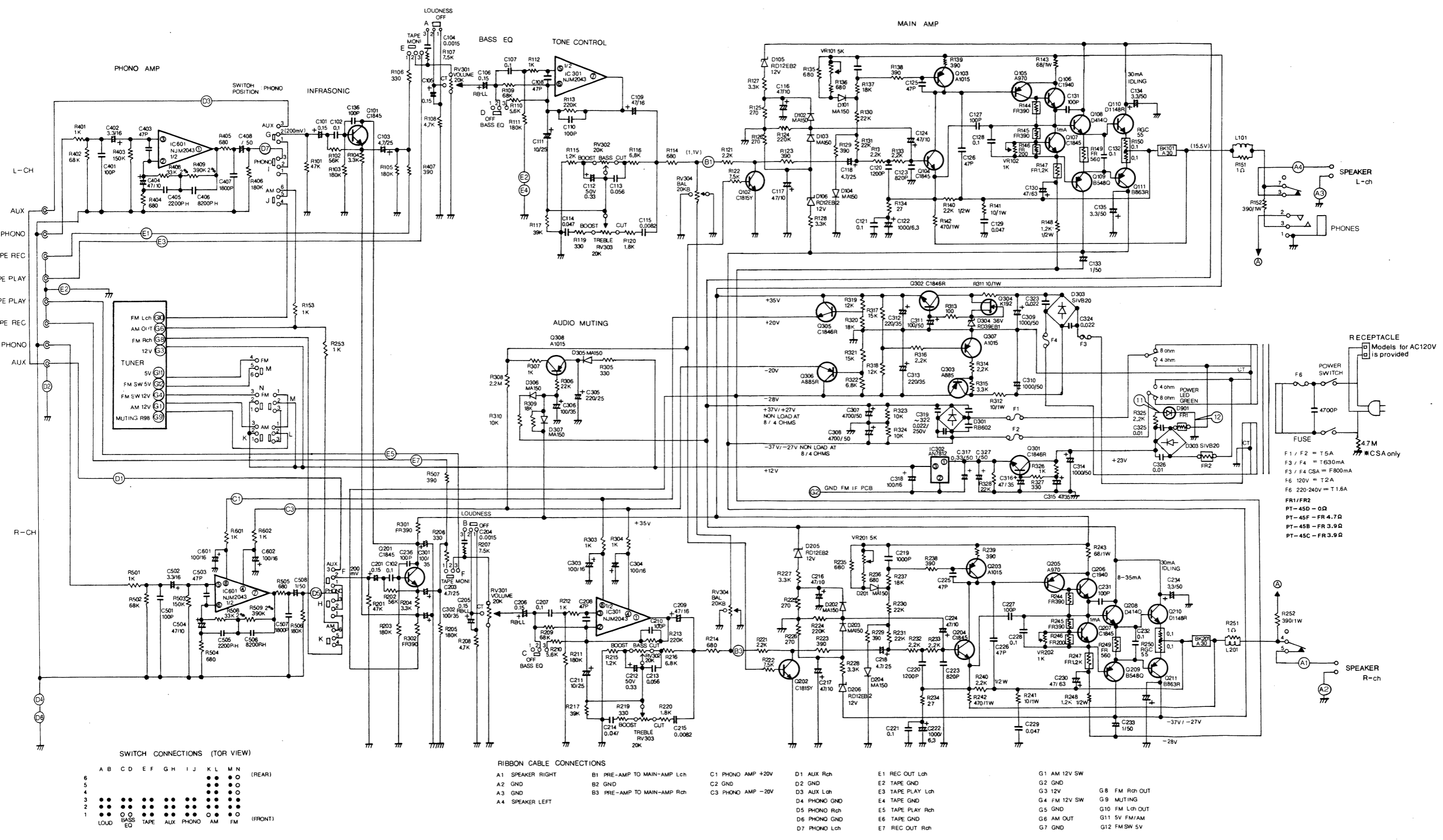

RECEPTACLE Models for AC120V is provided

FUSE
F1 / F2 = T.5A
F3 / F4 = T.630mA
F5 / F6 = T.2A
F7 = 220-240V = T.1.6A
FR1/FR2 PT-45D - 0Ω
PT-45F - FR 4.7Ω
PT-45B - FR 3.9Ω
PT-45C - FR 3.9Ω

POWER LED GREEN
D901
FR1
FR2
FR3
FR4
FR5
FR6
FR7
FR8
FR9
FR10
FR11
FR12
FR13
FR14
FR15
FR16
FR17
FR18
FR19
FR20
FR21
FR22
FR23
FR24
FR25
FR26
FR27
FR28
FR29
FR30
FR31
FR32
FR33
FR34
FR35
FR36
FR37
FR38
FR39
FR40
FR41
FR42
FR43
FR44
FR45
FR46
FR47
FR48
FR49
FR50
FR51
FR52
FR53
FR54
FR55
FR56
FR57
FR58
FR59
FR60
FR61
FR62
FR63
FR64
FR65
FR66
FR67
FR68
FR69
FR70
FR71
FR72
FR73
FR74
FR75
FR76
FR77
FR78
FR79
FR80
FR81
FR82
FR83
FR84
FR85
FR86
FR87
FR88
FR89
FR90
FR91
FR92
FR93
FR94
FR95
FR96
FR97
FR98
FR99
FR100

SWITCH CONNECTIONS (TOR VIEW)

A	B	C	D	E	F	G	H	I	J	K	L	M	N
6	•	•	•	•	•	•	•	•	•	•	•	•	•
5	•	•	•	•	•	•	•	•	•	•	•	•	•
4	•	•	•	•	•	•	•	•	•	•	•	•	•
3	•	•	•	•	•	•	•	•	•	•	•	•	•
2	•	•	•	•	•	•	•	•	•	•	•	•	•
1	•	•	•	•	•	•	•	•	•	•	•	•	•

LOUDNESS
BASS EQ
TAPE
AUX
PHONO
AM
FM (FRONT)

RIBBON CABLE CONNECTIONS

A1	SPEAKER RIGHT	B1	PRE-AMP TO MAIN-AMP Lch	C1	PHONO AMP +20V	D1	AUX Rch	E1	REC OUT Lch	G1	AM 12V SW
A2	GND	B2	GND	C2	GND	D2	GND	E2	TAPE GND	G2	GND
A3	GND	B3	PRE-AMP TO MAIN-AMP Rch	C3	PHONO AMP -20V	D3	AUX Lch	E3	TAPE PLAY Lch	G3	12V
A4	SPEAKER LEFT					D4	PHONO GND	E4	TAPE GND	G4	FM 12V SW
						D5	PHONO Rch	E5	TAPE PLAY Rch	G5	GND
						D6	PHONO GND	E6	TAPE GND	G6	AM OUT
						D7	PHONO Lch	E7	REC OUT Rch	G7	GND
										G8	FM Rch OUT
										G9	MUTING
										G10	FM Lch OUT
										G11	5V FM/AM
										G12	FM SW 5V

TUNER PCB NAD7125

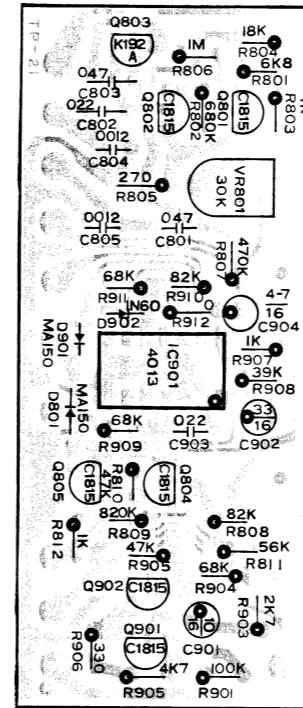
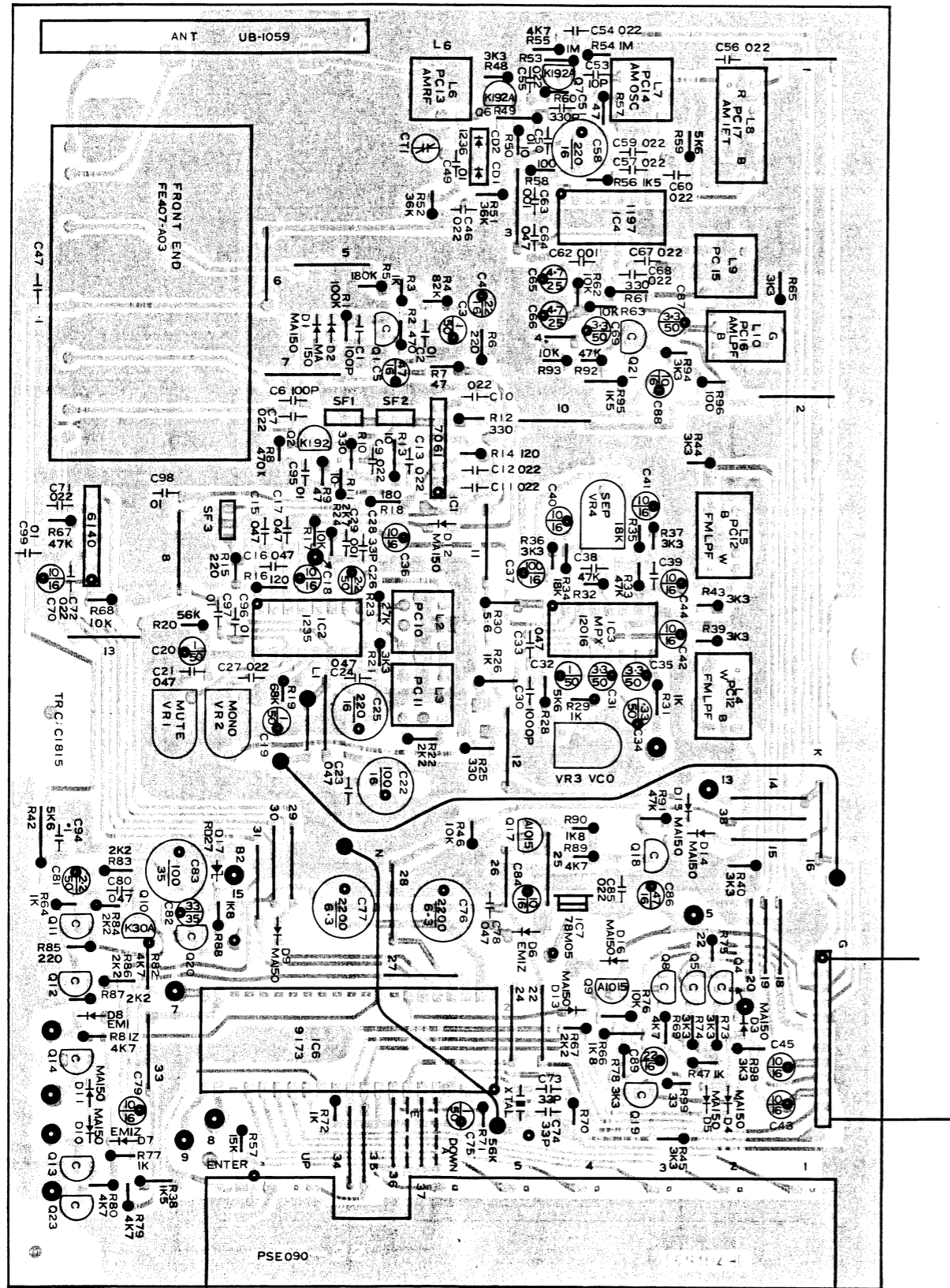

FLICKER PCB
HI-BLEND
CENTER TUNING
STEREO/MONO SWITCHING

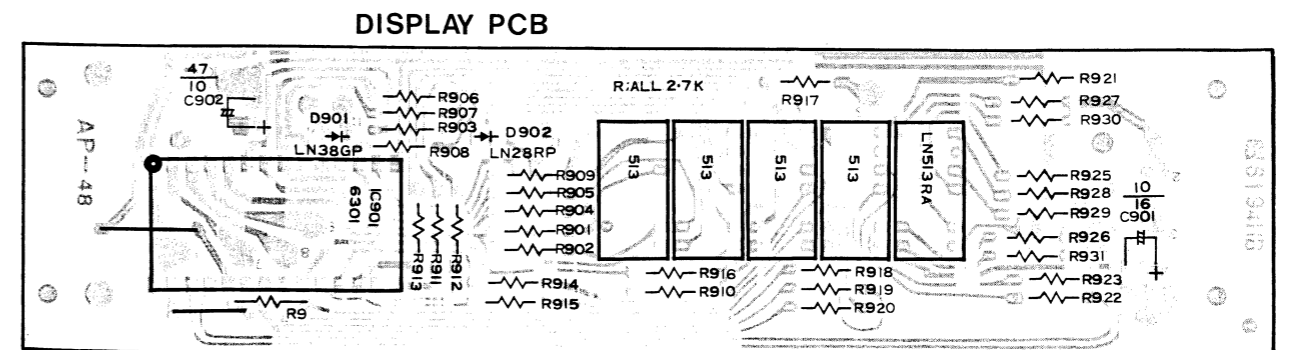

WIRING DIAGRAM NAD7120

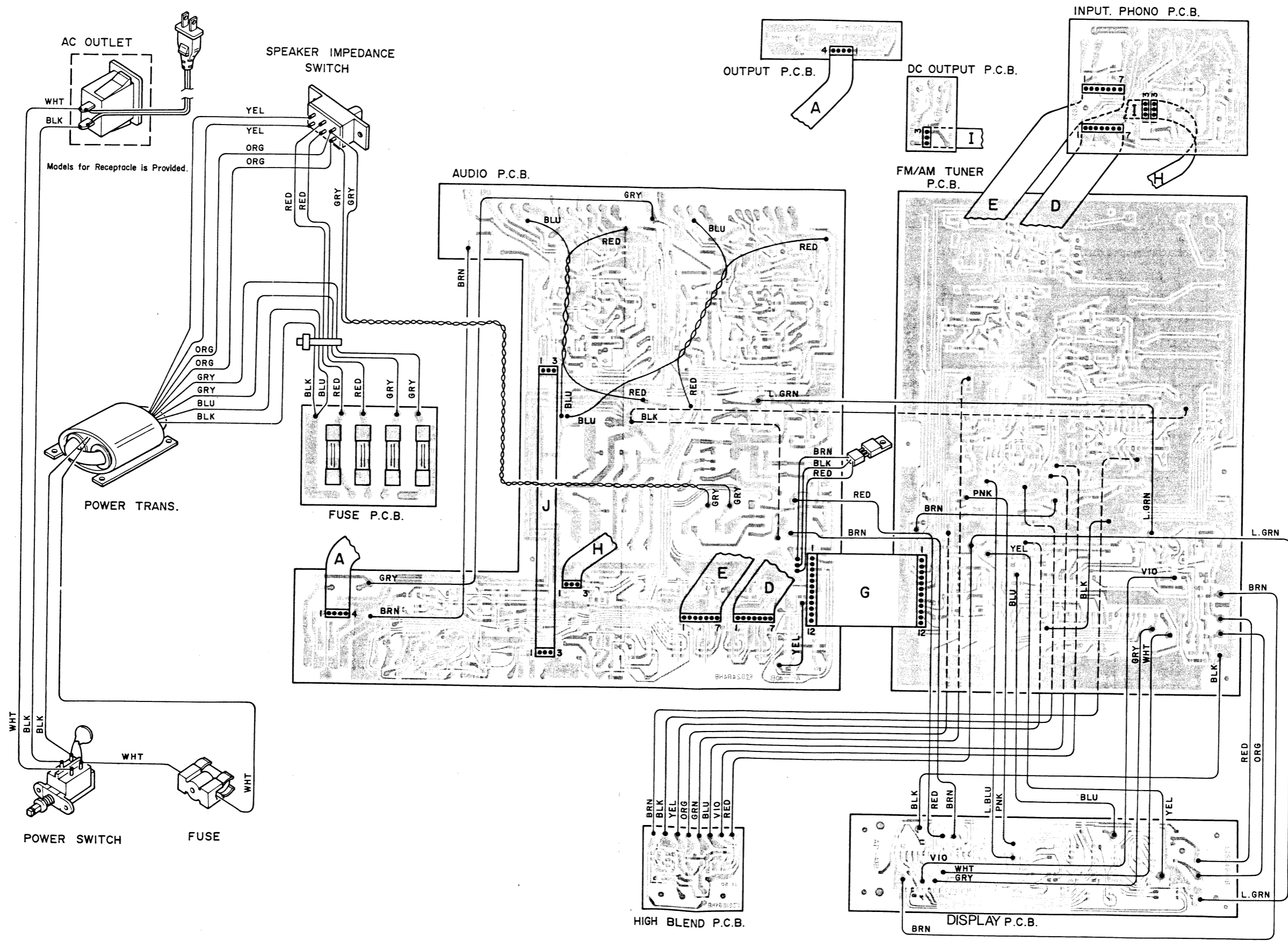

WIRING DIAGRAM NAD7125

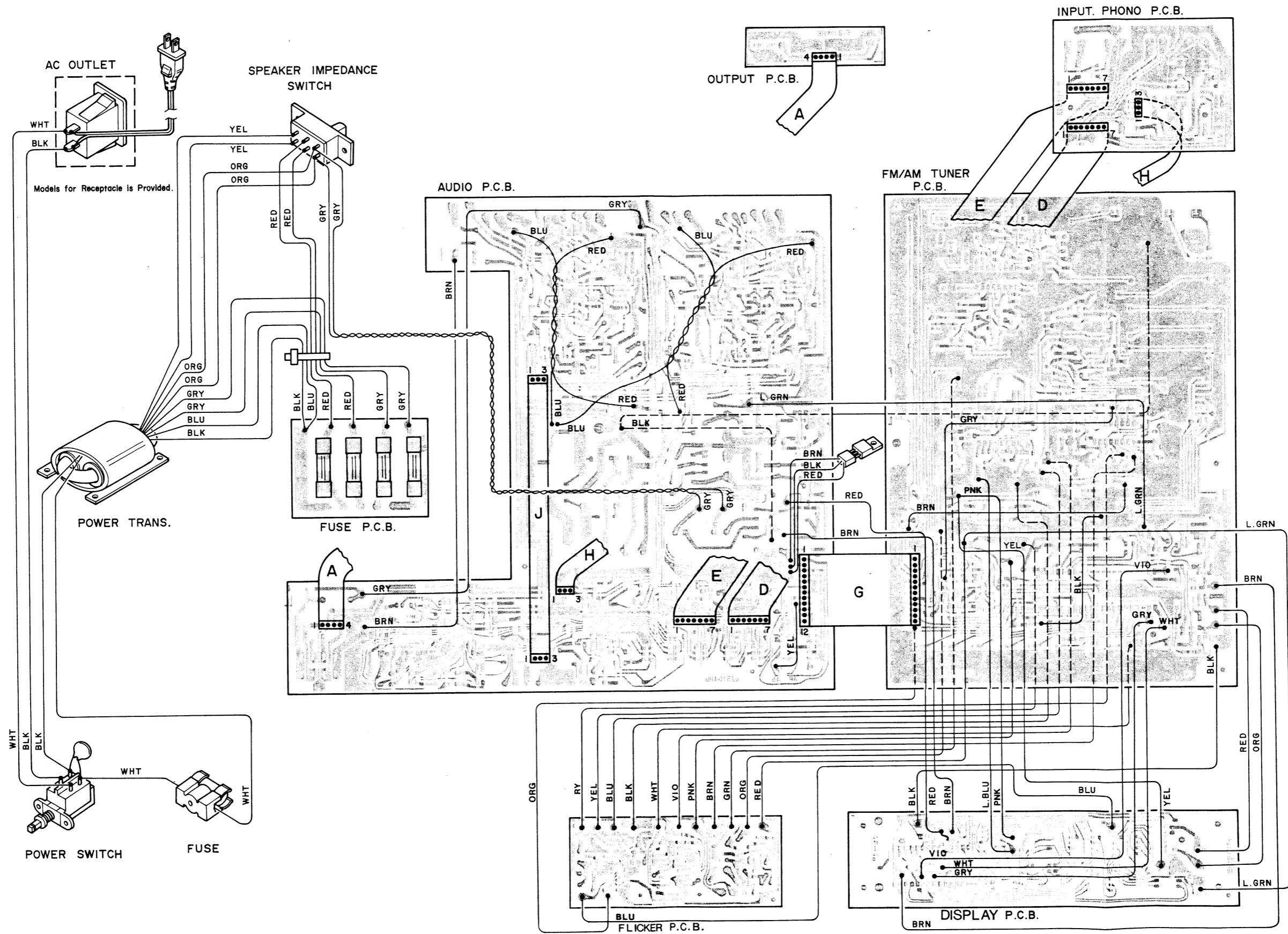

EXPLODED VIEW

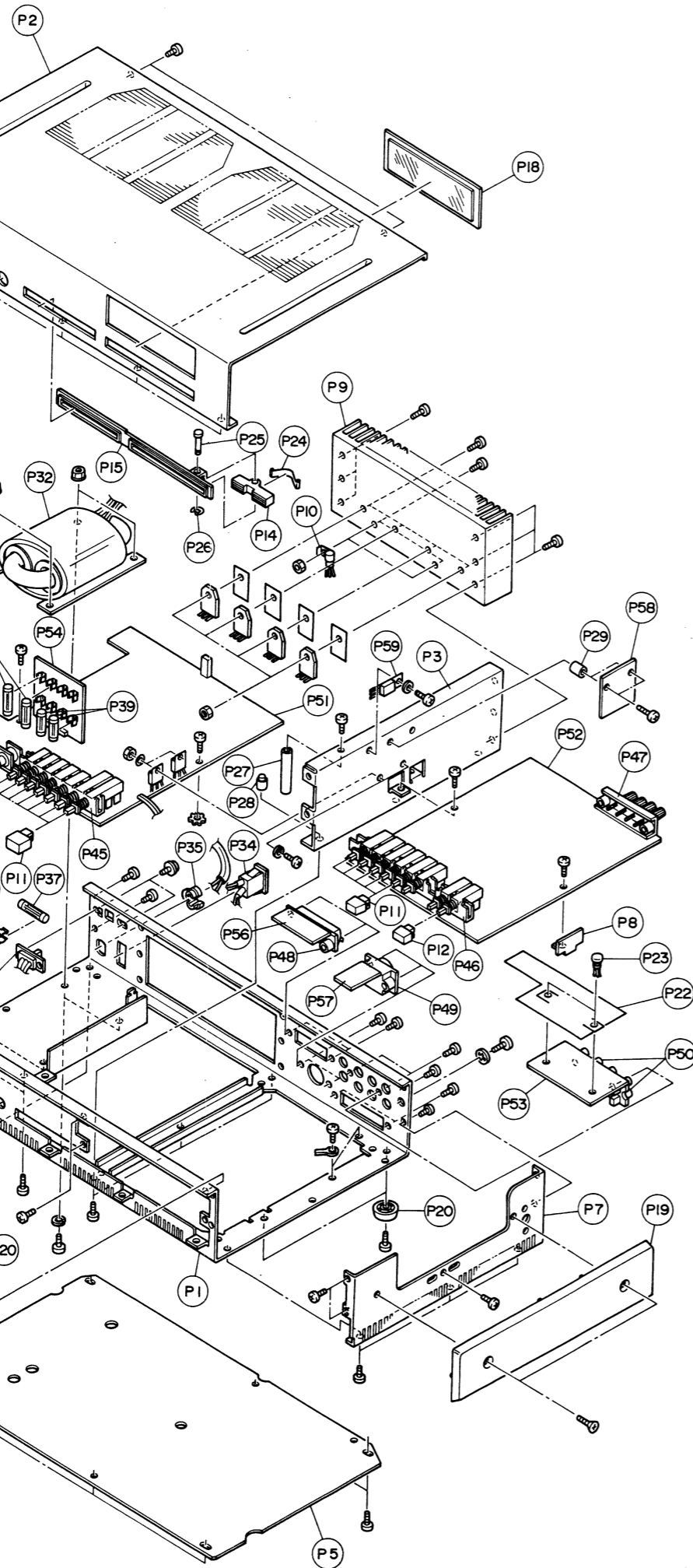

PARTS LIST

7120 / 7125

Ref. No.	Code No.	Description	Parts No.
P 1	142474	Bottom Chassis (AQ)220V	SN-210020E-1
	142475	" (AR)120V UL	SN-210020E-2
	141576	" (AT)120V CSA	SN-210020E-3
	141575	" (AS)240V	SN-210020E-
P 2	312864	Wrap Around Top Panel	SN-220254
P 3	141566	Chassis Frame	SN-230304
P 4	141567	AC Switch Bracket	SN-230303-A
P 5	141570	Bottom Plate	SN-220255
P 6	141568	Side Bracket (L)	SN-230310
P 7	141569	Side Bracket (R)	SN-230311
P 8	141573	p.c.b. Bracket	SN-241009
P 9	212414	Heat Sink (SP)	SN-230307
P10	373477	Heat Sink for Transistor	No.37
P11	302788	Square Push Button	KB-10D
P12	302928	Square Push Button	KR-10D
P13	302929	Square Push Button	KG-10D
P14	302927	Square Push Button	KB-08GA
P15	182182	Square Button Frame (SJ)	SN-230309
P16	182176	Square Button Frame (SI)	SN-240988
P17	182181	Power Switch Arm (SB)	SN-230302
P18	182175	LED Window (SA)	SN-240987
P19	182177	Side Plate	SN-230301
P20	192237	Foot	MD-304
P21	182180	LED Indicator Plate	SN-241004
P22	192398	P.C.B. Cover	SN-241010
P23	192293	Plastic Rivet	No.1027
P24	222456	Leaf Spring (SW)	SN-241002
P25	141572	Shaft A, Tuning Button	SN-241005
P26	...	E-Ring for Shaft A	...
P27	151689	Stud No.14	SN-230241
P28	151690	Stud No.15	SN-241018
P29	151678	Bs. Stud No.4	SN-230242I
P30	151688	Bs. Stud No.13	
P31	202310	AC Power Cord 220V	SP-204
	202304	" 120V USA	SPT-1
	202321	" 120V CSA	SPT-2
	202307	" 240V BS/SAA	

NOTE

Ref.No.	Code No.	Description	Parts No.
P32	161878	Power Transformer 120V(USA)	PT-45D
	161879	" 220V	PT-45B
	161880	" 120V(CSA)	PT-45F
	161881	" 240V	PT-45C
P33	111118	Power Switch 220V,240V	ESB-90117s
	111124	" 120V	ESB-90102t
P34	121230	AC Convenience Outlet (US/CSA)	S2-737T-100
P35	373475	AC Cord Stopper 220V/240V	W-5116
	373495	" 120V(USA)	SR-3P-4
	372898	" 120V(CSA)	SR-4N-4
P36	262574	Fuse Holder 220V/120V(USA)	UF-0015
	261797	" 120V(CSA)	H-0445
P37		Time Lag Fuse	
P38		Time Lag Fuse	
P39		Time Lag Fuse	
P40	111142	Speaker Impedance Switch	
P41	121235	Headphone Jack	YHJ-125-060
P42	101042	Rotary Variable Res.(Bas/Treb)	R113G-P3496-2
P43	101036	Rotary Variable Res. (Balance)	R113-3602A
P44	101037	Rotary Variable Res. (Volume)	R113G-P3530
P45	111147	Push Switch	PSE070C2K
P46	111141	Push Switch	PSE090
P47	121231	Antenna Terminals	UB-1059#02
P48	121233	Speaker Terminals	UG-0020#1
P49		DIN Socket	
P50	121178	4P-PIN Jack (PHONO INPUT, AUX INPUT, TAPE Rec./Play)	UA-1075#01
P51		PCB, Audio Sect.	
P52		PCB, Tuner Sect.	
P53		PCB, Phono Sect.	
P54		PCB, Fuse	
P55		PCB, LED	
P56		PCB, Speaker Terminals	
P57		PCB, DIN Socket	
P58		PCB, Hi-Blend (7120)	
		PCB, Flicker (7125)	
P59	030122	IC, Regulator	AN-7812
P60	302926	Round mould knob	PB-18B
P61		Capacitor, Noise Killer	
P62		LED Spacer	

NAD ELECTRONICS
LONDON/BOSTON

© 1983 BY NAD 204 PRINTED IN JAPAN