



# SERVICE MANUAL

SERVICE MANUAL

MODEL : C555

# SERVICE MANUAL

© NAD 2005

**C555**

**TURNTABLE**

**C555**  
TURNTABLE



**C555**  
TURNTABLE

**NAD ELECTRONICS INTERNATIONAL  
TORONTO**

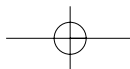

# SECTION 1

## SUMMARY

### CONTENTS

<b>PRODUCT SAFETY SERVICING GUIDELINES FOR VIDEO PRODUCTS .....</b>	<b>1-2</b>
<b>SERVICING PRECAUTIONS .....</b>	<b>1-3</b>
• General Servicing Precautions	
• Insulation Checking Prodedure	
• Electrostatically Sensitive Devices	
<b>SPECIFICATIONS .....</b>	<b>1-4</b>

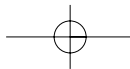

# PRODUCT SAFETY SERVICING GUIDELINES FOR VIDEO PRODUCTS

**CAUTION :** DO NOT ATTEMPT TO MODIFY THIS PRODUCT IN ANY WAY, NEVER PERFORM CUSTOMIZED INSTALLATIONS WITHOUT MANUFACTURER'S APPROVAL. UNAUTHORIZED MODIFICATIONS WILL NOT ONLY VOID THE WARRANTY, BUT MAY LEAD TO YOUR BEING LIABLE FOR ANY RESULTING PROPERTY DAMAGE OR USER INJURY.

SERVICE WORK SHOULD BE PERFORMED ONLY AFTER YOU ARE THOROUGHLY FAMILIAR WITH ALL OF THE FOLLOWING SAFETY CHECKS AND SERVICING GUIDELINES. TO DO OTHERWISE, INCREASES THE RISK OF POTENTIAL HAZARDS AND INJURY TO THE USER.

WHILE SERVICING, USE AN ISOLATION TRANSFORMER FOR PROTECTION FROM A.C. LINE SHOCK.

## SAFETY CHECKS

AFTER THE ORIGINAL SERVICE PROBLEM HAS BEEN CORRECTED, A CHECK SHOULD BE MADE OF THE FOLLOWING.

### SUBJECT : FIRE & SHOCK HAZARD

1. BE SURE THAT ALL COMPONENTS ARE POSITIONED IN SUCH A WAY AS TO AVOID POSSIBILITY OF ADJACENT COMPONENT SHORTS. THIS IS ESPECIALLY IMPORTANT ON THOSE MODULES WHICH ARE TRANSPORTED TO AND FROM THE REPAIR SHOP.
2. NEVER RELEASE A REPAIR UNLESS ALL PROTECTIVE DEVICES SUCH AS INSULATORS, BARRIERS, COVERS, SHIELDS, STRAIN RELIEFS, POWER SUPPLY CORDS, AND OTHER HARDWARE HAVE BEEN REINSTALLED PER ORIGINAL DESIGN. BE SURE THAT THE SAFETY PURPOSE OF THE POLARIZED LINE PLUG HAS NOT BEEN DEFEATED.
3. SOLDERING MUST BE INSPECTED TO DISCOVER POSSIBLE COLD SOLDER JOINTS, SOLDER SPLASHES OR SHARP SOLDER POINTS. BE CERTAIN TO REMOVE ALL LOOSE FOREIGN PARTICLES.
4. CHECK FOR PHYSICAL EVIDENCE OF DAMAGE OR DETERIORATION TO PARTS AND COMPONENTS. FOR FRAYED LEADS, DAMAGED INSULATION (INCLUDING A.C. CORD), AND REPLACE IF NECESSARY FOLLOW ORIGINAL LAYOUT, LEAD LENGTH AND DRESS.
5. NO LEAD OR COMPONENT SHOULD TOUCH A RECEIVING TUBE OR A RESISTOR RATED AT 1 WATT OR MORE. LEAD TENSION AROUND PROTRUDING METAL SURFACES MUST BE AVOIDED.
6. ALL CRITICAL COMPONENTS SUCH AS FUSES, FLAMEPROOF RESISTORS, CAPACITORS, ETC. MUST BE REPLACED WITH EXACT FACTORY TYPES, DO NOT USE REPLACEMENT COMPONENTS OTHER THAN THOSE SPECIFIED OR MAKE UNRECOMMENDED CIRCUIT MODIFICATIONS.
7. AFTER RE-ASSEMBLY OF THE SET ALWAYS PERFORM AN A.C. LEAKAGE TEST ON ALL EXPOSED METALLIC PARTS OF THE CABINET, (THE CHANNEL SELECTOR KNOB, ANTENNA TERMINALS, HANDLE AND SCREWS) TO BE SURE THE SET IS SAFE TO OPERATE WITHOUT DANGER OF ELECTRICAL SHOCK. DO NOT USE A LINE ISOLATION TRANSFORMER DURING THIS TEST USE AN A.C. VOLT-METER, HAVING 5000 OHMS PER VOLT OR MORE SENSITIVITY, IN THE FOLLOWING MANNER; CONNECT A 1500 OHM 10 WATT RESISTOR, PARALLELED BY A .15 MFD. 150.V A.C TYPE CAPACITOR BETWEEN A KNOWN GOOD EARTH GROUND (WATER PIPE, CONDUIT, ETC.) AND THE EXPOSED METALLIC PARTS, ONE AT A TIME. MEASURE THE A.C. VOLTAGE ACROSS THE COMBINATION OF 1500 OHM RESISTOR AND .15 MFD CAPACITOR. REVERSE THE A.C. PLUG AND REPEAT A.C. VOLTAGE MEASUREMENTS FOR EACH EXPOSED METALLIC PART. VOLTAGE MEASURED MUST NOT EXCEED 75 VOLTS R.M.S. THIS CORRESPONDS TO 0.5 MILLIAMPS A.C ANY VALUE EXCEEDING THIS LIMIT CONSTITUTES A POTENTIAL SHOCK HAZARD AND MUST BE CORRECTED IMMEDIATELY.

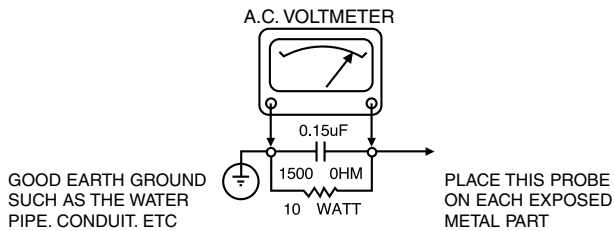

### SUBJECT: GRAPHIC SYMBOLS

 THE LIGHTNING FLASH WITH APROWHEAD SYMBOL, WITHIN AN EQUILATERAL TRIANGLE, IS INTENDED TO ALERT THE SERVICE PERSONNEL TO THE PRESENCE OF UNINSULATED "DANGEROUS VOLTAGE" THAT MAY BE OF SUFFICIENT MAGNITUDE TO CONSTITUTE A RISK OF ELECTRIC SHOCK.

 THE EXCLAMATION POINT WITHIN AN EQUILATERAL TRIANGLE IS INTENDED TO ALERT THE SERVICE PERSONNEL TO THE PRESENCE OF IMPORTANT SAFETY INFORMATION IN SERVICE LITERATURE.

SUBJECT : X-RADIATION

1. BE SURE PROCEDURES AND INSTRUCTIONS TO ALL SERVICE PERSONNEL COVER THE SUBJECT OF X-RADIATION. THE ONLY POTENTIAL SOURCE OF X-RAYS IN CURRENT T.V. RECEIVERS IS THE PICTURE TUBE. HOWEVER, THIS TUBE DOES NOT EMIT X-RAYS WHEN THE HIGH VOLTAGE IS AT THE FACTORY SPECIFIED LEVEL. THE PROPER VALUE IS GIVEN IN THE APPLICABLE SCHEMATIC. OPERATION AT HIGHER VOLTAGES MAY CAUSE A FAILURE OF THE PICTURE TUBE OR HIGH VOLTAGE SUPPLY AND, UNDER CERTAIN CIRCUMSTANCES, MAY PRODUCE RADIATION IN EXCESS OF DESIRABLE LEVELS.
2. ONLY FACTORY SPECIFIED C.R.T. ANODE CONNECTORS MUST BE USED. DEGAUSSING SHIELDS ALSO SERVE AS X-RAY SHIELD IN COLOR SETS, ALWAYS RE-INSTALL THEM.
3. IT IS ESSENTIAL THAT SERVICE PERSONNEL HAVE AVAILABLE AN ACCURATE AND RELIABLE HIGH VOLTAGE METER. THE CALIBRATION OF THE METER SHOULD BE CHECKED PERIODICALLY AGAINST A REFERENCE STANDARD, SUCH AS THE ONE AVAILABLE AT YOUR DISTRIBUTOR.
4. WHEN THE HIGH VOLTAGE CIRCUITRY IS OPERATING PROPERLY THERE IS NO POSSIBILITY OF AN X-RADIATION PROBLEM. EVERY TIME A COLOR CHASSIS IS SERVICED, THE BRIGHTNESS SHOULD BE RUN UP AND DOWN WHILE MONITORING THE HIGH VOLTAGE WITH A METER TO BE CERTAIN THAT THE HIGH VOLTAGE DOES NOT EXCEED THE SPECIFIED VALUE AND THAT IT IS REGULATING CORRECTLY. WE SUGGEST THAT YOU AND YOUR SERVICE ORGANIZATION REVIEW TEST PROCEDURES SO THAT VOLTAGE REGULATION IS ALWAYS CHECKED AS A STANDARD SERVICING PROCEDURE. AND THAT THE HIGH VOLTAGE READING BE RECORDED ON EACH CUSTOMER'S INVOICE.
5. WHEN TROUBLESHOOTING AND MAKING TEST MEASUREMENTS IN A PRODUCT WITH A PROBLEM OF EXCESSIVE HIGH VOLTAGE, AVOID BEING UNNECESSARILY CLOSE TO THE PICTURE TUBE AND THE HIGH VOLTAGE SUPPLY. DO NOT OPERATE THE PRODUCT LONGER THAN IS NECESSARY TO LOCATE THE CAUSE OF EXCESSIVE VOLTAGE.
6. REFER TO HV. B+ AND SHUTDOWN ADJUSTMENT PROCEDURES DESCRIBED IN THE APPROPRIATE SCHEMATIC AND DIAGRAMS (WHERE USED).

SUBJECT: IMPLSION

1. ALL DIRECT VIEWED PICTURE TUBES ARE EQUIPPED WITH AN INTEGRAL IMPLSION PROTECTION SYSTEM, BUT CARE SHOULD BE TAKEN TO AVOID DAMAGE DURING INSTALLATION, AVOID SCRATCHING THE TUBE. IF SCRATCHED REPLACE IT.
2. USE ONLY RECOMMENDED FACTORY REPLACEMENT TUBES.

SUBJECT : TIPS ON PROPER INSTALLATION

1. NEVER INSTALL ANY PRODUCT IN A CLOSED-IN RECESS, CUBBY-HOLE OR CLOSELY FITTING SHELF SPACE. OVER OR CLOSE TO HEAT DUCT, OR IN THE PATH OF HEATED AIR FLOW.
2. AVOID CONDITIONS OF HIGH HUMIDITY SUCH AS: OUTDOOR PATIO INSTALLATIONS WHERE DEW IS A FACTOR, NEAR STEAM RADIATORS WHERE STEAM LEAKAGE IS A FACTOR, ETC.
3. AVOID PLACEMENT WHERE DRAPERIES MAY OBSTRUCT REAR VENTING. THE CUSTOMER SHOULD ALSO AVOID THE USE OF DECORATIVE SCARVES OR OTHER COVERINGS WHICH MIGHT OBSTRUCT VENTILATION.
4. WALL AND SHELF MOUNTED INSTALLATIONS USING A COMMERCIAL MOUNTING KIT. MUST FOLLOW THE FACTORY APPROVED MOUNTING INSTRUCTIONS A PRODUCT MOUNTED TO A SHELF OR PLATFORM MUST RETAIN ITS ORIGINAL FEET (OR THE EQUIVALENT THICKNESS IN SPACERS) TO PROVIDE ADEQUATE AIR FLOW ACROSS THE BOTTOM, BOLTS OR SCREWS USED FOR FASTENERS MUST NOT TOUCH ANY PARTS OR WIRING. PERFORM LEAKAGE TEST ON CUSTOMIZED INSTALLATIONS.
5. CAUTION CUSTOMERS AGAINST THE MOUNTING OF A PRODUCT ON SLOPING SHELF OR A TILTED POSITION, UNLESS THE PRODUCT IS PROPERLY SECURED.
6. A PRODUCT ON A ROLL-ABOUT CART SHOULD BE STABLE ON ITS MOUNTING TO THE CART. CAUTION THE CUSTOMER ON THE HAZARDS OF TRYING TO ROLL A CART WITH SMALL CASTERS ACROSS THRESHOLDS OR DEEP PILE CARPETS.
7. CAUTION CUSTOMERS AGAINST THE USE OF A CART OR STAND WHICH HAS NOT BEEN LISTED BY UNDERWRITERS LABORATORIES, INC. FOR USE WITH THEIR SPECIFIC MODEL OF TELEVISION RECEIVER OR GENERICALLY APPROVED FOR USE WITH T.V.'S OF THE SAME OR LARGER SCREEN SIZE.
8. CAUTION CUSTOMERS AGAINST THE USE OF EXTENSION CORDS, EXPLAIN THAT A FOREST OF EXTENSIONS SPROUTING FROM A SINGLE OUTLET CAN LEAD TO DISASTROUS CONSEQUENCES TO HOME AND FAMILY.

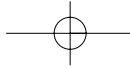

## SERVICING PRECAUTIONS

**CAUTION** : Before servicing the DVD covered by this service data and its supplements and addends, read and follow the **SAFETY PRECAUTIONS**. **NOTE** : if unforeseen circumstances create conflict between the following servicing precautions and any of the safety precautions in this publication, always follow the safety precautions.

*Remembers Safety First:*

### General Servicing Precautions

1. Always unplug the DVD AC power cord from the AC power source before:
  - (1) Removing or reinstalling any component, circuit board, module, or any other assembly.
  - (2) Disconnection or reconnecting any internal electrical plug or other electrical connection.
  - (3) Connecting a test substitute in parallel with an electrolytic capacitor.
 

**Caution** : A wrong part substitution or incorrect polarity installation of electrolytic capacitors may result in an explosion hazard.
2. Do not spray chemicals on or near this DVD or any of its assemblies.
3. Unless specified otherwise in this service data, clean electrical contacts by applying an appropriate contact cleaning solution to the contacts with a pipe cleaner, cotton-tipped swab, or comparable soft applicator. Unless specified otherwise in this service data, lubrication of contacts is not required.
4. Do not defeat any plug/socket B+ voltage interlocks with which instruments covered by this service manual might be equipped.
5. Do not apply AC power to this DVD and/or any of its electrical assemblies unless all solid-state device heat sinks are correctly installed.
6. Always connect test instrument ground lead to the appropriate ground before connection the test instrument positive lead. Always remove the test instrument ground lead last.

### Insulation Checking Procedure

Disconnect the attachment plug from the AC outlet and turn the power on. Connect an insulation resistance meter(500V) to the blades of the attachment plug. The insulation resistance between each blade of the attachment plug and accessible conductive parts (Note 1) should be more than 1M-ohm.

**Note 1** : Accessible Conductive Parts including Metal panels, Input terminals, Earphone jacks, etc.

### Electrostatically Sensitive (ES) Devices

Some semiconductor (solid state) devices can be damaged easily by static electricity. Such components commonly are called Electrostatically Sensitive (ES) Devices. Examples of typical ES devices are integrated circuits and some field effect transistors and semiconductor chip components.

The following techniques should be used to help reduce the incidence of component damage caused by static electricity.

1. Immediately before handling any semiconductor component or semiconductor-equipped assembly, drain off any electrostatic charge on your body by touching a known earth ground. Alternatively, obtain and wear a commercially available discharging wrist strap device, which should be removed for potential shock reasons prior to applying power to the unit under test.
2. After removing an electrical assembly equipped with ES devices, place the assembly on a conductive surface such as aluminum foil, to prevent electrostatic charge buildup or exposure of the assembly.
3. Use only a grounded-tip soldering iron to solder or unsolder ES devices.
4. Use only an anti-static solder removal device. Some solder removal devices not classified a "anti-static" can generate electrical charges sufficient to damage ES devices.
5. Do not use freon-propelled chemicals. These can generate electrical charge sufficient to damage ES devices.
6. Do not remove a replacement ES device from its protective package until immediately before you are ready to install it. (Most replacement ES devices are packaged with leads electrically shorted together by conductive foam, aluminum foil, or comparable conductive material).
7. Immediately before removing the protective material from the leads of a replacement ES device, touch the protective material to the chassis or circuit assembly into which the device will be installed.

**Caution** : Be sure no power is applied to the chassis or circuit, and observe all other safety precautions.

8. Minimize bodily motions when handling unpackaged replacement ES devices. (Normally harmless motion such as the brushing together of your clothes fabric or the lifting of your foot from a carpeted floor can generate static electricity sufficient to damage an ES device.)

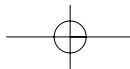

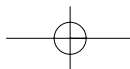

# SPECIFICATIONS

## CARTRIDGE SPECIFICATION

### TRANSDUCER CHARACTERISTICS

Frequency response	20Hz - 20 kHz $\pm$ 3dB
Channel balance	2dB at 1 kHz
Channel separation	20dB at 1 kHz
Output level	5mV $\pm$ 2dB at 1 kHz at 5cm/s
Static compliance	16mm/N
Equivalent tip mass	0.7mg
Vertical tracking angle	26 degrees
Stylus radius	Elliptical 0.00072" x 0.0003" / 18 $\mu$ x 7 $\mu$
Stylus type	replaceable

### ELECTRICAL CHARACTERISTICS

Load resistance	47k ohms
Load capacitance	150 - 400pF
Internal inductance	560mH
Internal resistance	700 ohms

### MECHANICAL CHARACTERISTICS

Cartridge weight	4.2g
Fixing centres	0.5" / 12.7mm
Tracking weight	1.5 - 2.0g (1.7g nominal)

## C 555 SPECIFICATIONS

### TURNTABLE

Drive system	Belt drive
Motor	High torque synchronous motor
Speeds	33.3 and 45.1 rpm
Suspension system	3 energy absorbent synthetic rubber feet

### TO NEARM

Operation	Manual
Length	289mm total length - 244mm pivot to stylus
Effective mass	9 grams
Overhang	19.1mm
Cartridge weight	4.2 grams
Vertical tracking force	1.7 grams nominal
Cable capacitance	150-400pF

### PHYSICAL SPECIFICATIONS

Dimensions (WxHxD) with dust cover down	17 $\frac{3}{8}$ x 4 $\frac{9}{16}$ x 14" / 447 x 115 x 356mm
Net Weight	11.57lb / 5.25kg
Shipping Weight	15.21lb / 6.9kg

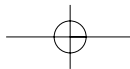

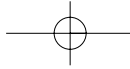

# SECTION 2

## CABINET & MAIN CHASSIS

### CONTENTS

<b>1. PARTS VIEWS .....</b>	<b>2-2</b>
<b>1. Side Parts View .....</b>	<b>2-2</b>
<b>2. Side Parts View List .....</b>	<b>2-3</b>

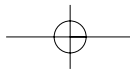
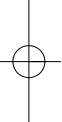
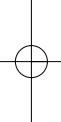

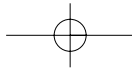

# PARTS VIEWS

## 1. Side Parts View

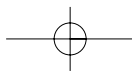
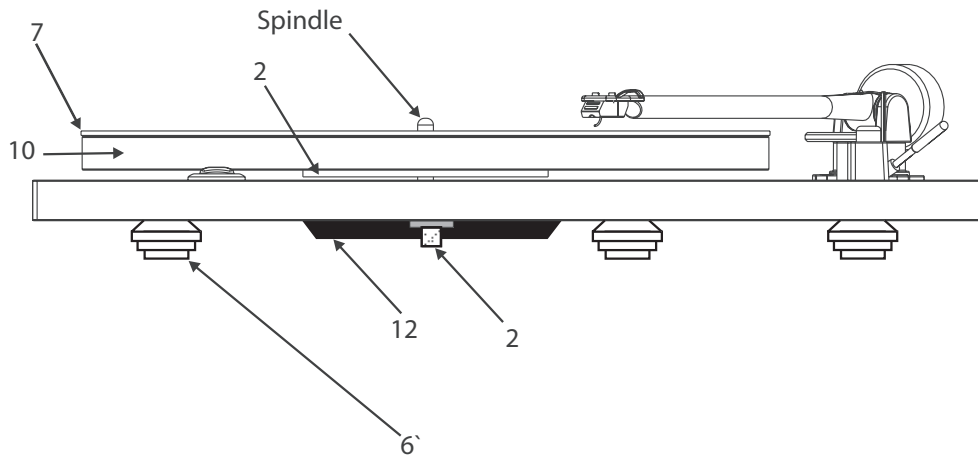
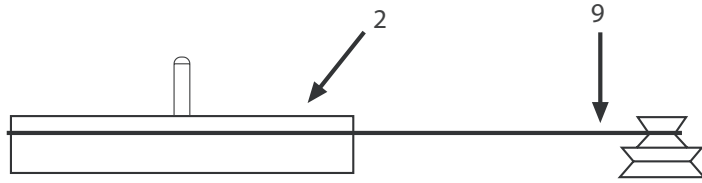
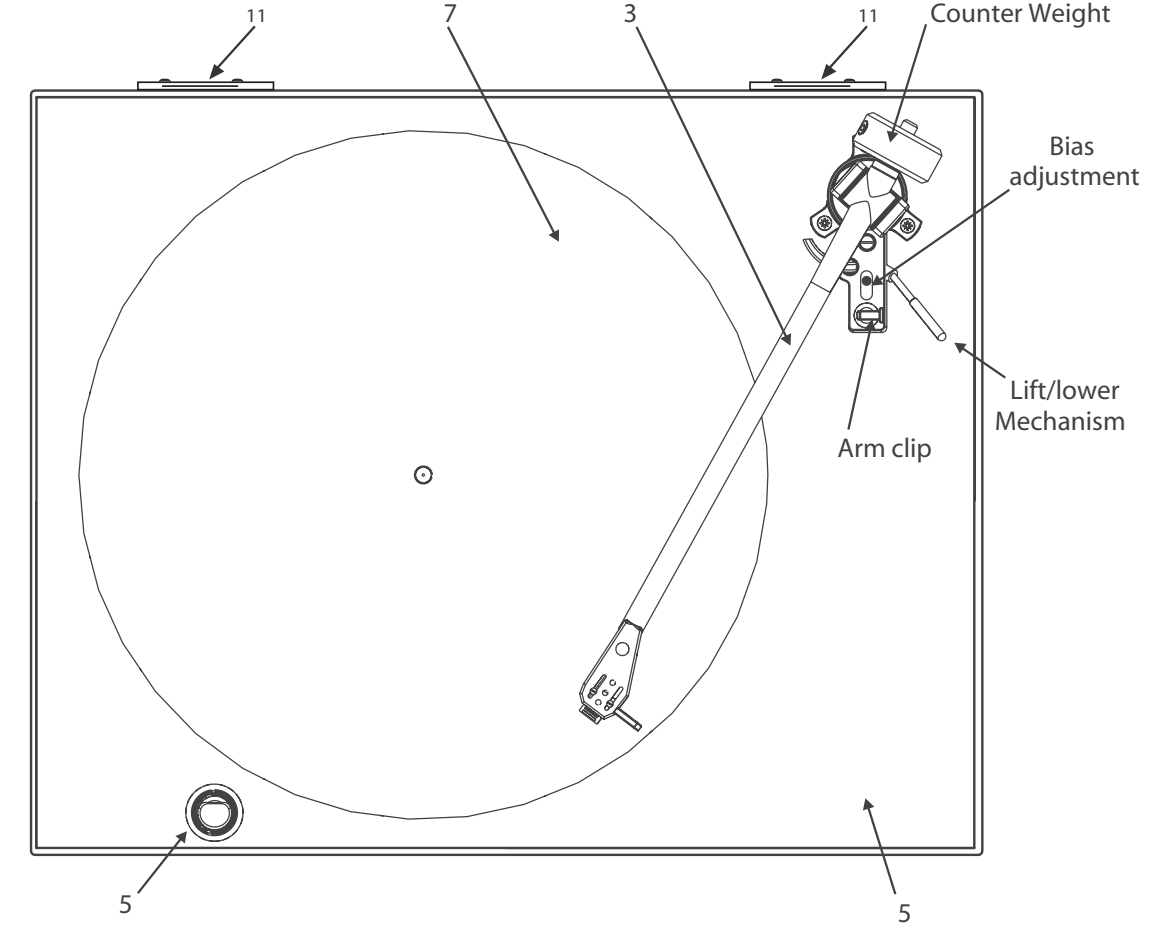

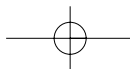

## PARTS VIEWS

### 2. Side Parts View List

LOCATION	PART NUMBER	DESCRIPTION
1	AS555	C555 Turntable Motor & PCB
2	AS556	C555 Hub Bearing Assembly with C555 Sub Platter
3	AS557	C555 Tonearm
4	AS558	C555 Turntable Lid
5	AS559	C555 Plinth including Switch
6	AS568	C555 Foot including Screw
7	AS562	C555 Turntable Mat
8	AS563	C555 Phonograph Cable assembly
9	AS564	Drive Belt
10	AS565	C555 Platter
11	AS567	C555 Complete Lid Hing- Set including Rivets
12	AS566	C555 Motor Cover Tray
(not shown)	AS561	C555 Complete Packaging

