

SERVICE MANUAL



M25 C/AH

SEVEN CHANNEL AMPLIFIER

M25 C/AH

SEVEN CHANNEL AMPLIFIER

CONTENTS

FRONT PANEL/REAR PANEL VIEW.....	3
SPECIFICATIONS.....	4
ALIGNMENT PROCEDURE/ALIGNMENT POINTS.....	5-6
WIRING DIAGRAM.....	7
SCHEMATIC DIAGRAM.....	8-16
PCB LAYOUT.....	17-23
ELECTRICAL PARTS LIST.....	24-40
EXPLODED VIEW.....	41-44
EXPLODED VIEW PARTS LIST.....	45
PACKING DIAGRAM.....	46

SERVICE SAFETY PRECAUTIONS

1. Replacing the Fuses

CAUTION: FOR CONTINUED PROTECTION AGAINST THE RISK OF FIRE REPLACE ONLY WITH SAME TYPE OF FUSE.

REFERENCE NO.	PART NUMBER	DESCRIPTION
Rear Panel		
AH ▲	20-11203-10	MDA T20AL/250V
C ▲	20-12103-20	MDA T10AL/250V
AMP Board		
F101/F102 ▲	20-12632-00	T6.3AL/250V
PSU Board		
F201-F204 ▲	20-12162-01	T1.6AL/250V

NOTE:

*AH : North American version only

*C : European version only

2. Safety-check out (North American model only)

Before returning the product to the customer, make leakage current or resistance measurements to determine that exposed parts are acceptably insulated from the supply circuit.

Parts marked with the symbol ▲ are critical with regard to the risk of fire and electric shock. Replace only parts recommended by the manufacturer.

FRONT PANEL / REAR PANEL VIEW

FRONT PANEL CONTROLS

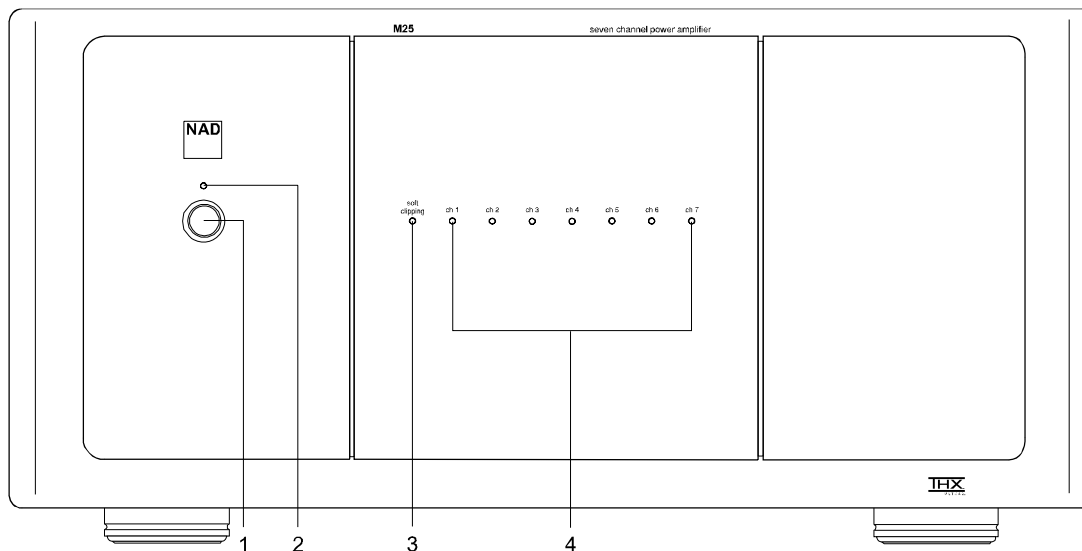

- 1. POWER SWITCH
- 2. POWER INDICATOR

- 3. SOFT CLIPPING INDICATOR
- 4. PROTECTION INDICATOR

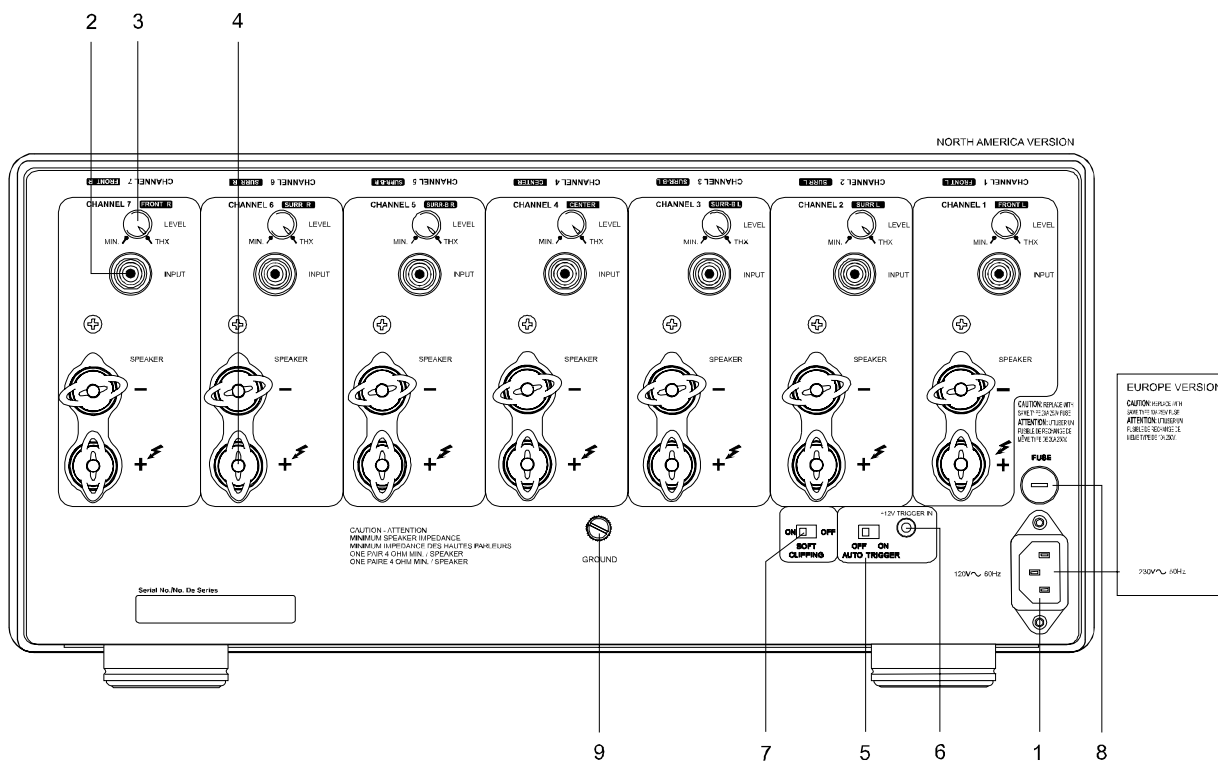

- 1. AC INLET
- 2. INPUT JACK
- 3. LEVEL CONTROL
- 4. SPEAKER TERMINALS
- 5. AUTO TRIGGER SWITCH

- 6. 12V TRIGGER INPUT
- 7. SOFT CLIPPING SWITCH
- 8. MAINS FUSE
- 9. GROUND TERMINAL

SPECIFICATIONS

CONTINUOUS AVERAGE POWER **≥160 W (22.0 dBW)**
OUTPUT INTO 8 OHMS OR 4 OHMS
(Min. power per channel, 20 Hz – 20 kHz, both channels driven, with no more than rated distortion)

Rated Distortion **≤0.03%**
(THD 20 Hz – 20 kHz)

Clipping power **≥180 W**
(maximum continuous power per channel).

IHF dynamic power
(Maximum short term power per channel)

8 ohms:	≥220 W (23.4 dBW)
4 ohms:	≥385 W (25.9 dBW)
2 ohms:	≥485 W (26.9 dBW)

Damping factor **>180**
(ref. 8 ohms 50Hz)

Input Impedance **R = 1 Mohms**
C = 180 pF

Input sensitivity (for rated output into 8 ohms) **1250mV+/-50mV**

Voltage gain **29 dB**

Frequency response 20 Hz – 20 kHz **±0.2 dB**
- 3dB at 3 Hz/70 kHz

Signal / Noise ratio, A-weighted **>96 dB ref. 1 W**
>118 dB ref. 160W

DIMENSIONS AND WEIGHTS

Net Weight **44.5 kg (98.0 lb)**
Shipping Weight **53 kg (116.7 lb)**
Dimension (W×H×D) **435 × 200 × 465.6mm**

ALIGNMENT PROCEDURE

A. THERMAL SENSE ADJUSTMENT

This adjustment should be always done when the M25 is cool condition. (That means the temperature inside the unit should be almost same as the ambient temperature. Connector P208B that connects the transformer and power board should be removed to avoid that the Idling current heats up the unit excessively) At ambient temperature of 25 C degrees and when the unit is just turned on (still in cool condition), adjust the pot RV103(as marked as “Thermal Sense ADJ” in below drawing) for a voltage between the THERMAL TEST POINT and AGND to be 750mV \pm 10mV. If the ambient temperature is different, the voltage setting should be changed by 20mV per degree difference. So at 20C degrees, the voltage should be 850mV \pm 10mV; and at 30C degrees, the voltage should be 650mV \pm 10mV, etc.

B. DC OFFSET VOLTAGE

The DC OFFSET between OFFSET Test Point and AGND must be within 0 \pm 3mV. If it's found to be out of this range, change the TL084BCD to one selected for low offset voltage to meet the requirement.

C. IDLING CURRENT

The idling current in the output stage of the poweramp should be set to 40mA \pm 10mA per pnp-npn transistor pair(This means the mid point voltage is 17.6mV with down limit of 13.2mV and up limit of 22mV). The alignment procedure is: At first, adjust RV102 (Marked as “Idling Current ADJ” in the drawing below) for a voltage of 17.6mV \pm 1mV between Test point 1 and 2. Then preheat the unit for 5 minutes, let idling current settled and then readjust to 17.6mV \pm 1mV.

Pls note:

1. The idling current must be adjusted when all modules are assembled into the unit.
2. Though the idling current is set as 17.6mV \pm 1mV during the adjustment, due to the influence of varied ambient temperature and mains voltage etc., the idling current will drift after some time. During the normal checking of idling current in the service field, it's acceptable as long as the voltage is in the range of 13.2mV—22.0mV.

D. ISC Current sense zero-set.

The ISC current-sensing voltage at no signal should be 0mV \pm 50mV. During factory alignment, it is set to 0mV \pm 10mV . That is to adjust Pot RV104 (as marked as “ISC SENSE ADJ” in the below drawing) to get a voltage between the “ISC SENSE TEST POINT” and AGND to be 0mV \pm 10mV.

(Pls note the ISC should be adjusted when all modules are plugged in. It's not possible to get 0mV \pm 10mV if any of the modules are removed.)

E. Fan Cut Off Point Adjustment

Check the Fan sense voltage first. Turn Pot RV201 to the end clockwise and confirm TP2 of J201 is in negative voltage. Run the unit to heat it up and drive the fan to start turning,

for example, all 7 channels at 50W/4ohms for 10 minutes or 5 minutes or even less (as long as the fan can starts turning). Turn off the signal but still keep the unit operating for 1 minute. Then run all 7 channels at 1kHz, **0.25W** at 4 ohms load, monitor the voltage at TP1 of Pot RV201. Adjust RV201 to get the voltage from negative to positive to ensure that the Fans are turned off. Then run all 7 channels at 1kHz, **0.5W** at 4 ohms load, monitor if the voltage at TP1 of Pot RV201 is negative, if not, adjust Pot RV201 just to the point that TP1 changes from positive to negative (to get the fans just start turning). Finally, turn off the signal and monitor if fans stop turning within about 30s Max."

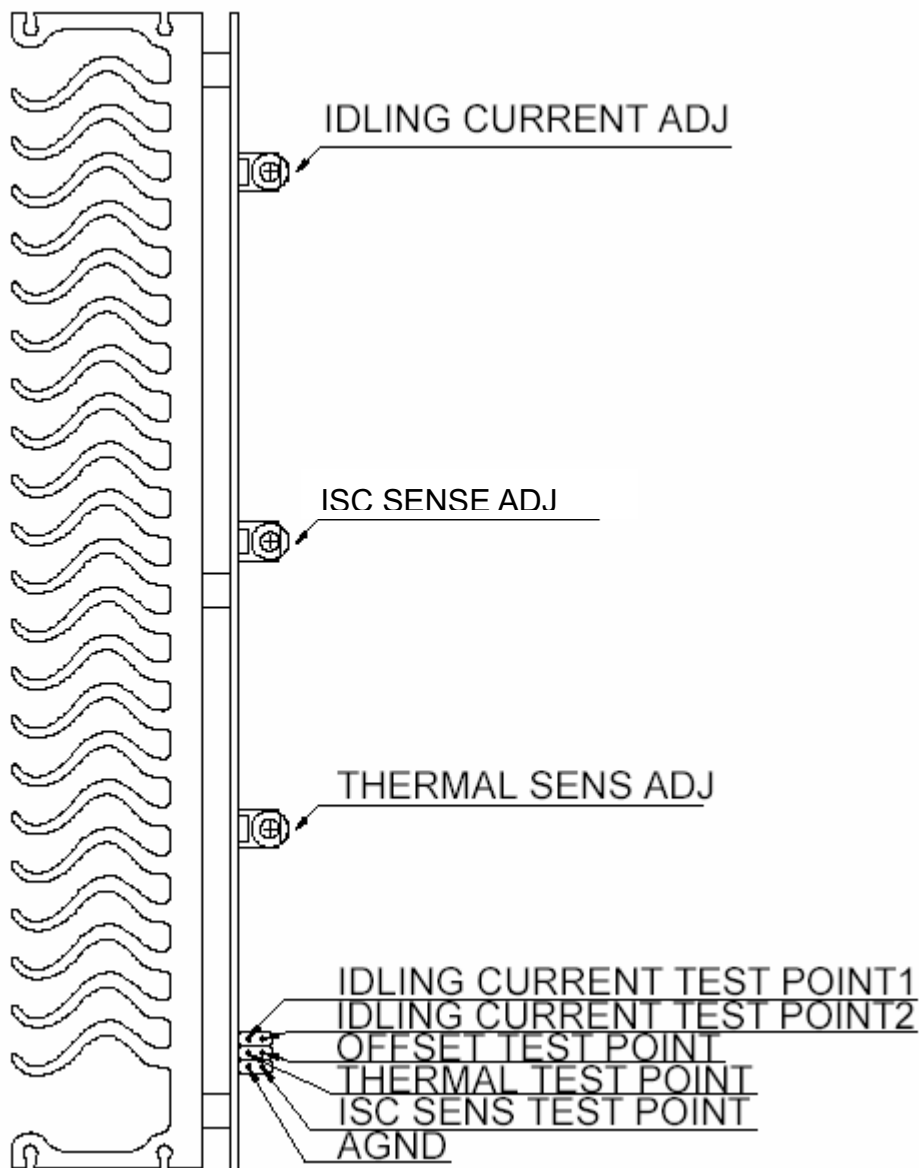

WIRING DIAGRAM

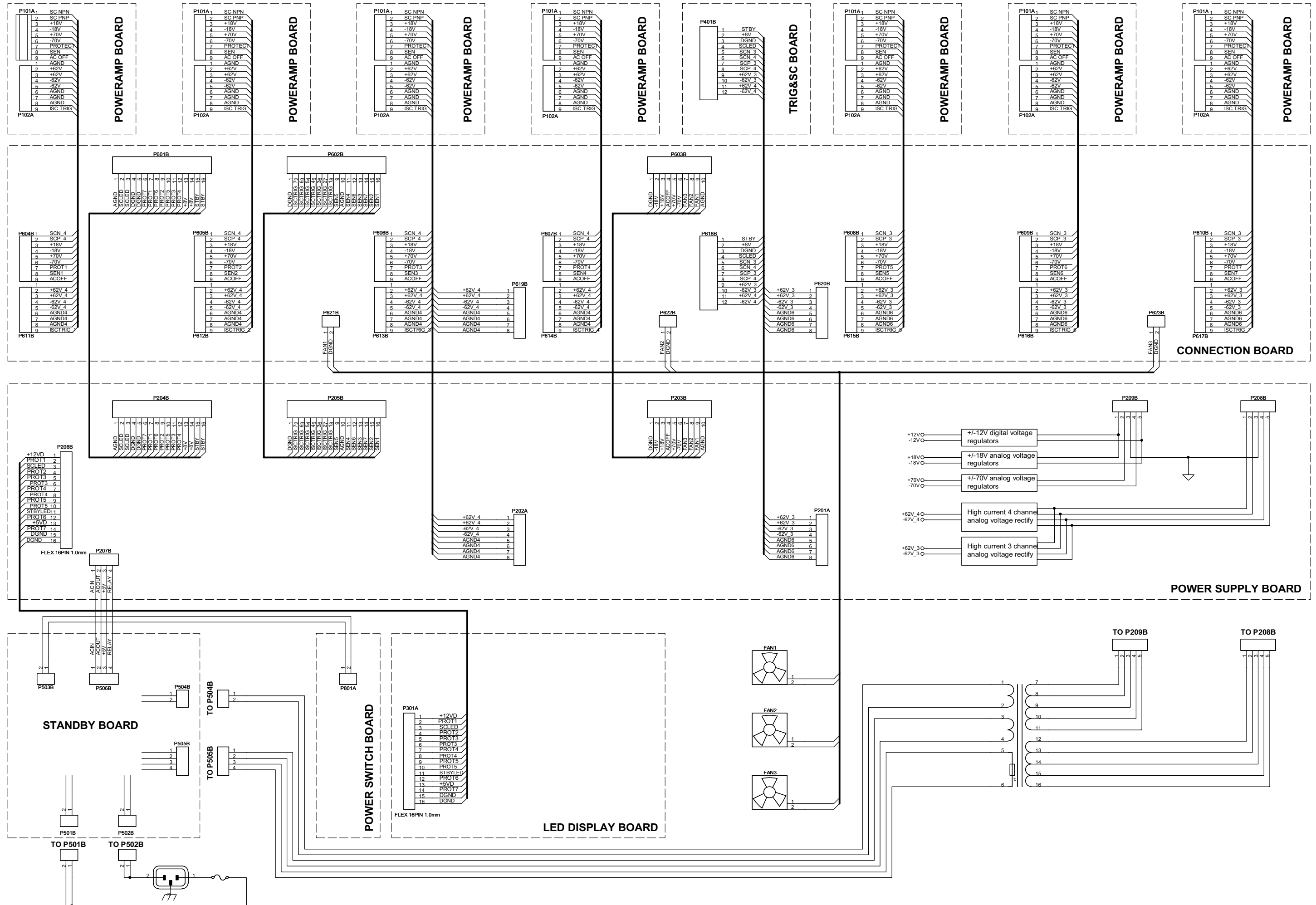

SCHEMATICS DIAGRAM

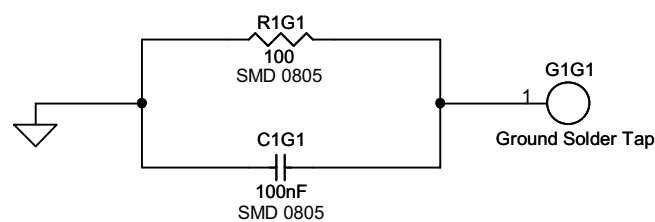
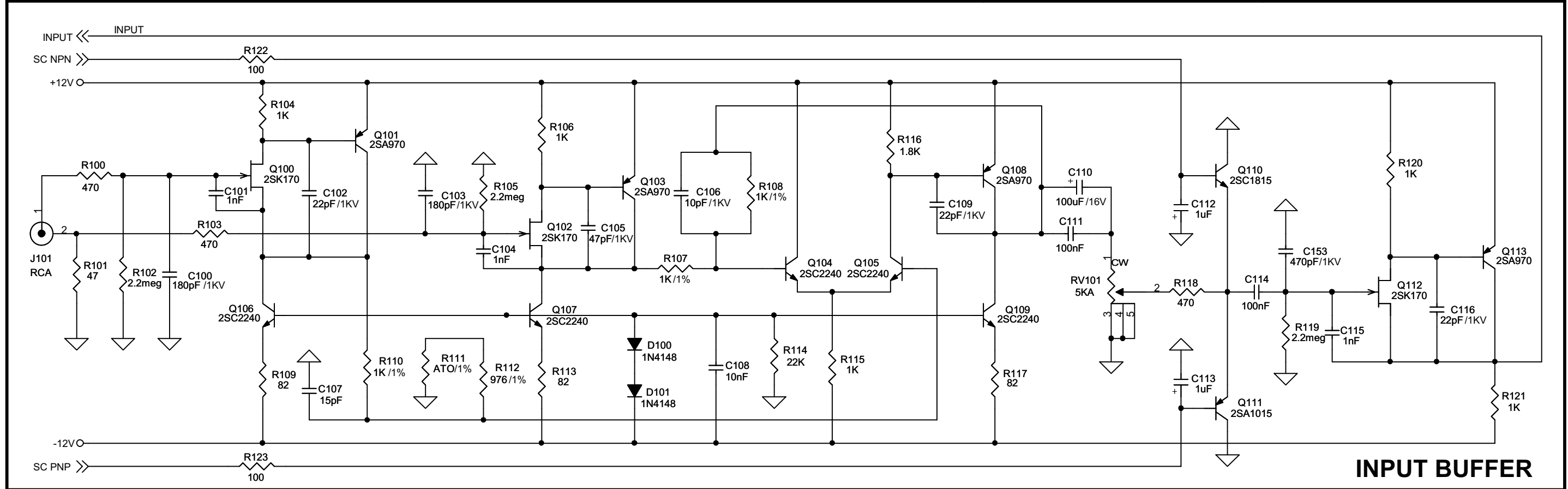
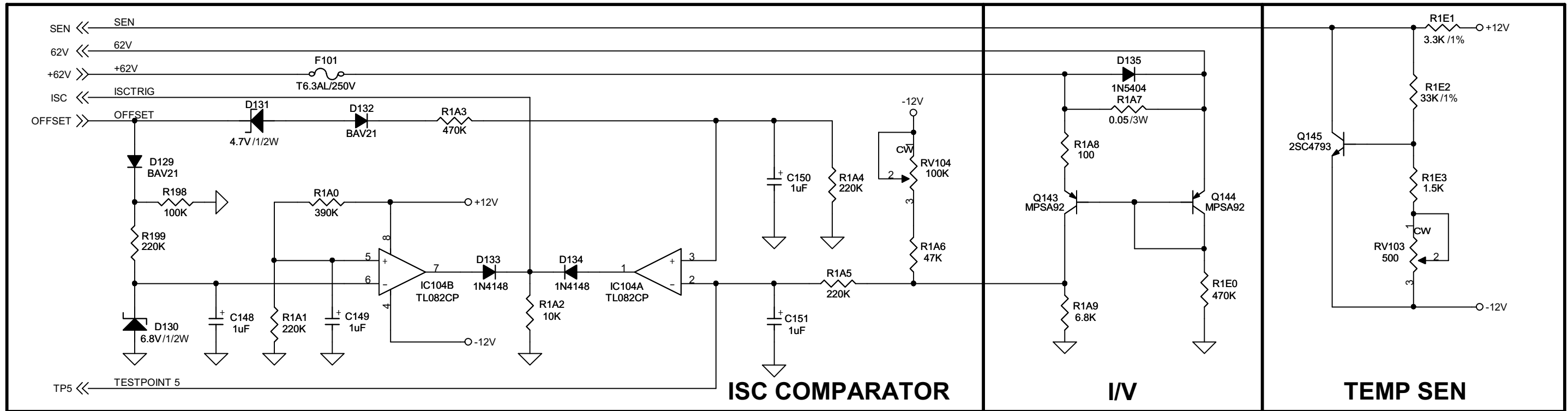

All Polyester capacitors are 63V unless noted.
 All Elec. capacitors are 50V unless noted.
 All Resistor are 1/6W RJ13 unless noted.

SCHEMATICS DIAGRAM

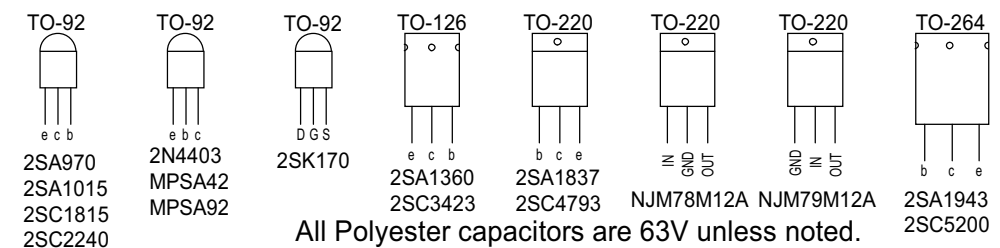
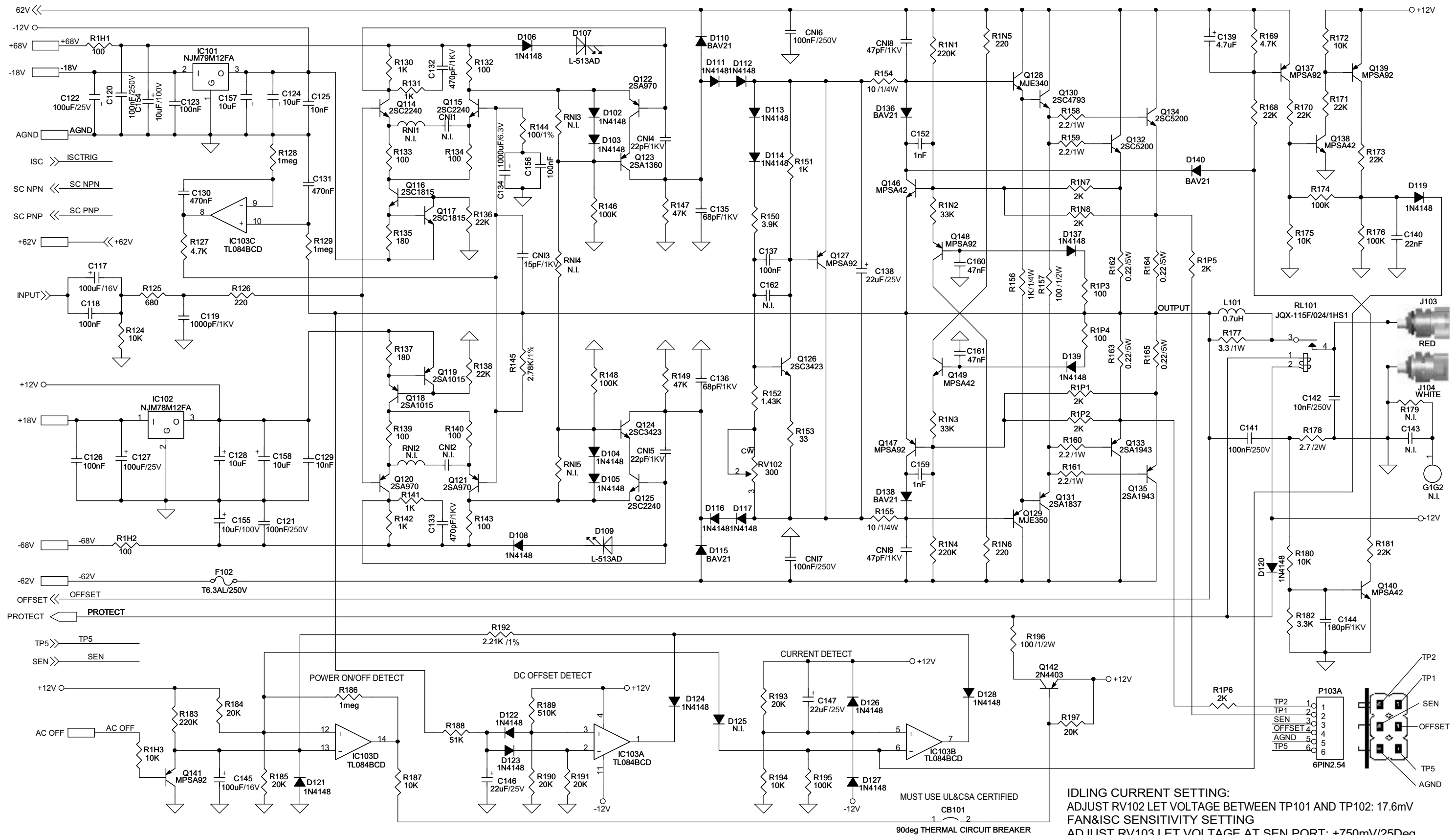

All Polyester capacitors are 63V unless noted.
 All Elec. capacitors are 50V unless noted.
 All Resistor are 1/6W RJ13 unless noted.

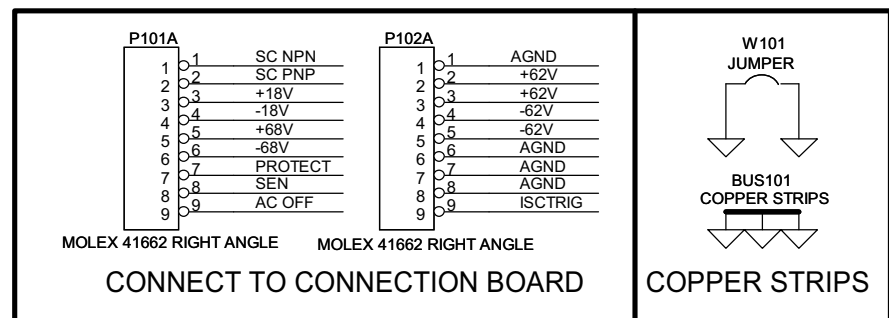

IDLING CURRENT SETTING:
 ADJUST RV102 LET VOLTAGE BETWEEN TP101 AND TP102: 17.6mV
FAN&ISC SENSITIVITY SETTING
 ADJUST RV103 LET VOLTAGE AT SEN PORT: +750mV/25Deg
 RESISTORS ARE CARBON FILM 1/6W UNLESS SPECIFIED

SCHEMATICS DIAGRAM

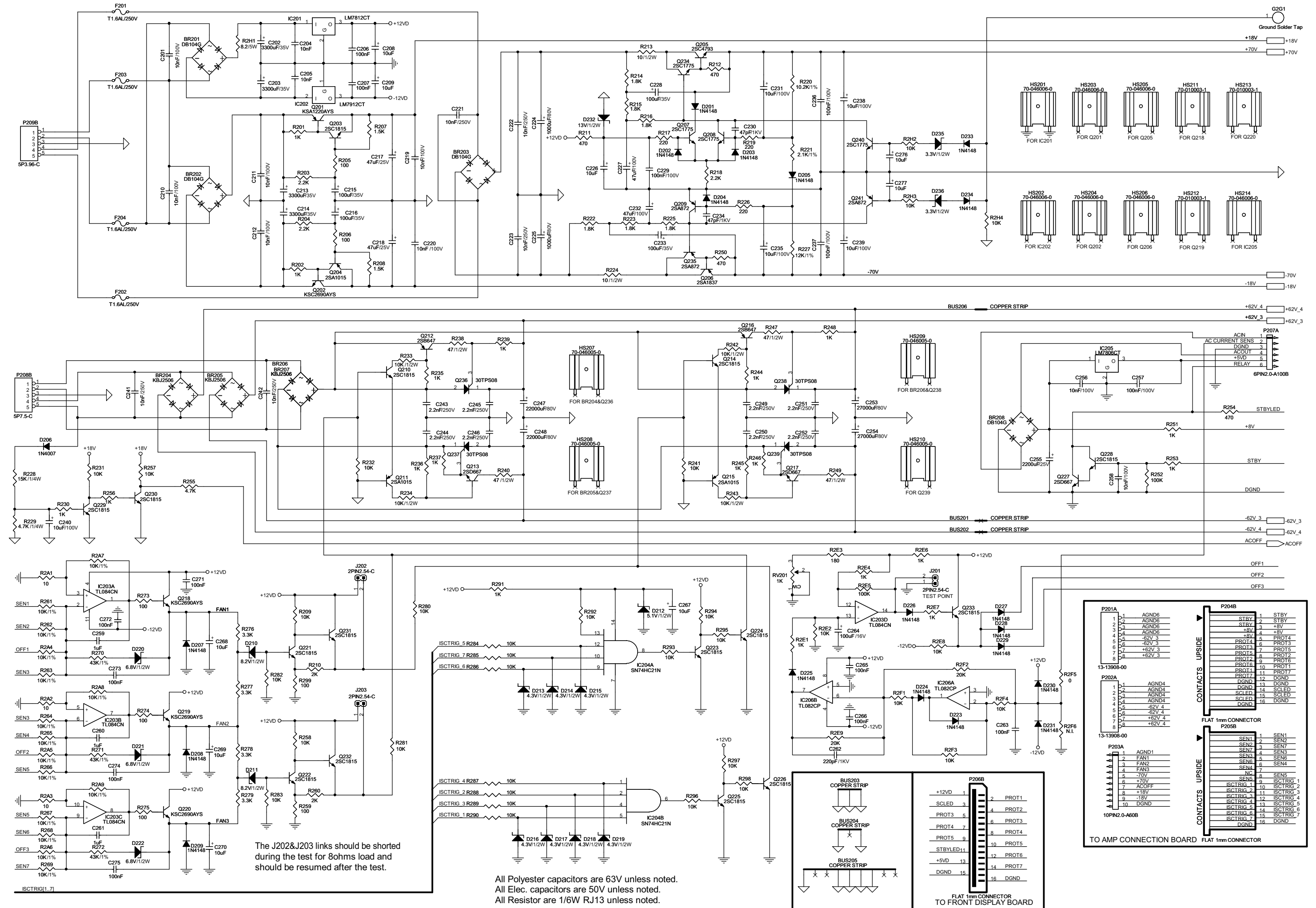

SCHEMATICS DIAGRAM

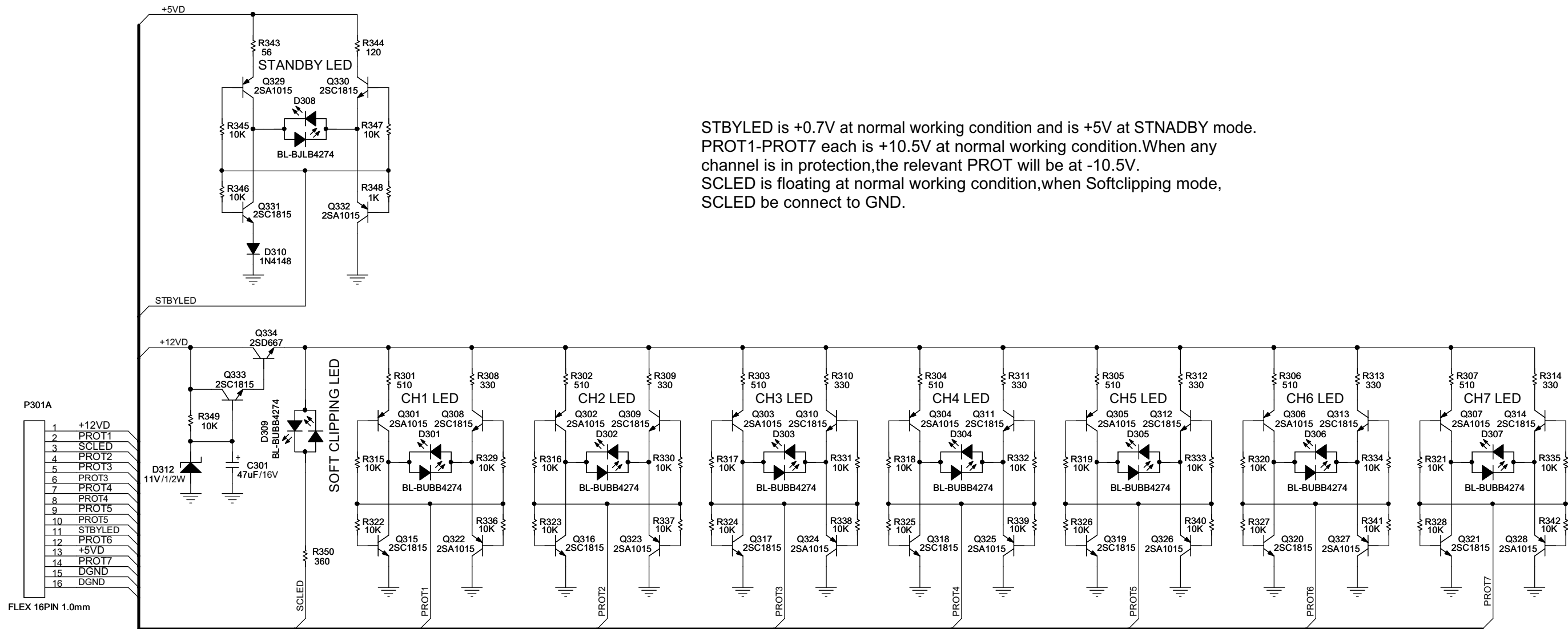

All Polyester capacitors are 63V unless noted.
 All Elec. capacitors are 50V unless noted.
 All Resistor are 1/6W unless noted.

SCHEMATICS DIAGRAM-

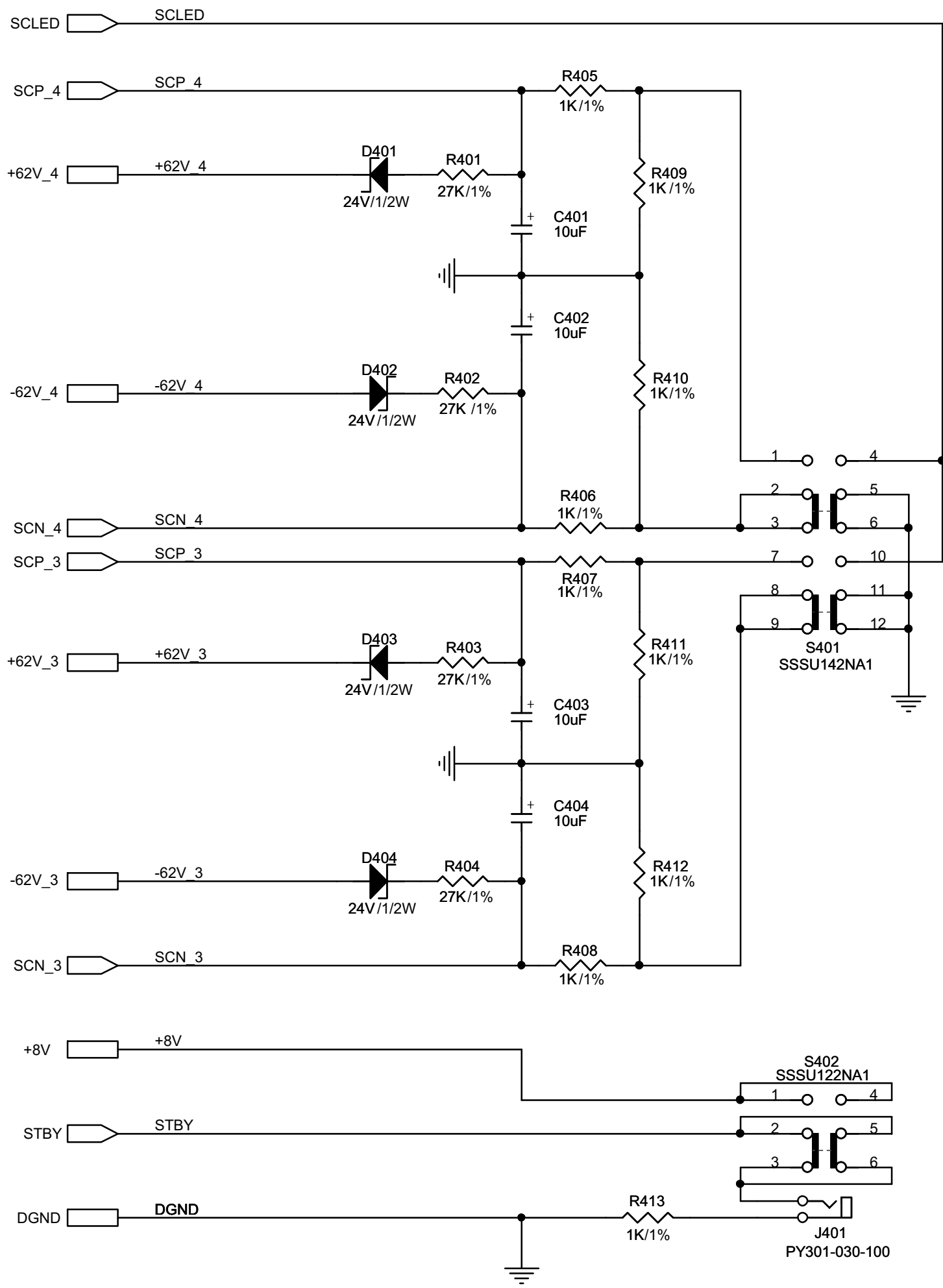

P401B

1	STBY
2	+8V
3	DGND
4	SCLED
5	SCN 3
6	SCP 3
7	SCP 4
8	SCP 4
9	+62V 3
10	-62V 3
11	+62V 4
12	-62V 4

12PIN2.0-C

All Polyester capacitors are 63V unless noted.
 All Elec. capacitors are 50V unless noted.
 All Resistor are 1/6W unless noted.

SCHEMATICS DIAGRAM

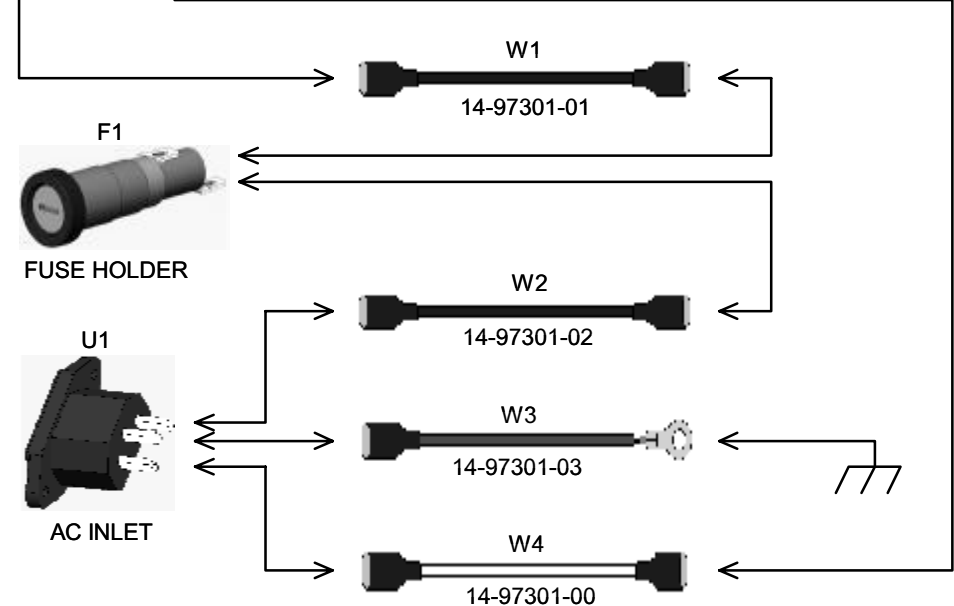
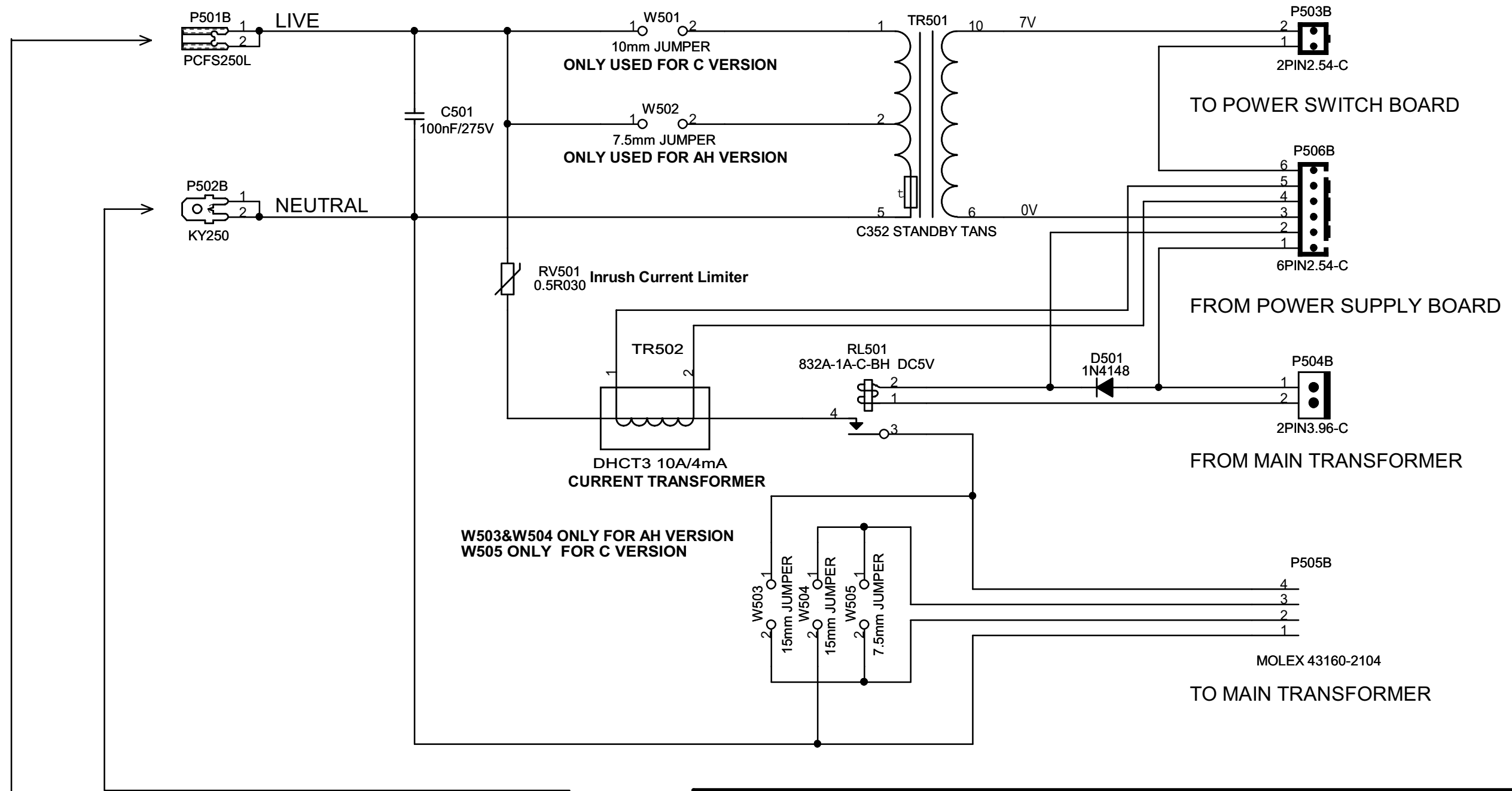

M25 120V/230V TABLE		
	120V	230V
W501&W505	NO INSERT	INSERT
W502,W503&W504	INSERT	NO INSERT
F1 (user accessible fuse)	T20AL/250V	T10AL/250V

SCHEMATICS DIAGRAM

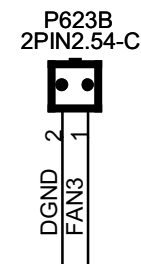
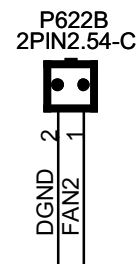
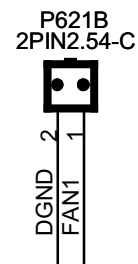
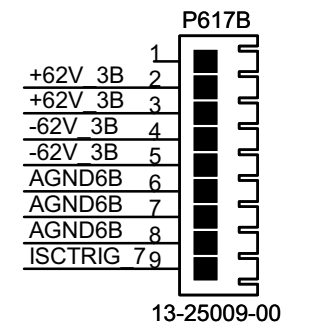
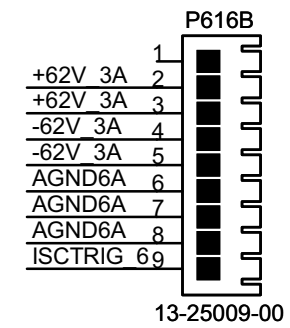
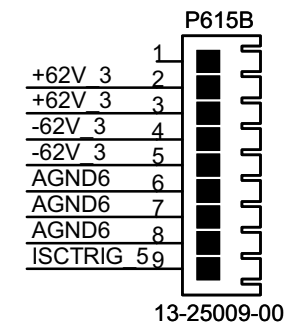
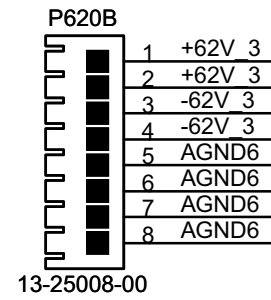
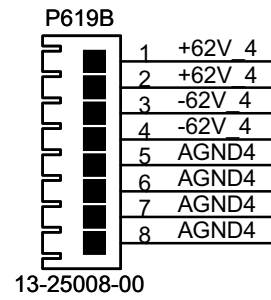
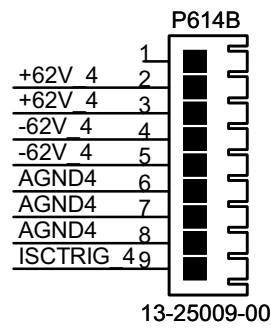
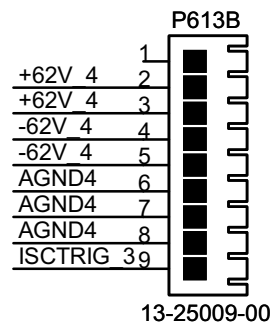
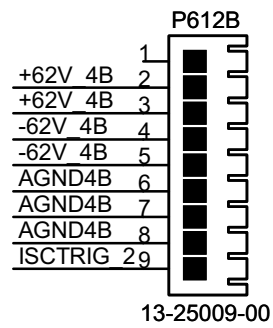
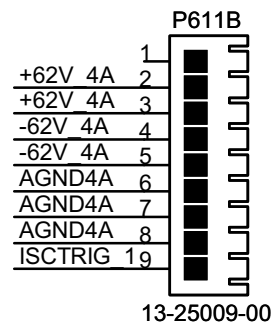
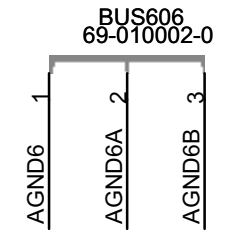
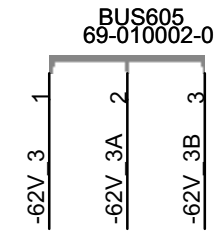
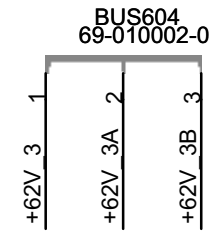
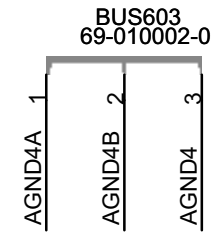
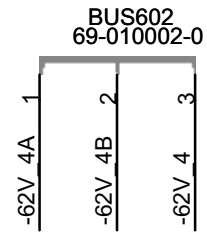
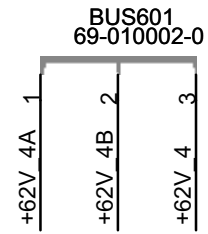
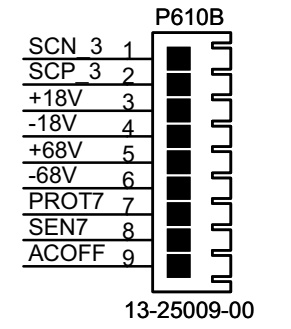
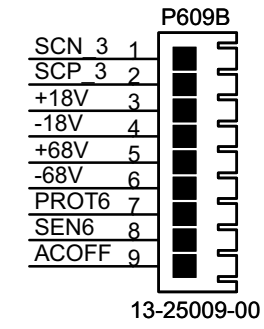
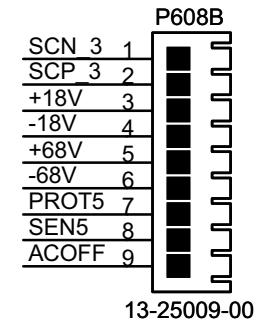
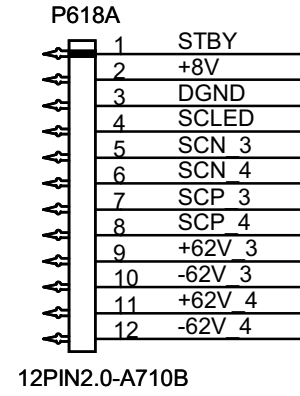
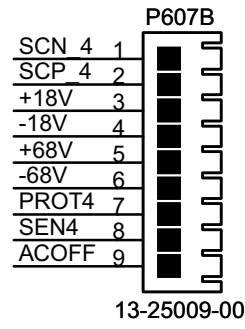
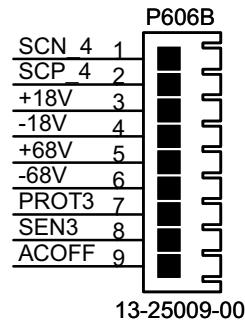
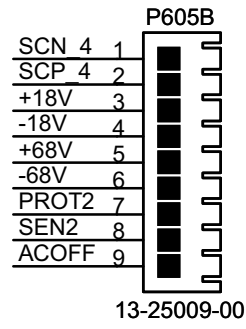
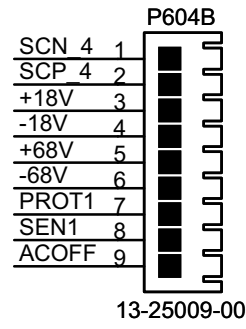
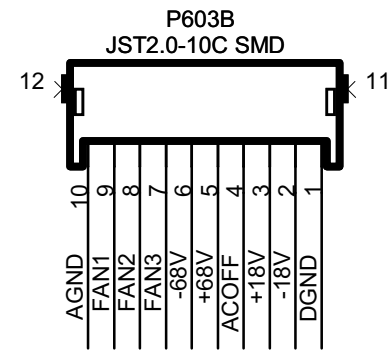
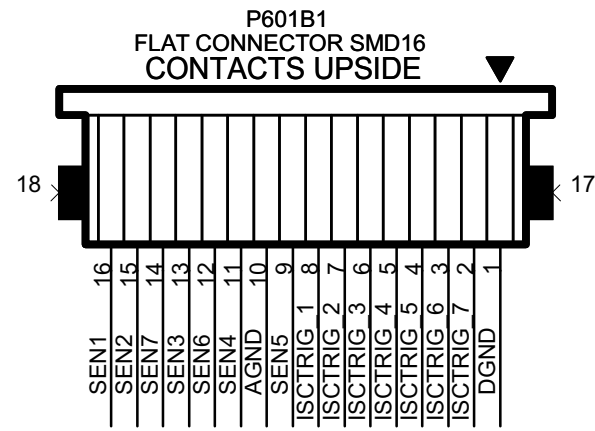
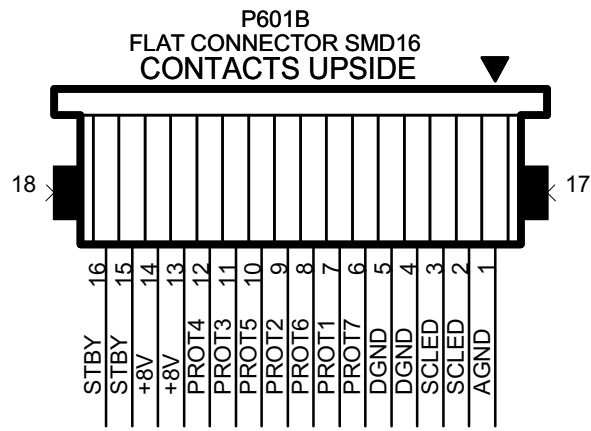

SCHEMATICS DIAGRAM

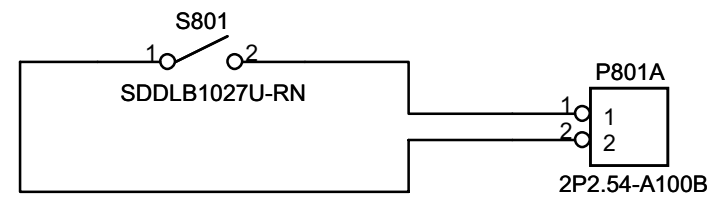

SCHEMATICS DIAGRAM

Primary leads are terminated with Molex 43375-0001 and with Molex housing 44441-2004

Secondary leads are terminated with Molex 43375-0001 and with Molex housing 44441-2005

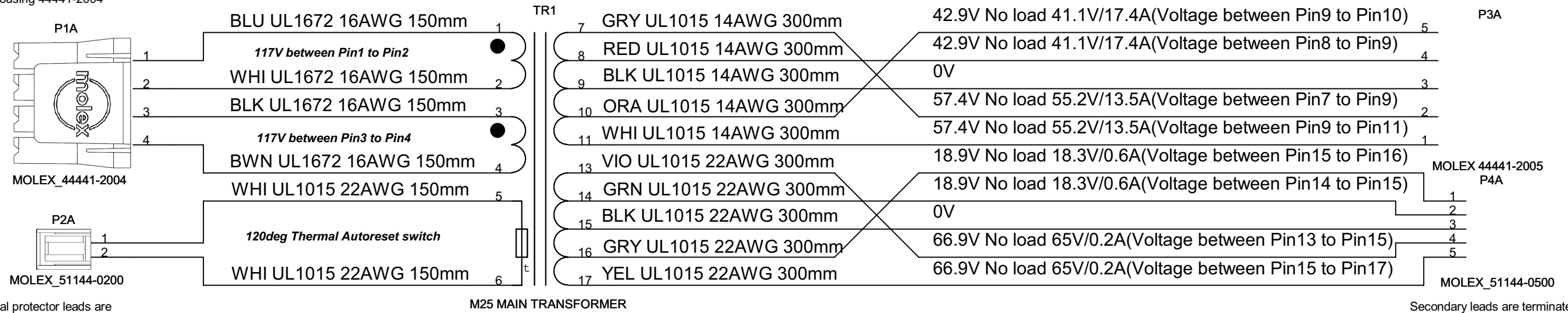

Thermal protector leads are terminated with Molex 50539-8000 and with Molex housing 51144-0200

Secondary leads are terminated with Molex 50539-8000 and with Molex housing 51144-0500

<p>Secondary high and low Alternative loads Secondary current at normal load Thermal protector mounted on secondary side but leads close to primary leads</p> <p>Diameter <162mm Center filled and 10mm hole Height <106mm Weight <10.8Kg</p> <p>Comments: 1)Primary resistance:2x0.36ohm 2)Secondary resistance:2x(0.065+0.03) and 2x(1.1+0.44)ohm 3)Calculated temperature rise at 1350VA continuous load:77 deg C 4)CUL recognized to UL6500 and Can/CSA E60065-00</p>	<p>Label: ⌈</p> <p>Toroid Audio Ltd P/N: TI-043810 AU Iss 2 NAD: M25 Thermal Autoreset 120Deg Class B insulation system (E202144/Z125) cULus logo + E115159 CE Logo</p> <p>⌋</p>
---	---

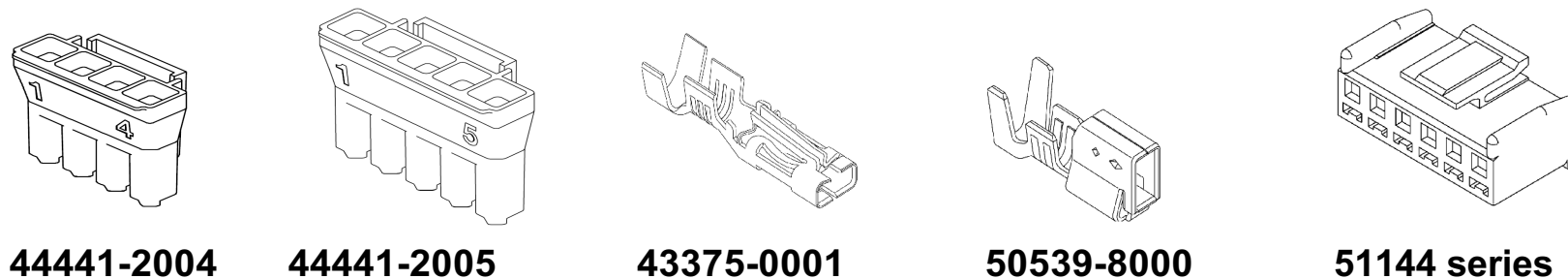

PCB LAYOUT

AMP BOARD - COMPONENT SIDE

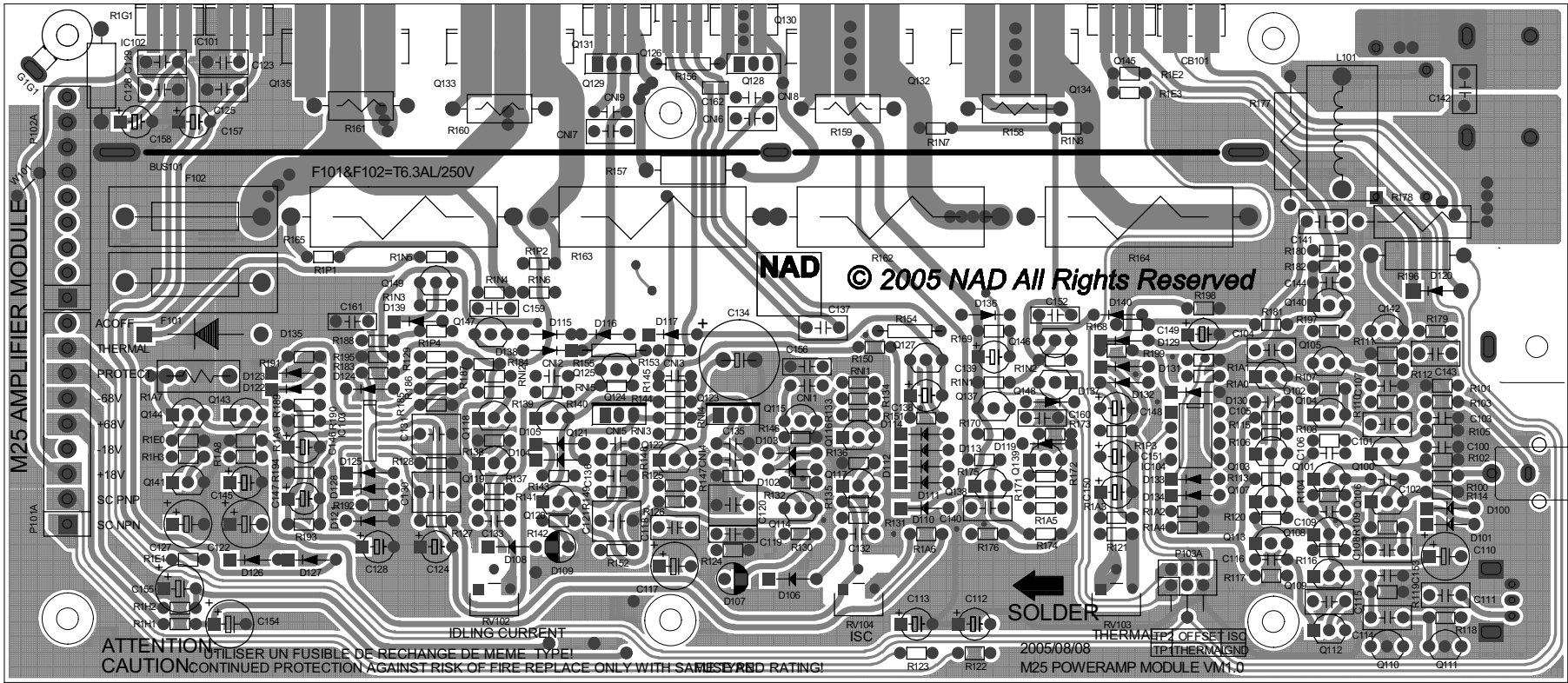

AMP BOARD - SOLDER SIDE

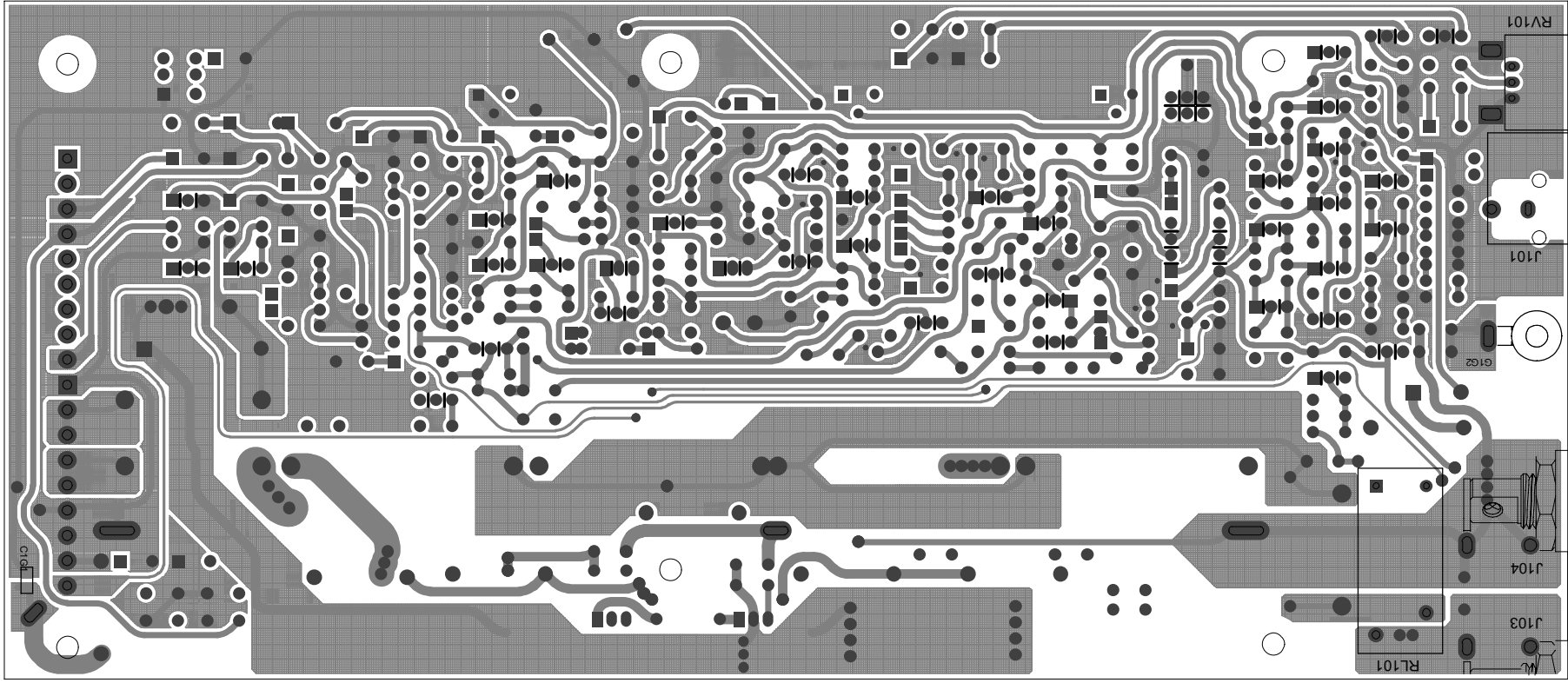

PCB LAYOUT

PSU BOARD - COMPONENT SIDE

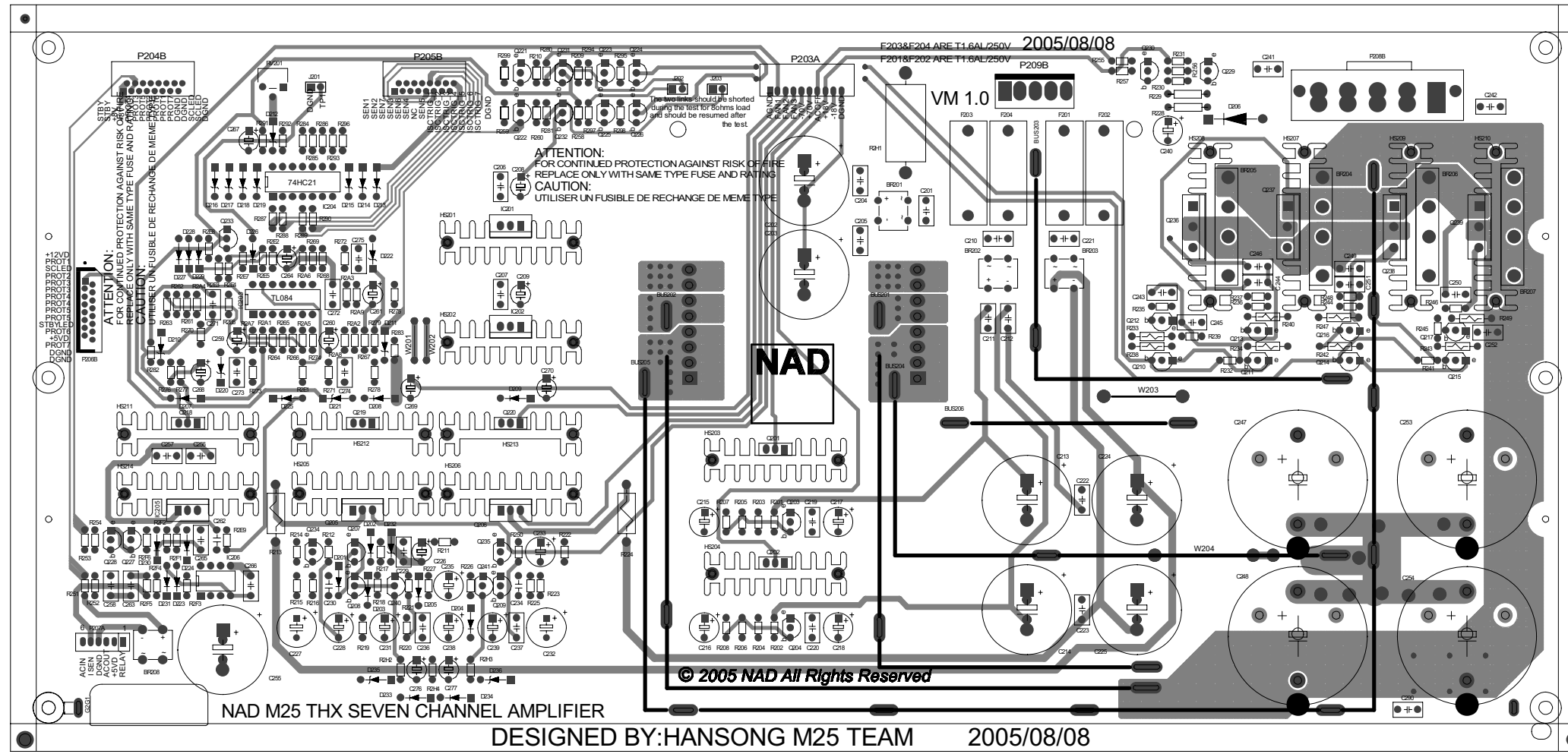

PSU BOARD - SOLDER SIDE

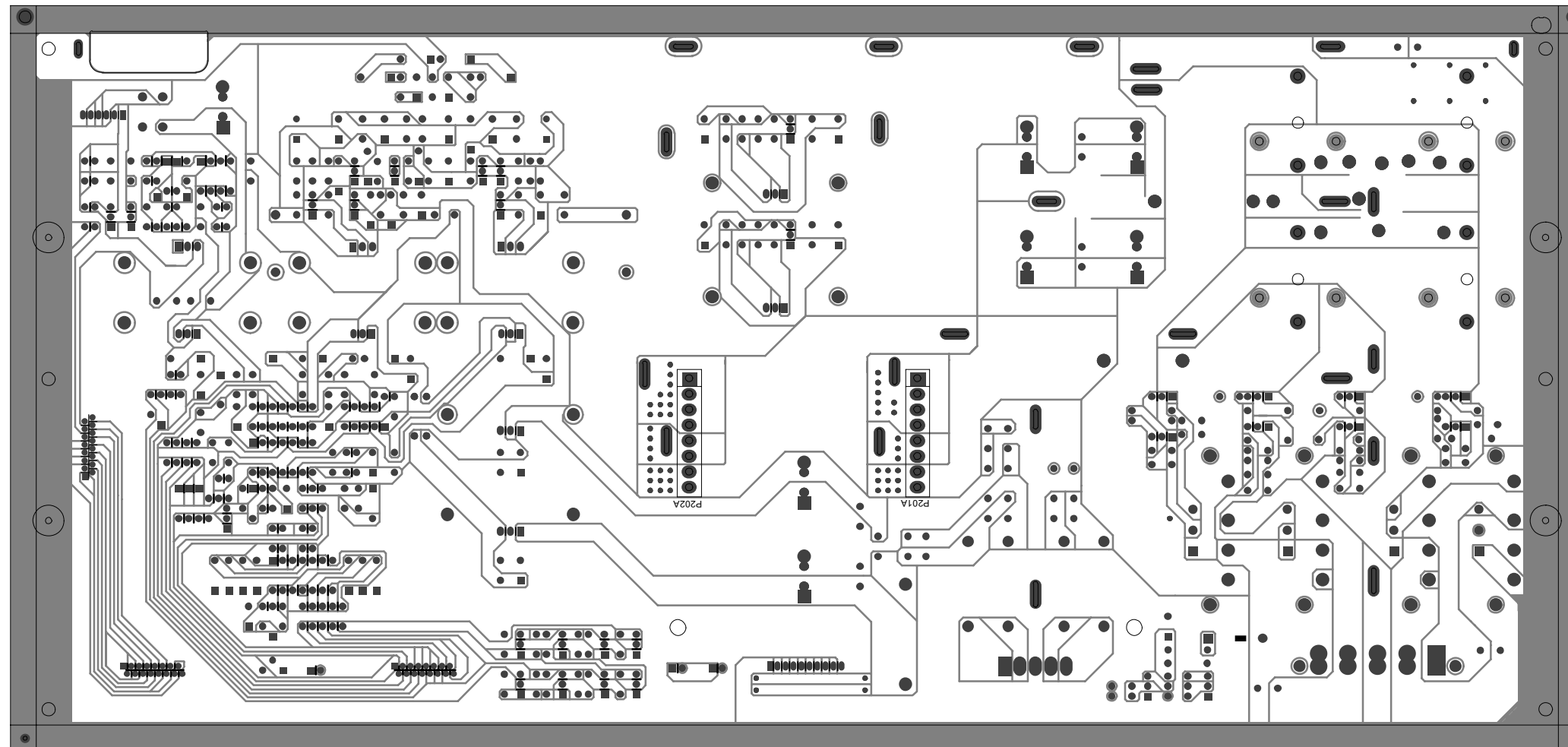

PCB LAYOUT

CONNECTION BOARD - COMPONENT SIDE

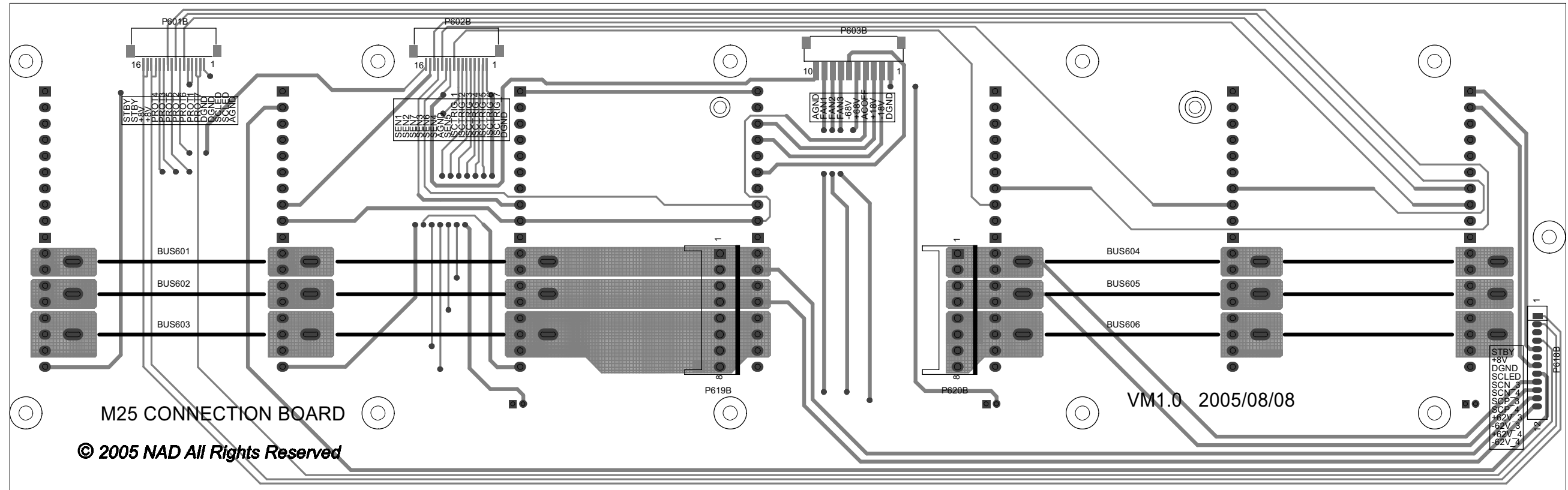

CONNECTION BOARD - COMPONENT SIDE

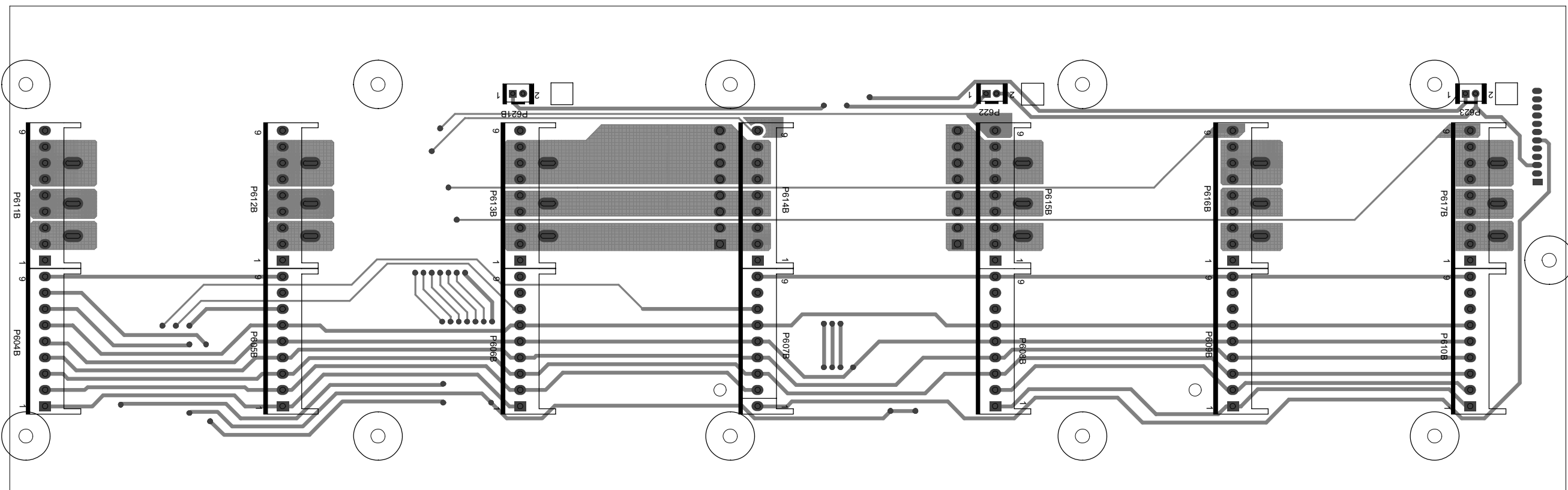

PCB LAYOUT

DISPLAY BOARD - COMPONENT SIDE

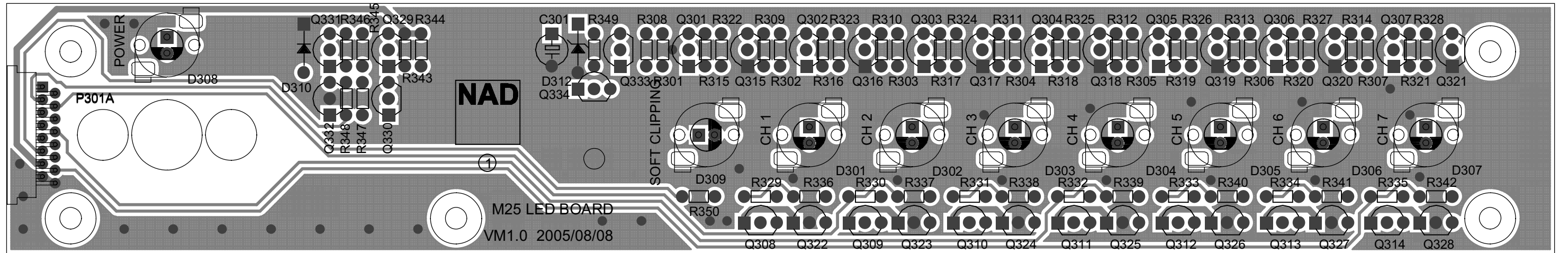

DISPLAY BOARD - SOLDER SIDE

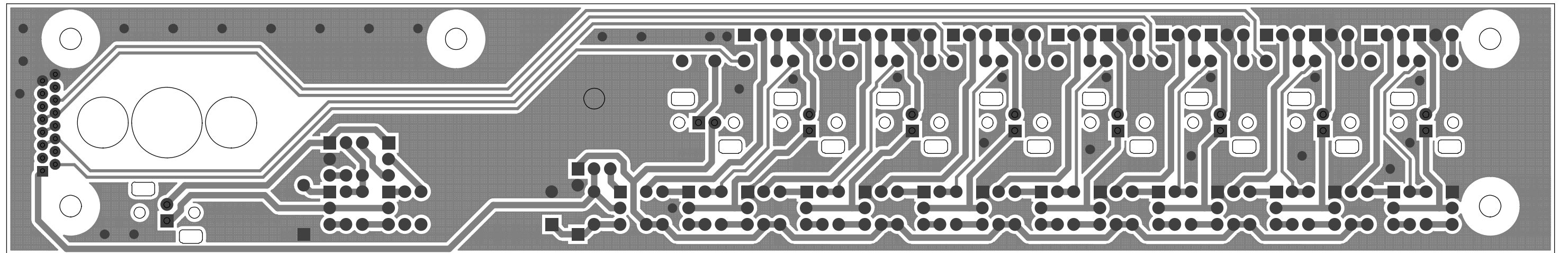

PCB LAYOUT

TRIGGER BOARD - COMPONENT SIDE

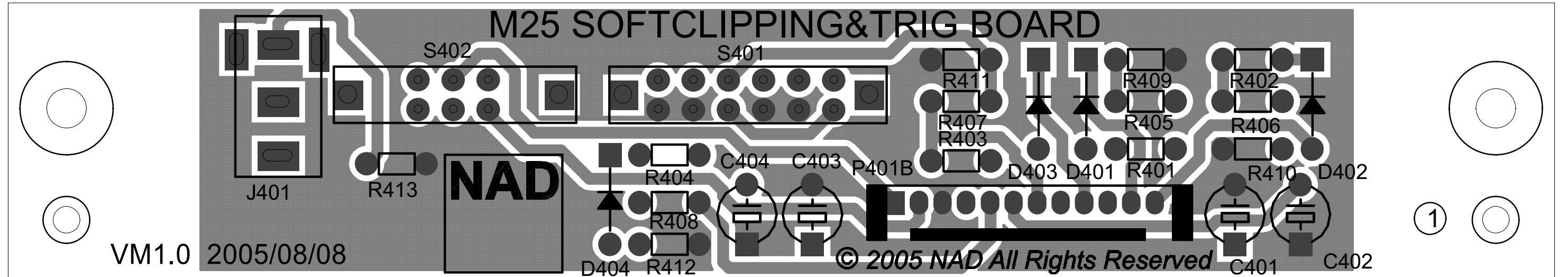

TRIGGER BOARD - SOLDER SIDE

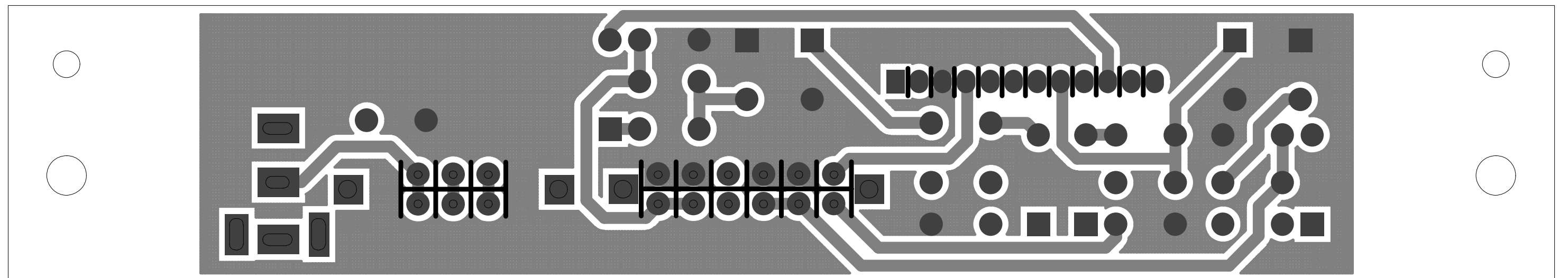

PCB LAYOUT

SW BOARD - COMPONENT SIDE

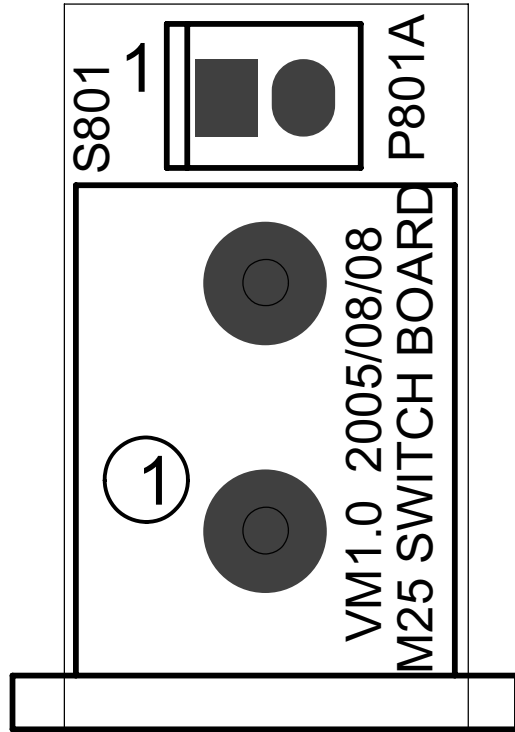

SW BOARD - SOLDER SIDE

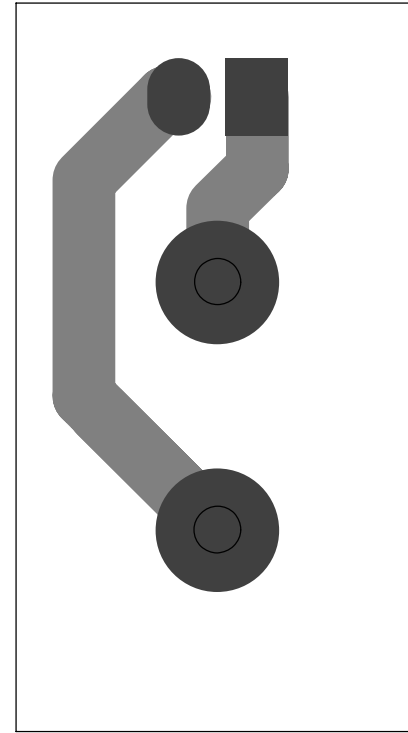

PCB LAYOUT

STANDBY BOARD - COMPONENT SIDE

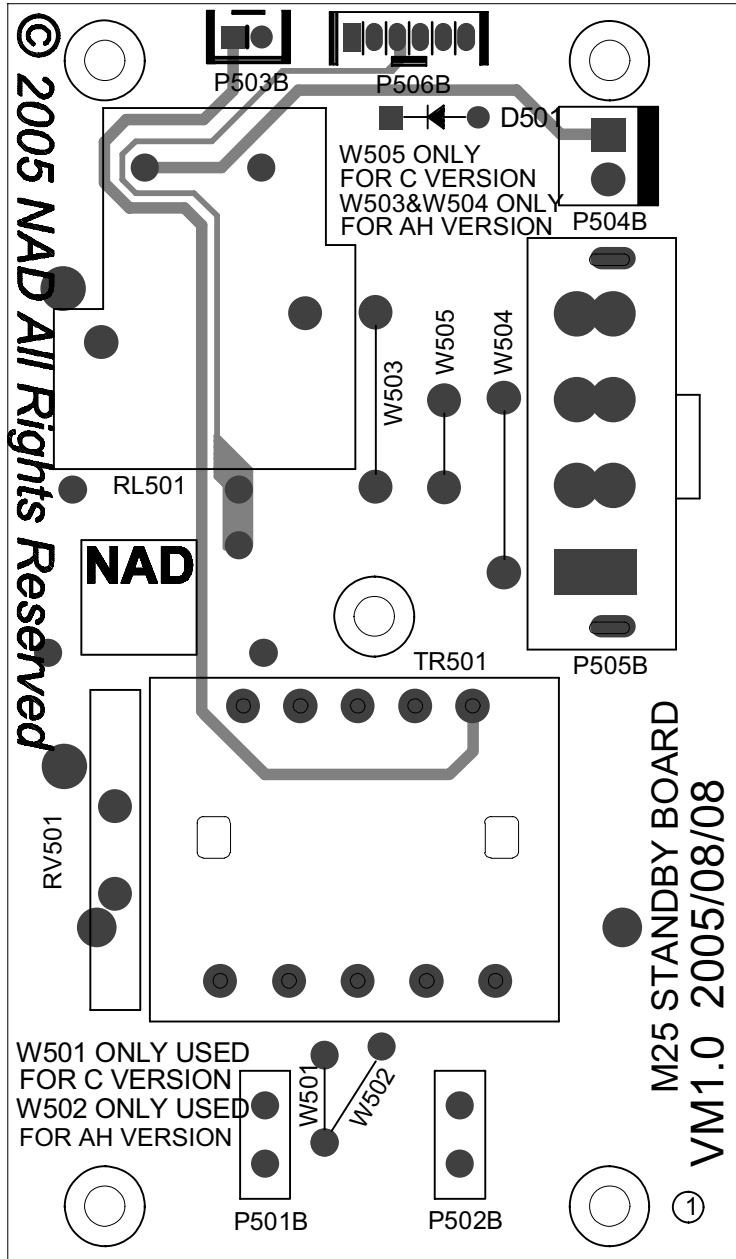

STANDBY BOARD - SOLDER SIDE

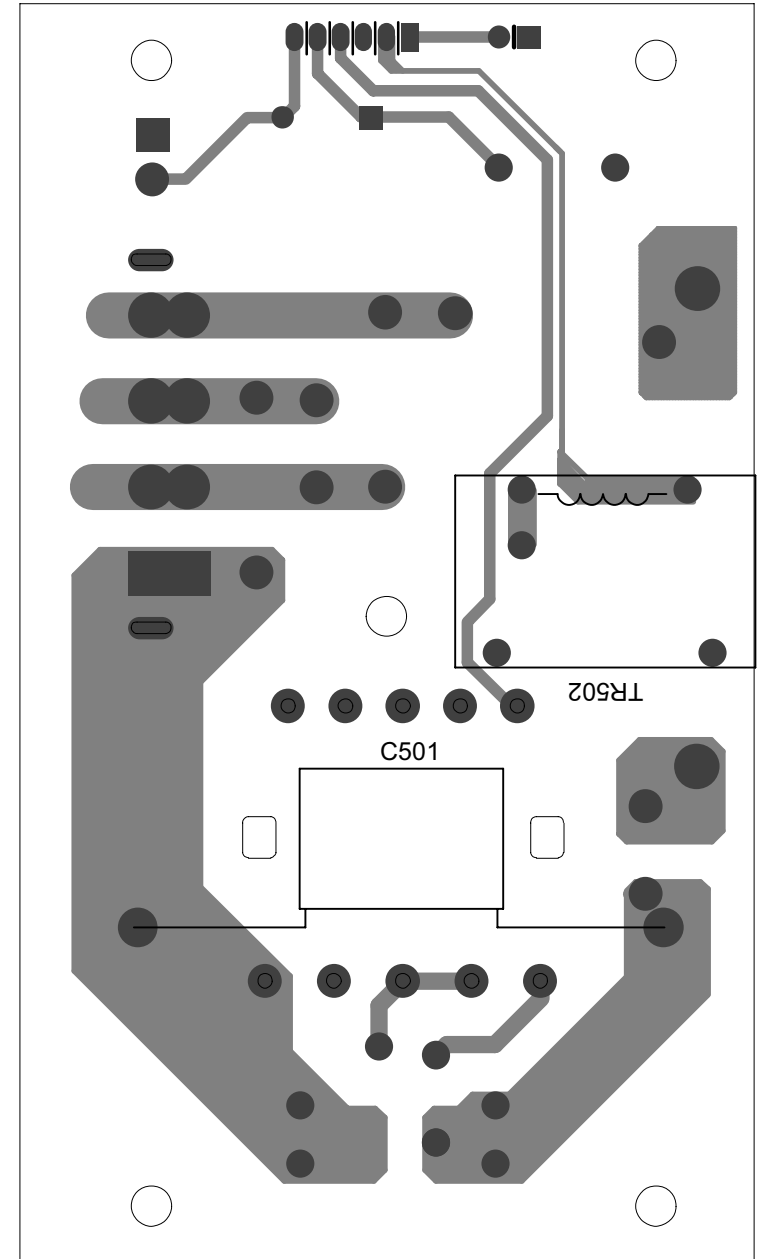

ELECTRICAL PARTS LIST

DESIGNATOR	DESCRIPTION	PART TYPE	PART NUMBER	FOOTPRINT
AH P/N : 01-52501-10 C/BC P/N : 01-52501-20 PCB1 BOARD (AMP)				
DIODE				
D100	Switch Diode	1N4148	33-44148-02	DAX/.300X.080/.031
D101	Switch Diode	1N4148	33-44148-02	DAX/.300X.080/.031
D102	Switch Diode	1N4148	33-44148-02	DAX/.300X.080/.031
D103	Switch Diode	1N4148	33-44148-02	DAX/.300X.080/.031
D104	Switch Diode	1N4148	33-44148-02	DAX/.300X.080/.031
D105	Switch Diode	1N4148	33-44148-02	DAX/.300X.080/.031
D106	Switch Diode	1N4148	33-44148-02	DAX/.300X.080/.031
D107	LED	φ3, Green	33-50350-00	DYL/D.200/LS.100/.039
D108	Switch Diode	1N4148	33-44148-02	DAX/.300X.080/.031
D109	LED	φ3, Green	33-50350-00	DYL/D.200/LS.100/.039
D110	Switch Diode	BAV21	33-40021-03	DAX/.300X.080/.031
D111	Switch Diode	1N4148	33-44148-02	DAX/.300X.080/.031
D112	Switch Diode	1N4148	33-44148-02	DAX/.300X.080/.031
D113	Switch Diode	1N4148	33-44148-02	DAX/.300X.080/.031
D114	Switch Diode	1N4148	33-44148-02	DAX/.300X.080/.031
D115	Switch Diode	BAV21	33-40021-03	DAX/.300X.080/.031
D116	Switch Diode	1N4148	33-44148-02	DAX/.300X.080/.031
D117	Switch Diode	1N4148	33-44148-02	DAX/.300X.080/.031
D119	Switch Diode	1N4148	33-44148-02	DAX/.300X.080/.031
D120	Switch Diode	1N4148	33-44148-02	DAX/.300X.080/.031
D121	Switch Diode	1N4148	33-44148-02	DAX/.300X.080/.031
D122	Switch Diode	1N4148	33-44148-02	DAX/.300X.080/.031
D123	Switch Diode	1N4148	33-44148-02	DAX/.300X.080/.031
D124	Switch Diode	1N4148	33-44148-02	DAX/.300X.080/.031
D126	Switch Diode	1N4148	33-44148-02	DAX/.300X.080/.031
D127	Switch Diode	1N4148	33-44148-02	DAX/.300X.080/.031
D128	Switch Diode	1N4148	33-44148-02	DAX/.300X.080/.031
D129	Switch Diode	BAV21	33-40021-03	DAX/.300X.080/.031
D130	Zener Diode	6.8V, 1/2W	33-16809-02	DAX/.300X.080/.031
D131	Zener Diode	4.7V, 1/2W	33-14709-01	DAX/.300X.080/.031
D132	Switch Diode	BAV21	33-40021-03	DAX/.300X.080/.031
D133	Switch Diode	1N4148	33-44148-02	DAX/.300X.080/.031
D134	Switch Diode	1N4148	33-44148-02	DAX/.300X.080/.031
D135	Recti Diode	1N5404	33-25404-01	DAX/.600X.200/.059
D136	Switch Diode	BAV21	33-40021-03	DAX/.300X.080/.031
D137	Switch Diode	1N4148	33-44148-02	DAX/.300X.080/.031
D138	Switch Diode	BAV21	33-40021-03	DAX/.300X.080/.031
D139	Switch Diode	1N4148	33-44148-02	DAX/.300X.080/.031
D140	Switch Diode	BAV21	33-40021-03	DAX/.300X.080/.031
TRANSISTOR				
Q100	Transistor	2SK170-BL	31-00170-00	TO92/100/DGS
Q101	Transistor	2SA970-GR	31-00970-00	TO92/100/ECB
Q102	Transistor	2SK170-BL	31-00170-00	TO92/100/DGS
Q103	Transistor	2SA970-GR	31-00970-00	TO92/100/ECB
Q104	Transistor	2SC2240-GR	31-02240-00	TO92/100/ECB
Q105	Transistor	2SC2240-GR	31-02240-00	TO92/100/ECB
Q106	Transistor	2SC2240-GR	31-02240-00	TO92/100/ECB
Q107	Transistor	2SC2240-GR	31-02240-00	TO92/100/ECB
Q108	Transistor	2SA970-GR	31-00970-00	TO92/100/ECB
Q109	Transistor	2SC2240-GR	31-02240-00	TO92/100/ECB
Q110	Transistor	2SC1815-GR	31-01815-00	TO92/100/ECB
Q111	Transistor	2SA1015-GR	31-01015-00	TO92/100/ECB
Q112	Transistor	2SK170-BL	31-00170-00	TO92/100/DGS
Q113	Transistor	2SA970-GR	31-00970-00	TO92/100/ECB
Q114	Transistor	2SC2240-GR	31-02240-00	TO92/100/ECB
Q115	Transistor	2SC2240-GR	31-02240-00	TO92/100/ECB
Q116	Transistor	2SC1815-GR	31-01815-00	TO92/100/ECB
Q117	Transistor	2SC1815-GR	31-01815-00	TO92/100/ECB
Q118	Transistor	2SA1015-GR	31-01015-00	TO92/100/ECB

ELECTRICAL PARTS LIST

DESIGNATOR	DESCRIPTION	PART TYPE	PART NUMBER	FOOTPRINT
Q119	Transistor	2SA1015-GR	31-01015-00	TO92/100/ECB
Q120	Transistor	2SA970-GR	31-00970-00	TO92/100/ECB
Q121	Transistor	2SA970-GR	31-00970-00	TO92/100/ECB
Q122	Transistor	2SA970-GR	31-00970-00	TO92/100/ECB
Q123	Transistor	2SA1360-O	31-01360-00	TO126/90/ECB
Q124	Transistor	2SC3423-O	31-03423-00	TO126/90/ECB
Q125	Transistor	2SC2240-GR	31-02240-00	TO92/100/ECB
Q126	Transistor	2SC3423-O	31-03423-00	TO126/90/ECB
Q127	Transistor	MPSA92	31-00092-00	TO92/100/EBC
Q128	Transistor	MJE340	31-00340-01	TO126/90/ECB
Q129	Transistor	MJE350	31-00350-01	TO126/90/ECB
Q130	Transistor	2SC4793	31-04793-00	TO220AB/215/SURFACE/BCE
Q131	Transistor	2SA1837	31-01837-00	TO220AB/215/SURFACE/BCE
Q132	Power Transistor	2SC5200-O	31-05200-00	TO264/215/SURFACE/BCE
Q133	Power Transistor	2SA1943-O	31-01943-00	TO264/215/SURFACE/BCE
Q134	Power Transistor	2SC5200-O	31-05200-00	TO264/215/SURFACE/BCE
Q135	Power Transistor	2SA1943-O	31-01943-00	TO264/215/SURFACE/BCE
Q137	Transistor	MPSA92	31-00092-00	TO92/100/EBC
Q138	Transistor	MPSA42	31-00042-00	TO92/100/EBC
Q139	Transistor	MPSA92	31-00092-00	TO92/100/EBC
Q140	Transistor	MPSA42	31-00042-00	TO92/100/EBC
Q141	Transistor	MPSA92	31-00092-00	TO92/100/EBC
Q142	Transistor	2N4403	31-04403-00	TO92/100/EBC
Q143	Transistor	MPSA92	31-00092-00	TO92/100/EBC
Q144	Transistor	MPSA92	31-00092-00	TO92/100/EBC
Q145	Transistor	2SC4793	31-04793-00	TO220AB/215/SURFACE/BCE
Q146	Transistor	MPSA42	31-00042-00	TO92/100/EBC
Q147	Transistor	MPSA92	31-00092-00	TO92/100/EBC
Q148	Transistor	MPSA92	31-00092-00	TO92/100/EBC
Q149	Transistor	MPSA42	31-00042-00	TO92/100/EBC
THERMAL SWITCH				
CB101	THERMAL CIRCUIT BRAKE	67L090	03-67090-00	TO220AC/SURFACE
IC				
IC101	RAGULATOR	NJM79M12FA	03-07912-20	TO220AB/SURFACE
IC102	RAGULATOR	NJM78M12FA	03-07812-20	TO220AB/SURFACE
IC103	QUAD OP-AMP	TL084BCD	03-00084-02	SOG.050/14/WG.244/L.375
IC104	DUAL OP-AMP	TL082CP	03-00082-00	DIP.100/8/W.300/L.750
RESISTOR				
R100	Metal Film Resistor	470Ω, 1/6W, 5%	07-20471-00	AXI.200X.080/.031
R101	Metal Film Resistor	47Ω, 1/6W, 5%	07-20470-00	AXI.200X.080/.031
R102	Metal Film Resistor	2.2megΩ, 1/6W, 5%	07-20225-00	AXI.200X.080/.031
R103	Metal Film Resistor	470Ω, 1/6W, 5%	07-20471-00	AXI.200X.080/.031
R104	Metal Film Resistor	1KΩ, 1/6W, 5%	07-20102-00	AXI.200X.080/.031
R105	Metal Film Resistor	2.2megΩ, 1/6W, 5%	07-20225-00	AXI.200X.080/.031
R106	Metal Film Resistor	1KΩ, 1/6W, 5%	07-20102-00	AXI.200X.080/.031
R107	Metal Film Resistor	1KΩ, 1/6W, 1%	07-21001-00	AXI.200X.080/.031
R108	Metal Film Resistor	1KΩ, 1/6W, 1%	07-21001-00	AXI.200X.080/.031
R109	Metal Film Resistor	82Ω, 1/6W, 5%	07-20820-00	AXI.200X.080/.031
R110	Metal Film Resistor	1KΩ, 1/6W, 1%	07-21001-00	AXI.200X.080/.031
R111	Metal Film Resistor	AOT, 1/6W, 1%	07-2****-00	AXI.200X.080/.031
R112	Metal Film Resistor	976Ω, 1/6W, 1%	07-29760-00	AXI.200X.080/.031
R113	Metal Film Resistor	82Ω, 1/6W, 5%	07-20820-00	AXI.200X.080/.031
R114	Metal Film Resistor	22KΩ, 1/6W, 5%	07-20223-00	AXI.200X.080/.031
R115	Metal Film Resistor	1KΩ, 1/6W, 5%	07-20102-00	AXI.200X.080/.031
R116	Metal Film Resistor	1K8Ω, 1/6W, 5%	07-20182-00	AXI.200X.080/.031
R117	Metal Film Resistor	82Ω, 1/6W, 5%	07-20820-00	AXI.200X.080/.031
R118	Metal Film Resistor	470Ω, 1/6W, 5%	07-20471-00	AXI.200X.080/.031
R119	Metal Film Resistor	2.2megΩ, 1/6W, 5%	07-20225-00	AXI.200X.080/.031
R120	Metal Film Resistor	1KΩ, 1/6W, 5%	07-20102-00	AXI.200X.080/.031
R121	Metal Film Resistor	1KΩ, 1/6W, 5%	07-20102-00	AXI.200X.080/.031

ELECTRICAL PARTS LIST

DESIGNATOR	DESCRIPTION	PART TYPE	PART NUMBER	FOOTPRINT
R122	Metal Film Resistor	100Ω, 1/6W, 5%	07-20101-00	AX/.200X.080/.031
R123	Metal Film Resistor	100Ω, 1/6W, 5%	07-20101-00	AX/.200X.080/.031
R124	Metal Film Resistor	10KΩ, 1/6W, 5%	07-20103-00	AX/.200X.080/.031
R125	Metal Film Resistor	1KΩ, 1/6W, 5%	07-20102-00	AX/.200X.080/.031
R126	Metal Film Resistor	220Ω, 1/6W, 5%	07-20221-00	AX/.200X.080/.031
R127	Metal Film Resistor	4K7Ω, 1/6W, 5%	07-20472-00	AX/.200X.080/.031
R128	Metal Film Resistor	1megΩ, 1/6W, 5%	07-20105-00	AX/.200X.080/.031
R129	Metal Film Resistor	1megΩ, 1/6W, 5%	07-20105-00	AX/.200X.080/.031
R130	Metal Film Resistor	1KΩ, 1/6W, 5%	07-20102-00	AX/.200X.080/.031
R131	Metal Film Resistor	1KΩ, 1/6W, 5%	07-20102-00	AX/.200X.080/.031
R132	Metal Film Resistor	100Ω, 1/6W, 5%	07-20101-00	AX/.200X.080/.031
R133	Metal Film Resistor	100Ω, 1/6W, 5%	07-20101-00	AX/.200X.080/.031
R134	Metal Film Resistor	100Ω, 1/6W, 5%	07-20101-00	AX/.200X.080/.031
R135	Metal Film Resistor	180Ω, 1/6W, 5%	07-20181-00	AX/.200X.080/.031
R136	Metal Film Resistor	22KΩ, 1/6W, 5%	07-20223-00	AX/.200X.080/.031
R137	Metal Film Resistor	180Ω, 1/6W, 5%	07-20181-00	AX/.200X.080/.031
R138	Metal Film Resistor	22KΩ, 1/6W, 5%	07-20223-00	AX/.200X.080/.031
R139	Metal Film Resistor	100Ω, 1/6W, 5%	07-20101-00	AX/.200X.080/.031
R140	Metal Film Resistor	100Ω, 1/6W, 5%	07-20101-00	AX/.200X.080/.031
R141	Metal Film Resistor	1KΩ, 1/6W, 5%	07-20102-00	AX/.200X.080/.031
R142	Metal Film Resistor	1KΩ, 1/6W, 5%	07-20102-00	AX/.200X.080/.031
R143	Metal Film Resistor	100Ω, 1/6W, 5%	07-20101-00	AX/.200X.080/.031
R144	Metal Film Resistor	100Ω, 1/6W, 1%	07-21000-00	AX/.200X.080/.031
R145	Metal Film Resistor	2K78 Ω, 1/6W, 1%	07-22781-00	AX/.200X.080/.031
R146	Metal Film Resistor	100KΩ, 1/6W, 5%	07-20104-00	AX/.200X.080/.031
R147	Metal Film Resistor	47KΩ, 1/6W, 5%	07-20473-00	AX/.200X.080/.031
R148	Metal Film Resistor	100KΩ, 1/6W, 5%	07-20104-00	AX/.200X.080/.031
R149	Metal Film Resistor	47KΩ, 1/6W, 5%	07-20473-00	AX/.200X.080/.031
R150	Metal Film Resistor	3K9Ω, 1/6W, 5%	07-20392-00	AX/.200X.080/.031
R151	Metal Film Resistor	1KΩ, 1/6W, 5%	07-20102-00	AX/.200X.080/.031
R152	Metal Film Resistor	1.43KΩ, 1/6W, 1%	07-21431-00	AX/.200X.080/.031
R153	Metal Film Resistor	33Ω, 1/6W, 5%	07-20330-00	AX/.200X.080/.031
R154	Metal Film Resistor	10Ω, 1/4W, 5%	07-20100-10	AX/.400X.080/.031
R155	Metal Film Resistor	10Ω, 1/4W, 5%	07-20100-10	AX/.400X.080/.031
R156	FUSEABLE Resistor	1KΩ, 1/4W, 5%	07-50102-00	AX/.400X.080/.031
R157	Metal Oxide Film Resistor	100Ω, 1/2W, 5%	07-30101-00	AX/.600X.125/.039
R158	Metal Oxide Film Resistor	2.2Ω, 1W, 5%	07-30229-01	AX/.600X.125/.039
R159	Metal Oxide Film Resistor	2.2Ω, 1W, 5%	07-30229-01	AX/.600X.125/.039
R160	Metal Oxide Film Resistor	2.2Ω, 1W, 5%	07-30229-01	AX/.600X.125/.039
R161	Metal Oxide Film Resistor	2.2Ω, 1W, 5%	07-30229-01	AX/.600X.125/.039
R162	Cement Resistor	0.22Ω, 5W, 5%	07-40228-05	AX/.1380X.375/.047
R163	Cement Resistor	0.22Ω, 5W, 5%	07-40228-05	AX/.1380X.375/.047
R164	Cement Resistor	0.22Ω, 5W, 5%	07-40228-05	AX/.1380X.375/.047
R165	Cement Resistor	0.22Ω, 5W, 5%	07-40228-05	AX/.1380X.375/.047
R168	Metal Film Resistor	22KΩ, 1/6W, 5%	07-20223-00	AX/.200X.080/.031
R169	Metal Film Resistor	4K7Ω, 1/6W, 5%	07-20472-00	AX/.200X.080/.031
R170	Metal Film Resistor	22KΩ, 1/6W, 5%	07-20223-00	AX/.200X.080/.031
R171	Metal Film Resistor	22KΩ, 1/6W, 5%	07-20223-00	AX/.200X.080/.031
R172	Metal Film Resistor	10KΩ, 1/6W, 5%	07-20103-00	AX/.200X.080/.031
R173	Metal Film Resistor	22KΩ, 1/6W, 5%	07-20223-00	AX/.200X.080/.031
R174	Metal Film Resistor	100KΩ, 1/6W, 5%	07-20104-00	AX/.200X.080/.031
R175	Metal Film Resistor	10KΩ, 1/6W, 5%	07-20103-00	AX/.200X.080/.031
R176	Metal Film Resistor	100KΩ, 1/6W, 5%	07-20104-00	AX/.200X.080/.031
R177	Metal Oxide Film Resistor	3.3Ω, 1W, 5%	07-30339-10	AX/.800X.200/.037
R178	Metal Oxide Film Resistor	2.7Ω, 2W, 5%	07-30279-02	AX/.800X.200/.037

ELECTRICAL PARTS LIST

DESIGNATOR	DESCRIPTION	PART TYPE	PART NUMBER	FOOTPRINT
R180	Metal Film Resistor	10K Ω , 1/6W, 5%	07-20103-00	AX/.200X.080/.031
R181	Metal Film Resistor	22K Ω , 1/6W, 5%	07-20223-00	AX/.200X.080/.031
R182	Metal Film Resistor	3K3 Ω , 1/6W, 1%	07-23301-00	AX/.200X.080/.031
R183	Metal Film Resistor	220K Ω , 1/6W, 5%	07-20224-00	AX/.200X.080/.031
R184	Metal Film Resistor	20K Ω , 1/6W, 5%	07-20203-00	AX/.200X.080/.031
R185	Metal Film Resistor	20K Ω , 1/6W, 5%	07-20203-00	AX/.200X.080/.031
R186	Metal Film Resistor	1meg Ω , 1/6W, 5%	07-20105-00	AX/.200X.080/.031
R187	Metal Film Resistor	10K Ω , 1/6W, 5%	07-20103-00	AX/.200X.080/.031
R188	Metal Film Resistor	51K Ω , 1/6W, 5%	07-20513-00	AX/.200X.080/.031
R189	Metal Film Resistor	510K Ω , 1/6W, 5%	07-20514-00	AX/.200X.080/.031
R190	Metal Film Resistor	20K Ω , 1/6W, 5%	07-20203-00	AX/.200X.080/.031
R191	Metal Film Resistor	20K Ω , 1/6W, 5%	07-20203-00	AX/.200X.080/.031
R192	Metal Film Resistor	2K21 Ω , 1/6W, 1%	07-22211-00	AX/.200X.080/.031
R193	Metal Film Resistor	20K Ω , 1/6W, 5%	07-20203-00	AX/.200X.080/.031
R194	Metal Film Resistor	10K Ω , 1/6W, 5%	07-20103-00	AX/.200X.080/.031
R195	Metal Film Resistor	100K Ω , 1/6W, 5%	07-20104-00	AX/.200X.080/.031
R196	Metal Oxide Film Resistor	100 Ω , 1/2W, 5%	07-30101-00	AX/.600X.125/.039
R197	Metal Film Resistor	20K Ω , 1/6W, 5%	07-20203-00	AX/.200X.080/.031
R198	Metal Film Resistor	100K Ω , 1/6W, 5%	07-20104-00	AX/.200X.080/.031
R199	Metal Film Resistor	220K Ω , 1/6W, 5%	07-20224-00	AX/.200X.080/.031
R1A0	Metal Film Resistor	390K Ω , 1/6W, 5%	07-20394-00	AX/.200X.080/.031
R1A1	Metal Film Resistor	220K Ω , 1/6W, 5%	07-20224-00	AX/.200X.080/.031
R1A2	Metal Film Resistor	10K Ω , 1/6W, 5%	07-20103-00	AX/.200X.080/.031
R1A3	Metal Film Resistor	470k Ω , 1/6W, 5%	07-20474-00	AX/.200X.080/.031
R1A4	Metal Film Resistor	220K Ω , 1/6W, 5%	07-20224-00	AX/.200X.080/.031
R1A5	Metal Film Resistor	220K Ω , 1/6W, 5%	07-20224-00	AX/.200X.080/.031
R1A6	Metal Film Resistor	47K Ω , 1/6W, 5%	07-20473-00	AX/.200X.080/.031
R1A7	Cement Resistor	0.05 Ω , 3W, 5%	07-40507-04	RAD/.525X.200/LS.315/.039
R1A8	Metal Film Resistor	100 Ω , 1/6W, 5%	07-20101-00	AX/.200X.080/.031
R1A9	Metal Film Resistor	6K8 Ω , 1/6W, 5%	07-20682-00	AX/.200X.080/.031
R1H3	Metal Film Resistor	10K Ω , 1/6W, 5%	07-20103-00	AX/.200X.080/.031
R1E0	Metal Film Resistor	470k Ω , 1/6W, 5%	07-20474-00	AX/.200X.080/.031
R1E1	Metal Film Resistor	3K3 Ω , 1/6W, 1%	07-23301-00	AX/.200X.080/.031
R1E2	Metal Film Resistor	33K Ω , 1/6W, 1%	07-23302-00	AX/.200X.080/.031
R1E3	Metal Film Resistor	1K5 Ω , 1/6W, 5%	07-20152-00	AX/.200X.080/.031
R1G1	Metal Oxide Film Resistor	100 Ω , 2W, 5%	07-30101-05	AX/.800X.200/.037
R1H1	Metal Film Resistor	100 Ω , 1/6W, 5%	07-20101-00	AX/.200X.080/.031
R1H2	Metal Film Resistor	100 Ω , 1/6W, 5%	07-20101-00	AX/.200X.080/.031
R1N1	Metal Film Resistor	220K Ω , 1/6W, 5%	07-20224-00	AX/.200X.080/.031
R1N2	Metal Film Resistor	33K Ω , 1/6W, 1%	07-23302-00	AX/.200X.080/.031
R1N3	Metal Film Resistor	33K Ω , 1/6W, 1%	07-23302-00	AX/.200X.080/.031
R1N4	Metal Film Resistor	220K Ω , 1/6W, 5%	07-20224-00	AX/.200X.080/.031
R1N5	Metal Film Resistor	220 Ω , 1/6W, 5%	07-20221-00	AX/.200X.080/.031
R1N6	Metal Film Resistor	220 Ω , 1/6W, 5%	07-20221-00	AX/.200X.080/.031
R1N7	Metal Film Resistor	2K Ω , 1/6W, 5%	07-20202-00	AX/.200X.080/.031
R1N8	Metal Film Resistor	2K Ω , 1/6W, 5%	07-20202-00	AX/.200X.080/.031
R1P1	Metal Film Resistor	2K Ω , 1/6W, 5%	07-20202-00	AX/.200X.080/.031
R1P2	Metal Film Resistor	2K Ω , 1/6W, 5%	07-20202-00	AX/.200X.080/.031
R1P3	Metal Film Resistor	100 Ω , 1/6W, 5%	07-20101-00	AX/.200X.080/.031
R1P4	Metal Film Resistor	100 Ω , 1/6W, 5%	07-20101-00	AX/.200X.080/.031
R1P5	Metal Film Resistor	2K Ω , 1/6W, 5%	07-20202-00	AX/.200X.080/.031
R1P6	Metal Film Resistor	2K Ω , 1/6W, 5%	07-20202-00	AX/.200X.080/.031
CAPACTIOR				
C100	Ceramic Capacitor	180pF, 10%, 1KV	05-18113-00	CPAX/.200X.100/.036
C101	Polyester capacitor	1nF, 5%, 63V	25-10261-00	RAD/.300X.150/LS.200/.031
C102	Ceramic Capacitor	22pF, 5%, 1KV	05-22013-02	CPAX/.200X.100/.032
C103	Ceramic Capacitor	180pF, 10%, 1KV	05-18113-00	CPAX/.200X.100/.036
C104	Polyester capacitor	1nF, 5%, 63V	25-10261-00	RAD/.300X.150/LS.200/.031
C105	Ceramic Capacitor	47pF, 5%, 1KV	05-47013-01	CPAX/.200X.100/.031

ELECTRICAL PARTS LIST

DESIGNATOR	DESCRIPTION	PART TYPE	PART NUMBER	FOOTPRINT
C106	Ceramic Capacitor	10pF, 5%, 1KV	05-10013-01	CPAX/.200X.100/.031
C107	Ceramic Capacitor	15pF, 5%, 1KV	05-15013-01	CPAX/.200X.100/.032
C108	Polyester capacitor	10nF, 10%, 63V	25-10361-04	RAD/.300X.150/LS.200/.031
C109	Ceramic Capacitor	22pF, 5%, 1KV	05-22013-02	CPAX/.200X.100/.032
C110	ALU Electrolytic Capacitor	100uF/25V, 20%, 105°C	06-10121-02	CPCYL1/D.300/LS.200/.031
C111	Polyester capacitor	100nF, 10%, 63V	25-10461-00	RAD/.300X.150/LS.200/.035
C112	ALU Electrolytic Capacitor	1uF/50V, 20%, 105°C	06-10951-03	CPCYL/D.200/LS.200/.031
C113	ALU Electrolytic Capacitor	1uF/50V, 20%, 105°C	06-10951-03	CPCYL/D.200/LS.200/.031
C114	Polyester capacitor	100nF, 10%, 63V	25-10461-00	RAD/.300X.150/LS.200/.035
C115	Polyester capacitor	1nF, 5%, 63V	25-10261-00	RAD/.300X.150/LS.200/.031
C116	Ceramic Capacitor	22pF, 5%, 1KV	05-22013-02	CPAX/.200X.100/.032
C117	ALU Electrolytic Capacitor	100uF/25V, 20%, 105°C	06-10121-02	CPCYL1/D.300/LS.200/.031
C118	Polyester capacitor	100nF, 10%, 63V	25-10461-00	RAD/.300X.150/LS.200/.035
C119	Polyester capacitor	1.8nF, 10%, 50V	25-18251-00	RAD/.300X.150/LS.200/.031
C120	Polyester capacitor	100nF, 5%, 250V	25-10422-01	RAD/.300X.150/LS.200/.034
C121	Polyester capacitor	100nF, 5%, 250V	25-10422-01	RAD/.300X.150/LS.200/.034
C122	ALU Electrolytic Capacitor	100uF/25V, 20%, 105°C	06-10121-02	CPCYL1/D.300/LS.200/.031
C123	Polyester capacitor	100nF, 10%, 63V	25-10461-00	RAD/.300X.150/LS.200/.035
C124	ALU Electrolytic Capacitor	10uF/50V, 20%, 105°C	06-10051-01	CPCYL1/D.200/LS.200/.031
C125	Polyester capacitor	10nF, 10%, 63V	25-10361-04	RAD/.300X.150/LS.200/.031
C126	Polyester capacitor	100nF, 10%, 63V	25-10461-00	RAD/.300X.150/LS.200/.035
C127	ALU Electrolytic Capacitor	100uF/25V, 20%, 105°C	06-10121-02	CPCYL1/D.300/LS.200/.031
C128	ALU Electrolytic Capacitor	10uF/50V, 20%, 105°C	06-10051-01	CPCYL1/D.200/LS.200/.031
C129	Polyester capacitor	10nF, 10%, 63V	25-10361-04	RAD/.300X.150/LS.200/.031
C130	Polyester capacitor	470nF, 10%, 63V	25-47461-01	RAD/.300X.150/LS.200/.036
C131	Polyester capacitor	470nF, 10%, 63V	25-47461-01	RAD/.300X.150/LS.200/.036
C132	Ceramic Capacitor	470pF, 10%, 1KV	05-47113-00	CPAX/.200X.100/.038
C133	Ceramic Capacitor	470pF, 10%, 1KV	05-47113-00	CPAX/.200X.100/.038
C134	ALU Electrolytic Capacitor	1000uF/6.3V, 20%, 105°C	06-10260-01	CPCYL1/D.500/LS.200/.031
C135	Ceramic Capacitor	68pF, 10%, 1KV	05-68013-00	CPAX/.200X.100/.034
C136	Ceramic Capacitor	68pF, 10%, 1KV	05-68013-00	CPAX/.200X.100/.034
C137	Polyester capacitor	100nF, 10%, 63V	25-10461-00	RAD/.300X.150/LS.200/.035
C138	ALU Electrolytic Capacitor	22uF/25V, 20%, 105°C	06-22021-01	CPCYL1/D.200/LS.200/.031
C139	ALU Electrolytic Capacitor	4.7uF/50V, 20%, 105°C	06-47951-05	CPCYL/D.200/LS.200/.031
C140	Polyester capacitor	22nF, 10%, 63V	25-22361-03	RAD/.300X.150/LS.200/.031
C141	Polyester capacitor	100nF, 5%, 250V	25-10422-01	RAD/.300X.150/LS.200/.034
C142	Polyester capacitor	10nF, 5%, 250V	25-10322-02	RAD/.300X.150/LS.200/.033
C144	Ceramic Capacitor	180pF, 10%, 1KV	05-18113-00	CPAX/.200X.100/.036
C145	ALU Electrolytic Capacitor	100uF/16V, 20%, 105°C	06-10111-03	CPCYL1/D.200/LS.200/.031
C146	ALU Electrolytic Capacitor	22uF/25V, 20%, 105°C	06-22021-01	CPCYL1/D.200/LS.200/.031
C147	ALU Electrolytic Capacitor	22uF/25V, 20%, 105°C	06-22021-01	CPCYL1/D.200/LS.200/.031
C148	ALU Electrolytic Capacitor	1uF/50V, 20%, 105°C	06-10951-03	CPCYL/D.200/LS.200/.031
C149	ALU Electrolytic Capacitor	1uF/50V, 20%, 105°C	06-10951-03	CPCYL/D.200/LS.200/.031
C150	ALU Electrolytic Capacitor	1uF/50V, 20%, 105°C	06-10951-03	CPCYL/D.200/LS.200/.031

ELECTRICAL PARTS LIST

DESIGNATOR	DESCRIPTION	PART TYPE	PART NUMBER	FOOTPRINT
C151	ALU Electrolytic Capacitor	1uF/50V, 20%, 105°C	06-10951-03	CPCYL/D.200/LS.200/.031
C152	Polyester capacitor	1nF, 5%, 63V	25-10261-00	RAD/.300X.150/LS.200/.031
C153	Ceramic Capacitor	470pF, 10%, 1KV	05-47113-00	CPAX/.200X.100/.038
C154	ALU Electrolytic Capacitor	10uF/100V, 20%, 105°C	06-10012-01	CPCYL1/D.300/LS.200/.031
C155	ALU Electrolytic Capacitor	10uF/100V, 20%, 105°C	06-10012-01	CPCYL1/D.300/LS.200/.031
C156	Polyester capacitor	100nF, 10%, 63V	25-10461-00	RAD/.300X.150/LS.200/.035
C157	ALU Electrolytic Capacitor	10uF/50V, 20%, 105°C	06-10051-01	CPCYL1/D.200/LS.200/.031
C158	ALU Electrolytic Capacitor	10uF/50V, 20%, 105°C	06-10051-01	CPCYL1/D.200/LS.200/.031
C159	Polyester capacitor	1nF, 5%, 63V	25-10261-00	RAD/.300X.150/LS.200/.031
C160	Polyester capacitor	47nF, 5%, 63V	25-47361-01	RAD/.300X.150/LS.200/.034
C161	Polyester capacitor	47nF, 5%, 63V	25-47361-01	RAD/.300X.150/LS.200/.034
C1G1	Ceramic Capacitor SMD	100nF, 10%, 50V	26-10451-11	SM/C_0805
CNI3	Ceramic Capacitor	15pF, 10%, 1KV	05-15013-00	CPAX/.200X.100/.032
CNI4	Ceramic Capacitor	22pF, 10%, 1KV	05-22013-00	CPAX/.200X.100/.032
CNI5	Ceramic Capacitor	22pF, 10%, 1KV	05-22013-00	CPAX/.200X.100/.032
CNI6	Polyester capacitor	100nF, 5%, 250V	25-10422-01	RAD/.300X.150/LS.200/.034
CNI7	Polyester capacitor	100nF, 5%, 250V	25-10422-01	RAD/.300X.150/LS.200/.034
CNI8	Ceramic Capacitor	47pF, 10%, 1KV	05-47013-00	CPAX/.200X.100/.031
CNI9	Ceramic Capacitor	47pF, 10%, 1KV	05-47013-00	CPAX/.200X.100/.031
INDUCTOR				
L101	Inductor	0.7uH, horizontal type	08-01079-01	RAD/.850X.450/LS.700/.059
RELAY				
RL101	Relay	JQX-115F/024/1HS1	12-03101-03	RELAY_1
POT				
RV101	POT	5K, RK09K1110482-5KA	09-01502-00	VPOT1
RV102	SEMI POT	300Ω, vertical type	09-02301-01	VRES17
RV103	SEMI POT	500Ω, vertical type	09-02501-02	VRES17
RV104	SEMI POT	100K, vertical type	09-02104-01	VRES17
FUSE				
F101	Fuse	T6.3AL/250V	20-12632-00	5X20
F102	Fuse	T6.3AL/250V	20-12632-00	5X20
JUMPER				
W101	Jumper	5mm	21-06500-00	5mm
BUS101	Bus-Bar		69-010001-0	
CONNECTOR				
G1G1	Ground Solder Tap	GND-8	32-28042-00	
P101A	Connector	9PIN	13-13909-00	
P102A	Connector	9PIN	13-13909-00	
P103A	Connector	6PIN2.54 90deg	13-12506-02	
J101	Single RCA Assemblage	White	17-01001-12	RCA_1A
R111	Test Pin	1PIN	13-10001-00	
J103	Hs New Binding Post, Red		17-03001-03	
J104	Hs New Binding Post, White		17-03001-04	
P/N 01-52502-00 PCB2 BOARD (POWER SUPPLY)				
DIODE				
D201	Switch Diode	1N4148	33-44148-02	DAX/.300X.080/.031
D202	Switch Diode	1N4148	33-44148-02	DAX/.300X.080/.031
D203	Switch Diode	1N4148	33-44148-02	DAX/.300X.080/.031
D204	Switch Diode	1N4148	33-44148-02	DAX/.300X.080/.031
D205	Switch Diode	1N4148	33-44148-02	DAX/.300X.080/.031
D206	Rectify Diode	1N4007	33-24007-02	

ELECTRICAL PARTS LIST

DESIGNATOR	DESCRIPTION	PART TYPE	PART NUMBER	FOOTPRINT
D207	Switch Diode	1N4148	33-44148-02	DAX/.300X.080/.031
D208	Switch Diode	1N4148	33-44148-02	DAX/.300X.080/.031
D209	Switch Diode	1N4148	33-44148-02	DAX/.300X.080/.031
D210	Zener Diode	8.2V, 1/2W	33-18209-01	DAX/.300X.080/.031
D211	Zener Diode	8.2V, 1/2W	33-18209-01	DAX/.300X.080/.031
D212	Zener Diode	5.1V, 1/2W	33-15109-05	DAX/.300X.080/.031
D213	Zener Diode	4.3V, 1/2W	33-14309-01	DAX/.300X.080/.031
D214	Zener Diode	4.3V, 1/2W	33-14309-01	DAX/.300X.080/.031
D215	Zener Diode	4.3V, 1/2W	33-14309-01	DAX/.300X.080/.031
D216	Zener Diode	4.3V, 1/2W	33-14309-01	DAX/.300X.080/.031
D217	Zener Diode	4.3V, 1/2W	33-14309-01	DAX/.300X.080/.031
D218	Zener Diode	4.3V, 1/2W	33-14309-01	DAX/.300X.080/.031
D219	Zener Diode	4.3V, 1/2W	33-14309-01	DAX/.300X.080/.031
D220	Zener Diode	6.8V, 1/2W	33-16809-02	DAX/.300X.080/.031
D221	Zener Diode	6.8V, 1/2W	33-16809-02	DAX/.300X.080/.031
D222	Zener Diode	6.8V, 1/2W	33-16809-02	DAX/.300X.080/.031
D223	Switch Diode	1N4148	33-44148-02	DAX/.300X.080/.031
D224	Switch Diode	1N4148	33-44148-02	DAX/.300X.080/.031
D225	Switch Diode	1N4148	33-44148-02	DAX/.300X.080/.031
D226	Switch Diode	1N4148	33-44148-02	DAX/.300X.080/.031
D227	Switch Diode	1N4148	33-44148-02	DAX/.300X.080/.031
D228	Switch Diode	1N4148	33-44148-02	DAX/.300X.080/.031
D229	Switch Diode	1N4148	33-44148-02	DAX/.300X.080/.031
D230	Switch Diode	1N4148	33-44148-02	DAX/.300X.080/.031
D231	Switch Diode	1N4148	33-44148-02	DAX/.300X.080/.031
D232	Zener Diode	13V, 1/2W	33-11300-01	DAX/.300X.080/.031
D233	Switch Diode	1N4148	33-44148-02	DAX/.300X.080/.031
D234	Switch Diode	1N4148	33-44148-02	DAX/.300X.080/.031
D235	Zener Diode	3.3V, 1/2W	33-13309-03	DAX/.300X.080/.031
D236	Zener Diode	3.3V, 1/2W	33-13309-03	DAX/.300X.080/.031
BRIDGE				
BR201	BRIDGE	DB104G	33-30142-00	BRIDGE/.400X.500/.051
BR202	BRIDGE	DB104G	33-30142-00	BRIDGE/.400X.500/.051
BR203	BRIDGE	DB104G	33-30142-00	BRIDGE/.400X.500/.051
BR204	BRIDGE	KBJ2506	33-32562-00	BRIDGE/1.180X.180/.087
BR205	BRIDGE	KBJ2506	33-32562-00	BRIDGE/1.180X.180/.087
BR206	BRIDGE	KBJ2506	33-32562-00	BRIDGE/1.180X.180/.087
BR207	BRIDGE	KBJ2506	33-32562-00	BRIDGE/1.180X.180/.087
BR208	BRIDGE	DB104G	33-30142-00	BRIDGE/.400X.500/.051
SCR				
Q236	SCR	30TPS08	33-83008-00	TO247AC
Q237	SCR	30TPS08	33-83008-00	TO247AC
Q238	SCR	30TPS08	33-83008-00	TO247AC
Q239	SCR	30TPS08	33-83008-00	TO247AC
TRANSISTOR				
Q201	Transistor	KSA1220AYSTU	31-01220-00	TO126/90/ECB
Q202	Transistor	KSC2690AYSTU	31-02690-00	TO126/90/ECB
Q203	Transistor	2SC1815-GR	31-01815-00	TO92/100/ECB
Q204	Transistor	2SA1015-GR	31-01015-00	TO92/100/ECB
Q205	Transistor	2SC4793	31-04793-00	TO220AB
Q206	Transistor	2SA1837	31-01837-00	TO220AB
Q207	Transistor	2SC1775-AETZ	31-01775-00	TO92/100/ECB
Q208	Transistor	2SC1775-AETZ	31-01775-00	TO92/100/ECB
Q209	Transistor	2SA872-AETZ	31-00872-00	TO92/100/ECB
Q210	Transistor	2SC1815-GR	31-01815-00	TO92/100/ECB
Q211	Transistor	2SA1015-GR	31-01015-00	TO92/100/ECB
Q212	Transistor	2SB647-AWC	31-00647-00	TO92/100/ECB
Q213	Transistor	2SD667-AWC	31-00667-00	TO92/100/ECB
Q214	Transistor	2SC1815-GR	31-01815-00	TO92/100/ECB
Q215	Transistor	2SA1015-GR	31-01015-00	TO92/100/ECB
Q216	Transistor	2SB647-AWC	31-00647-00	TO92/100/ECB

ELECTRICAL PARTS LIST

DESIGNATOR	DESCRIPTION	PART TYPE	PART NUMBER	FOOTPRINT
Q217	Transistor	2SD667-AWC	31-00667-00	TO92/100/ECB
Q218	Transistor	KSC2690AYSTU	31-02690-00	TO126/90/ECB
Q219	Transistor	KSC2690AYSTU	31-02690-00	TO126/90/ECB
Q220	Transistor	KSC2690AYSTU	31-02690-00	TO126/90/ECB
Q221	Transistor	2SC1815-GR	31-01815-00	TO92/100/ECB
Q222	Transistor	2SC1815-GR	31-01815-00	TO92/100/ECB
Q223	Transistor	2SC1815-GR	31-01815-00	TO92/100/ECB
Q224	Transistor	2SC1815-GR	31-01815-00	TO92/100/ECB
Q225	Transistor	2SC1815-GR	31-01815-00	TO92/100/ECB
Q226	Transistor	2SC1815-GR	31-01815-00	TO92/100/ECB
Q227	Transistor	2SD667-AWC	31-00667-00	TO92/100/ECB
Q228	Transistor	2SC1815-GR	31-01815-00	TO92/100/ECB
Q229	Transistor	2SC1815-GR	31-01815-00	TO92/100/ECB
Q230	Transistor	2SC1815-GR	31-01815-00	TO92/100/ECB
Q231	Transistor	2SC1815-GR	31-01815-00	TO92/100/ECB
Q232	Transistor	2SC1815-GR	31-01815-00	TO92/100/ECB
Q233	Transistor	2SC1815-GR	31-01815-00	TO92/100/ECB
Q234	Transistor	2SC1775-AETZ	31-01775-00	TO92/100/ECB
Q235	Transistor	2SA872-AETZ	31-00872-00	TO92/100/ECB
Q240	Transistor	2SC1775-AETZ	31-01775-00	TO92/100/ECB
Q241	Transistor	2SA872-AETZ	31-00872-00	TO92/100/ECB
IC				
IC201	Ragulator	L7812CV	03-07812-00	TO220AB
IC202	Ragulator	L7912CV	03-07912-00	TO220AB
IC203	QUAD OP-AMP	TL084CN	03-00084-00	DIP.100/14/W.300/L.750
IC204	GATE IC	SN74HC21N	03-07421-00	DIP.100/14/W.300/L.750
IC205	RAGULATOR	L7806CV	03-07806-00	TO220AB
IC206	DUAL OP-AMP	TL082CP	03-00082-00	DIP.100/8/W.300/L.450
RESISTOR				
R201	Metal Film Resistor	1K Ω , 1/6W, 5%	07-20102-00	AX/.200X.080/.031
R202	Metal Film Resistor	1K Ω , 1/6W, 5%	07-20102-00	AX/.200X.080/.031
R203	Metal Film Resistor	2K2 Ω , 1/6W, 5%	07-20222-00	AX/.200X.080/.031
R204	Metal Film Resistor	2K2 Ω , 1/6W, 5%	07-20222-00	AX/.200X.080/.031
R205	Metal Film Resistor	100 Ω , 1/6W, 5%	07-20101-00	AX/.200X.080/.031
R206	Metal Film Resistor	100 Ω , 1/6W, 5%	07-20101-00	AX/.200X.080/.031
R207	Metal Film Resistor	1K5 Ω , 1/6W, 5%	07-20152-00	AX/.200X.080/.031
R208	Metal Film Resistor	1K5 Ω , 1/6W, 5%	07-20152-00	AX/.200X.080/.031
R209	Metal Film Resistor	10K Ω , 1/6W, 5%	07-20103-00	AX/.200X.080/.031
R210	Metal Film Resistor	2K Ω , 1/6W, 5%	07-20202-00	AX/.200X.080/.031
R211	Metal Film Resistor	470 Ω , 1/6W, 5%	07-20471-00	AX/.200X.080/.031
R212	Metal Film Resistor	470 Ω , 1/6W, 5%	07-20471-00	AX/.200X.080/.031
R213	Metal Oxide Film Resistor	10 Ω , 1/2W, 5%	07-30100-03	AX/.600X.125/.039
R214	Metal Film Resistor	1K8 Ω , 1/6W, 5%	07-20182-00	AX/.200X.080/.031
R215	Metal Film Resistor	1K8 Ω , 1/6W, 5%	07-20182-00	AX/.200X.080/.031
R216	Metal Film Resistor	1K8 Ω , 1/6W, 5%	07-20182-00	AX/.200X.080/.031
R217	Metal Film Resistor	220 Ω , 1/6W, 5%	07-20221-00	AX/.200X.080/.031
R218	Metal Film Resistor	2K2 Ω , 1/6W, 5%	07-20222-00	AX/.200X.080/.031
R219	Metal Film Resistor	220 Ω , 1/6W, 5%	07-20221-00	AX/.200X.080/.031
R220	Metal Film Resistor	10K2 Ω , 1/6W, 1%	07-21022-00	AX/.200X.080/.031
R221	Metal Film Resistor	2K1 Ω , 1/6W, 1%	07-22101-00	AX/.200X.080/.031
R222	Metal Film Resistor	1K8 Ω , 1/6W, 5%	07-20182-00	AX/.200X.080/.031
R223	Metal Film Resistor	1K8 Ω , 1/6W, 5%	07-20182-00	AX/.200X.080/.031
R224	Metal Oxide Film Resistor	10 Ω , 1/2W, 5%	07-30100-03	AX/.600X.125/.039
R225	Metal Film Resistor	1K8 Ω , 1/6W, 5%	07-20182-00	AX/.200X.080/.031
R226	Metal Film Resistor	220 Ω , 1/6W, 5%	07-20221-00	AX/.200X.080/.031
R227	Metal Film Resistor	12K Ω , 1/6W, 1%	07-21202-00	AX/.200X.080/.031
R228	Metal Film Resistor	15K Ω , 1/4W, 5%	07-20153-10	AX/.400X.080/.031
R229	Metal Film Resistor	4K7 Ω , 1/4W, 5%	07-20472-10	AX/.400X.080/.031
R230	Metal Film Resistor	1K Ω , 1/6W, 5%	07-20102-00	AX/.200X.080/.031

ELECTRICAL PARTS LIST

DESIGNATOR	DESCRIPTION	PART TYPE	PART NUMBER	FOOTPRINT
R231	Metal Film Resistor	10K Ω , 1/6W, 5%	07-20103-00	AX/.200X.080/.031
R232	Metal Film Resistor	10K Ω , 1/6W, 5%	07-20103-00	AX/.200X.080/.031
R233	Metal Oxide Film Resistor	10K Ω , 1/2W, 5%	07-30103-00	AX/.400X.100/.031
R234	Metal Oxide Film Resistor	10K Ω , 1/2W, 5%	07-30103-00	AX/.400X.100/.031
R235	Metal Film Resistor	1K Ω , 1/6W, 5%	07-20102-00	AX/.200X.080/.031
R236	Metal Film Resistor	1K Ω , 1/6W, 5%	07-20102-00	AX/.200X.080/.031
R237	Metal Film Resistor	1K Ω , 1/6W, 5%	07-20102-00	AX/.200X.080/.031
R238	Metal Oxide Film Resistor	47 Ω , 1/2W, 5%	07-30470-00	AX/.400X.080/.031
R239	Metal Film Resistor	1K Ω , 1/6W, 5%	07-20102-00	AX/.200X.080/.031
R240	Metal Oxide Film Resistor	47 Ω , 1/2W, 5%	07-30470-00	AX/.400X.080/.031
R241	Metal Film Resistor	10K Ω , 1/6W, 5%	07-20103-00	AX/.200X.080/.031
R242	Metal Oxide Film Resistor	10K Ω , 1/2W, 5%	07-30103-00	AX/.400X.100/.031
R243	Metal Oxide Film Resistor	10K Ω , 1/2W, 5%	07-30103-00	AX/.400X.100/.031
R244	Metal Film Resistor	1K Ω , 1/6W, 5%	07-20102-00	AX/.200X.080/.031
R245	Metal Film Resistor	1K Ω , 1/6W, 5%	07-20102-00	AX/.200X.080/.031
R246	Metal Film Resistor	1K Ω , 1/6W, 5%	07-20102-00	AX/.200X.080/.031
R247	Metal Oxide Film Resistor	47 Ω , 1/2W, 5%	07-30470-00	AX/.400X.080/.031
R248	Metal Film Resistor	1K Ω , 1/6W, 5%	07-20102-00	AX/.200X.080/.031
R249	Metal Oxide Film Resistor	47 Ω , 1/2W, 5%	07-30470-00	AX/.400X.080/.031
R250	Metal Film Resistor	470 Ω , 1/6W, 5%	07-20471-00	AX/.200X.080/.031
R251	Metal Film Resistor	1K Ω , 1/6W, 5%	07-20102-00	AX/.200X.080/.031
R252	Metal Film Resistor	100K Ω , 1/6W, 5%	07-20104-00	AX/.200X.080/.031
R253	Metal Film Resistor	1K Ω , 1/6W, 5%	07-20102-00	AX/.200X.080/.031
R254	Metal Film Resistor	470 Ω , 1/6W, 5%	07-20471-00	AX/.200X.080/.031
R255	Metal Film Resistor	4K7 Ω , 1/6W, 5%	07-20472-00	AX/.200X.080/.031
R256	Metal Film Resistor	1K Ω , 1/6W, 5%	07-20102-00	AX/.200X.080/.031
R257	Metal Film Resistor	10K Ω , 1/6W, 5%	07-20103-00	AX/.200X.080/.031
R258	Metal Film Resistor	10K Ω , 1/6W, 5%	07-20103-00	AX/.200X.080/.031
R259	Metal Film Resistor	100 Ω , 1/6W, 5%	07-20101-00	AX/.200X.080/.031
R260	Metal Film Resistor	2K Ω , 1/6W, 5%	07-20202-00	AX/.200X.080/.031
R261	Metal Film Resistor	10K Ω , 1/6W, 1%	07-21002-00	AX/.200X.080/.031
R262	Metal Film Resistor	10K Ω , 1/6W, 1%	07-21002-00	AX/.200X.080/.031
R263	Metal Film Resistor	10K Ω , 1/6W, 1%	07-21002-00	AX/.200X.080/.031
R264	Metal Film Resistor	10K Ω , 1/6W, 1%	07-21002-00	AX/.200X.080/.031
R265	Metal Film Resistor	10K Ω , 1/6W, 1%	07-21002-00	AX/.200X.080/.031
R266	Metal Film Resistor	10K Ω , 1/6W, 1%	07-21002-00	AX/.200X.080/.031
R267	Metal Film Resistor	10K Ω , 1/6W, 1%	07-21002-00	AX/.200X.080/.031
R268	Metal Film Resistor	10K Ω , 1/6W, 1%	07-21002-00	AX/.200X.080/.031
R269	Metal Film Resistor	10K Ω , 1/6W, 1%	07-21002-00	AX/.200X.080/.031
R270	Metal Film Resistor	43K Ω , 1/6W, 1%	07-24302-00	AX/.200X.080/.031
R271	Metal Film Resistor	43K Ω , 1/6W, 1%	07-24302-00	AX/.200X.080/.031
R272	Metal Film Resistor	43K Ω , 1/6W, 1%	07-24302-00	AX/.200X.080/.031
R273	Metal Film Resistor	100 Ω , 1/6W, 5%	07-20101-00	AX/.200X.080/.031
R274	Metal Film Resistor	100 Ω , 1/6W, 5%	07-20101-00	AX/.200X.080/.031
R275	Metal Film Resistor	100 Ω , 1/6W, 5%	07-20101-00	AX/.200X.080/.031
R276	Metal Film Resistor	3K3 Ω , 1/6W, 5%	07-20332-00	AX/.200X.080/.031
R277	Metal Film Resistor	3K3 Ω , 1/6W, 5%	07-20332-00	AX/.200X.080/.031
R278	Metal Film Resistor	3K3 Ω , 1/6W, 5%	07-20332-00	AX/.200X.080/.031
R279	Metal Film Resistor	3K3 Ω , 1/6W, 5%	07-20332-00	AX/.200X.080/.031
R280	Metal Film Resistor	10K Ω , 1/6W, 5%	07-20103-00	AX/.200X.080/.031
R281	Metal Film Resistor	10K Ω , 1/6W, 5%	07-20103-00	AX/.200X.080/.031
R282	Metal Film Resistor	10K Ω , 1/6W, 5%	07-20103-00	AX/.200X.080/.031
R283	Metal Film Resistor	10K Ω , 1/6W, 5%	07-20103-00	AX/.200X.080/.031
R284	Metal Film Resistor	10K Ω , 1/6W, 5%	07-20103-00	AX/.200X.080/.031

ELECTRICAL PARTS LIST

DESIGNATOR	DESCRIPTION	PART TYPE	PART NUMBER	FOOTPRINT
R285	Metal Film Resistor	10K Ω , 1/6W, 5%	07-20103-00	AX/.200X.080/.031
R286	Metal Film Resistor	10K Ω , 1/6W, 5%	07-20103-00	AX/.200X.080/.031
R287	Metal Film Resistor	10K Ω , 1/6W, 5%	07-20103-00	AX/.200X.080/.031
R288	Metal Film Resistor	10K Ω , 1/6W, 5%	07-20103-00	AX/.200X.080/.031
R289	Metal Film Resistor	10K Ω , 1/6W, 5%	07-20103-00	AX/.200X.080/.031
R290	Metal Film Resistor	10K Ω , 1/6W, 5%	07-20103-00	AX/.200X.080/.031
R292	Metal Film Resistor	10K Ω , 1/6W, 5%	07-20103-00	AX/.200X.080/.031
R293	Metal Film Resistor	10K Ω , 1/6W, 5%	07-20103-00	AX/.200X.080/.031
R294	Metal Film Resistor	10K Ω , 1/6W, 5%	07-20103-00	AX/.200X.080/.031
R295	Metal Film Resistor	10K Ω , 1/6W, 5%	07-20103-00	AX/.200X.080/.031
R296	Metal Film Resistor	10K Ω , 1/6W, 5%	07-20103-00	AX/.200X.080/.031
R297	Metal Film Resistor	10K Ω , 1/6W, 5%	07-20103-00	AX/.200X.080/.031
R298	Metal Film Resistor	10K Ω , 1/6W, 5%	07-20103-00	AX/.200X.080/.031
R299	Metal Film Resistor	100 Ω , 1/6W, 5%	07-20101-00	AX/.200X.080/.031
R291	Metal Film Resistor	1K Ω , 1/6W, 5%	07-20102-00	AX/.200X.080/.031
R2A1	Metal Film Resistor	10 Ω , 1/6W, 5%	07-20100-00	AX/.200X.080/.031
R2A2	Metal Film Resistor	10 Ω , 1/6W, 5%	07-20100-00	AX/.200X.080/.031
R2A3	Metal Film Resistor	10 Ω , 1/6W, 5%	07-20100-00	AX/.200X.080/.031
R2A4	Metal Film Resistor	10K Ω , 1/6W, 1%	07-21002-00	AX/.200X.080/.031
R2A5	Metal Film Resistor	10K Ω , 1/6W, 1%	07-21002-00	AX/.200X.080/.031
R2A6	Metal Film Resistor	10K Ω , 1/6W, 1%	07-21002-00	AX/.200X.080/.031
R2A7	Metal Film Resistor	10K Ω , 1/6W, 1%	07-21002-00	AX/.200X.080/.031
R2A8	Metal Film Resistor	10K Ω , 1/6W, 1%	07-21002-00	AX/.200X.080/.031
R2A9	Metal Film Resistor	10K Ω , 1/6W, 1%	07-21002-00	AX/.200X.080/.031
R2E1	Metal Film Resistor	1K Ω , 1/6W, 5%	07-20102-00	AX/.200X.080/.031
R2E2	Metal Film Resistor	10K Ω , 1/6W, 5%	07-20103-00	AX/.200X.080/.031
R2E3	Metal Film Resistor	180 Ω , 1/6W, 5%	07-20181-00	AX/.200X.080/.031
R2E4	Metal Film Resistor	1K Ω , 1/6W, 5%	07-20102-00	AX/.200X.080/.031
R2E5	Metal Film Resistor	100K Ω , 1/6W, 5%	07-20104-00	AX/.200X.080/.031
R2E6	Metal Film Resistor	1K Ω , 1/6W, 5%	07-20102-00	AX/.200X.080/.031
R2E7	Metal Film Resistor	1K Ω , 1/6W, 5%	07-20102-00	AX/.200X.080/.031
R2E8	Metal Film Resistor	10K Ω , 1/6W, 5%	07-20103-00	AX/.200X.080/.031
R2E9	Metal Film Resistor	20K Ω , 1/6W, 5%	07-20203-00	AX/.200X.080/.031
R2F1	Metal Film Resistor	10K Ω , 1/6W, 5%	07-20103-00	AX/.200X.080/.031
R2F2	Metal Film Resistor	20K Ω , 1/6W, 5%	07-20203-00	AX/.200X.080/.031
R2F3	Metal Film Resistor	10K Ω , 1/6W, 5%	07-20103-00	AX/.200X.080/.031
R2F4	Metal Film Resistor	10K Ω , 1/6W, 5%	07-20103-00	AX/.200X.080/.031
R2F5	JUMPER	5mm	21-06500-00	AX/.200X.080/.031
R2H1	Cement Resistor	8.2 Ω , 5W, 5%	07-40829-05	AX/.600X.175/.039
R2H2	Metal Film Resistor	10K Ω , 1/6W, 5%	07-20103-00	AX/.200X.080/.031
R2H3	Metal Film Resistor	10K Ω , 1/6W, 5%	07-20103-00	AX/.200X.080/.031
R2H4	Metal Film Resistor	10K Ω , 1/6W, 5%	07-20103-00	AX/.200X.080/.031
CAPACITOR				
C201	Polyester capacitor	10nF, 10%, 100V	25-10312-01	RAD/.300X.150/LS.200/.035
C202	ALU Electrolytic Capacitor	3300uF/35V, 20%, 105 $^{\circ}$ C	06-33231-00	CPCYL1/D.900/LS.350/.062
C203	ALU Electrolytic Capacitor	3300uF/35V, 20%, 105 $^{\circ}$ C	06-33231-00	CPCYL1/D.900/LS.350/.062
C204	Polyester capacitor	10nF, 10%, 100V	25-10312-01	RAD/.300X.150/LS.200/.035
C205	Polyester capacitor	10nF, 10%, 100V	25-10312-01	RAD/.300X.150/LS.200/.035
C206	Polyester capacitor	100nF, 10%, 100V	25-10412-02	RAD/.300X.150/LS.200/.037
C207	Polyester capacitor	100nF, 10%, 100V	25-10412-02	RAD/.300X.150/LS.200/.037
C208	ALU Electrolytic Capacitor	10uF/50V, 20%, 105 $^{\circ}$ C	06-10051-01	CPCYL1/D.200/LS.200/.031
C209	ALU Electrolytic Capacitor	10uF/50V, 20%, 105 $^{\circ}$ C	06-10051-01	CPCYL1/D.200/LS.200/.031
C210	Polyester capacitor	10nF, 10%, 100V	25-10312-01	RAD/.300X.150/LS.200/.035
C211	Polyester capacitor	10nF, 10%, 100V	25-10312-01	RAD/.300X.150/LS.200/.035
C212	Polyester capacitor	10nF, 10%, 100V	25-10312-01	RAD/.300X.150/LS.200/.035
C213	ALU Electrolytic Capacitor	3300uF/35V, 20%, 105 $^{\circ}$ C	06-33231-00	CPCYL1/D.900/LS.350/.062

ELECTRICAL PARTS LIST

DESIGNATOR	DESCRIPTION	PART TYPE	PART NUMBER	FOOTPRINT
C214	ALU Electrolytic Capacitor	3300uF/35V, 20%, 105°C	06-33231-00	CPCYL1/D.900/LS.350/062
C215	ALU Electrolytic Capacitor	100uF/35V, 20%, 105°C	06-10131-05	CPCYL1/D.300/LS.200/031
C216	ALU Electrolytic Capacitor	100uF/35V, 20%, 105°C	06-10131-05	CPCYL1/D.300/LS.200/031
C217	ALU Electrolytic Capacitor	47uF/25V, 20%, 105°C	06-47021-01	CPCYL1/D.300/LS.200/031
C218	ALU Electrolytic Capacitor	47uF/25V, 20%, 105°C	06-47021-01	CPCYL1/D.300/LS.200/031
C219	Polyester capacitor	10nF, 10%, 100V	25-10312-01	RAD/.300X.150/LS.200/035
C220	Polyester capacitor	10nF, 10%, 100V	25-10312-01	RAD/.300X.150/LS.200/035
C221	Polyester capacitor	10nF, 10%, 250V	25-10322-01	RAD/.300X.150/LS.200/036
C222	Polyester capacitor	10nF, 10%, 250V	25-10322-01	RAD/.300X.150/LS.200/036
C223	Polyester capacitor	10nF, 10%, 250V	25-10322-01	RAD/.300X.150/LS.200/036
C224	ALU Electrolytic Capacitor	1000uF/80V, 20%, 105°C	06-10281-01	CPCYL1/D.900/LS.350/062
C225	ALU Electrolytic Capacitor	1000uF/80V, 20%, 105°C	06-10281-01	CPCYL1/D.900/LS.350/062
C226	ALU Electrolytic Capacitor	10uF/50V, 20%, 105°C	06-10051-01	CPCYL1/D.200/LS.200/031
C227	ALU Electrolytic Capacitor	47uF/100V, 20%, 105°C	06-47012-01	CPCYL1/D.400/LS.200/031
C228	ALU Electrolytic Capacitor	100uF/35V, 20%, 105°C	06-10131-05	CPCYL1/D.300/LS.200/031
C229	Polyester capacitor	100nF, 10%, 100V	25-10412-02	RAD/.300X.150/LS.200/037
C230	Ceramic Capacitor	47pF, 10%, 1KV	05-47013-00	CPAX/.200X.100/031
C231	ALU Electrolytic Capacitor	10uF/100V, 20%, 105°C	06-10012-01	CPCYL1/D.300/LS.200/031
C232	ALU Electrolytic Capacitor	47uF/100V, 20%, 105°C	06-47012-01	CPCYL1/D.400/LS.200/031
C233	ALU Electrolytic Capacitor	100uF/35V, 20%, 105°C	06-10131-05	CPCYL1/D.300/LS.200/031
C234	Ceramic Capacitor	47pF, 10%, 1KV	05-47013-00	CPAX/.200X.100/031
C235	ALU Electrolytic Capacitor	10uF/100V, 20%, 105°C	06-10012-01	CPCYL1/D.300/LS.200/031
C236	Polyester capacitor	100nF, 10%, 100V	25-10412-02	RAD/.300X.150/LS.200/037
C237	Polyester capacitor	100nF, 10%, 100V	25-10412-02	RAD/.300X.150/LS.200/037
C238	ALU Electrolytic Capacitor	10uF/100V, 20%, 105°C	06-10012-01	CPCYL1/D.300/LS.200/031
C239	ALU Electrolytic Capacitor	10uF/100V, 20%, 105°C	06-10012-01	CPCYL1/D.300/LS.200/031
C240	ALU Electrolytic Capacitor	10uF/100V, 20%, 105°C	06-10012-01	CPCYL1/D.300/LS.200/031
C241	Polyester capacitor	10nF, 10%, 250V	25-10322-01	RAD/.300X.150/LS.200/036
C242	Polyester capacitor	10nF, 10%, 250V	25-10322-01	RAD/.300X.150/LS.200/036
C243	Polyester capacitor	2.2nF, 10%, 250V	25-22222-00	RAD/.300X.150/LS.200/034
C244	Polyester capacitor	2.2nF, 10%, 250V	25-22222-00	RAD/.300X.150/LS.200/034
C245	Polyester capacitor	2.2nF, 10%, 250V	25-22222-00	RAD/.300X.150/LS.200/034
C246	Polyester capacitor	2.2nF, 10%, 250V	25-22222-00	RAD/.300X.150/LS.200/034
C247	ALU Electrolytic Capacitor	22000uF/80V, 105°C	06-22381-00	CPCYL1/D1.420/LS.880/079
C248	ALU Electrolytic Capacitor	22000uF/80V, 105°C	06-22381-00	CPCYL1/D1.420/LS.880/079
C249	Polyester capacitor	2.2nF, 10%, 250V	25-22222-00	RAD/.300X.150/LS.200/034
C250	Polyester capacitor	2.2nF, 10%, 250V	25-22222-00	RAD/.300X.150/LS.200/034
C251	Polyester capacitor	2.2nF, 10%, 250V	25-22222-00	RAD/.300X.150/LS.200/034
C252	Polyester capacitor	2.2nF, 10%, 250V	25-22222-00	RAD/.300X.150/LS.200/034
C253	ALU Electrolytic Capacitor	27000uF/80V, 105°C	06-27381-00	CPCYL1/D1.420/LS.880/079
C254	ALU Electrolytic Capacitor	27000uF/80V, 105°C	06-27381-00	CPCYL1/D1.420/LS.880/079

ELECTRICAL PARTS LIST

DESIGNATOR	DESCRIPTION	PART TYPE	PART NUMBER	FOOTPRINT
C255	ALU Electrolytic Capacitor	2200uF/25V, 20%, 105°C	06-22221-04	CPCYL1/D.900/LS.350/.062
C256	Polyester capacitor	10nF, 10%, 100V	25-10312-01	RAD/.300X.150/LS.200/.035
C257	Polyester capacitor	100nF, 10%, 100V	25-10412-02	RAD/.300X.150/LS.200/.037
C258	Polyester capacitor	10nF, 10%, 100V	25-10312-01	RAD/.300X.150/LS.200/.035
C259	ALU Electrolytic Capacitor	1uF/50V, 20%, 105°C	06-10951-10	CPCYL1/D.200/LS.200/.031
C260	ALU Electrolytic Capacitor	1uF/50V, 20%, 105°C	06-10951-10	CPCYL1/D.200/LS.200/.031
C261	ALU Electrolytic Capacitor	1uF/50V, 20%, 105°C	06-10951-10	CPCYL1/D.200/LS.200/.031
C262	Ceramic Capacitor	220pF, 10%, 1KV	05-22113-01	CPAX/.200X.100/.031
C263	Polyester capacitor	100nF, 10%, 100V	25-10412-02	RAD/.300X.150/LS.200/.037
C264	ALU Electrolytic Capacitor	100uF/16V, 20%, 105°C	06-10111-07	CPCYL1/D.200/LS.200/.031
C265	Polyester capacitor	100nF, 10%, 100V	25-10412-02	RAD/.300X.150/LS.200/.037
C266	Polyester capacitor	100nF, 10%, 100V	25-10412-02	RAD/.300X.150/LS.200/.037
C267	ALU Electrolytic Capacitor	10uF/50V, 20%, 105°C	06-10051-01	CPCYL1/D.200/LS.200/.031
C268	ALU Electrolytic Capacitor	10uF/50V, 20%, 105°C	06-10051-01	CPCYL1/D.200/LS.200/.031
C269	ALU Electrolytic Capacitor	10uF/50V, 20%, 105°C	06-10051-01	CPCYL1/D.200/LS.200/.031
C270	ALU Electrolytic Capacitor	10uF/50V, 20%, 105°C	06-10051-01	CPCYL1/D.200/LS.200/.031
C271	Polyester capacitor	100nF, 10%, 100V	25-10412-02	RAD/.300X.150/LS.200/.037
C272	Polyester capacitor	100nF, 10%, 100V	25-10412-02	RAD/.300X.150/LS.200/.037
C273	Polyester capacitor	100nF, 10%, 100V	25-10412-02	RAD/.300X.150/LS.200/.037
C274	Polyester capacitor	100nF, 10%, 100V	25-10412-02	RAD/.300X.150/LS.200/.037
C275	Polyester capacitor	100nF, 10%, 100V	25-10412-02	RAD/.300X.150/LS.200/.037
C276	ALU Electrolytic Capacitor	10uF/50V, 20%, 105°C	06-10051-01	CPCYL1/D.200/LS.200/.031
C277	ALU Electrolytic Capacitor	10uF/50V, 20%, 105°C	06-10051-01	CPCYL1/D.200/LS.200/.031
POT				
RV201	SEMI POT	1K, vertical type	09-02102-02	VRES17
CONNECTOR				
J201	Connector	2P2.54	13-12502-00	
J202	Connector	2P2.54	13-12502-00	
J203	Connector	2P2.54	13-12502-00	
P201A	Housing	8PIN	13-13908-00	BLKCON.100/VH/TM1SQ/W.200/
P202A	Housing	8PIN	13-13908-00	BLKCON.100/VH/TM1SQ/W.200/
P203A	Connector	10P2.0-A35B	14-97310-00	PHB-2.0A-10Y
P204B	Housing	MOLEX 52807 RIGHT ANGLE/NON-ZIF/TOP CONTACT STYLE/16PIN (FPC1.0-16P)	13-21016-02	BLKCON.100/VH/TM2SQB/W.300 /116
P205B	Housing	MOLEX 52807 RIGHT ANGLE/NON-ZIF/TOP CONTACT STYLE/16PIN (FPC1.0-16P)	13-21016-02	BLKCON.100/VH/TM2SQB/W.300 /116
P206B	Housing	FPC-1.0-16P/1.0-11-16P	13-21016-04	BLKCON.100/VH/TM1SQ/W.200/ 16
P207A	Connector Ribbon	6P2.0-A100B 1569-26AWG	14-52506-00	
P208B	Housing	5PIN7.5-C	13-27505-00	BLKCON.200/VH/TM1SQ/W.300/ 5
P209B	Housing	5PIN3.96-C	13-23905-00	BLKCON.156/VH/TM1SQB/W.355 /5
G2G1	Ground Solder Tap	GND-8	32-28042-00	
FUSE				
F201	Fuse	T1.6AL/250V	20-12162-01	T1.6AL/250V
F202	Fuse	T1.6AL/250V	20-12162-01	T1.6AL/250V

ELECTRICAL PARTS LIST

DESIGNATOR	DESCRIPTION	PART TYPE	PART NUMBER	FOOTPRINT
F203	Fuse	T1.6AL/250V	20-12162-01	T1.6AL/250V
F204	Fuse	T1.6AL/250V	20-12162-01	T1.6AL/250V
JUMPER				
W201	Jumper	10mm	21-06101-00	10mm
W202	Jumper	10mm	21-06101-00	10mm
W203	Jumper	20mm	21-10201-00	20mm
BUS201	BUSBAR		69-046003-0	
BUS202	BUSBAR		69-046002-0	
BUS203	BUSBAR		69-010004-0	
BUS204	BUSBAR		69-010006-0	
BUS205	BUSBAR		69-010008-0	
BUS206	BUSBAR		69-006001-0	
P/N 01-52503-00 PCB3 BOARD (PROTECT&SOFTCLIPPING LED)				
DIODE				
D301	LED	φ5, blue and red, Class A	33-50565-00	DYL/D.200/LS.100/.039
D302	LED	φ5, blue and red, Class A	33-50565-00	DYL/D.200/LS.100/.039
D303	LED	φ5, blue and red, Class A	33-50565-00	DYL/D.200/LS.100/.039
D304	LED	φ5, blue and red, Class A	33-50565-00	DYL/D.200/LS.100/.039
D305	LED	φ5, blue and red, Class A	33-50565-00	DYL/D.200/LS.100/.039
D306	LED	φ5, blue and red, Class A	33-50565-00	DYL/D.200/LS.100/.039
D307	LED	φ5, blue and red, Class A	33-50565-00	DYL/D.200/LS.100/.039
D309	LED	φ5, blue and red, Class A	33-50565-00	DYL/D.200/LS.100/.039
D308	LED	φ5, blue and orange	33-50565-01	DYL/D.200/LS.100/.039
D310	Switch Diode	1N4148	33-44148-02	DAX/.300X.080/.031
D312	Zener Diode	11V, 1/2W	33-11100-02	DAX/.300X.080/.031
TRANSISTOR				
Q301	Transistor	2SA1015-GR	31-01015-00	TO92/100/ECB
Q302	Transistor	2SA1015-GR	31-01015-00	TO92/100/ECB
Q303	Transistor	2SA1015-GR	31-01015-00	TO92/100/ECB
Q304	Transistor	2SA1015-GR	31-01015-00	TO92/100/ECB
Q305	Transistor	2SA1015-GR	31-01015-00	TO92/100/ECB
Q306	Transistor	2SA1015-GR	31-01015-00	TO92/100/ECB
Q307	Transistor	2SA1015-GR	31-01015-00	TO92/100/ECB
Q308	Transistor	2SC1815-GR	31-01815-00	TO92/100/ECB
Q309	Transistor	2SC1815-GR	31-01815-00	TO92/100/ECB
Q310	Transistor	2SC1815-GR	31-01815-00	TO92/100/ECB
Q311	Transistor	2SC1815-GR	31-01815-00	TO92/100/ECB
Q312	Transistor	2SC1815-GR	31-01815-00	TO92/100/ECB
Q313	Transistor	2SC1815-GR	31-01815-00	TO92/100/ECB
Q314	Transistor	2SC1815-GR	31-01815-00	TO92/100/ECB
Q315	Transistor	2SC1815-GR	31-01815-00	TO92/100/ECB
Q316	Transistor	2SC1815-GR	31-01815-00	TO92/100/ECB
Q317	Transistor	2SC1815-GR	31-01815-00	TO92/100/ECB
Q318	Transistor	2SC1815-GR	31-01815-00	TO92/100/ECB
Q319	Transistor	2SC1815-GR	31-01815-00	TO92/100/ECB
Q320	Transistor	2SC1815-GR	31-01815-00	TO92/100/ECB
Q321	Transistor	2SC1815-GR	31-01815-00	TO92/100/ECB
Q322	Transistor	2SA1015-GR	31-01015-00	TO92/100/ECB
Q323	Transistor	2SA1015-GR	31-01015-00	TO92/100/ECB
Q324	Transistor	2SA1015-GR	31-01015-00	TO92/100/ECB
Q325	Transistor	2SA1015-GR	31-01015-00	TO92/100/ECB
Q326	Transistor	2SA1015-GR	31-01015-00	TO92/100/ECB
Q327	Transistor	2SA1015-GR	31-01015-00	TO92/100/ECB

ELECTRICAL PARTS LIST

DESIGNATOR	DESCRIPTION	PART TYPE	PART NUMBER	FOOTPRINT
Q328	Transistor	2SA1015-GR	31-01015-00	TO92/100/ECB
Q329	Transistor	2SA1015-GR	31-01015-00	TO92/100/ECB
Q330	Transistor	2SC1815-GR	31-01815-00	TO92/100/ECB
Q331	Transistor	2SC1815-GR	31-01815-00	TO92/100/ECB
Q332	Transistor	2SA1015-GR	31-01015-00	TO92/100/ECB
Q333	Transistor	2SC1815-GR	31-01815-00	TO92/100/ECB
Q334	Transistor	2SD667-AWC	31-00667-00	TO92/100/ECB
RESISTOR				
R301	Metal Film Resistor	510Ω, 1/6W, 5%	07-20511-00	AX/.200X.080/.031
R302	Metal Film Resistor	510Ω, 1/6W, 5%	07-20511-00	AX/.200X.080/.031
R303	Metal Film Resistor	510Ω, 1/6W, 5%	07-20511-00	AX/.200X.080/.031
R304	Metal Film Resistor	510Ω, 1/6W, 5%	07-20511-00	AX/.200X.080/.031
R305	Metal Film Resistor	510Ω, 1/6W, 5%	07-20511-00	AX/.200X.080/.031
R306	Metal Film Resistor	510Ω, 1/6W, 5%	07-20511-00	AX/.200X.080/.031
R307	Metal Film Resistor	510Ω, 1/6W, 5%	07-20511-00	AX/.200X.080/.031
R308	Metal Film Resistor	330Ω, 1/6W, 5%	07-20331-00	AX/.200X.080/.031
R309	Metal Film Resistor	330Ω, 1/6W, 5%	07-20331-00	AX/.200X.080/.031
R310	Metal Film Resistor	330Ω, 1/6W, 5%	07-20331-00	AX/.200X.080/.031
R311	Metal Film Resistor	330Ω, 1/6W, 5%	07-20331-00	AX/.200X.080/.031
R312	Metal Film Resistor	330Ω, 1/6W, 5%	07-20331-00	AX/.200X.080/.031
R313	Metal Film Resistor	330Ω, 1/6W, 5%	07-20331-00	AX/.200X.080/.031
R314	Metal Film Resistor	330Ω, 1/6W, 5%	07-20331-00	AX/.200X.080/.031
R315	Metal Film Resistor	10KΩ, 1/6W, 5%	07-20103-00	AX/.200X.080/.031
R316	Metal Film Resistor	10KΩ, 1/6W, 5%	07-20103-00	AX/.200X.080/.031
R317	Metal Film Resistor	10KΩ, 1/6W, 5%	07-20103-00	AX/.200X.080/.031
R318	Metal Film Resistor	10KΩ, 1/6W, 5%	07-20103-00	AX/.200X.080/.031
R319	Metal Film Resistor	10KΩ, 1/6W, 5%	07-20103-00	AX/.200X.080/.031
R320	Metal Film Resistor	10KΩ, 1/6W, 5%	07-20103-00	AX/.200X.080/.031
R321	Metal Film Resistor	10KΩ, 1/6W, 5%	07-20103-00	AX/.200X.080/.031
R322	Metal Film Resistor	10KΩ, 1/6W, 5%	07-20103-00	AX/.200X.080/.031
R323	Metal Film Resistor	10KΩ, 1/6W, 5%	07-20103-00	AX/.200X.080/.031
R324	Metal Film Resistor	10KΩ, 1/6W, 5%	07-20103-00	AX/.200X.080/.031
R325	Metal Film Resistor	10KΩ, 1/6W, 5%	07-20103-00	AX/.200X.080/.031
R326	Metal Film Resistor	10KΩ, 1/6W, 5%	07-20103-00	AX/.200X.080/.031
R327	Metal Film Resistor	10KΩ, 1/6W, 5%	07-20103-00	AX/.200X.080/.031
R328	Metal Film Resistor	10KΩ, 1/6W, 5%	07-20103-00	AX/.200X.080/.031
R329	Metal Film Resistor	10KΩ, 1/6W, 5%	07-20103-00	AX/.200X.080/.031
R330	Metal Film Resistor	10KΩ, 1/6W, 5%	07-20103-00	AX/.200X.080/.031
R331	Metal Film Resistor	10KΩ, 1/6W, 5%	07-20103-00	AX/.200X.080/.031
R332	Metal Film Resistor	10KΩ, 1/6W, 5%	07-20103-00	AX/.200X.080/.031
R333	Metal Film Resistor	10KΩ, 1/6W, 5%	07-20103-00	AX/.200X.080/.031
R334	Metal Film Resistor	10KΩ, 1/6W, 5%	07-20103-00	AX/.200X.080/.031
R335	Metal Film Resistor	10KΩ, 1/6W, 5%	07-20103-00	AX/.200X.080/.031
R336	Metal Film Resistor	10KΩ, 1/6W, 5%	07-20103-00	AX/.200X.080/.031
R337	Metal Film Resistor	10KΩ, 1/6W, 5%	07-20103-00	AX/.200X.080/.031
R338	Metal Film Resistor	10KΩ, 1/6W, 5%	07-20103-00	AX/.200X.080/.031
R339	Metal Film Resistor	10KΩ, 1/6W, 5%	07-20103-00	AX/.200X.080/.031
R340	Metal Film Resistor	10KΩ, 1/6W, 5%	07-20103-00	AX/.200X.080/.031
R341	Metal Film Resistor	10KΩ, 1/6W, 5%	07-20103-00	AX/.200X.080/.031
R342	Metal Film Resistor	10KΩ, 1/6W, 5%	07-20103-00	AX/.200X.080/.031
R343	Metal Film Resistor	56Ω, 1/6W, 5%	07-20560-00	AX/.200X.080/.031
R344	Metal Film Resistor	120Ω, 1/6W, 5%	07-20121-00	AX/.200X.080/.031
R345	Metal Film Resistor	10KΩ, 1/6W, 5%	07-20103-00	AX/.200X.080/.031
R346	Metal Film Resistor	10KΩ, 1/6W, 5%	07-20103-00	AX/.200X.080/.031
R347	Metal Film Resistor	10KΩ, 1/6W, 5%	07-20103-00	AX/.200X.080/.031
R348	Metal Film Resistor	1KΩ, 1/6W, 5%	07-20102-00	AX/.200X.080/.031
R349	Metal Film Resistor	10KΩ, 1/6W, 5%	07-20103-00	AX/.200X.080/.031
R350	Metal Film Resistor	360Ω, 1/6W, 5%	07-20361-00	AX/.200X.080/.031
CAPACITOR				
C301	ALU Electrolytic Capacitor	47uF/16V, 20%, 105°C	06-47011-00	CPCYL1/D.200/LS.200/.031

ELECTRICAL PARTS LIST

DESIGNATOR	DESCRIPTION	PART TYPE	PART NUMBER	FOOTPRINT
CONNECTORS				
P302A	Housing	1.0-11-16PS	13-21016-06	BLKCON.079/VH/TM1SQ/W.200/16
P/N 01-52504-00 PCB4 BOARD (TRIGGER)				
DIODE				
D401	Zener Diode	24V, 1/2W	33-12400-06	DAX/.300X.080/.031
D402	Zener Diode	24V, 1/2W	33-12400-06	DAX/.300X.080/.031
D403	Zener Diode	24V, 1/2W	33-12400-06	DAX/.300X.080/.031
D404	Zener Diode	24V, 1/2W	33-12400-06	DAX/.300X.080/.031
RESISTOR				
R401	Metal Film Resistor	27K Ω , 1/6W, 1%	07-22702-00	AX/.200X.080/.031
R402	Metal Film Resistor	27K Ω , 1/6W, 1%	07-22702-00	AX/.200X.080/.031
R403	Metal Film Resistor	27K Ω , 1/6W, 1%	07-22702-00	AX/.200X.080/.031
R404	Metal Film Resistor	27K Ω , 1/6W, 1%	07-22702-00	AX/.200X.080/.031
R405	Metal Film Resistor	1K Ω , 1/6W, 1%	07-21001-00	AX/.200X.080/.031
R406	Metal Film Resistor	1K Ω , 1/6W, 1%	07-21001-00	AX/.200X.080/.031
R407	Metal Film Resistor	1K Ω , 1/6W, 1%	07-21001-00	AX/.200X.080/.031
R408	Metal Film Resistor	1K Ω , 1/6W, 1%	07-21001-00	AX/.200X.080/.031
R409	Metal Film Resistor	1K Ω , 1/6W, 1%	07-21001-00	AX/.200X.080/.031
R410	Metal Film Resistor	1K Ω , 1/6W, 1%	07-21001-00	AX/.200X.080/.031
R411	Metal Film Resistor	1K Ω , 1/6W, 1%	07-21001-00	AX/.200X.080/.031
R412	Metal Film Resistor	1K Ω , 1/6W, 1%	07-21001-00	AX/.200X.080/.031
R413	Metal Film Resistor	1K Ω , 1/6W, 1%	07-21001-00	AX/.200X.080/.031
CAPACITOR				
C401	ALU Electrolytic Capacitor	10uF/50V, 20%, 105 $^{\circ}$ C	06-10051-01	CPCYL1/D.200/LS.200/.031
C402	ALU Electrolytic Capacitor	10uF/50V, 20%, 105 $^{\circ}$ C	06-10051-01	CPCYL1/D.200/LS.200/.031
C403	ALU Electrolytic Capacitor	10uF/50V, 20%, 105 $^{\circ}$ C	06-10051-01	CPCYL1/D.200/LS.200/.031
C404	ALU Electrolytic Capacitor	10uF/50V, 20%, 105 $^{\circ}$ C	06-10051-01	CPCYL1/D.200/LS.200/.031
CONNECTOR				
P401B	HOUSING	12PIN2.0-C	13-22012-00	
SWITCH				
S401	SWITCH	SSSU142NA1	11-05402-00	SLIDESWITCHES/SSSU121700
S402	SWITCH	SSSU122NA1	11-05202-10	SLIDESWITCHES/SSSU141500
J401	12V TRIG IN	PY301-030-100	17-07001-00	
AH P/N: 01-52505-10 C/BC P/N:01-52505-20 PCB5 BOARD (STANDBY)				
DIODE				
D501	Switch Diode	1N4148	33-44148-02	DAX/.300X.080/.031
CAPACITOR				
C501	High Voltage Ceramic Capacitor	220nF, 275V, \pm 10%	25-22422-04	
INRUSH LIMITER				
RV501	Inrush Current Limiter	0.5R030	07-70059-00	RAD/1.110X.180/LS.300/.047
JUMPER				
W501	Jumper	7.5mm	21-06750-00	7.5mm
W502	Jumper	10mm	21-06101-00	10mm
W505(C)	Jumper	7.5mm	21-10750-00	7.5mm
W503(AH)	Jumper	15mm	21-10151-00	15mm
W504(AH)	Jumper	15mm	21-10151-00	15mm
TRANSFORMER				
TR501	STANDBY TRANSFORMER	TD030-E102D	18-35003-00	
TR502	CURRENT TRANSFORMER	DHCT3 10A/4mA	18-52510-00	
RELAY				

ELECTRICAL PARTS LIST

DESIGNATOR	DESCRIPTION	PART TYPE	PART NUMBER	FOOTPRINT
RL501	RELAYS	832A-1A-C-BH DC5V	12-03101-02	
CONNECTOR				
P501B	Jack	PCFS250L	32-26304-10	
P502B	Jack	HS4-CI9120-B009V1-M032	32-26304-00	
P503B	Housing	2PIN2.54-C	13-22502-00	BLKCON.100/VH/TM1SQB/W.200 /2
P504B	Housing	2PIN3.96-C	13-23902-00	BLKCON.156/VH/TM1SQB/W.355 /2
P505B	Housing	4PIN7.5C	13-27504-00	BLKCON.255/VH/TM1SQB/W.200 /4
P506B	Housing	6PIN2.0-C	13-22006-00	BLKCON.100/VH/TM1SQB/W.200 /4
P/N 01-52506-00 PCB6 BOARD (CONNECTION)				
CONNECTOR				
P601B	Connector	MOLEX 52207 RIGHT ANGLE/SMT/ZIF/TOP CONTACT STYLE/16PIN	13-21016-01	
P602B	Connector	MOLEX 52207 RIGHT ANGLE/SMT/ZIF/TOP CONTACT STYLE/16PIN	13-21016-01	
P603B	Connector	S10B-PH-SM3-TB	13-22010-01	
P604B	Connector	MOLEX 2145/3215 TOP ENTRY/9PIN	13-25009-00	
P605B	Connector	MOLEX 2145/3215 TOP ENTRY/9PIN	13-25009-00	
P606B	Connector	MOLEX 2145/3215 TOP ENTRY/9PIN	13-25009-00	
P607B	Connector	MOLEX 2145/3215 TOP ENTRY/9PIN	13-25009-00	
P608B	Connector	MOLEX 2145/3215 TOP ENTRY/9PIN	13-25009-00	
P609B	Connector	MOLEX 2145/3215 TOP ENTRY/9PIN	13-25009-00	
P610B	Connector	MOLEX 2145/3215 TOP ENTRY/9PIN	13-25009-00	
P611B	Connector	MOLEX 2145/3215 TOP ENTRY/9PIN	13-25009-00	
P612B	Connector	MOLEX 2145/3215 TOP ENTRY/9PIN	13-25009-00	
P613B	Connector	MOLEX 2145/3215 TOP ENTRY/9PIN	13-25009-00	
P614B	Connector	MOLEX 2145/3215 TOP ENTRY/9PIN	13-25009-00	
P615B	Connector	MOLEX 2145/3215 TOP ENTRY/9PIN	13-25009-00	
P616B	Connector	MOLEX 2145/3215 TOP ENTRY/9PIN	13-25009-00	
P617B	Connector	MOLEX 2145/3215 TOP ENTRY/9PIN	13-25009-00	
P618A	Connector	12P2.0-A710B	14-52512-01	PHB-2.0A-12Y
P619B	Connector	MOLEX 5145-NCH TOP ENTRY/8PIN	13-25008-00	
P620B	Connector	MOLEX 5145-NCH TOP ENTRY/8PIN	13-25008-00	
P621B	Connector	2PIN2.54	13-22502-00	
P622	Connector	2PIN2.54	13-22502-00	
P623	Connector	2PIN2.54	13-22502-00	
JUMPER				
BUS601	Bus-bar		69-010002-0	
BUS602	Bus-bar		69-010002-0	
BUS603	Bus-bar		69-010002-0	
BUS604	Bus-bar		69-010002-0	

ELECTRICAL PARTS LIST

DESIGNATOR	DESCRIPTION	PART TYPE	PART NUMBER	FOOTPRINT
BUS605	Bus-bar		69-010002-0	
BUS606	Bus-bar		69-010002-0	
P/N 01-52507-00 PCB7 BOARD (POWER SWITCH)				
SWITCH				
S801	SWITCH	SDDL1027U-RN	11-01101-20	
CONNECTOR				
P801A	Connector	2P2.54-A150B	14-97302-11	XHB-2.5A-2Y
Assembly Parts				
FAN				
	FAN	EFB1212L	35-01212-00	
FUSE				
	FUSE	T20AL/250V(AH)	20-11203-10	
	FUSE	T10AL/250V (C)	20-12103-20	
FUSE HOLDER				
	FUSE HOLDER	HTB-32I	20-20000-03	
AC INLET				
	AC Inlets	R-301(00)	17-07003-01	
TRANSFORMER				
	Transformer		18-52513-00	
CONNECTOR				
	Connector	1.0mm pitch, 16PIN, 60mm, reversed contact	14-97316-00	
	Connector	.0-16P-230mm, reversed con	14-52516-10	
	Connector	One terminal:KST FDFD2-187(8), Another terminal: KST FDFD2-250, wire:16AWG, double-insulated, white,300V,105C 1672#, L=600mm	14-97301-00	
	Connector	One terminal:KST FDFD2-187(5), another terminal:KST MDFN2-250, wire:16AWG, double-insulated, blue, 300V,105C 1672#, L=600mm	14-97301-01	
	Connector	One terminal:KST FDFD2-187(5), another terminal:KST FDFD2-187(8), Wire:16AWG, Double-insulated, blue,300V,105C 1672#, L=150mm	14-97301-02	
	Connector	One terminal:KST FDFD2-187(8), another terminal: KST RNBL2-4, Wire:16AWG Yellow&Green 300V,105C , L=150mm	14-97301-03	

EXPLODED VIEW

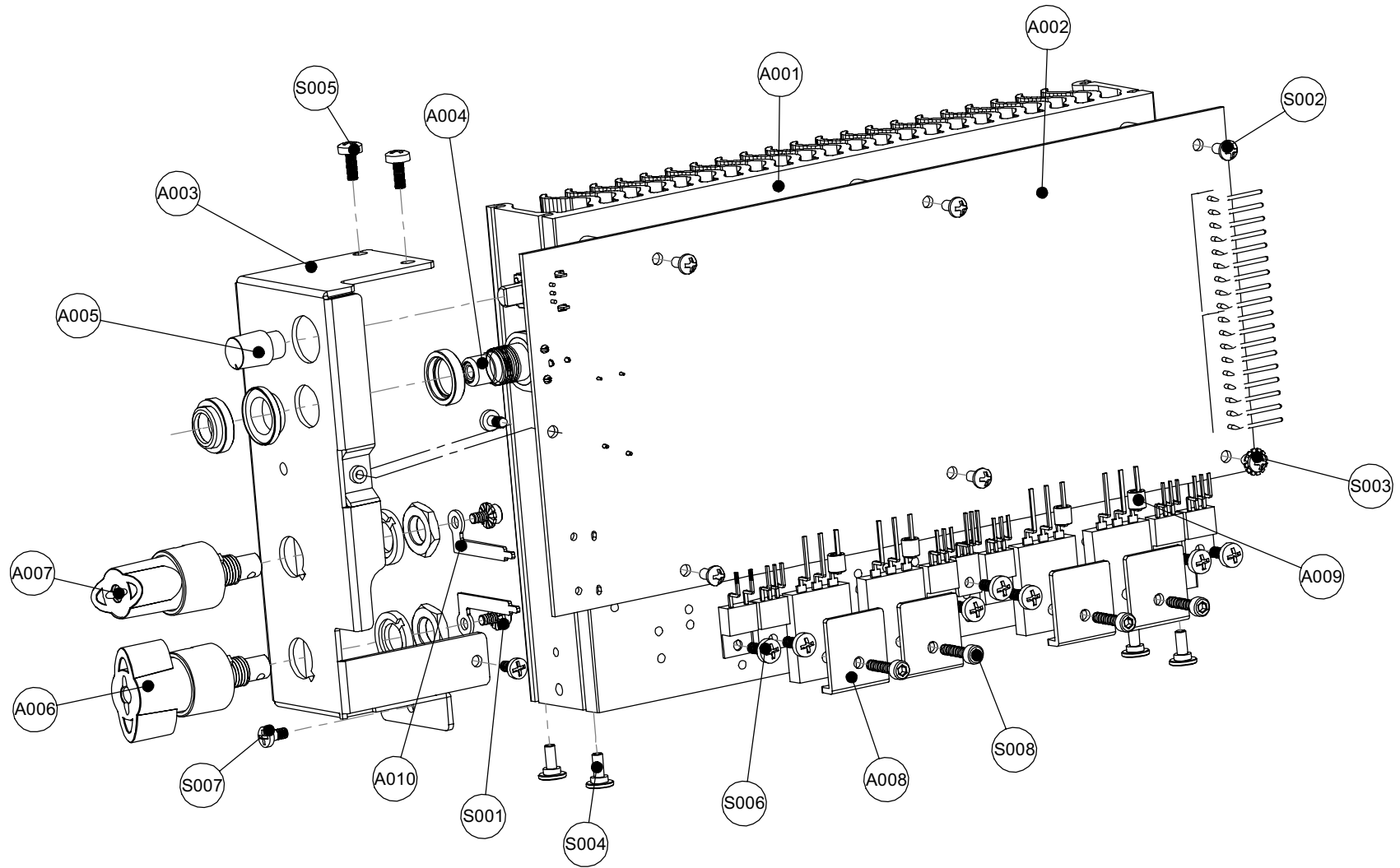

EXPLODED VIEW

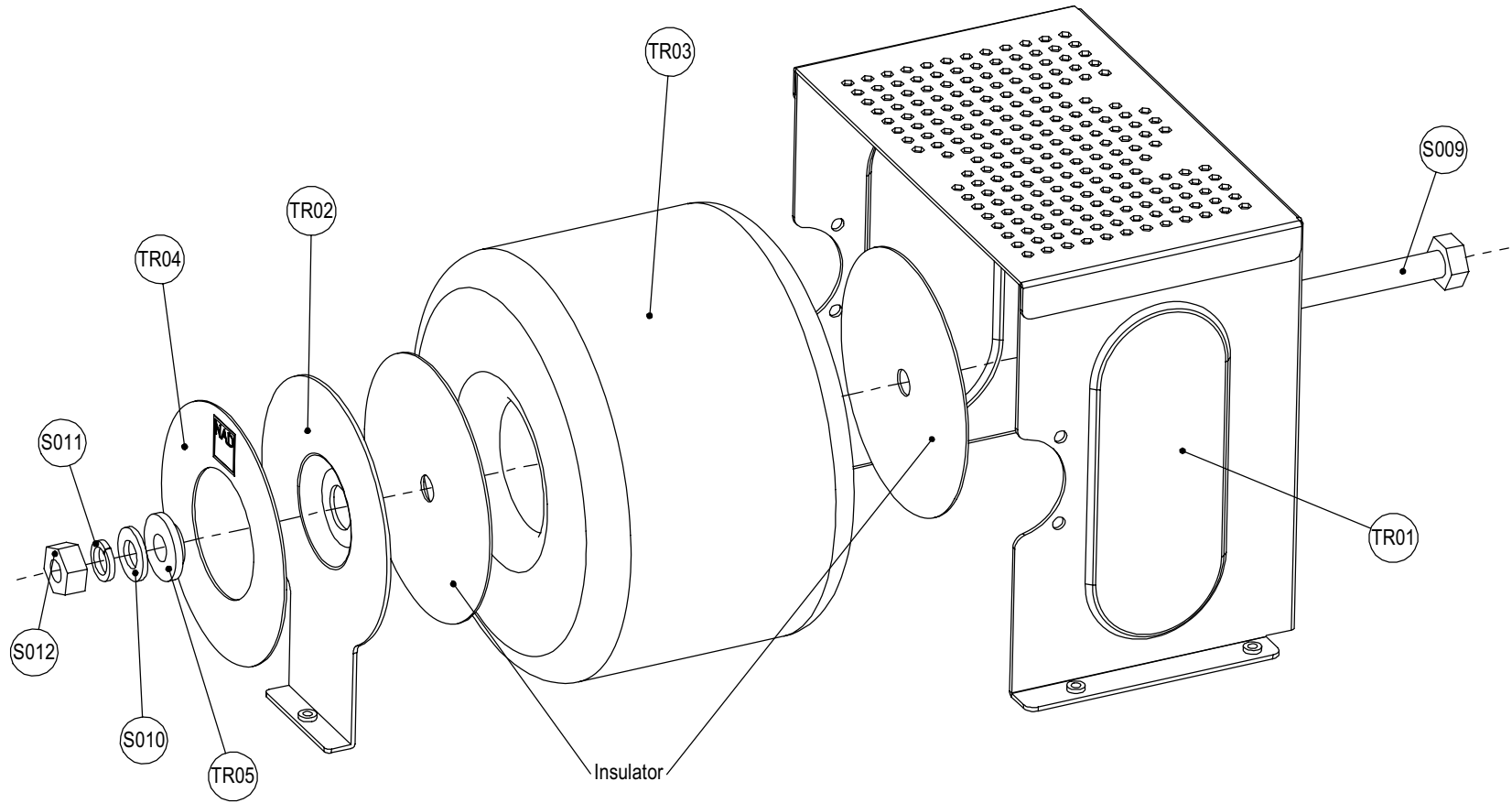



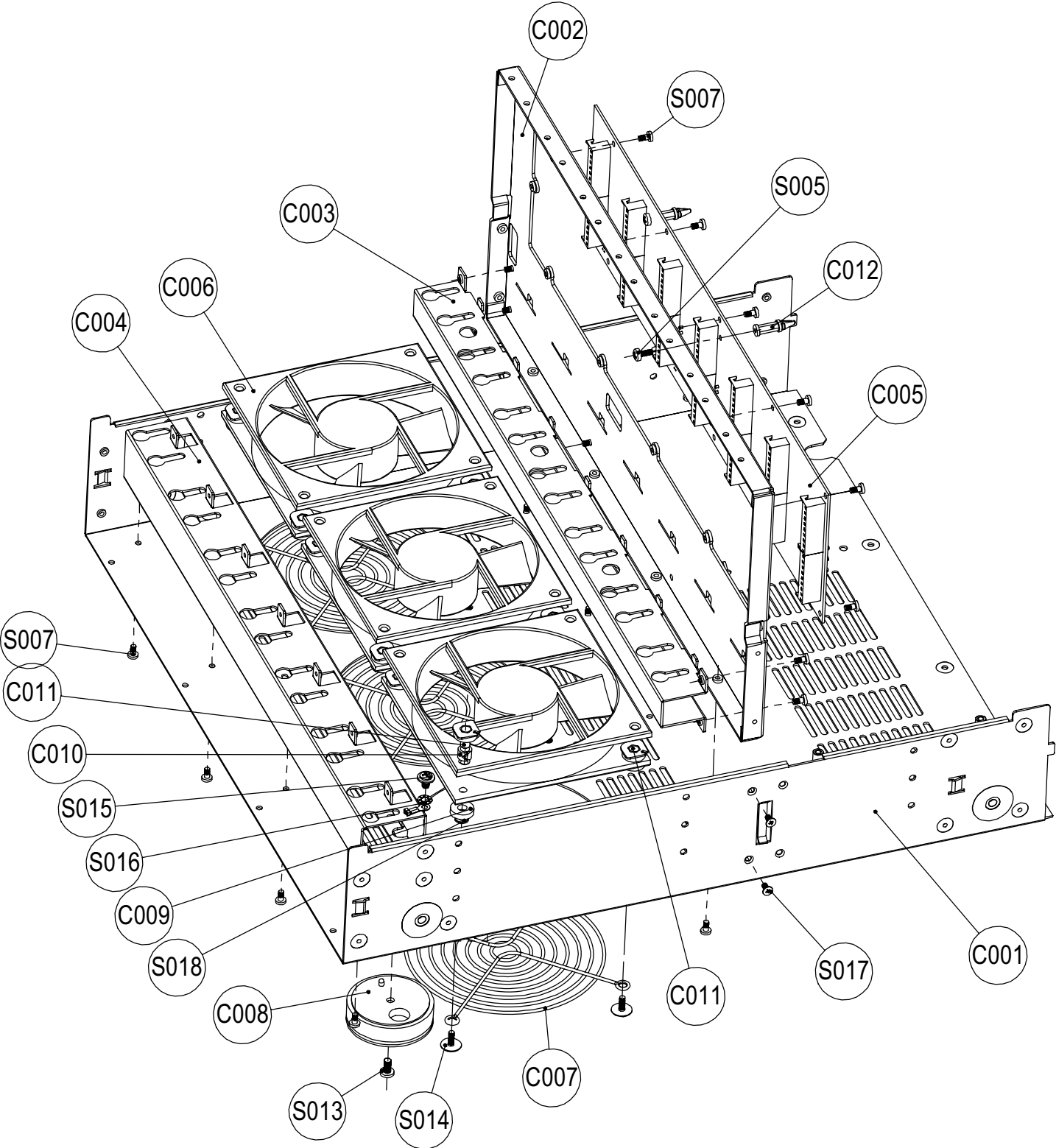

EXPLODED VIEW

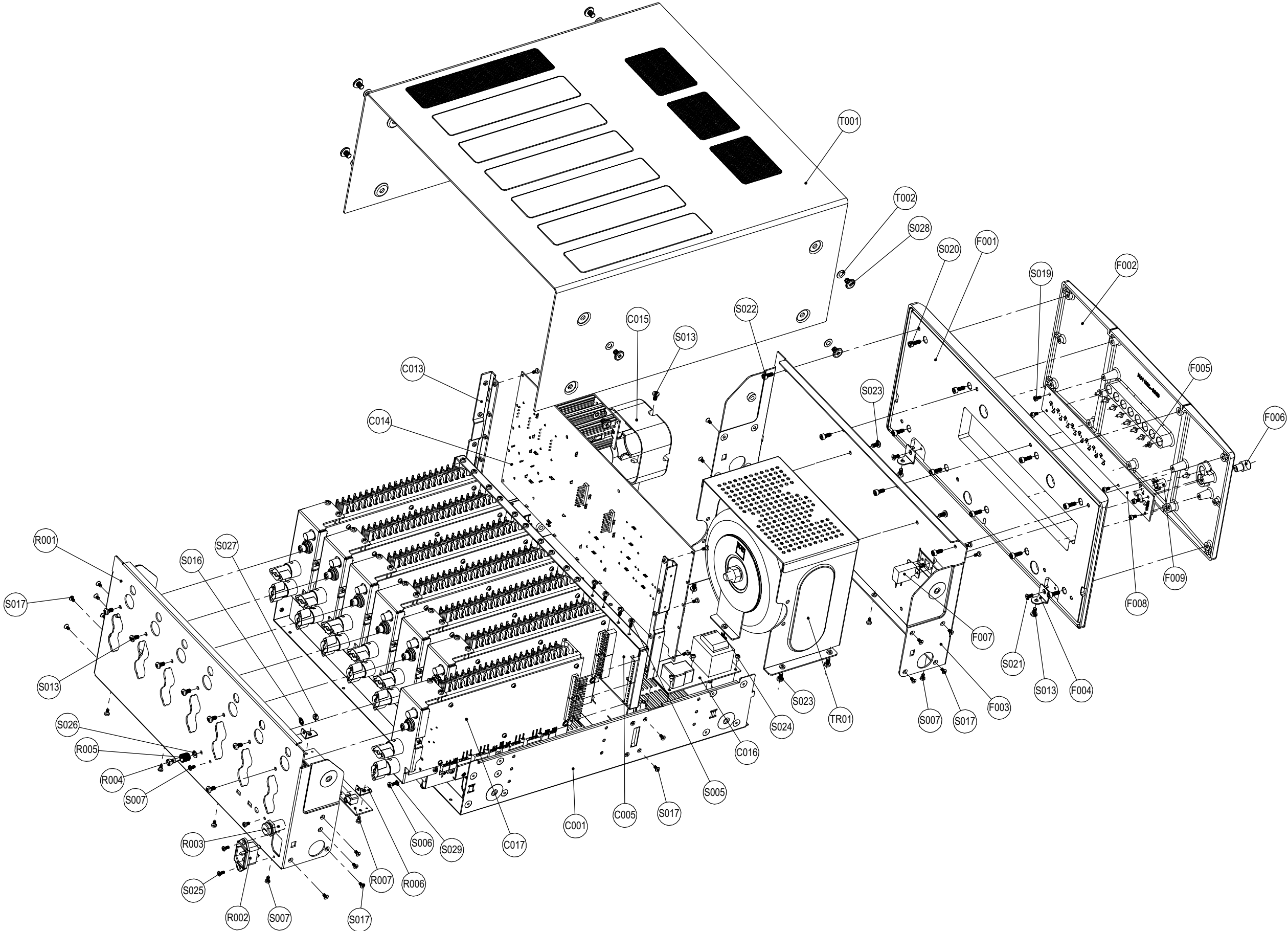

EXPLODED VIEW



EXPLODED VIEW PARTS LIST

REF.NO	PART NO.	DESCRIPTION	Qty.	REF.NO	PART NO.	DESCRIPTION	Qty.
A001	70-046001-0	Main Heatsink	7	F007 	11-01101-20	SWITCH	1
A002	01-52510-10	AMP MODULE PCB Boards(AH)	7	F008	01-52503-00	PROTECT&SOFTCLIPPING LED BOARD	
	01-52510-20	AMP MODULE PCB Boards(C)	7	F009	75-062001-0	Sleeve	2
A003	67-046011-1	Terminal Bracket	7				
A004	17-01001-12	Single RCA Assemblage	7	R001	67-046005-2	Rear Panel(C)	1
A005	73-010001-0	Rotate Knob	7		67-046015-2	Rear Panel(AH)	1
A006	17-03001-03	Hs New Binding Post, Red	7	R002 	17-07003-01	AC Inlets	1
A007	17-03001-04	Hs New Binding Post, White	7	R003 	20-20000-03	Fuse Holder	1
A008	66-005009-0	TR CLAMPER	28	R004	71-003001-0	Grd. Post Bolt	1
A009	19-05005-00	Ferrite Bead	28	R005	71-003002-0	Grd. Post Cap	1
A010	69-046001-0	Bus-Bar	14	R006	66-010010-0	Bracket6	2
				R007	01-52504-00	Trigger PCB Board	1
TR01	67-046013-1	Transformer Bracket	1				
TR02	66-010004-0	Metal Disc	1	T001	67-046006-0	Top Cover	1
TR03 	18-52513-00	Transformer(TOROID)	1	T002	76-046001-0	Screw Washer	8
TR04	94-046004-0	Transformer lable	1				
TR05	75-010003-0	Insalation Cell	1	S001	61-223506-1	Hex Machine Screw	14
				S002	61-023506-1	Machine Screw	35
C001	67-046004-1	Chassis	1	S003	61-373506-0	Machine Screw	7
C002	67-046007-0	Connector Bracket	1	S004	61-013206-0	Bolt	28
C003	67-046008-0	Front Troffer Bracket	1	S005	61-023208-0	Self Taping Screw	30
C004	67-046009-0	Rear Troffer Bracket	1	S006	61-023108-0	Self Taping Screw	59
C005	01-52506-00	Connection PCB Board	1	S007	61-023106-0	Self Taping Screw	76
C006	35-01212-00	FAN	3	S008	61-223514-0	Machine screw	28
C007	68-010003-0	Fan Cover	3	S009	64-110120-1	Bolt	1
C008	83-048010-0	Foot Assy	4	S010	63-011020-3	Washer	1
C009	79-046001-0	Shock Absorber Washer	24	S011	63-021030-0	Spring Washer	1
C010	79-046002-0	Shock Absorber Pad	12	S012	62-011002-1	Nut	1
C011	65-046001-0	Fan Pillar	12	S013	61-024108-0	Self Taping Screw	14
C012	85-001001-0	Space Support	2	S014	61-083509-6	Machine Screw	12
C013	67-046010-0	Power PCB Bracket	2	S015	61-084106-0	Self Taping Screw	1
C014	01-52502-00	Power Supply PCB Board	1	S016	63-030410-0	Serrated Lock Washer	2
C015	75-010001-0	Capacitor Holder	1	S017	61-063106-0	Self Taping Screw	25
C016	01-52505-10	Standby PCB Board(AH)	1	S018	63-010408-0	Washer	12
	01-52505-20	Standby PCB Board(C)	1	S019	61-023206-0	Self Taping Screw	5
C017	01-52510-10	AH Version AMP Module	7	S020	61-224512-1	Hex Screws	9
	01-52510-20	C Version AMP Module	7	S021	61-063108-5	Self Taping Screw	2
				S022	61-224508-1	Hex Screws	4
				S023	61-024208-0	Self Taping Screw	8
F001	70-046002-2	M25 Fascia 1	1	S024	61-084208-0	Self Taping Screw	1
F002	70-046003-0	M25 Fascia 2	1	S025	61-073208-0	Self Taping Screws	2
F003	67-046003-0	Subfascia	1	S026	63-010408-2	Washer	1
F004	67-046014-0	Panel Connect Bracket	2	S027	62-010402-1	Nut	1
F005	76-008001-0	LED Lens	9	S028	61-246508-0	M6X8 Hex Screw	8
F006	70-046004-0	Power Button	1	S029	63-030304-0	Serrated Lock Washer	8

PACKING DIAGRAM

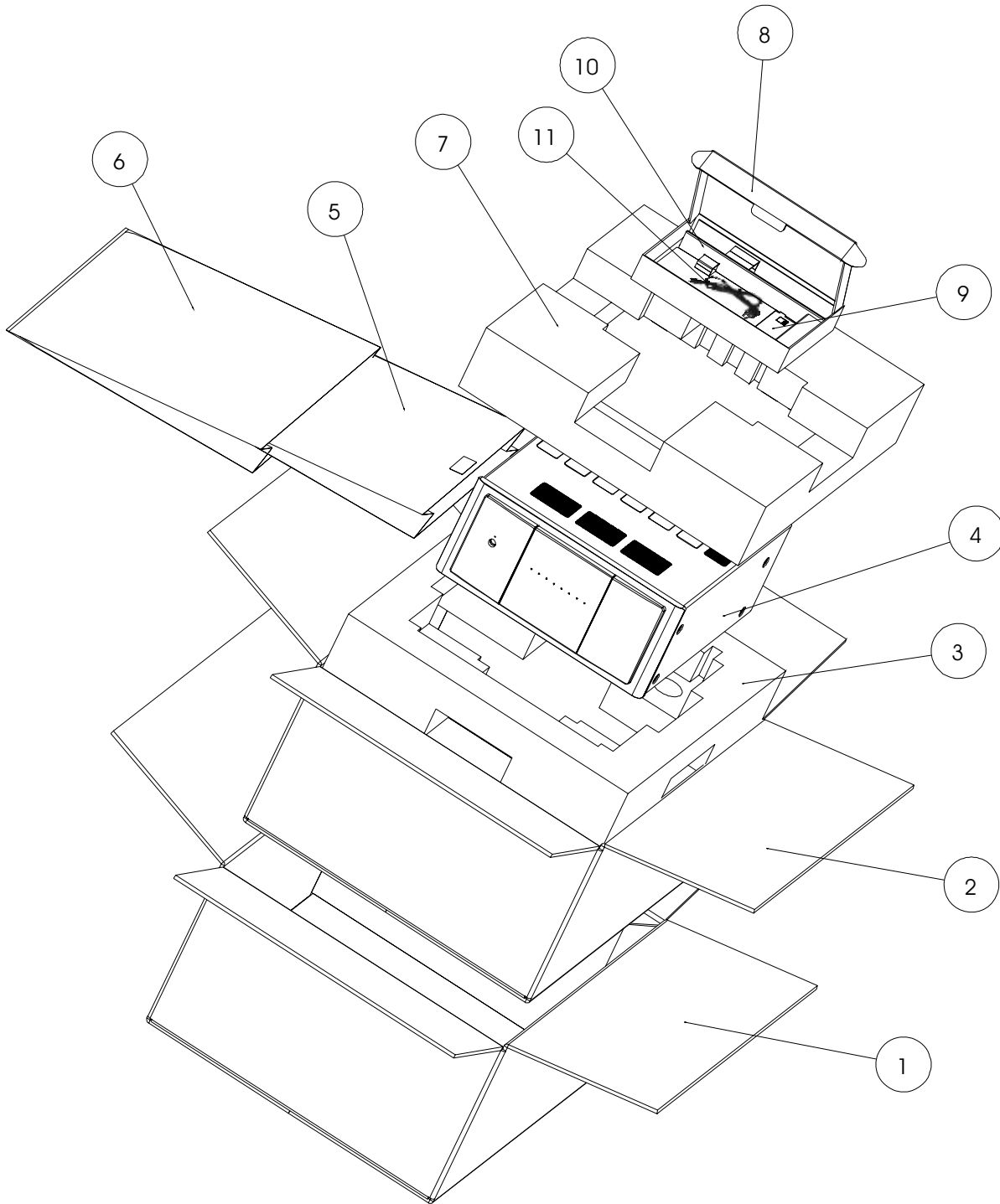

REF.NO	PART NO.	DESCRIPTION	Qty.
1	88-046002-0	Shipping Carton Box	1
2	88-046001-0	Gift Carton Box	1
3	89-046001-1	M25 Botton Polyfoam	1
4	00-52500-20	M25 Unit	1
5	87-046002-0	Non-woven Cloth bag	1
6	90-010003-0	polyfbag	1
7	89-046002-0	M25 Top Polyfoam	1
8	88-043003-0	M15Accessories Box	1
9	30-45250-00	Instruction Manual	1
10	88-043004-0	M15Box Sheet	1
11	15-10230-20	AC Cord	1