

CIRCUIT DIAGRAM

1. POWER(SMPS) CIRCUIT DIAGRAM

- NOTE :**
1. Shaded(■) parts are critical for safety. Replace only with specified part number.
 2. Voltages are DC-measured with a digital voltmeter during Play mode.

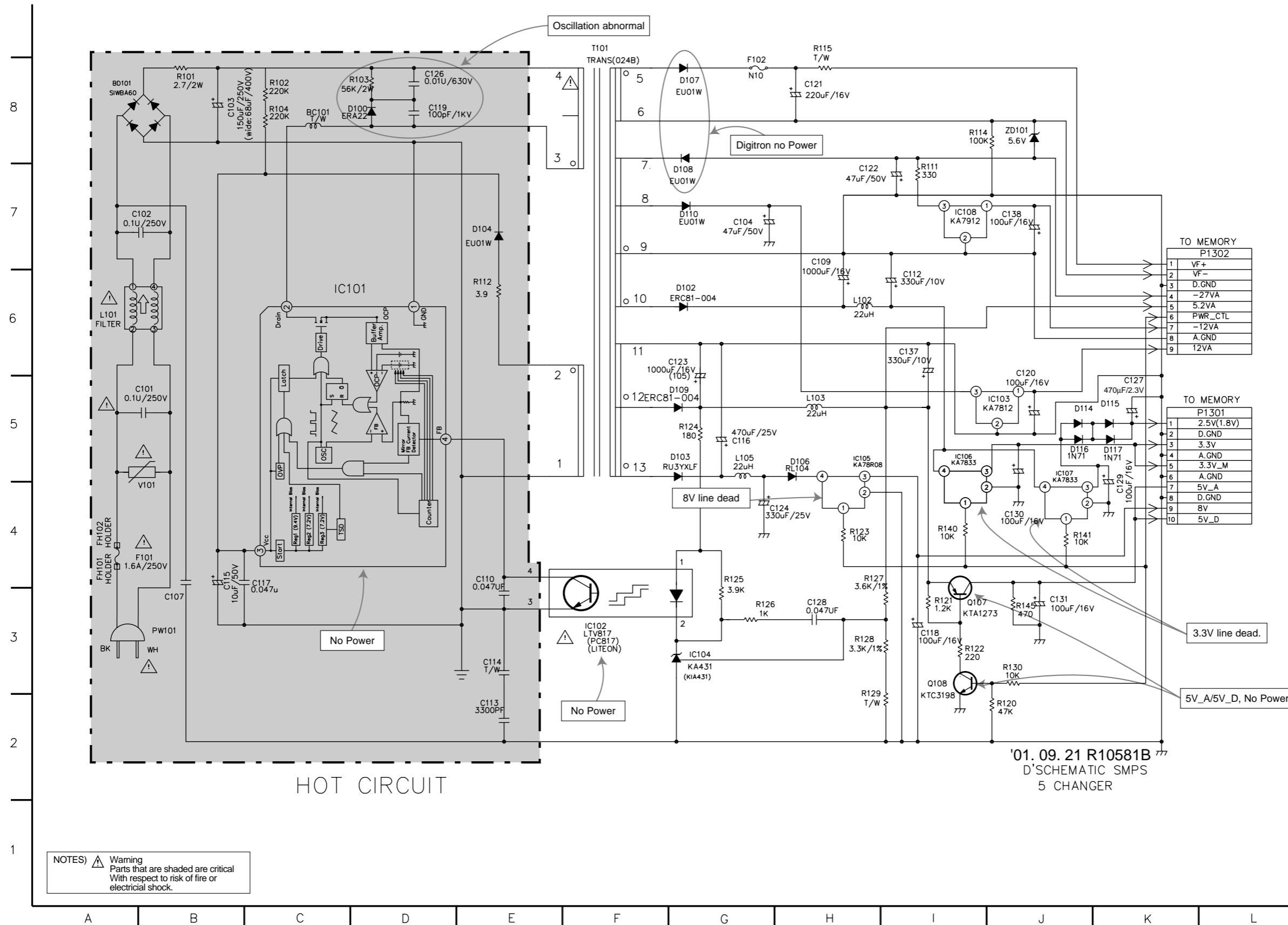

NOTES) ⚠ Warning
Parts that are shaded are critical
With respect to risk of fire or
electrical shock.

2. DVD DSP CIRCUIT DIAGRAM

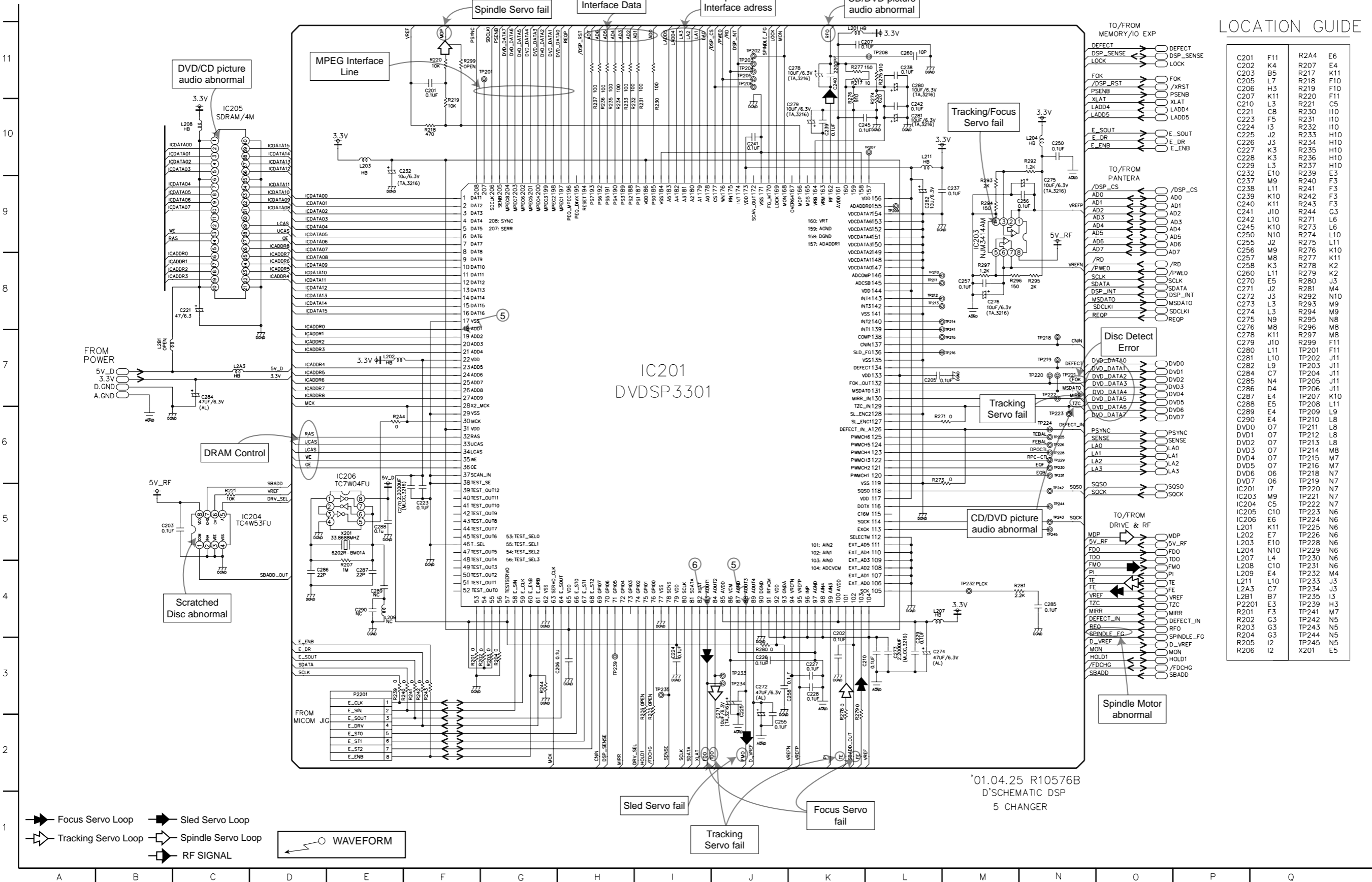

3. DRIVE & RF CIRCUIT DIAGRAM

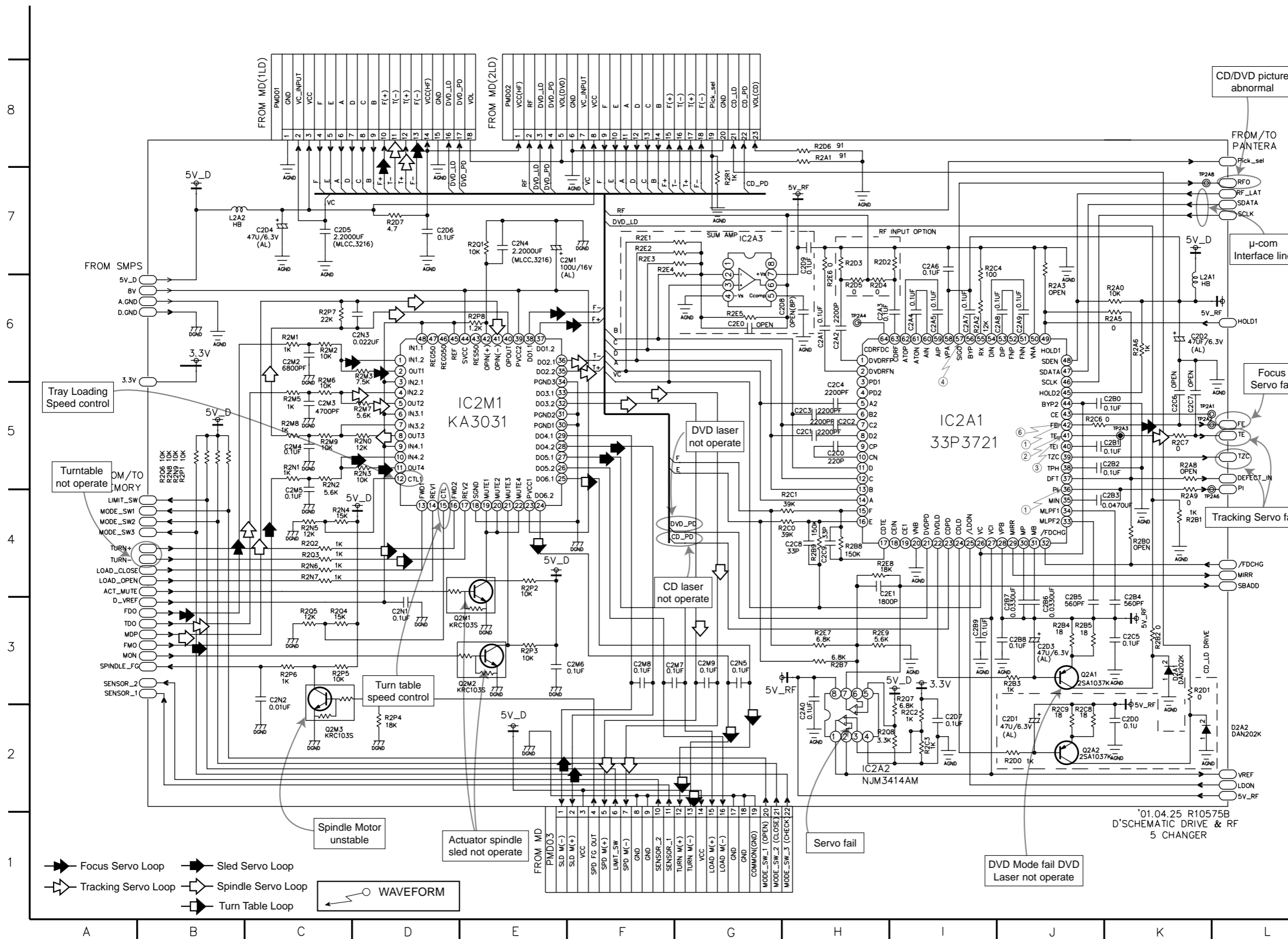

LOCATION GUIDE

C2A0	H2	D2A2	L2	R2M7	D5
C2A1	H6	IC2A1	I5	R2M8	C5
C2A2	H6	IC2A2	H2	R2M9	C5
C2A3	H6	IC2A3	G7	R2N0	D5
C2A4	I6	IC2M1	E5	R2N1	C5
C2A5	I6	L2A1	K6	R2N2	C5
C2A6	I7	L2A2	B7	R2N3	D5
C2A7	I6	Q2A1	J3	R2N4	C4
C2A8	J6	Q2A2	J2	R2N5	C4
C2A9	J6	Q2M1	D3	R2N6	C4
C2B0	K5	Q2M2	D3	R2N7	C4
C2B1	K5	Q2M3	C2	R2N8	B5
C2B2	J5	R2A0	K6	R2N9	B5
C2B3	K4	R2A1	H8	R2P1	B5
C2B4	J3	R2A2	I6	R2P2	E4
C2B5	J3	R2A3	J6	R2P3	E3
C2B6	J3	R2A5	K6	R2P4	D2
C2B7	J3	R2A6	K6	R2P5	C3
C2B8	I3	R2A8	K5	R2P6	C3
C2B9	I3	R2A9	K4	R2P7	C6
C2C0	H5	R2B0	K4	R2P8	E6
C2C1	H5	R2B1	K4	R2Q1	E7
C2C2	H5	R2B2	K3	R2Q2	C4
C2C3	H5	R2B3	J3	R2Q3	C4
C2C4	H5	R2B4	J3	R2Q4	C3
C2C5	K3	R2B5	J3	R2Q5	C3
C2C6	K5	R2B7	H3	R2Q6	B5
C2C7	K5	R2B8	H4	R2Q7	I3
C2C8	H4	R2B9	H4	R2Q8	H2
C2C9	H4	R2C0	G4	R2R1	G7
C2D0	K2	R2C1	H4	TP2A1	K5
C2D1	J2	R2C2	I2	TP2A2	K5
C2D2	K6	R2C3	I2	TP2A3	K5
C2D3	J3	R2C4	I7	TP2A4	H6
C2D4	C7	R2C6	J5	TP2A6	K4
C2D5	C7	R2C7	K5	TP2A8	K7
C2D6	D7	R2C8	J2	TZC	L5
C2D7	I2	R2C9	J2	VC	F7
C2D8	H6	R2D0	J2	VC	F6
C2D9	H7	R2D1	K3	VC	C7
C2E0	G4	R2D2	H7	VREF	L2
C2E1	H4	R2D3	H7		
C2M1	E7	R2D4	H6		
C2M2	C6	R2D5	H6		
C2M3	C5	R2D6	H8		
C2M4	C5	R2D7	D7		
C2M5	C4	R2E1	F7		
C2M6	F3	R2E2	F7		
C2M7	F3	R2E3	F7		
C2M8	F3	R2E4	F7		
C2M9	G3	R2E5	G6		
C2N1	D3	R2E6	H6		
C2N2	C3	R2E7	H3		
C2N3	D6	R2E8	H4		
C2N4	E7	R2E9	H3		
C2N5	G7	R2M1	C6		
CD_PD	G3	R2M2	C6		
D.GND	A6	R2M5	C5		
D2A1	K3	R2M6	C5		

- ➔ Focus Servo Loop
- ➔ Sled Servo Loop
- ➔ Tracking Servo Loop
- ➔ Spindle Servo Loop
- ➔ Turn Table Loop
- ⚡ WAVEFORM

A B C D E F G H I J K L M

'01.04.25 R10575B
D'SCHEMATIC DRIVE & RF
5 CHANGER

4. PANTERA CIRCUIT DIAGRAM

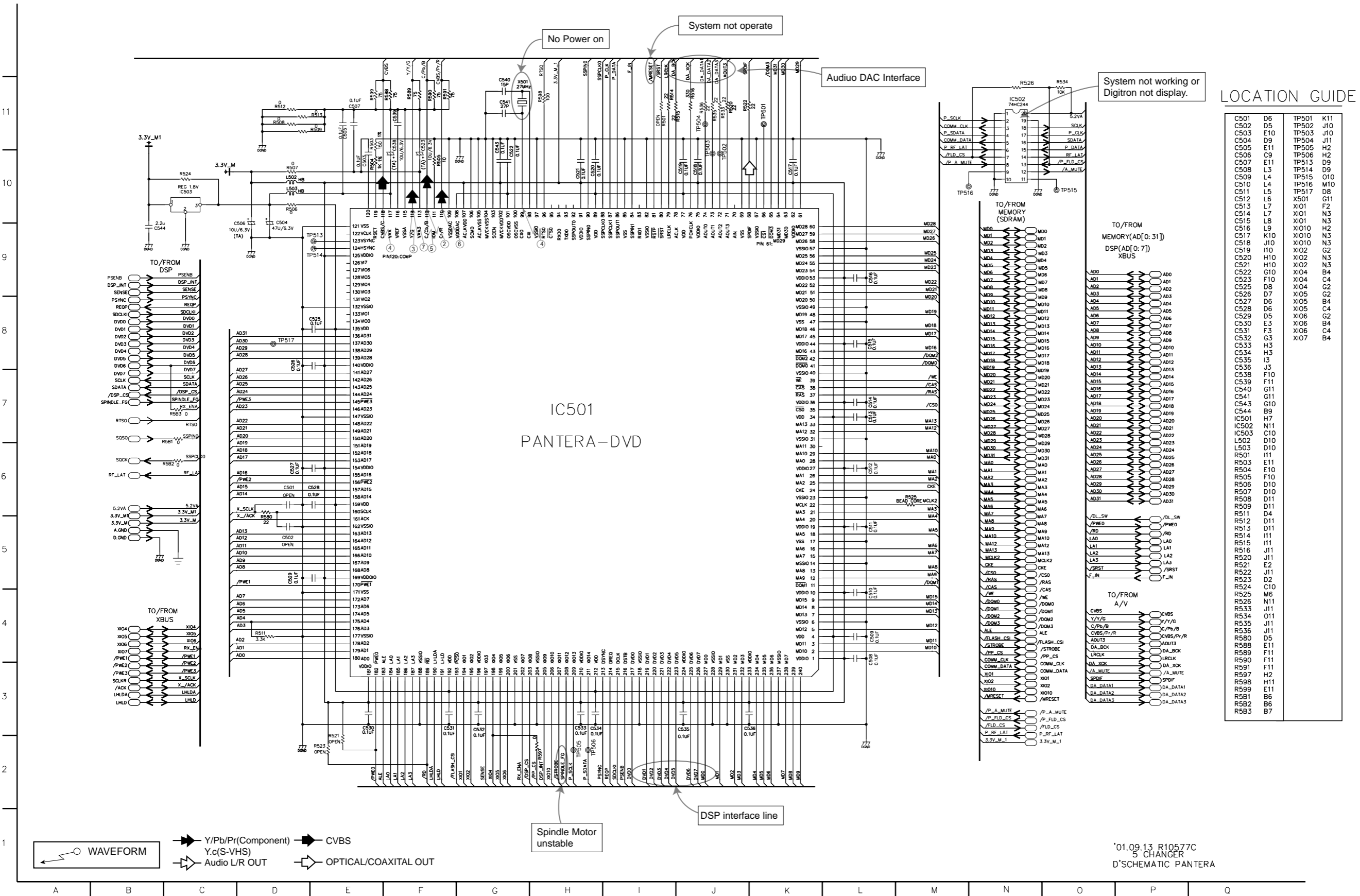

• **WAVEFORMS**

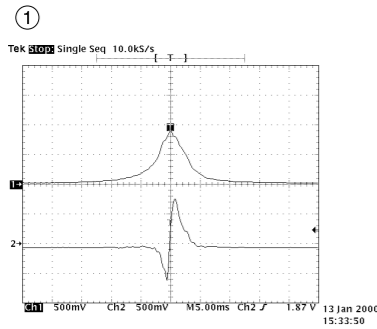

IC2A1 Pin 42, Focus Error
IC2A1 Pin 36, Pi

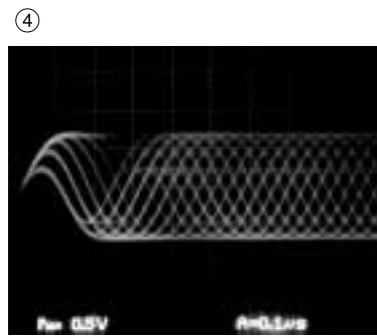

IC2A1 Pin 57, RF

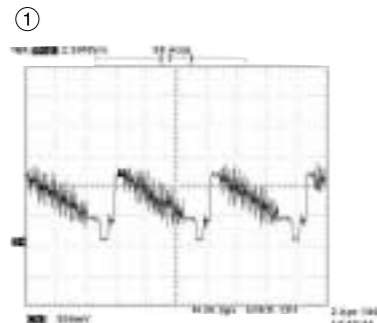

IC501 Pin 118, Composite

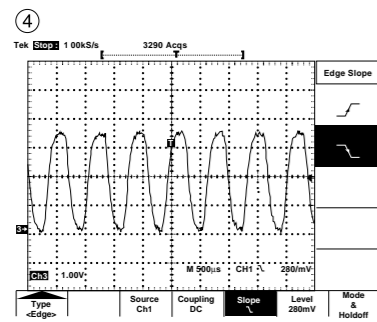

IC501 Pin 99, PANTER MAIN

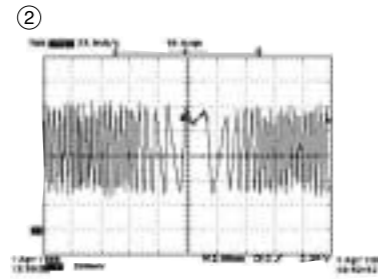

IC2A1 Pin 41 Tracking Error

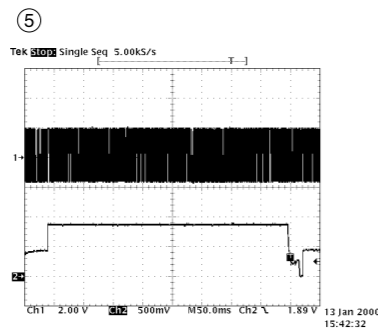

IC201 Pin 88, SLED Drive(FMO)
IC201 Pin 18, SLED FG

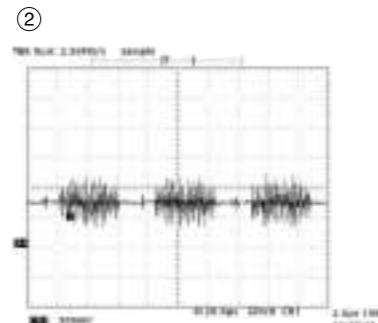

IC501 Pin 112, Chrominance (Super video out Mode)

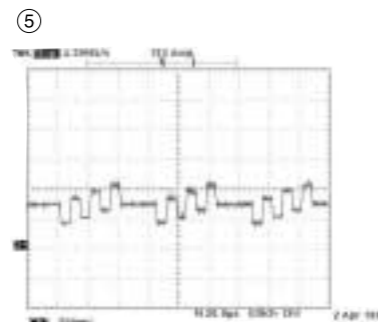

IC501 Pin 112 Component Pb

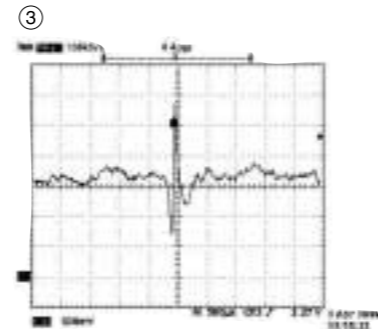

IC2A1 Pin 41 VBR TRACKING Error

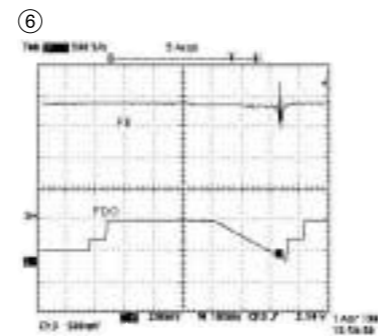

IC2A1 Pin42, Focus Error(in Focus Search)
IC201 Pin 83, Focus Drive(FDO)

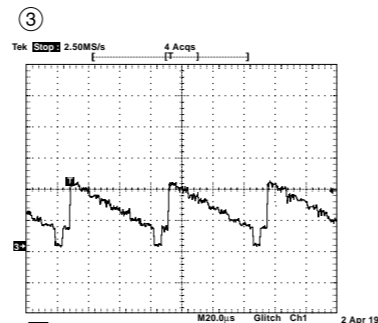

IC501 Pin 114, Luminance (Super video out Mode)



IC501 Pin 110 Component Pr

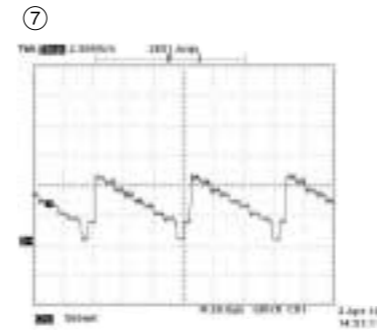

IC501 Pin 114 Component Y

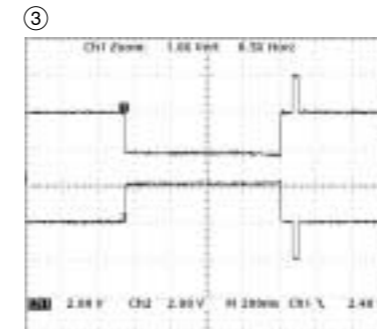

TURN(+)(-) from Motor Drive Reverse turn

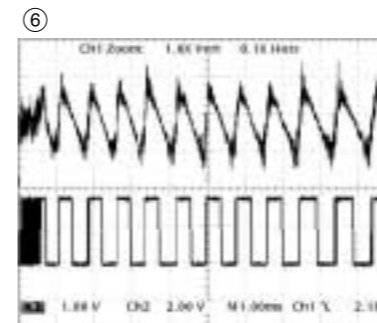

TE/TZC Before tracking servo ON

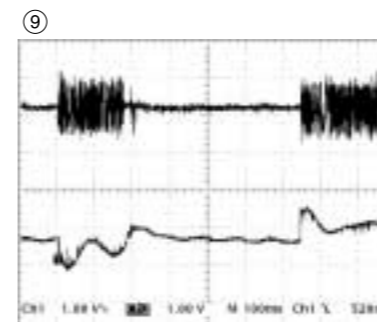

TE/SLD(+) Search mode (outer & inner)

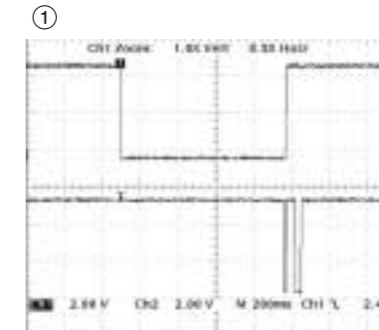

TURN(+)(-) Signal from μ-com

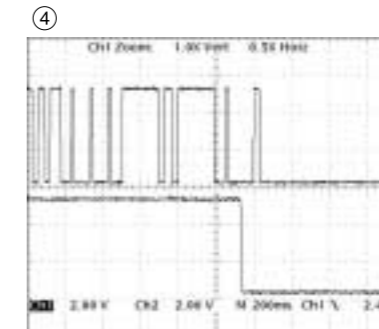

Sensor 1 (disc position)
Sensor 2 (disc ready)

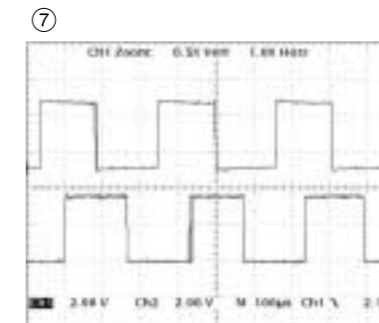

TZC/MIRR (Search mode)

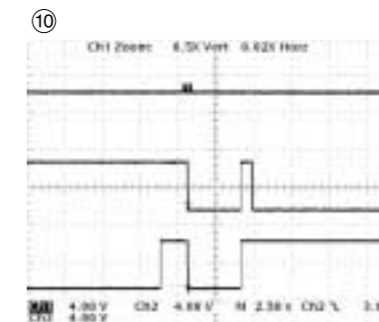

Tray open Tray closed

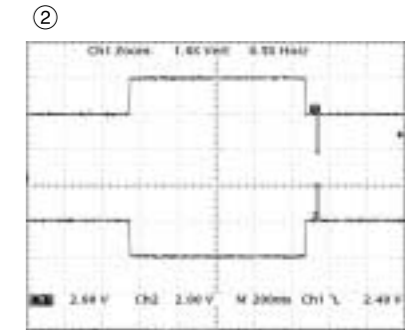

TURN(+)(-) from Motor Drive Forward turn

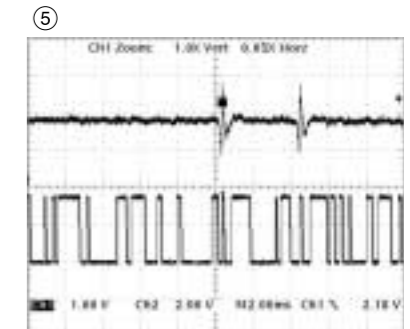

TE/TZC After tracking servo ON (Play mode)

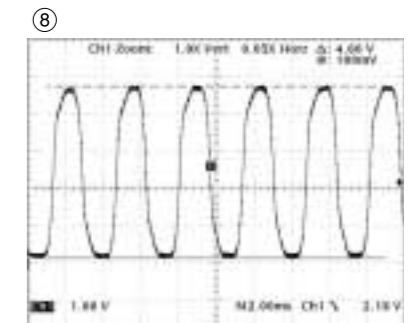

FG Signal from M/D (Play mode)

5. MEMORY CIRCUIT DIAGRAM

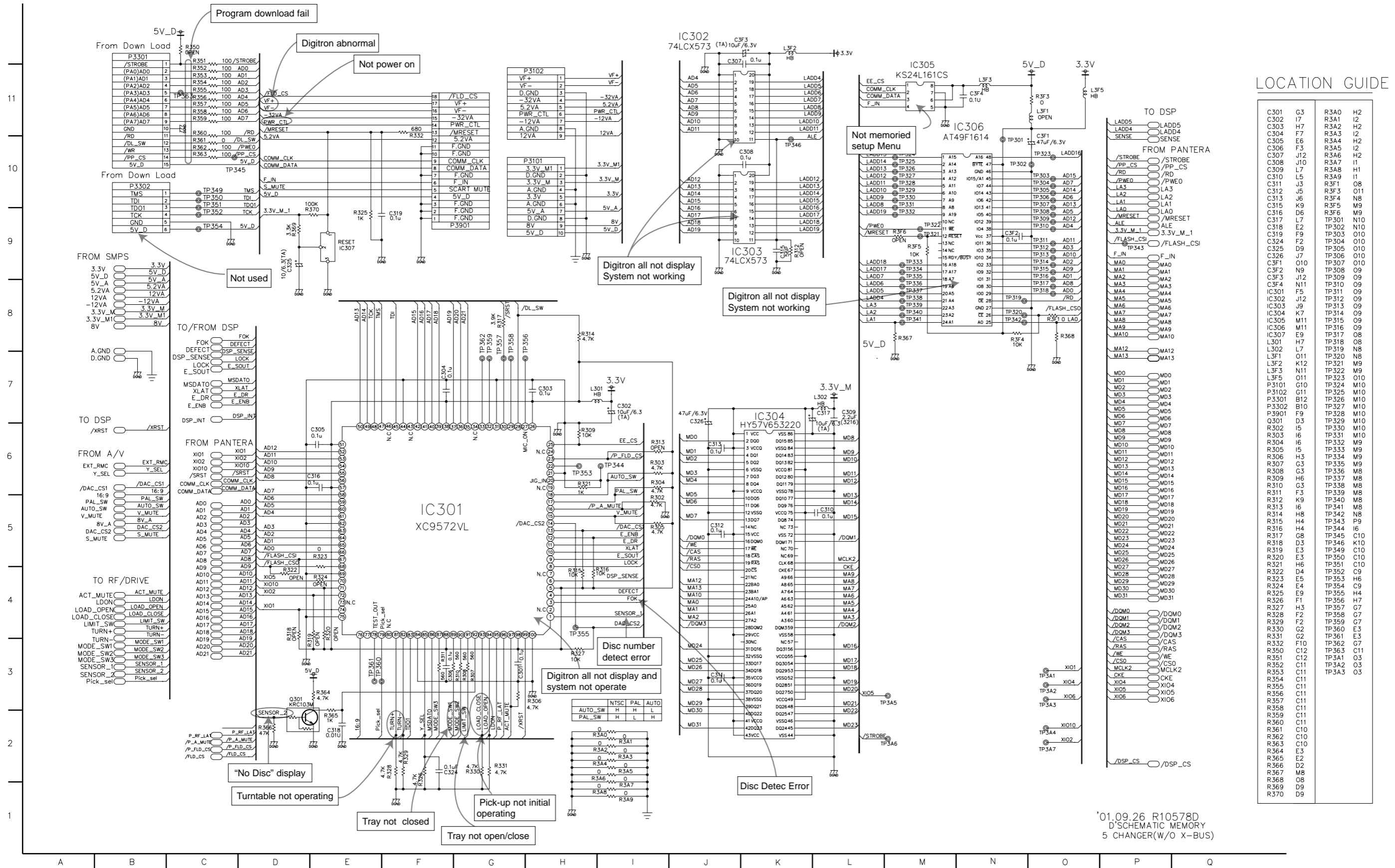

LOCATION GUIDE

C301	G3	R3A0	H2
C302	I7	R3A1	I2
C303	H7	R3A2	H2
C304	F7	R3A3	I2
C305	E6	R3A4	H2
C306	F3	R3A5	I2
C307	J2	R3A6	I1
C308	I0	R3A7	H1
C309	L7	R3A8	H1
C310	L5	R3A9	I1
C311	J3	R3F1	O8
C312	J5	R3F3	O11
C313	J6	R3F4	N8
C315	K9	R3F5	M9
C316	D6	R3F6	M9
C317	L7	TP301	N10
C318	E2	TP302	N10
C319	F9	TP303	O10
C324	F2	TP304	O10
C325	D9	TP305	O10
C326	J7	TP306	O10
C327	O10	TP307	O10
C328	N9	TP308	O10
C329	J12	TP309	O9
C330	N11	TP310	O9
C331	J5	TP311	O9
C332	F2	TP312	O9
C333	K7	TP313	O9
C334	J9	TP314	O9
C335	M11	TP315	O9
C336	M11	TP316	O9
C337	E9	TP317	O8
C338	L7	TP318	O8
C339	L7	TP319	N8
C340	K11	TP320	N8
C341	O10	TP321	M9
C342	N10	TP322	M9
C343	G10	TP323	O10
C344	B12	TP324	M10
C345	B12	TP325	M10
C346	B10	TP326	M10
C347	F10	TP327	M10
C348	B9	TP328	M10
C349	D3	TP329	M10
C350	I5	TP330	M10
C351	I6	TP331	M10
C352	I5	TP332	M9
C353	H3	TP333	M9
C354	G3	TP334	M9
C355	H3	TP335	M9
C356	H3	TP336	M8
C357	G6	TP337	M8
C358	K3	TP338	M8
C359	K3	TP339	M8
C360	K9	TP340	M8
C361	I6	TP341	M8
C362	H8	TP342	N8
C363	H4	TP343	P9
C364	H4	TP344	I6
C365	G8	TP345	C10
C366	D3	TP346	C10
C367	G8	TP347	C10
C368	E3	TP348	C10
C369	F1	TP349	C10
C370	E3	TP350	C10
C371	H6	TP351	C10
C372	D4	TP352	C9
C373	E5	TP353	H6
C374	E4	TP354	C9
C375	E9	TP355	H4
C376	F1	TP356	H7
C377	H3	TP357	G7
C378	F2	TP358	G7
C379	F2	TP359	G7
C380	G2	TP360	E3
C381	G2	TP361	E3
C382	F10	TP362	G7
C383	C12	TP363	C11
C384	C12	TP364	C11
C385	C11	TP365	C11
C386	C11	TP366	D2
C387	M8	TP367	M8
C388	O8	TP368	O8
C389	D9	TP369	D9
C390	D9	TP370	D9

'01.09.26 R10578D
D'SCHEMATIC MEMORY
5 CHANGER(W/O X-BUS)

6. TIMER & KEY CIRCUIT DIAGRAM

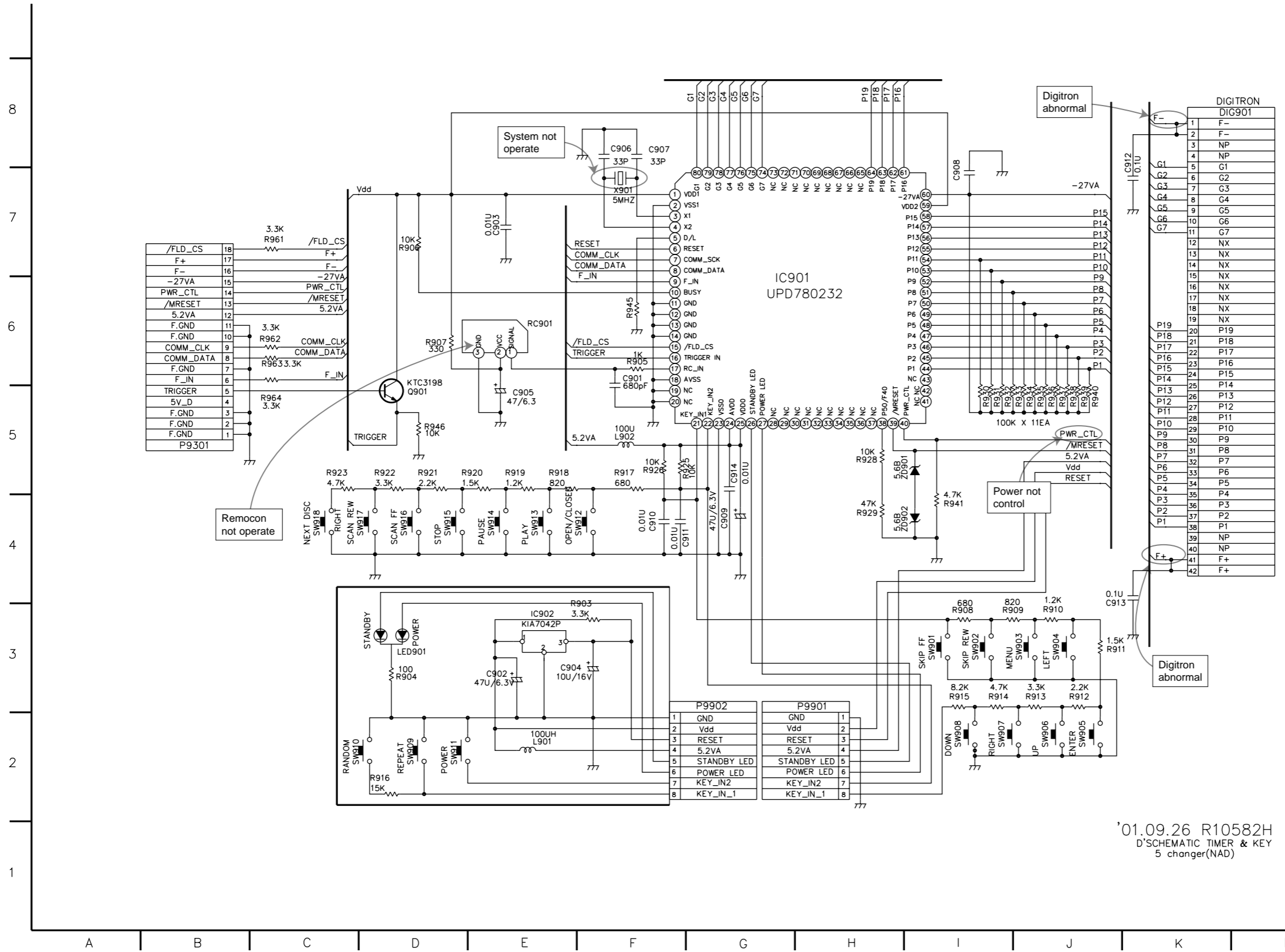

LOCATION GUIDE

C901	F6	RESET	E7
C902	E3	RESET	J5
C903	E7	SW901	I3
C904	E3	SW902	I3
C905	E5	SW903	J3
C906	F8	SW904	J3
C907	F8	SW905	J2
C908	I7	SW906	J2
C909	G4	SW907	I2
C910	F4	SW908	I2
C911	G4	SW909	D2
C912	K7	SW910	C2
C913	J3	SW911	D2
C914	G5	SW912	F4
DIG901	K8	SW913	E4
IC901	G6	SW914	E4
IC902	E3	SW915	D4
L901	E2	SW916	D4
L902	F5	SW917	D4
LED901	D3	SW918	C4
P9301	B5	SW919	F7
P9901	H3	ZD901	I5
P9902	G3	ZD902	I4
Q901	D5		
R903	E3		
R904	D3		
R905	F6		
R906	D7		
R907	D6		
R908	I3		
R909	I3		
R910	J3		
R911	J3		
R912	J3		
R913	J3		
R914	I3		
R915	I3		
R916	D2		
R917	F5		
R918	E5		
R919	E5		
R920	D5		
R921	D5		
R922	D5		
R923	C5		
R925	G5		
R926	F5		
R928	H5		
R929	H4		
R930	I5		
R931	I5		
R932	I5		
R933	J5		
R934	J5		
R935	J5		
R936	J5		
R937	J5		
R938	J5		
R939	J5		
R940	J5		
R941	I4		
R945	F6		
R946	D5		
R961	C7		
R962	C6		
R963	C6		
R964	C5		
RC901	E6		

'01.09.26 R10582H
D'SCHEMATIC TIMER & KEY
5 changer(NAD)

7. AV CIRCUIT DIAGRAM

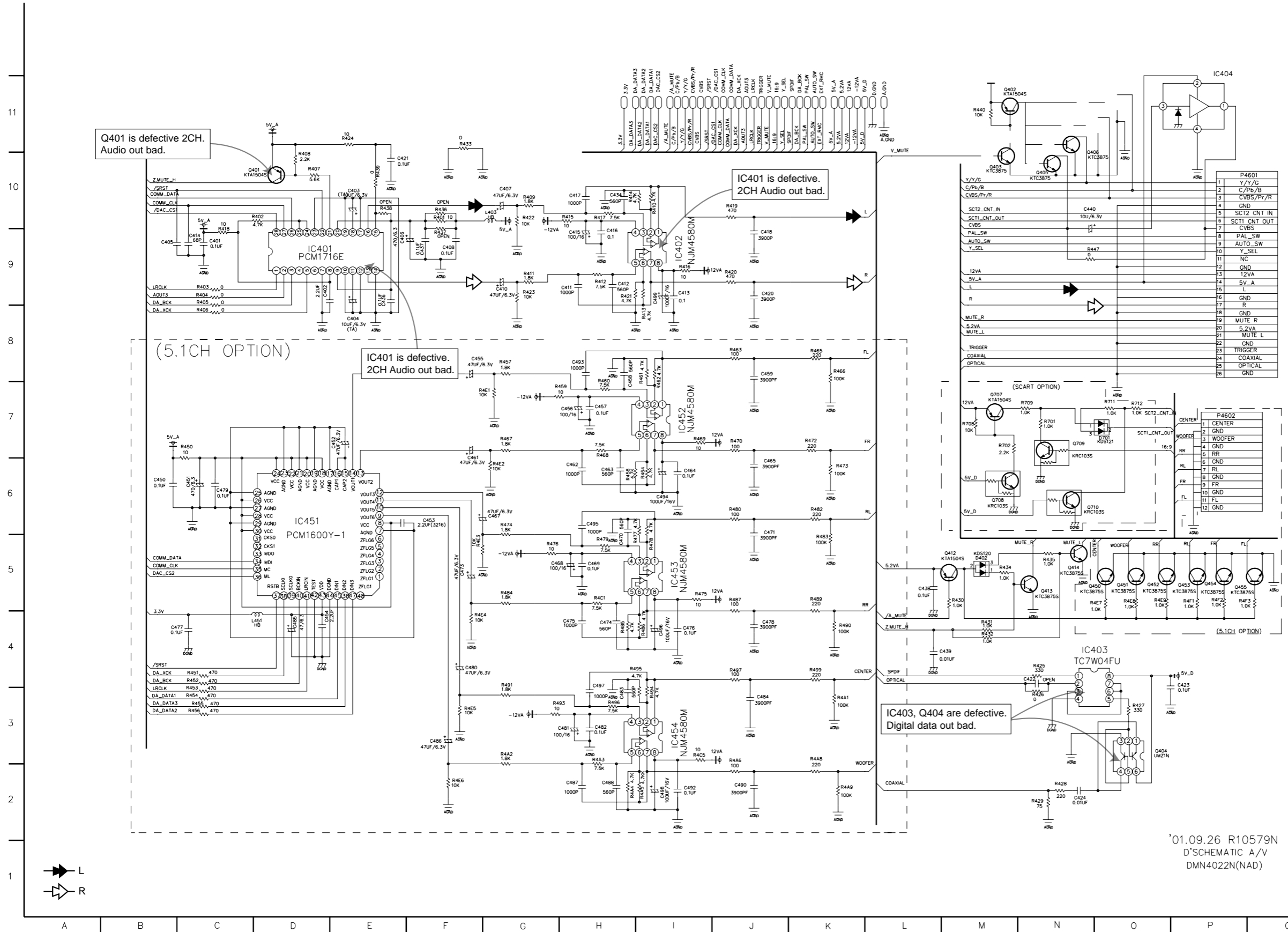

LOCATION GUIDE

C401	C9	Q401	C10	R466	K8
C402	D9	Q402	M11	R467	G7
C403	E10	Q403	M10	R468	H7
C404	E8	Q404	O3	R469	I7
C405	B9	Q405	N10	R470	J7
C406	E9	Q406	N10	R472	K7
C407	G10	Q407	N11	R473	K6
C408	F5	Q408	O11	R474	O6
C410	G9	Q412	M5	R475	I5
C411	H9	Q413	N5	R476	G5
C412	H9	Q414	N5	R477	I5
C413	I9	Q450	N5	R478	I5
C414	C9	Q451	O5	R479	H5
C415	H9	Q452	O5	R480	J6
C416	H9	Q453	P5	R482	K5
C417	H10	Q454	P5	R483	K5
C418	J9	Q455	P5	R484	G5
C420	J9	Q707	M7	R485	H4
C421	E10	Q708	M6	R486	I4
C422	N4	Q709	N7	R487	J5
C423	P4	Q710	N6	R489	K5
C424	N2	R401	F10	R490	K4
C434	H10	R402	C10	R491	G4
C436	E8	R403	C9	R493	G3
C437	F9	R404	C9	R494	I3
C438	L5	R405	C9	R495	H4
C439	L4	R406	C8	R496	H3
C440	N10	R407	D10	R497	J4
C448	B6	R408	D10	R498	K4
C452	E7	R409	G10	R499	K3
C453	F6	R410	I10	R4A2	G3
C454	D4	R411	G9	R4A3	H3
C455	F8	R412	H9	R4A4	H2
C456	H7	R413	I8	R4A5	I2
C457	H7	R414	H10	R4A6	J3
C458	H7	R415	H10	R4A8	K3
C459	I8	R416	I9	R4A9	K2
C461	F6	R417	H10	R4C1	H5
C462	H6	R418	C9	R4C5	I3
C463	H6	R419	J10	R4E1	F7
C464	I6	R420	J9	R4E2	G6
C465	J6	R421	H9	R4E3	F5
C467	G6	R422	G10	R4E4	F4
C469	H5	R424	E11	R4E6	F2
C470	H5	R425	N4	R4E7	N5
C471	J6	R426	N3	R4E8	O5
C473	F5	R427	O3	R4E9	O5
C474	H4	R428	N2	R4F1	P5
C475	H4	R429	N2	R4F2	P5
C476	E4	R430	M5	R4F3	P5
C477	B4	R431	M4	R701	N7
C478	J4	R432	M4	R702	M7
C479	C6	R433	F11	R708	M7
C480	F4	R434	M5	R709	N7
C481	G3	R435	N5	R711	O7
C482	H3	R436	F10	R712	O7
C483	H3	R437	F9		
C484	J3	R438	E10		
C485	D4	R439	E10		
C486	F3	R440	M11		
C487	H2	R441	M11		
C488	H2	R442	M11		
C490	J2	R443	N11		
C492	I2	R444	N11		
C493	H8	R445	N11		
C494	I6	R446	N10		
C495	H6	R447	N9		
C496	I4	R450	C7		
C497	H4	R451	C4		
C498	I2	R452	C4		
C499	I9	R453	C3		
IC401	O9	R454	C3		
IC402	I9	R455	C3		
IC403	N4	R456	C3		
IC404	P11	R457	G8		
IC451	D6	R458	H6		
IC452	I7	R459	G7		
IC453	I5	R460	H7		
IC454	I3	R461	I7		
L403	G10	R462	I7		
L451	C4	R463	J8		
D402	M5	R464	I6		
D701	O7	R465	K8		

'01.09.26 R10579N
D'SCHEMATIC A/V
DMN4022N(NAD)

8. A/V JACK CIRCUIT DIAGRAM

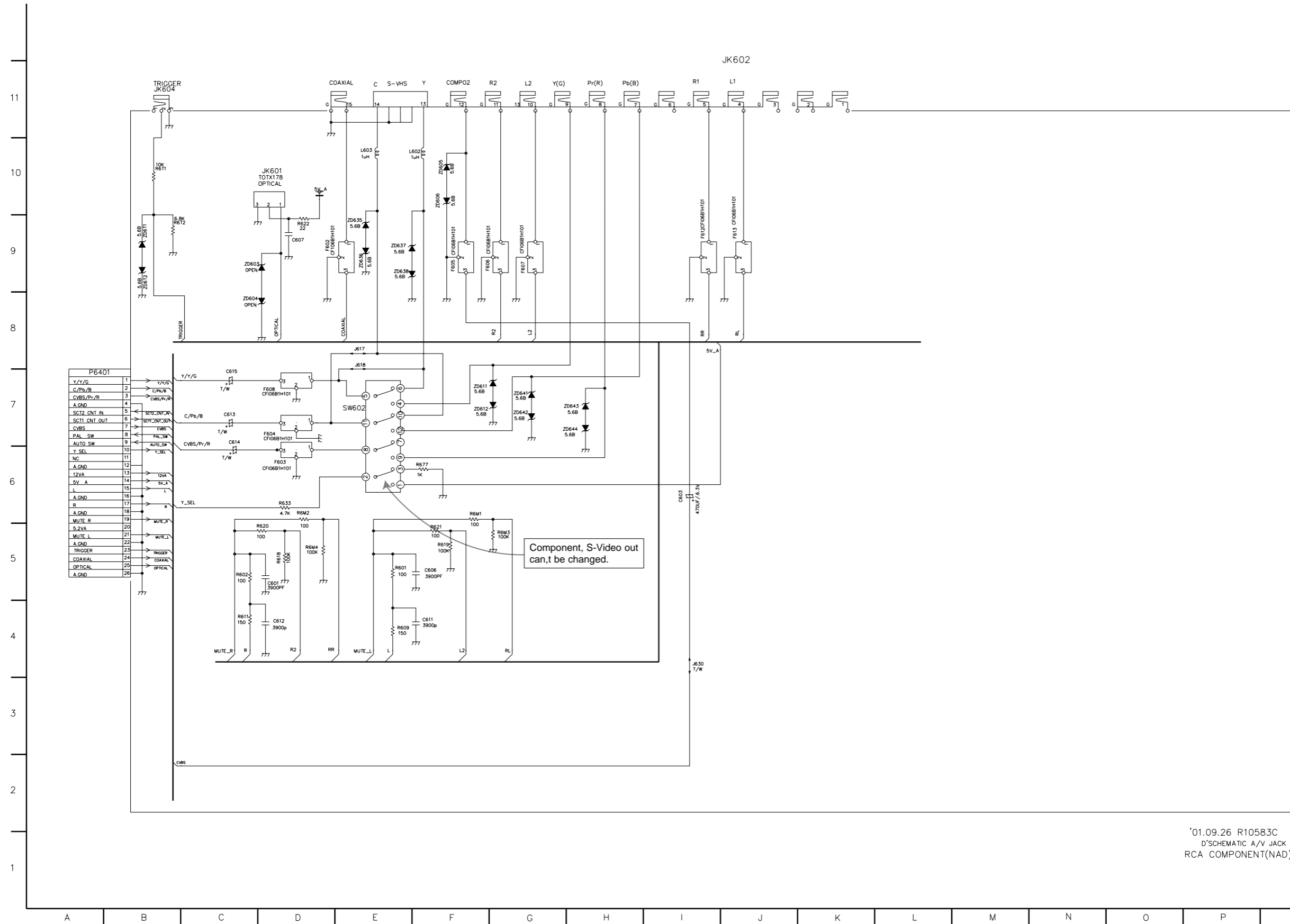

'01.09.26 R10583C
 D'SCHEMATIC A/V JACK
 RCA COMPONENT(NAD)

• CIRCUIT VOLTAGE CHART

MODE PIN NO.	LEVEL(V)
PANTERA IC 501	
1	3.18
2	1.3
3	1.4
4	2.2
5	1.5
6	0
7	1.5
8	1.4
9	1.6
10	3.1
11	0.7
12	0.15
13	0.15
14	0
15	0
16	1.7
17	1.4
18	0
19	1.5
20	1.6
21	0
22	1.6
23	0
24	3.1
25	1.7
26	1.4
27	3.1
28	1.5
29	0.15
30	
31	0
32	0.7
33	1.5
34	2.2
35	2
36	3.1
37	2.9
38	2.2
39	2.9
40	0
41	0
42	0
43	1.6
44	3.1
45	1.6
46	1.5
47	0
48	1.4
49	0
50	1.5
51	1.7
52	1.2
53	3.1

MODE PIN NO.	LEVEL(V)
54	1.6
55	1.4
56	1.5
57	0
58	1.6
59	1.4
60	1.5
61	1.4
62	3.1
63	1
64	1.5
65	0.005
66	0.5
67	0.003
68	1.58
69	0
70	3.1
71	1.2
72	1.2
73	1.2
74	1.2
75	3.1
76	1.65
77	2.2
78	1.5
79	1.5
80	3.1
81	3.1
82	0.001
83	3.1
84	3.7
85	0
86	
87	3.1
88	3.1
89	2.1
90	0.004
91	3.1
92	0
93	
94	
95	
96	
97	0
98	
99	
100	0
101	2.1
102	3.1
103	0
104	0
105	0
106	0
107	2.1
108	2.1

MODE PIN NO.	LEVEL(V)
109	0
110	0.8
111	0.9
112	1.3
113	3.1
114	0.78
115	0
116	1.26
117	2.38
118	0.08
119	1.2
120	2
121	0
122	3.1
123	3.1
124	3.1
125	3.1
126	
127	
128	
129	
130	
131	
132	0
133	
134	
135	2.2
136	
137	3.1
138	3.1
139	3.1
140	3.1
141	3.1
142	3.1
143	3.1
144	3.1
145	3.1
146	3.1
147	0
148	3.1
149	3.1
150	3.1
151	3.1
152	3.1
153	3.1
154	3.1
155	3.1
156	3.1
157	3.1
158	3.1
159	2.2
160	1.5
161	3.1
162	
163	0

MODE PIN NO.	LEVEL(V)
164	3.1
165	3.1
166	3.1
167	3.1
168	3.1
169	3.1
170	3.1
171	0
172	3.1
173	3.1
174	3.1
175	1.5
176	3.1
177	0
178	3.1
179	3.1
180	3.1
181	3.1
182	3.18
183	0.086
184	3
185	2.4
186	2.3
187	0
188	0
189	3.1
190	0
191	0.017
192	2.2
193	3.1
194	3.1
195	0
196	3.18
197	1.3
198	3.1
199	3.1
200	3.1
201	0
202	2.3
203	3.1
204	0.001
205	3.1
206	3.1
207	3.1
208	1.6
209	3.1
210	3.18
211	0.018
212	2.2
213	3.19
214	2.69
215	1.5
216	2.9
217	2.59
218	0

MODE PIN NO.	LEVEL(V)
219	2.29
220	2.08
221	2.29
222	2.29
223	2.49
224	3.1
225	2.39
226	2.45
227	1.5
228	0
229	1.52
230	0
231	1.61
232	1.6
233	3.1
234	1.6
235	1.6
236	1.5
237	0
238	1.6
239	1.4
240	1.5

MODE PIN NO.	LEVEL(V)
MEMORY IC 301	
1	4.3
2	
3	3.1
4	0
5	3.2
6	2
7	
8	3.1
9	0.01
10	3.1
11	3.2
12	3.2
13	3.2
14	3.2
15	0
16	3.1
17	3.1
18	3.1
19	
20	0
21	0
22	0
23	3
24	
25	0.625
26	3.2
27	0.705
28	3.2
29	3.1
30	
31	0
32	
33	
34	
35	3.1
36	3.1
37	2.39
38	3.2
39	1.49
40	1.5
41	3.09
42	1.69
43	0
44	3.1
45	
46	3.1
47	
48	2.5
49	3.1
50	3.1
51	3.2
52	3.1
53	3.1

MODE PIN NO.	LEVEL(V)
54	3.1
55	3.1
56	3.1
57	3.1
58	3.1
59	3.1
60	3.1
61	0.5
62	0
63	3.1
64	3.1
65	3.1
66	3.1
67	3.1
68	1.6
69	0
70	0
71	3.1
72	0
73	
74	3.1
75	0
76	3.2
77	0
78	3.1
79	0.3
80	
81	0
82	0
83	2.5
84	0
85	3.19
86	3.19
87	4.4
88	3.19
89	4.4
90	0
91	4.4
92	0
93	0
94	0
95	0
96	0
97	3.17
98	3.17
99	3.1
100	0

MODE PIN NO.	EE	PLAY
D S P IC201 SP3301		
1	2.00	1.30
2	2.00	1.30
3	2.00	1.30
4	2.00	1.30
5	2.00	1.30
6	2.00	1.30
7	2.00	1.30
8	2.00	1.30
9	2.00	1.30
10	2.00	1.30
11	2.00	1.30
12	2.00	1.30
13	2.00	1.30
14	2.00	1.30
15	2.00	1.30
16	2.00	1.30
17	0.00	0.00
18	0.00	1.50
19	0.00	1.50
20	0.00	1.50
21	0.00	1.50
22	3.10	3.00
23	0.00	1.50
24	0.00	1.50
25	0.00	1.50
26	0.00	1.50
27	0.00	1.50
28	2.10	1.50
29	0.00	0.00
30	2.10	2.00
31	3.10	3.00
32	3.10	1.50
33	3.10	2.50
34	3.10	2.50
35	2.10	1.30
36	1.10	1.80
37	0.00	0.00
38	0.00	0.00
39	0.00	0.00
40	3.10	3.00
41	0.00	0.00
42	3.10	3.00
43	0.00	0.00
44	0.00	0.00
45	3.10	3.00
46	0.00	0.00
47	0.00	0.00
48	0.00	0.00
49	0.00	3.00
50	0.00	0.00
51	0.00	0.00
52	3.10	1.80
53	0.00	0.00

MODE PIN NO.	EE	PLAY
54	3.10	3.00
55	3.10	3.00
56	0.00	0.00
57	0.00	3.13
58	5.00	4.98
59	0.00	0.00
60	0.00	0.00
61	5.00	4.98
62	0.00	0.00
63	2.10	2.10
64	0.00	0.00
65	3.10	3.00
66	0.00	0.00
67	3.10	3.12
68	0.00	0.00
69	0.00	0.20
70	0.00	0.00
71	3.10	3.10
72	0.00	0.20
73	0.00	0.00
74	3.10	3.10
75	0.00	0.00
76	0.00	0.00
77	0.00	0.00
78	0.00	2.30
79	3.10	3.10
80	5.00	5.00
81	0.00	0.00
82	5.00	5.00
83	2.10	2.00
84	2.10	2.10
85	3.10	3.10
86	1.40	1.40
87	0.00	0.00
88	2.10	2.00
89	2.10	2.00
90	0.00	0.00
91	1.50	1.55
92	3.10	3.12
93	1.60	1.55
94	1.10	1.11
95	2.00	2.00
96	1.55	1.55
97	0.00	0.00
98	1.55	1.55
99	1.56	2.15
100	3.10	3.10
101	1.55	1.58
102	1.55	1.55
103	1.62	1.64
104	1.55	1.55
105	1.50	1.50
106	0.00	0.00
107	0.00	0.00
108	0.00	0.00

MODE PIN NO.	EE	PLAY
109	0.00	0.00
110	0.00	0.00
111	0.00	0.00
112	0.00	0.00
113	3.40	4.70
114	5.00	5.00
115	1.50	1.50
116	1.50	1.53
117	3.10	3.10
118	0.00	0.00
119	0.00	0.00
120	3.50	4.20
121	3.25	4.20
122	3.45	4.30
123	3.50	4.30
124	3.50	4.30
125	3.50	4.50
126	0.00	0.00
127	3.60	2.60
128	0.00	0.00
129	3.60	2.60
130	0.00	0.20
131	0.00	0.00
132	0.00	3.10
133	3.10	3.10
134	0.00	0.00
135	0.00	0.00
136	3.10	2.20
137	0.00	0.00
138	0.00	0.00
139	3.10	3.10
140	3.00	3.10
141	0.00	0.00
142	3.00	3.00
143	3.10	3.10
144	3.10	3.10
145	3.10	0.90
146	3.50	4.50
147	0.00	0.00
148	0.00	0.00
149	0.00	0.00
150	0.00	0.00
151	0.00	0.00
152	0.00	0.00
153	0.00	0.00
154		

2. AV JACK P.C.BOARD

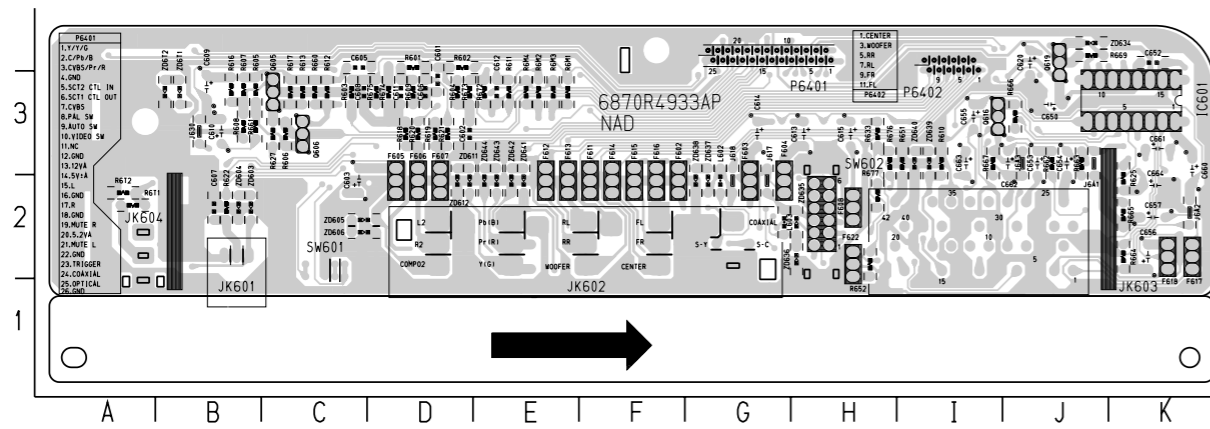

LOCATION GUIDE

CE91	D3	IC601	K3	RE52	H2
CE92	D3	J617	G2	RE60	C3
CE93	C2	J618	G2	RE61	B3
CE95	C4	J630	B3	RE62	J3
CE96	D3	J641	J3	RE63	J3
CE97	B2	J642	K2	RE64	K2
CE98	C3	J643	J3	RE65	K2
CE99	B3	J661	B2	RE66	J2
CE10	B3	J662	F2	RE67	J2
CE11	D3	J663	J2	RE69	E3
CE12	E3	J684	K2	RE72	E3
CE13	H3	L632	G2	RE73	D3
CE14	D3	L633	G2	RE74	D3
CE15	H3	P641	M4	RE76	D3
CE20	J4	P642	L4	RE76	H3
CE21	K4	Q605	C3	RE77	H3
CE22	K4	Q606	C3	RE77	H3
CE23	J3	Q616	I3	RE82	E3
CE24	J3	Q619	J4	RE83	E3
CE25	I3	R611	D4	RE84	E3
CE26	K2	R612	D4	RE11	A2
CE27	K2	R613	C3	RE12	A2
CE28	K3	R614	C3	SW61	C2
CE29	K3	R615	B3	SW62	H2
CE29	K3	R615	B3	SW62	H2
CE30	J3	R616	C3	Z605	B2
CE31	I3	R617	B3	Z606	B2
CE34	K2	R618	B3	Z609	C2
FE02	F2	R619	D3	Z609	C2
FE03	D2	R619	I3	Z611	D2
FE04	D2	R611	E3	Z612	D2
FE05	D2	R612	C3	Z614	J4
FE06	D2	R613	C3	Z615	H2
FE07	D2	R616	B3	Z616	H2
FE08	H2	R617	C3	Z617	G2
FE11	F2	R618	D3	Z618	G2
FE12	E2	R619	D3	Z619	I2
FE13	E2	R620	D3	Z640	I3
FE14	F2	R621	D3	Z641	E2
FE15	F2	R622	B2	Z642	E2
FE16	F2	R623	K2	Z643	E2
FE17	K2	R627	C3	Z644	E2
FE18	K2	R633	H3	Z611	B3
FE22	H2	R651	I3	Z612	B3

3. SMPS P.C.BOARD

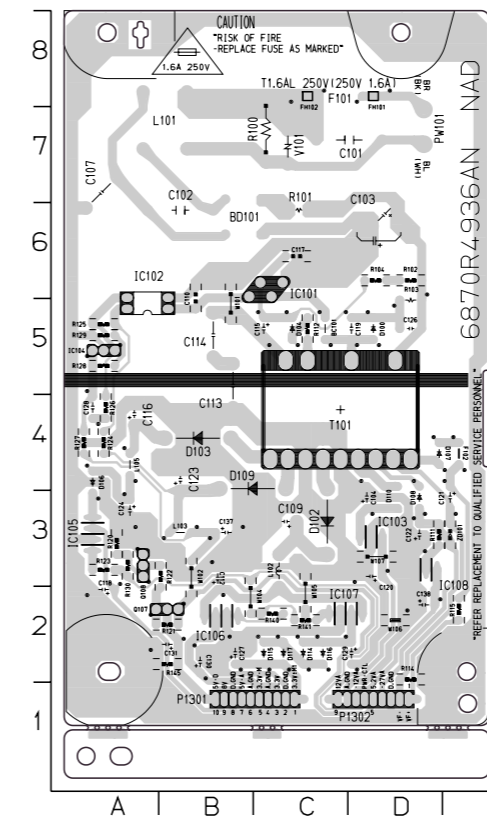

LOCATION GUIDE

BC101	C5	FH102	C8
BD101	B6	IC101	C6
C101	D7	IC102	A5
C102	B6	IC103	D3
C103	D6	IC104	A5
C104	D3	IC105	A3
C107	A7	IC106	B2
C109	C3	IC107	D2
C110	B6	IC108	D3
C112	B3	L101	B7
C113	B5	L102	C3
C114	B5	L103	B3
C115	C5	L105	A4
C116	A4	P1301	C1
C117	C6	P1302	D1
C118	A2	PW101	D7
C119	D5	Q107	B2
C120	D3	Q108	A3
C121	E3	R100	C7
C122	D3	R101	C6
C123	B4	R102	D6
C124	A3	R103	D5
C126	D5	R104	D6
C127	B2	R111	D3
C128	A4	R112	C5
C129	D2	R114	D2
C130	B2	R115	E2
C131	B2	R120	A3
C137	B3	R121	B2
C138	D2	R122	B3
D100	D5	R123	A3
D102	C3	R124	A4
D103	B4	R125	A5
D104	C5	R126	A4
D106	A4	R127	A4
D107	D4	R128	A5
D108	D3	R129	A5
D109	B4	R130	A3
D110	D3	R140	C2
D114	C2	R141	C2
D115	C2	R145	B2
D116	C2	T101	C4
D117	C2	V101	C7
F102	E4	ZD101	E3
FH101	D8		

4. FRONT P.C.BOARD

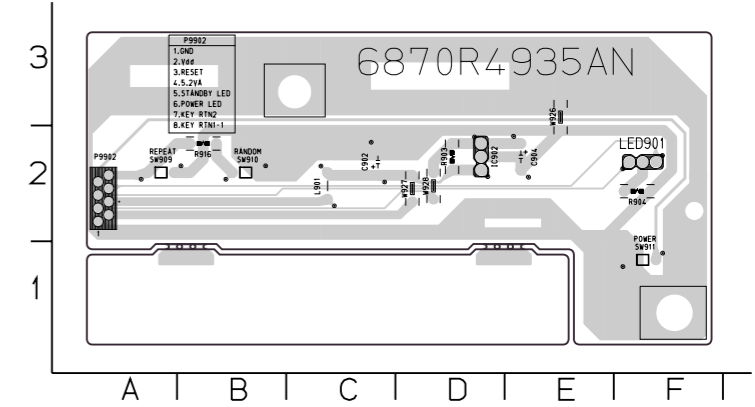
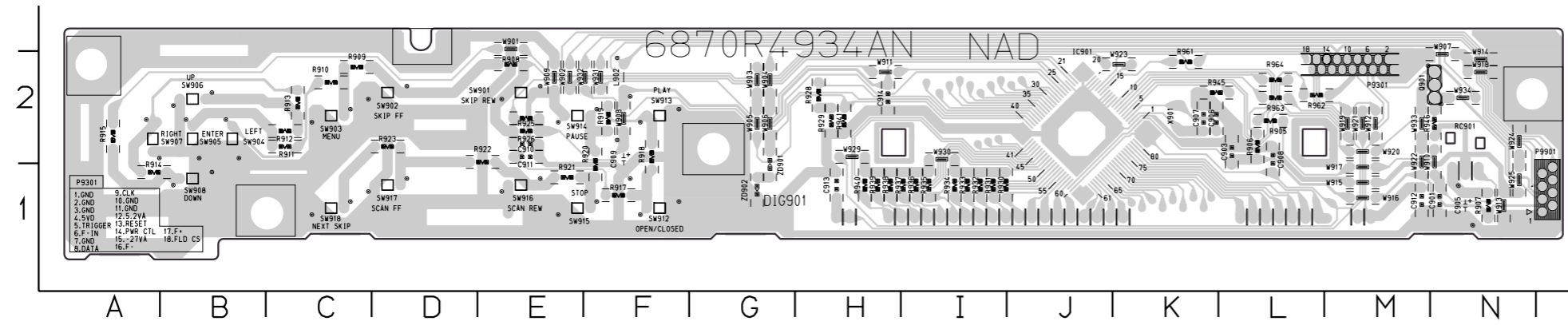

CIRCUIT DIAGRAM

1. POWER(SMPS) CIRCUIT DIAGRAM

NOTE :
 1. Shaded(■) parts are critical for safety. Replace only with specified part number.
 2. Voltages are DC-measured with a digital voltmeter during Play mode.

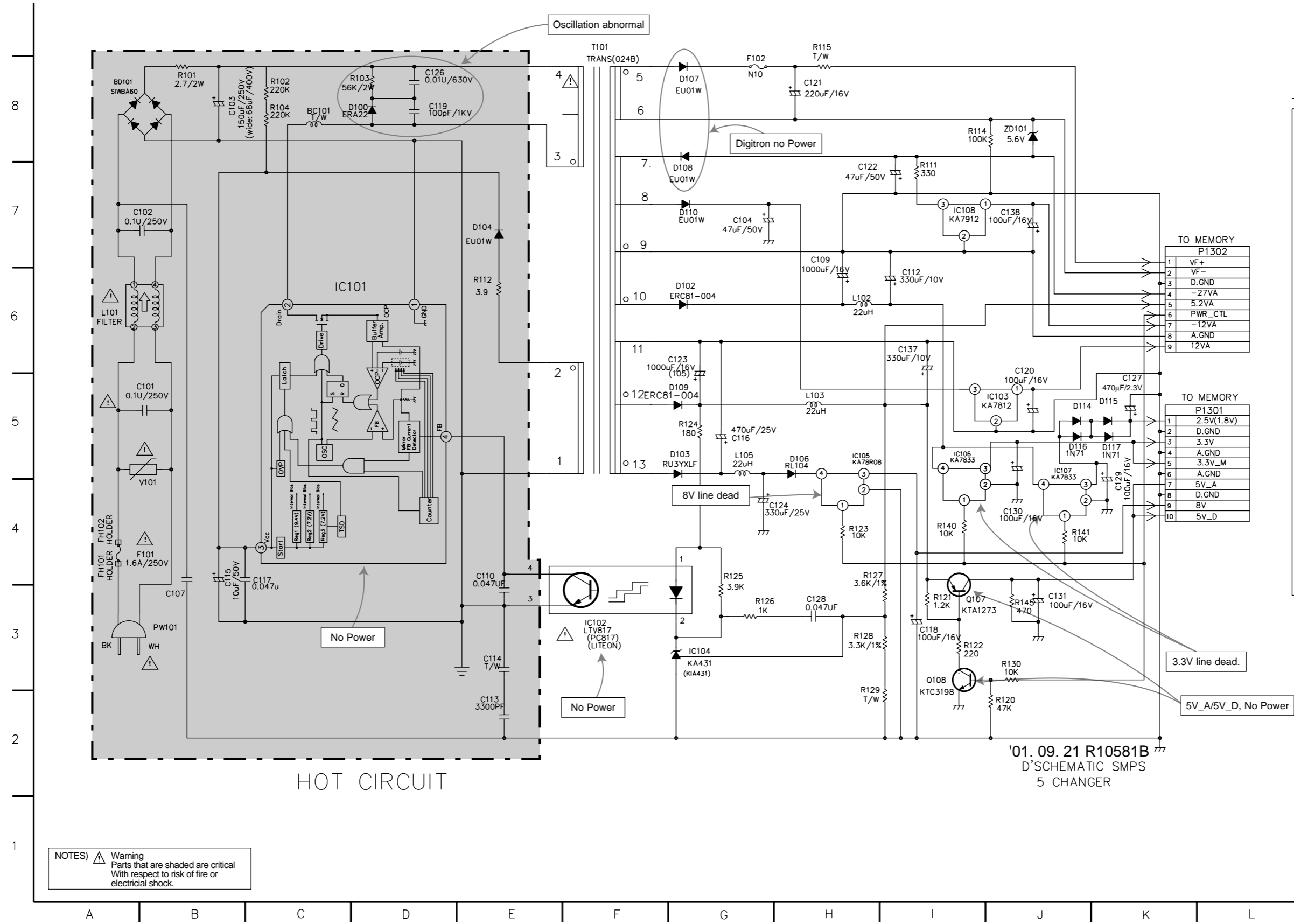

LOCATION GUIDE

BC101	C8	FH101	A4
BD101	A8	FH102	A4
C101	A5	IC101	C6
C102	A7	IC102	F3
C103	B8	IC103	J5
C104	G7	IC104	G3
C107	B3	IC105	H5
C109	H7	IC106	I5
C110	E4	IC107	J5
C112	I6	IC108	I7
C113	E2	L101	A6
C114	E3	L102	H6
C115	B3	L103	H5
C116	G5	L105	G5
C117	C4	P1301	K5
C118	I3	P1302	L7
C119	D8	PW101	B3
C120	J6	Q107	I3
C121	H8	Q108	I3
C122	H7	R101	B8
C123	G6	R102	C8
C124	G4	R103	D8
C126	D8	R104	C8
C127	K5	R111	I7
C128	H3	R112	E6
C129	K4	R114	I8
C130	J4	R115	H9
C131	J3	R120	J2
C137	I6	R121	I3
C138	J7	R122	I3
D100	C8	R123	H4
D102	G6	R124	G5
D103	G5	R125	G4
D104	E7	R126	G3
D106	H5	R127	H4
D107	G8	R128	H3
D108	G7	R129	H2
D109	G5	R130	J3
D110	G7	R140	I4
D114	J5	R141	J4
D115	K5	R145	J3
D116	J5	T101	F9
D117	K5	V101	B4
F102	G8	ZD101	J8

TO MEMORY
P1302

1	VF+
2	VF-
3	D.GND
4	-27VA
5	5.2VA
6	PWR_CTL
7	-12VA
8	A.GND
9	12VA

TO MEMORY
P1301

1	2.5V(1.8V)
2	D.GND
3	3.3V
4	A.GND
5	3.3V_M
6	A.GND
7	5V_A
8	D.GND
9	8V
10	5V_D

NOTES) ⚠ Warning
 Parts that are shaded are critical
 With respect to risk of fire or
 electrical shock.

2. DVD DSP CIRCUIT DIAGRAM

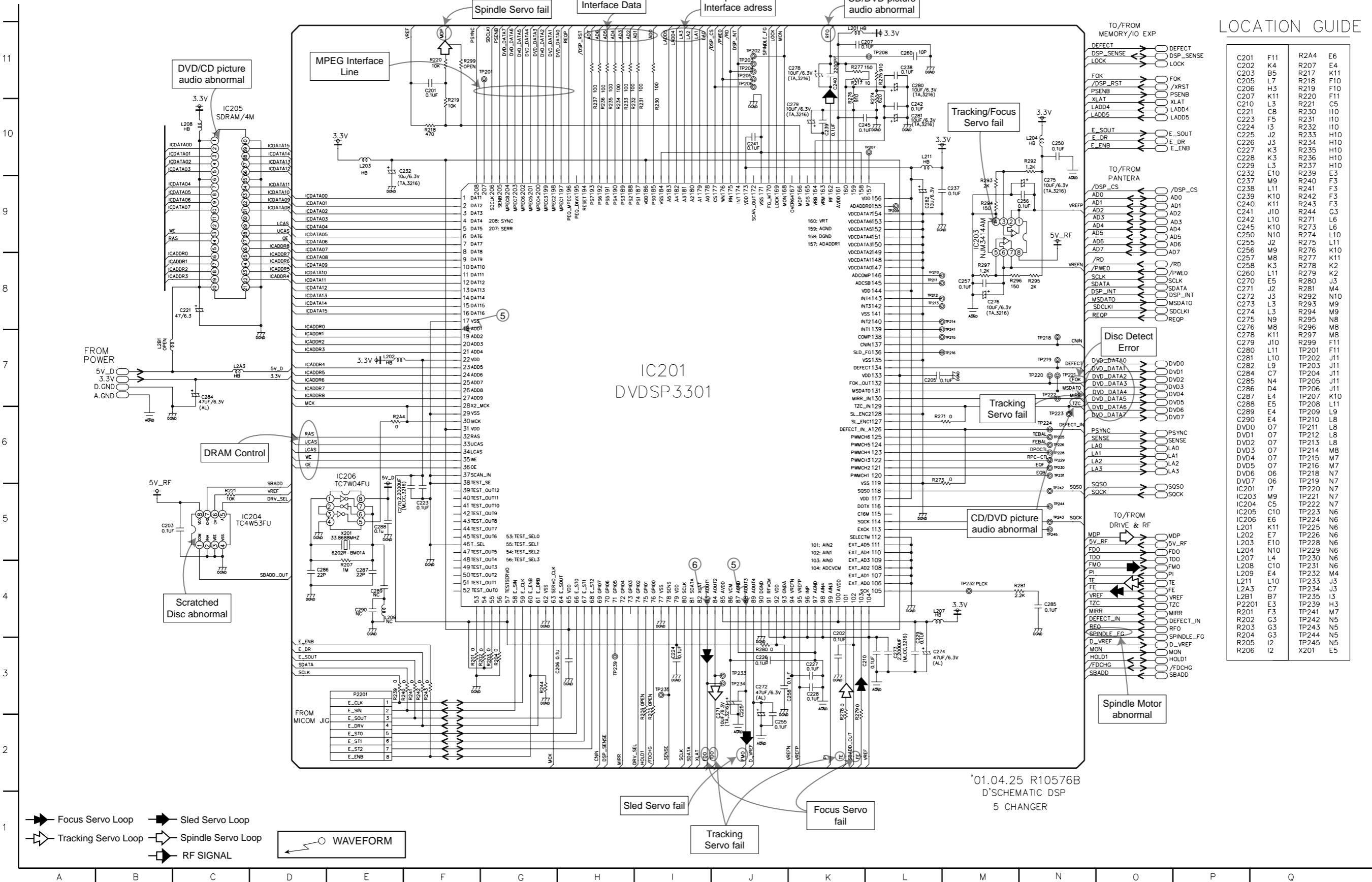

3. DRIVE & RF CIRCUIT DIAGRAM

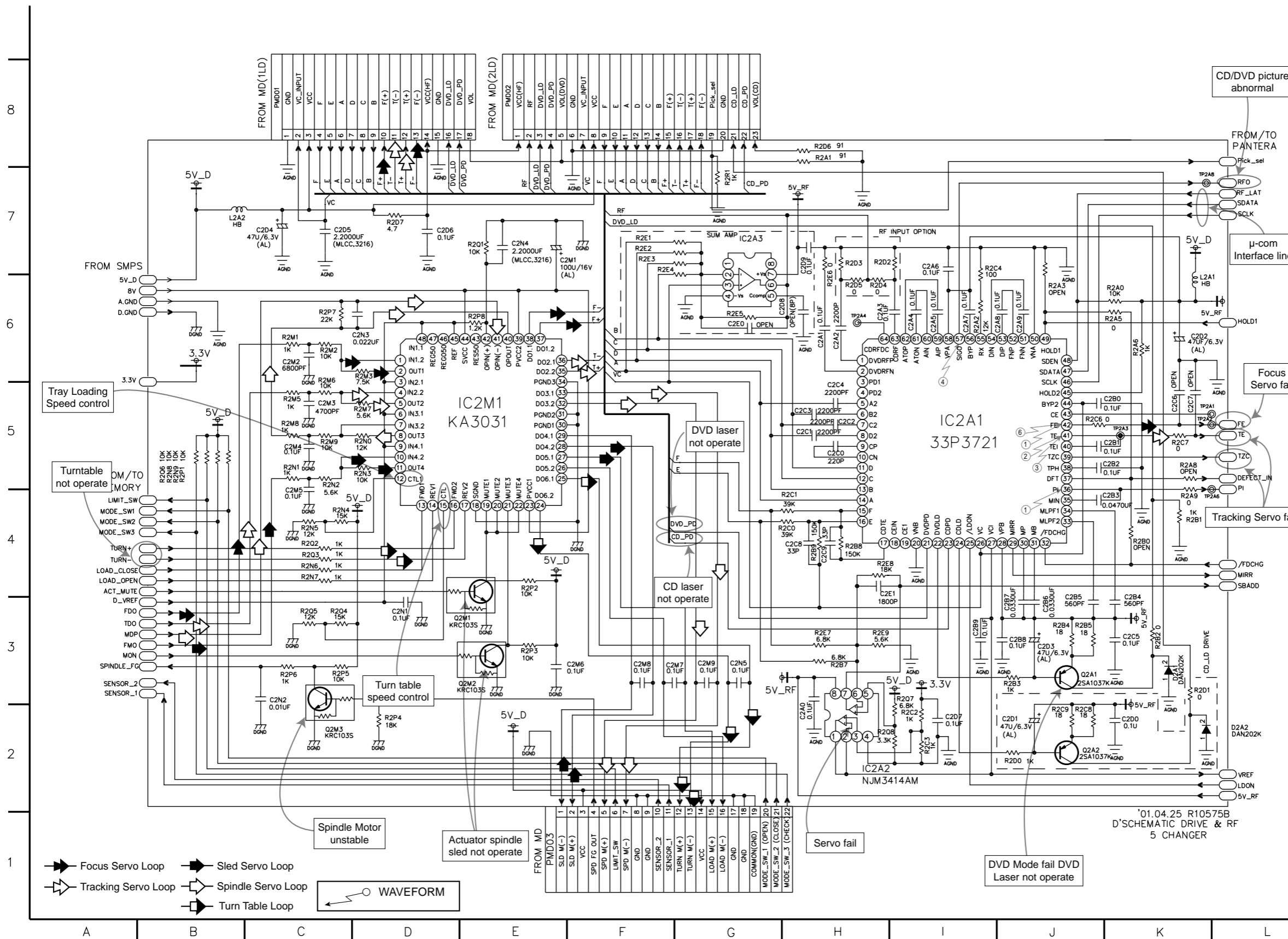

LOCATION GUIDE

C2A0	H2	D2A2	L2	R2M7	D5
C2A1	H6	IC2A1	I5	R2M8	C5
C2A2	H6	IC2A2	H2	R2M9	C5
C2A3	H6	IC2A3	G7	R2N0	D5
C2A4	I6	IC2M1	E5	R2N1	C5
C2A5	I6	L2A1	K6	R2N2	C5
C2A6	I7	L2A2	B7	R2N3	D5
C2A7	I6	Q2A1	J3	R2N4	C4
C2A8	J6	Q2A2	J2	R2N5	C4
C2A9	J6	Q2M1	D3	R2N6	C4
C2B0	K5	Q2M2	D3	R2N7	C4
C2B1	K5	Q2M3	C2	R2N8	B5
C2B2	J5	R2A0	K6	R2N9	B5
C2B3	K4	R2A1	H8	R2P1	B5
C2B4	J3	R2A2	I6	R2P2	E4
C2B5	J3	R2A3	J6	R2P3	E3
C2B6	J3	R2A5	K6	R2P4	D2
C2B7	J3	R2A6	K6	R2P5	C3
C2B8	I3	R2A8	K5	R2P6	C3
C2B9	I3	R2A9	K4	R2P7	C6
C2C0	H5	R2B0	K4	R2P8	E6
C2C1	H5	R2B1	K4	R2Q1	E7
C2C2	H5	R2B2	K3	R2Q2	C4
C2C3	H5	R2B3	J3	R2Q3	C4
C2C4	H5	R2B4	J3	R2Q4	C3
C2C5	K3	R2B5	J3	R2Q5	C3
C2C6	K5	R2B7	H3	R2Q6	B5
C2C7	K5	R2B8	H4	R2Q7	I3
C2C8	H4	R2B9	H4	R2Q8	H2
C2C9	H4	R2C0	G4	R2R1	G7
C2D0	K2	R2C1	H4	TP2A1	K5
C2D1	J2	R2C2	I2	TP2A2	K5
C2D2	K6	R2C3	I2	TP2A3	K5
C2D3	J3	R2C4	I7	TP2A4	H6
C2D4	C7	R2C6	J5	TP2A6	K4
C2D5	C7	R2C7	K5	TP2A8	K7
C2D6	D7	R2C8	J2	TZC	L5
C2D7	I2	R2C9	J2	VC	F7
C2D8	H6	R2D0	J2	VC	F6
C2D9	H7	R2D1	K3	VC	C7
C2E0	G6	R2D2	H7	VREF	L2
C2E1	H4	R2D3	H7		
C2M1	E7	R2D4	H6		
C2M2	C6	R2D5	H6		
C2M3	C5	R2D6	H8		
C2M4	C5	R2D7	D7		
C2M5	C4	R2E1	F7		
C2M6	F3	R2E2	F7		
C2M7	F3	R2E3	F7		
C2M8	F3	R2E4	F7		
C2M9	G3	R2E5	G6		
C2N1	D3	R2E6	H6		
C2N2	C3	R2E7	H3		
C2N3	D6	R2E8	H4		
C2N4	E7	R2E9	H3		
C2N5	G7	R2M1	C6		
CD_PD	G3	R2M2	C6		
D.GND	A6	R2M5	C5		
D2A1	K3	R2M6	C5		

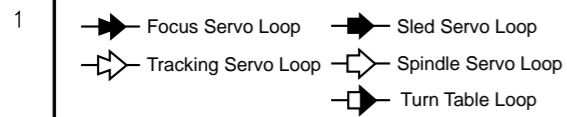

'01.04.25 R10575B
D'SCHEMATIC DRIVE & RF
5 CHANGER

4. PANTERA CIRCUIT DIAGRAM

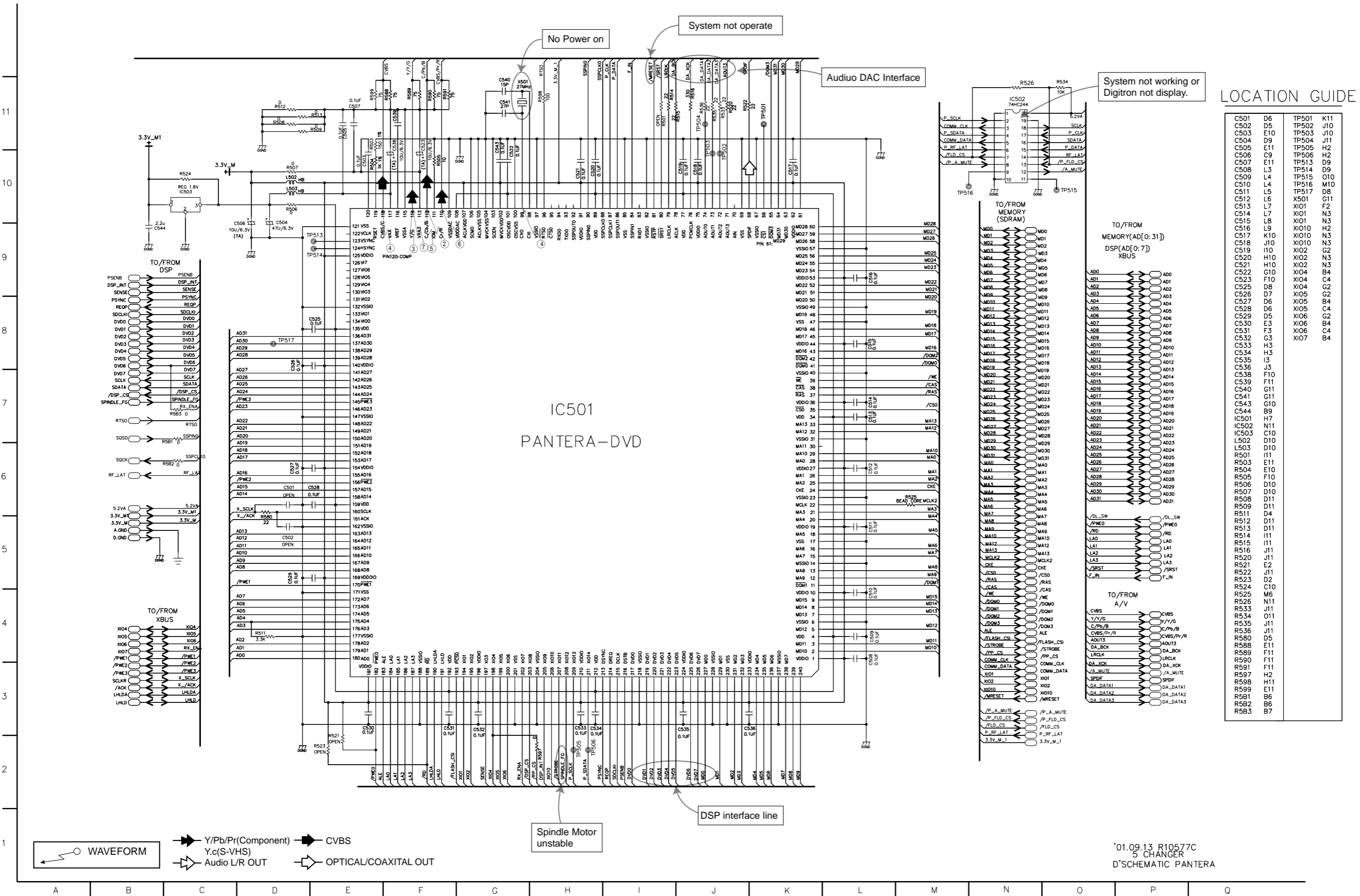

• WAVEFORMS

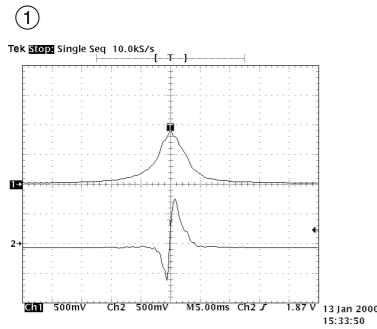

IC2A1 Pin 42, Focus Error
IC2A1 Pin 36, Pi

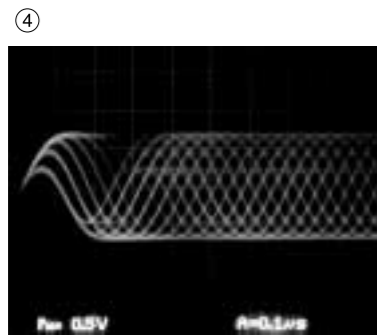

IC2A1 Pin 57, RF

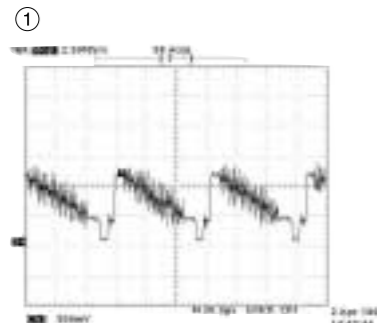

IC501 Pin 118, Composite

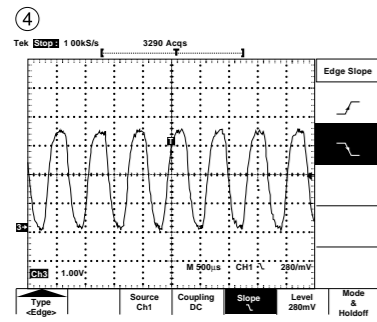

IC501 Pin 99, PANTER MAIN

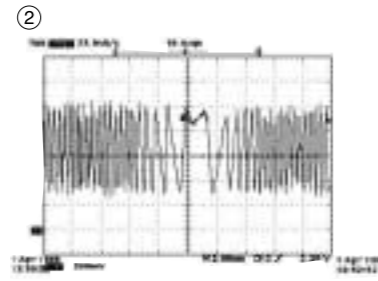

IC2A1 Pin 41 Tracking Error

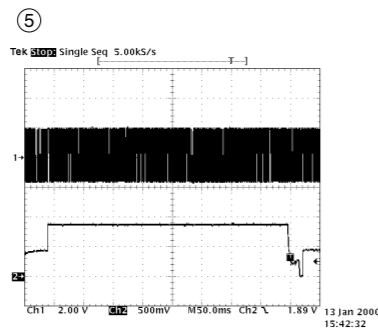

IC201 Pin 88, SLED Drive(FMO)
IC201 Pin 18, SLED FG

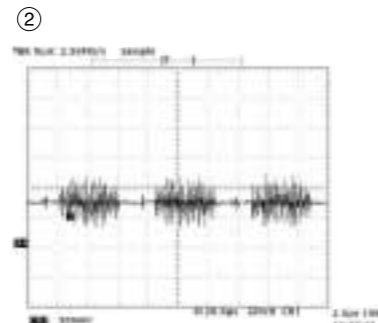

IC501 Pin 112, Chrominance (Super video out Mode)

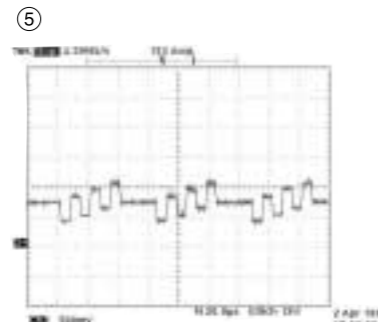

IC501 Pin 112 Component Pb

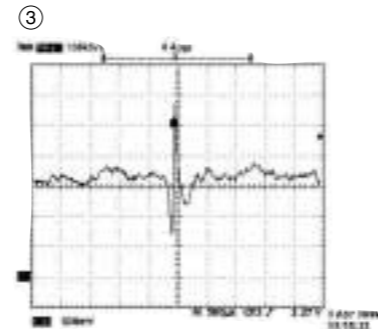

IC2A1 Pin 41 VBR TRACKING Error

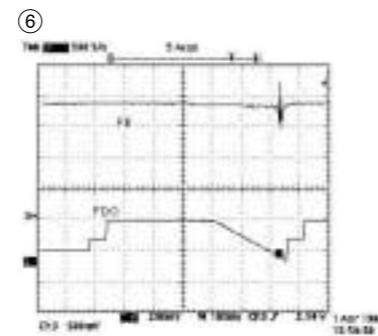

IC2A1 Pin42, Focus Error(in Focus Search)
IC201 Pin 83, Focus Drive(FDO)

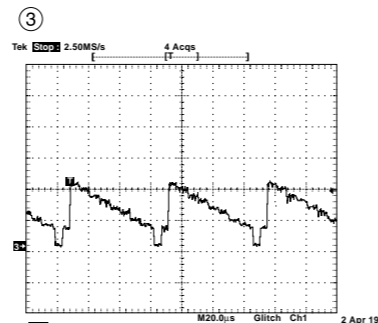

IC501 Pin 114, Luminance (Super video out Mode)

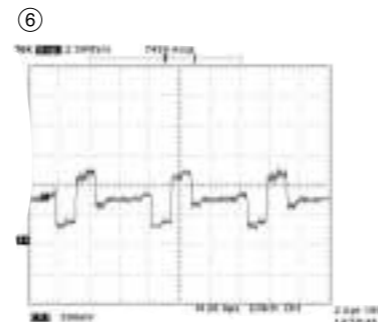

IC501 Pin 110 Component Pr

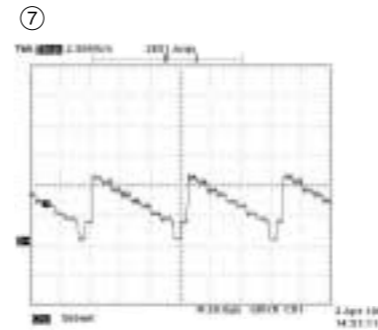

IC501 Pin 114 Component Y

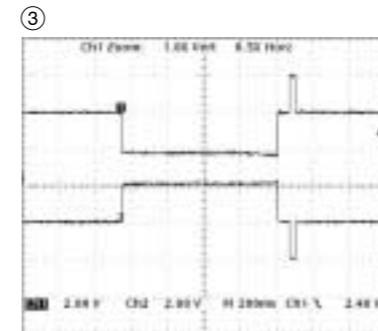

TURN(+)(-) from Motor Drive Reverse turn

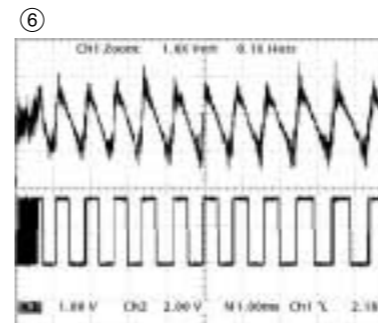

TE/TZC Before tracking servo ON

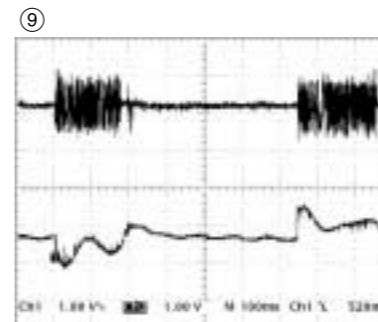

TE/SLD(+) Search mode (outer & inner)

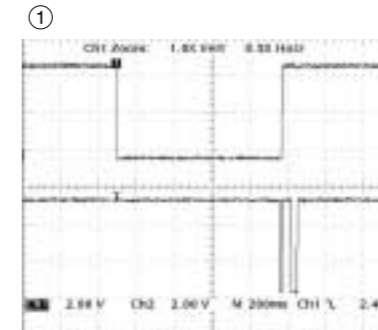

TURN(+)(-) Signal from μ-com

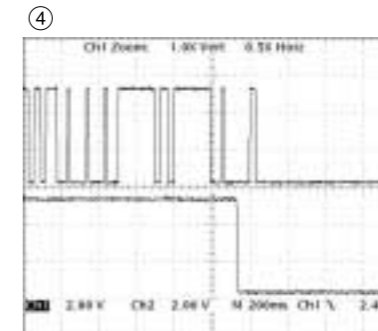

Sensor 1 (disc position)
Sensor 2 (disc ready)

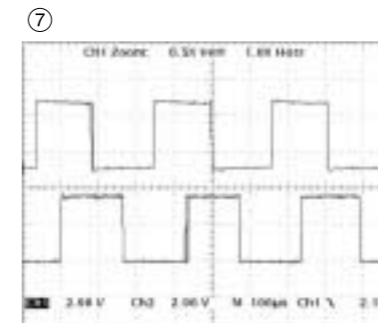

TZC/MIRR (Search mode)

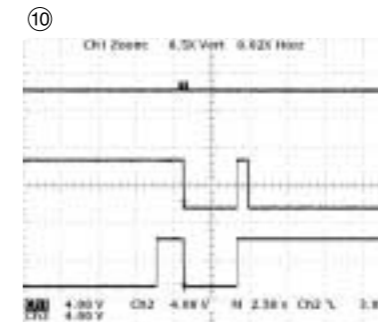

Tray open Tray closed

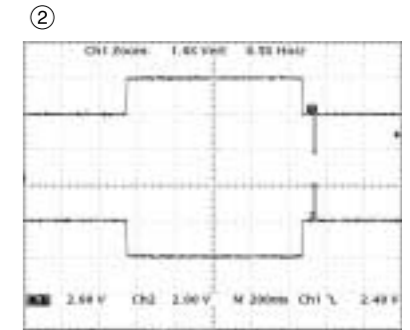

TURN(+)(-) from Motor Drive Forward turn

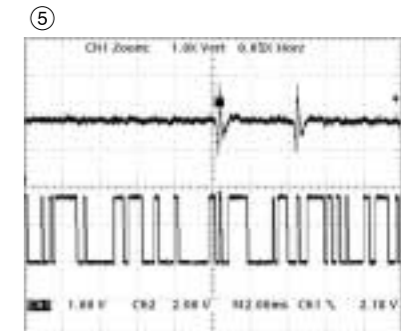

TE/TZC After tracking servo ON (Play mode)

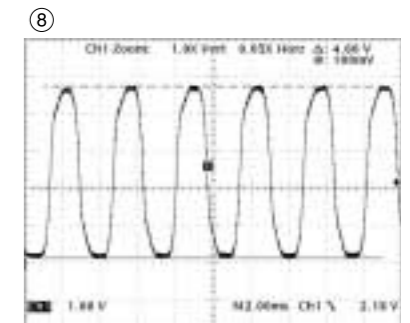

FG Signal from M/D (Play mode)

5. MEMORY CIRCUIT DIAGRAM

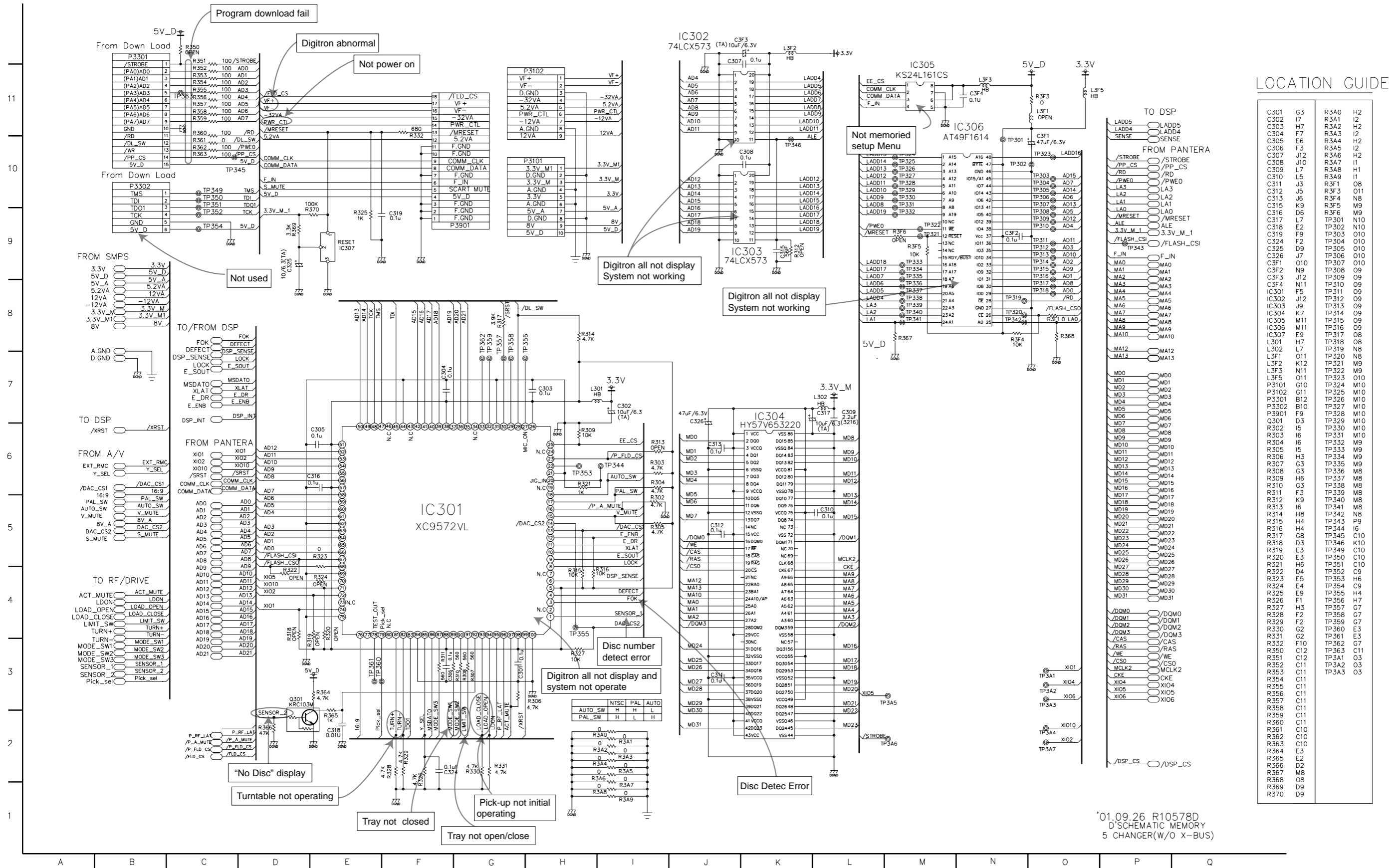

LOCATION GUIDE

C301	G3	R3A0	H2
C302	I7	R3A1	I2
C303	H7	R3A2	H2
C304	F7	R3A3	I2
C305	E6	R3A4	H2
C306	F3	R3A5	I2
C307	J2	R3A6	I1
C308	I0	R3A7	H1
C309	L7	R3A8	H1
C310	L5	R3A9	I1
C311	J3	R3F1	O8
C312	J5	R3F3	O11
C313	J6	R3F4	N8
C315	K9	R3F5	M9
C316	D6	R3F6	M9
C317	L7	TP301	N10
C318	E2	TP302	N10
C319	F9	TP303	O10
C324	F2	TP304	O10
C325	D9	TP305	O10
C326	J7	TP306	O10
C327	O10	TP307	O10
C328	N9	TP308	O10
C329	J12	TP309	O9
C330	N11	TP310	O9
C331	F5	TP311	O9
C332	J2	TP312	O9
C333	K7	TP313	O9
C334	J9	TP314	O9
C335	M11	TP315	O9
C336	M11	TP316	O9
C337	E9	TP317	O8
C338	L7	TP318	O8
C339	L7	TP319	N8
C340	H2	TP320	N8
C341	K12	TP321	N8
C342	O11	TP322	M9
C343	N10	TP323	O10
C344	G11	TP324	M10
C345	B12	TP325	M10
C346	B12	TP326	M10
C347	F10	TP327	M10
C348	B10	TP328	M10
C349	D3	TP329	M10
C350	I5	TP330	M10
C351	I6	TP331	M10
C352	I6	TP332	M9
C353	I5	TP333	M9
C354	H3	TP334	M9
C355	G3	TP335	M9
C356	H3	TP336	M8
C357	H6	TP337	M8
C358	G3	TP338	M8
C359	K9	TP339	M8
C360	K9	TP340	M8
C361	I6	TP341	M8
C362	H8	TP342	N8
C363	H4	TP343	P9
C364	H4	TP344	I6
C365	G8	TP345	C10
C366	D3	TP346	C10
C367	G3	TP347	C10
C368	E3	TP348	C10
C369	F1	TP349	C10
C370	F2	TP350	C10
C371	H6	TP351	C10
C372	E4	TP352	C9
C373	E5	TP353	H6
C374	E4	TP354	C9
C375	E9	TP355	H4
C376	F1	TP356	H7
C377	H3	TP357	G7
C378	F2	TP358	G7
C379	F2	TP359	G7
C380	G2	TP360	E3
C381	G2	TP361	E3
C382	F10	TP362	G7
C383	C12	TP363	C11
C384	C12	TP364	C11
C385	C11	TP365	C11
C386	C12	TP366	D2
C387	M8	TP367	M8
C388	O8	TP368	O8
C389	D9	TP369	D9
C390	D9	TP370	D9

'01.09.26 R10578D
D'SCHEMATIC MEMORY
5 CHANGER(W/O X-BUS)

6. TIMER & KEY CIRCUIT DIAGRAM

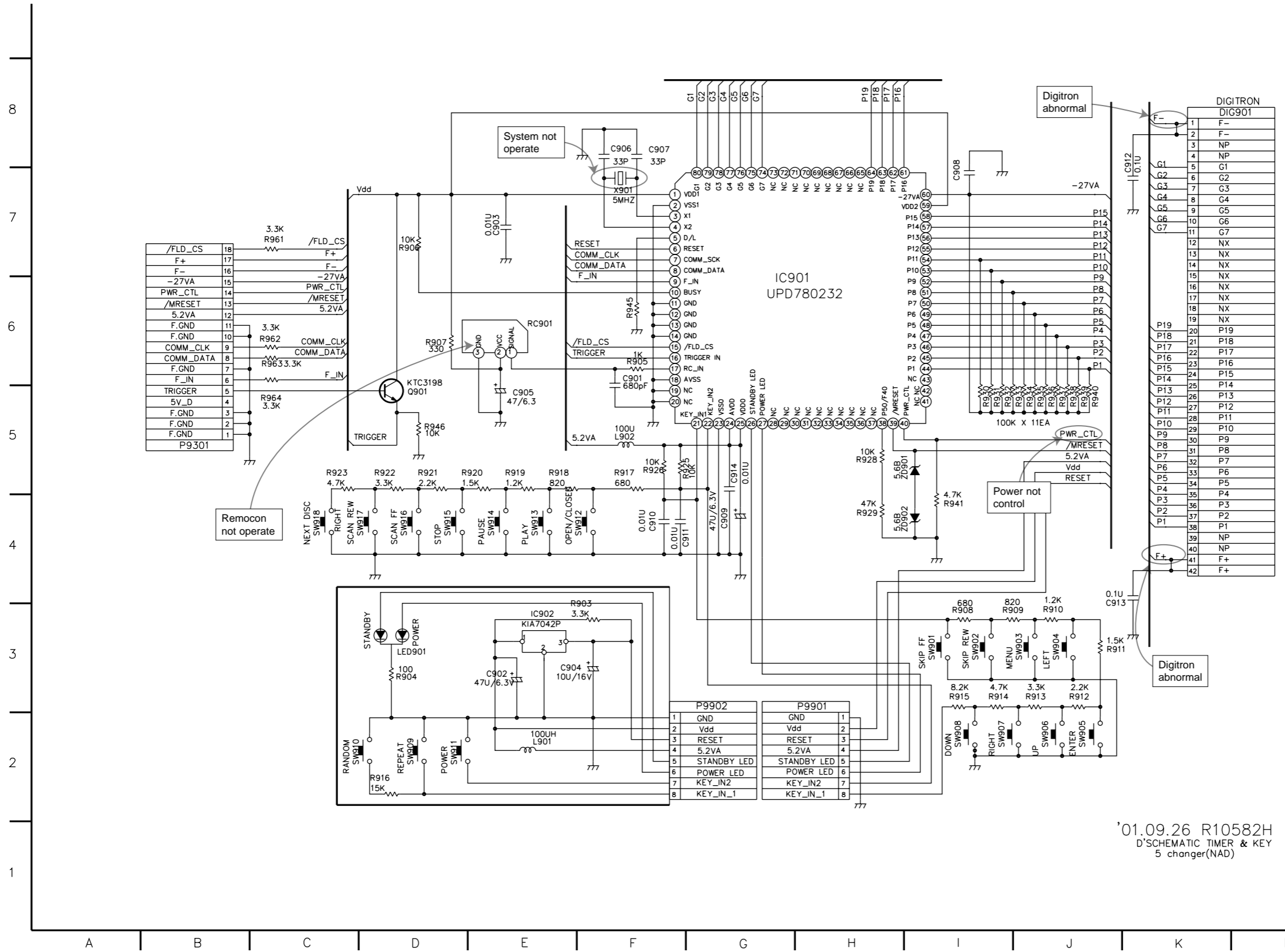

LOCATION GUIDE

C901	F6	RESET	E7
C902	E3	RESET	J5
C903	E7	SW901	I3
C904	E3	SW902	I3
C905	E5	SW903	J3
C906	F8	SW904	J3
C907	F8	SW905	J2
C908	I7	SW906	J2
C909	G4	SW907	I2
C910	F4	SW908	I2
C911	G4	SW909	D2
C912	K7	SW910	C2
C913	J3	SW911	D2
C914	G5	SW912	F4
DIG901	K8	SW913	E4
IC901	G6	SW914	E4
IC902	E3	SW915	D4
L901	E2	SW916	D4
L902	F5	SW917	D4
LED901	D3	SW918	C4
P9301	B5	X901	F7
P9901	H3	ZD901	I5
P9902	G3	ZD902	I4
Q901	D5		
R903	E3		
R904	D3		
R905	F6		
R906	D7		
R907	D6		
R908	I3		
R909	I3		
R910	J3		
R911	J3		
R912	J3		
R913	J3		
R914	I3		
R915	I3		
R916	D2		
R917	F5		
R918	E5		
R919	E5		
R920	D5		
R921	D5		
R922	D5		
R923	C5		
R925	G5		
R926	F5		
R928	H5		
R929	H4		
R930	I5		
R931	I5		
R932	I5		
R933	J5		
R934	J5		
R935	J5		
R936	J5		
R937	J5		
R938	J5		
R939	J5		
R940	J5		
R941	I4		
R945	F6		
R946	D5		
R961	C7		
R962	C6		
R963	C6		
R964	C5		
RC901	E6		

'01.09.26 R10582H
D'SCHEMATIC TIMER & KEY
5 changer(NAD)

7. AV CIRCUIT DIAGRAM

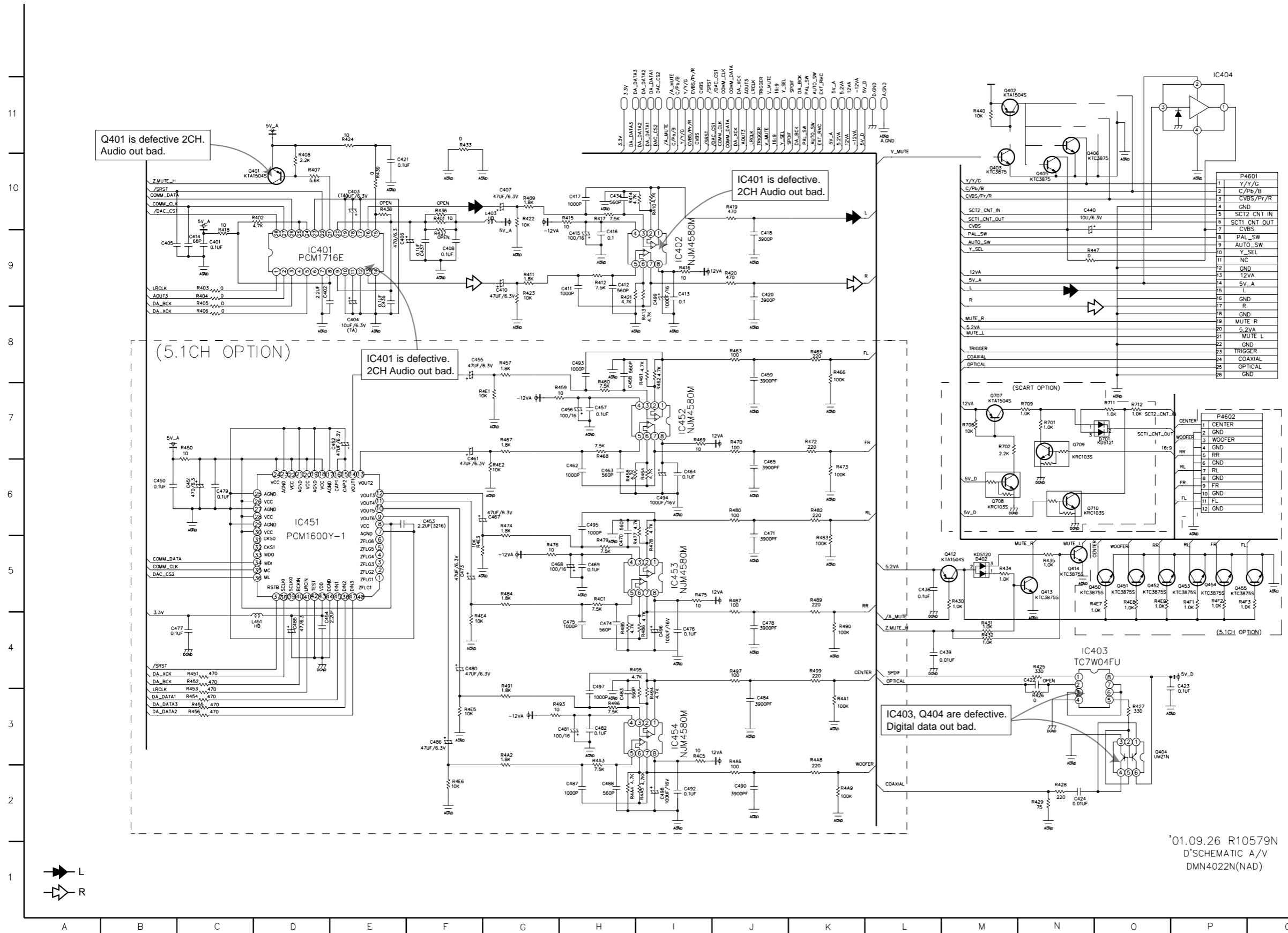

LOCATION GUIDE

C401	C9	Q401	C10	R466	K8
C402	D9	Q402	M11	R467	G7
C403	E10	Q403	M10	R468	H7
C404	E8	Q404	O3	R469	I7
C405	B9	Q405	N10	R470	J7
C406	E9	Q406	N10	R472	K7
C407	G10	Q407	N11	R473	K6
C408	F9	Q408	O11	R474	O6
C410	G9	Q412	M5	R475	I5
C411	H9	Q413	N5	R476	G5
C412	H9	Q414	N5	R477	I5
C413	I9	Q450	N5	R478	I5
C414	C9	Q451	O5	R479	H5
C415	H9	Q452	O5	R480	J6
C416	H9	Q453	P5	R482	K5
C417	H10	Q454	P5	R483	K5
C418	J9	Q455	P5	R484	G5
C420	J9	Q707	M7	R485	H4
C421	E10	Q708	M6	R486	I4
C422	N4	Q709	N7	R487	J5
C423	P4	Q710	N6	R489	K5
C424	N2	R401	F10	R490	K4
C434	H10	R402	C10	R491	G4
C436	E8	R403	C9	R493	G3
C437	F9	R404	C9	R494	I3
C438	L5	R405	C9	R495	H4
C439	L4	R406	C8	R496	H3
C440	N10	R407	D10	R497	J4
C448	B6	R408	D10	R498	K4
C452	E7	R409	G10	R499	K3
C453	F6	R410	I10	R4A2	G3
C454	D4	R411	G9	R4A3	H3
C455	F8	R412	H9	R4A4	H2
C456	H7	R413	I8	R4A5	I2
C457	H7	R414	H10	R4A6	J3
C458	H7	R415	H10	R4A8	K3
C459	I8	R416	I9	R4A9	K2
C461	F6	R417	H10	R4C1	H5
C462	H6	R418	C9	R4C5	I3
C463	H6	R419	J10	R4E1	F7
C464	I6	R420	J9	R4E2	G6
C465	J6	R421	H9	R4E3	F5
C467	G6	R422	G10	R4E4	F4
C469	H5	R424	E11	R4E6	F2
C470	H5	R425	N4	R4E7	N5
C471	J6	R426	N3	R4E8	O5
C473	F5	R427	O3	R4E9	O5
C474	H4	R428	N2	R4F1	P5
C475	H4	R429	N2	R4F2	P5
C476	E4	R430	M5	R4F3	P5
C477	B4	R431	M4	R701	N7
C478	J4	R432	M4	R702	M7
C479	C6	R433	F11	R708	M7
C480	F4	R434	M5	R709	N7
C481	G3	R435	N5	R711	O7
C482	H3	R436	F10	R712	O7
C483	H3	R437	F9		
C484	J3	R438	E10		
C485	D4	R439	E10		
C486	F3	R440	M11		
C487	H2	R441	M11		
C488	H2	R442	M11		
C490	J2	R443	N11		
C492	I2	R444	N11		
C493	H8	R445	N11		
C494	I6	R446	N10		
C495	H6	R447	N9		
C496	I4	R450	C7		
C497	H4	R451	C4		
C498	I2	R452	C4		
C499	I9	R453	C3		
IC401	O9	R454	C3		
IC402	I9	R455	C3		
IC403	N4	R456	C3		
IC404	P11	R457	G8		
IC451	D6	R458	H6		
IC452	I7	R459	G7		
IC453	I5	R460	H7		
IC454	I3	R461	I7		
L403	G10	R462	I7		
L451	C4	R463	J8		
D402	M5	R464	I6		
D701	O7	R465	K8		

'01.09.26 R10579N
D'SCHEMATIC A/V
DMN4022N(NAD)

8. A/V JACK CIRCUIT DIAGRAM

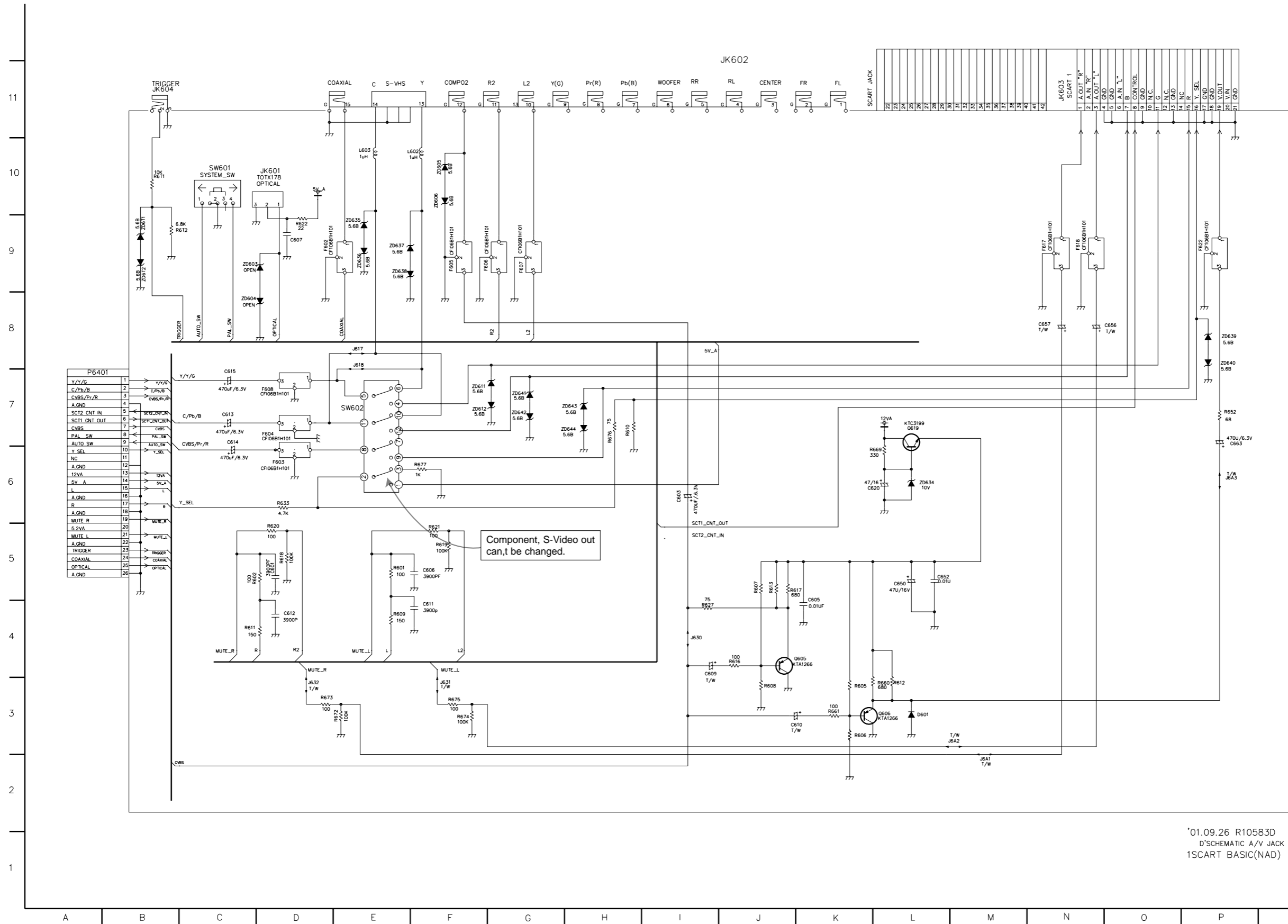

'01.09.26 R10583D
 D'SCHEMATIC A/V JACK
 1SCART BASIC(NAD)

• CIRCUIT VOLTAGE CHART

MODE PIN NO.	LEVEL(V)
PANTERA IC 501	
1	3.18
2	1.3
3	1.4
4	2.2
5	1.5
6	0
7	1.5
8	1.4
9	1.6
10	3.1
11	0.7
12	0.15
13	0.15
14	0
15	0
16	1.7
17	1.4
18	0
19	1.5
20	1.6
21	0
22	1.6
23	0
24	3.1
25	1.7
26	1.4
27	3.1
28	1.5
29	0.15
30	
31	0
32	0.7
33	1.5
34	2.2
35	2
36	3.1
37	2.9
38	2.2
39	2.9
40	0
41	0
42	0
43	1.6
44	3.1
45	1.6
46	1.5
47	0
48	1.4
49	0
50	1.5
51	1.7
52	1.2
53	3.1

MODE PIN NO.	LEVEL(V)
54	1.6
55	1.4
56	1.5
57	0
58	1.6
59	1.4
60	1.5
61	1.4
62	3.1
63	1
64	1.5
65	0.005
66	0.5
67	0.003
68	1.58
69	0
70	3.1
71	1.2
72	1.2
73	1.2
74	1.2
75	3.1
76	1.65
77	2.2
78	1.5
79	1.5
80	3.1
81	3.1
82	0.001
83	3.1
84	3.7
85	0
86	
87	3.1
88	3.1
89	2.1
90	0.004
91	3.1
92	0
93	
94	
95	
96	
97	0
98	
99	
100	0
101	2.1
102	3.1
103	0
104	0
105	0
106	0
107	2.1
108	2.1

MODE PIN NO.	LEVEL(V)
109	0
110	0.8
111	0.9
112	1.3
113	3.1
114	0.78
115	0
116	1.26
117	2.38
118	0.08
119	1.2
120	2
121	0
122	3.1
123	3.1
124	3.1
125	3.1
126	
127	
128	
129	
130	
131	
132	0
133	
134	
135	2.2
136	
137	3.1
138	3.1
139	3.1
140	3.1
141	3.1
142	3.1
143	3.1
144	3.1
145	3.1
146	3.1
147	0
148	3.1
149	3.1
150	3.1
151	3.1
152	3.1
153	3.1
154	3.1
155	3.1
156	3.1
157	3.1
158	3.1
159	2.2
160	1.5
161	3.1
162	
163	0

MODE PIN NO.	LEVEL(V)
164	3.1
165	3.1
166	3.1
167	3.1
168	3.1
169	3.1
170	3.1
171	0
172	3.1
173	3.1
174	3.1
175	1.5
176	3.1
177	0
178	3.1
179	3.1
180	3.1
181	3.1
182	3.18
183	0.086
184	3
185	2.4
186	2.3
187	0
188	0
189	3.1
190	0
191	0.017
192	2.2
193	3.1
194	3.1
195	0
196	3.18
197	1.3
198	3.1
199	3.1
200	3.1
201	0
202	2.3
203	3.1
204	0.001
205	3.1
206	3.1
207	3.1
208	1.6
209	3.1
210	3.18
211	0.018
212	2.2
213	3.19
214	2.69
215	1.5
216	2.9
217	2.59
218	0

MODE PIN NO.	LEVEL(V)
219	2.29
220	2.08
221	2.29
222	2.29
223	2.49
224	3.1
225	2.39
226	2.45
227	1.5
228	0
229	1.52
230	0
231	1.61
232	1.6
233	3.1
234	1.6
235	1.6
236	1.5
237	0
238	1.6
239	1.4
240	1.5

MODE PIN NO.	LEVEL(V)
MEMORY IC 301	
1	4.3
2	
3	3.1
4	0
5	3.2
6	2
7	
8	3.1
9	0.01
10	3.1
11	3.2
12	3.2
13	3.2
14	3.2
15	0
16	3.1
17	3.1
18	3.1
19	
20	0
21	0
22	0
23	3
24	
25	0.625
26	3.2
27	0.705
28	3.2
29	3.1
30	
31	0
32	
33	
34	
35	3.1
36	3.1
37	2.39
38	3.2
39	1.49
40	1.5
41	3.09
42	1.69
43	0
44	3.1
45	
46	3.1
47	
48	2.5
49	3.1
50	3.1
51	3.2
52	3.1
53	3.1

MODE PIN NO.	LEVEL(V)
54	3.1
55	3.1
56	3.1
57	3.1
58	3.1
59	3.1
60	3.1
61	0.5
62	0
63	3.1
64	3.1
65	3.1
66	3.1
67	3.1
68	1.6
69	0
70	0
71	3.1
72	0
73	
74	3.1
75	0
76	3.2
77	0
78	3.1
79	0.3
80	
81	0
82	0
83	2.5
84	0
85	3.19
86	3.19
87	4.4
88	3.19
89	4.4
90	0
91	4.4
92	0
93	0
94	0
95	0
96	0
97	3.17
98	3.17
99	3.1
100	0

MODE PIN NO.	EE	PLAY
D S P IC201 SP3301		
1	2.00	1.30
2	2.00	1.30
3	2.00	1.30
4	2.00	1.30
5	2.00	1.30
6	2.00	1.30
7	2.00	1.30
8	2.00	1.30
9	2.00	1.30
10	2.00	1.30
11	2.00	1.30
12	2.00	1.30
13	2.00	1.30
14	2.00	1.30
15	2.00	1.30
16	2.00	1.30
17	0.00	0.00
18	0.00	1.50
19	0.00	1.50
20	0.00	1.50
21	0.00	1.50
22	3.10	3.00
23	0.00	1.50
24	0.00	1.50
25	0.00	1.50
26	0.00	1.50
27	0.00	1.50
28	2.10	1.50
29	0.00	0.00
30	2.10	2.00
31	3.10	3.00
32	3.10	1.50
33	3.10	2.50
34	3.10	2.50
35	2.10	1.30
36	1.10	1.80
37	0.00	0.00
38	0.00	0.00
39	0.00	0.00
40	3.10	3.00
41	0.00	0.00
42	3.10	3.00
43	0.00	0.00
44	0.00	0.00
45	3.10	3.00
46	0.00	0.00
47	0.00	0.00
48	0.00	0.00
49	0.00	3.00
50	0.00	0.00
51	0.00	0.00
52	3.10	1.80
53	0.00	0.00

MODE PIN NO.	EE	PLAY
54	3.10	3.00
55	3.10	3.00
56	0.00	0.00
57	0.00	3.13
58	5.00	4.98
59	0.00	0.00
60	0.00	0.00
61	5.00	4.98
62	0.00	0.00
63	2.10	2.10
64	0.00	0.00
65	3.10	3.00
66	0.00	0.00
67	3.10	3.12
68	0.00	0.00
69	0.00	0.20
70	0.00	0.00
71	3.10	3.10
72	0.00	0.20
73	0.00	0.00
74	3.10	3.10
75	0.00	0.00
76	0.00	0.00
77	0.00	0.00
78	0.00	2.30
79	3.10	3.10
80	5.00	5.00
81	0.00	0.00
82	5.00	5.00
83	2.10	2.00
84	2.10	2.10
85	3.10	3.10
86	1.40	1.40
87	0.00	0.00
88	2.10	2.00
89	2.10	2.00
90	0.00	0.00
91	1.50	1.55
92	3.10	3.12
93	1.60	1.55
94	1.10	1.11
95	2.00	2.00
96	1.55	1.55
97	0.00	0.00
98	1.55	1.55
99	1.56	2.15
100	3.10	3.10
101	1.55	1.58
102	1.55	1.55
103	1.62	1.64
104	1.55	1.55
105	1.50	1.50
106	0.00	0.00
107	0.00	0.00
108	0.00	0.00

MODE PIN NO.	EE	PLAY
109	0.00	0.00
110	0.00	0.00
111	0.00	0.00
112	0.00	0.00
113	3.40	4.70
114	5.00	5.00
115	1.50	1.50
116	1.50	1.53
117	3.10	3.10
118	0.00	0.00
119	0.00	0.00
120	3.50	4.20
121	3.25	4.20
122	3.45	4.30
123	3.50	4.30
124	3.50	4.30
125	3.50	4.50
126	0.00	0.00
127	3.60	2.60
128	0.00	0.00
129	3.60	2.60
130	0.00	0.20
131	0.00	0.00
132	0.00	3.10
133	3.10	3.10
134	0.00	0.00
135	0.00	0.00
136	3.10	2.20
137	0.00	0.00
138	0.00	0.00
139	3.10	3.10
140	3.00	3.10
141	0.00	0.00
142	3.00	3.00
143	3.10	3.10
144	3.10	3.10
145	3.10	0.90
146	3.50	4.50
147	0.00	0.00
148	0.00	0.00
149	0.00	0.00
150	0.00	0.00
151	0.00	0.00
152	0.00	0.00
153	0.00	0.00
154		

2. AV JACK P.C.BOARD

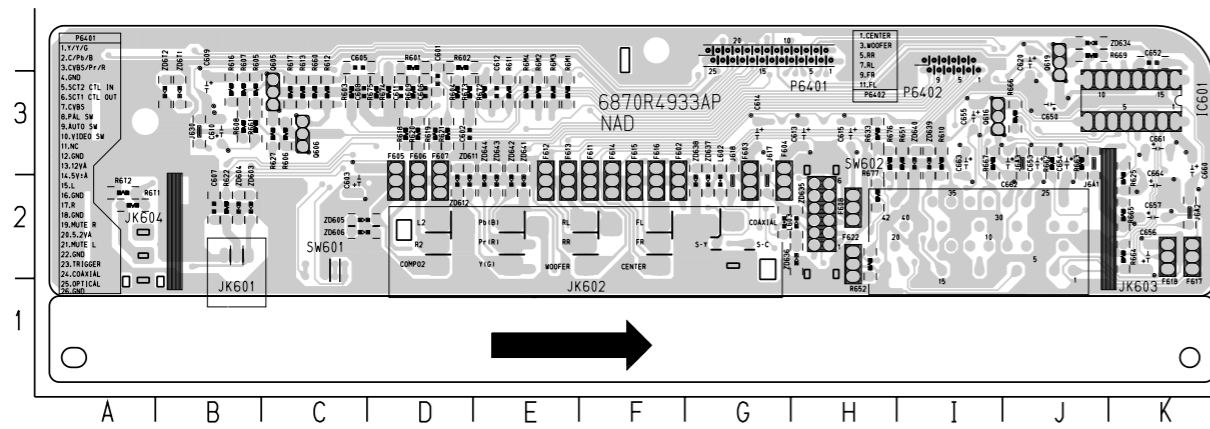

LOCATION GUIDE

CE91	D3	IC601	K3	RE52	H2
CE82	D3	JE17	Q2	RE60	C3
CE93	C2	JE18	Q2	RE61	B3
CE95	C4	JE30	B3	RE62	J3
CE96	D3	JE41	J3	RE63	J3
CE97	B2	JE42	K2	RE64	K2
CE98	C3	JE43	J3	RE65	K2
CE99	B3	JE61	B2	RE66	J2
CE10	B3	JE62	F2	RE67	J2
CE11	D3	JE63	J2	RE68	J2
CE12	E3	JE64	K2	RE72	E3
CE13	H3	LE32	Q2	RE73	D3
CE14	D3	LE63	Q2	RE74	D3
CE15	H3	PE41	M4	RE75	D3
CE20	J4	PE42	L4	RE76	H3
CE21	K4	QE05	C3	RE77	H3
CE22	K4	QE06	C3	RE78	E3
CE23	J3	QE15	I3	RE79	E3
CE24	J3	QE19	J4	RE83	E3
CE25	I3	RE01	D4	RE84	E3
CE26	K2	RE02	D4	RE11	A2
CE27	K2	RE03	C3	RE12	A2
CE28	K3	RE04	C3	SW61	C2
CE29	K3	RE05	B3	SW62	H2
CE30	J3	RE06	C3	ZS60	B2
CE31	I3	RE07	B3	ZS61	B2
CE32	K2	RE08	B3	ZS65	C2
FE02	F2	RE09	D3	ZS66	C2
FE03	D2	RE10	I3	ZS81	D2
FE04	D2	RE11	E3	ZS62	D2
FE05	I2	RE12	C3	ZS34	J4
FE06	D2	RE13	C3	ZS35	H2
FE07	D2	RE16	B3	ZS36	H2
FE08	M2	RE17	C3	ZS37	Q2
FE11	F2	RE18	D3	ZS38	Q2
FE12	E2	RE19	D3	ZS39	I2
FE13	E2	RE20	D3	ZS40	I3
FE14	F2	RE21	D3	ZS41	E2
FE15	F2	RE22	B2	ZS42	E2
FE16	F2	RE23	K2	ZS43	E2
FE17	M2	RE27	C3	ZS44	E2
FE18	K2	RE33	H3	ZS11	B3
FE22	H2	RE51	I3	ZS12	B3

3. SMPS P.C.BOARD

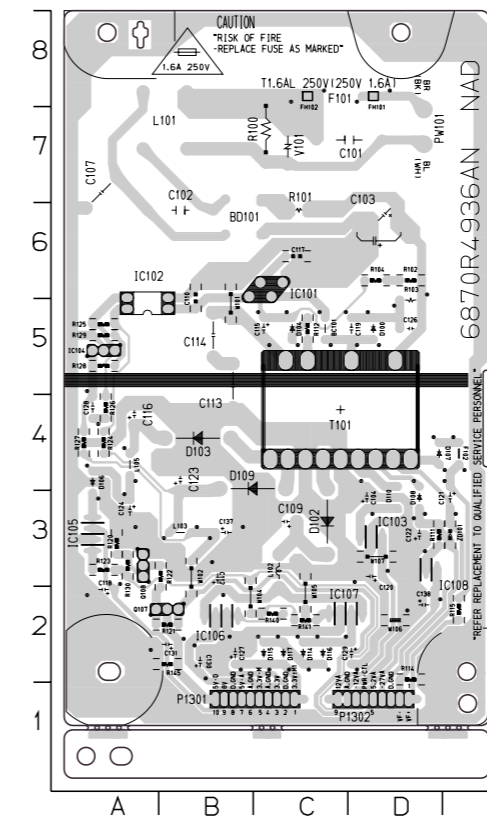

LOCATION GUIDE

BC101	C5	FH102	C8
BD101	B6	IC101	C6
C101	D7	IC102	A5
C102	B6	IC103	D3
C103	D6	IC104	A5
C104	D3	IC105	A3
C107	A7	IC106	B2
C109	C3	IC107	D2
C110	B6	IC108	D3
C112	B3	L101	B7
C113	B5	L102	C3
C114	B5	L103	B3
C115	C5	L105	A4
C116	A4	P1301	C1
C117	C6	P1302	D1
C118	A2	PW101	D7
C119	D5	Q107	B2
C120	D3	Q108	A3
C121	E3	R100	C7
C122	D3	R101	C6
C123	B4	R102	D6
C124	A3	R103	D5
C126	D5	R104	D6
C127	B2	R111	D3
C128	A4	R112	C5
C129	D2	R114	D2
C130	B2	R115	E2
C131	B2	R120	A3
C137	B3	R121	B2
C138	D2	R122	B3
D100	D5	R123	A3
D102	C3	R124	A4
D103	B4	R125	A5
D104	C5	R126	A4
D106	A4	R127	A4
D107	D4	R128	A5
D108	D3	R129	A5
D109	B4	R130	A3
D110	D3	R140	C2
D114	C2	R141	C2
D115	C2	R145	B2
D116	C2	T101	C4
D117	C2	V101	C7
F102	E4	ZD101	E3
FH101	D8		

4. FRONT P.C.BOARD

