

7.3. Amplifier Section

Notes: 1. Diode is 1SS53, 1S1555, or 1SS176 unless otherwise specified.
 2. Resistor and capacitor marked with * show typical value.

Notes: 1. 2SA733, 2SA6085P, 2SA1048 and 2SA1175 are interchangeable with each other.
 2. 2SC945, 2SC5365P, 2SC2458 and 2SC2785 are interchangeable with each other.

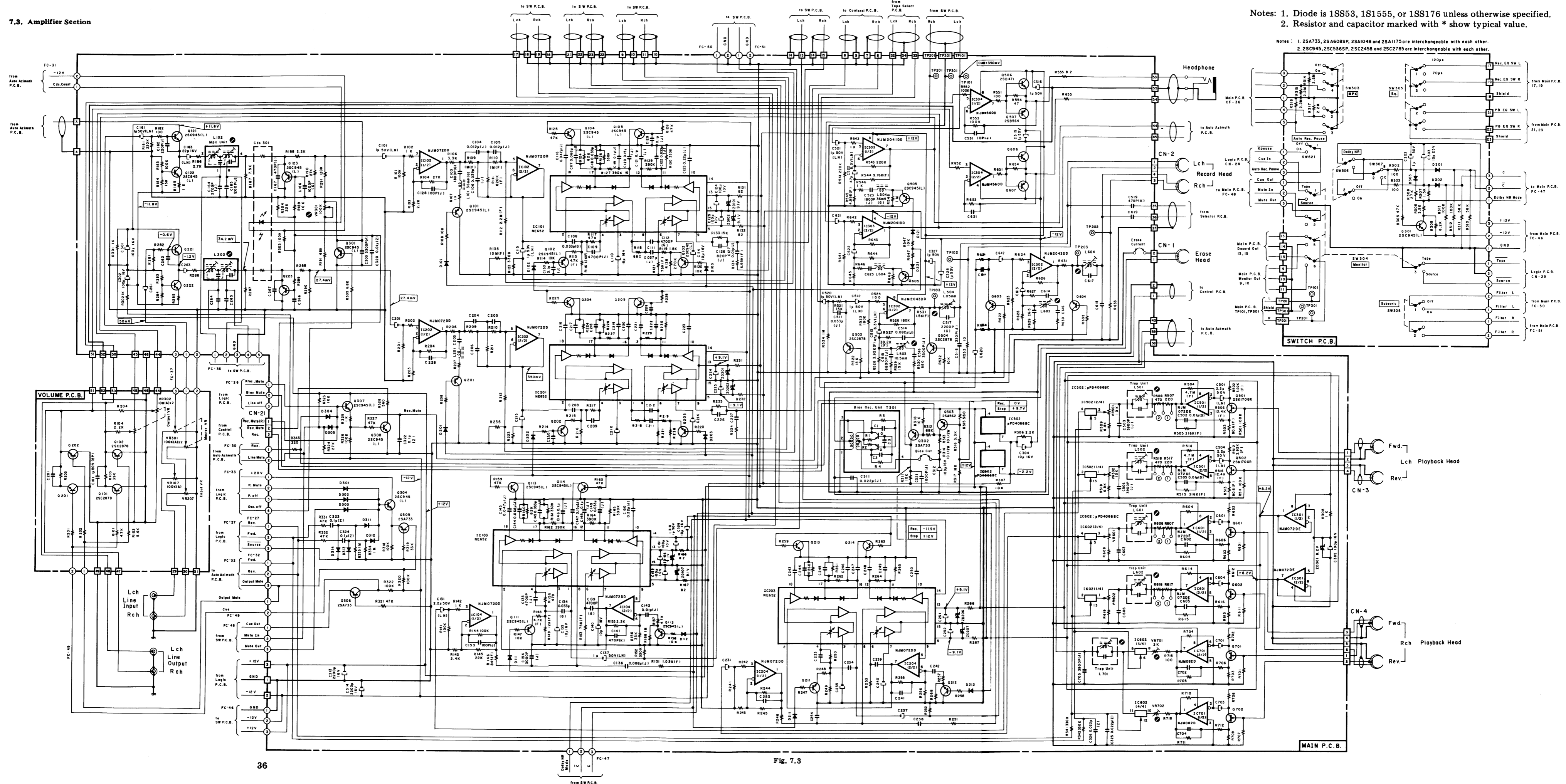
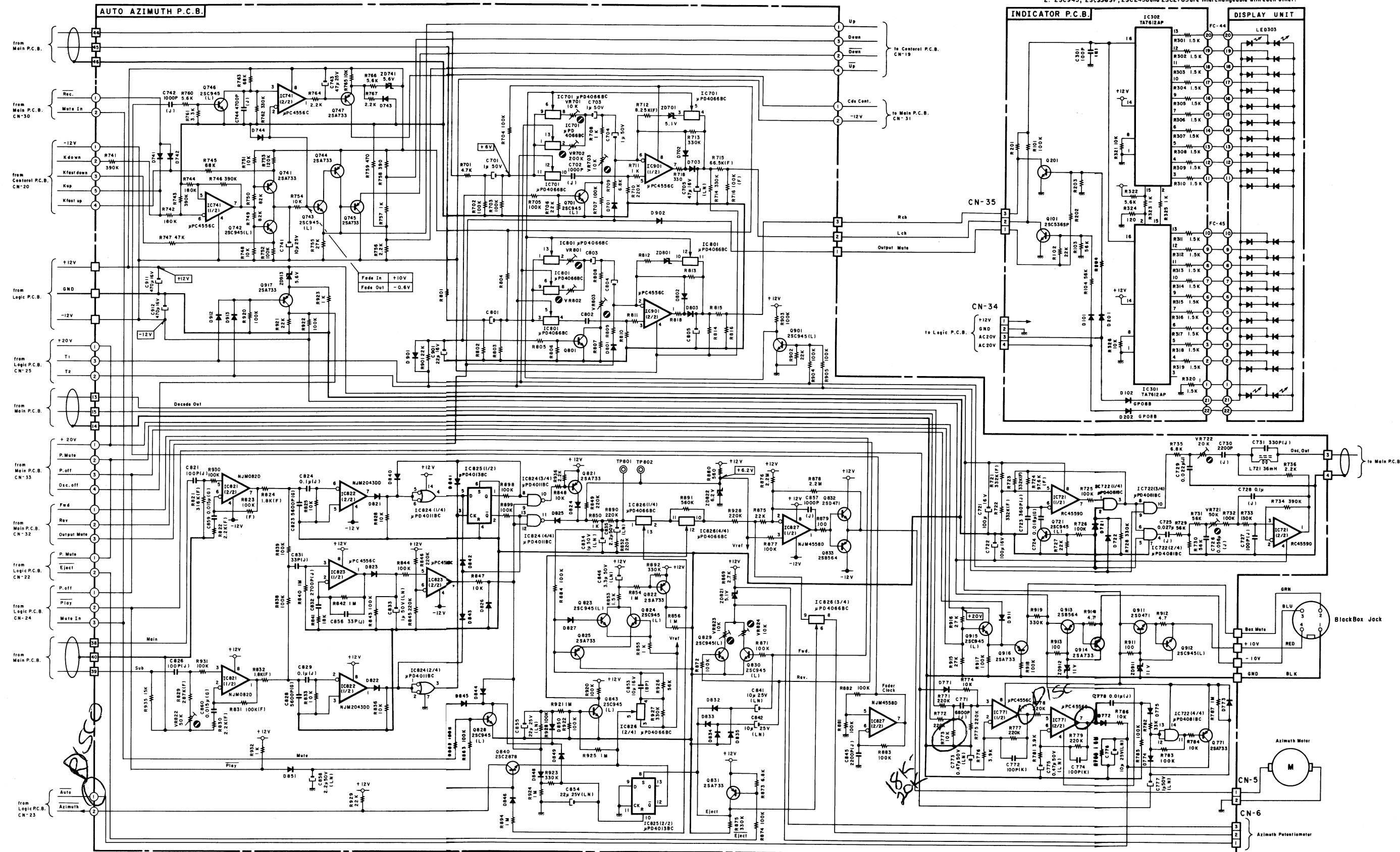

Fig. 7.3

7.4. Auto Azimuth Control Section



Notes: 1. 25A733, 25M068P, 25A1048 and 25A1175 are interchangeable with each other.
2. 25C945, 25C5365P, 25C24558 and 25C2785 are interchangeable with each other.

Notes: 1. Diode is 1SS53, 1S1555, or 1SS176 unless otherwise specified.
2. Resistor and capacitor marked with * show typical value.

Fig. 7.4

7.5. Mechanism Control Section

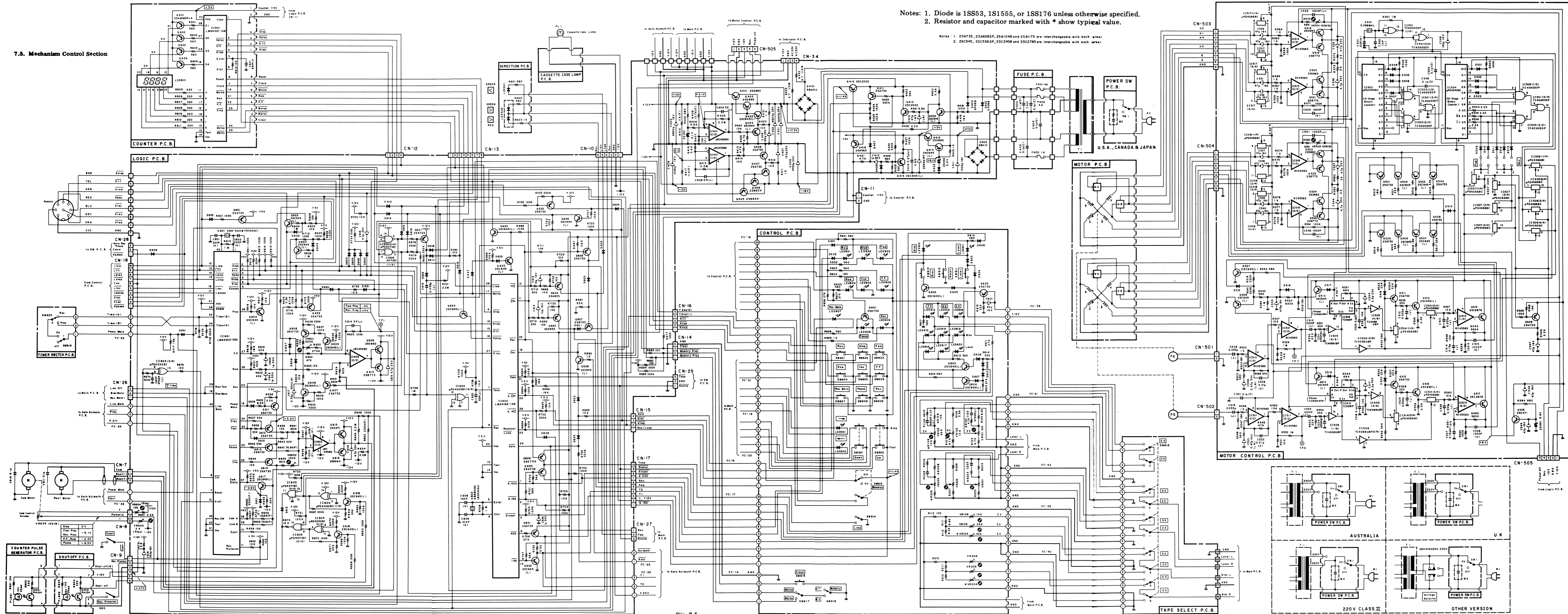

Notes: 1. Diode is 1SS53, 1S1555, or 1SS176 unless otherwise specified.
 2. Resistor and capacitor marked with * show typical value.

Notes: 1. 2S4733, 2S4608SP, 2S4104B and 2S4117S are interchangeable with each other.
 2. 2S0945, 2S0356SP, 2S0245B and 2S0278S are interchangeable with each other.

Fig. 7.5

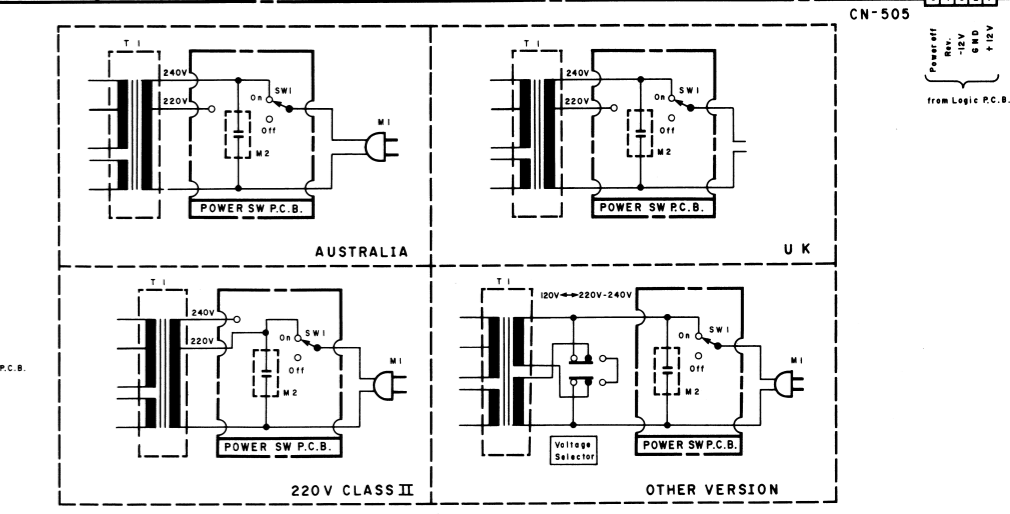

8. WIRING DIAGRAM

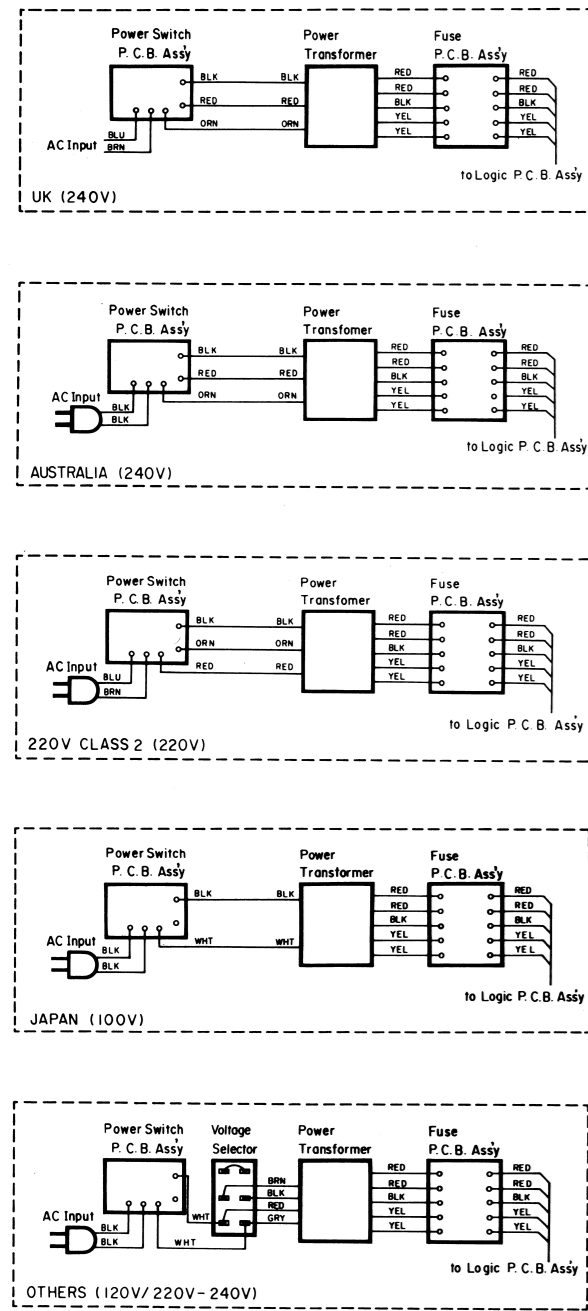

- Notes: 1. Table of wire colors
 BRN — Brown
 RED — Red
 ORN — Orange
 YEL — Yellow
 GRN — Green
 BLU — Blue
 VIO — Violet
 GRY — Gray
 WHT — White
 BLK — Black
 2. Dip side view of the P.C.B. is illustrated.
 3. Wire tube color is shown in ().

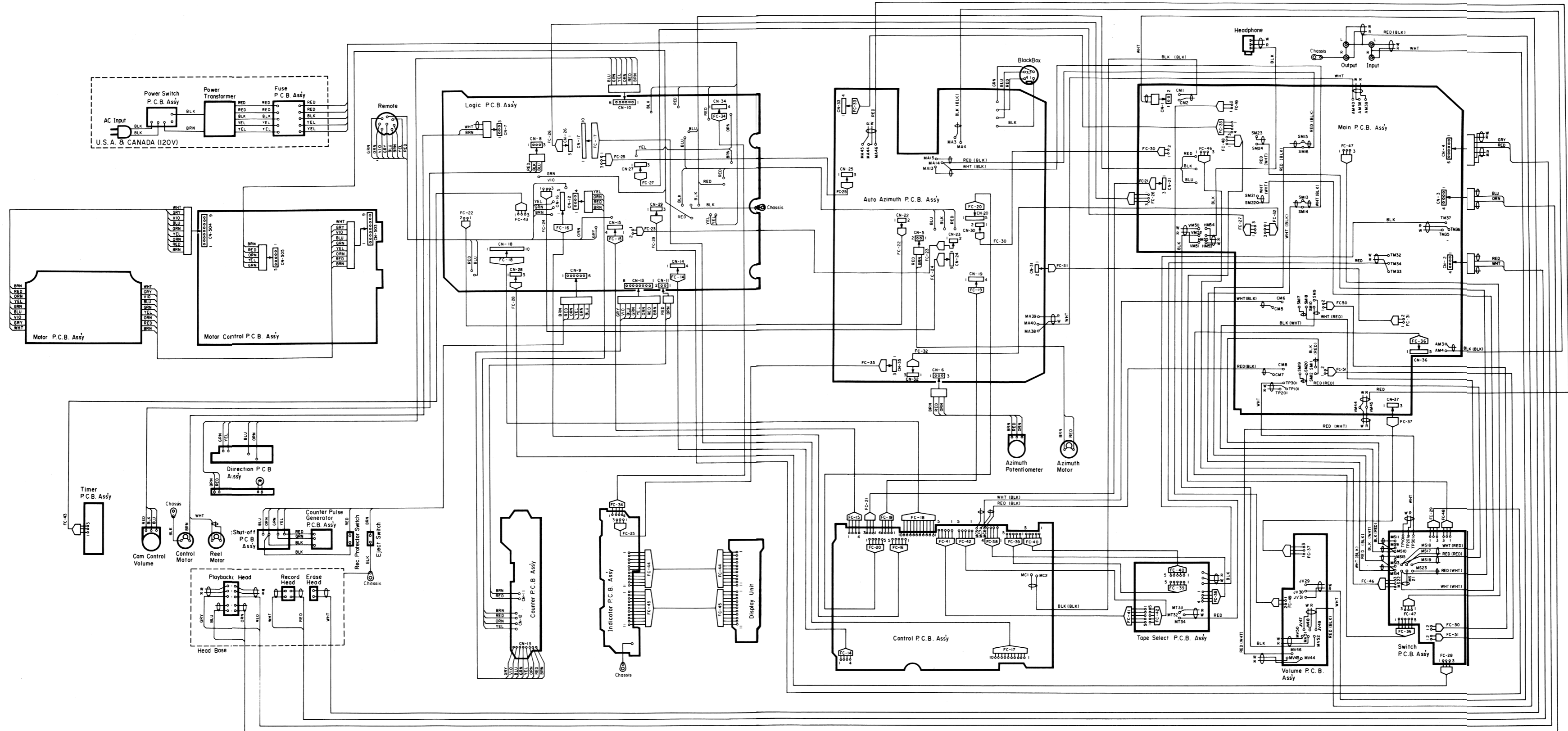

Fig. 8

9. TIMING CHART AND EQ. AMP. FREQUENCY RESPONSE

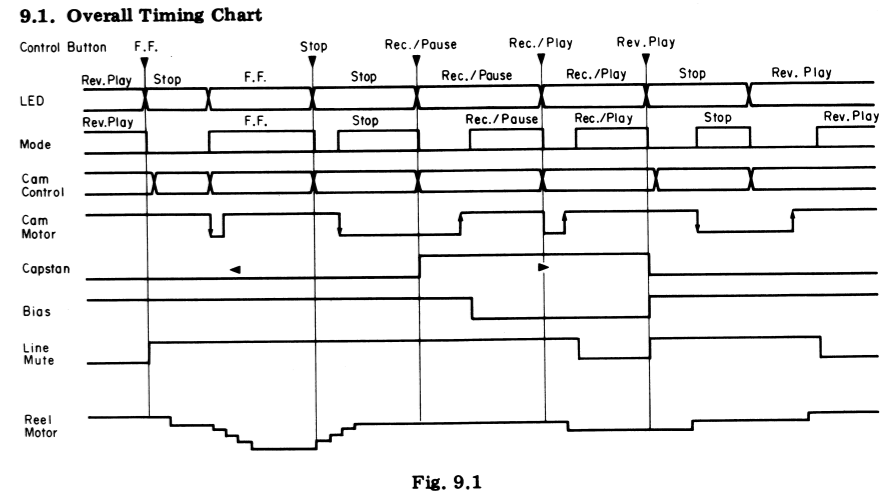

Fig. 9.1

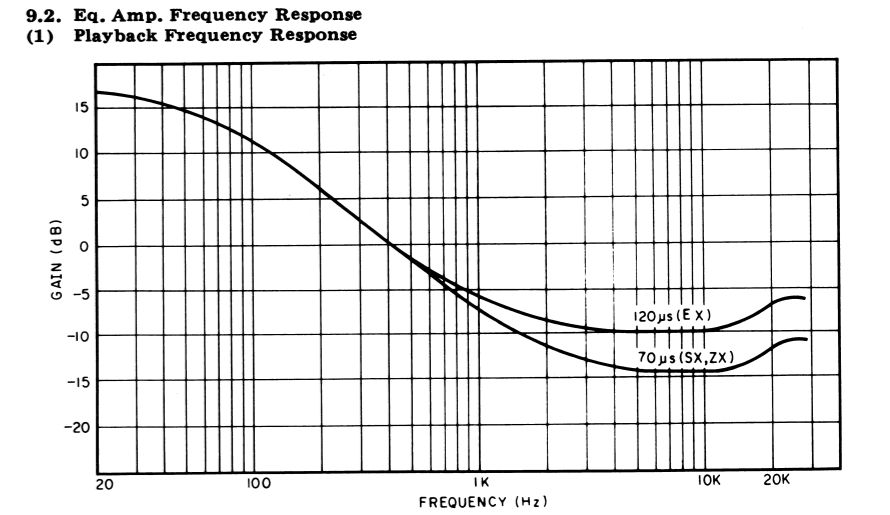

Fig. 9.2.1

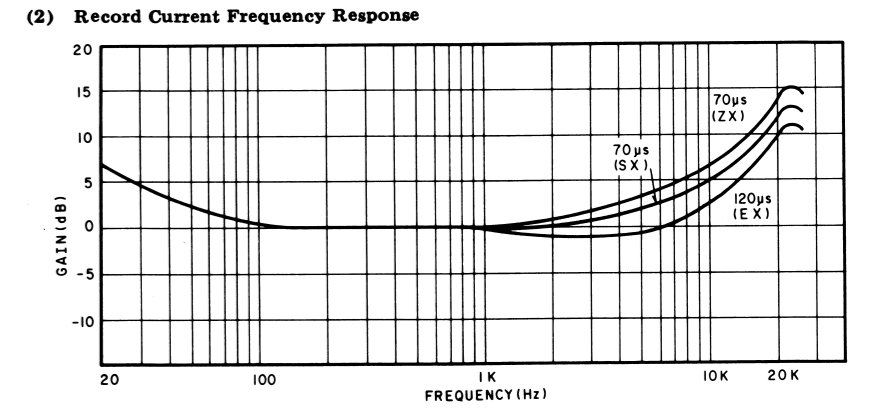

Fig. 9.2.2