

Integra SERVICE MANUAL

Ref. No. 3792

Nov, 2004

Super Audio CD & DVD Audio/Video Player MODEL **DPS-10.5**

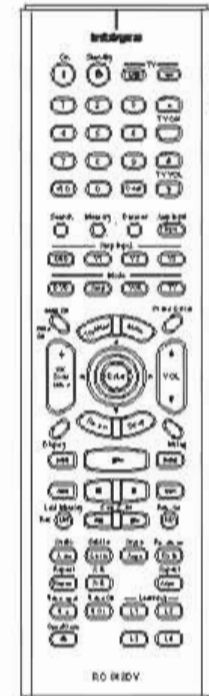

RC-562DV

UDD1N	120V AC, 60Hz
UPA4P	230-240V AC, 50Hz

SAFETY-RELATED COMPONENT WARNING!!

COMPONENTS IDENTIFIED BY MARK  ON THE SCHEMATIC DIAGRAM AND IN THE PARTS LIST ARE CRITICAL FOR RISK OF FIRE AND ELECTRIC SHOCK. REPLACE THESE COMPONENTS WITH ONKYO PARTS WHOSE PART NUMBERS APPEAR AS SHOWN IN THIS MANUAL.

MAKE LEAKAGE-CURRENT OR RESISTANCE MEASUREMENTS TO DETERMINE THAT EXPOSED PARTS ARE ACCEPTABLY INSULATED FROM THE SUPPLY CIRCUIT BEFORE RETURNING THE APPLIANCE TO THE CUSTOMER.

SPECIFICATIONS

Signal System	North American models:	NTSC
	Australian models:	PAL/NTSC
Composite Video Output/Impedance		1.0 V(p-p)/75 ohm negative sync, RCA/phono
S-Video Output/Impedance		Y: 1.0 V(p-p)/75 ohm negative sync, 4-pin mini DIN
		C: 0.286 V(p-p)/75 ohm
Component Video Output/Impedance		Y: 1.0 V(p-p)/75 ohm
		PB/PR: 0.7V(p-p)/75 ohm, RCA/phono, BNC
Frequency Response	DVD Audio	4 Hz - 88 kHz (192 kHz)
	DVD Linear Sound	4 Hz - 44 kHz (96 kHz)
		4 Hz - 22 kHz (48 kHz)
	Audio CD	4 Hz - 20 kHz (44.1 kHz)
S/N Ratio		112 dB
Audio Dynamic Range		106 dB
THD (Total Harmonic Distortion)		0.002 % (1 kHz)
Wow and Flutter		Below threshold of measurability
Audio Output (Digital/Optical)		-22.5 dBm
Audio Output/Impedance (Digital/Coaxial)		0.5V p-p / 75 ohm
Audio Output/Impedance (Analog)		2.0 V(rms) / 320 ohm
HDMI socket (HDMI OUT)		19-pin
i.LINK socket		4-pin (S400)
Power Supply	North American models:	AC 120 V, 60 Hz
	Australian models:	AC 230-240 V, 50 Hz
Power Consumption		48 W
Stand-by Power Consumption		7.1 W
Dimensions (W x H x D)		435 W x 123 H x 376 D mm 17. 1/8 W x 4. 13/16 H x 14. 13/16 D inches
Weight		12.1 kg 26.7 lbs
Operation Condition Temperature		5°C - 35°C (41°F - 95°F)
Disc Compatibility		DVD-Video, DVD-Audio, SACD, DVD-R (Video Mode), DVD-RW (Video Mode/VR mode), Music CD/CD-R/RW, Video CD, MP3, JPEG Disc that has not been properly finalized may only be partially playable or not playable at all.

Specifications and features subject to change without notice.

SERVICE PROCEDURES-1

This set employs a laser. Therefore, be sure to follow carefully the instructions below when servicing.

WARNING!!

SERVICE WARNING : DO NOT APPROACH THE LASER EXIT WITH THE EYE TOO CLOSELY. IN CASE IT IS NECESSARY TO CONFIRM LASER BEAM EMISSION, BE SURE TO OBSERVE FROM A DISTANCE OF MORE THAN 30cm FROM THE SURFACE OF THE OBJECTIVE LENS ON THE OPTICAL PICKUP BLOCK.

Laser Diode Properties

CD
 Wavelength: 650 nm
 Laser output: 0.43 mW

DVD
 Wavelength: 780 nm
 Laser output: 0.14 mW

WARNING

WARNING:

TO REDUCE THE RISK OF FIRE OR ELECTRIC SHOCK, DO NOT EXPOSE THIS APPLIANCE TO RAIN OR MOISTURE.

CAUTION:

TO REDUCE THE RISK OF ELECTRIC SHOCK, DO NOT REMOVE COVER (OR BACK). NO USER-SERVICEABLE PARTS INSIDE. REFER SERVICING TO QUALIFIED SERVICE PERSONNEL.



WARNING
 RISK OF ELECTRIC SHOCK
 DO NOT OPEN

AVIS
 RISQUE DE CHOC ELECTRIQUE
 NE PAS OUVRIR



The lightning flash with arrowhead symbol, within an equilateral triangle, is intended to alert the user to the presence of uninsulated "dangerous voltage" within the product's enclosure that may be of sufficient magnitude to constitute a risk of electric shock to persons.



The exclamation point within an equilateral triangle is intended to alert the user to the presence of important operating and maintenance (servicing) instructions in the literature accompanying the appliance.

LASER WARNING

This unit contains a semiconductor laser system and is classified as a "CLASS 1 LASER PRODUCT". So, to use this model properly, read this Instruction Manual carefully. In case of any trouble, please contact the store where you purchased the unit. To prevent being exposed to the laser beam, do not try to open the enclosure.

CAUTION:

VISIBLE LASER RADIATION WHEN OPEN AND INTERLOCK FAILED OR DEFEATED. DO NOT STARE INTO BEAM.

CAUTION:

THIS PRODUCT UTILIZES A LASER. USE OF CONTROLS OR ADJUSTMENTS OR PERFORMANCE OF PROCEDURES OTHER THAN THOSE SPECIFIED HEREIN MAY RESULT IN HAZARDOUS RADIATION EXPOSURE.

The label on the right is applied on the rear panel except for USA and Canadian models.



1. This unit is a CLASS 1 LASER PRODUCT and employs a laser inside the cabinet.
2. To prevent the laser from being exposed, do not remove the cover. Refer servicing to qualified personnel.

SERVICE PROCEDURE

1. Replacing the fuses

This symbol located near the fuse indicates that the fuse used is show operating type, For continued protection against fire hazard, replace with same type fuse , For fuse rating, refer to the marking adjest to the symbol.

Ce symbole indique que le fusible utilise est e lent. Pour une protection permanente, n'utiliser que des fusibles de meme type. Ce demier est indique la qu le present symbol est apposse.

REF. NO.	PART NO.		DESCRIPTION	DST.
F001 or	252158	⚠	1.6A-UL/T-237	<DD1N>
	252252		1.6A-T/UL-ST2	<DD1N>
F001 or	252075	⚠	2.5A-SW-EAK	<PA4P>
	252275		2.5A-SE-TL250V	<PA4P>
REF. NO.	PART NO.		DESCRIPTION	DST.
F9001 or	252160	⚠	2.5A-UL/T-237	<DD1N>
	252254		2.5A-T/UL-ST2	<DD1N>
F9001 or	252075	⚠	2.5A-SE-EAK	<PA4P>
	252275		2.5A-SE-TL250V	<PA4P>

LASER BEAM CAUTION LABEL



WAVE LENGTH:650nm
 MAX.LASER POWER:0.5mW
 波 長:650nm
 最大レーザー出力:0.5mW
 98764160



NOTE:
 <DD1N>: North American Region
 <PA4P>: Australian Region

SERVICE PROCEDURES-2

2. Safety-check out

(Only U.S.A. model)

After correcting the original service problem perform the following safety check before releasing the set to the customer
Connect the insulating-resistance tester between the plug of power supply cord and terminal GND on the back panel.
Specifications: More than 10M ohm at 500V

INITIALIZING

Factory-shipped condition

Push button "ON" (Mechanical SW) Except <DCIN>

Press the [STOP] and [STANDBY] same time.

(Wait until FL display "No Disc") .

Push button "STANDBY".

Others

SURR. MODE Switch ----- "1" position

Mechanical power switch ---- ON

Confirm version of Microprocessor

At power ON.

1. Press "DISPLAY" key and "VIDEO OFF" key at same time.

2. Press "DISPLAY" key.

- | | |
|---|-----------------------------------|
| a) System microprocessor | g) FL display microprocessor |
| b) Release version of System microprocessor | h) Video microprocessor |
| c) Loader microprocessor version | i) Loader of video microprocessor |
| d) B/E version of microprocessor | j) iLINK microprocessor |
| e) F/E version of microprocessor | k) Model name |
| f) CPPM | l) Destination |
| | m) All segment of TL tube |

Note: Regional cod is displayed on the TV monitor.

EXPLODED VIEW-2

DVD LOADER MECHANISM

Z711: MGD-33
Parts No. 24801022

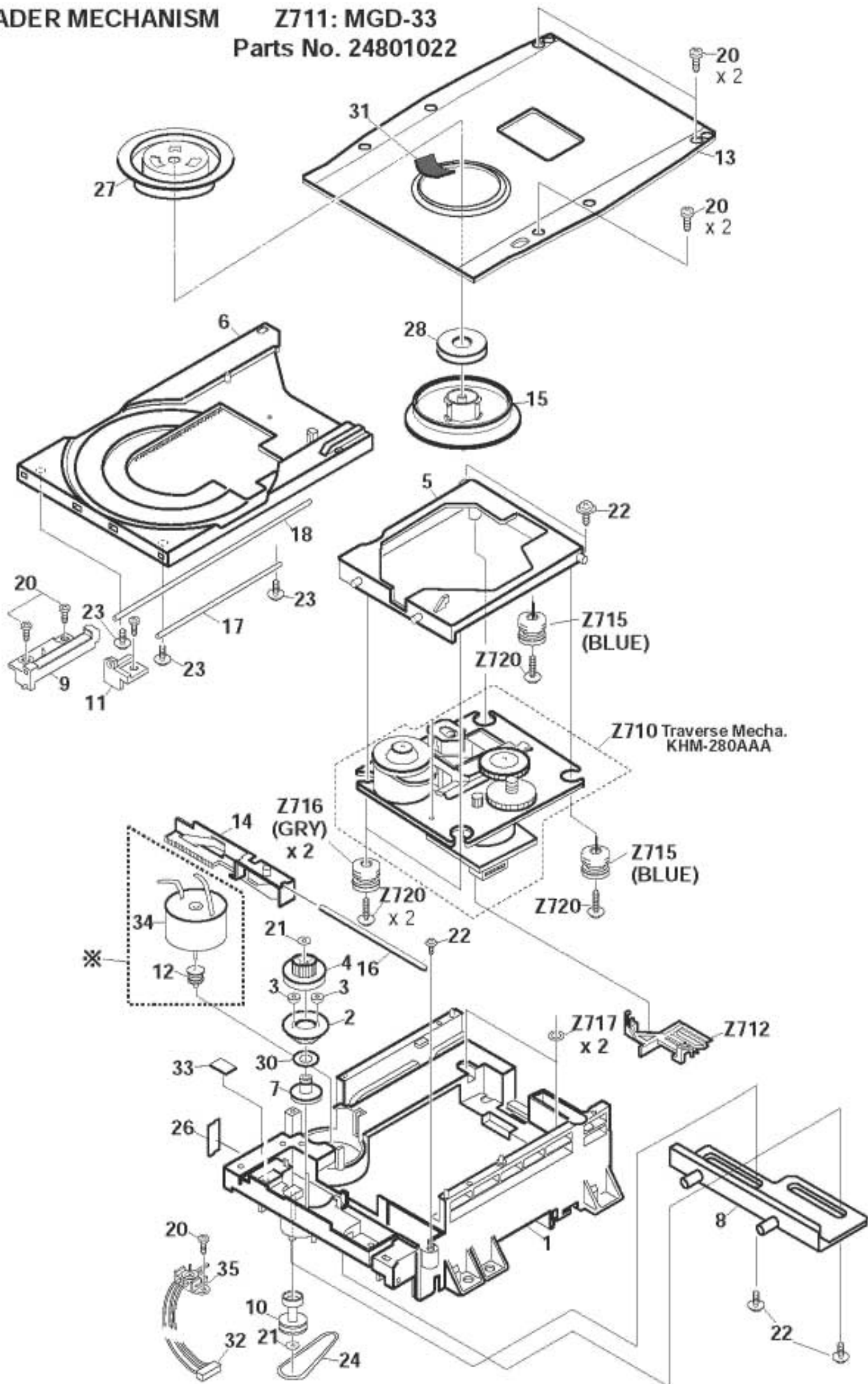

SCHEMATIC DIAGRAM-7/18

U09 : AUDIO OUTPUT PC BOARD NAAF-8266

AUDIO OUTPUT SECTION

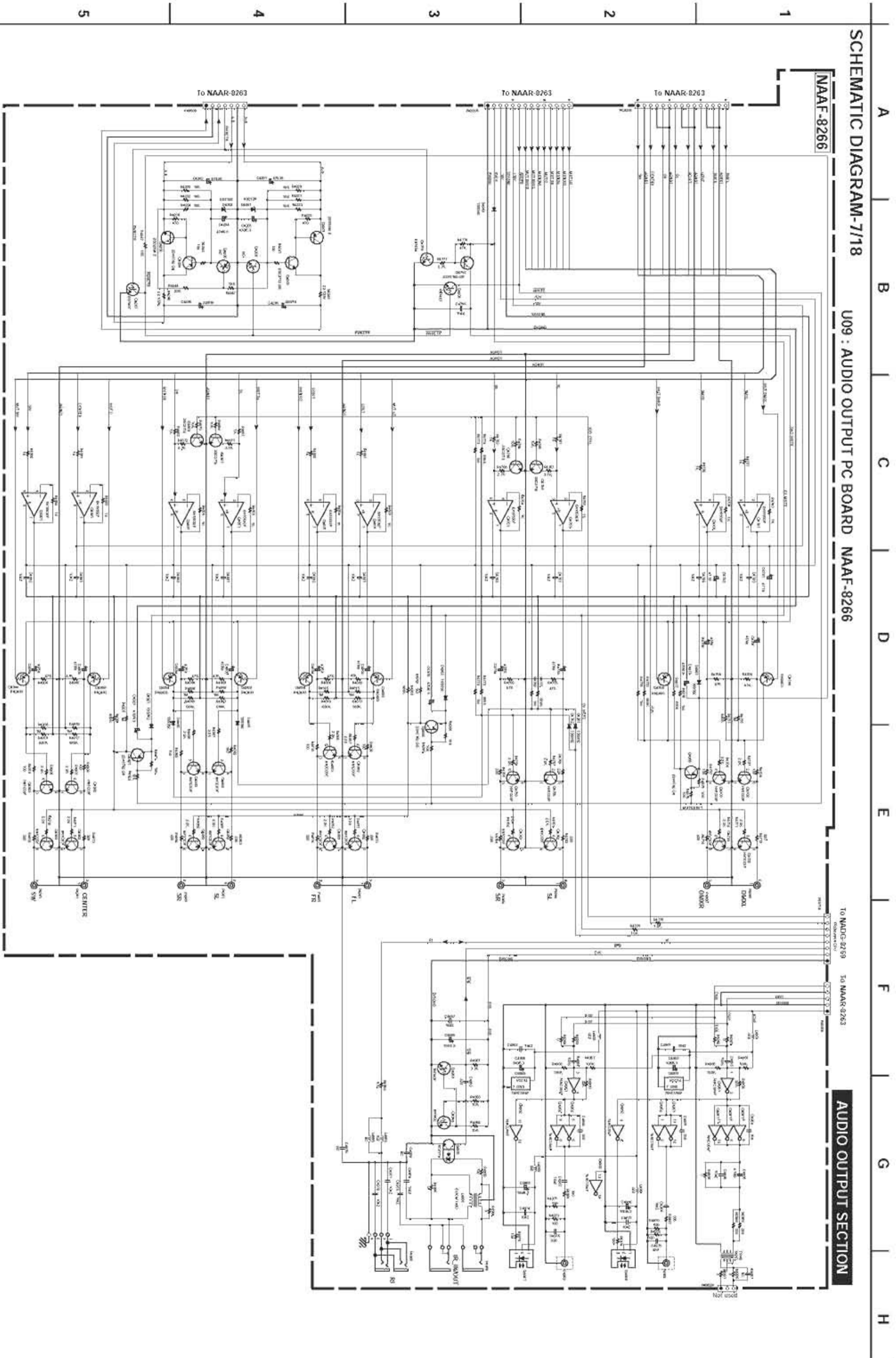

5

4

3

2

1

A

B

C

D

E

F

G

H

NAAR-8263

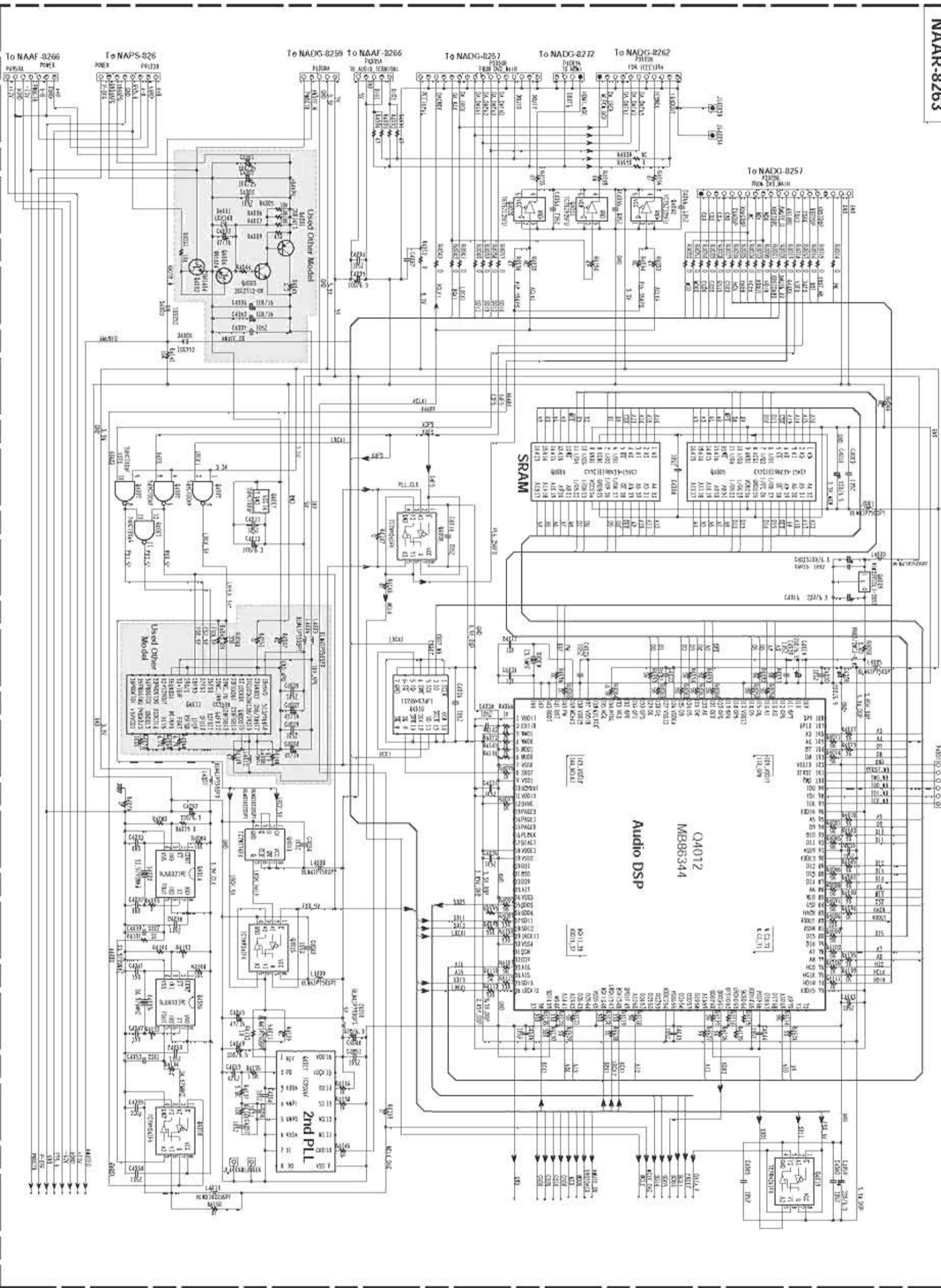

SCHEMATIC DIAGRAM 6/18

AUDIO/DAC SECTION

VLSC x 8 channel

NAAR-8263

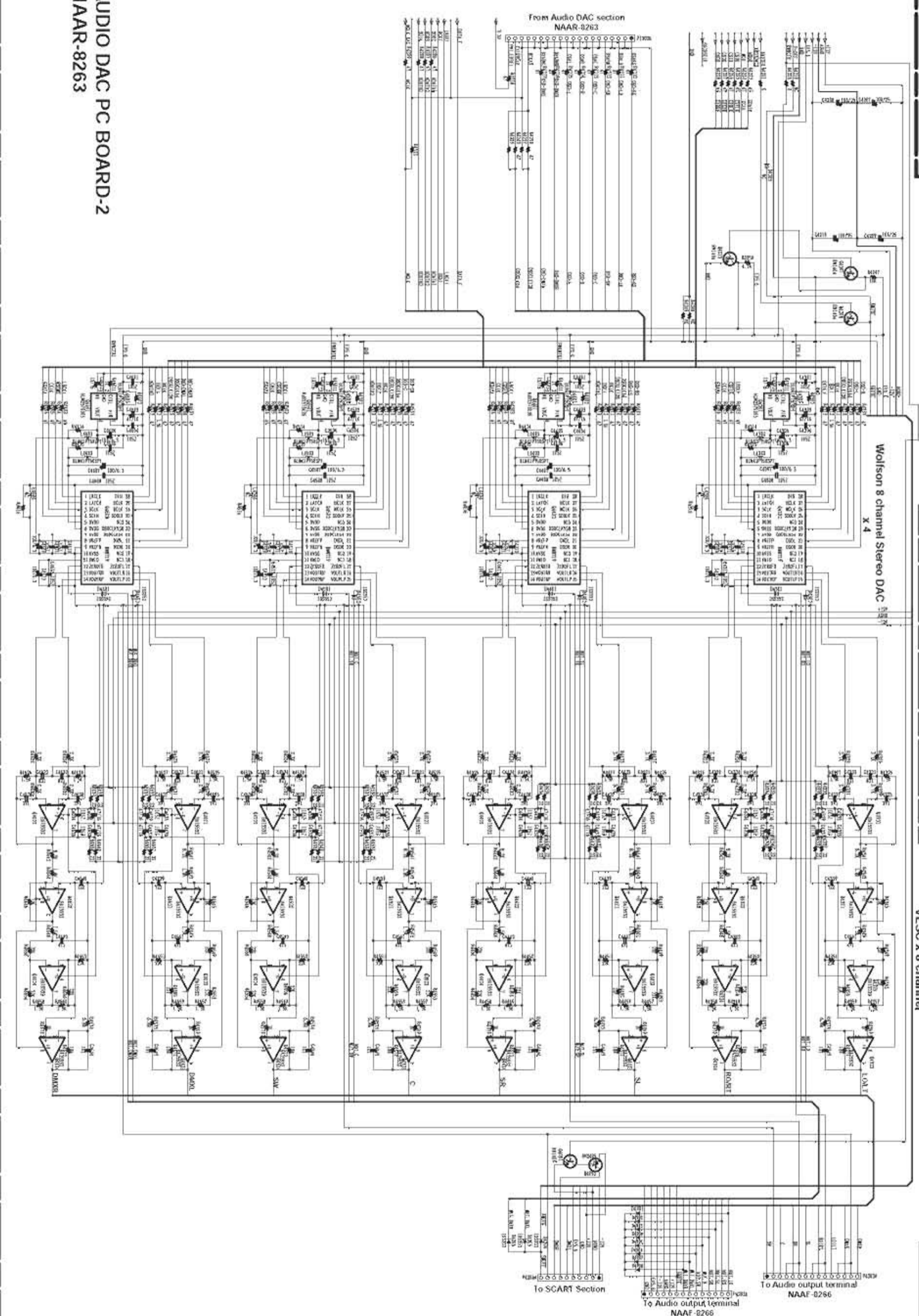

U18 : AUDIO DAC PC BOARD-2
NAAR-8263

A B C D E F G H

5

4

3

2

1

SCHEMATIC DIAGRAM 1/18
 U03 : DVD MAIN CPU PC BOARD (1/2) NADG-8259
 MAIN CPU SECTION

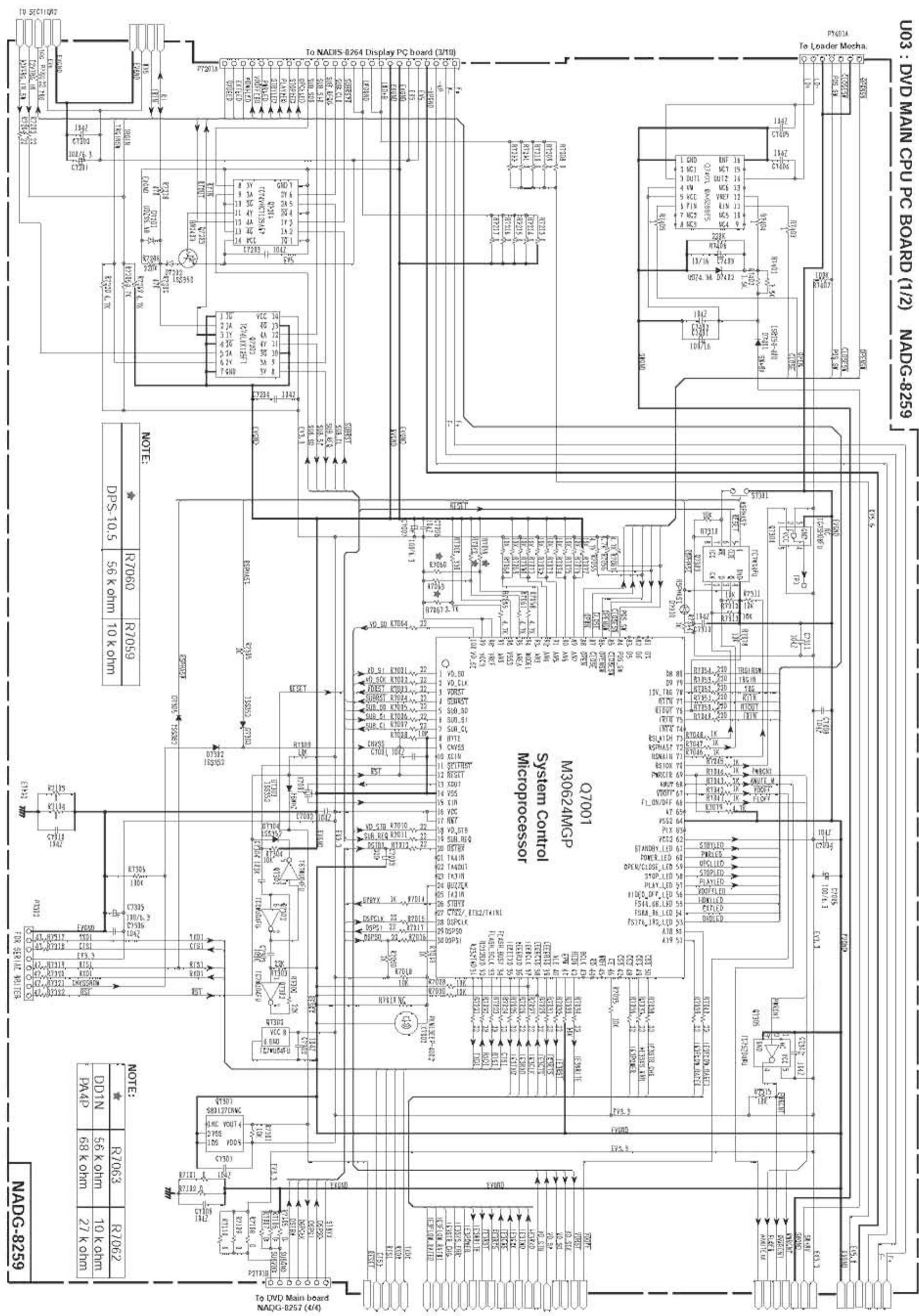

NADG-8259

SCHEMATIC DIAGRAM 2/18

U03 : DVD MAIN CPU PC BOARD
NADG-8259 (2/2)

MAIN CPU SECTION
NADG-8259

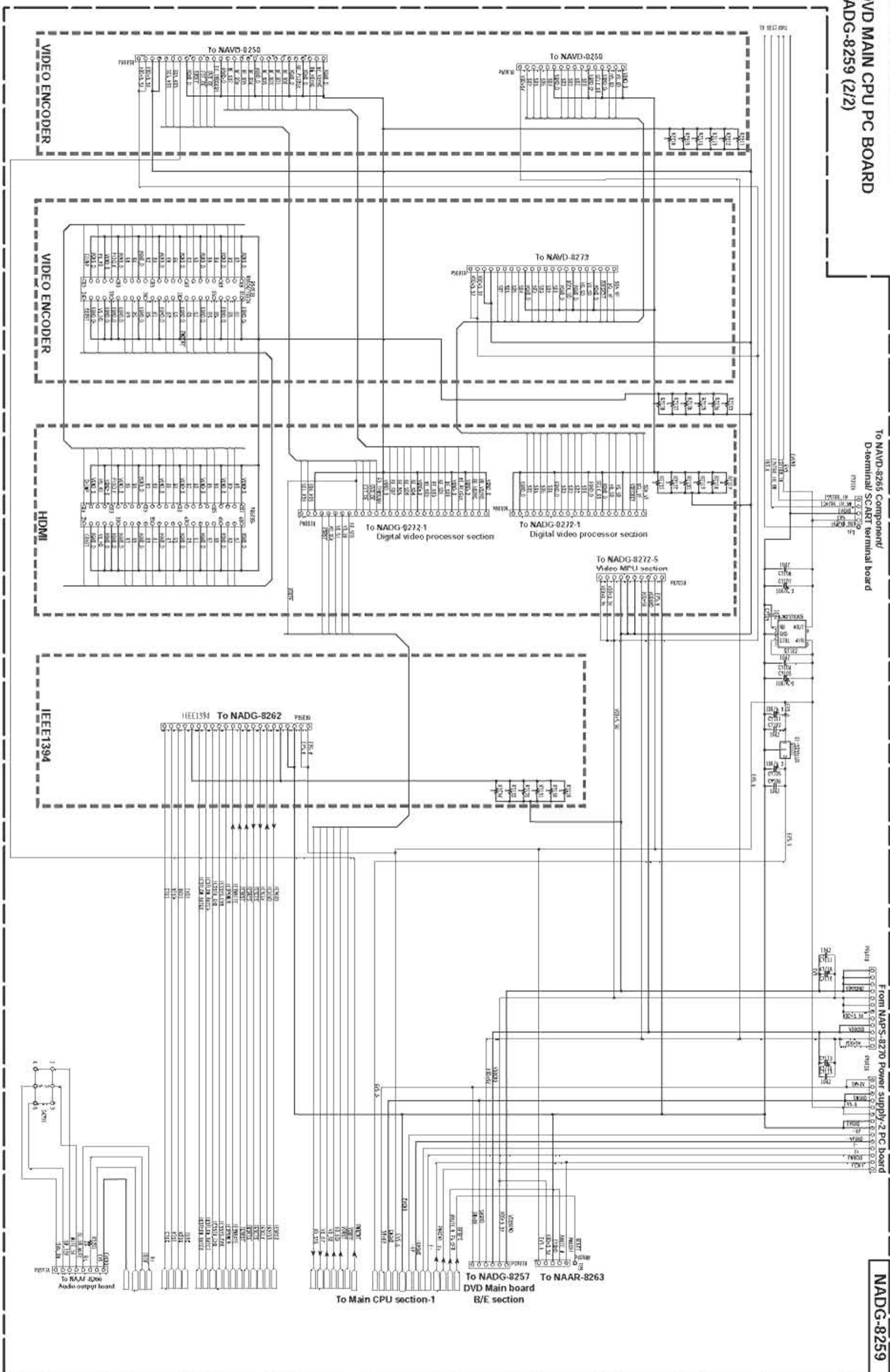

A B C D E F G H

1

2

3

4

5

SCHEMATIC DIAGRAM 15/18 U15 : DIGITAL VIDEO PROCESSOR PC BOARD (2/5) NADG-8272 SCALER SECTION

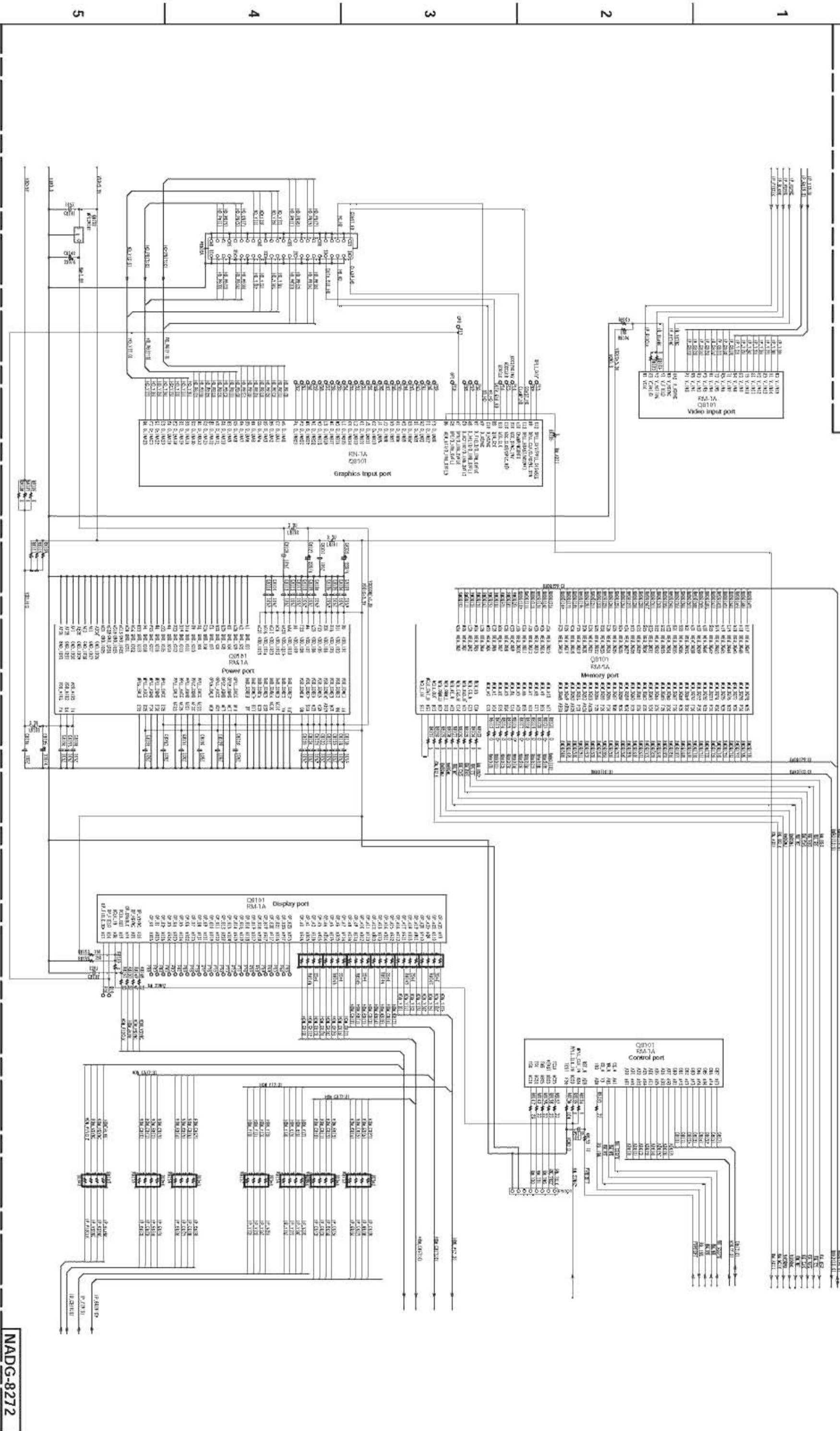

NADG-8272

A B C D E F G H

SCHEMATIC DIAGRAM 17/18

U15 : DIGITAL VIDEO PROCESSOR PC BOARD (4/5) NADG-8272

HDMI SECTION

NADG-8272

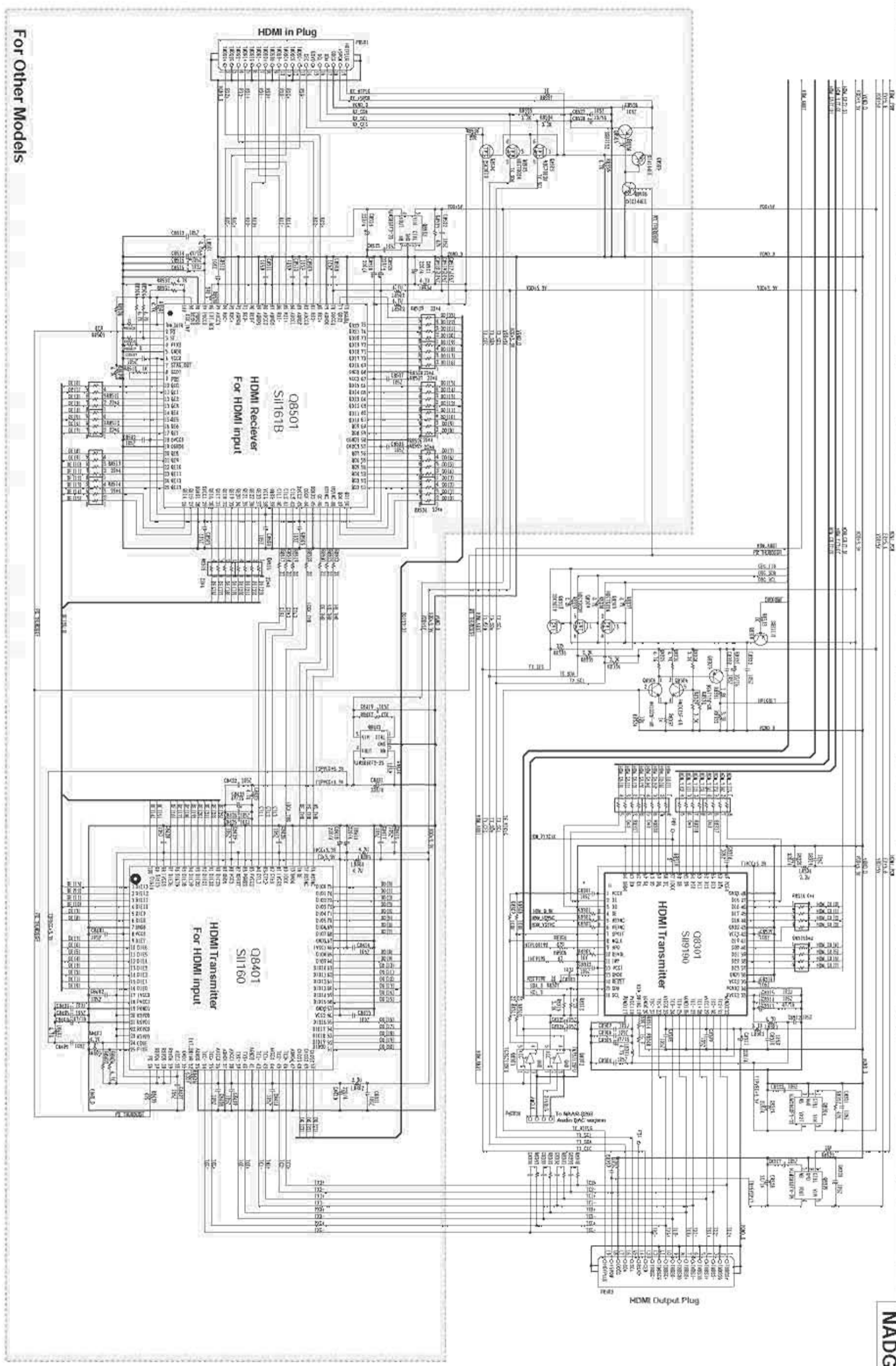

For Other Models

A B C D E F G H

SCHEMATIC DIAGRAM 18/18

U15 : DIGITAL VIDEO PROCESSOR PC BOARD (5/5) NADG-8272

VIDEO MPU SECTION

NADG-8272

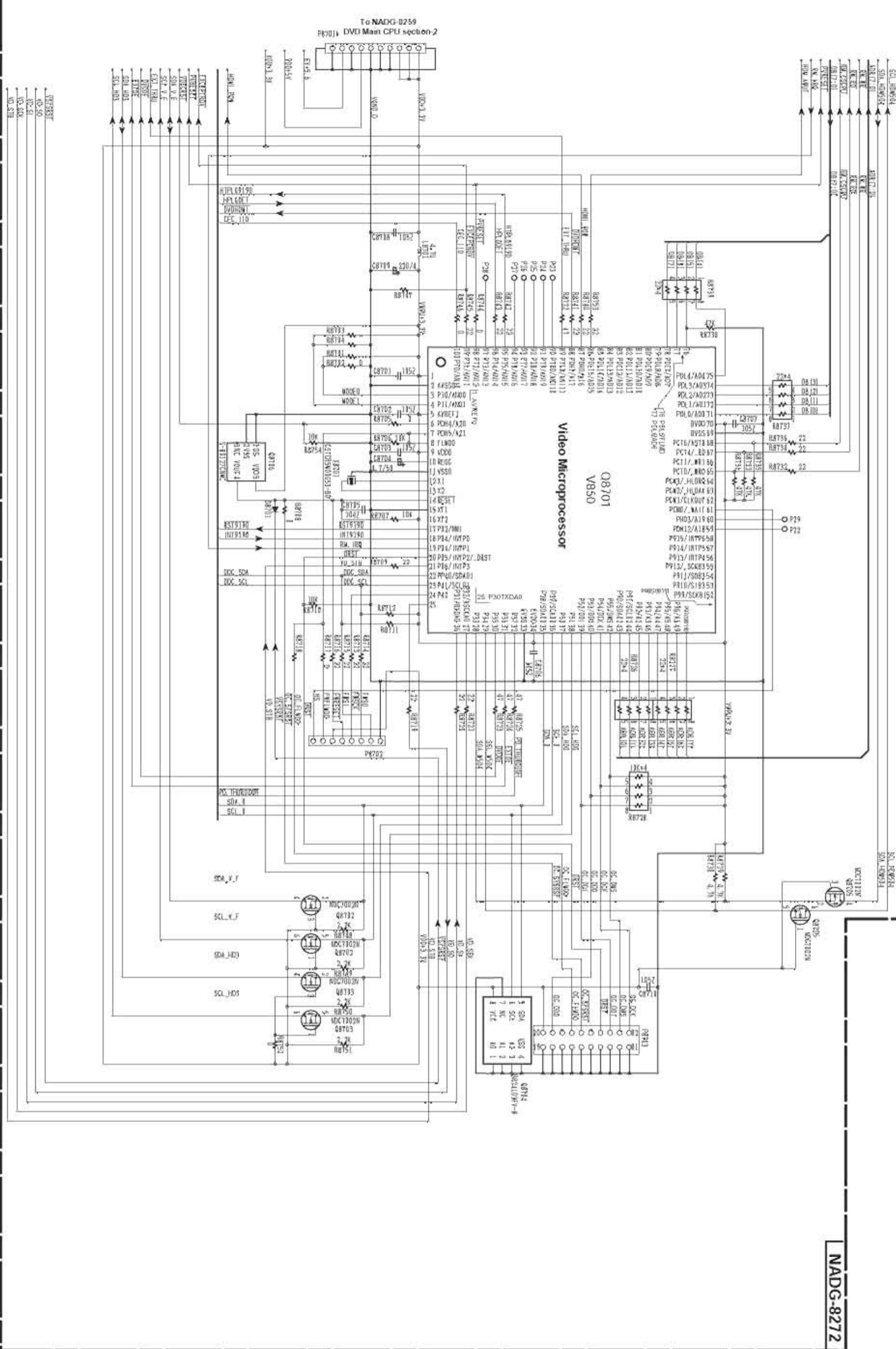

5

4

3

2

1

SCHEMATIC DIAGRAM 3/18

U07 : DISPLAY PC BOARD NADIS-8264

DISPLAY SECTION

U10 : JOG SWITCH PC BOARD NASW-8267

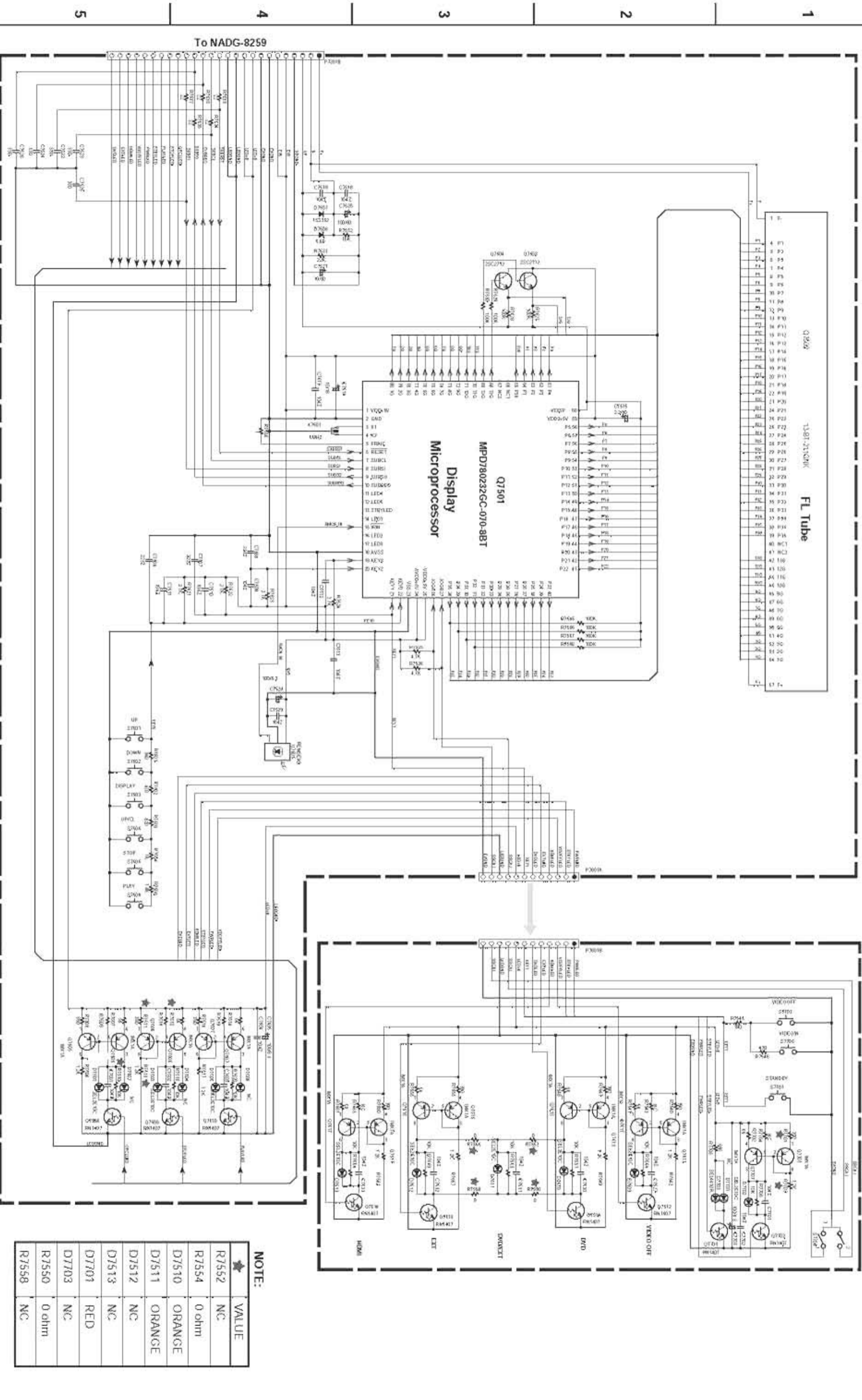

NOTE:

★	VALUE
R7552	NC
R7554	0 ohm
D7510	ORANGE
D7511	ORANGE
D7512	NC
D7513	NC
D7701	RED
D7703	NC
R7550	0 ohm
R7558	NC

U12 : POWER SUPPLY PC BOARD-1 NAPS-8269

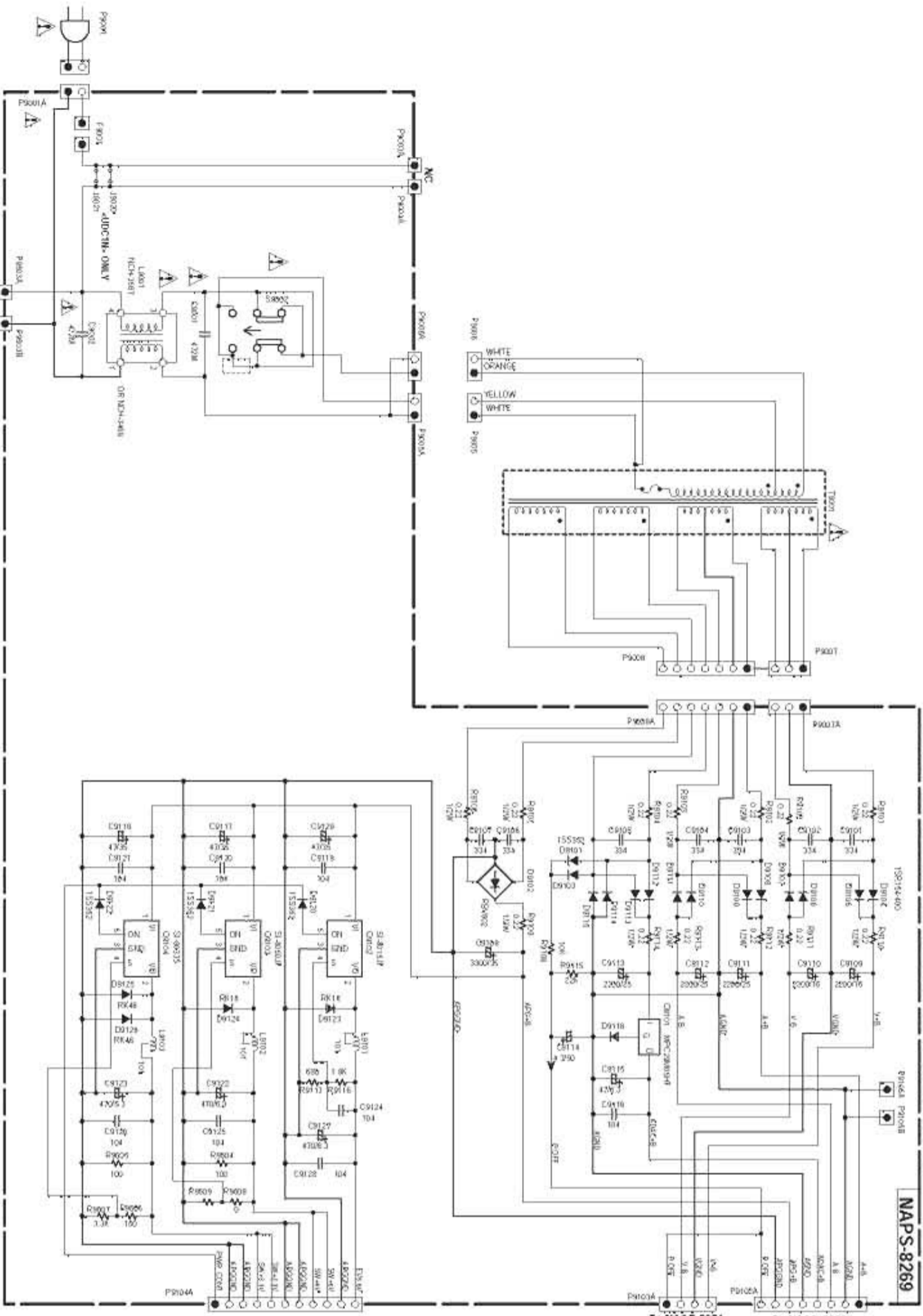

CAUTION
 FOR CONTACT PROTECTION
 AGAINST FIRE HAZARD REPLACE
 ONLY WITH FUSE OF SAME TYPE
 AND RATING INDICATED.

ATTENTION
 POUR PROTEGER CONTRE LES RISQUES
 D'INCENDIE, REMPLACEZ UNiquement
 PAR UN FUSIBLE DE MÊME TYPE
 ET CARACTÉRISTIQUES INDICÉES.

NOTE
 THIS SYMBOL LOCATED NEXT TO THE FUSE INDICATES
 THAT THE FUSE USED IS AN OPERATING TYPE
 FOR CONTINUED PROTECTION AGAINST FIRE
 HAZARD REPLACE WITH SAME TYPE FUSE. FOR FUSE
 RATING REFER TO THE PARTING ADJACENT TO THE SYMBOL.

NOTE
 CE SYMBOLE INDIQUE QUE LE FUSIBLE UTILISÉ EST
 ÉLÉMENT POUR UNE PROTECTION PERMANENTE CONTRE
 LES RISQUES D'INCENDIE. REMPLACEZ UNiquement
 PAR UN FUSIBLE DE MÊME TYPE. CARACTÉRISTIQUES
 INDICÉES EN OÙ LE PRÉSENT SYMBOLE. CONSULTEZ
 LE SYMBOLE ADJACENT À CE SYMBOLE POUR LE
 RANGEMENT DU FUSIBLE.

NOTE
 THE COMPONENTS IDENTIFIED WITH MARK Δ ARE CRITICAL FOR SAFETY.
 REPLACE ONLY WITH COMPONENTS IDENTIFIED WITH THIS MARK.
 ALL DIMENSIONS ARE IN MILLIMETERS UNLESS OTHERWISE NOTED.
 DIMENSIONS ARE IN INCHES UNLESS OTHERWISE NOTED.
 THE TRACK LINE ON OCCASION INDICATE THE POSITION OF THE MARKS
 ON THE PRINTING SIDE.
 CIRCUIT IS SUBJECT TO CHANGE FOR IMPROVEMENT.

U13 : POWER SUPPLY PC BOARD-2 NAPS-8270

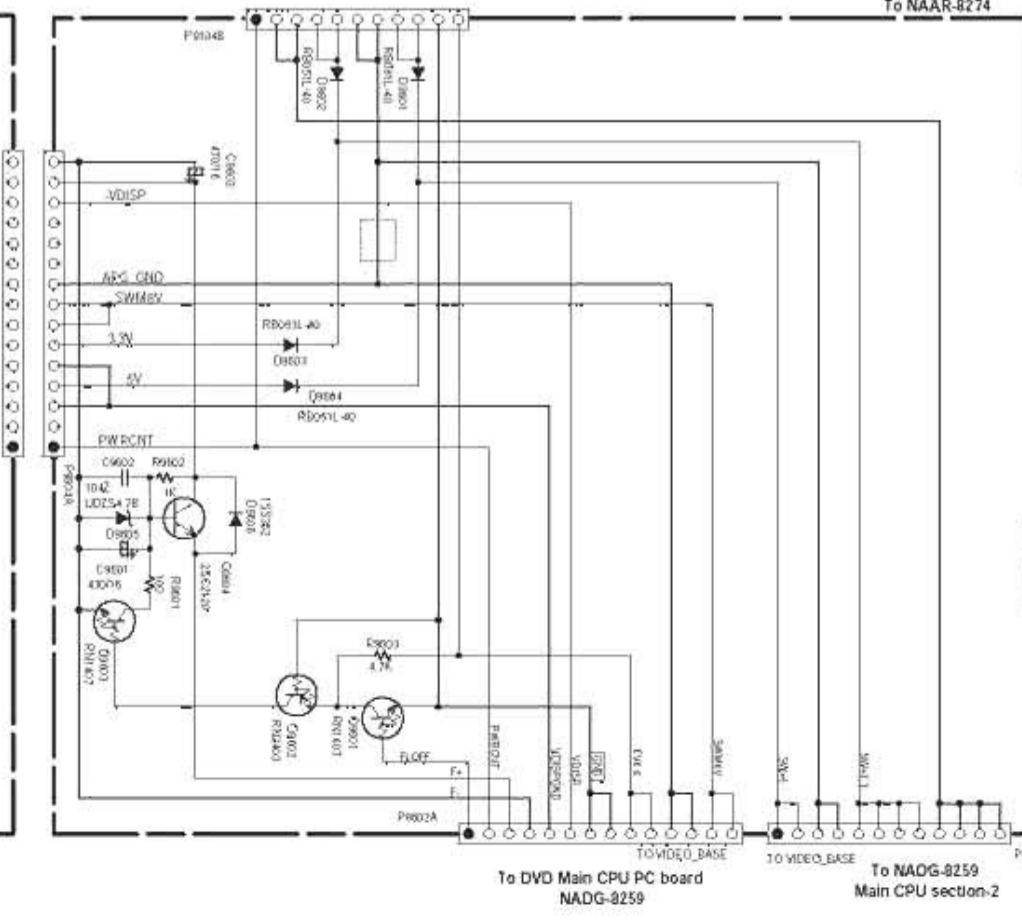

U21 : POWER SUPPLY UNIT
 (NAPS-0036)-----<DD1N>
 (NAPS-0037)-----<PAAP>

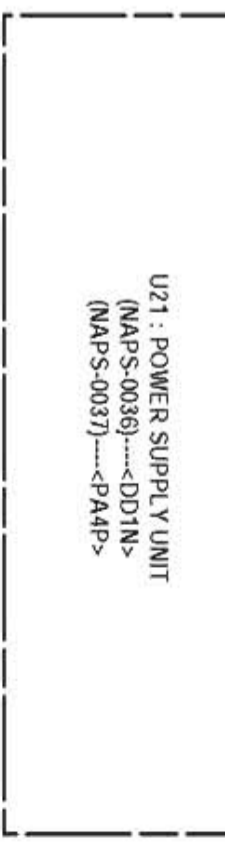

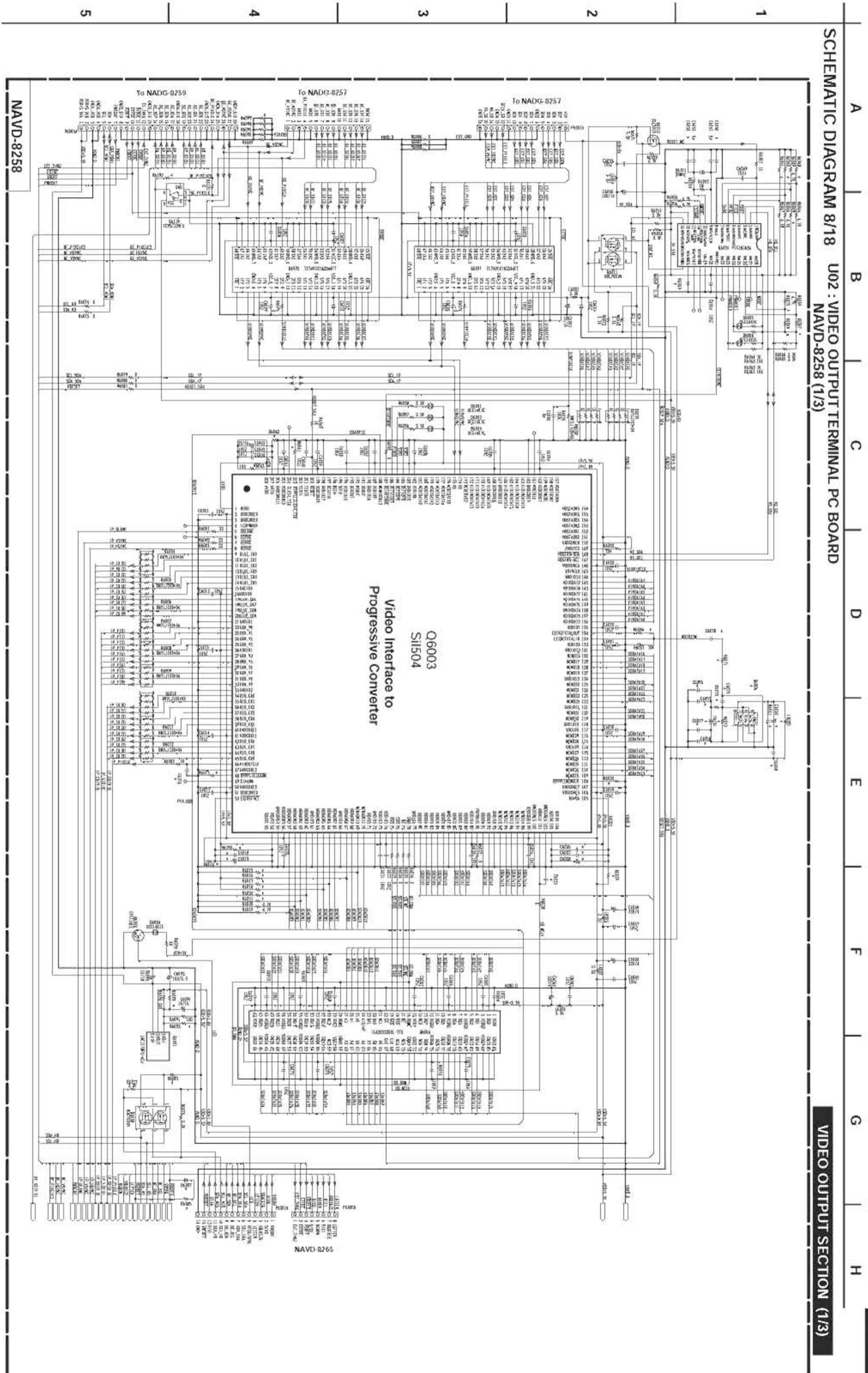

NAVD-8258

NAVD-8265

Q6003
Si1504
Video Interface to
Progressive Converter

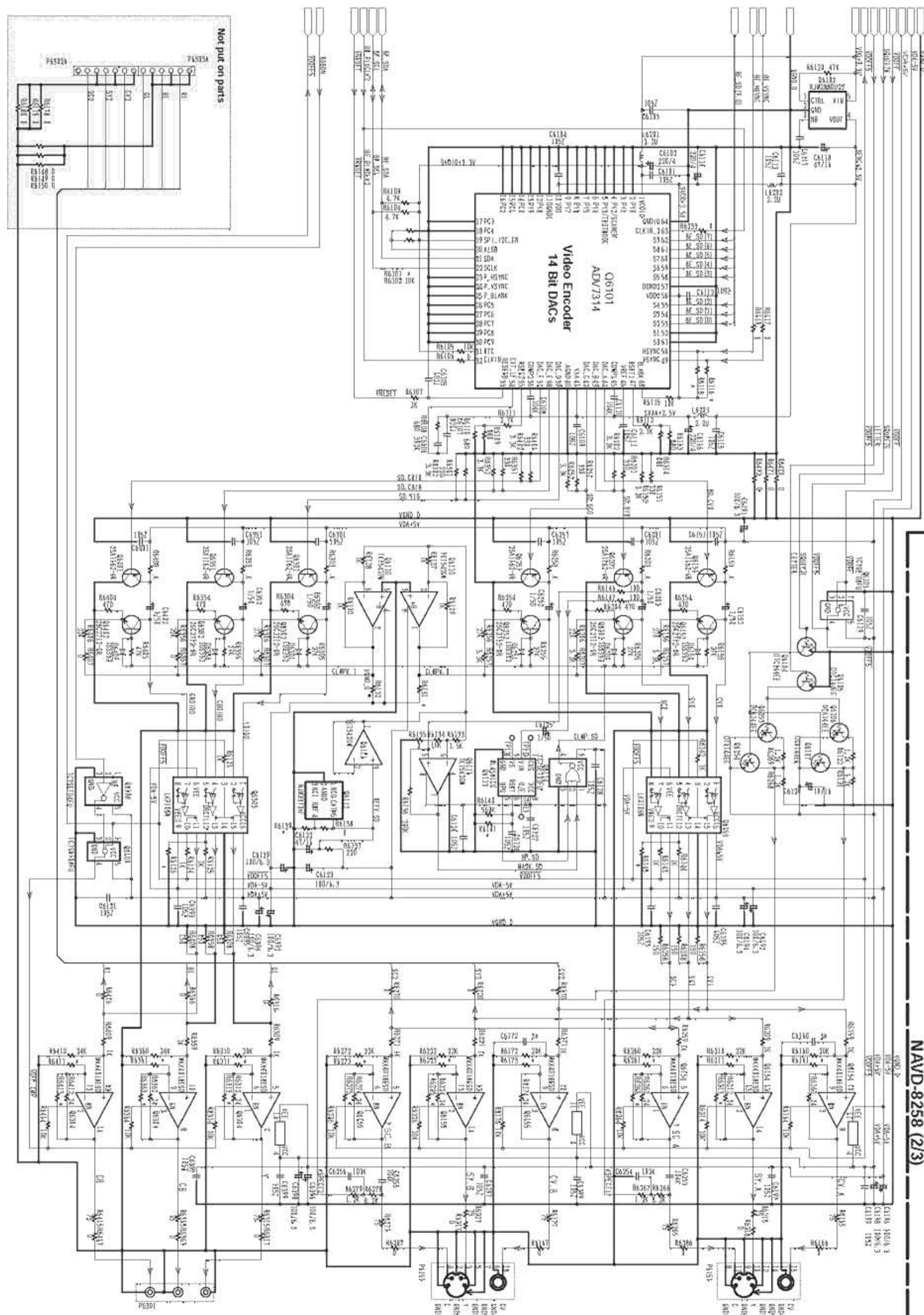

A B C D E F G H

5

4

3

2

1

SCHEMATIC DIAGRAM 10/18 U02 : VIDEO OUTPUT TERMINAL PC BOARD NAVD-8258 (3/3)

VIDEO OUTPUT SECTION (3/3)

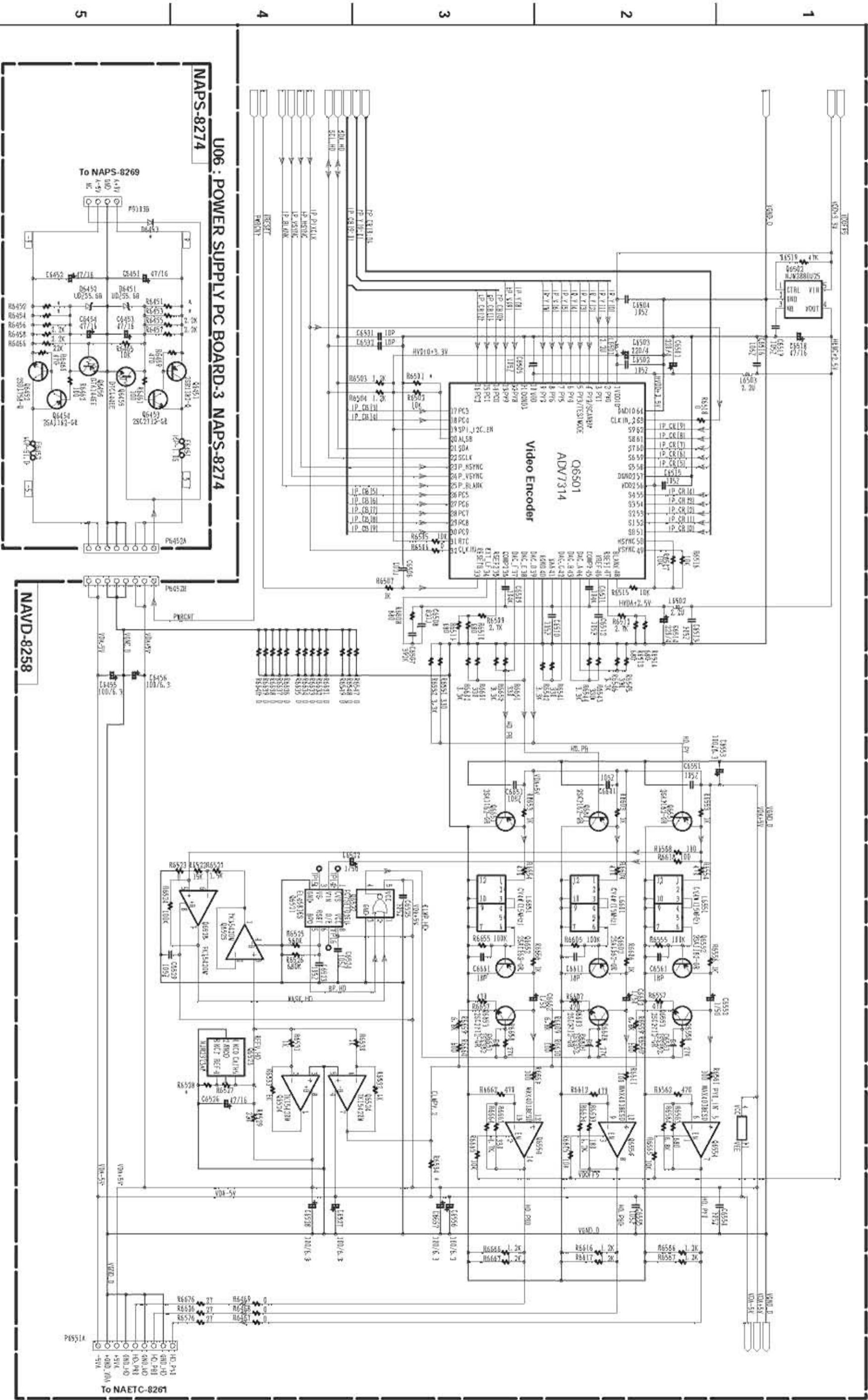

A B C D E F G H

5

4

3

2

1

A B C D E F G H

SCHEMATIC DIAGRAM 11/18 U08 : COMPONENT/D-TERMINAL/
SCART TERMINAL PC BOARD NAVD-8265

COMPONENT/D-TERMINAL/SCART SECTION

NAVD-8265

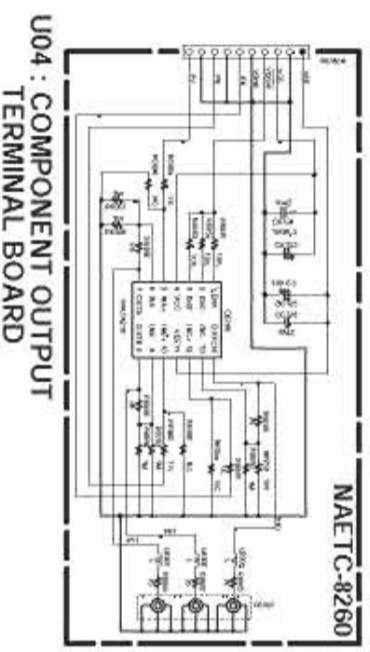
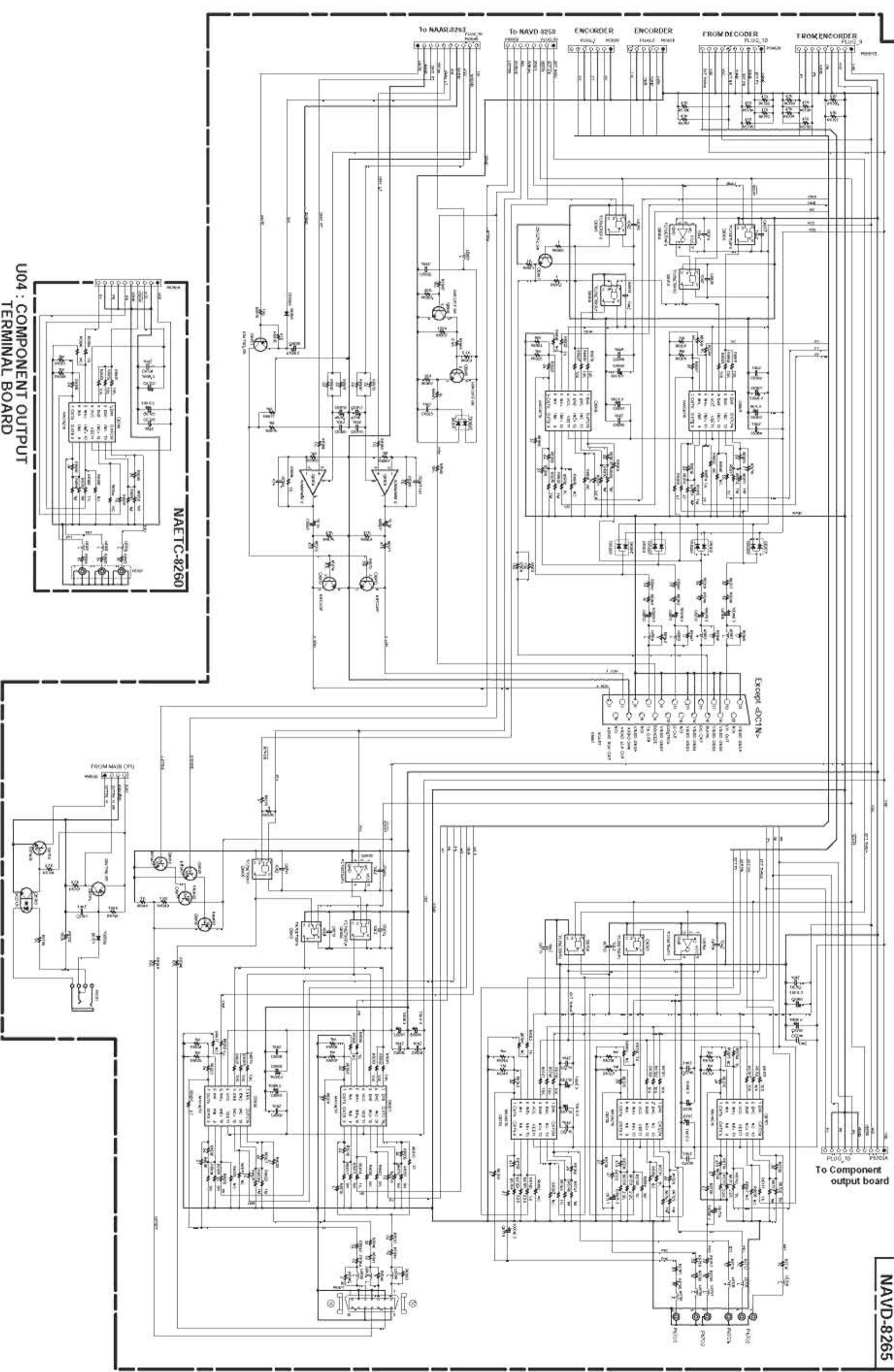

U04 : COMPONENT OUTPUT
TERMINAL BOARD

5

4

3

2

1

VIDEO DECODER SECTION

U16: VIDEO INPUT TERMINAL PC BOARD NAVD-8273

NAVD-8273

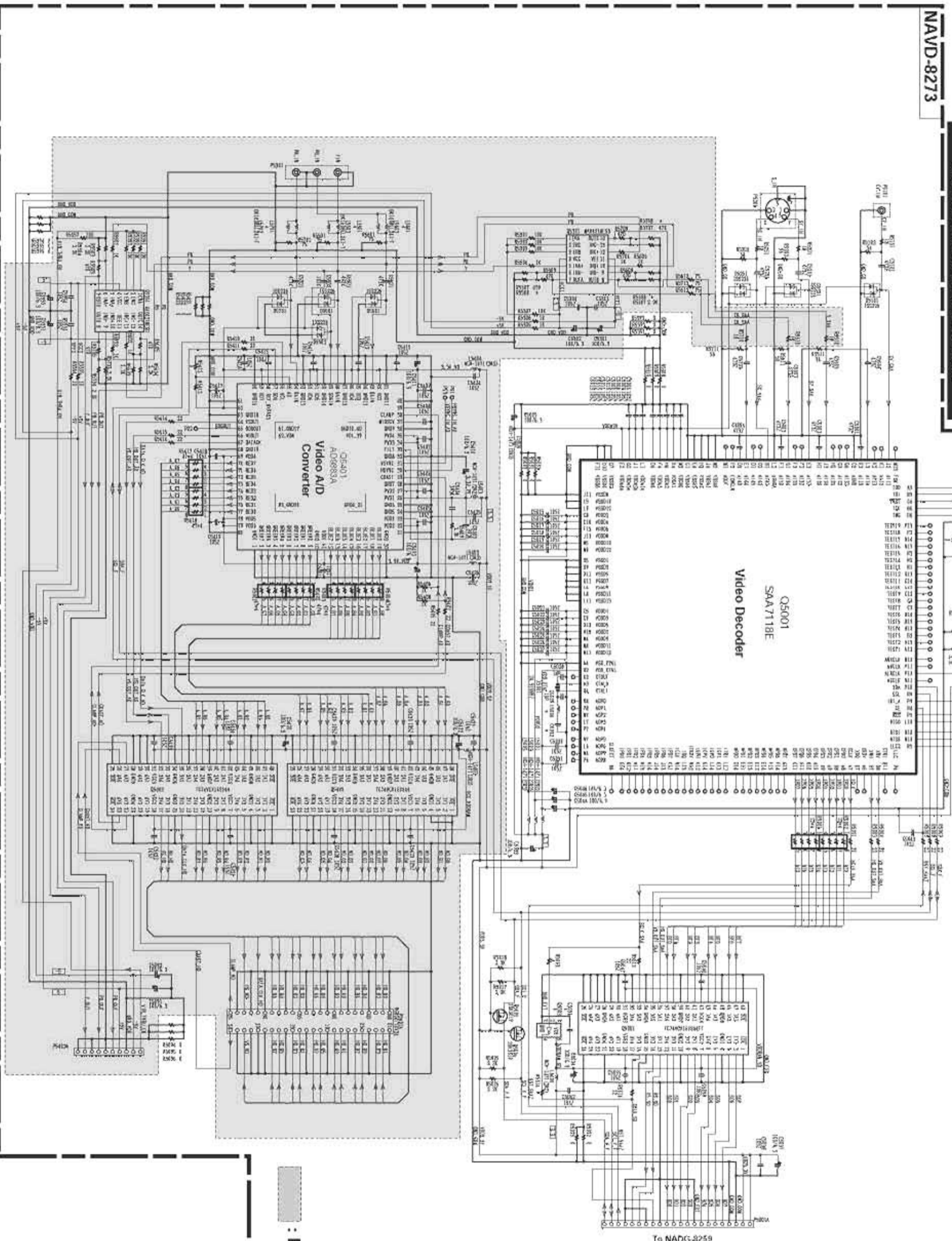

For other models

SCHEMATIC
DIAGRAM

U01 : DVD MAIN BOARD NADG-8257 (1/4) F/E section

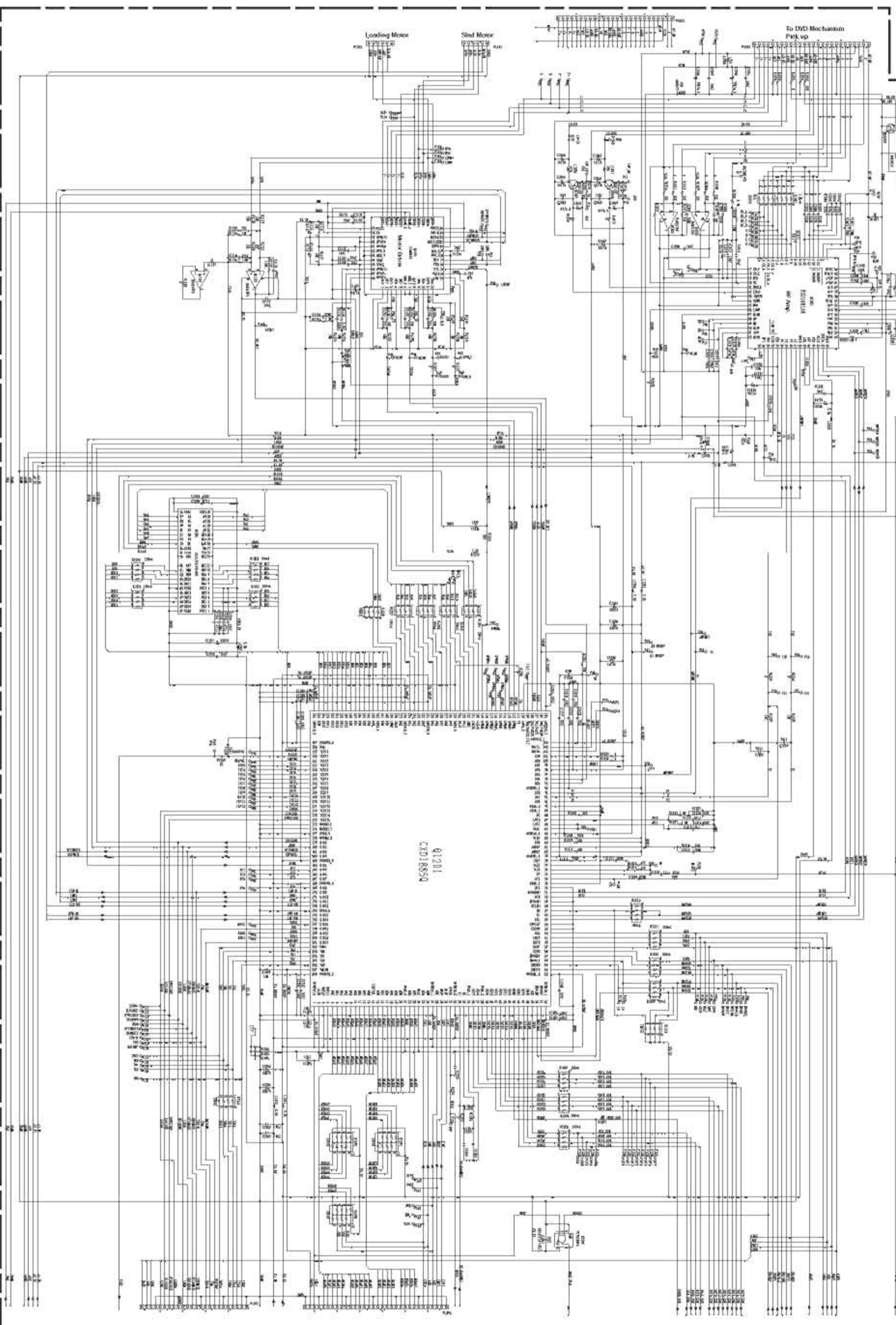

A B C D E F G H

1 2 3 4 5

A

B

C

D

E

F

G

H

SCHEMATIC DIAGRAM

U01 : DVD MAIN BOARD NADG-8257 (2/4)

SACD Section

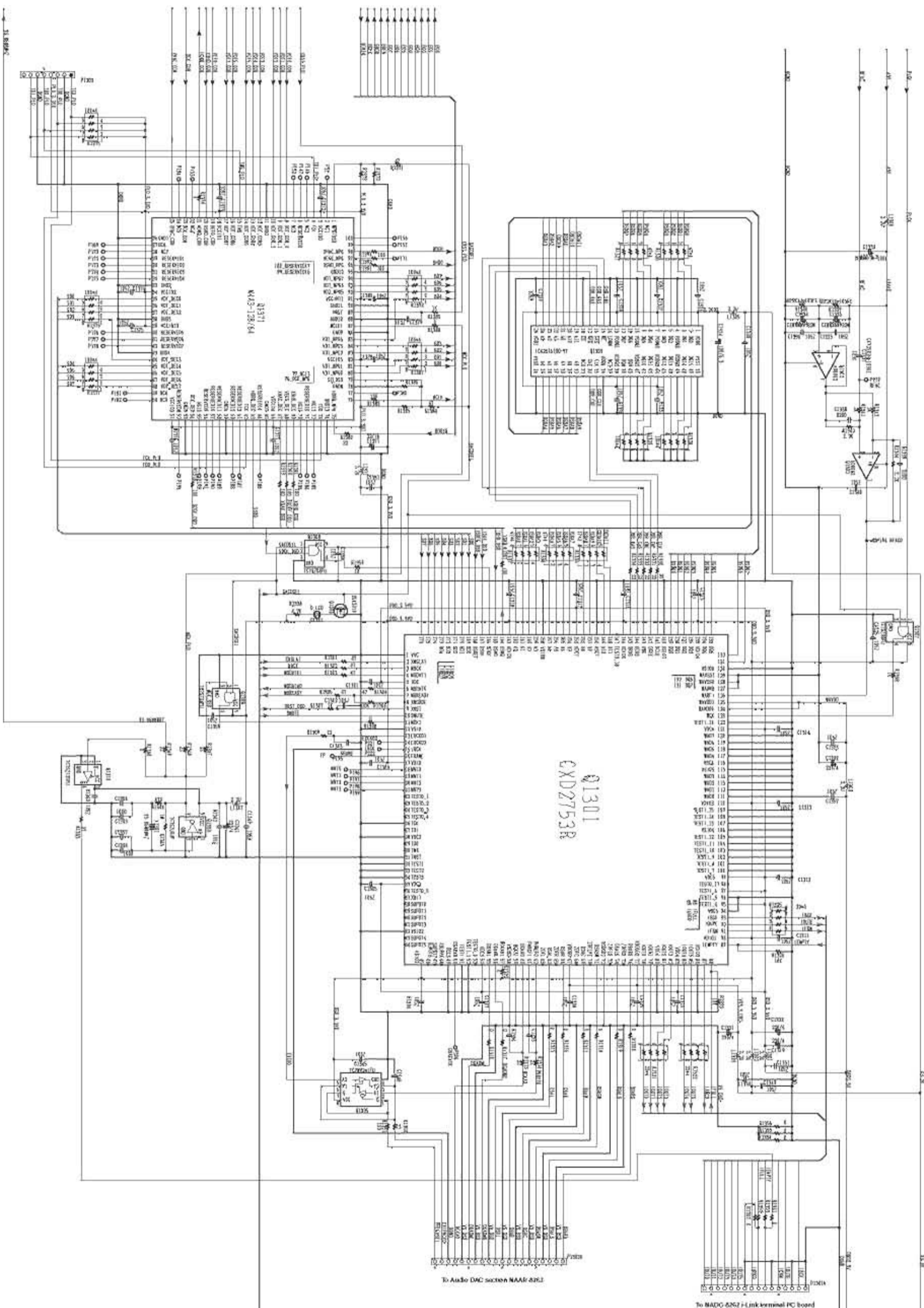

SCHEMATIC DIAGRAM

U01 : DVD MAIN BOARD NADG-8257 (4/4) MPU section

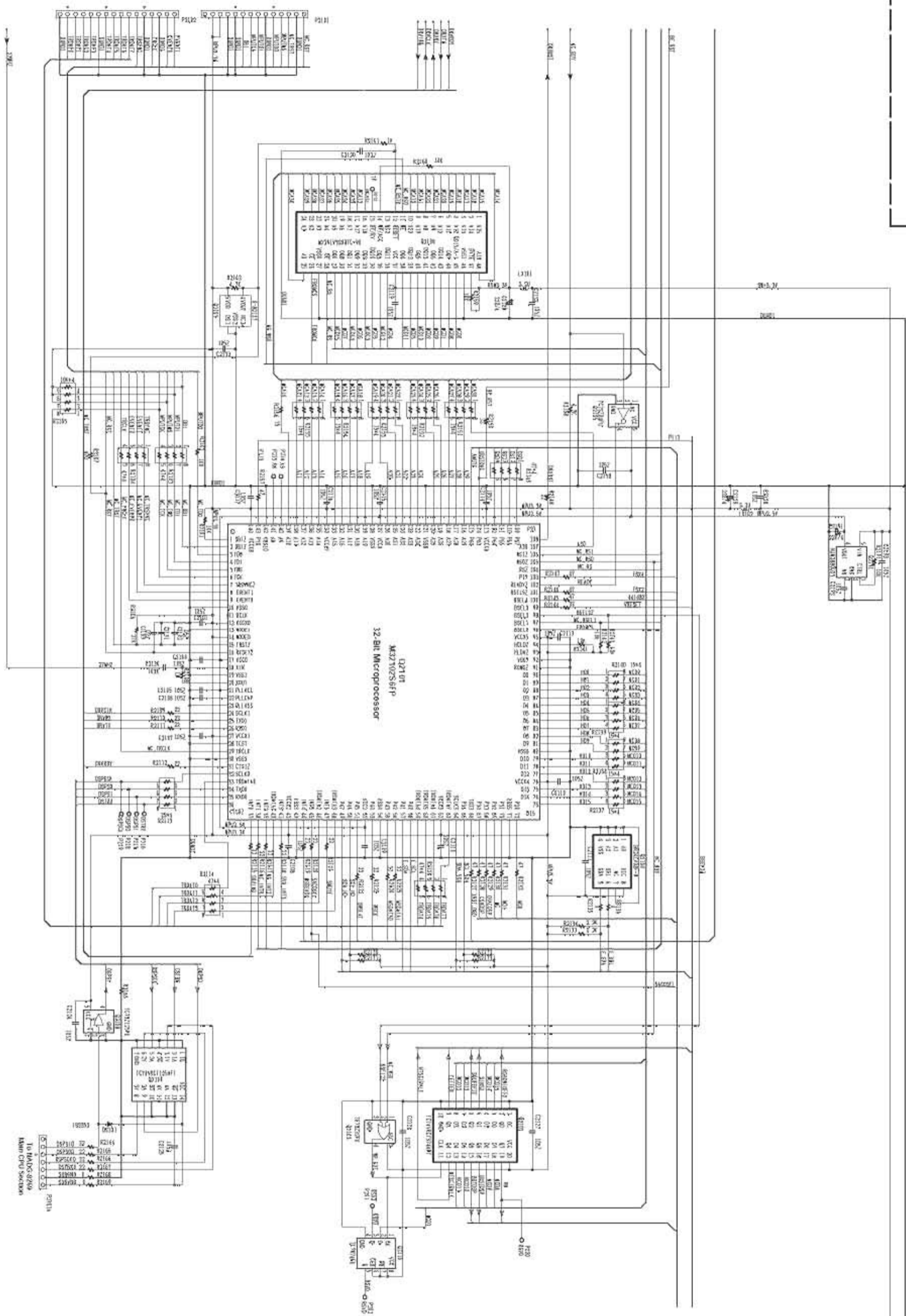

To NADG-8259
Main CPU Section

A

B

C

D

PRINTED CIRCUIT BOARD VIEW

U01 : DVD MAIN PC BOARD NADG-8257

A-side pattern and A-side silk

1

2

3

4

5

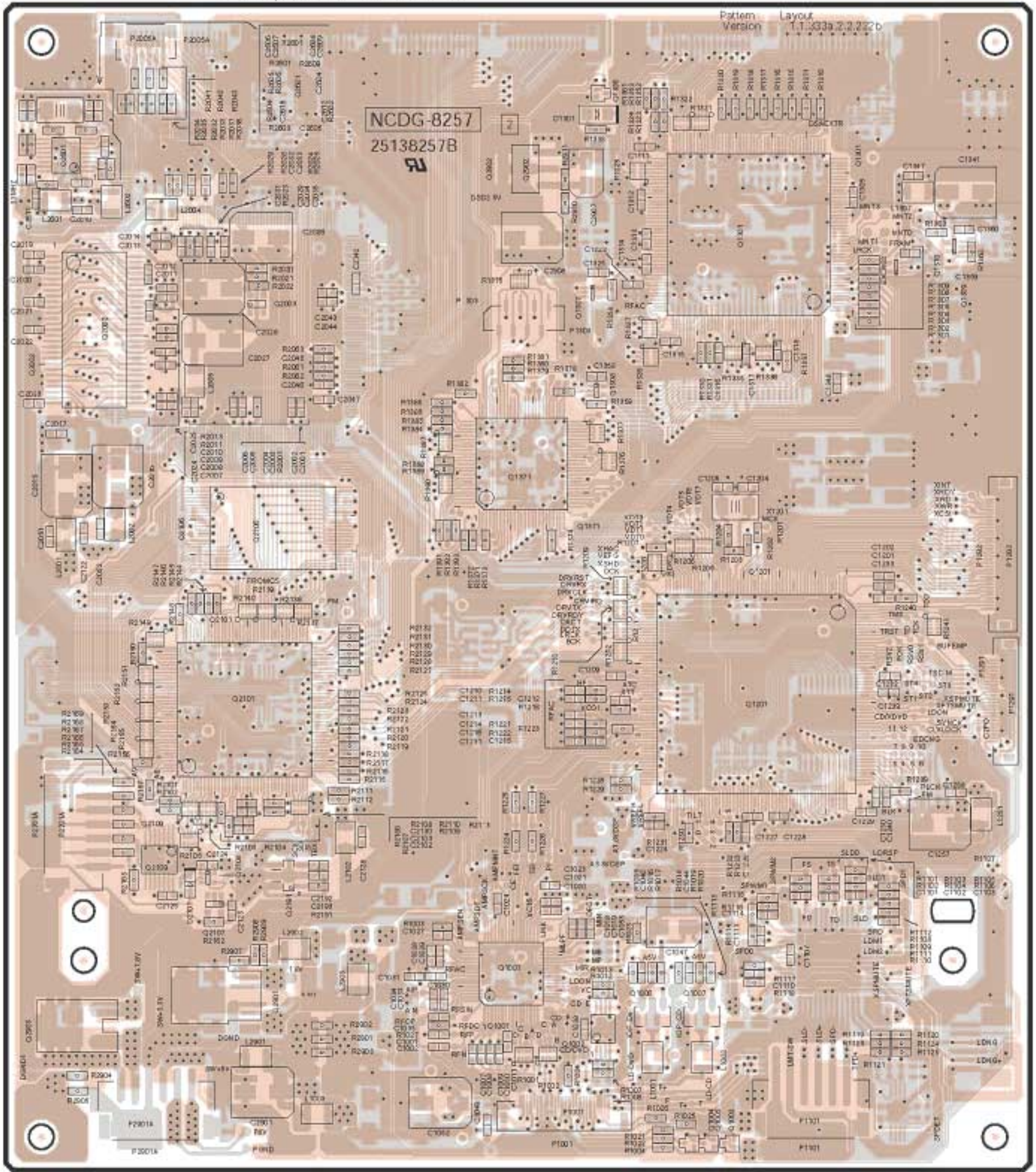

— A-SIDE PATTERN
— B-SIDE PATTERN

A

B

C

D

PRINTED CIRCUIT BOARD VIEW

U01 : DVD MAIN PC BOARD NADG-8257

B-side pattern and B-side silk

1

2

3

4

5

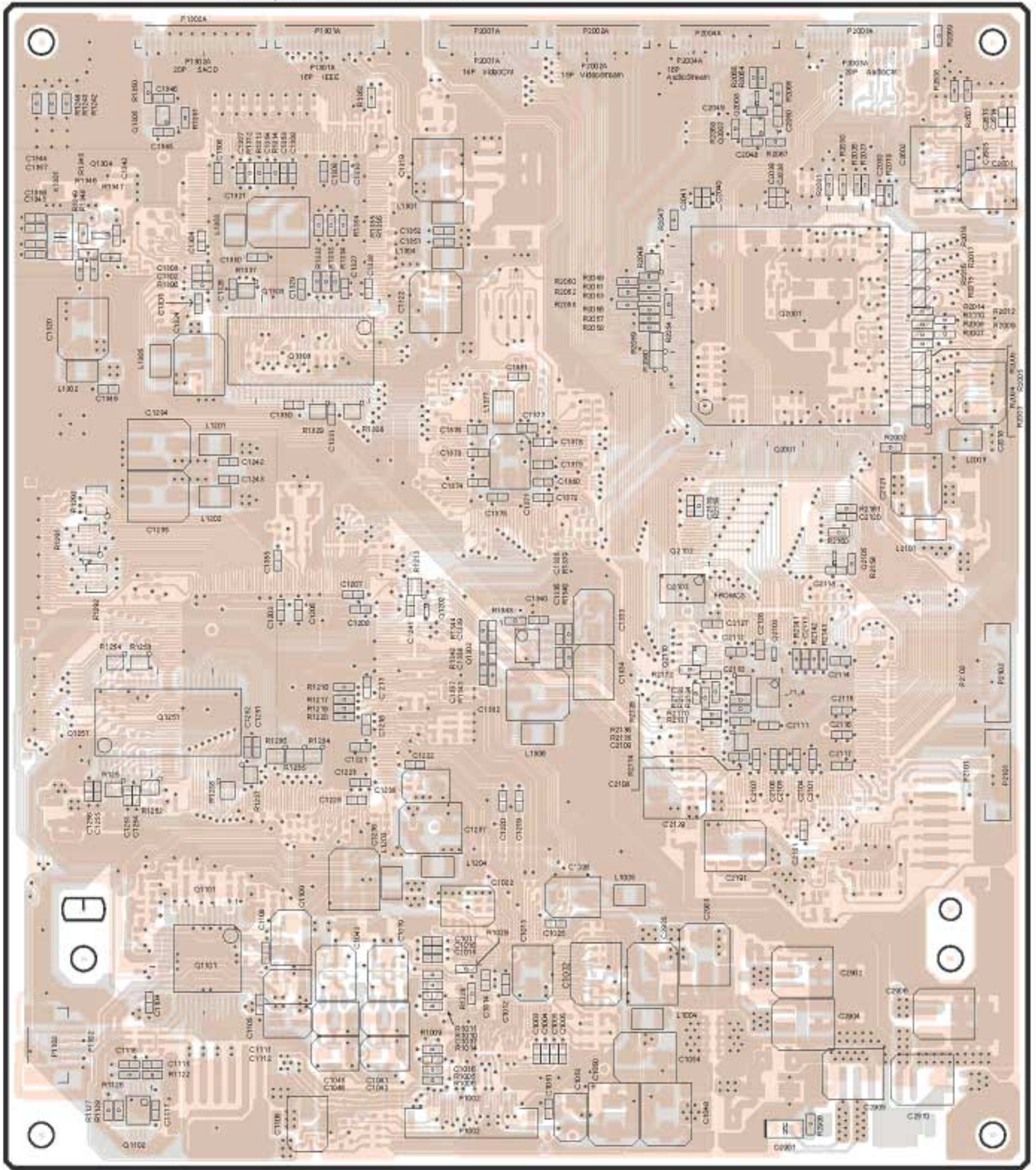

— A-SIDE PATTERN
— B-SIDE PATTERN

A | B | C | D

PRINTED CIRCUIT BOARD VIEW **U13** DIGITAL VIDEO PROCESSOR PC BOARD NADG-82

1
2
3
4
5

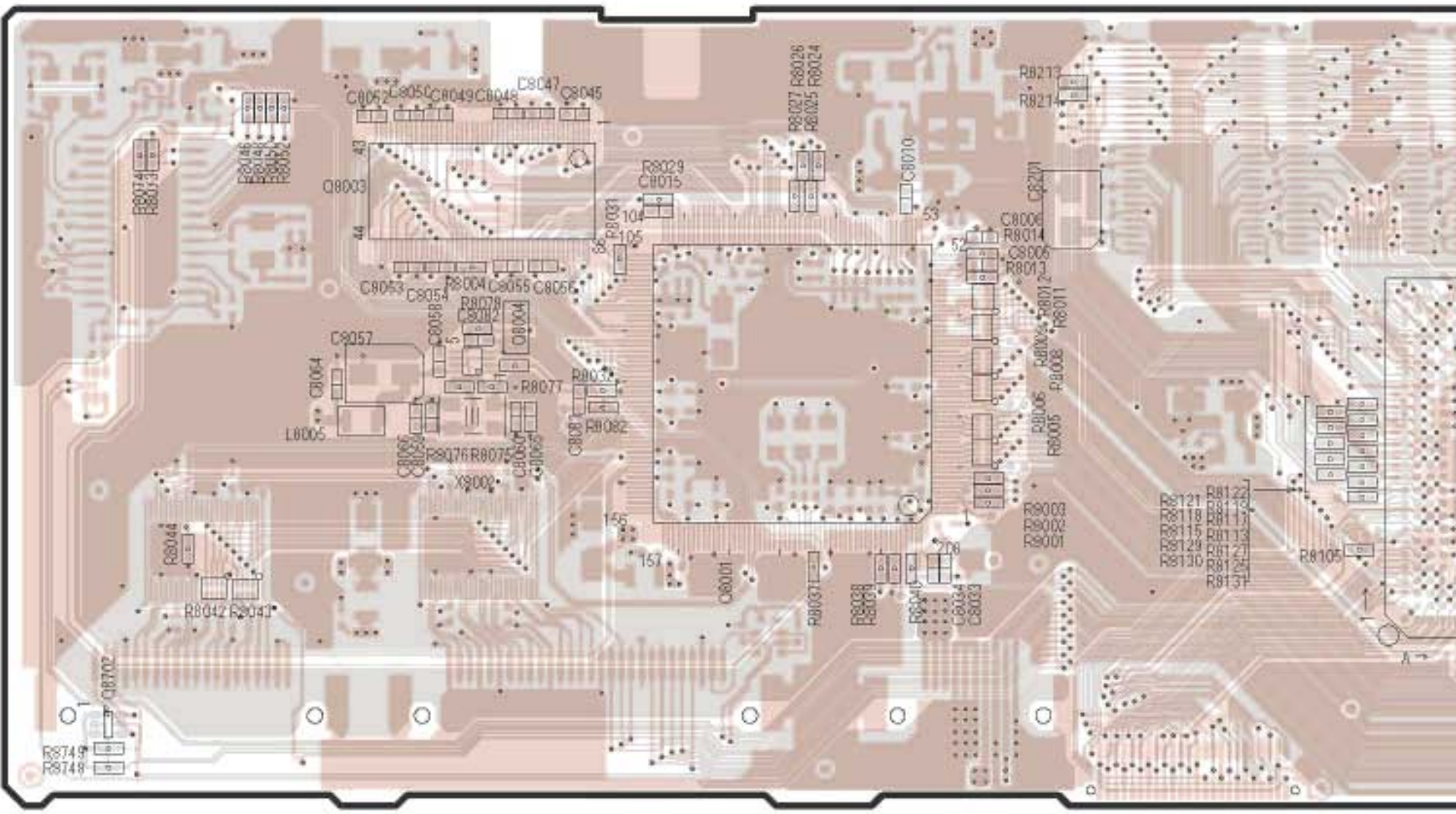
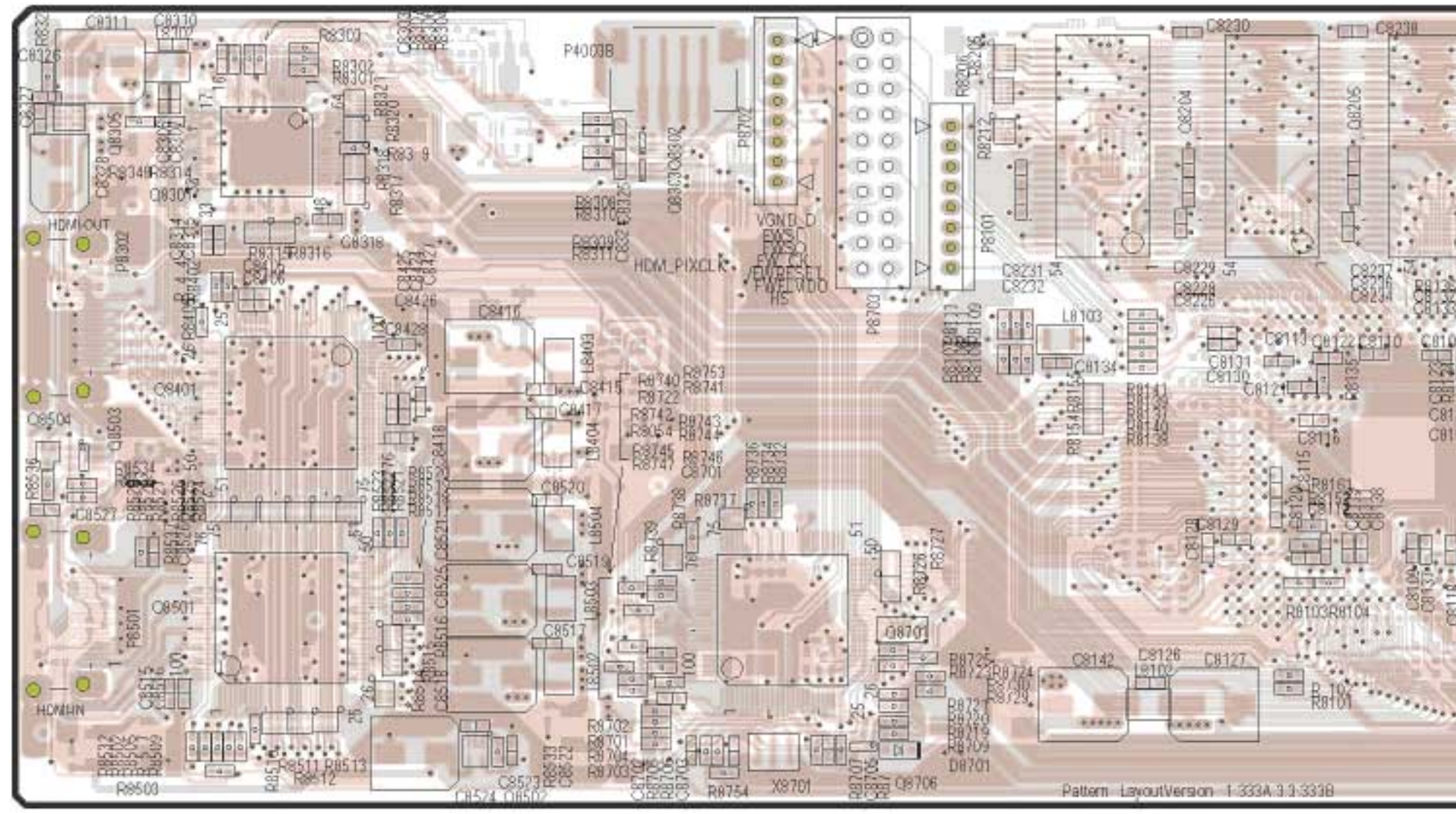

E

F

G

H

8272

A-SIDE VIEW

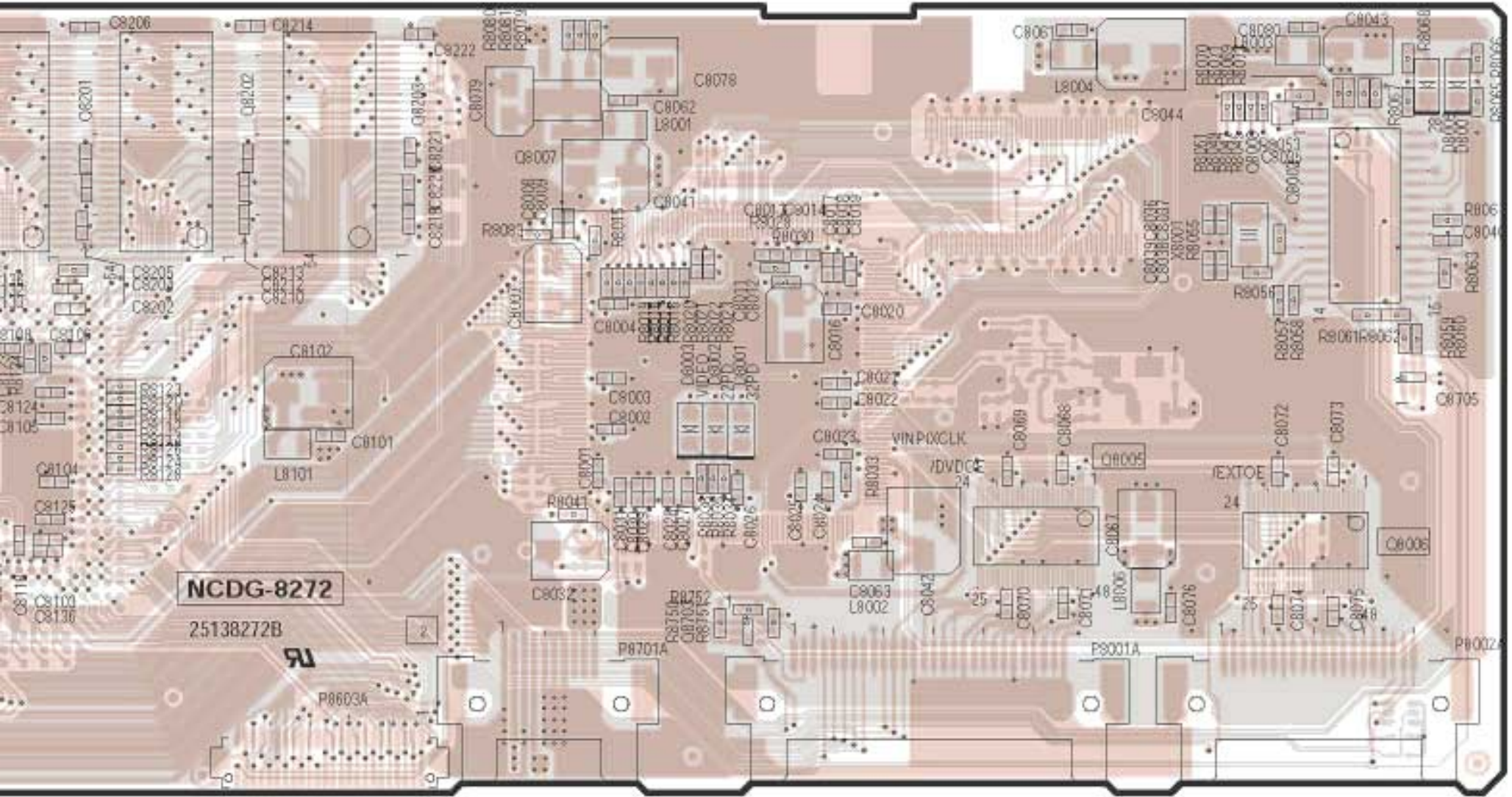

B-SIDE VIEW

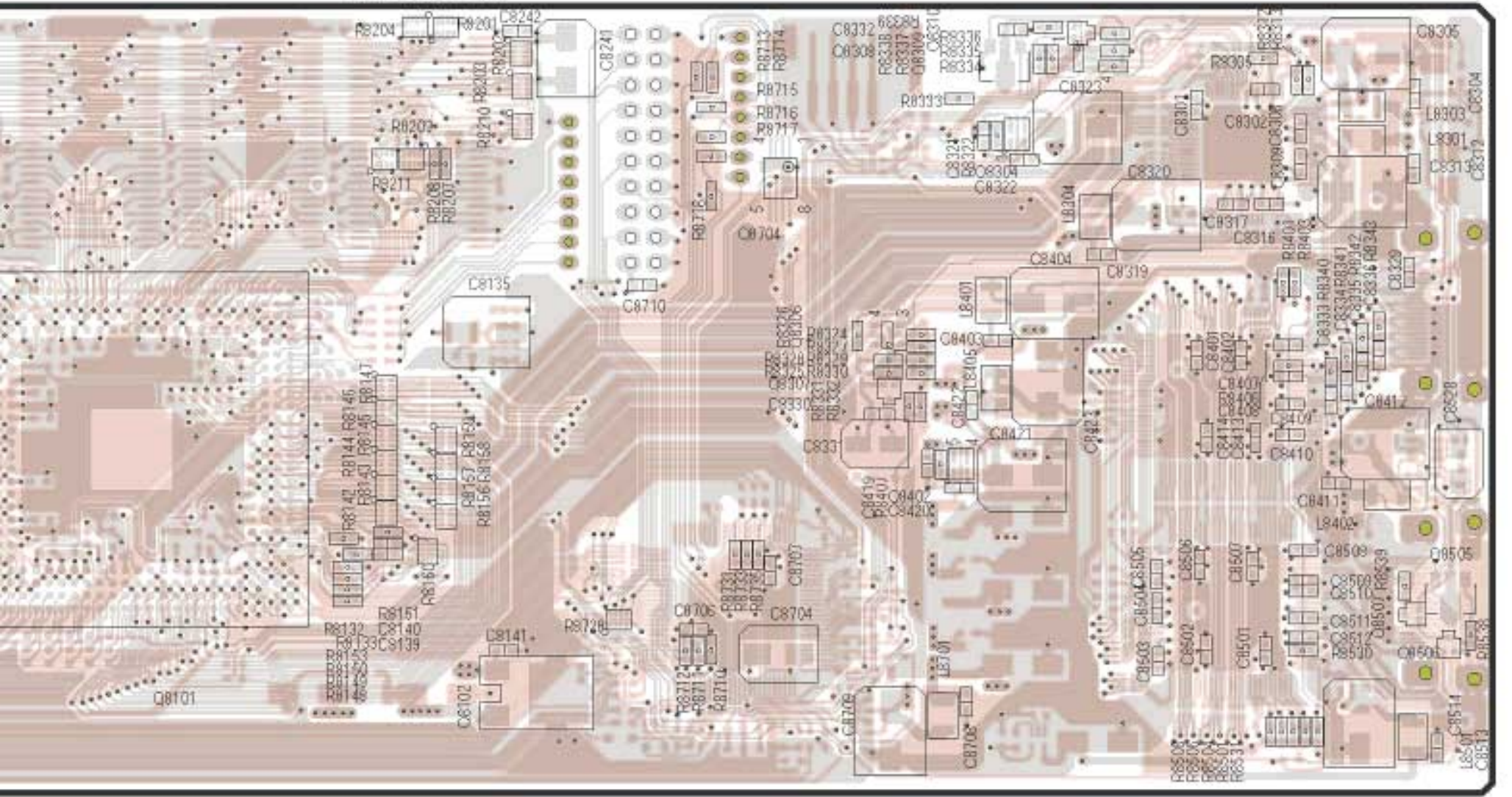

— A-SIDE PATTERN — B-SIDE PATTERN

A B C D
PRINTED CIRCUIT BOARD VIEW

1
U18 : AUDIO DAC PC BOARD NAAR-8263

A-SIDE VIEW

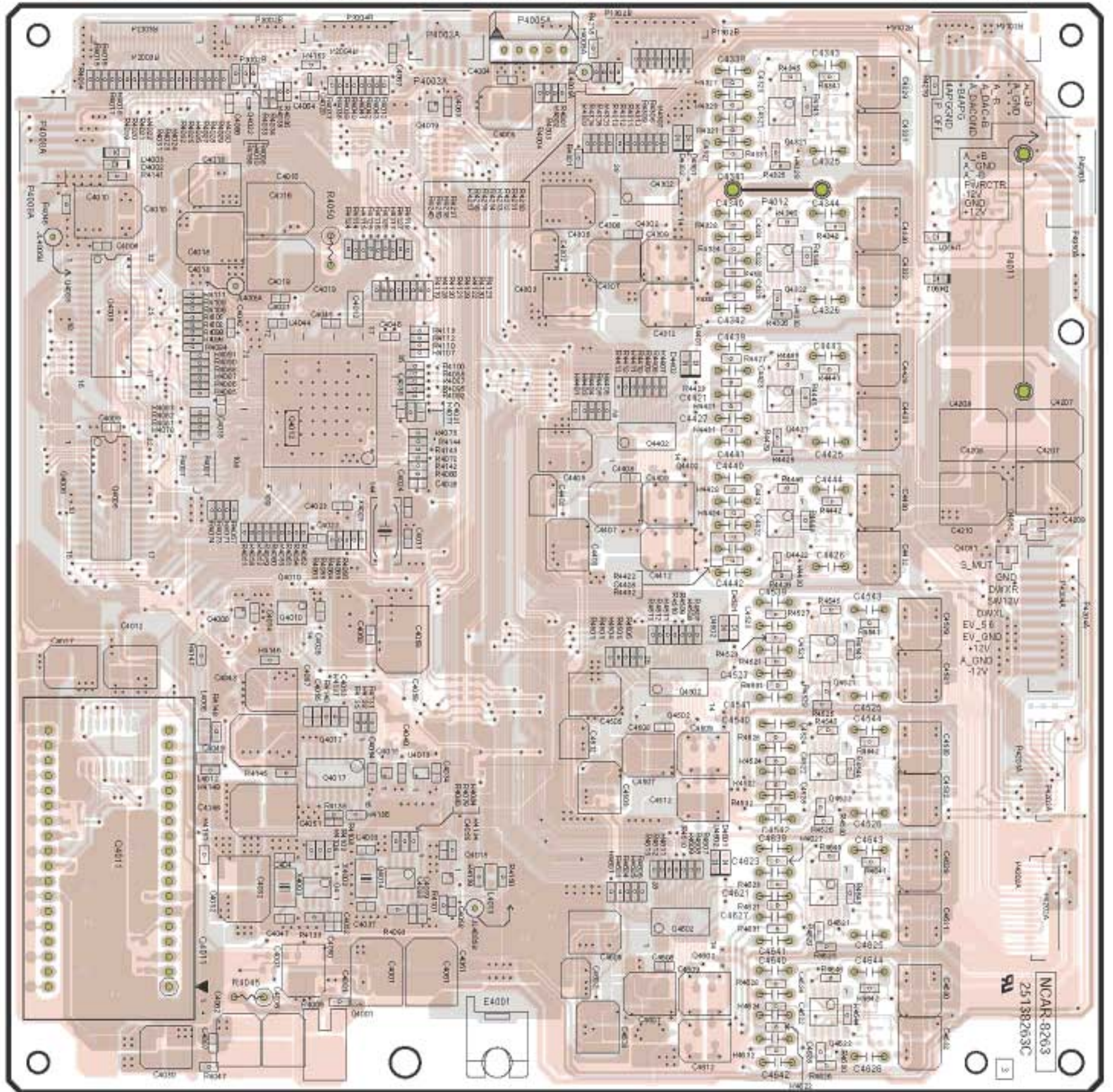

2
3
4
5
A-SIDE PATTERN
B-SIDE PATTERN

A B C D
PRINTED CIRCUIT BOARD VIEW

1

U18 : AUDIO DAC PC BOARD NAAR-8263

B-SIDE VIEW

2

3

4

5

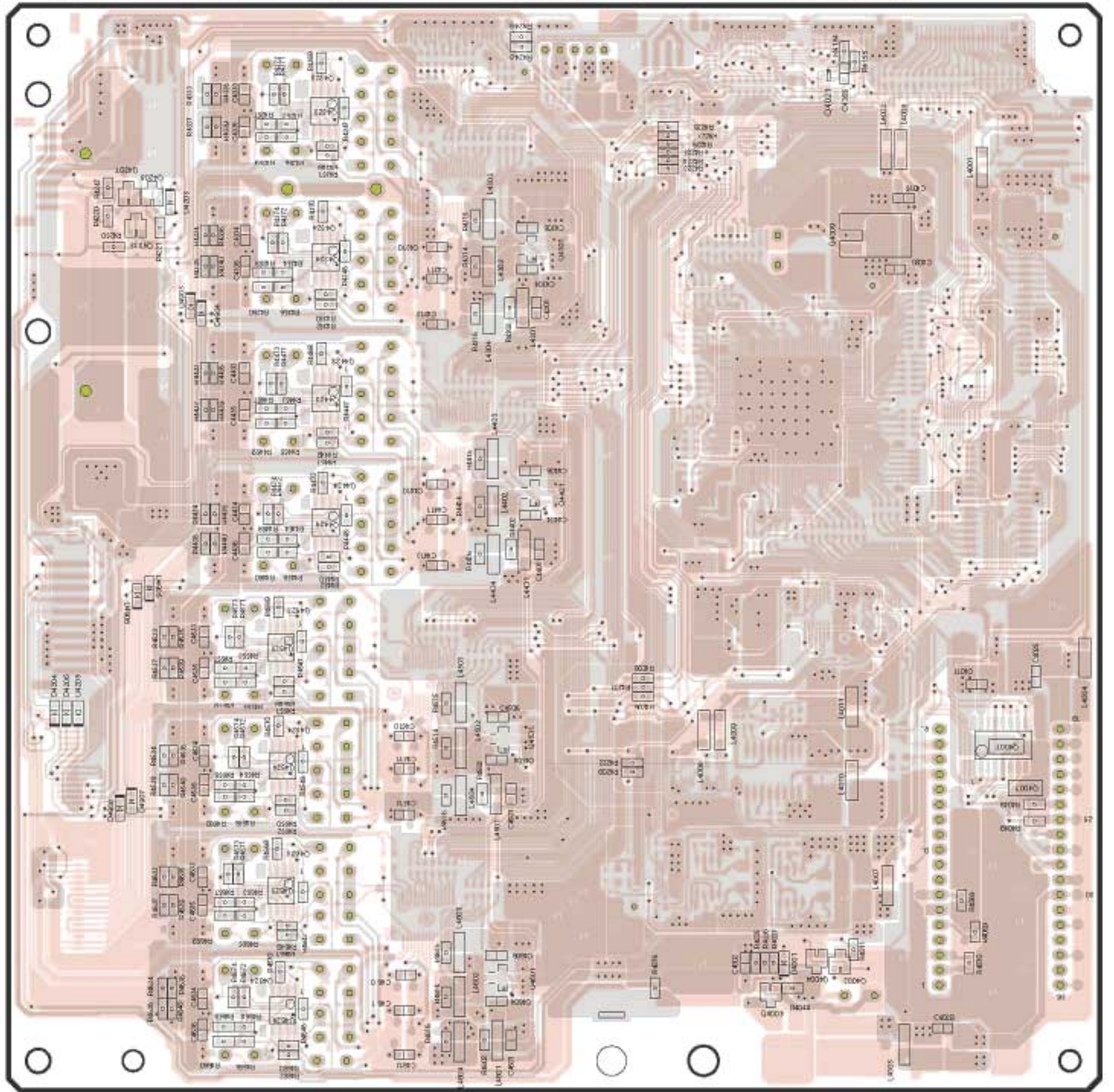

— A-SIDE PATTERN
— B-SIDE PATTERN

A

B

C

D

PRINTED CIRCUIT BOARD VIEW

U03 DVD MAIN CPU PC BOARD NADG-8259

1

2

3

4

5

A-SID

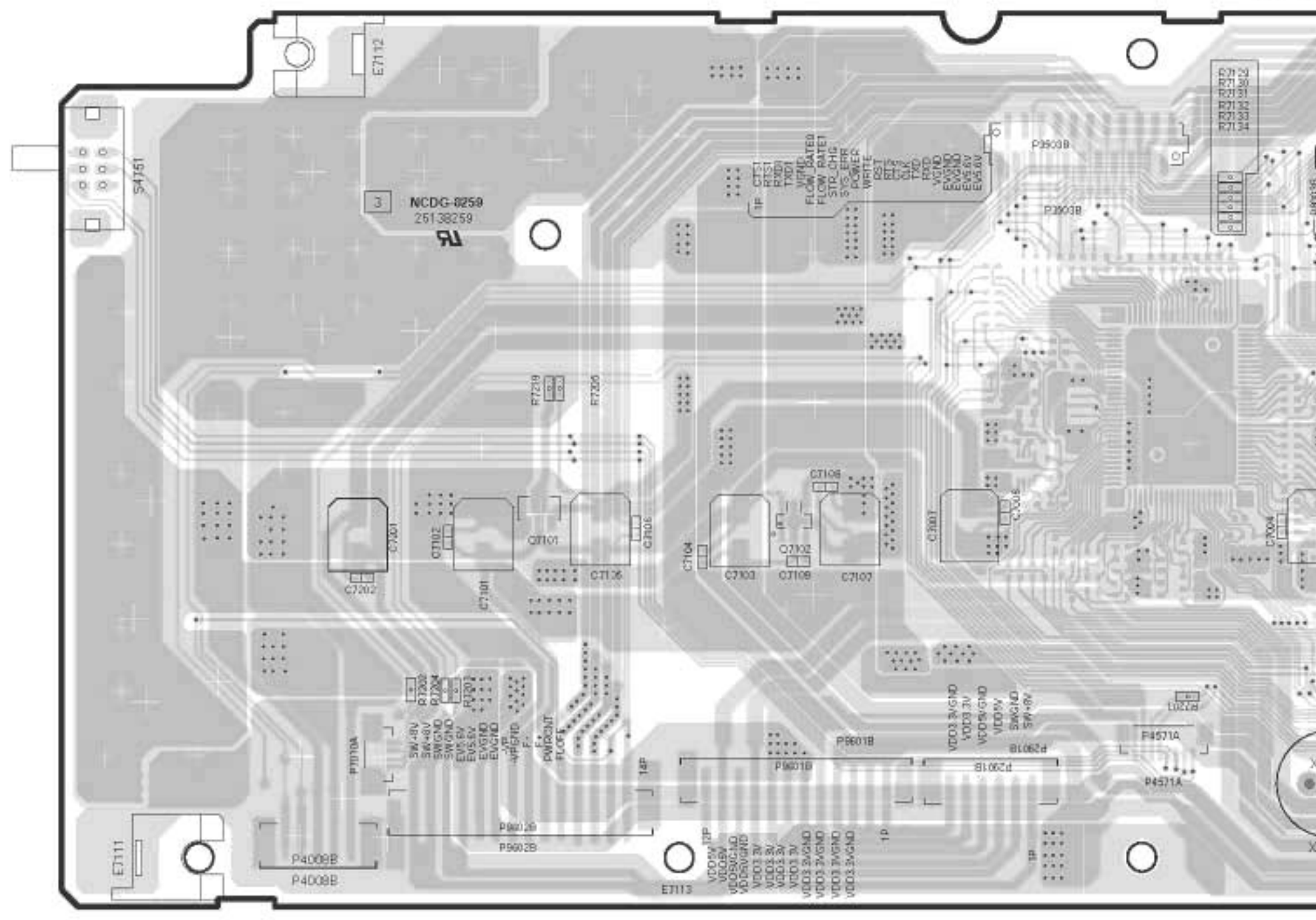

E

F

G

H

DE VIEW

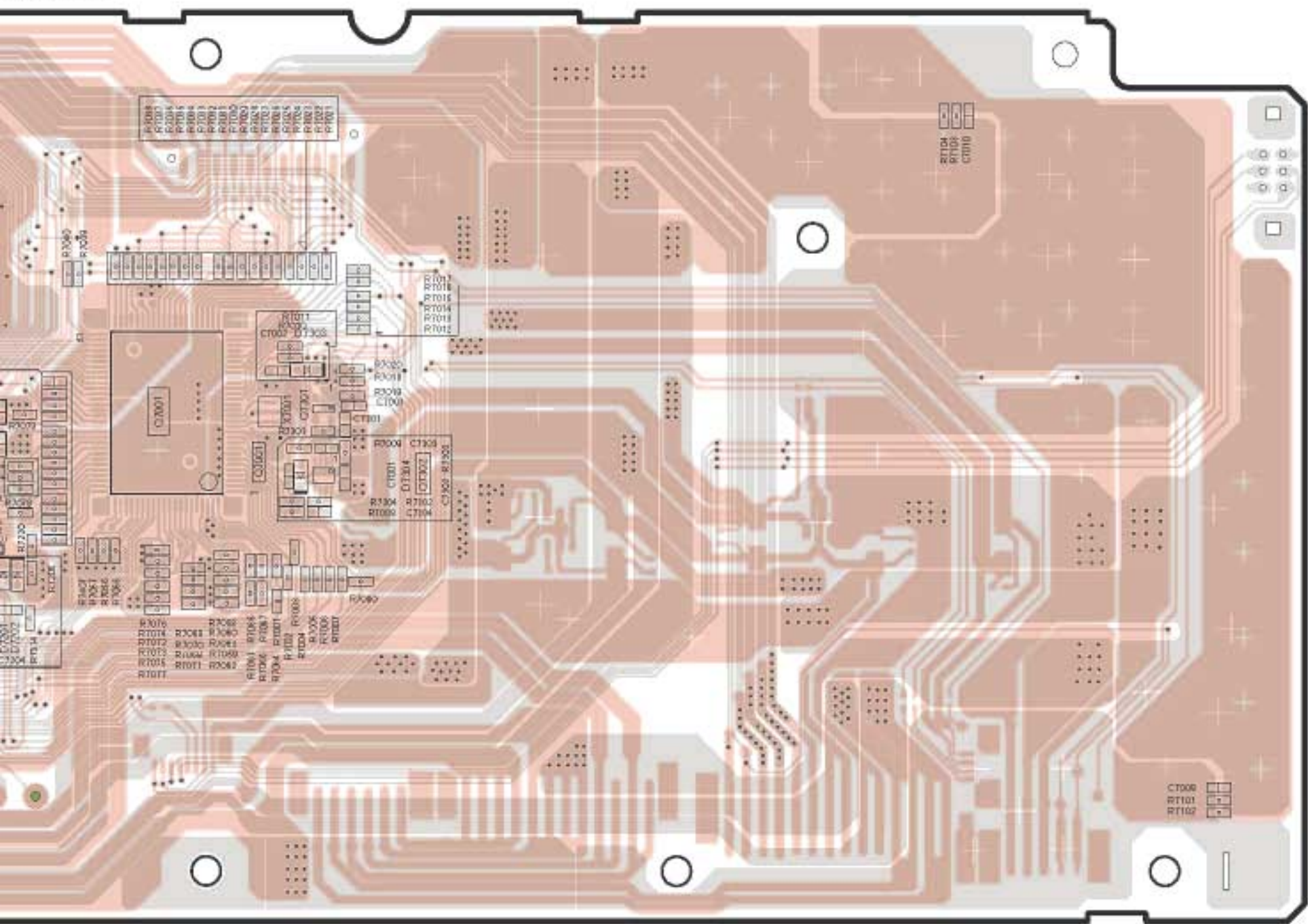

A-SIDE PATTERN
 B-SIDE PATTERN

A

B

C

D

PRINTED CIRCUIT BOARD VIEW

U20

1 IEEE1394 TERMINAL
PC BOARD
NADG-8262

FROM A-SIDE VIEW

1

2

3

4

5

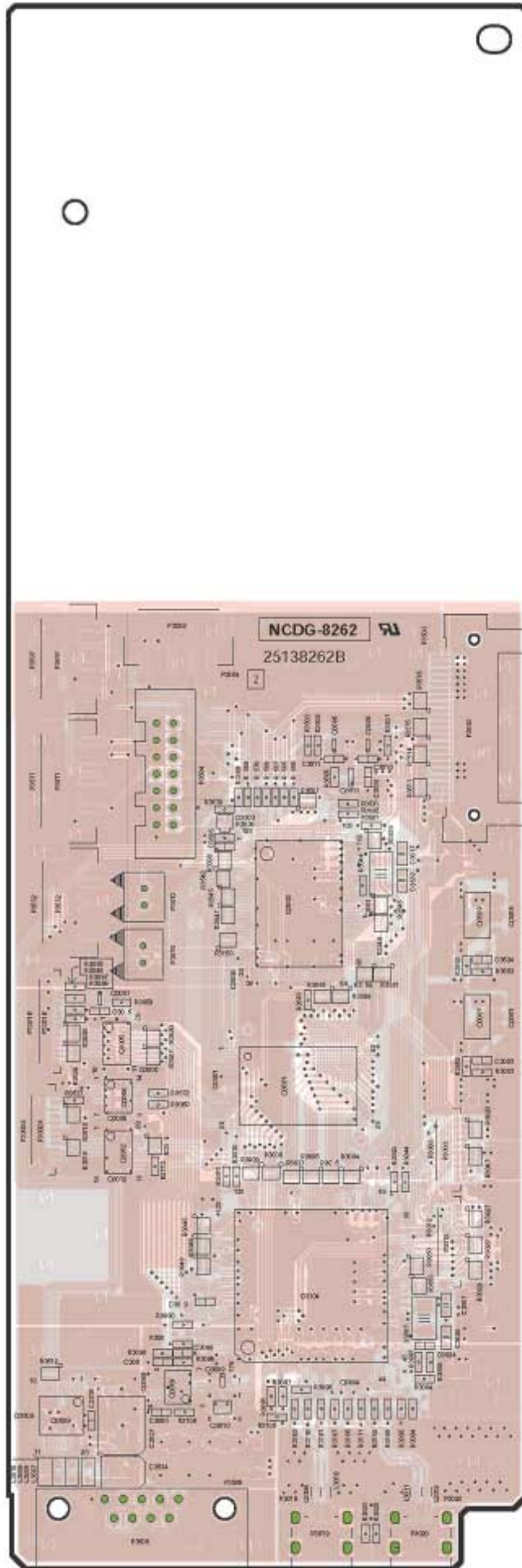

A-SIDE PATTERN
B-SIDE PATTERN

A

B

C

D

PRINTED CIRCUIT BOARD VIEW

U20

1 IEEE1394 TERMINAL
PC BOARD
NADG-8262

FROM B-SIDE VIEW

2

3

4

5

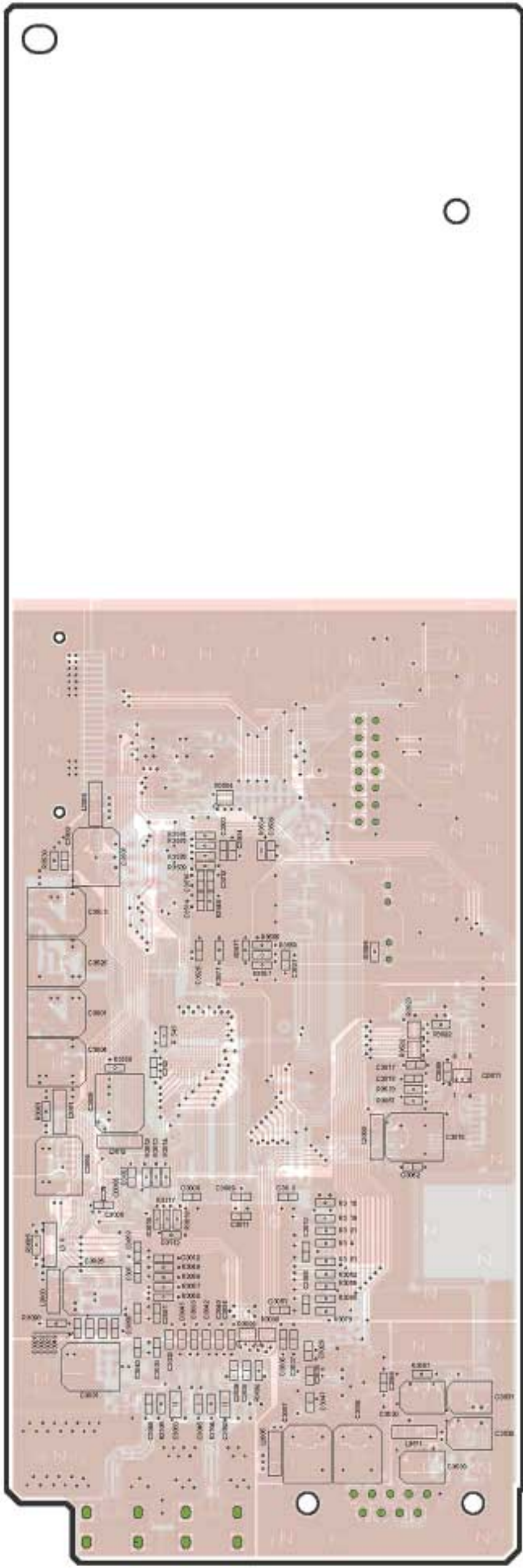

— A-SIDE PATTERN
— B-SIDE PATTERN

A

B

C

D

PRINTED CIRCUIT BOARD VIEW

1

U07 DISPLAY PC BOARD NADIS-8264

2

A-SIDE VIEW

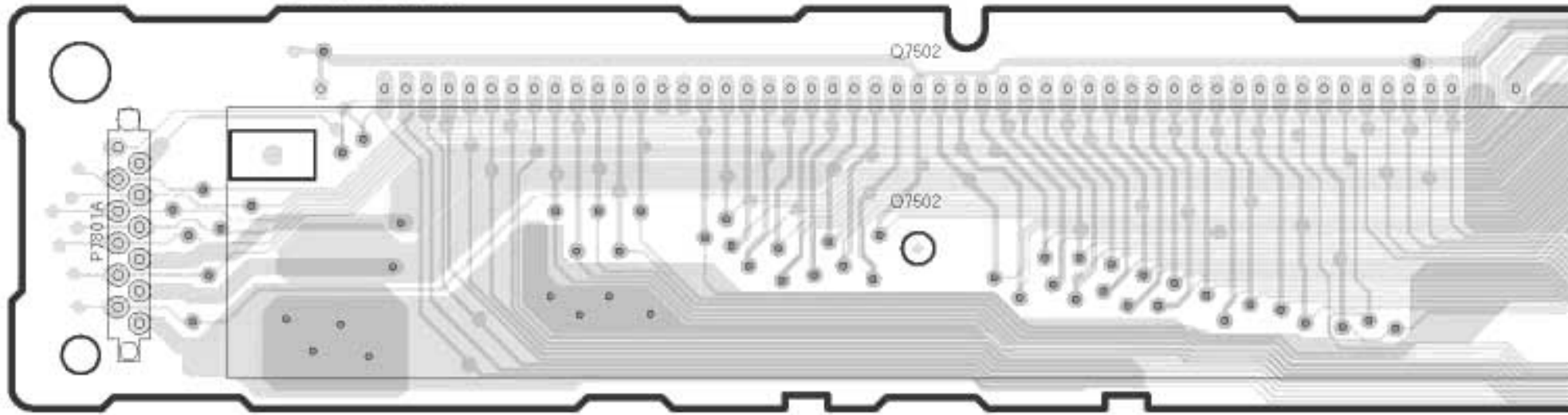

3

— A-SIDE
— B-SIDE

4

5

PRINTED CIRCUIT BOARD VIEW
U04 COMPONENT OUTPUT TERMINAL BOARD
NAETC-8260

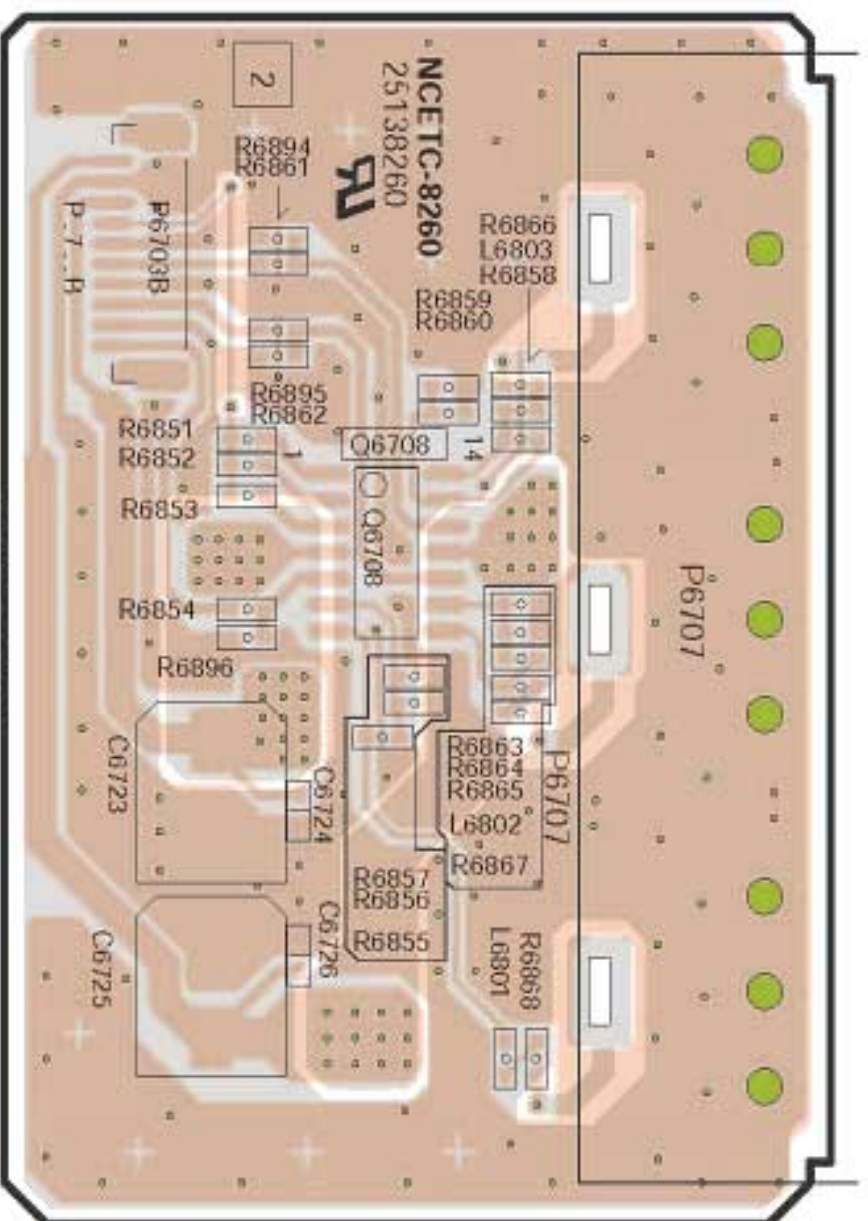

A-SIDE VIEW

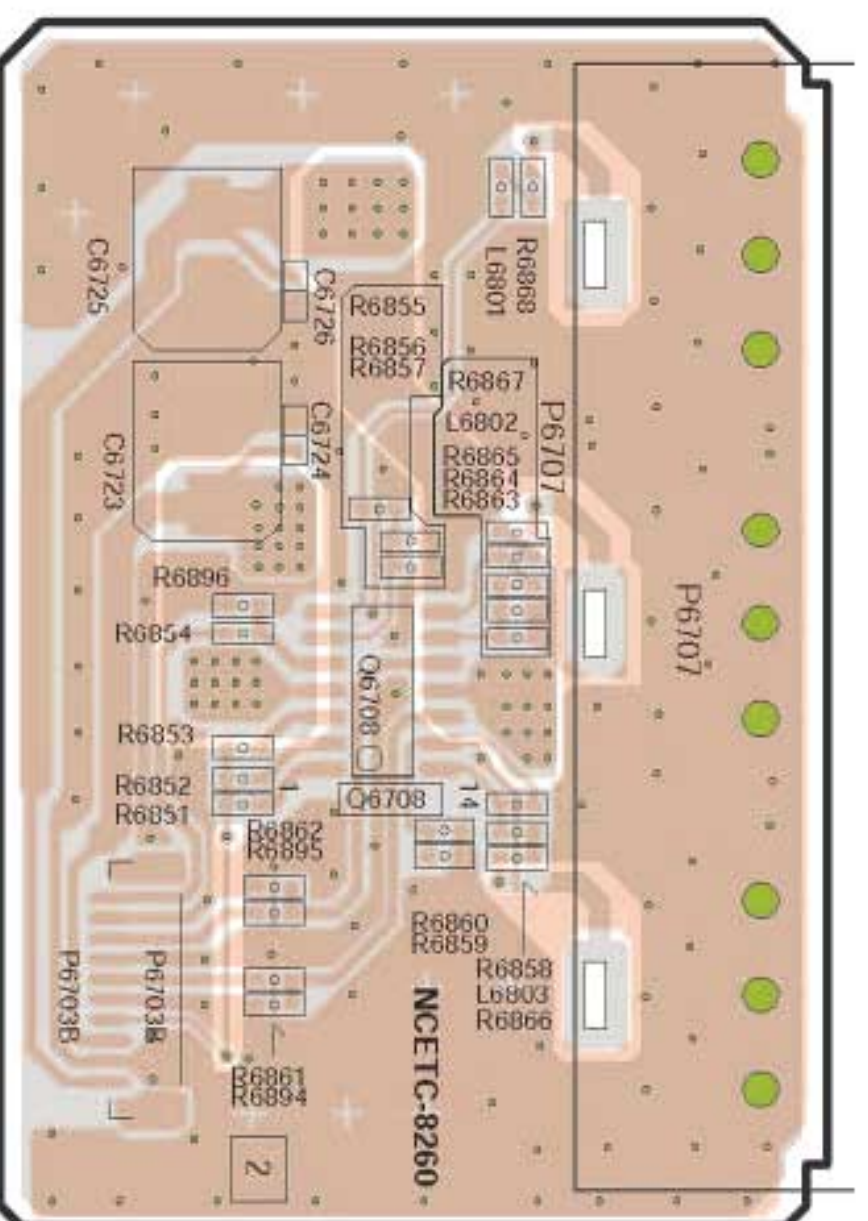

B-SIDE VIEW

— A-SIDE PATTERN
— B-SIDE PATTERN

A B C D
PRINTED CIRCUIT BOARD VIEW

U12 POWER SUPPLY PC BOARD-1 NAPS-8269

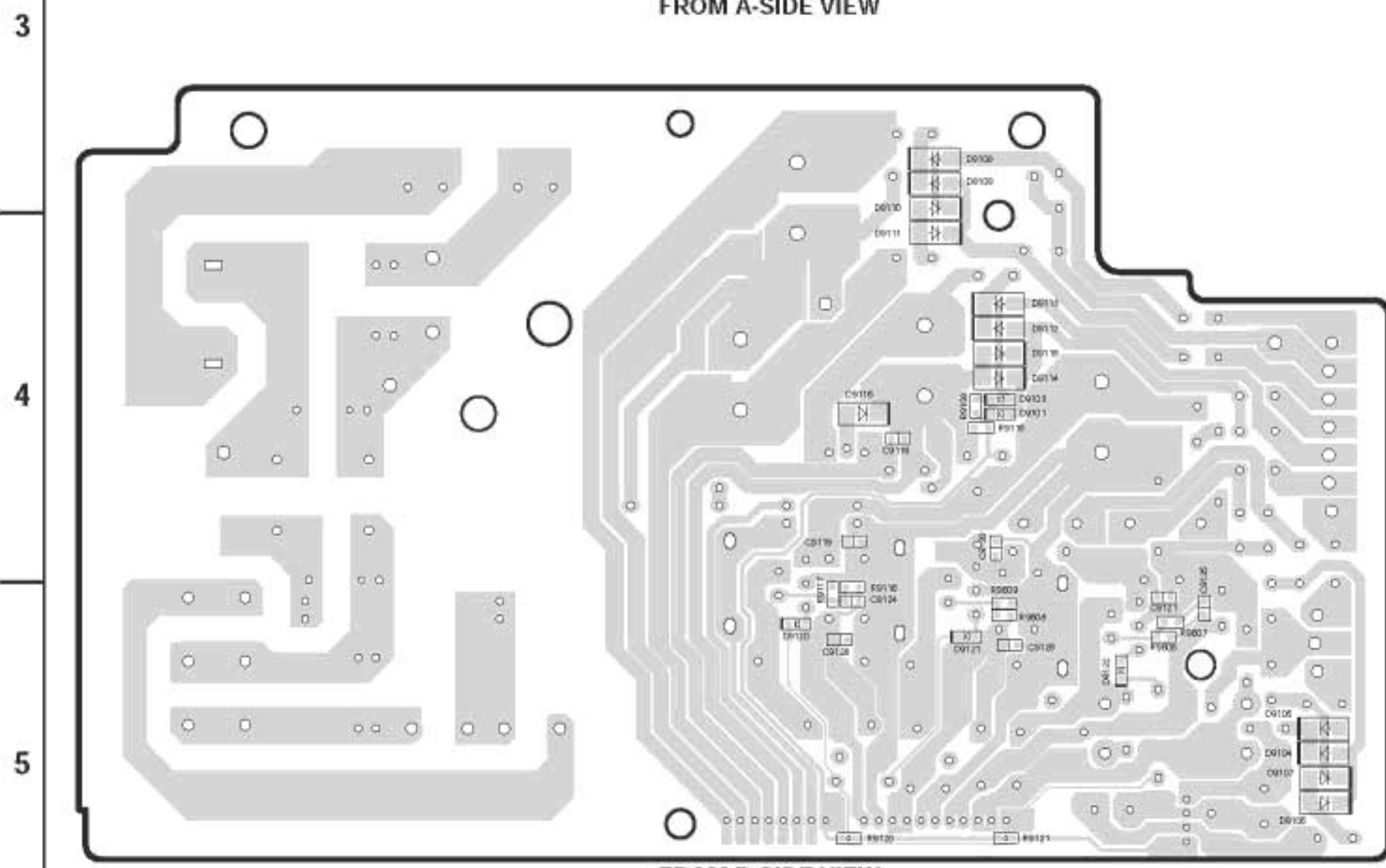
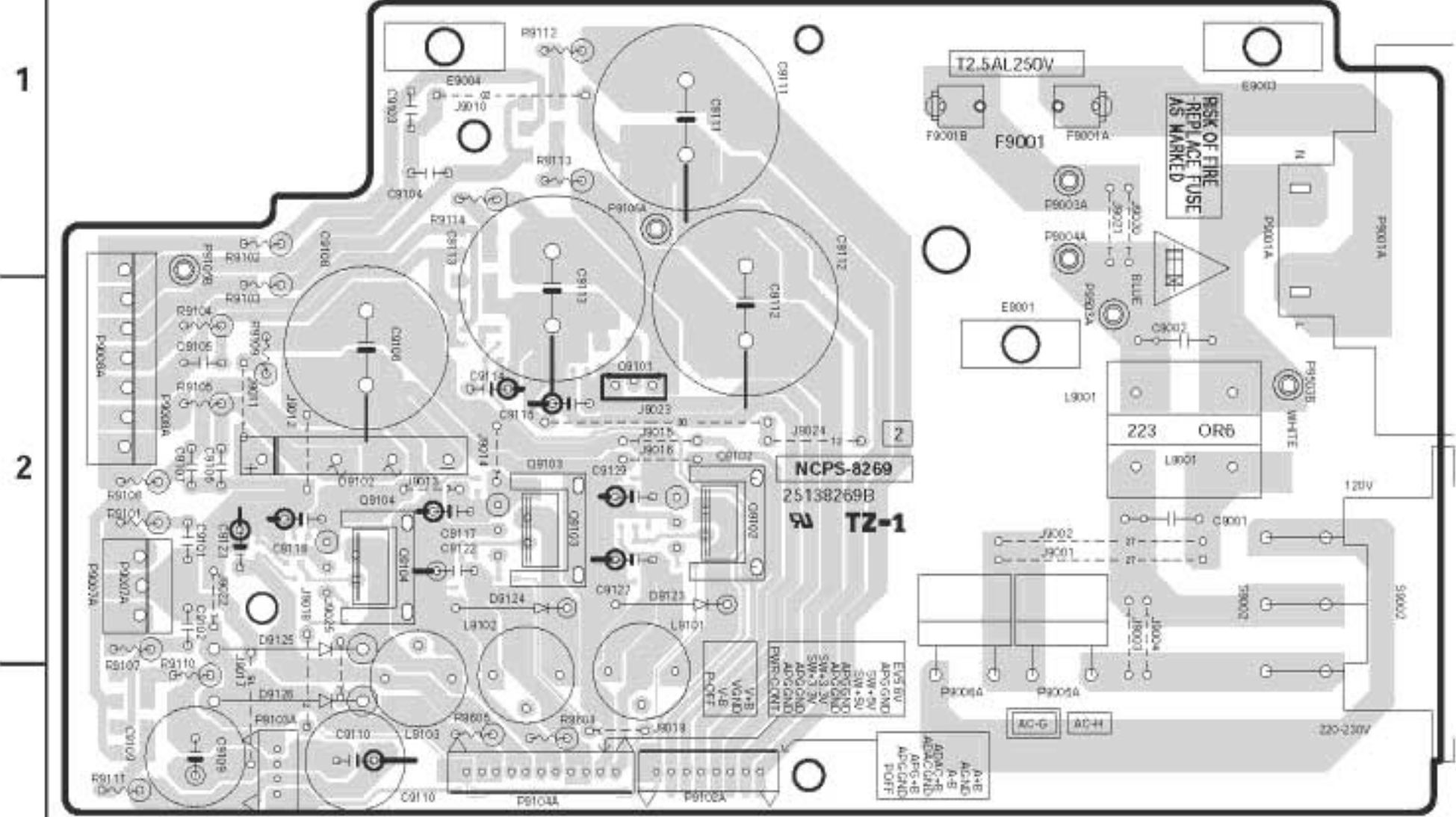

A B C D
PRINTED CIRCUIT BOARD VIEW **U13** POWER SUPPLY PC BOARD-2 NAPS-8270

FROM TOP VIEW

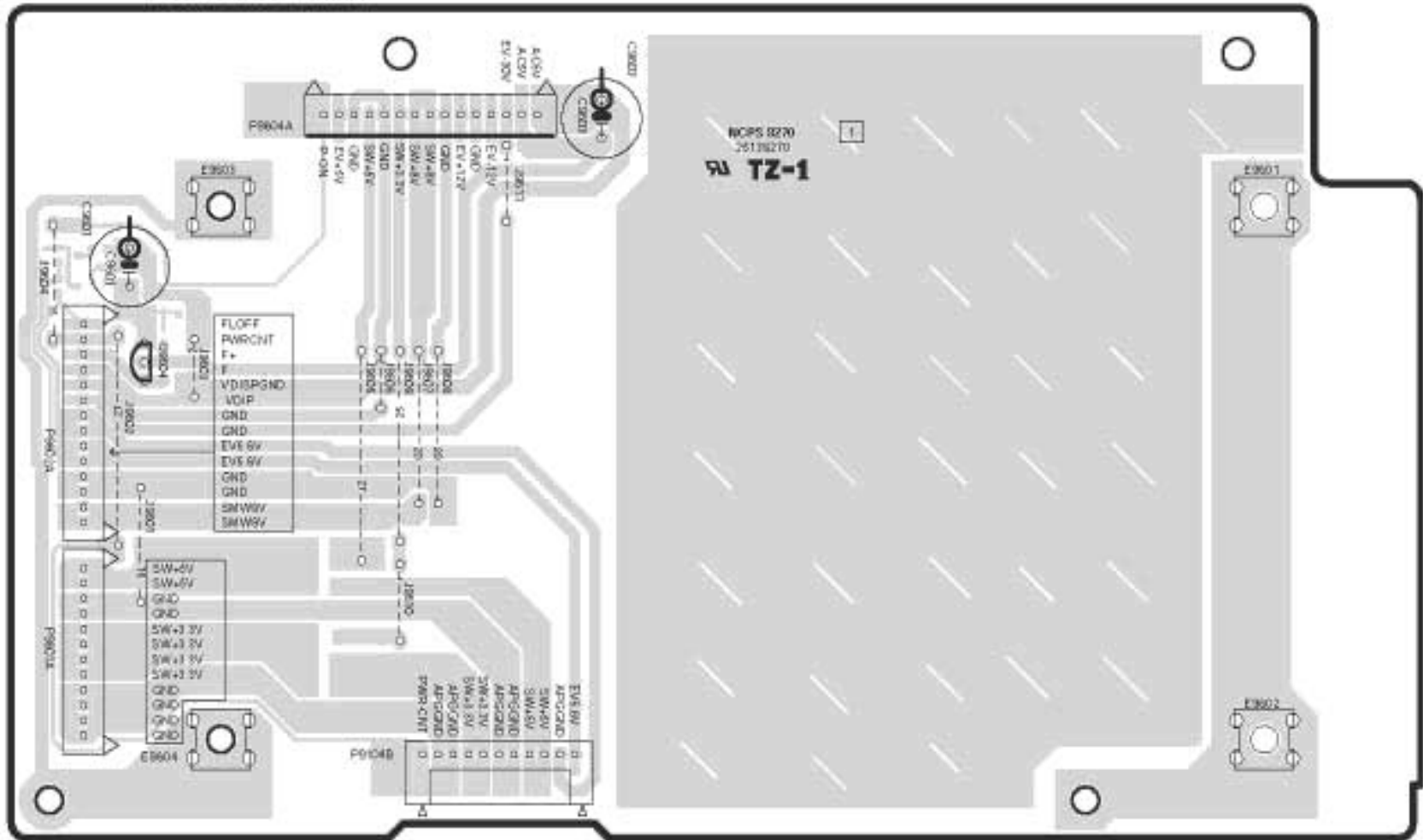

FROM BOTTOM VIEW

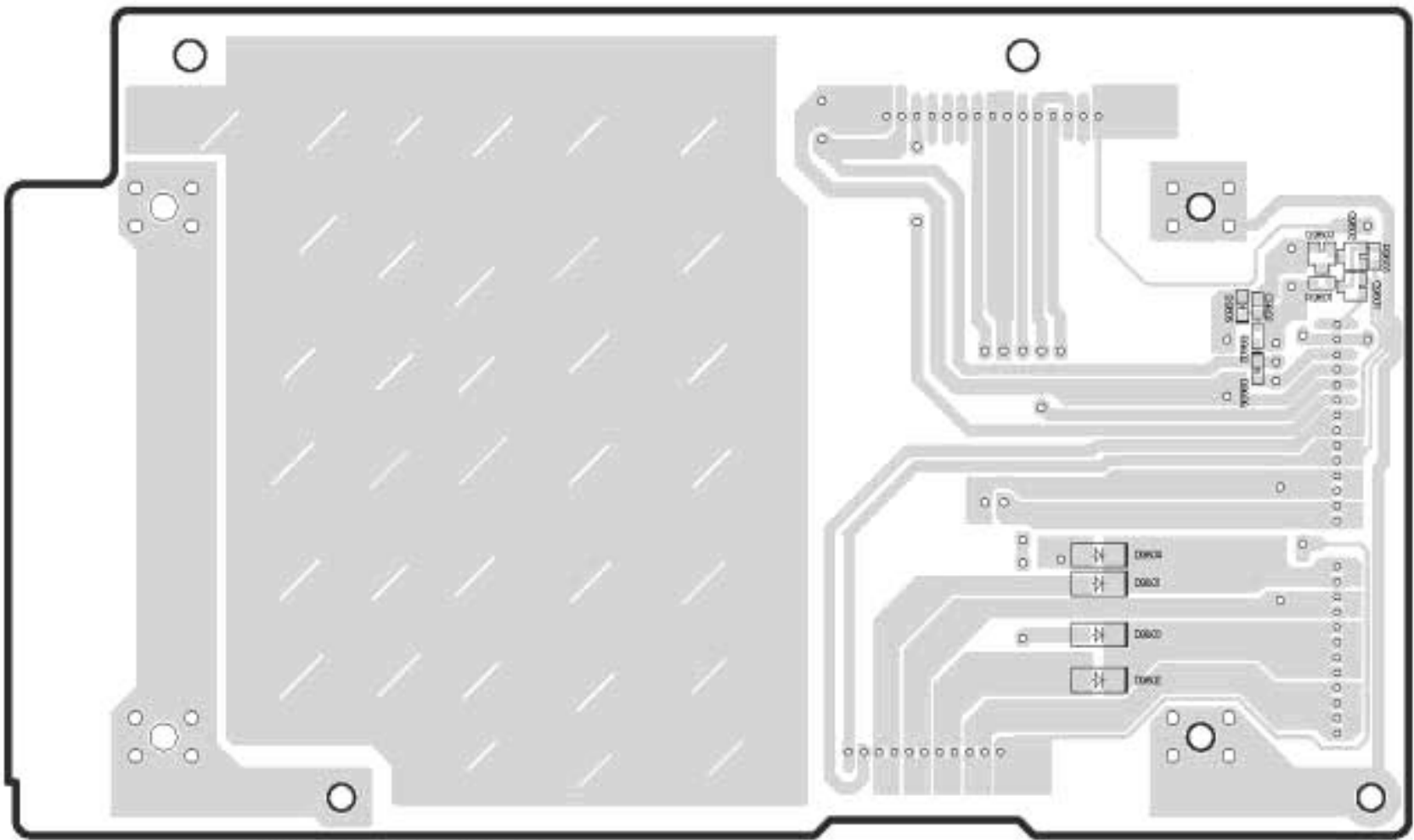

PRINTED CIRCUIT BOARD VIEW **U10** JOG SWITCH PC BOARD NASW-8267

1
2
3
4
5

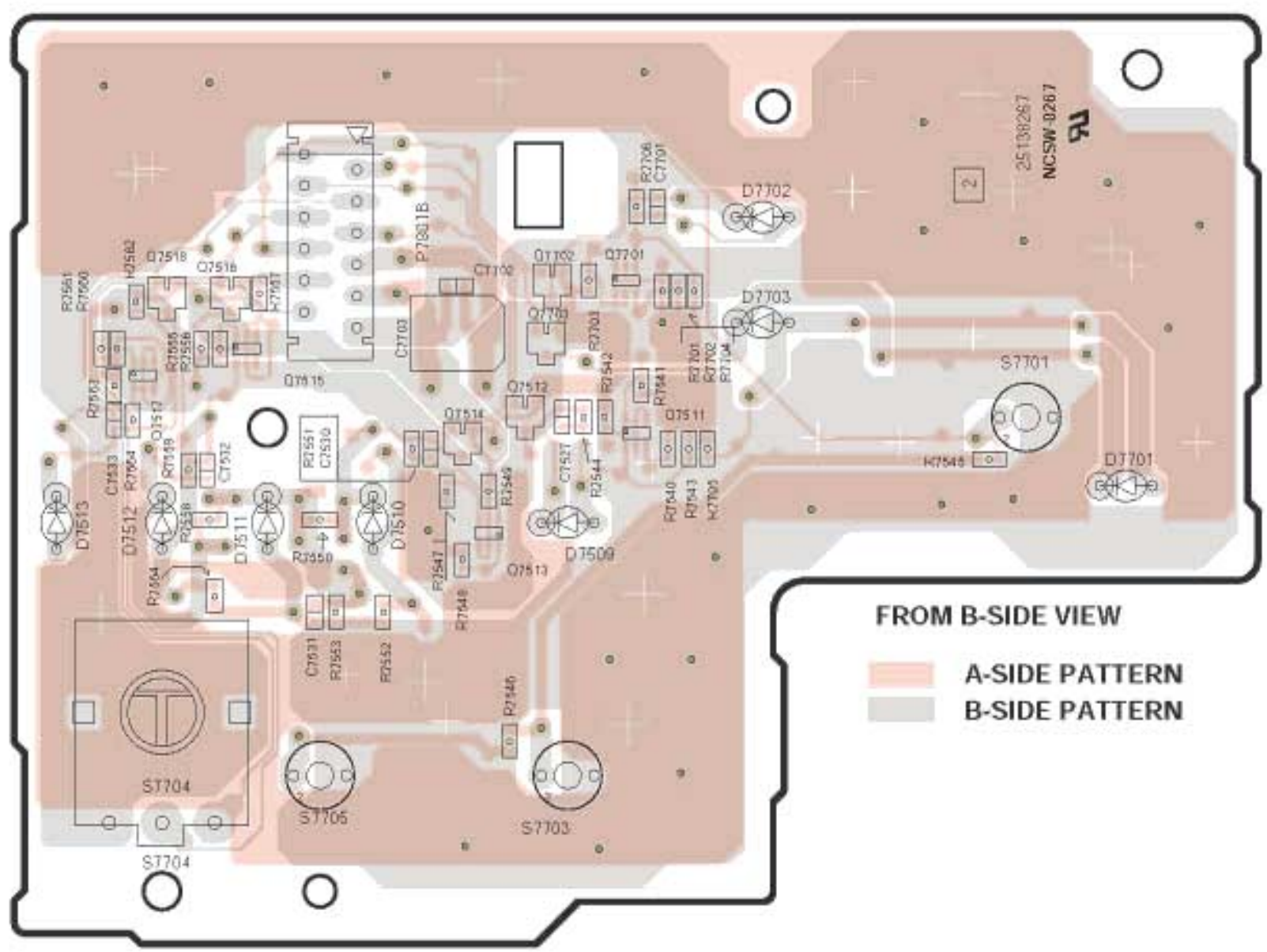
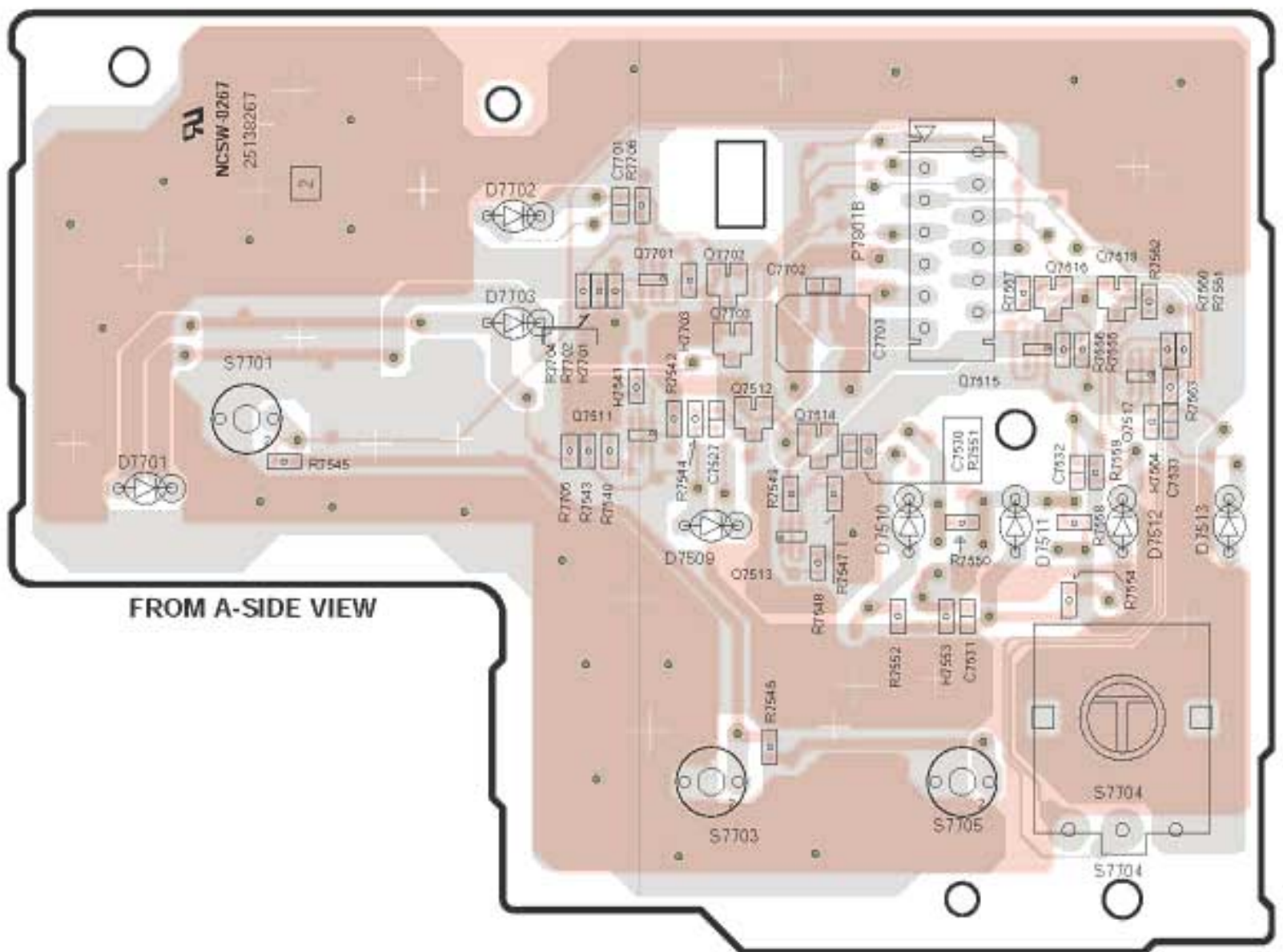

FROM B-SIDE VIEW
A-SIDE PATTERN
B-SIDE PATTERN

PACKING VIEW

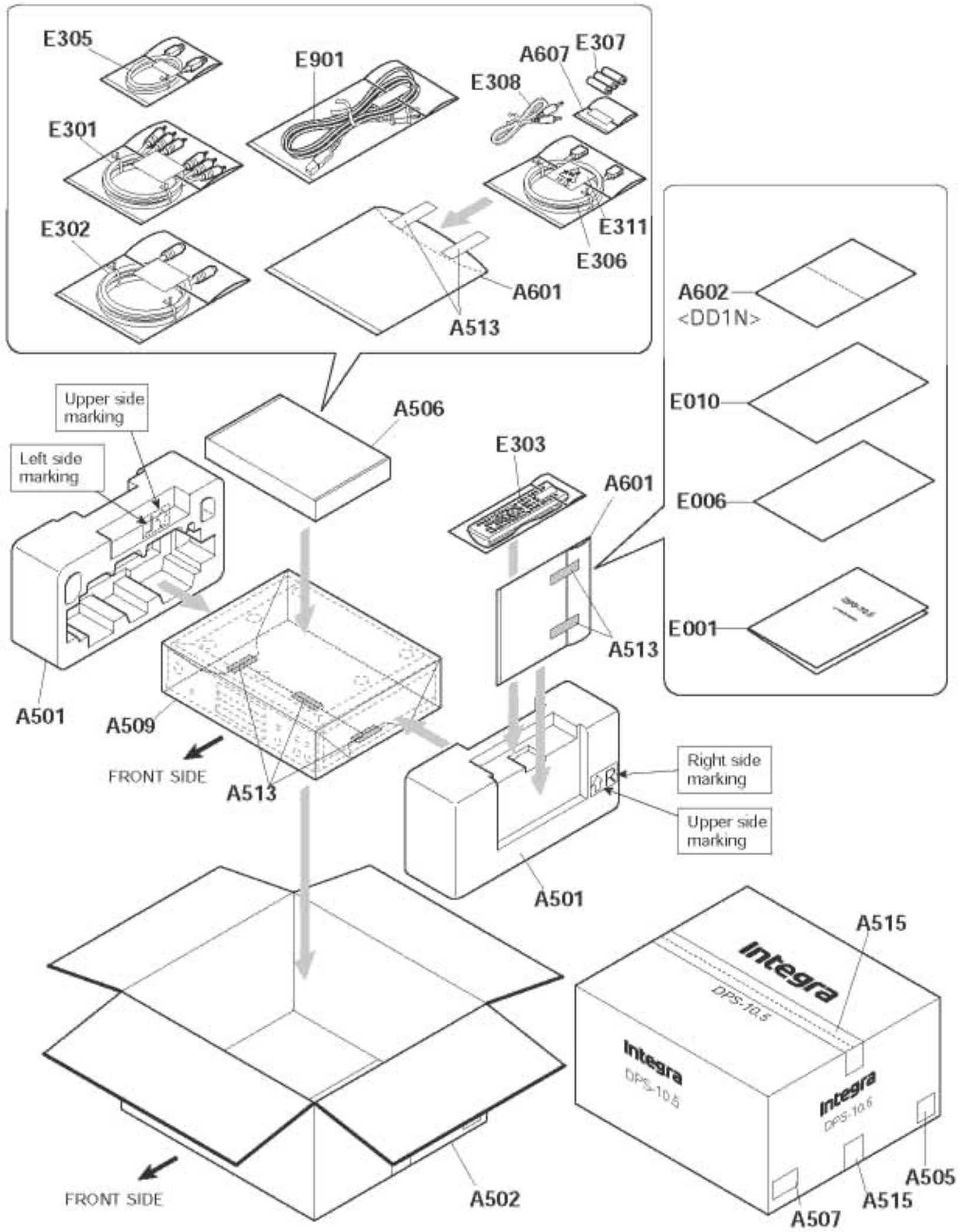

PRINTED CIRCUIT BOARD PARTS LIST

DPS-10.5

N: New part, !: Safety part

PCB NO.	CIRCUIT	PART NAME	DESCRIPTION	PART NO.	REMARKS
DG8257	C1001	G-CERA C	CK725B1C-104K1	332121045R1	1
DG8257	C1002	G-CERA C	CK725B1C-104K1	332121045R1	1
DG8257	C1003	G-CERA C	CC725CH1H-220J1	342102204R1	1
DG8257	C1004	G-CERA C	CC725CH1H-220J1	342102204R1	1
DG8257	C1005	G-CERA C	CC725CH1H-220J1	342102204R1	1
DG8257	C1006	G-CERA C	CC725CH1H-220J1	342102204R1	1
DG8257	C1007	G-CERA C	CK725B1H-222K1	332102225R1	1
DG8257	C1008	G-CERA C	CK725B1H-222K1	332102225R1	1
DG8257	C1009	G-CERA C	CK725B1H-222K1	332102225R1	1
DG8257	C1010	G-CERA C	CK725B1H-222K1	332102225R1	1
DG8257	C1011	G-CERA C	CC725CH1H-331J1	342103314R1	1
DG8257	C1012	G-CERA C	CK725F1E-104Z1	332161040R1	1
DG8257	C1013	CHIP ELECT C	CEWX16V-22M	356742209R2	1
DG8257	C1014	G-CERA C	CK725F1E-104Z1	332161040R1	1
DG8257	C1015	G-CERA C	CK725B1E-333K1	332113335R1	1
DG8257	C1016	G-CERA C	CK725B1E-333K1	332113335R1	1
DG8257	C1017	G-CERA C	CC725CH1H-151J1	342101514R1	1
DG8257	C1018	G-CERA C	CK725B1A-474K1	332134745R1	1
DG8257	C1019	G-CERA C	CK725B1A-474K1	332134745R1	1
DG8257	C1020	G-CERA C	CK725B1C-104K1	332121045R1	1
DG8257	C1021	G-CERA C	CK725F1E-104Z1	332161040R1	1
DG8257	C1022	CHIP ELECT C	CEWX16V-22M	356742209R2	1
DG8257	C1023	G-CERA C	CK725F1E-104Z1	332161040R1	1
DG8257	C1024	G-CERA C	CK725B1H-473K1	332104735R1	1
DG8257	C1025	G-CERA C	CK725F1E-104Z1	332161040R1	1
DG8257	C1026	CHIP ELECT C	CEWX16V-22M	356742209R2	1
DG8257	C1027	G-CERA C	CC725CH1E-102J1	342111024R1	1
DG8257	C1028	G-CERA C	CK725B1C-104K1	332121045R1	1

DG8257	C1029	G-CERA C	CK725B1C-104K1	332121045R1	1
DG8257	C1030	G-CERA C	CK725B1C-104K1	332121045R1	1
DG8257	C1031	G-CERA C	CK725F1E-104Z1	332161040R1	1
DG8257	C1032	CHIP ELECT C	CEWX6.3V-100M	356721019R2	1
DG8257	C1033	G-CERA C	CK725B1C-104K1	332121045R1	1
DG8257	C1034	G-CERA C	CK725B1C-104K1	332121045R1	1
DG8257	C1035	G-CERA C	CK725B1H-103K1	332101035R1	1
DG8257	C1036	G-CERA C	CC725CH1H-100D1	342101002R1	1
DG8257	C1037	G-CERA C	CC725CH1H-100D1	342101002R1	1
DG8257	C1038	G-CERA C	CK725F1E-104Z1	332161040R1	1
DG8257	C1039	CHIP ELECT C	CEWX6.3V-47M	356724709R2	1
DG8257	C1040	G-CERA C	CC725CH1E-102J1	342111024R1	1
DG8257	C1041	CHIP ELECT C	CEWX16V-10M	356741009R2	1
DG8257	C1042	CHIP ELECT C	CEWX16V-10M	356741009R2	1
DG8257	C1043	CHIP ELECT C	CEWX6.3V-47M	356724709R2	1
DG8257	C1044	G-CERA C	CC725CH1E-102J1	342111024R1	1
DG8257	C1045	CHIP ELECT C	CEWX16V-10M	356741009R2	1
DG8257	C1046	CHIP ELECT C	CEWX16V-10M	356741009R2	1
DG8257	C1047	CHIP ELECT C	CEWX16V-22M	356742209R2	1
DG8257	C1048	CHIP ELECT C	CEWX6.3V-100M	356721019R2	1
DG8257	C1049	G-CERA C	CK725F1E-104Z1	332161040R1	1
DG8257	C1050	CHIP ELECT C	CEWX6.3V-100M	356721019R2	1
DG8257	C1051	G-CERA C	CK725F1E-104Z1	332161040R1	1
DG8257	C1052	CHIP ELECT C	CEWX6.3V-100M	356721019R2	1
DG8257	C1053	CHIP ELECT C	CEWX50V-1M	356780109R2	1
DG8257	C1054	CHIP ELECT C	CEWX4V-220M	3567A2219R2	1
DG8257	C1101	G-CERA C	CC725CH1H-221J1	342102214R1	1
DG8257	C1102	G-CERA C	CC725CH1H-101J1	342101014R1	1
DG8257	C1103	G-CERA C	CC725CH1E-102J1	342111024R1	1
DG8257	C1104	G-CERA C	CK725F1E-104Z1	332161040R1	1
DG8257	C1105	G-CERA C	CK725F1E-104Z1	332161040R1	1
DG8257	C1106	CHIP ELECT C	CEWX16V-22M	356742209R2	1
DG8257	C1107	G-CERA C	CK725F1E-104Z1	332161040R1	1

DG8257	C1108	G-CERA C	CK725F1E-104Z1	332161040R1	1
DG8257	C1109	CHIP ELECT C	CEWX16V-22M	356742209R2	1
DG8257	C1110	G-CERA C	CK725F1E-104Z1	332161040R1	1
DG8257	C1111	CHIP ELECT C	CEWX16V-10M	356741009R2	1
DG8257	C1112	CHIP ELECT C	CEWX16V-10M	356741009R2	1
DG8257	C1113	G-CERA C	CK725B1H-223K1	332102235R1	1
DG8257	C1114	G-CERA C	CK725B1H-223K1	332102235R1	1
DG8257	C1115	G-CERA C	CK725B1E-473K1	332114735R1	1
DG8257	C1116	G-CERA C	CK725B1E-473K1	332114735R1	1
DG8257	C1117	G-CERA C	CK725F1E-104Z1	332161040R1	1
DG8257	C1201	G-CERA C	CK725F1A-105Z1	332181050R1	1
DG8257	C1202	G-CERA C	CK725F1A-105Z1	332181050R1	1
DG8257	C1203	G-CERA C	CK725F1A-105Z1	332181050R1	1
DG8257	C1206	G-CERA C	CK725F1A-105Z1	332181050R1	1
DG8257	C1207	G-CERA C	CK725F1A-105Z1	332181050R1	1
DG8257	C1208	G-CERA C	CK725F1A-105Z1	332181050R1	1
DG8257	C1209	G-CERA C	CK725B1E-223K1	332112235R1	1
DG8257	C1210	G-CERA C	CC725CH1H-151J1	342101514R1	1
DG8257	C1211	G-CERA C	CK725B1E-223K1	332112235R1	1
DG8257	C1212	G-CERA C	CK725B1C-104K1	332121045R1	1
DG8257	C1213	G-CERA C	CC725CH1H-101J1	342101014R1	1
DG8257	C1214	G-CERA C	CK725B1E-223K1	332112235R1	1
DG8257	C1215	G-CERA C	CC725CH1H-101J1	342101014R1	1
DG8257	C1216	G-CERA C	CK725B1A-154K1	332131545R1	1
DG8257	C1217	G-CERA C	CK725F1A-105Z1	332181050R1	1
DG8257	C1218	G-CERA C	CK725F1A-105Z1	332181050R1	1
DG8257	C1219	G-CERA C	CC725CH1H-331J1	342103314R1	1
DG8257	C1220	G-CERA C	CC725CH1H-331J1	342103314R1	1
DG8257	C1221	G-CERA C	CK725F1A-105Z1	332181050R1	1
DG8257	C1222	G-CERA C	CK725F1E-104Z1	332161040R1	1
DG8257	C1223	G-CERA C	CK725F1A-105Z1	332181050R1	1
DG8257	C1224	G-CERA C	CK725B1H-473K1	332104735R1	1
DG8257	C1225	G-CERA C	CK725F1A-105Z1	332181050R1	1

DG8257	C1226	G-CERA C	CK725B1H-103K1	332101035R1	1
DG8257	C1227	G-CERA C	CK725F1A-105Z1	332181050R1	1
DG8257	C1228	G-CERA C	CK725F1A-105Z1	332181050R1	1
DG8257	C1229	G-CERA C	CK725F1A-105Z1	332181050R1	1
DG8257	C1230	G-CERA C	CK725F1A-105Z1	332181050R1	1
DG8257	C1232	G-CERA C	CK725F1A-105Z1	332181050R1	1
DG8257	C1233	G-CERA C	CK725F1A-105Z1	332181050R1	1
DG8257	C1234	CHIP ELECT C	CEWX4V-220M	3567A2219R2	1
DG8257	C1235	CHIP ELECT C	CEWX4V-220M	3567A2219R2	1
DG8257	C1236	CHIP ELECT C	CEWX4V-220M	3567A2219R2	1
DG8257	C1237	CHIP ELECT C	CEWX4V-220M	3567A2219R2	1
DG8257	C1238	CHIP ELECT C	CEWX16V-10M	356741009R2	1
DG8257	C1239	G-CERA C	CK725F1A-105Z1	332181050R1	1
DG8257	C1240	G-CERA C	CC725CH1H-560J1	342105604R1	1
DG8257	C1241	G-CERA C	CK725F1A-105Z1	332181050R1	1
DG8257	C1242	G-CERA C	CK725F1A-105Z1	332181050R1	1
DG8257	C1243	G-CERA C	CK725F1A-105Z1	332181050R1	1
DG8257	C1251	G-CERA C	CC725CH1H-471J1	342104714R1	1
DG8257	C1252	G-CERA C	CK725F1E-104Z1	332161040R1	1
DG8257	C1253	G-CERA C	CC725CH1H-471J1	342104714R1	1
DG8257	C1254	G-CERA C	CK725F1E-104Z1	332161040R1	1
DG8257	C1255	G-CERA C	CC725CH1H-471J1	342104714R1	1
DG8257	C1256	G-CERA C	CK725F1E-104Z1	332161040R1	1
DG8257	C1257	CHIP ELECT C	CEWX4V-220M	3567A2219R2	1
DG8257	C1258	G-CERA C	CK725F1A-105Z1	332181050R1	1
DG8257	C1301	G-CERA C	CK725F1A-105Z1	332181050R1	1
DG8257	C1302	G-CERA C	CC725CH1E-102J1	342111024R1	1
DG8257	C1304	G-CERA C	CK725F1A-105Z1	332181050R1	1
DG8257	C1305	G-CERA C	CK725F1A-105Z1	332181050R1	1
DG8257	C1306	G-CERA C	CK725F1A-105Z1	332181050R1	1
DG8257	C1307	G-CERA C	CK725F1A-105Z1	332181050R1	1
DG8257	C1308	G-CERA C	CK725F1A-105Z1	332181050R1	1
DG8257	C1309	G-CERA C	CK725F1A-105Z1	332181050R1	1

DG8257	C1310	G-CERA C	CK725F1A-105Z1	332181050R1	1
DG8257	C1311	G-CERA C	CK725F1A-105Z1	332181050R1	1
DG8257	C1312	G-CERA C	CK725F1A-105Z1	332181050R1	1
DG8257	C1313	G-CERA C	CK725F1A-105Z1	332181050R1	1
DG8257	C1314	G-CERA C	CK725F1A-105Z1	332181050R1	1
DG8257	C1315	G-CERA C	CK725F1A-105Z1	332181050R1	1
DG8257	C1316	G-CERA C	CK725F1A-105Z1	332181050R1	1
DG8257	C1317	G-CERA C	CK725F1A-105Z1	332181050R1	1
DG8257	C1318	G-CERA C	CK725F1A-105Z1	332181050R1	1
DG8257	C1319	CHIP ELECT C	CEWX4V-220M	3567A2219R2	1
DG8257	C1320	CHIP ELECT C	CEWX4V-220M	3567A2219R2	1
DG8257	C1321	CHIP ELECT C	CEWX4V-220M	3567A2219R2	1
DG8257	C1322	CHIP ELECT C	CEWX4V-220M	3567A2219R2	1
DG8257	C1323	G-CERA C	CK725F1A-105Z1	332181050R1	1
DG8257	C1324	CHIP ELECT C	CEWX6.3V-100M	356721019R2	1
DG8257	C1325	G-CERA C	CK725F1A-105Z1	332181050R1	1
DG8257	C1326	G-CERA C	CK725F1A-105Z1	332181050R1	1
DG8257	C1327	G-CERA C	CK725F1A-105Z1	332181050R1	1
DG8257	C1328	G-CERA C	CK725F1A-105Z1	332181050R1	1
DG8257	C1329	G-CERA C	CK725F1A-105Z1	332181050R1	1
DG8257	C1330	G-CERA C	CK725F1A-105Z1	332181050R1	1
DG8257	C1331	G-CERA C	CK725F1A-105Z1	332181050R1	1
DG8257	C1332	CHIP ELECT C	CEWX6.3V-100M	356721019R2	1
DG8257	C1333	CHIP ELECT C	CEWX16V-22M	356742209R2	1
DG8257	C1334	CHIP ELECT C	CEWX16V-22M	356742209R2	1
DG8257	C1335	G-CERA C	CK725F1A-105Z1	332181050R1	1
DG8257	C1336	G-CERA C	CK725F1A-105Z1	332181050R1	1
DG8257	C1337	G-CERA C	CK725B1H-103K1	332101035R1	1
DG8257	C1338	G-CERA C	CC725CH1H-020C1	342100201R1	1
DG8257	C1339	G-CERA C	CC725CH1H-020C1	342100201R1	1
DG8257	C1340	G-CERA C	CK725F1A-105Z1	332181050R1	1
DG8257	C1341	CHIP ELECT C	CEWX4V-220M	3567A2219R2	1
DG8257	C1342	G-CERA C	CK725F1A-105Z1	332181050R1	1

DG8257	C1343	G-CERA C	CC725CH1H-100D1	342101002R1	1
DG8257	C1344	G-CERA C	CC725CH1H-100D1	342101002R1	1
DG8257	C1345	G-CERA C	CK725F1A-105Z1	332181050R1	1
DG8257	C1347	G-CERA C	CK725F1A-105Z1	332181050R1	1
DG8257	C1348	G-CERA C	CK725F1A-105Z1	332181050R1	1
DG8257	C1349	G-CERA C	CK725F1A-105Z1	332181050R1	1
DG8257	C1350	G-CERA C	CK725F1A-105Z1	332181050R1	1
DG8257	C1351	G-CERA C	CK725F1A-105Z1	332181050R1	1
DG8257	C1352	G-CERA C	CK725F1A-105Z1	332181050R1	1
DG8257	C1358	G-CERA C	CK725F1A-105Z1	332181050R1	1
DG8257	C1359	G-CERA C	CK725F1A-105Z1	332181050R1	1
DG8257	C1360	G-CERA C	CK725F1A-105Z1	332181050R1	1
DG8257	C1371	CHIP ELECT C	CEWX16V-22M	356742209R2	1
DG8257	C1372	G-CERA C	CK725F1A-105Z1	332181050R1	1
DG8257	C1373	G-CERA C	CK725F1A-105Z1	332181050R1	1
DG8257	C1374	G-CERA C	CK725F1A-105Z1	332181050R1	1
DG8257	C1375	G-CERA C	CK725F1A-105Z1	332181050R1	1
DG8257	C1376	G-CERA C	CK725F1A-105Z1	332181050R1	1
DG8257	C1377	G-CERA C	CK725F1A-105Z1	332181050R1	1
DG8257	C1378	G-CERA C	CK725F1A-105Z1	332181050R1	1
DG8257	C1379	G-CERA C	CC725CH1E-102J1	3421111024R1	1
DG8257	C1380	G-CERA C	CK725F1A-105Z1	332181050R1	1
DG8257	C1381	G-CERA C	CK725F1A-105Z1	332181050R1	1
DG8257	C2001	G-CERA C	CK725F1A-105Z1	332181050R1	1
DG8257	C2002	G-CERA C	CK725F1A-105Z1	332181050R1	1
DG8257	C2003	G-CERA C	CK725F1A-105Z1	332181050R1	1
DG8257	C2004	G-CERA C	CK725F1A-105Z1	332181050R1	1
DG8257	C2005	G-CERA C	CK725F1A-105Z1	332181050R1	1
DG8257	C2006	G-CERA C	CK725F1A-105Z1	332181050R1	1
DG8257	C2007	G-CERA C	CK725F1A-105Z1	332181050R1	1
DG8257	C2008	G-CERA C	CK725F1A-105Z1	332181050R1	1
DG8257	C2009	G-CERA C	CK725F1A-105Z1	332181050R1	1
DG8257	C2010	G-CERA C	CK725F1A-105Z1	332181050R1	1

DG8257	C2011	G-CERA C	CK725F1A-105Z1	332181050R1	1
DG8257	C2012	G-CERA C	CK725F1A-105Z1	332181050R1	1
DG8257	C2013	G-CERA C	CK725F1A-105Z1	332181050R1	1
DG8257	C2014	G-CERA C	CK725F1A-105Z1	332181050R1	1
DG8257	C2015	CHIP ELECT C	CEWX4V-220M	3567A2219R2	1
DG8257	C2016	CHIP ELECT C	CEWX4V-220M	3567A2219R2	1
DG8257	C2017	G-CERA C	CK725F1A-105Z1	332181050R1	1
DG8257	C2018	CHIP ELECT C	CEWX4V-220M	3567A2219R2	1
DG8257	C2019	G-CERA C	CK725F1A-105Z1	332181050R1	1
DG8257	C2020	G-CERA C	CK725F1A-105Z1	332181050R1	1
DG8257	C2021	G-CERA C	CK725F1A-105Z1	332181050R1	1
DG8257	C2022	G-CERA C	CK725F1A-105Z1	332181050R1	1
DG8257	C2023	G-CERA C	CK725F1A-105Z1	332181050R1	1
DG8257	C2024	G-CERA C	CK725F1A-105Z1	332181050R1	1
DG8257	C2025	G-CERA C	CK725F1A-105Z1	332181050R1	1
DG8257	C2026	CHIP ELECT C	CEWX4V-220M	3567A2219R2	1
DG8257	C2027	CHIP ELECT C	CEWX4V-220M	3567A2219R2	1
DG8257	C2028	CHIP ELECT C	CEWX16V-47M	356744709R2	1
DG8257	C2030	G-CERA C	CK725F1A-105Z1	332181050R1	1
DG8257	C2031	G-CERA C	CK725F1A-105Z1	332181050R1	1
DG8257	C2032	G-CERA C	CK725F1A-105Z1	332181050R1	1
DG8257	C2033	G-CERA C	CK725F1A-105Z1	332181050R1	1
DG8257	C2034	G-CERA C	CK725F1A-105Z1	332181050R1	1
DG8257	C2035	G-CERA C	CK725F1A-105Z1	332181050R1	1
DG8257	C2038	G-CERA C	CK725F1A-105Z1	332181050R1	1
DG8257	C2039	G-CERA C	CK725F1A-105Z1	332181050R1	1
DG8257	C2040	G-CERA C	CK725F1A-105Z1	332181050R1	1
DG8257	C2041	G-CERA C	CK725F1A-105Z1	332181050R1	1
DG8257	C2043	G-CERA C	CK725F1A-105Z1	332181050R1	1
DG8257	C2044	G-CERA C	CK725F1A-105Z1	332181050R1	1
DG8257	C2045	G-CERA C	CC725CHIE-102J1	3421111024R1	1
DG8257	C2046	G-CERA C	CK725F1A-105Z1	332181050R1	1
DG8257	C2047	G-CERA C	CK725F1A-105Z1	332181050R1	1

DG8257	C2048	G-CERA C	CK725F1A-105Z1	332181050R1	1
DG8257	C2049	G-CERA C	CK725F1A-105Z1	332181050R1	1
DG8257	C2051	G-CERA C	CK725F1A-105Z1	332181050R1	1
DG8257	C2052	G-CERA C	CK725F1A-105Z1	332181050R1	1
DG8257	C2101	G-CERA C	CK725F1A-105Z1	332181050R1	1
DG8257	C2102	G-CERA C	CK725F1A-105Z1	332181050R1	1
DG8257	C2103	G-CERA C	CC725CHIE-102J1	342111024R1	1
DG8257	C2104	G-CERA C	CK725F1A-105Z1	332181050R1	1
DG8257	C2105	G-CERA C	CK725F1A-105Z1	332181050R1	1
DG8257	C2106	G-CERA C	CK725F1A-105Z1	332181050R1	1
DG8257	C2107	G-CERA C	CK725F1A-105Z1	332181050R1	1
DG8257	C2108	G-CERA C	CK725F1A-105Z1	332181050R1	1
DG8257	C2109	G-CERA C	CK725F1A-105Z1	332181050R1	1
DG8257	C2110	G-CERA C	CK725F1A-105Z1	332181050R1	1
DG8257	C2111	G-CERA C	CK725F1A-105Z1	332181050R1	1
DG8257	C2112	G-CERA C	CK725F1A-105Z1	332181050R1	1
DG8257	C2113	G-CERA C	CK725F1A-105Z1	332181050R1	1
DG8257	C2114	G-CERA C	CK725F1A-105Z1	332181050R1	1
DG8257	C2115	G-CERA C	CK725F1A-105Z1	332181050R1	1
DG8257	C2116	G-CERA C	CK725F1A-105Z1	332181050R1	1
DG8257	C2117	G-CERA C	CK725F1A-105Z1	332181050R1	1
DG8257	C2118	G-CERA C	CK725F1A-105Z1	332181050R1	1
DG8257	C2119	G-CERA C	CK725F1A-105Z1	332181050R1	1
DG8257	C2120	G-CERA C	CC725CHIE-102J1	342111024R1	1
DG8257	C2121	CHIP ELECT C	CEWX4V-220M	3567A2219R2	1
DG8257	C2122	G-CERA C	CK725F1A-105Z1	332181050R1	1
DG8257	C2123	G-CERA C	CK725F1A-105Z1	332181050R1	1
DG8257	C2124	G-CERA C	CK725F1A-105Z1	332181050R1	1
DG8257	C2125	G-CERA C	CK725F1A-105Z1	332181050R1	1
DG8257	C2126	G-CERA C	CK725F1A-105Z1	332181050R1	1
DG8257	C2127	G-CERA C	CK725F1A-105Z1	332181050R1	1
DG8257	C2128	G-CERA C	CK725F1A-105Z1	332181050R1	1
DG8257	C2129	CHIP ELECT C	CEWX4V-220M	3567A2219R2	1

DG8257	C2130	G-CERA C	CK725B1H-103K1	332101035R1	1
DG8257	C2131	G-CERA C	CK725B1A-474K1	332134745R1	1
DG8257	C2191	CHIP ELECT C	CEWX4V-220M	3567A2219R2	1
DG8257	C2192	G-CERA C	CK725F1A-105Z1	332181050R1	1
DG8257	C2193	G-CERA C	CK725F1A-105Z1	332181050R1	1
DG8257	C2601	CHIP ELECT C	CEWX16V-22M	356742209R2	1
DG8257	C2602	CHIP ELECT C	CEWX6.3V-100M	356721019R2	1
DG8257	C2603	G-CERA C	CK725F1A-105Z1	332181050R1	1
DG8257	C2604	G-CERA C	CK725F1A-105Z1	332181050R1	1
DG8257	C2605	G-CERA C	CK725F1A-105Z1	332181050R1	1
DG8257	C2606	G-CERA C	CC725CH1H-120J1	342101204R1	1
DG8257	C2608	G-CERA C	CC725CH1H-120J1	342101204R1	1
DG8257	C2610	G-CERA C	CK725F1A-105Z1	332181050R1	1
DG8257	C2611	G-CERA C	CK725F1A-105Z1	332181050R1	1
DG8257	C2612	G-CERA C	CC725CH1H-560J1	342105604R1	1
DG8257	C2901	CHIP ELECT C	CEWX6.3V-100M	356721019R2	1
DG8257	C2902	CHIP ELECT C	CEWX4V-220M	3567A2219R2	1
DG8257	C2903	CHIP ELECT C	CEWX4V-220M	3567A2219R2	1
DG8257	C2904	CHIP ELECT C	CEWX4V-220M	3567A2219R2	1
DG8257	C2905	CHIP ELECT C	CEWX4V-220M	3567A2219R2	1
DG8257	C2906	CHIP ELECT C	CEWX4V-220M	3567A2219R2	1
DG8257	C2907	CHIP ELECT C	CEWX16V-10M	356741009R2	1
DG8257	C2908	CHIP ELECT C	CEWX4V-220M	3567A2219R2	1
DG8257	C2909	CHIP ELECT C	CEWX6.3V-100M	356721019R2	1
DG8257	C2910	CHIP ELECT C	CEWX4V-220M	3567A2219R2	1
DG8257	D1301	LED	SEC1801C	225386R2	1
DG8257	D2101	G-DIODE	ISS352	223234R2	1
DG8257	D2901	LED	SEC1801C	225386R2	1
DG8257	L1001	CHOKE COIL	NCH-1479	231237K470R2	1
DG8257	L1002	CHOKE COIL	NCH-1479	231237K470R2	1
DG8257	L1003	CHOKE COIL	NCH-1471	231237M022R2	1
DG8257	L1004	CHOKE COIL	NCH-1471	231237M022R2	1
DG8257	L1005	CHOKE COIL	NCH-1471	231237M022R2	1

DG8257	L1201	CHOKE COIL	NCH-1471	231237M022R2	1
DG8257	L1202	CHOKE COIL	NCH-1471	231237M022R2	1
DG8257	L1203	CHOKE COIL	NCH-1471	231237M022R2	1
DG8257	L1204	CHOKE COIL	NCH-1471	231237M022R2	1
DG8257	L1251	CHOKE COIL	NCH-1471	231237M022R2	1
DG8257	L1301	CHOKE COIL	NCH-1471	231237M022R2	1
DG8257	L1302	CHOKE COIL	NCH-1471	231237M022R2	1
DG8257	L1303	CHOKE COIL	NCH-1471	231237M022R2	1
DG8257	L1304	CHOKE COIL	NCH-1471	231237M022R2	1
DG8257	L1305	CHOKE COIL	NCH-1471	231237M022R2	1
DG8257	L1306	CHOKE COIL	NCH-1471	231237M022R2	1
DG8257	L1307	CHOKE COIL	NCH-1471	231237M022R2	1
DG8257	L1371	CHOKE COIL	NCH-1471	231237M022R2	1
DG8257	L2001	CHOKE COIL	NCH-1471	231237M022R2	1
DG8257	L2002	CHOKE COIL	NCH-1471	231237M022R2	1
DG8257	L2003	CHOKE COIL	NCH-1471	231237M022R2	1
DG8257	L2004	CHOKE COIL	NCH-1471	231237M022R2	1
DG8257	L2005	CHOKE COIL	NCH-1471	231237M022R2	1
DG8257	L2101	CHOKE COIL	NCH-1471	231237M022R2	1
DG8257	L2102	CHOKE COIL	NCH-1471	231237M022R2	1
DG8257	L2601	CHOKE COIL	NCH-1473	231237M047R2	1
DG8257	L2602	CHOKE COIL	NCH-1473	231237M047R2	1
DG8257	L2901	CHOKE COIL	NCH-1471	231237M022R2	1
DG8257	L2902	CHOKE COIL	NCH-1471	231237M022R2	1
DG8257	L2903	CHOKE COIL	NCH-1471	231237M022R2	1
DG8257	P1001	SOCKET	NSCT-26P2671	25052775R2	1
DG8257	P1101	PLUG	NPLG-6P932	25055979R2	1
DG8257	P1301A	PLUG	SM16B-SURS-TF	25056399R2	N
DG8257	P1302A	PLUG	SM20B-SURS-TF	25056401R2	N
DG8257	P2001A	PLUG	SM14B-SURS-TF	25056397R2	N
DG8257	P2002A	PLUG	SM15B-SURS-TF	25056398R2	N
DG8257	P2003A	PLUG	SM20B-SURS-TF	25056401R2	N
DG8257	P2004A	PLUG	SM16B-SURS-TF	25056399R2	N

DG8257	P2101	SOCKET	NSCT-14P2665	25052769R2	1
DG8257	P2701A	PLUG	NPLG-7P933	25055980R2	1
DG8257	P2901A	PLUG	NPLG-6P932	25055979R2	1
DG8257	Q1001	IC	CXD1881BR	22241902R3	1
DG8257	Q1002	IC	NJM2115V	22241676R2	1
DG8257	Q1003	TR	2SK3019	2216520R2	1
DG8257	Q1004	TR	2SK3019	2216520R2	1
DG8257	Q1005	TR	2SK3019	2216520R2	1
DG8257	Q1006	TR	2SB1132	2216400R2	1
DG8257	Q1007	TR	2SB1132	2216400R2	1
DG8257	Q1101	IC	FAN8042	22241905R3	1
DG8257	Q1102	IC	BA4510FV	22241907R2	1
DG8257	Q1201	IC	CXD1885Q	22241903R3	1
DG8257	Q1202	IC	74LVC1G08GW	22242071R2PH	N 1
DG8257	Q1202 or	IC	TC7SZ08FU	22242071R2TO	N (1)
DG8257	Q1251	IC	IC41LV16100-50T	22241909R2	1
DG8257	Q1251 or	IC	IC41LV16100-50T	22241909R3	(1)
DG8257	Q1301	IC	CXD2753R	22241829R3	1
DG8257	Q1302	IC	AD8062	22242066R2	N 1
DG8257	Q1303	IC	IC42S16100-TT	22242046R3	N 1
DG8257	Q1303 or	IC	IC42S16100-TT	22242046R2	N (1)
DG8257	Q1304	IC	TC7SZU04F	22242073R2TO	N 1
DG8257	Q1305	IC	74LVC2G241DP	22242076R2PH	N 1
DG8257	Q1305 or	IC	TC7WH241FU	22242076R2TO	N (1)
DG8257	Q1306	TR	2SK3019	2216520R2	1
DG8257	Q1307	IC	TC7SZ08FU	22242071R2TO	N 1
DG8257	Q1308	IC	TC7SZ08FU	22242071R2TO	N 1
DG8257	Q1309	IC	TC7SZ08FU	22242071R2TO	N 1
DG8257	Q1310	IC	TC7SZ125FU	22241895R2	1
DG8257	Q1371	IC	EPM3128A-Harmony-8LJ	22242067R3	N 1
DG8257	Q2001	IC	M65776CFP	22242044R3	N 1
DG8257	Q2002	IC	IC42S16400-TT	22241910R2	1
DG8257	Q2002 or	IC	IC42S16400-TT	22241910R3	(1)

DG8257	Q2007	IC	74LVC2G24IDP	22242076R2PH	N	1
DG8257	Q2007 or	IC	TC7WH24IFU	22242076R2TO	N	(1)
DG8257	Q2008	IC	TC7SZ125FU	22241895R2	N	1
DG8257	Q2101	IC	M32102S6FP	22242045R3	N	1
DG8257	Q2102	IC	TC74VHCT374AFT	22274374GR2TO	N	1
DG8257	Q2103	IC	74LVC1G32GW	22242077R2PH	N	1
DG8257	Q2103 or	IC	TC7SZ32FU	22242077R2TO	N	(1)
DG8257	Q2104	IC	BR24L08FV-W	22242070R2	N	1
DG8257	Q2105	IC	74LVC1G04GW	22242074R2PH	N	1
DG8257	Q2105 or	IC	TC7SZ04FU	22242074R2TO	N	(1)
DG8257	Q2106	IC	MX29LV320ABTC-90 (0102)	22241862R301020	N	1
DG8257	Q2107	IC	S-80127CNMC-JKM-T2	22241642R2	N	1
DG8257	Q2108	IC	TC7SZ125FU	22241895R2	N	1
DG8257	Q2109	IC	74AHCT125PW	22241894R2PH	N	1
DG8257	Q2191	IC	NJM2880U25	22242085R2	N	1
DG8257	Q2601	IC	BU2288FV	22241911R2	N	1
DG8257	Q2901	IC	BA33B00FP	22242086R2	N	1
DG8257	Q2902	IC	LM11117MPX-ADJ	22241648R2	N	1
DG8257	Q2903	IC(REGULATOR)	MPC2918T	22278018ER2NE	N	1
DG8257	R1001	C-R NET	RM7LJ152X04	43484715204R2	N	1
DG8257	R1002	C-R NET	RM7LJ000X04	43484700004R2	N	1
DG8257	R1003	C-CARBON R	RN72K1J-123FE	435031232R1	N	1
DG8257	R1004	C-CARBON R	RN72K1J-103JE	435031034R1	N	1
DG8257	R1005	C-CARBON R	RN72K1J-223JE	435032234R1	N	1
DG8257	R1006	C-CARBON R	RN72K1J-223JE	435032234R1	N	1
DG8257	R1007	C-CARBON R	RN72K1J-223JE	435032234R1	N	1
DG8257	R1009	C-CARBON R	RN72K1J-103JE	435031034R1	N	1
DG8257	R1010	C-CARBON R	RN72K1J-223JE	435032234R1	N	1
DG8257	R1011	C-CARBON R	RN72K1J-223JE	435032234R1	N	1
DG8257	R1012	C-CARBON R	RN72K1J-223JE	435032234R1	N	1
DG8257	R1014	C-CARBON R	RN72K1J-103JE	435031034R1	N	1
DG8257	R1015	C-CARBON R	RN72K1J-102JE	435031024R1	N	1
DG8257	R1016	C-CARBON R	RN72K1J-330JE	435033304R1	N	1

DG8257	R1017	G-CARBON R	RN72K1J-330JE	435033304R1	1
DG8257	R1018	G-CARBON R	RN72K1J-102JE	435031024R1	1
DG8257	R1019	G-CARBON R	RN72K1J-330JE	435033304R1	1
DG8257	R1020	G-CARBON R	RN72K1J-330JE	435033304R1	1
DG8257	R1021	G-CARBON R	RN72K1J-000JE	435030004R1	1
DG8257	R1022	G-CARBON R	RN72K1J-101JE	435031014R1	1
DG8257	R1023	G-CARBON R	RN72K1J-000JE	435030004R1	1
DG8257	R1027	G-CARBON R	RN72K1J-102JE	435031024R1	1
DG8257	R1028	G-CARBON R	RN72K1J-392JE	435033924R1	1
DG8257	R1029	G-CARBON R	RN72K1J-104JE	435031044R1	1
DG8257	R1101	G-CARBON R	RN72K1J-563FE	435035632R1	1
DG8257	R1102	G-CARBON R	RN72K1J-153JE	435031534R1	1
DG8257	R1103	G-CARBON R	RN72K1J-563JE	435035634R1	1
DG8257	R1104	G-CARBON R	RN72K1J-333JE	435033334R1	1
DG8257	R1105	G-CARBON R	RN72K1J-563JE	435035634R1	1
DG8257	R1106	G-CARBON R	RN72K1J-333JE	435033334R1	1
DG8257	R1107	G-CARBON R	RN72K1J-000JE	435030004R1	1
DG8257	R1108	G-CARBON R	RN72K1J-103JE	435031034R1	1
DG8257	R1109	G-CARBON R	RN72K1J-103JE	435031034R1	1
DG8257	R1110	G-CARBON R	RN72K1J-103JE	435031034R1	1
DG8257	R1111	G-CARBON R	RN72K1J-103JE	435031034R1	1
DG8257	R1112	G-CARBON R	RN72K1J-000JE	435030004R1	1
DG8257	R1113	G-CARBON R	RN72K1J-333JE	435033334R1	1
DG8257	R1114	G-CARBON R	RN72K1J-752JE	435037524R1	1
DG8257	R1115	G-CARBON R	RN72K1J-333JE	435033334R1	1
DG8257	R1116	G-CARBON R	RN72K1J-752JE	435037524R1	1
DG8257	R1117	G-CARBON R	RN72K1J-103FE	435031032R1	1
DG8257	R1118	G-CARBON R	RN72K1J-103FE	435031032R1	1
DG8257	R1119	G-CARBON R	RN72K1J-223JE	435032234R1	1
DG8257	R1120	G-CARBON R	RN72K1J-103JE	435031034R1	1
DG8257	R1121	G-CARBON R	RN72K1J-103JE	435031034R1	1
DG8257	R1122	G-CARBON R	RN72K1J-104JE	435031044R1	1
DG8257	R1123	G-CARBON R	RN72K1J-223JE	435032234R1	1

DG8257	R1124	C-CARBON R	RN72K1J-103JE	435031034R1		1
DG8257	R1125	C-CARBON R	RN72K1J-103JE	435031034R1		1
DG8257	R1126	C-CARBON R	RN72K1J-104JE	435031044R1		1
DG8257	R1127	C-CARBON R	RN72K1J-000JE	435030004R1		1
DG8257	R1128	C-CARBON R	RN72K1J-000JE	435030004R1		1
DG8257	R1202	C-CARBON R	RN72K1J-000JE	435030004R1		1
DG8257	R1205	C-R NET	RM7LJ101X04	43484710104R2	N	1
DG8257	R1206	C-R NET	RM7LJ101X04	43484710104R2	N	1
DG8257	R1207	C-CARBON R	RN72K1J-181JE	435031814R1		1
DG8257	R1208	C-R NET	RM7LJ101X04	43484710104R2	N	1
DG8257	R1209	C-R NET	RM7LJ330X04	43484733004R2	N	1
DG8257	R1210	C-R NET	RM7LJ101X04	43484710104R2	N	1
DG8257	R1211	C-R NET	RM7LJ101X04	43484710104R2	N	1
DG8257	R1212	C-R NET	RM7LJ181X04	43484718104R2	N	1
DG8257	R1213	C-R NET	RM7LJ103X04	43484710304R2	N	1
DG8257	R1214	C-CARBON R	RN72K1J-473FE	435034732R1		1
DG8257	R1215	C-CARBON R	RN72K1J-473FE	435034732R1		1
DG8257	R1216	C-CARBON R	RN72K1J-154FE	435031542R1		1
DG8257	R1217	C-CARBON R	RN72K1J-471FE	435034712R1		1
DG8257	R1218	C-CARBON R	RN72K1J-683FE	435036832R1		1
DG8257	R1219	C-CARBON R	RN72K1J-473FE	435034732R1		1
DG8257	R1220	C-CARBON R	RN72K1J-104FE	435031042R1		1
DG8257	R1221	C-CARBON R	RN72K1J-182FE	435031822R1		1
DG8257	R1222	C-CARBON R	RN72K1J-182FE	435031822R1		1
DG8257	R1223	C-CARBON R	RN72K1J-223FE	435032232R1		1
DG8257	R1224	C-CARBON R	RN72K1J-000JE	435030004R1		1
DG8257	R1225	C-CARBON R	RN72K1J-103JE	435031034R1		1
DG8257	R1226	C-CARBON R	RN72K1J-000JE	435030004R1		1
DG8257	R1227	C-CARBON R	RN72K1J-103JE	435031034R1		1
DG8257	R1228	C-CARBON R	RN72K1J-000JE	435030004R1		1
DG8257	R1229	C-CARBON R	RN72K1J-000JE	435030004R1		1
DG8257	R1230	C-CARBON R	RN72K1J-000JE	435030004R1		1
DG8257	R1231	C-CARBON R	RN72K1J-333JE	435033334R1		1

DG8257	R1232	C-CARBON R	RN72K1J-152JE	435031524R1		1
DG8257	R1233	C-CARBON R	RN72K1J-333JE	435033334R1		1
DG8257	R1234	C-R NET	RM7LJ101X04	43484710104R2	N	1
DG8257	R1235	C-R NET	RM7LJ101X04	43484710104R2	N	1
DG8257	R1236	C-R NET	RM7LJ101X04	43484710104R2	N	1
DG8257	R1237	C-R NET	RM7LJ101X04	43484710104R2	N	1
DG8257	R1238	C-R NET	RM7LJ101X04	43484710104R2	N	1
DG8257	R1239	C-CARBON R	RN72K1J-220JE	435032204R1		1
DG8257	R1240	C-CARBON R	RN72K1J-103JE	435031034R1		1
DG8257	R1241	C-R NET	RM7LJ101X04	43484710104R2	N	1
DG8257	R1242	C-CARBON R	RN72K1J-000JE	435030004R1		1
DG8257	R1243	C-CARBON R	RN72K1J-000JE	435030004R1		1
DG8257	R1244	C-CARBON R	RN72K1J-000JE	435030004R1		1
DG8257	R1251	C-R NET	RM7LJ101X04	43484710104R2	N	1
DG8257	R1252	C-R NET	RM7LJ101X04	43484710104R2	N	1
DG8257	R1253	C-R NET	RM7LJ101X04	43484710104R2	N	1
DG8257	R1254	C-R NET	RM7LJ101X04	43484710104R2	N	1
DG8257	R1291	C-R NET	RM6KJ103X08	43474610308R1		1
DG8257	R1292	C-R NET	RM6KJ103X08	43474610308R1		1
DG8257	R1293	C-R NET	RM6KJ103X08	43474610308R1		1
DG8257	R1301	C-CARBON R	RN72K1J-470JE	435034704R1		1
DG8257	R1302	C-CARBON R	RN72K1J-470JE	435034704R1		1
DG8257	R1303	C-CARBON R	RN72K1J-470JE	435034704R1		1
DG8257	R1304	C-CARBON R	RN72K1J-470JE	435034704R1		1
DG8257	R1305	C-CARBON R	RN72K1J-470JE	435034704R1		1
DG8257	R1306	C-CARBON R	RN72K1J-103JE	435031034R1		1
DG8257	R1307	C-CARBON R	RN72K1J-102JE	435031024R1		1
DG8257	R1308	C-CARBON R	RN72K1J-000JE	435030004R1		1
DG8257	R1309	C-CARBON R	RN72K1J-220JE	435032204R1		1
DG8257	R1310	C-CARBON R	RN72K1J-000JE	435030004R1		1
DG8257	R1311	C-CARBON R	RN72K1J-000JE	435030004R1		1
DG8257	R1312	C-CARBON R	RN72K1J-000JE	435030004R1		1
DG8257	R1313	C-CARBON R	RN72K1J-220JE	435032204R1		1

DG8257	R1314	G-CARBON R	RN72K1J-220JE	435032204R1		1
DG8257	R1315	G-CARBON R	RN72K1J-000JE	435030004R1		1
DG8257	R1316	G-CARBON R	RN72K1J-000JE	435030004R1		1
DG8257	R1317	G-CARBON R	RN72K1J-000JE	435030004R1		1
DG8257	R1318	G-CARBON R	RN72K1J-000JE	435030004R1		1
DG8257	R1319	G-CARBON R	RN72K1J-000JE	435030004R1		1
DG8257	R1320	G-CARBON R	RN72K1J-000JE	435030004R1		1
DG8257	R1321	G-R NET	RM7LJ220X04	43484722004R2	N	1
DG8257	R1322	G-R NET	RM7LJ220X04	43484722004R2	N	1
DG8257	R1323	G-CARBON R	RN72K1J-103JE	435031034R1		1
DG8257	R1324	G-CARBON R	RN72K1J-103JE	435031034R1		1
DG8257	R1325	G-R NET	RM7LJ470X04	43484747004R2	N	1
DG8257	R1326	G-R NET	RM7LJ470X04	43484747004R2	N	1
DG8257	R1327	G-R NET	RM7LJ470X04	43484747004R2	N	1
DG8257	R1328	G-R NET	RM7LJ103X04	43484710304R2	N	1
DG8257	R1329	G-R NET	RM7LJ103X04	43484710304R2	N	1
DG8257	R1330	G-CARBON R	RN72K1J-220JE	435032204R1		1
DG8257	R1331	G-CARBON R	RN72K1J-220JE	435032204R1		1
DG8257	R1332	G-CARBON R	RN72K1J-220JE	435032204R1		1
DG8257	R1333	G-CARBON R	RN72K1J-220JE	435032204R1		1
DG8257	R1334	G-CARBON R	RN72K1J-220JE	435032204R1		1
DG8257	R1335	G-R NET	RM7LJ470X04	43484747004R2	N	1
DG8257	R1336	G-R NET	RM7LJ470X04	43484747004R2	N	1
DG8257	R1337	G-R NET	RM7LJ470X04	43484747004R2	N	1
DG8257	R1338	G-CARBON R	RN72K1J-102JE	435031024R1		1
DG8257	R1339	G-CARBON R	RN72K1J-103FE	435031032R1		1
DG8257	R1340	G-CARBON R	RN72K1J-103FE	435031032R1		1
DG8257	R1341	G-CARBON R	RN72K1J-202JE	435032024R1		1
DG8257	R1342	G-CARBON R	RN72K1J-222JE	435032224R1		1
DG8257	R1343	G-CARBON R	RN72K1J-202JE	435032024R1		1
DG8257	R1344	G-CARBON R	RN72K1J-222JE	435032224R1		1
DG8257	R1345	G-CARBON R	RN72K1J-105JE	435031054R1		1
DG8257	R1346	G-CARBON R	RN72K1J-821FE	435038212R1		1

DG8257	R1347	G-CARBON R	RN72K1J-220JE	435032204R1	1
DG8257	R1348	G-CARBON R	RN72K1J-220JE	435032204R1	1
DG8257	R1349	G-CARBON R	RN72K1J-220JE	435032204R1	1
DG8257	R1350	G-CARBON R	RN72K1J-220JE	435032204R1	1
DG8257	R1351	G-CARBON R	RN72K1J-101JE	435031014R1	1
DG8257	R1354	G-CARBON R	RN72K1J-000JE	435030004R1	1
DG8257	R1355	G-CARBON R	RN72K1J-000JE	435030004R1	1
DG8257	R1356	G-CARBON R	RN72K1J-000JE	435030004R1	1
DG8257	R1357	G-CARBON R	RN72K1J-101JE	435031014R1	1
DG8257	R1358	G-CARBON R	RN72K1J-100JE	435031004R1	1
DG8257	R1359	G-CARBON R	RN72K1J-100JE	435031004R1	1
DG8257	R1360	G-CARBON R	RN72K1J-000JE	435030004R1	1
DG8257	R1361	G-CARBON R	RN72K1J-000JE	435030004R1	1
DG8257	R1362	G-CARBON R	RN72K1J-000JE	435030004R1	1
DG8257	R1363	G-CARBON R	RN72K1J-470JE	435034704R1	1
DG8257	R1371	G-CARBON R	RN72K1J-470JE	435034704R1	1
DG8257	R1374	G-CARBON R	RN72K1J-000JE	435030004R1	1
DG8257	R1375	G-R NET	RM7LJ103X04	43484710304R2	N 1
DG8257	R1376	G-R NET	RM7LJ101X04	43484710104R2	N 1
DG8257	R1377	G-R NET	RM7LJ101X04	43484710104R2	N 1
DG8257	R1378	G-CARBON R	RN72K1J-101JE	435031014R1	1
DG8257	R1379	G-CARBON R	RN72K1J-101JE	435031014R1	1
DG8257	R1380	G-CARBON R	RN72K1J-101JE	435031014R1	1
DG8257	R1381	G-CARBON R	RN72K1J-101JE	435031014R1	1
DG8257	R1382	G-CARBON R	RN72K1J-220JE	435032204R1	1
DG8257	R1383	G-CARBON R	RN72K1J-101JE	435031014R1	1
DG8257	R1384	G-CARBON R	RN72K1J-470JE	435034704R1	1
DG8257	R1387	G-R NET	RM7LJ101X04	43484710104R2	N 1
DG8257	R1388	G-CARBON R	RN72K1J-000JE	435030004R1	1
DG8257	R1389	G-CARBON R	RN72K1J-102JE	435031024R1	1
DG8257	R1390	G-R NET	RM7LJ101X04	43484710104R2	N 1
DG8257	R1391	G-CARBON R	RN72K1J-101JE	435031014R1	1
DG8257	R1393	G-CARBON R	RN72K1J-101JE	435031014R1	1

DG8257	R2001	C-CARBON R	RN72K1J-103JE	435031034R1		1
DG8257	R2002	C-CARBON R	RN72K1J-103JE	435031034R1		1
DG8257	R2003	C-R NET	RM7LJ150X04	43484715004R2	N	1
DG8257	R2004	C-R NET	RM7LJ150X04	43484715004R2	N	1
DG8257	R2005	C-R NET	RM7LJ150X04	43484715004R2	N	1
DG8257	R2006	C-R NET	RM7LJ150X04	43484715004R2	N	1
DG8257	R2007	C-CARBON R	RN72K1J-150JE	435031504R1		1
DG8257	R2009	C-CARBON R	RN72K1J-150JE	435031504R1		1
DG8257	R2010	C-CARBON R	RN72K1J-150JE	435031504R1		1
DG8257	R2011	C-CARBON R	RN72K1J-150JE	435031504R1		1
DG8257	R2012	C-CARBON R	RN72K1J-150JE	435031504R1		1
DG8257	R2013	C-CARBON R	RN72K1J-150JE	435031504R1		1
DG8257	R2014	C-CARBON R	RN72K1J-150JE	435031504R1		1
DG8257	R2015	C-R NET	RM7LJ150X04	43484715004R2	N	1
DG8257	R2016	C-R NET	RM7LJ150X04	43484715004R2	N	1
DG8257	R2017	C-R NET	RM7LJ150X04	43484715004R2	N	1
DG8257	R2018	C-R NET	RM7LJ150X04	43484715004R2	N	1
DG8257	R2019	C-CARBON R	RN72K1J-000JE	435030004R1		1
DG8257	R2023	C-CARBON R	RN72K1J-000JE	435030004R1		1
DG8257	R2024	C-CARBON R	RN72K1J-000JE	435030004R1		1
DG8257	R2025	C-CARBON R	RN72K1J-000JE	435030004R1		1
DG8257	R2030	C-CARBON R	RN72K1J-102JE	435031024R1		1
DG8257	R2031	C-CARBON R	RN72K1J-102JE	435031024R1		1
DG8257	R2041	C-CARBON R	RN72K1J-000JE	435030004R1		1
DG8257	R2042	C-CARBON R	RN72K1J-000JE	435030004R1		1
DG8257	R2043	C-CARBON R	RN72K1J-000JE	435030004R1		1
DG8257	R2047	C-CARBON R	RN72K1J-220JE	435032204R1		1
DG8257	R2048	C-R NET	RM7LJ220X04	43484722004R2	N	1
DG8257	R2049	C-CARBON R	RN72K1J-220JE	435032204R1		1
DG8257	R2050	C-CARBON R	RN72K1J-220JE	435032204R1		1
DG8257	R2051	C-CARBON R	RN72K1J-000JE	435030004R1		1
DG8257	R2052	C-CARBON R	RN72K1J-220JE	435032204R1		1
DG8257	R2053	C-CARBON R	RN72K1J-220JE	435032204R1		1

DG8257	R2054	G-CARBON R	RN72K1J-103JE	435031034R1	1
DG8257	R2055	G-CARBON R	RN72K1J-220JE	435032204R1	1
DG8257	R2056	G-CARBON R	RN72K1J-220JE	435032204R1	1
DG8257	R2058	EMIFIL	BK1608LL24I-T	230959R1	1
DG8257	R2059	G-R NET	RM7LJ150X04	43484715004R2	N
DG8257	R2060	G-R NET	RM7LJ150X04	43484715004R2	N
DG8257	R2061	G-CARBON R	RN72K1J-000JE	435030004R1	1
DG8257	R2062	G-CARBON R	RN72K1J-000JE	435030004R1	1
DG8257	R2063	G-CARBON R	RN72K1J-102JE	435031024R1	1
DG8257	R2064	G-CARBON R	RN72K1J-220JE	435032204R1	1
DG8257	R2065	G-CARBON R	RN72K1J-101JE	435031014R1	1
DG8257	R2066	G-CARBON R	RN72K1J-000JE	435030004R1	1
DG8257	R2067	G-CARBON R	RN72K1J-101JE	435031014R1	1
DG8257	R2068	G-CARBON R	RN72K1J-220JE	435032204R1	1
DG8257	R2069	G-CARBON R	RN72K1J-000JE	435030004R1	1
DG8257	R2101	G-CARBON R	RN72K1J-103JE	435031034R1	1
DG8257	R2102	G-CARBON R	RN72K1J-101JE	435031014R1	1
DG8257	R2103	G-R NET	RM7LJ470X04	43484747004R2	N
DG8257	R2104	G-R NET	RM7LJ470X04	43484747004R2	N
DG8257	R2105	G-R NET	RM7LJ103X04	43484710304R2	N
DG8257	R2106	G-CARBON R	RN72K1J-273JE	435032734R1	1
DG8257	R2107	G-CARBON R	RN72K1J-471JE	435034714R1	1
DG8257	R2108	G-CARBON R	RN72K1J-105JE	435031054R1	1
DG8257	R2109	G-CARBON R	RN72K1J-220JE	435032204R1	1
DG8257	R2110	G-CARBON R	RN72K1J-220JE	435032204R1	1
DG8257	R2111	G-CARBON R	RN72K1J-220JE	435032204R1	1
DG8257	R2112	G-CARBON R	RN72K1J-220JE	435032204R1	1
DG8257	R2113	G-R NET	RM7LJ220X04	43484722004R2	N
DG8257	R2114	G-R NET	RM7LJ470X04	43484747004R2	N
DG8257	R2115	G-CARBON R	RN72K1J-220JE	435032204R1	1
DG8257	R2116	G-CARBON R	RN72K1J-220JE	435032204R1	1
DG8257	R2117	G-CARBON R	RN72K1J-220JE	435032204R1	1
DG8257	R2118	G-CARBON R	RN72K1J-220JE	435032204R1	1

DG8257	R2119	G-CARBON R	RN72K1J-220JE	435032204R1	N	1
DG8257	R2120	G-CARBON R	RN72K1J-220JE	435032204R1	N	1
DG8257	R2121	G-CARBON R	RN72K1J-220JE	435032204R1	N	1
DG8257	R2122	G-CARBON R	RN72K1J-220JE	435032204R1	N	1
DG8257	R2123	G-CARBON R	RN72K1J-220JE	435032204R1	N	1
DG8257	R2124	G-CARBON R	RN72K1J-220JE	435032204R1	N	1
DG8257	R2125	G-CARBON R	RN72K1J-220JE	435032204R1	N	1
DG8257	R2126	G-R NET	RM7LJ470X04	43484747004R2	N	1
DG8257	R2127	G-CARBON R	RN72K1J-470JE	435034704R1	N	1
DG8257	R2128	G-CARBON R	RN72K1J-470JE	435034704R1	N	1
DG8257	R2129	G-CARBON R	RN72K1J-470JE	435034704R1	N	1
DG8257	R2130	G-CARBON R	RN72K1J-470JE	435034704R1	N	1
DG8257	R2131	G-CARBON R	RN72K1J-470JE	435034704R1	N	1
DG8257	R2132	G-CARBON R	RN72K1J-470JE	435034704R1	N	1
DG8257	R2133	G-CARBON R	RN72K1J-222JE	435032224R1	N	1
DG8257	R2134	G-CARBON R	RN72K1J-222JE	435032224R1	N	1
DG8257	R2135	G-CARBON R	RN72K1J-000JE	435030004R1	N	1
DG8257	R2136	G-CARBON R	RN72K1J-000JE	435030004R1	N	1
DG8257	R2137	G-R NET	RM7LJ150X04	43484715004R2	N	1
DG8257	R2138	G-R NET	RM7LJ150X04	43484715004R2	N	1
DG8257	R2139	G-R NET	RM7LJ150X04	43484715004R2	N	1
DG8257	R2140	G-R NET	RM7LJ150X04	43484715004R2	N	1
DG8257	R2141	G-CARBON R	RN72K1J-103JE	435031034R1	N	1
DG8257	R2142	G-CARBON R	RN72K1J-103JE	435031034R1	N	1
DG8257	R2143	G-CARBON R	RN72K1J-103JE	435031034R1	N	1
DG8257	R2144	G-CARBON R	RN72K1J-220JE	435032204R1	N	1
DG8257	R2145	G-CARBON R	RN72K1J-470JE	435034704R1	N	1
DG8257	R2146	G-CARBON R	RN72K1J-470JE	435034704R1	N	1
DG8257	R2147	G-CARBON R	RN72K1J-470JE	435034704R1	N	1
DG8257	R2148	G-CARBON R	RN72K1J-220JE	435032204R1	N	1
DG8257	R2149	G-R NET	RM7LJ470X04	43484747004R2	N	1
DG8257	R2150	G-CARBON R	RN72K1J-220JE	435032204R1	N	1
DG8257	R2151	G-R NET	RM7LJ150X04	43484715004R2	N	1

DG8257	R2152	C-R NET	RM7LJ150X04	43484715004R2	N	1
DG8257	R2153	C-R NET	RM7LJ150X04	43484715004R2	N	1
DG8257	R2154	C-R NET	RM7LJ150X04	43484715004R2	N	1
DG8257	R2155	C-R NET	RM7LJ150X04	43484715004R2	N	1
DG8257	R2156	C-CARBON R	RN72K1J-150JE	435031504R1		1
DG8257	R2157	C-CARBON R	RN72K1J-470JE	435034704R1		1
DG8257	R2158	C-CARBON R	RN72K1J-472JE	435034724R1		1
DG8257	R2159	C-CARBON R	RN72K1J-103JE	435031034R1		1
DG8257	R2160	C-CARBON R	RN72K1J-103JE	435031034R1		1
DG8257	R2161	C-CARBON R	RN72K1J-102JE	435031024R1		1
DG8257	R2162	C-CARBON R	RN72K1J-472JE	435034724R1		1
DG8257	R2163	C-CARBON R	RN72K1J-000JE	435030004R1		1
DG8257	R2164	C-CARBON R	RN72K1J-220JE	435032204R1		1
DG8257	R2165	C-CARBON R	RN72K1J-220JE	435032204R1		1
DG8257	R2166	C-CARBON R	RN72K1J-220JE	435032204R1		1
DG8257	R2167	C-CARBON R	RN72K1J-220JE	435032204R1		1
DG8257	R2168	C-CARBON R	RN72K1J-000JE	435030004R1		1
DG8257	R2169	C-CARBON R	RN72K1J-000JE	435030004R1		1
DG8257	R2191	C-CARBON R	RN72K1J-103JE	435031034R1		1
DG8257	R2601	C-CARBON R	RN72K1J-561FE	435035612R1		1
DG8257	R2602	C-CARBON R	RN72K1J-220JE	435032204R1		1
DG8257	R2603	C-CARBON R	RN72K1J-101JE	435031014R1		1
DG8257	R2604	C-CARBON R	RN72K1J-101JE	435031014R1		1
DG8257	R2605	C-CARBON R	RN72K1J-220JE	435032204R1		1
DG8257	R2608	C-CARBON R	RN72K1J-000JE	435030004R1		1
DG8257	R2609	C-CARBON R	RN72K1J-000JE	435030004R1		1
DG8257	R2901	C-CARBON R	RN72K1J-000JE	435030004R1		1
DG8257	R2902	C-CARBON R	RN72K1J-000JE	435030004R1		1
DG8257	R2903	C-CARBON R	RN72K1J-000JE	435030004R1		1
DG8257	R2906	C-CARBON R	RN72K1J-102JE	435031024R1		1
DG8257	R2907	C-CARBON R	RN72K1J-333FE	435033332R1		1
DG8257	R2908	C-CARBON R	RN72K1J-133FE	435031332R1		1
DG8257	R2909	C-CARBON R	RN72K1J-911FE	435039112R1		1

PCB NO.	CIRCUIT PART NAME	DESCRIPTION	PART NO.	REMARKS
DG8257	R2910	G-CARBON R	RN72K1J-121FE	435031212R1 1
DG8257	R2911	G-CARBON R	RN72K1J-121FE	435031212R1 1
DG8257	X1301	CRYSTAL	FCX03-33.868MHZ	3010391R2 N 1
DG8257	X2601	CRYSTAL	FCX-03-27MHZ	3010353R2 1
VD8258	A051	HOLDER	HOLDER(CLAMP)	27190540-1 1
VD8258	C6001	G-CERA C	CK725F1A-105Z1	332181050R1 1
VD8258	C6002	CHIP ELECT C	CEWX16V-22M	356742209R2 1
VD8258	C6003	G-CERA C	CK725F1A-105Z1	332181050R1 1
VD8258	C6004	G-CERA C	CK725F1A-105Z1	332181050R1 1
VD8258	C6005	G-CERA C	CK725F1A-105Z1	332181050R1 1
VD8258	C6006	G-CERA C	CK725F1A-105Z1	332181050R1 1
VD8258	C6007	G-CERA C	CK725F1A-105Z1	332181050R1 1
VD8258	C6008	G-CERA C	CK725F1A-105Z1	332181050R1 1
VD8258	C6009	G-CERA C	CK725F1A-105Z1	332181050R1 1
VD8258	C6010	G-CERA C	CK725F1A-105Z1	332181050R1 1
VD8258	C6011	G-CERA C	CK725F1A-105Z1	332181050R1 1
VD8258	C6012	G-CERA C	CK725F1A-105Z1	332181050R1 1
VD8258	C6013	G-CERA C	CK725F1A-105Z1	332181050R1 1
VD8258	C6014	G-CERA C	CK725F1A-105Z1	332181050R1 1
VD8258	C6015	G-CERA C	CK725F1A-105Z1	332181050R1 1
VD8258	C6020	G-CERA C	CK725F1A-105Z1	332181050R1 1
VD8258	C6021	G-CERA C	CK725F1A-105Z1	332181050R1 1
VD8258	C6022	G-CERA C	CK725F1A-105Z1	332181050R1 1
VD8258	C6023	G-CERA C	CK725F1A-105Z1	332181050R1 1
VD8258	C6024	G-CERA C	CK725F1A-105Z1	332181050R1 1
VD8258	C6029	G-CERA C	CK725F1A-105Z1	332181050R1 1
VD8258	C6030	G-CERA C	CK725F1A-105Z1	332181050R1 1
VD8258	C6031	G-CERA C	CK725F1A-105Z1	332181050R1 1
VD8258	C6032	G-CERA C	CK725F1A-105Z1	332181050R1 1
VD8258	C6033	G-CERA C	CK725F1A-105Z1	332181050R1 1
VD8258	C6034	G-CERA C	CK725F1A-105Z1	332181050R1 1

VD8258	C6035	G-CERA C	CK725F1A-105Z1	332181050R1	1
VD8258	C6036	G-CERA C	CK725F1A-105Z1	332181050R1	1
VD8258	C6037	G-CERA C	CK725F1A-105Z1	332181050R1	1
VD8258	C6038	G-CERA C	CK725F1A-105Z1	332181050R1	1
VD8258	C6039	G-CERA C	CK725F1A-105Z1	332181050R1	1
VD8258	C6040	G-CERA C	CC725CH1E-102J1	342111024R1	1
VD8258	C6041	G-CERA C	CK725F1A-105Z1	332181050R1	1
VD8258	C6042	CHIP ELECT C	CEWX16V-22M	356742209R2	1
VD8258	C6043	G-CERA C	CK725F1A-105Z1	332181050R1	1
VD8258	C6044	G-CERA C	CC725CH1H-101J1	342101014R1	1
VD8258	C6045	G-CERA C	CK725F1A-105Z1	332181050R1	1
VD8258	C6046	CHIP ELECT C	CEWX4V-220M	3567A2219R2	1
VD8258	C6047	G-CERA C	CK725F1A-105Z1	332181050R1	1
VD8258	C6048	CHIP ELECT C	CEWX4V-220M	3567A2219R2	1
VD8258	C6049	G-CERA C	CC725CH1E-102J1	342111024R1	1
VD8258	C6051	G-CERA C	CC725CH1H-050C1	342100501R1	1
VD8258	C6052	G-CERA C	CC725CH1H-050C1	342100501R1	1
VD8258	C6054	G-CERA C	CK725F1A-105Z1	332181050R1	1
VD8258	C6055	G-CERA C	CK725F1A-105Z1	332181050R1	1
VD8258	C6056	CHIP ELECT C	CEWX16V-100M	356741019R2	1
VD8258	C6062	G-CERA C	CK725F1A-105Z1	332181050R1	1
VD8258	C6063	CHIP ELECT C	CEWX4V-220M	3567A2219R2	1
VD8258	C6064	G-CERA C	CK725F1A-105Z1	332181050R1	1
VD8258	C6065	G-CERA C	CK725F1A-105Z1	332181050R1	1
VD8258	C6066	G-CERA C	CK725F1A-105Z1	332181050R1	1
VD8258	C6067	G-CERA C	CK725F1A-105Z1	332181050R1	1
VD8258	C6068	G-CERA C	CK725F1A-105Z1	332181050R1	1
VD8258	C6069	G-CERA C	CK725F1A-105Z1	332181050R1	1
VD8258	C6070	G-CERA C	CK725F1A-105Z1	332181050R1	1
VD8258	C6071	G-CERA C	CK725F1A-105Z1	332181050R1	1
VD8258	C6072	G-CERA C	CK725F1A-105Z1	332181050R1	1
VD8258	C6073	G-CERA C	CK725F1A-105Z1	332181050R1	1
VD8258	C6074	G-CERA C	CK725F1A-105Z1	332181050R1	1

VD8258	C6075	G-CERA C	CK725F1A-105Z1	332181050R1	1
VD8258	C6080	G-CERA C	CC725CH1H-050C1	342100501R1	1
VD8258	C6091	CHIP ELECT C	CEWX16V-10M	356741009R2	1
VD8258	C6092	CHIP ELECT C	CEWX6.3V-100M	356721019R2	1
VD8258	C6093	CHIP ELECT C	CEWX16V-10M	356741009R2	1
VD8258	C6101	G-CERA C	CK725F1A-105Z1	332181050R1	1
VD8258	C6102	CHIP ELECT C	CEWX4V-220M	3567A2219R2	1
VD8258	C6103	G-CERA C	CK725F1A-105Z1	332181050R1	1
VD8258	C6104	G-CERA C	CK725F1A-105Z1	332181050R1	1
VD8258	C6105	G-CERA C	CC725CH1E-102J1	342111024R1	1
VD8258	C6106	G-CERA C	CK725B1H-392K1	332103925R1	1
VD8258	C6107	G-CERA C	CC725CH1E-821J1	342118214R1	1
VD8258	C6108	G-CERA C	CK725B1C-104K1	332121045R1	1
VD8258	C6109	G-CERA C	CK725F1A-105Z1	332181050R1	1
VD8258	C6110	G-CERA C	CK725B1C-104K1	332121045R1	1
VD8258	C6111	G-CERA C	CK725F1A-105Z1	332181050R1	1
VD8258	C6112	G-CERA C	CK725F1A-105Z1	332181050R1	1
VD8258	C6113	G-CERA C	CK725F1A-105Z1	332181050R1	1
VD8258	C6114	CHIP ELECT C	CEWX4V-220M	3567A2219R2	1
VD8258	C6115	G-CERA C	CK725F1A-105Z1	332181050R1	1
VD8258	C6116	CHIP ELECT C	CEWX4V-220M	3567A2219R2	1
VD8258	C6117	G-CERA C	CK725F1A-105Z1	332181050R1	1
VD8258	C6118	CHIP ELECT C	CEWX16V-47M	356744709R2	1
VD8258	C6119	G-CERA C	CK725F1A-105Z1	332181050R1	1
VD8258	C6120	CHIP ELECT C	CEWX16V-10M	356741009R2	1
VD8258	C6121	G-CERA C	CK725F1A-105Z1	332181050R1	1
VD8258	C6122	CHIP ELECT C	CEWX16V-47M	356744709R2	1
VD8258	C6123	CHIP ELECT C	CEWX6.3V-100M	356721019R2	1
VD8258	C6124	G-CERA C	CK725F1A-105Z1	332181050R1	1
VD8258	C6125	CHIP ELECT C	CEWX50V-1M	356780109R2	1
VD8258	C6126	G-CERA C	CK725F1A-105Z1	332181050R1	1
VD8258	C6127	G-CERA C	CK725F1A-105Z1	332181050R1	1
VD8258	C6128	G-CERA C	CK725F1A-105Z1	332181050R1	1

VD8258	C6129	CHIP ELECT C	CEWX6.3V-100M	356721019R2	1
VD8258	C6151	G-CERA C	CK725F1A-105Z1	332181050R1	1
VD8258	C6152	CHIP ELECT C	CEWX50V-1M	356780109R2	1
VD8258	C6160	G-CERA C	CC725CH1H-030C1	342100301R1	1
VD8258	C6172	G-CERA C	CC725CH1H-030C1	342100301R1	1
VD8258	C6191	CHIP ELECT C	CEWX6.3V-100M	356721019R2	1
VD8258	C6192	CHIP ELECT C	CEWX6.3V-100M	356721019R2	1
VD8258	C6193	G-CERA C	CK725F1A-105Z1	332181050R1	1
VD8258	C6194	CHIP ELECT C	CEWX6.3V-100M	356721019R2	1
VD8258	C6195	G-CERA C	CK725F1A-105Z1	332181050R1	1
VD8258	C6196	CHIP ELECT C	CEWX6.3V-100M	356721019R2	1
VD8258	C6197	G-CERA C	CK725F1A-105Z1	332181050R1	1
VD8258	C6198	CHIP ELECT C	CEWX6.3V-100M	356721019R2	1
VD8258	C6199	G-CERA C	CK725F1A-105Z1	332181050R1	1
VD8258	C6201	G-CERA C	CK725F1A-105Z1	332181050R1	1
VD8258	C6202	CHIP ELECT C	CEWX50V-1M	356780109R2	1
VD8258	C6251	G-CERA C	CK725F1A-105Z1	332181050R1	1
VD8258	C6252	CHIP ELECT C	CEWX50V-1M	356780109R2	1
VD8258	C6253	G-CERA C	CK725B1G-104K1	332121045R1	1
VD8258	C6254	G-CERA C	CK725B1H-103K1	332101035R1	1
VD8258	C6255	G-CERA C	CK725B1G-104K1	332121045R1	1
VD8258	C6256	G-CERA C	CK725B1H-103K1	332101035R1	1
VD8258	C6297	G-CERA C	CK725F1A-105Z1	332181050R1	1
VD8258	C6299	G-CERA C	CK725F1A-105Z1	332181050R1	1
VD8258	C6301	G-CERA C	CK725F1A-105Z1	332181050R1	1
VD8258	C6302	CHIP ELECT C	CEWX50V-1M	356780109R2	1
VD8258	C6351	G-CERA C	CK725F1A-105Z1	332181050R1	1
VD8258	C6352	CHIP ELECT C	CEWX50V-1M	356780109R2	1
VD8258	C6392	CHIP ELECT C	CEWX6.3V-100M	356721019R2	1
VD8258	C6393	G-CERA C	CK725F1A-105Z1	332181050R1	1
VD8258	C6394	CHIP ELECT C	CEWX6.3V-100M	356721019R2	1
VD8258	C6395	G-CERA C	CK725F1A-105Z1	332181050R1	1
VD8258	C6396	CHIP ELECT C	CEWX6.3V-100M	356721019R2	1

VD8258	C6397	G-CERA C	CK725F1A-105Z1	332181050R1	1
VD8258	C6398	CHIP ELECT C	CEWX6.3V-100M	356721019R2	1
VD8258	C6399	G-CERA C	CK725F1A-105Z1	332181050R1	1
VD8258	C6401	G-CERA C	CK725F1A-105Z1	332181050R1	1
VD8258	C6402	CHIP ELECT C	CEWX50V-1M	356780109R2	1
VD8258	C6451	CHIP ELECT C	CEWX16V-47M	356744709R2	1
VD8258	C6452	CHIP ELECT C	CEWX16V-47M	356744709R2	1
VD8258	C6453	CHIP ELECT C	CEWX16V-47M	356744709R2	1
VD8258	C6454	CHIP ELECT C	CEWX16V-47M	356744709R2	1
VD8258	C6455	CHIP ELECT C	CEWX6.3V-100M	356721019R2	1
VD8258	C6456	CHIP ELECT C	CEWX6.3V-100M	356721019R2	1
VD8258	C6501	CHIP ELECT C	CEWX4V-220M	3567A2219R2	1
VD8258	C6502	G-CERA C	CK725F1A-105Z1	332181050R1	1
VD8258	C6503	CHIP ELECT C	CEWX4V-220M	3567A2219R2	1
VD8258	C6504	G-CERA C	CK725F1A-105Z1	332181050R1	1
VD8258	C6505	G-CERA C	CK725F1A-105Z1	332181050R1	1
VD8258	C6506	G-CERA C	CC725CHIE-102J1	342111024R1	1
VD8258	C6507	G-CERA C	CK725B1H-392K1	332103925R1	1
VD8258	C6508	G-CERA C	CC725CHIE-821J1	342118214R1	1
VD8258	C6509	G-CERA C	CK725B1C-104K1	332121045R1	1
VD8258	C6510	G-CERA C	CK725F1A-105Z1	332181050R1	1
VD8258	C6511	G-CERA C	CK725B1C-104K1	332121045R1	1
VD8258	C6512	G-CERA C	CK725F1A-105Z1	332181050R1	1
VD8258	C6513	G-CERA C	CK725F1A-105Z1	332181050R1	1
VD8258	C6514	CHIP ELECT C	CEWX4V-220M	3567A2219R2	1
VD8258	C6515	G-CERA C	CK725F1A-105Z1	332181050R1	1
VD8258	C6516	G-CERA C	CK725F1A-105Z1	332181050R1	1
VD8258	C6517	G-CERA C	CK725F1A-105Z1	332181050R1	1
VD8258	C6518	CHIP ELECT C	CEWX16V-47M	356744709R2	1
VD8258	C6522	CHIP ELECT C	CEWX50V-1M	356780109R2	1
VD8258	C6523	G-CERA C	CK725F1A-105Z1	332181050R1	1
VD8258	C6524	G-CERA C	CK725F1A-105Z1	332181050R1	1
VD8258	C6525	G-CERA C	CK725F1A-105Z1	332181050R1	1

VD8258	C6526	CHIP ELECT C	CEWX16V-47M	356744709R2	1
VD8258	C6527	CHIP ELECT C	CEWX6.3V-100M	356721019R2	1
VD8258	C6528	CHIP ELECT C	CEWX6.3V-100M	356721019R2	1
VD8258	C6529	G-CERA C	CK725F1A-105Z1	332181050R1	1
VD8258	C6531	G-CERA C	CC725CH1H-100D1	342101002R1	1
VD8258	C6532	G-CERA C	CC725CH1H-100D1	342101002R1	1
VD8258	C6551	G-CERA C	CK725F1A-105Z1	332181050R1	1
VD8258	C6552	CHIP ELECT C	CEWX50V-1M	356780109R2	1
VD8258	C6553	CHIP ELECT C	CEWX6.3V-100M	356721019R2	1
VD8258	C6554	G-CERA C	CK725F1A-105Z1	332181050R1	1
VD8258	C6555	G-CERA C	CK725F1A-105Z1	332181050R1	1
VD8258	C6556	CHIP ELECT C	CEWX6.3V-100M	356721019R2	1
VD8258	C6557	CHIP ELECT C	CEWX6.3V-100M	356721019R2	1
VD8258	C6601	G-CERA C	CK725F1A-105Z1	332181050R1	1
VD8258	C6602	CHIP ELECT C	CEWX50V-1M	356780109R2	1
VD8258	C6651	G-CERA C	CK725F1A-105Z1	332181050R1	1
VD8258	C6652	CHIP ELECT C	CEWX50V-1M	356780109R2	1
VD8258	C6723	CHIP ELECT C	CEWX6.3V-100M	356721019R2	1
VD8258	C6724	G-CERA C	CK725F1E-104Z1	332161040R1	1
VD8258	C6725	CHIP ELECT C	CEWX6.3V-100M	356721019R2	1
VD8258	C6726	G-CERA C	CK725F1E-104Z1	332161040R1	1
VD8258	C7001	G-CERA C	CK725F1E-104Z1	332161040R1	1
VD8258	C7002	G-CERA C	CK725F1E-104Z1	332161040R1	1
VD8258	C7003	G-CERA C	CC725CH1H-220J1	342102204R1	1
VD8258	C7004	G-CERA C	CK725F1E-104Z1	332161040R1	1
VD8258	C7005	CHIP ELECT C	CEWX6.3V-100M	356721019R2	1
VD8258	C7006	G-CERA C	CK725F1E-104Z1	332161040R1	1
VD8258	C7007	CHIP ELECT C	CEWX6.3V-100M	356721019R2	1
VD8258	C7008	G-CERA C	CK725F1E-104Z1	332161040R1	1
VD8258	C7009	G-CERA C	CK725F1E-104Z1	332161040R1	1
VD8258	C7010	G-CERA C	CK725F1E-104Z1	332161040R1	1
VD8258	C7101	CHIP ELECT C	CEWX6.3V-100M	356721019R2	1
VD8258	C7102	G-CERA C	CK725F1E-104Z1	332161040R1	1

VD8258	C7103	CHIP ELECT C	CEWX6.3V-100M	356721019R2	1
VD8258	C7104	G-CERA C	CK725F1E-104Z1	332161040R1	1
VD8258	C7105	CHIP ELECT C	CEWX6.3V-100M	356721019R2	1
VD8258	C7106	G-CERA C	CK725F1E-104Z1	332161040R1	1
VD8258	C7107	CHIP ELECT C	CEWX6.3V-100M	356721019R2	1
VD8258	C7108	G-CERA C	CK725F1E-104Z1	332161040R1	1
VD8258	C7109	G-CERA C	CK725F1E-104Z1	332161040R1	1
VD8258	C7110	CHIP ELECT C	CEWX6.3V-47M	356724709R2	1
VD8258	C7111	G-CERA C	CK725F1E-104Z1	332161040R1	1
VD8258	C7112	CHIP ELECT C	CEWX6.3V-47M	356724709R2	1
VD8258	C7113	G-CERA C	CK725F1E-104Z1	332161040R1	1
VD8258	C7201	CHIP ELECT C	CEWX6.3V-100M	356721019R2	1
VD8258	C7202	G-CERA C	CK725F1E-104Z1	332161040R1	1
VD8258	C7203	G-CERA C	CK725F1E-104Z1	332161040R1	1
VD8258	C7204	G-CERA C	CK725F1E-104Z1	332161040R1	1
VD8258	C7301	G-CERA C	CK725F1E-104Z1	332161040R1	1
VD8258	C7302	G-CERA C	CK725F1E-104Z1	332161040R1	1
VD8258	C7303	G-CERA C	CK725B1H-103K1	332101035R1	1
VD8258	C7304	G-CERA C	CK725B1H-103K1	332101035R1	1
VD8258	C7305	CHIP ELECT C	CEWX6.3V-100M	356721019R2	1
VD8258	C7306	G-CERA C	CK725F1E-104Z1	332161040R1	1
VD8258	C7310	G-CERA C	CK725F1E-104Z1	332161040R1	1
VD8258	C7311	G-CERA C	CK725F1E-104Z1	332161040R1	1
VD8258	C7312	G-CERA C	CK725F1E-104Z1	332161040R1	1
VD8258	C7401	CHIP ELECT C	CEWX16V-100M	356741019R2	1
VD8258	C7402	G-CERA C	CK725F1E-104Z1	332161040R1	1
VD8258	C7403	CHIP ELECT C	CEWX16V-10M	356741009R2	1
VD8258	C7404	G-CERA C	CK725F1E-104Z1	332161040R1	1
VD8258	C7405	G-CERA C	CK725F1E-104Z1	332161040R1	1
VD8258	D6001	LED	SECI401C	225383R2	1
VD8258	D6002	LED	SECI401C	225383R2	1
VD8258	D6003	LED	SECI401C	225383R2	1
VD8258	D6004	LED	SECI401C	225383R2	1

VD8258	D6005	LED	SEC1401C	225383R2	1
VD8258	D6006	LED	SEC1401C	225383R2	1
VD8258	D6151	C-DIODE	ISS352	223234R2	1
VD8258	D6201	C-DIODE	ISS352	223234R2	1
VD8258	D6251	C-DIODE	ISS352	223234R2	1
VD8258	D6301	C-DIODE	ISS352	223234R2	1
VD8258	D6351	C-DIODE	ISS352	223234R2	1
VD8258	D6401	C-DIODE	ISS352	223234R2	1
VD8258	D6451	ZENER D	UDZ55.6B	224550560R2	1
VD8258	D6452	ZENER D	UDZ55.6B	224550560R2	1
VD8258	D6551	C-DIODE	ISS352	223234R2	1
VD8258	D6601	C-DIODE	ISS352	223234R2	1
VD8258	D6651	C-DIODE	ISS352	223234R2	1
VD8258	D7201	ZENER D	UDZ55.6B	224550560R2	1
VD8258	D7202	C-DIODE	ISS352	223234R2	1
VD8258	D7301	C-DIODE	ISS352	223234R2	1
VD8258	D7302	C-DIODE	ISS352	223234R2	1
VD8258	D7303	C-DIODE	ISS352	223234R2	1
VD8258	D7304	C-DIODE	ISS352	223234R2	1
VD8258	D7305	C-DIODE	ISS352	223234R2	1
VD8258	D7310	LED	SEC1201C	225385R2	1
VD8258	D7401	C-DIODE	ISR154-400	22380284R2	1
VD8258	D7402	ZENER D	UDZ53.6B	224550360R2	1
VD8258	E7111	RETAINER	E PLATE	2714059	1
VD8258	E7112	RETAINER	E PLATE	2714059	1
VD8258	F6451	FUSE	ICP-SI.0	252223R2	1
VD8258	F6452	FUSE	ICP-SI.0	252223R2	1
VD8258	L6001	CHOKE COIL	NCH-1471	231237K022R2	1
VD8258	L6002	CHOKE COIL	NCH-1471	231237K022R2	1
VD8258	L6003	CHOKE COIL	NCH-1471	231237K022R2	1
VD8258	L6004	CHOKE COIL	NCH-1471	231237K022R2	1
VD8258	L6006	CHOKE COIL	NCH-1471	231237K022R2	1
VD8258	L6201	CHOKE COIL	NCH-1471	231237K022R2	1

VD8258	L6202	CHOKE COIL	NCH-1471	231237K022R2	1
VD8258	L6203	CHOKE COIL	NCH-1471	231237K022R2	1
VD8258	L6501	CHOKE COIL	NCH-1471	231237K022R2	1
VD8258	L6502	CHOKE COIL	NCH-1471	231237K022R2	1
VD8258	L6503	CHOKE COIL	NCH-1471	231237K022R2	1
VD8258	L6551	LC BLOCK	CY4W(15MHz)	3030049R2	N
VD8258	L6601	LC BLOCK	CY4W(15MHz)	3030049R2	N
VD8258	L6651	LC BLOCK	CY4W(15MHz)	3030049R2	N
VD8258	L6801	CORE	N1608Z601T01	230981R2	1
VD8258	L6802	CORE	N1608Z601T01	230981R2	1
VD8258	L6803	CORE	N1608Z601T01	230981R2	1
VD8258	P2001B	PLUG	SM14B-SURS-TF	25056397R2	N
VD8258	P2002B	PLUG	SM15B-SURS-TF	25056398R2	N
VD8258	P2701B	PLUG	NPLG-7P920	25055967R2	1
VD8258	P2901B	PLUG	NPLG-6P919	25055966R2	1
VD8258	P3503B	SOCKET(B to B)	IMSA-9850S-22Y900	25052814R2	N
VD8258	P4008B	PLUG	NPLG-5P918	25055965R2	1
VD8258	P4571A	PLUG	NPLG-8P1105	25056166R2	N
VD8258	P5001B	SOCKET(B to B)	IMSA-9850S-22Y900	25052814R2	N
VD8258	P5401B	SOCKET	CPB8148-0211	25053023R2	N
VD8258	P6001A	PLUG(B to B)	IMSA-9850B-16Y900	25056203R2	N
VD8258	P6001B	SOCKET(B to B)	IMSA-9850S-16Y900	25052811R2	N
VD8258	P6003A	PLUG(B to B)	IMSA-9850B-28Y900	25056209R2	N
VD8258	P6003B	SOCKET(B to B)	IMSA-9850S-28Y900	25052817R2	N
VD8258	P6005A	PLUG	NPLG-8P1105	25056166R2	N
VD8258	P6151	PIN JACK	NPJ-10PDBY459	25045660	1
VD8258	P6301	PIN JACK	NPJ-3PDGLR429	25045622	1
VD8258	P6452A	PLUG(B to B)	IMSA-9852B-08Y900	25056366R2	N
VD8258	P6452B	SOCKET(B to B)	IMSA-9850S-08Y900	25052807R2	1
VD8258	P6551A	PLUG	NPLG-9P1106	25056167R2	N
VD8258	P6703B	PLUG	NPLG-10P1107	25056168R2	1
VD8258	P6707	BNC JACK	P2298-C	25045760	1
VD8258	P7010A	PLUG	NPLG-4P1101	25056162R2	1

VD8258	P7201A	SOCKET	NSCT-26P2696	25052800R2	N	1
VD8258	P7302	PLUG	NPLG-8P660	25055704		1
VD8258	P7401A	PLUG	NPLG-7P920	25055967R2		1
VD8258	P8001B	SOCKET(B to B)	IMSA-9850S-28Y900	25052817R2	N	1
VD8258	P8002B	SOCKET(B to B)	IMSA-9850S-20Y900	25052813R2	N	1
VD8258	P8603B	SOCKET	CPB8148-0211	25053023R2	N	1
VD8258	P8701B	SOCKET(B to B)	IMSA-9850S-10Y900	25052808R2	N	1
VD8258	P9103B	PLUG	NPLG-4P917	25055964R2		1
VD8258	P9601B	PLUG	NPLG-12P925	25055972R2		1
VD8258	P9602B	PLUG	NPLG-14P927	25055974R2	N	1
VD8258	Q6001	IC	TC74VCXI6224FT	2227C244DR2TO		1
VD8258	Q6002	IC	TC74VCXI6224FT	2227C244DR2TO	N	1
VD8258	Q6003	IC	SI504	22242049R3		1
VD8258	Q6004	IC	IC42S32200L-TTG	22242056R2	N	1
VD8258	Q6004 or	IC	IS42S32200B-TT	22242031R3		(1)
VD8258	Q6005	IC	MC504	22242050R9	N	1
VD8258	Q6008	TR	NDC7002N	2216870R2	N	1
VD8258	Q6009	TR	DTC114EE	2216730R2		1
VD8258	Q6010	TR	2SK3019	2216520R2		1
VD8258	Q6011	TR	NDC7002N	2216870R2	N	1
VD8258	Q6091	IC	LM11117MPX-ADJ	22241648R2		1
VD8258	Q6101	IC	ADV7310	22242058R3		1
VD8258	Q6102	IC	NJM2880U25	22242085R2	N	1
VD8258	Q6103	IC	74AHCT1G08GW	22242072R2PH	N	1
VD8258	Q6103 or	IC	TC7SET08FU	22242072R2TO	N	(1)
VD8258	Q6104	TR	DTC14EE	2216390R2		1
VD8258	Q6105	TR	DTC14EE	2216390R2		1
VD8258	Q6106	TR	DTA14EE	2216380R2		1
VD8258	Q6107	TR	DTA14EE	2216380R2		1
VD8258	Q6108	IC	74AHCT1G04GW	22242079R2PH	N	1
VD8258	Q6108 or	IC	TC7SET04FU	22242079R2TO	N	(1)
VD8258	Q6109	IC	74AHCT1G08GW	22242072R2PH	N	1
VD8258	Q6109 or	IC	TC7SET08FU	22242072R2TO	N	(1)

VD8258	Q6110	IC	TK15420M	22241443R2	1
VD8258	Q6111	IC	TK15420M	22241443R2	1
VD8258	Q6112	IC	NJM2373AF	22241897R2	1
VD8258	Q6113	IC	EL4581CS	22241527R2	1
VD8258	Q6114	IC	74AHCT1G02GW	22242089R2PH	N 1
VD8258	Q6114 or	IC	TC7SET02FU	22242089R2TO	N (1)
VD8258	Q6115	IC	TC7SZ125FU	22241895R2	1
VD8258	Q6151	TR	2SA1162-GR	2214375R2	1
VD8258	Q6152	TR	2SC2712-GR	2213145R2	1
VD8258	Q6153	IC	LA7106MFP	22241465R2	1
VD8258	Q6154	IC	MAX4018ESD	22241440R2	1
VD8258	Q6155	IC	MAX4018ESD	22241440R2	1
VD8258	Q6201	TR	2SA1162-GR	2214375R2	1
VD8258	Q6202	TR	2SC2712-GR	2213145R2	1
VD8258	Q6251	TR	2SA1162-GR	2214375R2	1
VD8258	Q6252	TR	2SC2712-GR	2213145R2	1
VD8258	Q6253	TR	DTA144EE	2216380R2	1
VD8258	Q6254	TR	DTA144EE	2216380R2	1
VD8258	Q6301	TR	2SA1162-GR	2214375R2	1
VD8258	Q6302	TR	2SC2712-GR	2213145R2	1
VD8258	Q6303	IC	LA7106MFP	22241465R2	1
VD8258	Q6304	IC	MAX4018ESD	22241440R2	1
VD8258	Q6351	TR	2SA1162-GR	2214375R2	1
VD8258	Q6352	TR	2SC2712-GR	2213145R2	1
VD8258	Q6401	TR	2SA1162-GR	2214375R2	1
VD8258	Q6402	TR	2SC2712-GR	2213145R2	1
VD8258	Q6451	TR	2SB1565-E	2202715	1
VD8258	Q6451 or	TR	2SB1565-F	2202716	(1)
VD8258	Q6451A	HEAT SINK	SP211K	27160442	1
VD8258	Q6451B	SCREW	3P+10FN(BC)	82143010	1
VD8258	Q6451C	NUT	N-3FN(BC)	863430	1
VD8258	Q6451C or	NUT	N-3FN	863130	(1)
VD8258	Q6452	TR	2SD2394-E	2202705	1

VD8258	Q6452 or	TR	2SD2394-F	2202706	(1)
VD8258	Q6452A	HEAT SINK	SP211K	27160442	1
VD8258	Q6452B	SCREW	3P+10FN(BC)	82143010	1
VD8258	Q6452C	NUT	N-3FN(BC)	863430	1
VD8258	Q6452C or	NUT	N-3FN	863130	(1)
VD8258	Q6453	TR	2SC2712-GR	2213145R2	1
VD8258	Q6454	TR	2SA1162-GR	2214375R2	1
VD8258	Q6455	TR	DTC14EE	2216390R2	1
VD8258	Q6456	TR	DTA14EE	2216380R2	1
VD8258	Q6501	IC	ADV7314	22242057R2	N 1
VD8258	Q6502	IC	NJM2880U25	22242085R2	N 1
VD8258	Q6521	IC	EL4581CS	22241527R2	1
VD8258	Q6522	IC	74AHCT1G02GW	22242089R2PH	N 1
VD8258	Q6522 or	IC	TC7SET02FU	22242089R2TO	N (1)
VD8258	Q6523	IC	NJM2373AF	22241897R2	1
VD8258	Q6524	IC	TK15420M	22241443R2	1
VD8258	Q6525	IC	TK15420M	22241443R2	1
VD8258	Q6551	TR	2SA1162-GR	2214375R2	1
VD8258	Q6552	TR	2SA1162-GR	2214375R2	1
VD8258	Q6553	TR	2SC2712-GR	2213145R2	1
VD8258	Q6554	IC	MAX4018ESD	22241440R2	1
VD8258	Q6601	TR	2SA1162-GR	2214375R2	1
VD8258	Q6602	TR	2SA1162-GR	2214375R2	1
VD8258	Q6603	TR	2SC2712-GR	2213145R2	1
VD8258	Q6651	TR	2SA1162-GR	2214375R2	1
VD8258	Q6652	TR	2SA1162-GR	2214375R2	1
VD8258	Q6653	TR	2SC2712-GR	2213145R2	1
VD8258	Q6708	IC	MAX4218ESD	22241442R2	1
VD8258	Q7001	IC	M30624FCGPP (0087)	NSP	N 1
VD8258	Q7101	IC(REGULATOR)	SI-3033LUS	22278033CR2	1
VD8258	Q7102	IC	NJM2370U05	22241289R2	1
VD8258	Q7201	IC	74AHCT125PW	22241894R2PH	N 1
VD8258	Q7202	IC	74LV125PW	22274125CR2PH	N 1

VD8258	Q7203	TR	RN2403	2214540R2		1
VD8258	Q7301	IC	S-80127CNMC-JKM-T2	22241642R2		1
VD8258	Q7302	IC	TC7WU04FU	22240935R2		1
VD8258	Q7303	IC	TC7W74FU	22241408R2		1
VD8258	Q7304	IC	TC7SH08FU	22241830R2TO		1
VD8258	Q7305	IC	74LVC1G04GW	22242074R2PH	N	1
VD8258	Q7305 or	IC	TC7SZ04FU	22242074R2TO	N	(1)
VD8258	Q7401	IC	BA6288FS	22241656R2		1
VD8258	R6001	C-CARBON R	RN72K1J-220FE	435032202R1		1
VD8258	R6002	C-CARBON R	RN72K1J-220FE	435032202R1		1
VD8258	R6003	C-CARBON R	RN72K1J-220FE	435032202R1		1
VD8258	R6004	C-R NET	RM7LJ100X04	43484710004R2	N	1
VD8258	R6005	C-R NET	RM7LJ100X04	43484710004R2	N	1
VD8258	R6006	C-R NET	RM7LJ100X04	43484710004R2	N	1
VD8258	R6007	C-R NET	RM7LJ100X04	43484710004R2	N	1
VD8258	R6008	C-R NET	RM7LJ100X04	43484710004R2	N	1
VD8258	R6009	C-R NET	RM7LJ100X04	43484710004R2	N	1
VD8258	R6010	C-R NET	RM7LJ100X04	43484710004R2	N	1
VD8258	R6011	C-R NET	RM7LJ100X04	43484710004R2	N	1
VD8258	R6012	C-R NET	RM7LJ100X04	43484710004R2	N	1
VD8258	R6019	C-CARBON R	RN72K1J-472FE	435034722R1		1
VD8258	R6020	C-CARBON R	RN72K1J-472FE	435034722R1		1
VD8258	R6023	C-CARBON R	RN72K1J-000JE	435030004R1		1
VD8258	R6024	C-CARBON R	RN72K1J-000JE	435030004R1		1
VD8258	R6025	C-CARBON R	RN72K1J-000JE	435030004R1		1
VD8258	R6026	C-CARBON R	RN72K1J-000JE	435030004R1		1
VD8258	R6027	C-CARBON R	RN72K1J-000JE	435030004R1		1
VD8258	R6028	C-CARBON R	RN72K1J-000JE	435030004R1		1
VD8258	R6031	C-CARBON R	RN72K1J-103FE	435031032R1		1
VD8258	R6032	C-CARBON R	RN72K1J-103FE	435031032R1		1
VD8258	R6033	C-R NET	RM7LJ103X04	43484710304R2	N	1
VD8258	R6034	C-R NET	RM7LJ103X04	43484710304R2	N	1
VD8258	R6035	C-CARBON R	RN72K1J-104FE	435031042R1		1

VD8258	R6036	C-CARBON R	RN72K1J-222FE	435032222R1	1
VD8258	R6037	C-CARBON R	RN72K1J-222FE	435032222R1	1
VD8258	R6038	C-CARBON R	RN72K1J-222FE	435032222R1	1
VD8258	R6039	C-CARBON R	RN72K1J-000JE	435030004R1	1
VD8258	R6040	C-CARBON R	RN72K1J-102FE	435031022R1	1
VD8258	R6043	C-CARBON R	RN72K1J-101FE	435031012R1	1
VD8258	R6044	C-CARBON R	RN72K1J-472FE	435034722R1	1
VD8258	R6046	C-CARBON R	RN72K1J-472FE	435034722R1	1
VD8258	R6047	C-CARBON R	RN72K1J-472FE	435034722R1	1
VD8258	R6049	C-CARBON R	RN72K1J-472FE	435034722R1	1
VD8258	R6052	C-CARBON R	RN72K1J-102FE	435031022R1	1
VD8258	R6053	C-CARBON R	RN72K1J-105FE	435031052R1	1
VD8258	R6054	C-CARBON R	RN72K1J-000JE	435030004R1	1
VD8258	R6055	C-CARBON R	RN72K1J-472FE	435034722R1	1
VD8258	R6056	C-CARBON R	RN72K1J-472FE	435034722R1	1
VD8258	R6057	C-CARBON R	RN72K1J-222FE	435032222R1	1
VD8258	R6058	C-CARBON R	RN72K1J-222FE	435032222R1	1
VD8258	R6059	C-CARBON R	RN72K1J-222FE	435032222R1	1
VD8258	R6060	C-CARBON R	RN72K1J-000JE	435030004R1	1
VD8258	R6061	C-CARBON R	RN72K1J-103FE	435031032R1	1
VD8258	R6062	C-CARBON R	RN72K1J-102FE	435031022R1	1
VD8258	R6063	C-CARBON R	RN72K1J-103FE	435031032R1	1
VD8258	R6064	C-CARBON R	RN72K1J-102FE	435031022R1	1
VD8258	R6065	C-CARBON R	RN72K1J-222FE	435032222R1	1
VD8258	R6066	C-CARBON R	RN72K1J-222FE	435032222R1	1
VD8258	R6069	C-CARBON R	RN72K1J-472FE	435034722R1	1
VD8258	R6074	C-CARBON R	RN72K1J-000JE	435030004R1	1
VD8258	R6075	C-CARBON R	RN72K1J-000JE	435030004R1	1
VD8258	R6076	C-CARBON R	RN72K1J-222FE	435032222R1	1
VD8258	R6077	C-CARBON R	RN72K1J-222FE	435032222R1	1
VD8258	R6078	C-CARBON R	RN72K1J-471FE	435034712R1	1
VD8258	R6079	C-CARBON R	RN72K1J-000JE	435030004R1	1
VD8258	R6080	C-CARBON R	RN72K1J-000JE	435030004R1	1

VD8258	R6081	C-CARBON R	RN72K1J-000JE	435030004R1	1
VD8258	R6082	C-CARBON R	RN72K1J-100FE	435031002R1	1
VD8258	R6083	C-CARBON R	RN72K1J-000JE	435030004R1	1
VD8258	R6086	C-CARBON R	RN72K1J-000JE	435030004R1	1
VD8258	R6087	C-CARBON R	RN72K1J-000JE	435030004R1	1
VD8258	R6088	C-CARBON R	RN72K1J-000JE	435030004R1	1
VD8258	R6089	C-CARBON R	RN72K1J-000JE	435030004R1	1
VD8258	R6090	C-CARBON R	RN72K1J-000JE	435030004R1	1
VD8258	R6091	C-CARBON R	RN72K1J-121FE	435031212R1	1
VD8258	R6094	C-CARBON R	RN72K1J-241FE	435032412R1	1
VD8258	R6095	C-CARBON R	RN72K1J-000JE	435030004R1	1
VD8258	R6097	C-CARBON R	RN72K1J-000JE	435030004R1	1
VD8258	R6098	C-CARBON R	RN72K1J-000JE	435030004R1	1
VD8258	R6099	C-CARBON R	RN72K1J-472FE	435034722R1	1
VD8258	R6101	C-CARBON R	RN72K1J-103FE	435031032R1	1
VD8258	R6103	C-CARBON R	RN72K1J-472FE	435034722R1	1
VD8258	R6104	C-CARBON R	RN72K1J-472FE	435034722R1	1
VD8258	R6105	C-CARBON R	RN72K1J-103FE	435031032R1	1
VD8258	R6106	C-CARBON R	RN72K1J-000JE	435030004R1	1
VD8258	R6107	C-CARBON R	RN72K1J-102FE	435031022R1	1
VD8258	R6108	C-CARBON R	RN72K1J-681FE	435036812R1	1
VD8258	R6109	C-CARBON R	RN72K1J-681FE	435036812R1	1
VD8258	R6110	C-CARBON R	RN72K1J-681FE	435036812R1	1
VD8258	R6111	C-CARBON R	RN72K1J-272FE	435032722R1	1
VD8258	R6112	C-CARBON R	RN72K1J-272FE	435032722R1	1
VD8258	R6113	C-CARBON R	RN72K1J-681FE	435036812R1	1
VD8258	R6114	C-CARBON R	RN72K1J-681FE	435036812R1	1
VD8258	R6115	C-CARBON R	RN72K1J-103FE	435031032R1	1
VD8258	R6117	C-CARBON R	RN72K1J-000JE	435030004R1	1
VD8258	R6119	C-CARBON R	RN72K1J-000JE	435030004R1	1
VD8258	R6120	C-CARBON R	RN72K1J-473FE	435034732R1	1
VD8258	R6121	C-CARBON R	RN72K1J-122FE	435031222R1	1
VD8258	R6122	C-CARBON R	RN72K1J-122FE	435031222R1	1

VD8258	R6123	C-CARBON R	RN72K1J-102FE	435031022R1	1
VD8258	R6124	C-CARBON R	RN72K1J-102FE	435031022R1	1
VD8258	R6125	C-CARBON R	RN72K1J-102FE	435031022R1	1
VD8258	R6127	C-CARBON R	RN72K1J-102FE	435031022R1	1
VD8258	R6128	C-CARBON R	RN72K1J-102FE	435031022R1	1
VD8258	R6129	C-CARBON R	RN72K1J-102FE	435031022R1	1
VD8258	R6130	C-CARBON R	RN72K1J-102FE	435031022R1	1
VD8258	R6133	C-CARBON R	RN72K1J-152FE	435031522R1	1
VD8258	R6134	C-CARBON R	RN72K1J-103FE	435031032R1	1
VD8258	R6135	C-CARBON R	RN72K1J-000JE	435030004R1	1
VD8258	R6136	C-CARBON R	RN72K1J-224FE	435032242R1	1
VD8258	R6137	C-CARBON R	RN72K1J-221FE	435032212R1	1
VD8258	R6138	C-CARBON R	RN72K1J-000JE	435030004R1	1
VD8258	R6140	C-CARBON R	RN72K1J-564FE	435035642R1	1
VD8258	R6142	C-CARBON R	RN72K1J-102FE	435031022R1	1
VD8258	R6143	C-CARBON R	RN72K1J-102FE	435031022R1	1
VD8258	R6144	C-CARBON R	RN72K1J-102FE	435031022R1	1
VD8258	R6146	C-CARBON R	RN72K1J-101FE	435031012R1	1
VD8258	R6147	C-CARBON R	RN72K1J-101FE	435031012R1	1
VD8258	R6151	C-CARBON R	RN72K1J-331FE	435033312R1	1
VD8258	R6152	C-CARBON R	RN72K1J-332FE	435033322R1	1
VD8258	R6153	C-CARBON R	RN72K1J-102FE	435031022R1	1
VD8258	R6154	C-CARBON R	RN72K1J-471FE	435034712R1	1
VD8258	R6155	C-CARBON R	RN72K1J-273FE	435032732R1	1
VD8258	R6156	C-CARBON R	RN72K1J-273FE	435032732R1	1
VD8258	R6157	C-CARBON R	RN72K1J-332FE	435033322R1	1
VD8258	R6158	C-CARBON R	RN72K1J-151FE	435031512R1	1
VD8258	R6159	C-CARBON R	RN72K1J-102FE	435031022R1	1
VD8258	R6160	C-CARBON R	RN72K1J-203FE	435032032R1	1
VD8258	R6162	C-CARBON R	RN72K1J-240FE	435032402R1	1
VD8258	R6164	C-CARBON R	RN72K1J-103FE	435031032R1	1
VD8258	R6165	C-CARBON R	RN72K1J-750FE	435037502R1	1
VD8258	R6166	C-CARBON R	RN72K1J-000JE	435030004R1	1

VD8258	R6167	C-CARBON R	RN72K1J-000JE	435030004R1	1
VD8258	R6171	C-CARBON R	RN72K1J-102FE	435031022R1	1
VD8258	R6172	C-CARBON R	RN72K1J-203FE	435032032R1	1
VD8258	R6174	C-CARBON R	RN72K1J-240FE	435032402R1	1
VD8258	R6176	C-CARBON R	RN72K1J-103FE	435031032R1	1
VD8258	R6177	C-CARBON R	RN72K1J-750FE	435037502R1	1
VD8258	R6191	C-CARBON R	RN72K1J-101JE	435031014R1	1
VD8258	R6201	C-CARBON R	RN72K1J-331FE	435033312R1	1
VD8258	R6202	C-CARBON R	RN72K1J-332FE	435033322R1	1
VD8258	R6203	C-CARBON R	RN72K1J-102FE	435031022R1	1
VD8258	R6204	C-CARBON R	RN72K1J-471FE	435034712R1	1
VD8258	R6205	C-CARBON R	RN72K1J-273FE	435032732R1	1
VD8258	R6206	C-CARBON R	RN72K1J-273FE	435032732R1	1
VD8258	R6207	C-CARBON R	RN72K1J-332FE	435033322R1	1
VD8258	R6208	C-CARBON R	RN72K1J-151FE	435031512R1	1
VD8258	R6209	C-CARBON R	RN72K1J-102FE	435031022R1	1
VD8258	R6210	C-CARBON R	RN72K1J-223FE	435032232R1	1
VD8258	R6212	C-CARBON R	RN72K1J-240FE	435032402R1	1
VD8258	R6214	C-CARBON R	RN72K1J-103FE	435031032R1	1
VD8258	R6215	C-CARBON R	RN72K1J-750FE	435037502R1	1
VD8258	R6216	C-CARBON R	RN72K1J-000JE	435030004R1	1
VD8258	R6217	C-CARBON R	RN72K1J-000JE	435030004R1	1
VD8258	R6221	C-CARBON R	RN72K1J-102FE	435031022R1	1
VD8258	R6222	C-CARBON R	RN72K1J-223FE	435032232R1	1
VD8258	R6224	C-CARBON R	RN72K1J-240FE	435032402R1	1
VD8258	R6226	C-CARBON R	RN72K1J-103FE	435031032R1	1
VD8258	R6227	C-CARBON R	RN72K1J-750FE	435037502R1	1
VD8258	R6233	C-CARBON R	RN72K1J-000JE	435030004R1	1
VD8258	R6251	C-CARBON R	RN72K1J-331FE	435033312R1	1
VD8258	R6252	C-CARBON R	RN72K1J-332FE	435033322R1	1
VD8258	R6253	C-CARBON R	RN72K1J-102FE	435031022R1	1
VD8258	R6254	C-CARBON R	RN72K1J-471FE	435034712R1	1
VD8258	R6255	C-CARBON R	RN72K1J-273FE	435032732R1	1

VD8258	R6256	C-CARBON R	RN72K1J-273FE	435032732R1	1
VD8258	R6257	C-CARBON R	RN72K1J-332FE	435033322R1	1
VD8258	R6258	C-CARBON R	RN72K1J-151FE	435031512R1	1
VD8258	R6259	C-CARBON R	RN72K1J-102FE	435031022R1	1
VD8258	R6260	C-CARBON R	RN72K1J-223FE	435032232R1	1
VD8258	R6262	C-CARBON R	RN72K1J-240FE	435032402R1	1
VD8258	R6264	C-CARBON R	RN72K1J-103FE	435031032R1	1
VD8258	R6265	C-CARBON R	RN72K1J-750FE	435037502R1	1
VD8258	R6266	C-CARBON R	RN72K1J-822FE	435038222R1	1
VD8258	R6267	C-CARBON R	RN72K1J-122FE	435031222R1	1
VD8258	R6268	C-CARBON R	RN72K1J-122FE	435031222R1	1
VD8258	R6269	C-CARBON R	RN72K1J-122FE	435031222R1	1
VD8258	R6271	C-CARBON R	RN72K1J-102FE	435031022R1	1
VD8258	R6272	C-CARBON R	RN72K1J-223FE	435032232R1	1
VD8258	R6274	C-CARBON R	RN72K1J-240FE	435032402R1	1
VD8258	R6276	C-CARBON R	RN72K1J-103FE	435031032R1	1
VD8258	R6277	C-CARBON R	RN72K1J-750FE	435037502R1	1
VD8258	R6278	C-CARBON R	RN72K1J-822FE	435038222R1	1
VD8258	R6279	C-CARBON R	RN72K1J-122FE	435031222R1	1
VD8258	R6286	C-CARBON R	RN72K1J-000JE	435030004R1	1
VD8258	R6287	C-CARBON R	RN72K1J-000JE	435030004R1	1
VD8258	R6301	C-CARBON R	RN72K1J-331FE	435033312R1	1
VD8258	R6302	C-CARBON R	RN72K1J-332FE	435033322R1	1
VD8258	R6303	C-CARBON R	RN72K1J-102FE	435031022R1	1
VD8258	R6304	C-CARBON R	RN72K1J-471FE	435034712R1	1
VD8258	R6305	C-CARBON R	RN72K1J-273FE	435032732R1	1
VD8258	R6306	C-CARBON R	RN72K1J-273FE	435032732R1	1
VD8258	R6307	C-CARBON R	RN72K1J-332FE	435033322R1	1
VD8258	R6308	C-CARBON R	RN72K1J-151FE	435031512R1	1
VD8258	R6309	C-CARBON R	RN72K1J-102FE	435031022R1	1
VD8258	R6310	C-CARBON R	RN72K1J-203FE	435032032R1	1
VD8258	R6312	C-CARBON R	RN72K1J-240FE	435032402R1	1
VD8258	R6314	C-CARBON R	RN72K1J-103FE	435031032R1	1

VD8258	R6315	C-CARBON R	RN72K1J-750FE	435037502R1	1
VD8258	R6317	C-CARBON R	RN72K1J-000JE	435030004R1	1
VD8258	R6351	C-CARBON R	RN72K1J-331FE	435033312R1	1
VD8258	R6352	C-CARBON R	RN72K1J-332FE	435033322R1	1
VD8258	R6353	C-CARBON R	RN72K1J-102FE	435031022R1	1
VD8258	R6354	C-CARBON R	RN72K1J-471FE	435034712R1	1
VD8258	R6355	C-CARBON R	RN72K1J-273FE	435032732R1	1
VD8258	R6356	C-CARBON R	RN72K1J-223FE	435032232R1	1
VD8258	R6357	C-CARBON R	RN72K1J-000JE	435030004R1	1
VD8258	R6358	C-CARBON R	RN72K1J-151FE	435031512R1	1
VD8258	R6359	C-CARBON R	RN72K1J-102FE	435031022R1	1
VD8258	R6360	C-CARBON R	RN72K1J-243FE	435032432R1	1
VD8258	R6362	C-CARBON R	RN72K1J-240FE	435032402R1	1
VD8258	R6364	C-CARBON R	RN72K1J-103FE	435031032R1	1
VD8258	R6365	C-CARBON R	RN72K1J-750FE	435037502R1	1
VD8258	R6367	C-CARBON R	RN72K1J-000JE	435030004R1	1
VD8258	R6401	C-CARBON R	RN72K1J-331FE	435033312R1	1
VD8258	R6402	C-CARBON R	RN72K1J-332FE	435033322R1	1
VD8258	R6403	C-CARBON R	RN72K1J-102FE	435031022R1	1
VD8258	R6404	C-CARBON R	RN72K1J-471FE	435034712R1	1
VD8258	R6405	C-CARBON R	RN72K1J-273FE	435032732R1	1
VD8258	R6406	C-CARBON R	RN72K1J-223FE	435032232R1	1
VD8258	R6407	C-CARBON R	RN72K1J-000JE	435030004R1	1
VD8258	R6408	C-CARBON R	RN72K1J-151FE	435031512R1	1
VD8258	R6409	C-CARBON R	RN72K1J-102FE	435031022R1	1
VD8258	R6410	C-CARBON R	RN72K1J-243FE	435032432R1	1
VD8258	R6412	C-CARBON R	RN72K1J-240FE	435032402R1	1
VD8258	R6414	C-CARBON R	RN72K1J-103FE	435031032R1	1
VD8258	R6415	C-CARBON R	RN72K1J-750FE	435037502R1	1
VD8258	R6417	C-CARBON R	RN72K1J-000JE	435030004R1	1
VD8258	R6455	C-CARBON R	RN72K1J-222FE	435032222R1	1
VD8258	R6456	C-CARBON R	RN72K1J-222FE	435032222R1	1
VD8258	R6457	C-CARBON R	RN72K1J-222FE	435032222R1	1

VD8258	R6458	G-CARBON R	RN72K1J-222FE	435032222R1	1
VD8258	R6459	G-CARBON R	RN72K1J-471FE	435034712R1	1
VD8258	R6460	G-CARBON R	RN72K1J-471FE	435034712R1	1
VD8258	R6461	G-CARBON R	RN72K1J-101FE	435031012R1	1
VD8258	R6462	G-CARBON R	RN72K1J-101FE	435031012R1	1
VD8258	R6465	G-CARBON R	RN72K1J-103FE	435031032R1	1
VD8258	R6466	G-CARBON R	RN72K1J-223FE	435032232R1	1
VD8258	R6467	G-CARBON R	RN72K1J-000JE	435030004R1	1
VD8258	R6468	G-CARBON R	RN72K1J-000JE	435030004R1	1
VD8258	R6469	G-CARBON R	RN72K1J-000JE	435030004R1	1
VD8258	R6470	G-CARBON R	RN72K1J-000JE	435030004R1	1
VD8258	R6471	G-CARBON R	RN72K1J-000JE	435030004R1	1
VD8258	R6472	G-CARBON R	RN72K1J-000JE	435030004R1	1
VD8258	R6501	G-CARBON R	RN72K1J-103FE	435031032R1	1
VD8258	R6503	G-CARBON R	RN72K1J-122FE	435031222R1	1
VD8258	R6504	G-CARBON R	RN72K1J-122FE	435031222R1	1
VD8258	R6505	G-CARBON R	RN72K1J-103FE	435031032R1	1
VD8258	R6506	G-CARBON R	RN72K1J-000JE	435030004R1	1
VD8258	R6507	G-CARBON R	RN72K1J-102FE	435031022R1	1
VD8258	R6508	G-CARBON R	RN72K1J-681FE	435036812R1	1
VD8258	R6509	G-CARBON R	RN72K1J-272FE	435032722R1	1
VD8258	R6510	G-CARBON R	RN72K1J-681FE	435036812R1	1
VD8258	R6511	G-CARBON R	RN72K1J-681FE	435036812R1	1
VD8258	R6512	G-CARBON R	RN72K1J-272FE	435032722R1	1
VD8258	R6513	G-CARBON R	RN72K1J-681FE	435036812R1	1
VD8258	R6514	G-CARBON R	RN72K1J-681FE	435036812R1	1
VD8258	R6515	G-CARBON R	RN72K1J-103FE	435031032R1	1
VD8258	R6516	G-CARBON R	RN72K1J-103FE	435031032R1	1
VD8258	R6517	G-CARBON R	RN72K1J-103FE	435031032R1	1
VD8258	R6518	G-CARBON R	RN72K1J-000JE	435030004R1	1
VD8258	R6519	G-CARBON R	RN72K1J-473FE	435034732R1	1
VD8258	R6521	G-CARBON R	RN72K1J-152FE	435031522R1	1
VD8258	R6522	G-CARBON R	RN72K1J-153FE	435031532R1	1

VD8258	R6523	C-CARBON R	RN72K1J-000JE	435030004R1	1
VD8258	R6524	C-CARBON R	RN72K1J-104FE	435031042R1	1
VD8258	R6525	C-CARBON R	RN72K1J-564FE	435035642R1	1
VD8258	R6526	C-CARBON R	RN72K1J-684FE	435036842R1	1
VD8258	R6527	C-CARBON R	RN72K1J-000JE	435030004R1	1
VD8258	R6529	C-CARBON R	RN72K1J-221FE	435032212R1	1
VD8258	R6530	C-CARBON R	RN72K1J-102FE	435031022R1	1
VD8258	R6531	C-CARBON R	RN72K1J-102FE	435031022R1	1
VD8258	R6532	C-CARBON R	RN72K1J-102FE	435031022R1	1
VD8258	R6533	C-CARBON R	RN72K1J-102FE	435031022R1	1
VD8258	R6541	C-CARBON R	RN72K1J-331FE	435033312R1	1
VD8258	R6542	C-CARBON R	RN72K1J-332FE	435033322R1	1
VD8258	R6543	C-CARBON R	RN72K1J-331FE	435033312R1	1
VD8258	R6544	C-CARBON R	RN72K1J-332FE	435033322R1	1
VD8258	R6545	C-CARBON R	RN72K1J-331FE	435033312R1	1
VD8258	R6546	C-CARBON R	RN72K1J-332FE	435033322R1	1
VD8258	R6547	C-CARBON R	RN72K1J-000JE	435030004R1	1
VD8258	R6548	C-CARBON R	RN72K1J-000JE	435030004R1	1
VD8258	R6549	C-CARBON R	RN72K1J-000JE	435030004R1	1
VD8258	R6551	C-CARBON R	RN72K1J-331FE	435033312R1	1
VD8258	R6552	C-CARBON R	RN72K1J-332FE	435033322R1	1
VD8258	R6553	C-CARBON R	RN72K1J-102FE	435031022R1	1
VD8258	R6554	C-CARBON R	RN72K1J-471FE	435034712R1	1
VD8258	R6555	C-CARBON R	RN72K1J-103FE	435031032R1	1
VD8258	R6556	C-CARBON R	RN72K1J-102FE	435031022R1	1
VD8258	R6557	C-CARBON R	RN72K1J-471FE	435034712R1	1
VD8258	R6558	C-CARBON R	RN72K1J-273FE	435032732R1	1
VD8258	R6559	C-CARBON R	RN72K1J-562FE	435035622R1	1
VD8258	R6560	C-CARBON R	RN72K1J-821FE	435038212R1	1
VD8258	R6561	C-CARBON R	RN72K1J-101FE	435031012R1	1
VD8258	R6562	C-CARBON R	RN72K1J-471FE	435034712R1	1
VD8258	R6563	C-CARBON R	RN72K1J-681FE	435036812R1	1
VD8258	R6564	C-CARBON R	RN72K1J-682FE	435036822R1	1

VD8258	R6565	G-CARBON R	RN72K1J-103FE	435031032R1	1
VD8258	R6566	G-CARBON R	RN72K1J-122FE	435031222R1	1
VD8258	R6567	G-CARBON R	RN72K1J-122FE	435031222R1	1
VD8258	R6568	G-CARBON R	RN72K1J-101FE	435031012R1	1
VD8258	R6571	G-CARBON R	RN72K1J-222FE	435032222R1	1
VD8258	R6572	G-CARBON R	RN72K1J-222FE	435032222R1	1
VD8258	R6573	G-CARBON R	RN72K1J-222FE	435032222R1	1
VD8258	R6574	G-CARBON R	RN72K1J-000JE	435030004R1	1
VD8258	R6575	G-CARBON R	RN72K1J-000JE	435030004R1	1
VD8258	R6576	G-CARBON R	RN72K1J-270FE	435032702R1	1
VD8258	R6601	G-CARBON R	RN72K1J-331FE	435033312R1	1
VD8258	R6602	G-CARBON R	RN72K1J-332FE	435033322R1	1
VD8258	R6603	G-CARBON R	RN72K1J-102FE	435031022R1	1
VD8258	R6604	G-CARBON R	RN72K1J-471FE	435034712R1	1
VD8258	R6605	G-CARBON R	RN72K1J-103FE	435031032R1	1
VD8258	R6606	G-CARBON R	RN72K1J-102FE	435031022R1	1
VD8258	R6607	G-CARBON R	RN72K1J-471FE	435034712R1	1
VD8258	R6608	G-CARBON R	RN72K1J-273FE	435032732R1	1
VD8258	R6609	G-CARBON R	RN72K1J-682FE	435036822R1	1
VD8258	R6610	G-CARBON R	RN72K1J-101FE	435031012R1	1
VD8258	R6611	G-CARBON R	RN72K1J-101FE	435031012R1	1
VD8258	R6612	G-CARBON R	RN72K1J-471FE	435034712R1	1
VD8258	R6613	G-CARBON R	RN72K1J-181FE	435031812R1	1
VD8258	R6614	G-CARBON R	RN72K1J-821FE	435038212R1	1
VD8258	R6615	G-CARBON R	RN72K1J-103FE	435031032R1	1
VD8258	R6616	G-CARBON R	RN72K1J-122FE	435031222R1	1
VD8258	R6617	G-CARBON R	RN72K1J-122FE	435031222R1	1
VD8258	R6618	G-CARBON R	RN72K1J-101FE	435031012R1	1
VD8258	R6626	G-CARBON R	RN72K1J-270FE	435032702R1	1
VD8258	R6631	G-CARBON R	RN72K1J-000JE	435030004R1	1
VD8258	R6632	G-CARBON R	RN72K1J-000JE	435030004R1	1
VD8258	R6633	G-CARBON R	RN72K1J-000JE	435030004R1	1
VD8258	R6634	G-CARBON R	RN72K1J-000JE	435030004R1	1

N

VD8258	R6635	C-CARBON R	RN72K1J-000JE	435030004R1	1
VD8258	R6636	C-CARBON R	RN72K1J-000JE	435030004R1	1
VD8258	R6637	C-CARBON R	RN72K1J-000JE	435030004R1	1
VD8258	R6638	C-CARBON R	RN72K1J-000JE	435030004R1	1
VD8258	R6639	C-CARBON R	RN72K1J-000JE	435030004R1	1
VD8258	R6640	C-CARBON R	RN72K1J-000JE	435030004R1	1
VD8258	R6651	C-CARBON R	RN72K1J-331FE	435033312R1	1
VD8258	R6652	C-CARBON R	RN72K1J-332FE	435033322R1	1
VD8258	R6653	C-CARBON R	RN72K1J-102FE	435031022R1	1
VD8258	R6654	C-CARBON R	RN72K1J-471FE	435034712R1	1
VD8258	R6655	C-CARBON R	RN72K1J-103FE	435031032R1	1
VD8258	R6656	C-CARBON R	RN72K1J-102FE	435031022R1	1
VD8258	R6657	C-CARBON R	RN72K1J-471FE	435034712R1	1
VD8258	R6658	C-CARBON R	RN72K1J-273FE	435032732R1	1
VD8258	R6659	C-CARBON R	RN72K1J-682FE	435036822R1	1
VD8258	R6660	C-CARBON R	RN72K1J-101FE	435031012R1	1
VD8258	R6661	C-CARBON R	RN72K1J-101FE	435031012R1	1
VD8258	R6662	C-CARBON R	RN72K1J-471FE	435034712R1	1
VD8258	R6663	C-CARBON R	RN72K1J-331FE	435033312R1	1
VD8258	R6664	C-CARBON R	RN72K1J-472FE	435034722R1	1
VD8258	R6665	C-CARBON R	RN72K1J-103FE	435031032R1	1
VD8258	R6666	C-CARBON R	RN72K1J-122FE	435031222R1	1
VD8258	R6667	C-CARBON R	RN72K1J-122FE	435031222R1	1
VD8258	R6676	C-CARBON R	RN72K1J-270FE	435032702R1	1
VD8258	R6851	C-CARBON R	RN72K1J-103JE	435031034R1	1
VD8258	R6852	C-CARBON R	RN72K1J-103JE	435031034R1	1
VD8258	R6853	C-CARBON R	RN72K1J-103JE	435031034R1	1
VD8258	R6854	C-CARBON R	RN72K1J-102JE	435031024R1	1
VD8258	R6855	C-CARBON R	RN72K1J-240FE	435032402R1	1
VD8258	R6856	C-CARBON R	RN72K1J-105JE	435031054R1	1
VD8258	R6857	C-CARBON R	RN72K1J-105JE	435031054R1	1
VD8258	R6858	C-CARBON R	RN72K1J-240FE	435032402R1	1
VD8258	R6859	C-CARBON R	RN72K1J-105JE	435031054R1	1

N

VD8258	R6860	C-CARBON R	RN72K1J-105JE	435031054R1	1
VD8258	R6861	C-CARBON R	RN72K1J-102JE	435031024R1	1
VD8258	R6862	C-CARBON R	RN72K1J-102JE	435031024R1	1
VD8258	R6863	C-CARBON R	RN72K1J-105JE	435031054R1	1
VD8258	R6864	C-CARBON R	RN72K1J-105JE	435031054R1	1
VD8258	R6865	C-CARBON R	RN72K1J-240FE	435032402R1	1
VD8258	R6866	C-CARBON R	RN72K1J-750JE	435037504R1	1
VD8258	R6867	C-CARBON R	RN72K1J-750JE	435037504R1	1
VD8258	R6868	C-CARBON R	RN72K1J-750JE	435037504R1	1
VD8258	R7001	C-CARBON R	RN72K1J-220FE	435032202R1	1
VD8258	R7002	C-CARBON R	RN72K1J-220FE	435032202R1	1
VD8258	R7003	C-CARBON R	RN72K1J-220FE	435032202R1	1
VD8258	R7004	C-CARBON R	RN72K1J-220FE	435032202R1	1
VD8258	R7005	C-CARBON R	RN72K1J-220FE	435032202R1	1
VD8258	R7006	C-CARBON R	RN72K1J-220FE	435032202R1	1
VD8258	R7007	C-CARBON R	RN72K1J-220FE	435032202R1	1
VD8258	R7008	C-CARBON R	RN72K1J-103FE	435031032R1	1
VD8258	R7009	C-CARBON R	RN72K1J-103FE	435031032R1	1
VD8258	R7010	C-CARBON R	RN72K1J-220FE	435032202R1	1
VD8258	R7011	C-CARBON R	RN72K1J-220FE	435032202R1	1
VD8258	R7012	C-CARBON R	RN72K1J-220FE	435032202R1	1
VD8258	R7013	C-CARBON R	RN72K1J-102FE	435031022R1	1
VD8258	R7014	C-CARBON R	RN72K1J-102FE	435031022R1	1
VD8258	R7015	C-CARBON R	RN72K1J-220FE	435032202R1	1
VD8258	R7016	C-CARBON R	RN72K1J-220FE	435032202R1	1
VD8258	R7017	C-CARBON R	RN72K1J-220FE	435032202R1	1
VD8258	R7018	C-CARBON R	RN72K1J-103FE	435031032R1	1
VD8258	R7020	C-CARBON R	RN72K1J-102FE	435031022R1	1
VD8258	R7021	C-CARBON R	RN72K1J-220FE	435032202R1	1
VD8258	R7022	C-CARBON R	RN72K1J-220FE	435032202R1	1
VD8258	R7023	C-CARBON R	RN72K1J-220FE	435032202R1	1
VD8258	R7024	C-CARBON R	RN72K1J-220FE	435032202R1	1
VD8258	R7025	C-CARBON R	RN72K1J-220FE	435032202R1	1

VD8258	R7026	G-CARBON R	RN72K1J-220FE	435032202R1	1
VD8258	R7027	G-CARBON R	RN72K1J-220FE	435032202R1	1
VD8258	R7028	G-CARBON R	RN72K1J-103FE	435031032R1	1
VD8258	R7029	G-CARBON R	RN72K1J-220FE	435032202R1	1
VD8258	R7030	G-CARBON R	RN72K1J-103FE	435031032R1	1
VD8258	R7031	G-CARBON R	RN72K1J-220FE	435032202R1	1
VD8258	R7032	G-CARBON R	RN72K1J-220FE	435032202R1	1
VD8258	R7033	G-CARBON R	RN72K1J-103FE	435031032R1	1
VD8258	R7034	G-CARBON R	RN72K1J-220FE	435032202R1	1
VD8258	R7035	G-CARBON R	RN72K1J-103FE	435031032R1	1
VD8258	R7036	G-CARBON R	RN72K1J-220FE	435032202R1	1
VD8258	R7037	G-CARBON R	RN72K1J-220FE	435032202R1	1
VD8258	R7038	G-CARBON R	RN72K1J-220FE	435032202R1	1
VD8258	R7039	G-CARBON R	RN72K1J-220FE	435032202R1	1
VD8258	R7040	G-CARBON R	RN72K1J-220FE	435032202R1	1
VD8258	R7041	G-CARBON R	RN72K1J-102FE	435031022R1	1
VD8258	R7042	G-CARBON R	RN72K1J-102FE	435031022R1	1
VD8258	R7043	G-CARBON R	RN72K1J-102FE	435031022R1	1
VD8258	R7044	G-CARBON R	RN72K1J-102FE	435031022R1	1
VD8258	R7045	G-CARBON R	RN72K1J-102FE	435031022R1	1
VD8258	R7046	G-CARBON R	RN72K1J-102FE	435031022R1	1
VD8258	R7047	G-CARBON R	RN72K1J-102FE	435031022R1	1
VD8258	R7048	G-CARBON R	RN72K1J-102FE	435031022R1	1
VD8258	R7049	G-CARBON R	RN72K1J-221FE	435032212R1	1
VD8258	R7050	G-CARBON R	RN72K1J-221FE	435032212R1	1
VD8258	R7051	G-CARBON R	RN72K1J-221FE	435032212R1	1
VD8258	R7052	G-CARBON R	RN72K1J-221FE	435032212R1	1
VD8258	R7053	G-CARBON R	RN72K1J-221FE	435032212R1	1
VD8258	R7054	G-CARBON R	RN72K1J-221FE	435032212R1	1
VD8258	R7055	G-CARBON R	RN72K1J-472FE	435034722R1	1
VD8258	R7056	G-CARBON R	RN72K1J-472FE	435034722R1	1
VD8258	R7057	G-CARBON R	RN72K1J-472FE	435034722R1	1
VD8258	R7058	G-CARBON R	RN72K1J-472FE	435034722R1	1

VD8258	R7059	G-CARBON R	RN72K1J-103FE	435031032R1	1
VD8258	R7060	G-CARBON R	RN72K1J-563FE	435035632R1	1
VD8258	R7061	G-CARBON R	RN72K1J-472FE	435034722R1	1
VD8258	R7062	G-CARBON R	RN72K1J-103FE	435031032R1	1
VD8258	R7062	G-CARBON R	RN72K1J-273FE	435032732R1	1
VD8258	R7063	G-CARBON R	RN72K1J-563FE	435035632R1	1
VD8258	R7063	G-CARBON R	RN72K1J-683FE	435036832R1	1
VD8258	R7064	G-CARBON R	RN72K1J-220FE	435032202R1	1
VD8258	R7069	G-CARBON R	RN72K1J-103FE	435031032R1	1
VD8258	R7071	G-CARBON R	RN72K1J-103FE	435031032R1	1
VD8258	R7073	G-CARBON R	RN72K1J-103FE	435031032R1	1
VD8258	R7075	G-CARBON R	RN72K1J-103FE	435031032R1	1
VD8258	R7077	G-CARBON R	RN72K1J-103FE	435031032R1	1
VD8258	R7078	G-CARBON R	RN72K1J-103FE	435031032R1	1
VD8258	R7079	G-CARBON R	RN72K1J-472FE	435034722R1	1
VD8258	R7080	G-CARBON R	RN72K1J-472FE	435034722R1	1
VD8258	R7101	G-CARBON R	RN72K1J-000JE	435030004R1	1
VD8258	R7102	G-CARBON R	RN72K1J-000JE	435030004R1	1
VD8258	R7103	G-CARBON R	RN72K1J-000JE	435030004R1	1
VD8258	R7104	G-CARBON R	RN72K1J-000JE	435030004R1	1
VD8258	R7105	G-CARBON R	RN72K1J-000JE	435030004R1	1
VD8258	R7106	G-CARBON R	RN72K1J-000JE	435030004R1	1
VD8258	R7107	G-CARBON R	RN72K1J-000JE	435030004R1	1
VD8258	R7108	G-CARBON R	RN72K1J-000JE	435030004R1	1
VD8258	R7109	G-CARBON R	RN72K1J-000JE	435030004R1	1
VD8258	R7110	G-CARBON R	RN72K1J-000JE	435030004R1	1
VD8258	R7111	G-CARBON R	RN72K1J-000JE	435030004R1	1
VD8258	R7112	G-CARBON R	RN72K1J-000JE	435030004R1	1
VD8258	R7113	G-CARBON R	RN72K1J-000JE	435030004R1	1
VD8258	R7114	G-CARBON R	RN72K1J-000JE	435030004R1	1
VD8258	R7115	G-CARBON R	RN72K1J-000JE	435030004R1	1
VD8258	R7116	G-CARBON R	RN72K1J-000JE	435030004R1	1
VD8258	R7117	G-CARBON R	RN72K1J-000JE	435030004R1	1

VD8258	R7118	G-CARBON R	RN72K11-000JE	435030004R1	1
VD8258	R7119	G-CARBON R	RN72K11-000JE	435030004R1	1
VD8258	R7120	G-CARBON R	RN72K11-000JE	435030004R1	1
VD8258	R7121	G-CARBON R	RN72K11-000JE	435030004R1	1
VD8258	R7122	G-CARBON R	RN72K11-000JE	435030004R1	1
VD8258	R7123	G-CARBON R	RN72K11-000JE	435030004R1	1
VD8258	R7124	G-CARBON R	RN72K11-000JE	435030004R1	1
VD8258	R7125	G-CARBON R	RN72K11-000JE	435030004R1	1
VD8258	R7126	G-CARBON R	RN72K11-000JE	435030004R1	1
VD8258	R7127	G-CARBON R	RN72K11-000JE	435030004R1	1
VD8258	R7128	G-CARBON R	RN72K11-000JE	435030004R1	1
VD8258	R7129	G-CARBON R	RN72K11-000JE	435030004R1	1
VD8258	R7130	G-CARBON R	RN72K11-000JE	435030004R1	1
VD8258	R7131	G-CARBON R	RN72K11-000JE	435030004R1	1
VD8258	R7132	G-CARBON R	RN72K11-000JE	435030004R1	1
VD8258	R7133	G-CARBON R	RN72K11-000JE	435030004R1	1
VD8258	R7134	G-CARBON R	RN72K11-000JE	435030004R1	1
VD8258	R7201	G-CARBON R	RN72K11-220FE	435032202R1	1
VD8258	R7202	G-CARBON R	RN72K11-220FE	435032202R1	1
VD8258	R7203	G-CARBON R	RN72K11-220FE	435032202R1	1
VD8258	R7204	G-CARBON R	RN72K11-220FE	435032202R1	1
VD8258	R7205	G-CARBON R	RN72K11-472FE	435034722R1	1
VD8258	R7206	G-CARBON R	RN72K11-224FE	435032242R1	1
VD8258	R7207	G-CARBON R	RN72K11-473FE	435034732R1	1
VD8258	R7208	G-CARBON R	RN72K11-000JE	435030004R1	1
VD8258	R7209	G-CARBON R	RN72K11-000JE	435030004R1	1
VD8258	R7210	G-CARBON R	RN72K11-000JE	435030004R1	1
VD8258	R7211	G-CARBON R	RN72K11-000JE	435030004R1	1
VD8258	R7212	G-CARBON R	RN72K11-000JE	435030004R1	1
VD8258	R7213	G-CARBON R	RN72K11-000JE	435030004R1	1
VD8258	R7214	G-CARBON R	RN72K11-000JE	435030004R1	1
VD8258	R7215	G-CARBON R	RN72K11-000JE	435030004R1	1
VD8258	R7216	G-CARBON R	RN72K11-000JE	435030004R1	1

VD8258	R7217	G-CARBON R	RN72K1J-000JE	435030004R1	1
VD8258	R7218	G-CARBON R	RN72K1J-471JE	435034714R1	1
VD8258	R7301	G-CARBON R	RN72K1J-103FE	435031032R1	1
VD8258	R7302	G-CARBON R	RN72K1J-223FE	435032232R1	1
VD8258	R7303	G-CARBON R	RN72K1J-223FE	435032232R1	1
VD8258	R7304	G-CARBON R	RN72K1J-103FE	435031032R1	1
VD8258	R7305	G-CARBON R	RN72K1J-102FE	435031022R1	1
VD8258	R7306	G-CARBON R	RN72K1J-104FE	435031042R1	1
VD8258	R7310	G-CARBON R	RN72K1J-103FE	435031032R1	1
VD8258	R7311	G-CARBON R	RN72K1J-103FE	435031032R1	1
VD8258	R7312	G-CARBON R	RN72K1J-103FE	435031032R1	1
VD8258	R7313	G-CARBON R	RN72K1J-103FE	435031032R1	1
VD8258	R7314	G-CARBON R	RN72K1J-102FE	435031022R1	1
VD8258	R7315	G-CARBON R	RN72K1J-103FE	435031032R1	1
VD8258	R7317	G-CARBON R	RN72K1J-470FE	435034702R1	1
VD8258	R7318	G-CARBON R	RN72K1J-470FE	435034702R1	1
VD8258	R7319	G-CARBON R	RN72K1J-470FE	435034702R1	1
VD8258	R7320	G-CARBON R	RN72K1J-470FE	435034702R1	1
VD8258	R7321	G-CARBON R	RN72K1J-470FE	435034702R1	1
VD8258	R7322	G-CARBON R	RN72K1J-470FE	435034702R1	1
VD8258	R7401	G-CARBON R	RN72K1J-152FE	435031522R1	1
VD8258	R7402	G-CARBON R	RN72K1J-152FE	435031522R1	1
VD8258	R7403	G-CARBON R	RN72K1J-000JE	435030004R1	1
VD8258	R7404	G-CARBON R	RN72K1J-000JE	435030004R1	1
VD8258	R7405	G-CARBON R	RN72K1J-000JE	435030004R1	1
VD8258	R7406	G-CARBON R	RN72K1J-224FE	435032242R1	1
VD8258	S4751	SLIDE SW	NSS-22155	25065414	1
VD8258	S7301	PUSH SW	NPS-111-S681	25035718	1
VD8258	X6151	CRYSTAL	FCX03-20.000MHZ	3010389R2	N 1
VD8258	X7001	CERA LOCK	CSTCE12M0G	3010395R2	N 1
VD8258	X7002	PIEZO	PKM13EPPY-4002	3010309	1

PCB NO. CIRCUIT PART NAME DESCRIPTION PART NO. REMARKS

DI88264	C4201	VX C	CE04W25V-470M(VX)	393354717		1
DI88264	C4202	VX C	CE04W25V-470M(VX)	393354717		1
DI88264	C4203	VX C	CE04W16V-220M(VX)	393342217		1
DI88264	C4204	VX C	CE04W16V-220M(VX)	393342217		1
DI88264	C4205	VX C	CE04W16V-220M(VX)	393342217		1
DI88264	C4206	VX C	CE04W16V-220M(VX)	393342217		1
DI88264	C4701	VX C	CE04W16V-47M(VX)	393344707		1
DI88264	C4702	VX C	CE04W16V-47M(VX)	393344707		1
DI88264	C4705	RFS C	CE04W25V-47M(RFS)	395954707	N	1
DI88264	C4706	RFS C	CE04W25V-47M(RFS)	395954707	N	1
DI88264	C4753	VX C	CE04W50V-47M(VX)	393384707		1
DI88264	C4754	VX C	CE04W50V-47M(VX)	393384707		1
DI88264	C4755	G-CERA C	CK725F1E-104Z1	332161040R1		1
DI88264	C4803	RFS C	CE04W25V-47M(RFS)	395954707	N	1
DI88264	C4804	RFS C	CE04W25V-47M(RFS)	395954707	N	1
DI88264	C4853	VX C	CE04W50V-47M(VX)	393384707		1
DI88264	C4854	VX C	CE04W50V-47M(VX)	393384707		1
DI88264	C4903	VX C	CE04W50V-47M(VX)	393384707		1
DI88264	C4904	VX C	CE04W50V-47M(VX)	393384707		1
DI88264	C4921	VX C	CE04W6.3V-470M(VX)	393324717		1
DI88264	C4951	G-CERA C	CK725F1E-104Z1	332161040R1		1
DI88264	C4952	G-CERA C	CK725F1E-104Z1	332161040R1		1
DI88264	C4953	G-CERA C	CK725B1H-103K1	332101035R1		1
DI88264	C4954	G-CERA C	CK725B1H-103K1	332101035R1		1
DI88264	C4955	VX C	CE04W6.3V-100M(VX)	393321017		1
DI88264	C4956	VX C	CE04W6.3V-100M(VX)	393321017		1
DI88264	C4957	G-CERA C	CK725F1E-104Z1	332161040R1		1
DI88264	C4958	VX C	CE04W6.3V-100M(VX)	393321017		1
DI88264	C4959	G-CERA C	CK732B1H 223K	337322235R1		1
DI88264	C4960	G-CERA C	CC725CH1H-330J1	342103304R1		1
DI88264	C4961	G-CERA C	CC725CH1H-330J1	342103304R1		1
DI88264	C4962	G-CERA C	CC725CH1H-330J1	342103304R1		1
DI88264	C4965	G-CERA C	CK725F1E-104Z1	332161040R1		1

DI88264	C4966	VX C	CE04W6.3V-100M(VX)	393321017	1
DI88264	C4967	G-CERA C	CK725F1E-104Z1	332161040R1	1
DI88264	C4968	VX C	CE04W6.3V-100M(VX)	393321017	1
DI88264	C4969	G-CERA C	CK725F1E-104Z1	332161040R1	1
DI88264	C4970	G-CERA C	CK725F1E-104Z1	332161040R1	1
DI88264	C4971	G-CERA C	CK725F1E-104Z1	332161040R1	1
DI88264	C4972	G-CERA C	CK725F1E-104Z1	332161040R1	1
DI88264	C4973	G-CERA C	CK725F1E-104Z1	332161040R1	1
DI88264	C4974	G-CERA C	CK725F1E-104Z1	332161040R1	1
DI88264	C4975	G-CERA C	CC725CH1H-220J1	342102204R1	1
DI88264	C4976	G-CERA C	CC725CH1H-220J1	342102204R1	1
DI88264	C4977	VX C	CE04W6.3V-470M(VX)	393324717	1
DI88264	C4978	VX C	CE04W6.3V-470M(VX)	393324717	1
DI88264	C4999	G-CERA C	CK725F1E-104Z1	332161040R1	1
DI88264	C6781	G-CERA C	CK725F1E-104Z1	332161040R1	1
DI88264	C7501	G-CERA C	CK725F1E-104Z1	332161040R1	1
DI88264	C7502	G-CERA C	CK725F1E-104Z1	332161040R1	1
DI88264	C7503	G-CERA C	CK725F1E-104Z1	332161040R1	1
DI88264	C7504	G-CERA C	CK725F1E-104Z1	332161040R1	1
DI88264	C7505	CHIP ELECT C	CEWX6.3V-100M	356721019R2	1
DI88264	C7506	G-CERA C	CK725B1H-223K1	332102235R1	1
DI88264	C7507	G-CERA C	CK725B1H-223K1	332102235R1	1
DI88264	C7508	G-CERA C	CK725B1H-223K1	332102235R1	1
DI88264	C7509	G-CERA C	CK725F1E-104Z1	332161040R1	1
DI88264	C7510	G-CERA C	CK725F1E-104Z1	332161040R1	1
DI88264	C7511	G-CERA C	CK725F1E-104Z1	332161040R1	1
DI88264	C7512	G-CERA C	CK725F1E-104Z1	332161040R1	1
DI88264	C7513	G-CERA C	CK725F1E-104Z1	332161040R1	1
DI88264	C7515	CHIP ELECT C	CEWX50V-2.2M	356780229R2	1
DI88264	C7516	CHIP ELECT C	CEWX16V-10M	356741009R2	1
DI88264	C7517	G-CERA C	CK725F1E-104Z1	332161040R1	1
DI88264	C7518	G-CERA C	CK725F1E-104Z1	332161040R1	1
DI88264	C7519	G-CERA C	CK725F1E-104Z1	332161040R1	1

DI88264	C7520	CHIP ELECT C	CEWX16V-100M	356741019R2	1
DI88264	C7521	CHIP ELECT C	CEWX50V-10M	356781009R2	1
DI88264	C7522	G-CERA C	CC725CH1H-330J1	342103304R1	1
DI88264	C7528	CHIP ELECT C	CEWX6.3V-100M	356721019R2	1
DI88264	C7529	G-CERA C	CK725F1E-104Z1	332161040R1	1
DI88264	C7530	G-CERA C	CK725F1E-104Z1	332161040R1	1
DI88264	C7531	G-CERA C	CK725F1E-104Z1	332161040R1	1
DI88264	C7702	G-CERA C	CK725F1E-104Z1	332161040R1	1
DI88264	C7703	CHIP ELECT C	CEWX6.3V-100M	356721019R2	1
DI88264	D4201	ZENER D	UDZS13B	224551300R2	N
DI88264	D4202	ZENER D	UDZS13B	224551300R2	N
DI88264	D4751	G-DIODE	ISS352	223234R2	1
DI88264	D4751 0r	G-DIODE	ISS355	223269R2	(1)
DI88264	D4752	G-DIODE	ISS352	223234R2	1
DI88264	D4752 0r	G-DIODE	ISS355	223269R2	(1)
DI88264	D4851	G-DIODE	ISS352	223234R2	1
DI88264	D4851 0r	G-DIODE	ISS355	223269R2	(1)
DI88264	D4852	G-DIODE	ISS352	223234R2	1
DI88264	D4852 0r	G-DIODE	ISS355	223269R2	(1)
DI88264	D4921	G-DIODE	ISS352	223234R2	1
DI88264	D4921 0r	G-DIODE	ISS355	223269R2	(1)
DI88264	D4951	G-DIODE	ISS352	223234R2	1
DI88264	D4951 0r	G-DIODE	ISS355	223269R2	(1)
DI88264	D4952	G-DIODE	ISS352	223234R2	1
DI88264	D4952 0r	G-DIODE	ISS355	223269R2	(1)
DI88264	D4953	G-DIODE	ISS352	223234R2	1
DI88264	D4953 0r	G-DIODE	ISS355	223269R2	(1)
DI88264	D6781	G-DIODE	ISS352	223234R2	1
DI88264	D6781 0r	G-DIODE	ISS355	223269R2	(1)
DI88264	D7501	LED	SEL2E10C	225374	1
DI88264	D7503	LED	SEL2E10C	225374	1
DI88264	D7505	LED	SEL2E10C	225374	1
DI88264	D7507	G-DIODE	ISS352	223234R2	1

DIS8264	D7507 or	C-DIODE	ISS355	223269R2	(1)
DIS8264	D7508	ZENER D	UDZ2.4B	224490240R2	1
DIS8264	D7509	LED	SEL2E10C	225374	1
DIS8264	D7510	LED	SEL2910A-TP6	225390	1
DIS8264	D7511	LED	SEL2910A-TP6	225390	1
DIS8264	D7701	LED	SEL4110R	225290	1
DIS8264	E4602	CLAMP	WS-2NS	27300833	1
DIS8264	E4603	CLAMP	WS-2NS	27300833	1
DIS8264	E4953	RETAINER	KANAGU(φ-r)	27141059	1
DIS8264	L4951	CHOKE COIL	NCH-147I	231237M022R2	1
DIS8264	L4952	CHOKE COIL	NCH-147I	231237M022R2	1
DIS8264	L4953	CHOKE COIL	NCH-147I	231237M022R2	1
DIS8264	L4954	CHOKE COIL	NCH-147I	231237M022R2	1
DIS8264	L4955	CHOKE COIL	NCH-147I	231237M022R2	1
DIS8264	L4956	CHOKE COIL	NCH-157I	233530R2	1
DIS8264	L4999	EMIFIL	BK1608LM182-T	230958R1	1
DIS8264	P4005B	PLUG	NPLG-5P119	25055135	1
DIS8264	P4011	BUS BAR	BBL40	27141867	1
DIS8264	P4202B	PLUG	BM15B-SRSS-TB	25056378R2	N 1
DIS8264	P4203B	PLUG	NPLG-14P1111	25056172R2	N 1
DIS8264	P4571B	PLUG	NPLG-8P1105	25056166R2	N 1
DIS8264	P4950B	PLUG	NPLG-7P135	25055151	1
DIS8264	P4955	PIN JACK	NPJ-2PDB400	25045589	1
DIS8264	P4956	ST JACK	HSJ1002-01-1020	25045647	1
DIS8264	P4958	PIN JACK	NPJ-1PDOR442	25045636	1
DIS8264	P4959	PIN JACK	NPJ-1PDOR442	25045636	1
DIS8264	P4960	PIN JACK	NPJ-2PDWR404	25045593	1
DIS8264	P4961	PIN JACK	NPJ-6PDWRLEGP506	25045715	1
DIS8264	P4964	PIN JACK	NPJ-2PDLE507	25045716	1
DIS8264	P6005B	PLUG	NPLG-8P1105	25056166R2	1
DIS8264	P6551B	PLUG	NPLG-9P1106	25056167R2	1
DIS8264	P6703A	PLUG	NPLG-10P1107	25056168R2	1
DIS8264	P6781	ST JACK	HSJ1501-011010	25045581R2	1

DIS8264	P7010B	PLUG	NPLG-4P1101	25056162R2	1
DIS8264	P7201B	SOCKET	NSCT-26P2696	25052800R2	1
DIS8264	P7801A	WIRE HOL	NSCT-12P883	25051096	1
DIS8264	P7801B	WIRE TRAP	NPLG-12P595	25055633	1
DIS8264	P7801C	JUMPER LEAD	UL2651#26	2J100606B15	1
DIS8264	Q4201	TR	2SB1565-E	2202715	1
DIS8264	Q4201 or	TR	2SB1565-F	2202716	(1)
DIS8264	Q4201A	HEAT SINK	RAD-157	27160491	1
DIS8264	Q4201B	SCREW	3P+10FN(BC)	82143010	1
DIS8264	Q4202	TR	2SD2394-E	2202705	1
DIS8264	Q4202 or	TR	2SD2394-F	2202706	(1)
DIS8264	Q4202A	HEAT SINK	RAD-157	27160491	1
DIS8264	Q4202B	SCREW	3P+10FN(BC)	82143010	1
DIS8264	Q4203	TR	2SC2712-GR	2213145R2	1
DIS8264	Q4204	TR	2SA1162-GR	2214375R2	1
DIS8264	Q4207	TR	RN1407	2216260R2	1
DIS8264	Q4207 or	TR	DTCH14YKA	2216470R2	(1)
DIS8264	Q4208	TR	DTCH14YKA	2216470R2	1
DIS8264	Q4701	IC	NJM4580M-D	22241448R2	1
DIS8264	Q4702	TR	HNI C03F-B	2216141R2	1
DIS8264	Q4703	TR	HNI C03F-B	2216141R2	1
DIS8264	Q4704	TR	RN2403	2214540R2	1
DIS8264	Q4704 or	TR	DTA124EKA	2216240R2	(1)
DIS8264	Q4705	TR	RN2403	2214540R2	1
DIS8264	Q4705 or	TR	DTA124EKA	2216240R2	(1)
DIS8264	Q4751	IC	NJM4580M-D	22241448R2	1
DIS8264	Q4752	TR	HNI C03F-B	2216141R2	1
DIS8264	Q4753	TR	HNI C03F-B	2216141R2	1
DIS8264	Q4755	TR	2SC2712-GR	2213145R2	1
DIS8264	Q4756	TR	2SC2712-GR	2213145R2	1
DIS8264	Q4757	TR	2SA1162-GR	2214375R2	1
DIS8264	Q4758	TR	RN1407	2216260R2	1
DIS8264	Q4758 or	TR	DTCH14YKA	2216470R2	(1)

DIS8264	Q4801	IC	NJM4580M-D	22241448R2	1
DIS8264	Q4802	TR	HN1C03F-B	2216141R2	1
DIS8264	Q4803	TR	HN1C03F-B	2216141R2	1
DIS8264	Q4804	TR	RN2403	2214540R2	1
DIS8264	Q4804 or	TR	DTA124EKA	2216240R2	(1)
DIS8264	Q4805	TR	RN2403	2214540R2	1
DIS8264	Q4805 or	TR	DTA124EKA	2216240R2	(1)
DIS8264	Q4851	IC	NJM4580M-D	22241448R2	1
DIS8264	Q4852	TR	HN1C03F-B	2216141R2	1
DIS8264	Q4853	TR	HN1C03F-B	2216141R2	1
DIS8264	Q4854	TR	RN2403	2214540R2	1
DIS8264	Q4854 or	TR	DTA124EKA	2216240R2	(1)
DIS8264	Q4855	TR	RN2403	2214540R2	1
DIS8264	Q4855 or	TR	DTA124EKA	2216240R2	(1)
DIS8264	Q4857	TR	2SC2712-GR	2213145R2	1
DIS8264	Q4858	TR	2SC2712-GR	2213145R2	1
DIS8264	Q4901	IC	NJM4580M-D	22241448R2	1
DIS8264	Q4902	TR	HN1C03F-B	2216141R2	1
DIS8264	Q4903	TR	HN1C03F-B	2216141R2	1
DIS8264	Q4904	TR	RN2403	2214540R2	1
DIS8264	Q4904 or	TR	DTA124EKA	2216240R2	(1)
DIS8264	Q4905	TR	RN2403	2214540R2	1
DIS8264	Q4905 or	TR	DTA124EKA	2216240R2	(1)
DIS8264	Q4921	TR	2SA1162-GR	2214375R2	1
DIS8264	Q4951	IC	74HCU04F	222740046R2	1
DIS8264	Q4952	IC	74HCU04F	222740046R2	1
DIS8264	Q4953	TR	RN1402	2214470R2	1
DIS8264	Q4953 or	TR	DTC114EKA	2216250R2	(1)
DIS8264	Q4954	TR	RN1402	2214470R2	1
DIS8264	Q4954 or	TR	DTC114EKA	2216250R2	(1)
DIS8264	Q4955	PHT CP	PC817X	24120080	1
DIS8264	Q4956	PHT CP	TOTX179	24120094	1
DIS8264	Q4957	PHT CP	TOTX179	24120094	1

DIS8264	Q4958	TR	2SA1162-GR	2214375R2	1
DIS8264	Q4959	TR	2SA1162-GR	2214375R2	1
DIS8264	Q6781	TR	2SA1162-GR	2214375R2	1
DIS8264	Q6782	TR	RN1402	2214470R2	1
DIS8264	Q6782 or	TR	DTCH14EKA	2216250R2	(1)
DIS8264	Q6783	PHT CP	PC817X	24120080	1
DIS8264	Q7501	IC	MPD780232GC-091-8BT	22241989R3	1
DIS8264	Q7502	FL TUBE	13-BT-211GNK	212247	N 1
DIS8264	Q7502A	HOLDER	(FL)	27191114	1
DIS8264	Q7503	TR	2SC2712-GR	2213145R2	1
DIS8264	Q7504	TR	2SC2712-GR	2213145R2	1
DIS8264	Q7505	TR	IMT1A	2216270R2	1
DIS8264	Q7506	TR	IMT1A	2216270R2	1
DIS8264	Q7507	TR	IMT1A	2216270R2	1
DIS8264	Q7508	TR	RN1407	2216260R2	1
DIS8264	Q7508 or	TR	DTCH14YKA	2216470R2	(1)
DIS8264	Q7509	TR	RN1407	2216260R2	1
DIS8264	Q7509 or	TR	DTCH14YKA	2216470R2	(1)
DIS8264	Q7510	TR	RN1407	2216260R2	1
DIS8264	Q7510 or	TR	DTCH14YKA	2216470R2	(1)
DIS8264	Q7511	TR	IMT1A	2216270R2	1
DIS8264	Q7512	TR	RN1407	2216260R2	1
DIS8264	Q7512 or	TR	DTCH14YKA	2216470R2	(1)
DIS8264	Q7513	TR	IMT1A	2216270R2	1
DIS8264	Q7514	TR	RN1407	2216260R2	1
DIS8264	Q7514 or	TR	DTCH14YKA	2216470R2	(1)
DIS8264	Q7515	TR	IMT1A	2216270R2	1
DIS8264	Q7516	TR	RN1407	2216260R2	1
DIS8264	Q7516 or	TR	DTCH14YKA	2216470R2	(1)
DIS8264	Q7517	TR	IMT1A	2216270R2	1
DIS8264	Q7518	TR	RN1407	2216260R2	1
DIS8264	Q7518 or	TR	DTCH14YKA	2216470R2	(1)
DIS8264	Q7703	TR	RN1407	2216260R2	1

DIS8264	Q7703 or	TR	DTIC114YKA	2216470R2	(1)
DIS8264	R4229	C-CARBON R	RN72K1J-103JE	435031034R1	1
DIS8264	R4230	C-CARBON R	RN72K1J-103JE	435031034R1	1
DIS8264	R4231	C-CARBON R	RN72K1J-103JE	435031034R1	1
DIS8264	R4232	C-CARBON R	RN72K1J-103JE	435031034R1	1
DIS8264	R4233	C-CARBON R	RN72K1J-103JE	435031034R1	1
DIS8264	R4234	C-CARBON R	RN72K1J-103JE	435031034R1	1
DIS8264	R4235	C-CARBON R	RN72K1J-471JE	435034714R1	1
DIS8264	R4236	C-CARBON R	RN72K1J-471JE	435034714R1	1
DIS8264	R4241	C-CARBON R	RN72K1J-101JE	435031014R1	1
DIS8264	R4242	C-CARBON R	RN72K1J-101JE	435031014R1	1
DIS8264	R4243	C-CARBON R	RN72K1J-103JE	435031034R1	1
DIS8264	R4244	C-CARBON R	RN72K1J-223JE	435032234R1	1
DIS8264	R4245	METAL O R	RS1/2WBJ-2 2	443520224	1
DIS8264	R4246	METAL O R	RS1/2WBJ-2 2	443520224	1
DIS8264	R4247	C-CARBON R	RN72K1J-103JE	435031034R1	1
DIS8264	R4701	C-CARBON R	RN72K1J-102JE	435031024R1	1
DIS8264	R4702	C-CARBON R	RN72K1J-102JE	435031024R1	1
DIS8264	R4703	C-CARBON R	RN72K1J-102JE	435031024R1	1
DIS8264	R4704	C-CARBON R	RN72K1J-102JE	435031024R1	1
DIS8264	R4705	C-CARBON R	RN72K1J-473JE	435034734R1	1
DIS8264	R4706	C-CARBON R	RN72K1J-473JE	435034734R1	1
DIS8264	R4707	C-CARBON R	RN72K1J-222JE	435032224R1	1
DIS8264	R4708	C-CARBON R	RN72K1J-222JE	435032224R1	1
DIS8264	R4709	C-CARBON R	RN72K1J-101JE	435031014R1	1
DIS8264	R4710	C-CARBON R	RN72K1J-101JE	435031014R1	1
DIS8264	R4711	C-CARBON R	RN72K1J-222JE	435032224R1	1
DIS8264	R4712	C-CARBON R	RN72K1J-222JE	435032224R1	1
DIS8264	R4713	C-CARBON R	RN72K1J-221JE	435032214R1	1
DIS8264	R4714	C-CARBON R	RN72K1J-221JE	435032214R1	1
DIS8264	R4715	C-CARBON R	RN72K1J-105JE	435031054R1	1
DIS8264	R4716	C-CARBON R	RN72K1J-105JE	435031054R1	1
DIS8264	R4717	C-CARBON R	RN72K1J-684JE	435036844R1	1

DIS8264	R4718	C-CARBON R	RN72K1J-684JE	435036844R1	1
DIS8264	R4751	C-CARBON R	RN72K1J-102JE	435031024R1	1
DIS8264	R4752	C-CARBON R	RN72K1J-102JE	435031024R1	1
DIS8264	R4753	C-CARBON R	RN72K1J-102JE	435031024R1	1
DIS8264	R4754	C-CARBON R	RN72K1J-102JE	435031024R1	1
DIS8264	R4755	C-CARBON R	RN72K1J-473JE	435034734R1	1
DIS8264	R4756	C-CARBON R	RN72K1J-473JE	435034734R1	1
DIS8264	R4757	C-CARBON R	RN72K1J-222JE	435032224R1	1
DIS8264	R4758	C-CARBON R	RN72K1J-222JE	435032224R1	1
DIS8264	R4759	C-CARBON R	RN72K1J-221JE	435032214R1	1
DIS8264	R4760	C-CARBON R	RN72K1J-221JE	435032214R1	1
DIS8264	R4761	C-CARBON R	RN72K1J-103JE	435031034R1	1
DIS8264	R4762	C-CARBON R	RN72K1J-103JE	435031034R1	1
DIS8264	R4763	C-CARBON R	RN72K1J-221JE	435032214R1	1
DIS8264	R4764	C-CARBON R	RN72K1J-221JE	435032214R1	1
DIS8264	R4765	C-CARBON R	RN72K1J-103JE	435031034R1	1
DIS8264	R4766	C-CARBON R	RN72K1J-103JE	435031034R1	1
DIS8264	R4767	C-CARBON R	RN72K1J-272JE	435032724R1	1
DIS8264	R4768	C-CARBON R	RN72K1J-272JE	435032724R1	1
DIS8264	R4769	C-CARBON R	RN72K1J-105JE	435031054R1	1
DIS8264	R4770	C-CARBON R	RN72K1J-105JE	435031054R1	1
DIS8264	R4771	C-CARBON R	RN72K1J-684JE	435036844R1	1
DIS8264	R4772	C-CARBON R	RN72K1J-684JE	435036844R1	1
DIS8264	R4773	C-CARBON R	RN72K1J-105JE	435031054R1	1
DIS8264	R4774	C-CARBON R	RN72K1J-684JE	435036844R1	1
DIS8264	R4775	C-CARBON R	RN72K1J-182JE	435031824R1	1
DIS8264	R4776	C-CARBON R	RN72K1J-182JE	435031824R1	1
DIS8264	R4777	C-CARBON R	RN72K1J-272JE	435032724R1	1
DIS8264	R4778	C-CARBON R	RN72K1J-473JE	435034734R1	1
DIS8264	R4801	C-CARBON R	RN72K1J-102JE	435031024R1	1
DIS8264	R4802	C-CARBON R	RN72K1J-102JE	435031024R1	1
DIS8264	R4803	C-CARBON R	RN72K1J-102JE	435031024R1	1
DIS8264	R4804	C-CARBON R	RN72K1J-102JE	435031024R1	1

DIS8264	R4805	G-CARBON R	RN72K1J-473JE	435034734R1	1
DIS8264	R4806	G-CARBON R	RN72K1J-473JE	435034734R1	1
DIS8264	R4807	G-CARBON R	RN72K1J-222JE	435032224R1	1
DIS8264	R4808	G-CARBON R	RN72K1J-222JE	435032224R1	1
DIS8264	R4809	G-CARBON R	RN72K1J-101JE	435031014R1	1
DIS8264	R4810	G-CARBON R	RN72K1J-101JE	435031014R1	1
DIS8264	R4811	G-CARBON R	RN72K1J-222JE	435032224R1	1
DIS8264	R4812	G-CARBON R	RN72K1J-222JE	435032224R1	1
DIS8264	R4813	G-CARBON R	RN72K1J-221JE	435032214R1	1
DIS8264	R4814	G-CARBON R	RN72K1J-221JE	435032214R1	1
DIS8264	R4815	G-CARBON R	RN72K1J-105JE	435031054R1	1
DIS8264	R4816	G-CARBON R	RN72K1J-105JE	435031054R1	1
DIS8264	R4817	G-CARBON R	RN72K1J-684JE	435036844R1	1
DIS8264	R4818	G-CARBON R	RN72K1J-684JE	435036844R1	1
DIS8264	R4851	G-CARBON R	RN72K1J-102JE	435031024R1	1
DIS8264	R4852	G-CARBON R	RN72K1J-102JE	435031024R1	1
DIS8264	R4853	G-CARBON R	RN72K1J-102JE	435031024R1	1
DIS8264	R4854	G-CARBON R	RN72K1J-102JE	435031024R1	1
DIS8264	R4855	G-CARBON R	RN72K1J-473JE	435034734R1	1
DIS8264	R4856	G-CARBON R	RN72K1J-473JE	435034734R1	1
DIS8264	R4857	G-CARBON R	RN72K1J-222JE	435032224R1	1
DIS8264	R4858	G-CARBON R	RN72K1J-222JE	435032224R1	1
DIS8264	R4859	G-CARBON R	RN72K1J-101JE	435031014R1	1
DIS8264	R4860	G-CARBON R	RN72K1J-101JE	435031014R1	1
DIS8264	R4861	G-CARBON R	RN72K1J-222JE	435032224R1	1
DIS8264	R4862	G-CARBON R	RN72K1J-222JE	435032224R1	1
DIS8264	R4863	G-CARBON R	RN72K1J-221JE	435032214R1	1
DIS8264	R4864	G-CARBON R	RN72K1J-221JE	435032214R1	1
DIS8264	R4865	G-CARBON R	RN72K1J-105JE	435031054R1	1
DIS8264	R4866	G-CARBON R	RN72K1J-105JE	435031054R1	1
DIS8264	R4867	G-CARBON R	RN72K1J-684JE	435036844R1	1
DIS8264	R4868	G-CARBON R	RN72K1J-684JE	435036844R1	1
DIS8264	R4869	G-CARBON R	RN72K1J-103JE	435031034R1	1

DIS8264	R4870	C-CARBON R	RN72K1J-103JE	435031034R1	1
DIS8264	R4871	C-CARBON R	RN72K1J-272JE	435032724R1	1
DIS8264	R4872	C-CARBON R	RN72K1J-272JE	435032724R1	1
DIS8264	R4901	C-CARBON R	RN72K1J-102JE	435031024R1	1
DIS8264	R4902	C-CARBON R	RN72K1J-102JE	435031024R1	1
DIS8264	R4903	C-CARBON R	RN72K1J-102JE	435031024R1	1
DIS8264	R4904	C-CARBON R	RN72K1J-102JE	435031024R1	1
DIS8264	R4905	C-CARBON R	RN72K1J-473JE	435034734R1	1
DIS8264	R4906	C-CARBON R	RN72K1J-473JE	435034734R1	1
DIS8264	R4907	C-CARBON R	RN72K1J-222JE	435032224R1	1
DIS8264	R4908	C-CARBON R	RN72K1J-222JE	435032224R1	1
DIS8264	R4909	C-CARBON R	RN72K1J-101JE	435031014R1	1
DIS8264	R4910	C-CARBON R	RN72K1J-101JE	435031014R1	1
DIS8264	R4911	C-CARBON R	RN72K1J-222JE	435032224R1	1
DIS8264	R4912	C-CARBON R	RN72K1J-222JE	435032224R1	1
DIS8264	R4913	C-CARBON R	RN72K1J-221JE	435032214R1	1
DIS8264	R4914	C-CARBON R	RN72K1J-221JE	435032214R1	1
DIS8264	R4915	C-CARBON R	RN72K1J-105JE	435031054R1	1
DIS8264	R4916	C-CARBON R	RN72K1J-105JE	435031054R1	1
DIS8264	R4917	C-CARBON R	RN72K1J-684JE	435036844R1	1
DIS8264	R4918	C-CARBON R	RN72K1J-684JE	435036844R1	1
DIS8264	R4921	C-CARBON R	RN72K1J-103JE	435031034R1	1
DIS8264	R4922	C-CARBON R	RN72K1J-103JE	435031034R1	1
DIS8264	R4923	C-CARBON R	RN72K1J-105JE	435031054R1	1
DIS8264	R4924	C-CARBON R	RN72K1J-684JE	435036844R1	1
DIS8264	R4951	C-CARBON R	RN72K1J-000JE	435030004R1	1
DIS8264	R4954	C-CARBON R	RN72K1J-000JE	435030004R1	1
DIS8264	R4955	C-CARBON R	RN72K1J-104JE	435031044R1	1
DIS8264	R4956	C-CARBON R	RN72K1J-154JE	435031544R1	1
DIS8264	R4957	C-CARBON R	RN72K1J-104JE	435031044R1	1
DIS8264	R4958	C-CARBON R	RN72K1J-154JE	435031544R1	1
DIS8264	R4959	C-CARBON R	RN72K1J-223JE	435032234R1	1
DIS8264	R4960	C-CARBON R	RN72K1J-223JE	435032234R1	1

DIS8264	R4961	C-CARBON R	RN72K1J-332JE	435033324R1	1
DIS8264	R4962	C-CARBON R	RN72K1J-471JE	435034714R1	1
DIS8264	R4963	C-CARBON R	RN72K1J-103JE	435031034R1	1
DIS8264	R4964	C-CARBON R	RN72K1J-103JE	435031034R1	1
DIS8264	R4967	C-CARBON R	RN72K1J-331JE	435033314R1	1
DIS8264	R4968	C-CARBON R	RN72K1J-331JE	435033314R1	1
DIS8264	R4969	C-CARBON R	RN72K1J-101JE	435031014R1	1
DIS8264	R4970	C-CARBON R	RN72K1J-181JE	435031814R1	1
DIS8264	R4971	C-CARBON R	RN72K1J-181JE	435031814R1	1
DIS8264	R4972	C-CARBON R	RN72K1J-181JE	435031814R1	1
DIS8264	R4973	C-CARBON R	RN72K1J-181JE	435031814R1	1
DIS8264	R4974	C-CARBON R	RN72K1J-101JE	435031014R1	1
DIS8264	R4975	C-CARBON R	RN72K1J-101JE	435031014R1	1
DIS8264	R4976	C-CARBON R	RN72K1J-105JE	435031054R1	1
DIS8264	R4977	C-CARBON R	RN72K1J-684JE	435036844R1	1
DIS8264	R4978	C-CARBON R	RN72K1J-103JE	435031034R1	1
DIS8264	R4979	C-CARBON R	RN72K1J-103JE	435031034R1	1
DIS8264	R4980	C-CARBON R	RN72K1J-103JE	435031034R1	1
DIS8264	R4981	C-CARBON R	RN72K1J-103JE	435031034R1	1
DIS8264	R4982	C-CARBON R	RN72K1J-105JE	435031054R1	1
DIS8264	R4983	C-CARBON R	RN72K1J-684JE	435036844R1	1
DIS8264	R6781	C-CARBON R	RN72K1J-472JE	435034724R1	1
DIS8264	R6782	C-CARBON R	RN72K1J-104JE	435031044R1	1
DIS8264	R6783	C-CARBON R	RN72K1J-104JE	435031044R1	1
DIS8264	R6784	C-CARBON R	RN72K1J-472JE	435034724R1	1
DIS8264	R6785	C-CARBON R	RN72K1J-102JE	435031024R1	1
DIS8264	R6786	C-CARBON R	RN72K1J-471JE	435034714R1	1
DIS8264	R6788	C-CARBON R	RN72K1J-471JE	435034714R1	1
DIS8264	R6790	C-CARBON R	RN72K1J-471JE	435034714R1	1
DIS8264	R6792	C-CARBON R	RN72K1J-471JE	435034714R1	1
DIS8264	R6794	C-CARBON R	RN72K1J-471JE	435034714R1	1
DIS8264	R6796	C-CARBON R	RN72K1J-471JE	435034714R1	1
DIS8264	R7501	C-CARBON R	RN72K1J-391JE	435033914R1	1

DIS8264	R7502	G-CARBON R	RN72K1J-471JE	435034714R1	1
DIS8264	R7503	G-CARBON R	RN72K1J-821JE	435038214R1	1
DIS8264	R7504	G-CARBON R	RN72K1J-102JE	435031024R1	1
DIS8264	R7505	G-CARBON R	RN72K1J-182JE	435031824R1	1
DIS8264	R7506	G-CARBON R	RN72K1J-391JE	435033914R1	1
DIS8264	R7507	G-CARBON R	RN72K1J-560JE	435035604R1	1
DIS8264	R7508	G-CARBON R	RN72K1J-122JE	435031224R1	1
DIS8264	R7509	G-CARBON R	RN72K1J-000JE	435030004R1	1
DIS8264	R7510	G-CARBON R	RN72K1J-103JE	435031034R1	1
DIS8264	R7511	G-CARBON R	RN72K1J-391JE	435033914R1	1
DIS8264	R7512	G-CARBON R	RN72K1J-560JE	435035604R1	1
DIS8264	R7513	G-CARBON R	RN72K1J-122JE	435031224R1	1
DIS8264	R7514	G-CARBON R	RN72K1J-000JE	435030004R1	1
DIS8264	R7515	G-CARBON R	RN72K1J-103JE	435031034R1	1
DIS8264	R7516	G-CARBON R	RN72K1J-391JE	435033914R1	1
DIS8264	R7517	G-CARBON R	RN72K1J-122JE	435031224R1	1
DIS8264	R7518	G-CARBON R	RN72K1J-560JE	435035604R1	1
DIS8264	R7519	G-CARBON R	RN72K1J-000JE	435030004R1	1
DIS8264	R7520	G-CARBON R	RN72K1J-103JE	435031034R1	1
DIS8264	R7521	G-CARBON R	RN72K1J-272JE	435032724R1	1
DIS8264	R7522	G-CARBON R	RN72K1J-272JE	435032724R1	1
DIS8264	R7523	G-CARBON R	RN72K1J-272JE	435032724R1	1
DIS8264	R7524	G-CARBON R	RN72K1J-272JE	435032724R1	1
DIS8264	R7525	G-CARBON R	RN72K1J-472JE	435034724R1	1
DIS8264	R7526	G-CARBON R	RN72K1J-472JE	435034724R1	1
DIS8264	R7527	G-CARBON R	RN72K1J-472JE	435034724R1	1
DIS8264	R7528	G-CARBON R	RN72K1J-153JE	435031534R1	1
DIS8264	R7529	G-CARBON R	RN72K1J-471JE	435034714R1	1
DIS8264	R7530	G-CARBON R	RN72K1J-471JE	435034714R1	1
DIS8264	R7531	G-CARBON R	RN72K1J-223JE	435032234R1	1
DIS8264	R7532	G-CARBON R	RN72K1J-103JE	435031034R1	1
DIS8264	R7533	G-CARBON R	RN72K1J-220JE	435032204R1	1
DIS8264	R7534	G-CARBON R	RN72K1J-220JE	435032204R1	1

DIS8264	R7535	G-CARBON R	RN72K1J-220JE	435032204R1	1
DIS8264	R7536	G-CARBON R	RN72K1J-220JE	435032204R1	1
DIS8264	R7537	G-CARBON R	RN72K1J-220JE	435032204R1	1
DIS8264	R7538	G-CARBON R	RN72K1J-000JE	435030004R1	1
DIS8264	R7540	G-CARBON R	RN72K1J-391JE	435033914R1	1
DIS8264	R7541	G-CARBON R	RN72K1J-560JE	435035604R1	1
DIS8264	R7542	G-CARBON R	RN72K1J-122JE	435031224R1	1
DIS8264	R7544	G-CARBON R	RN72K1J-103JE	435031034R1	1
DIS8264	R7545	G-CARBON R	RN72K1J-391JE	435033914R1	1
DIS8264	R7546	G-CARBON R	RN72K1J-471JE	435034714R1	1
DIS8264	R7547	G-CARBON R	RN72K1J-391JE	435033914R1	1
DIS8264	R7548	G-CARBON R	RN72K1J-560JE	435035604R1	1
DIS8264	R7549	G-CARBON R	RN72K1J-122JE	435031224R1	1
DIS8264	R7551	G-CARBON R	RN72K1J-103JE	435031034R1	1
DIS8264	R7553	G-CARBON R	RN72K1J-103JE	435031034R1	1
DIS8264	R7554	G-CARBON R	RN72K1J-000JE	435030004R1	1
DIS8264	R7555	G-CARBON R	RN72K1J-391JE	435033914R1	1
DIS8264	R7556	G-CARBON R	RN72K1J-560JE	435035604R1	1
DIS8264	R7557	G-CARBON R	RN72K1J-122JE	435031224R1	1
DIS8264	R7558	G-CARBON R	RN72K1J-000JE	435030004R1	1
DIS8264	R7565	G-CARBON R	RN72K1J-104JE	435031044R1	1
DIS8264	R7566	G-CARBON R	RN72K1J-104JE	435031044R1	1
DIS8264	R7567	G-CARBON R	RN72K1J-104JE	435031044R1	1
DIS8264	R7568	G-CARBON R	RN72K1J-104JE	435031044R1	1
DIS8264	R7705	G-CARBON R	RN72K1J-561JE	435035614R1	1
DIS8264	S7501	PUSH SW	NPS-111-S681	25035718	1
DIS8264	S7502	PUSH SW	NPS-111-S681	25035718	1
DIS8264	S7503	PUSH SW	NPS-111-S681	25035718	1
DIS8264	S7504	PUSH SW	NPS-111-S681	25035718	1
DIS8264	S7505	PUSH SW	NPS-111-S681	25035718	1
DIS8264	S7506	PUSH SW	NPS-111-S681	25035718	1
DIS8264	S7701	PUSH SW	NPS-111-S681	25035718	1
DIS8264	S7703	PUSH SW	NPS-111-S681	25035718	1

D1S8264	S7705	PUSH SW	NPS-111-S681	25035718	1
D1S8264	U7501	REMO SENS	PIC-37043TH2	241336	1
D1S8264	X7501	CERA LOCK	CST5.00MGW	3010242	1

PCB NO.	CIRCUIT	PART NAME	DESCRIPTION	PART NO.	REMARKS
PSS8269	D9101	C-DIODE	ISS352	223234R2	1
PSS8269	D9102	DIODE	RBV602	22380038F	1
PSS8269	D9103	C-DIODE	ISS352	223234R2	1
PSS8269	D9104	C-DIODE	ISR154-400	22380284R2	1
PSS8269	D9105	C-DIODE	ISR154-400	22380284R2	1
PSS8269	D9106	C-DIODE	ISR154-400	22380284R2	1
PSS8269	D9107	C-DIODE	ISR154-400	22380284R2	1
PSS8269	D9108	C-DIODE	ISR154-400	22380284R2	1
PSS8269	D9109	C-DIODE	ISR154-400	22380284R2	1
PSS8269	D9110	C-DIODE	ISR154-400	22380284R2	1
PSS8269	D9111	C-DIODE	ISR154-400	22380284R2	1
PSS8269	D9112	C-DIODE	ISR154-400	22380284R2	1
PSS8269	D9113	C-DIODE	ISR154-400	22380284R2	1
PSS8269	D9114	C-DIODE	ISR154-400	22380284R2	1
PSS8269	D9115	C-DIODE	ISR154-400	22380284R2	1
PSS8269	D9116	C-DIODE	ISR154-400	22380284R2	1
PSS8269	D9121	C-DIODE	ISS352	223234R2	1
PSS8269	D9122	C-DIODE	ISS352	223234R2	1
PSS8269	D9123	DIODE	RK16	22380320	1
PSS8269	D9124	DIODE	RK16	22380320	1
PSS8269	D9125	DIODE	RK46	22380296F	1
PSS8269	D9126	DIODE	RK46	22380296F	1
PSS8269	D9601	C-DIODE	RB051L-40	223265R2	1
PSS8269	D9602	C-DIODE	RB051L-40	223265R2	1
PSS8269	D9603	C-DIODE	RB051L-40	223265R2	1
PSS8269	D9604	C-DIODE	RB051L-40	223265R2	1
PSS8269	D9605	ZENER D	UDZS5.1B	22450510R2	1
PSS8269	D9606	C-DIODE	ISS352	223234R2	1

PS8269	Q9101	IC(REGULATOR)	MPC29M05HF	22278005ENE	1
PS8269	Q9102	IC	SI-8015JF	22242082	N 1
PS8269	Q9103	IC	SI-8050JF	22242083	N 1
PS8269	Q9104	IC	SI-8033S	22242084	N 1
PS8269	Q9601	TR	RN1407	2216260R2	1
PS8269	Q9602	TR	RN2403	2214540R2	1
PS8269	Q9603	TR	RN1407	2216260R2	1
PS8269	Q9604	TR	2SC2120-Y	2211164	1
PS8269	L9001	CHOKE COIL	NCH-3561	231280	1
PS8269	L9101	CHOKE COIL	NCH-3582K101	231303K101	1
PS8269	L9102	CHOKE COIL	NCH-3582K101	231303K101	1
PS8269	L9103	CHOKE COIL	NCH-3582K101	231303K101	1
PS8269	C9001	IS C	DE1310E472M-KH	3300054	1
PS8269	C9002	IS C	DE1310E472M-KH	3300054	1
PS8269	C9101	TF C	EOQ-V50V-334J	374723344	1
PS8269	C9102	TF C	EOQ-V50V-334J	374723344	1
PS8269	C9103	TF C	EOQ-V50V-334J	374723344	1
PS8269	C9104	TF C	EOQ-V50V-334J	374723344	1
PS8269	C9105	TF C	EOQ-V50V-334J	374723344	1
PS8269	C9106	TF C	EOQ-V50V-334J	374723344	1
PS8269	C9107	TF C	EOQ-V50V-334J	374723344	1
PS8269	C9108	ELECT C	CE69W35V-3300M	3504317	1
PS8269	C9109	VX C	CE04W16V-2200M(VX)	393342227S	1
PS8269	C9110	VX C	CE04W16V-2200M(VX)	393342227S	1
PS8269	C9111	ELECT C	CE69W25V-2200M	3504369	1
PS8269	C9112	ELECT C	CE69W25V-2200M	3504369	1
PS8269	C9113	ELECT C	CE69W25V-2200M	3504369	1
PS8269	C9114	VX C	CE04W50V-4.7M(VX)	393380477	1
PS8269	C9115	VX C	CE04W6.3V-47M(VX)	393324707	1
PS8269	C9116	C-CERA C	CK725FIH-104Z1	332151040R1	1
PS8269	C9117	VX C	CE04W35V-47M(VX)	393364707	1
PS8269	C9118	VX C	CE04W35V-47M(VX)	393364707	1
PS8269	C9119	C-CERA C	CK725FIH-104Z1	332151040R1	1

PS8269	C9120	C-CERA C	CK725FIH-104Z1	332151040R1	1
PS8269	C9121	C-CERA C	CK725FIH-104Z1	332151040R1	1
PS8269	C9122	VX C	CE04W6.3V-470M(VX)	393324717	1
PS8269	C9123	VX C	CE04W6.3V-470M(VX)	393324717	1
PS8269	C9124	C-CERA C	CK725FIH-104Z1	332151040R1	1
PS8269	C9125	C-CERA C	CK725FIH-104Z1	332151040R1	1
PS8269	C9126	C-CERA C	CK725FIH-104Z1	332151040R1	1
PS8269	C9127	VX C	CE04W6.3V-470M(VX)	393324717	1
PS8269	C9128	C-CERA C	CK725FIH-104Z1	332151040R1	1
PS8269	C9129	VX C	CE04W35V-47M(VX)	393364707	1
PS8269	C9601	VX C	CE04W16V-470M(VX)	393344717	1
PS8269	C9602	C-CERA C	CK725FIH-104Z1	332151040R1	1
PS8269	C9603	VX C	CE04W16V-470M(VX)	393344717	1
PS8269	R9101	METAL R	RNU/2WCJ-0.22	453532294	1
PS8269	R9102	METAL R	RNU/2WCJ-0.22	453532294	1
PS8269	R9103	METAL R	RNU/2WCJ-0.22	453532294	1
PS8269	R9104	METAL R	RNU/2WCJ-1	453530104	1
PS8269	R9105	METAL R	RNU/2WCJ-0.22	453532294	1
PS8269	R9106	METAL R	RNU/2WCJ-0.22	453532294	1
PS8269	R9107	METAL R	RNU/2WCJ-0.22	453532294	1
PS8269	R9108	C-CARBON R	RN72K1J-103JE	435031034R1	1
PS8269	R9109	METAL R	RNU/2WCJ-0.22	453532294	1
PS8269	R9110	METAL R	RNU/2WCJ-0.22	453532294	1
PS8269	R9111	METAL R	RNU/2WCJ-0.22	453532294	1
PS8269	R9112	METAL R	RNU/2WCJ-0.22	453532294	1
PS8269	R9113	METAL R	RNU/2WCJ-0.22	453532294	1
PS8269	R9114	METAL R	RNU/2WCJ-1	453530104	1
PS8269	R9115	C-CARBON R	RN72K1J-223JE	435032234R1	1
PS8269	R9116	C-CARBON R	RN72K1J-182JE	435031824R1	1
PS8269	R9117	C-CARBON R	RN72K1J-681JE	435036814R1	1
PS8269	R9120	C-CARBON R	RN72K1J-000JE	435030004R1	1
PS8269	R9121	C-CARBON R	RN72K1J-000JE	435030004R1	1
PS8269	R9601	C-CARBON R	RN72K1J-101JE	435031014R1	1

PSS8269	R9602	C-CARBON R	RN72K1J-102JE	435031024R1	1
PSS8269	R9603	C-CARBON R	RN72K1J-472JE	435034724R1	1
PSS8269	R9604	METAL O R	RS1/2WBJ-100	443521014	1
PSS8269	R9605	METAL O R	RS1/2WBJ-100	443521014	1
PSS8269	R9606	C-CARBON R	RN72K1J-151JE	435031514R1	1
PSS8269	R9607	C-CARBON R	RN72K1J-332JE	435033324R1	1
PSS8269	R9608	C-CARBON R	RN72K1J-000JE	435030004R1	1
PSS8269	E9001	CLAMP	WS-2NS	27300833	1
PSS8269	E9601	TRM	NTM-1P243(M1699)	25060312	1
PSS8269	E9602	TRM	NTM-1P243(M1699)	25060312	1
PSS8269	E9603	TRM	NTM-1P243(M1699)	25060312	1
PSS8269	E9604	TRM	NTM-1P243(M1699)	25060312	1
PSS8269	F9001A	FUSE HOL	NSCT-1P2031	25052133	1
PSS8269	F9001B	FUSE HOL	NSCT-1P2031	25052133	1
PSS8269	P9005A	PLUG	NPLG-2P632	25055676	1
PSS8269	P9007A	PLUG	NPLG-3P150	25055166	1
PSS8269	P9008A	PLUG	NPLG-7P154	25055170	1
PSS8269	P9102A	PLUG	NPLG-8P136	25055152	1
PSS8269	P9103A	PLUG	NPLG-4P132	25055148	1
PSS8269	P9104A	PLUG	NPLG-11P139	25055155	1
PSS8269	P9104B	PLUG	NPLG-11P358	25055375	1
PSS8269	P9105	CRIMP AS	CRIMP AS	2069943106UL	1
PSS8269	P9503	SOCKET AS	NSAS-4P0994	2009990712AUL	1
PSS8269	P9601A	PLUG	NPLG-12P140	25055156	1
PSS8269	P9602A	PLUG	NPLG-14P142	25055158	1
PSS8269	P9604A	PLUG	NPLG-15P143	25055159	1
PSS8269	Q9102A	RADIATOR	RAD51(B)	27160220-1	1
PSS8269	Q9102B	SCREW	3P+6FN(BC)	82143006	1
PSS8269	Q9103A	RADIATOR	RAD51(B)	27160220-1	1
PSS8269	Q9103B	SCREW	3P+6FN(BC)	82143006	1
PSS8269	Q9104A	RADIATOR	RAD51(B)	27160220-1	1
PSS8269	Q9104B	SCREW	3P+6FN(BC)	82143006	1
PSS8269	P9001A	AC INLET	NPLG-2P913	25055960	1

<DDIN>

PS8269	E9801	LABEL	T2.5A1250V	29361747	<DDIN>	1
PS8269	P9001A	AC INLET	NPLG-2P913	25055960	<PA4P>	1
PS8269	E9801	FUSE LABEL	2.5A125V	29363738	N, <PA4P>	1

PCB NO.	CIRCUIT	PART NAME	DESCRIPTION	PART NO.	REMARKS
DG8272	C5001	G-CERA C	CK725F1A-473K1	332114735R1	1
DG8272	C5002	G-CERA C	CK725B1E-473K1	332114735R1	1
DG8272	C5003	G-CERA C	CK725B1E-473K1	332114735R1	1
DG8272	C5004	G-CERA C	CK725B1E-473K1	332114735R1	1
DG8272	C5005	CHIP ELECT C	CEWX6.3V-100M	356721019R2	1
DG8272	C5006	G-CERA C	CK725F1A-105Z1	332181050R1	1
DG8272	C5007	G-CERA C	CK725F1A-105Z1	332181050R1	1
DG8272	C5008	G-CERA C	CK725F1A-105Z1	332181050R1	1
DG8272	C5009	G-CERA C	CK725F1A-105Z1	332181050R1	1
DG8272	C5010	G-CERA C	CK725F1A-105Z1	332181050R1	1
DG8272	C5011	G-CERA C	CK725F1A-105Z1	332181050R1	1
DG8272	C5012	G-CERA C	CK725F1A-105Z1	332181050R1	1
DG8272	C5013	G-CERA C	CK725F1A-105Z1	332181050R1	1
DG8272	C5015	G-CERA C	CK725F1A-105Z1	332181050R1	1
DG8272	C5016	G-CERA C	CK725F1A-105Z1	332181050R1	1
DG8272	C5017	G-CERA C	CK725F1A-105Z1	332181050R1	1
DG8272	C5018	G-CERA C	CK725F1A-105Z1	332181050R1	1
DG8272	C5019	G-CERA C	CK725F1A-105Z1	332181050R1	1
DG8272	C5020	G-CERA C	CK725F1A-105Z1	332181050R1	1
DG8272	C5021	G-CERA C	CK725F1A-105Z1	332181050R1	1
DG8272	C5022	G-CERA C	CK725F1A-105Z1	332181050R1	1
DG8272	C5023	G-CERA C	CK725F1A-105Z1	332181050R1	1
DG8272	C5024	G-CERA C	CK725F1A-105Z1	332181050R1	1
DG8272	C5025	G-CERA C	CK725F1A-105Z1	332181050R1	1
DG8272	C5026	G-CERA C	CK725F1A-105Z1	332181050R1	1
DG8272	C5027	G-CERA C	CK725F1A-105Z1	332181050R1	1
DG8272	C5028	G-CERA C	CC725CH1H-180J1	342101804R1	1
DG8272	C5029	G-CERA C	CC725CH1H-150J1	342101504R1	1

DG8272	C5030	G-CERA C	CK725F1A-105Z1	332181050R1	1
DG8272	C5031	G-CERA C	CK725F1A-105Z1	332181050R1	1
DG8272	C5033	CHIP ELECT C	CEWX6.3V-100M	356721019R2	1
DG8272	C5034	CHIP ELECT C	CEWX6.3V-100M	356721019R2	1
DG8272	C5035	G-CERA C	CK725F1A-105Z1	332181050R1	1
DG8272	C5037	CHIP ELECT C	CEWX6.3V-100M	356721019R2	1
DG8272	C5038	G-CERA C	CK725F1A-105Z1	332181050R1	1
DG8272	C5039	G-CERA C	CK725F1A-105Z1	332181050R1	1
DG8272	C5040	G-CERA C	CK725F1A-105Z1	332181050R1	1
DG8272	C5041	G-CERA C	CK725F1A-105Z1	332181050R1	1
DG8272	C5042	G-CERA C	CK725F1A-105Z1	332181050R1	1
DG8272	C5043	G-CERA C	CC725CH1H-102J1	342101024R1	1
DG8272	C5044	CHIP ELECT C	CEWX6.3V-100M	356721019R2	1
DG8272	C5045	CHIP ELECT C	CEWX6.3V-100M	356721019R2	1
DG8272	C5046	CHIP ELECT C	CEWX6.3V-100M	356721019R2	1
DG8272	C5101	G-CERA C	CK725F1H-473Z1	332154730R1	1
DG8272	C5201	G-CERA C	CK725F1H-473Z1	332154730R1	1
DG8272	C5251	G-CERA C	CK725F1H-473Z1	332154730R1	1
DG8272	C5503	G-CERA C	CK725B1E-473K1	332114735R1	1
DG8272	C5504	G-CERA C	CK725B1E-473K1	332114735R1	1
DG8272	C5603	G-CERA C	CK725B1E-473K1	332114735R1	1
DG8272	C5703	G-CERA C	CK725B1E-473K1	332114735R1	1
DG8272	C8001	G-CERA C	CK725F1A-105Z1	332181050R1	1
DG8272	C8002	G-CERA C	CK725F1A-105Z1	332181050R1	1
DG8272	C8003	G-CERA C	CK725F1A-105Z1	332181050R1	1
DG8272	C8004	G-CERA C	CK725F1A-105Z1	332181050R1	1
DG8272	C8006	G-CERA C	CK725F1A-105Z1	332181050R1	1
DG8272	C8010	G-CERA C	CK725F1A-105Z1	332181050R1	1
DG8272	C8011	G-CERA C	CK725F1A-105Z1	332181050R1	1
DG8272	C8012	G-CERA C	CK725F1A-105Z1	332181050R1	1
DG8272	C8013	G-CERA C	CK725F1A-105Z1	332181050R1	1
DG8272	C8014	G-CERA C	CK725F1A-105Z1	332181050R1	1
DG8272	C8019	G-CERA C	CK725F1A-105Z1	332181050R1	1

DG8272	C8020	G-CERA C	CK725F1A-105Z1	332181050R1	1
DG8272	C8021	G-CERA C	CK725F1A-105Z1	332181050R1	1
DG8272	C8022	G-CERA C	CK725F1A-105Z1	332181050R1	1
DG8272	C8023	G-CERA C	CK725F1A-105Z1	332181050R1	1
DG8272	C8024	G-CERA C	CK725F1A-105Z1	332181050R1	1
DG8272	C8025	G-CERA C	CK725F1A-105Z1	332181050R1	1
DG8272	C8026	G-CERA C	CK725F1A-105Z1	332181050R1	1
DG8272	C8027	G-CERA C	CK725F1A-105Z1	332181050R1	1
DG8272	C8028	G-CERA C	CK725F1A-105Z1	332181050R1	1
DG8272	C8029	G-CERA C	CK725F1A-105Z1	332181050R1	1
DG8272	C8030	G-CERA C	CC725CH1E-102J1	342111024R1	1
DG8272	C8031	G-CERA C	CK725F1A-105Z1	332181050R1	1
DG8272	C8032	CHIP ELECT C	CEWX16V-22M	356742209R2	1
DG8272	C8033	G-CERA C	CK725F1A-105Z1	332181050R1	1
DG8272	C8034	G-CERA C	CC725CH1H-101J1	342101014R1	1
DG8272	C8035	G-CERA C	CC725CH1E-102J1	342111024R1	1
DG8272	C8036	G-CERA C	CC725CH1H-050C1	342100501R1	1
DG8272	C8038	G-CERA C	CC725CH1H-050C1	342100501R1	1
DG8272	C8040	G-CERA C	CK725F1A-105Z1	332181050R1	1
DG8272	C8041	CHIP ELECT C	CEWX4V-220M	3567A2219R2	1
DG8272	C8042	CHIP ELECT C	CEWX4V-220M	3567A2219R2	1
DG8272	C8043	CHIP ELECT C	CEWX16V-10M	356741009R2	1
DG8272	C8044	CHIP ELECT C	CEWX4V-220M	3567A2219R2	1
DG8272	C8045	G-CERA C	CK725F1A-105Z1	332181050R1	1
DG8272	C8047	G-CERA C	CK725F1A-105Z1	332181050R1	1
DG8272	C8048	G-CERA C	CK725F1A-105Z1	332181050R1	1
DG8272	C8049	G-CERA C	CK725F1A-105Z1	332181050R1	1
DG8272	C8050	G-CERA C	CK725F1A-105Z1	332181050R1	1
DG8272	C8052	G-CERA C	CK725F1A-105Z1	332181050R1	1
DG8272	C8053	G-CERA C	CK725F1A-105Z1	332181050R1	1
DG8272	C8054	G-CERA C	CK725F1A-105Z1	332181050R1	1
DG8272	C8055	G-CERA C	CK725F1A-105Z1	332181050R1	1
DG8272	C8056	G-CERA C	CK725F1A-105Z1	332181050R1	1

DG8272	C8057	CHIP ELECT C	CEWX16V-22M	356742209R2	1
DG8272	C8058	G-CERA C	CK725F1A-105Z1	332181050R1	1
DG8272	C8059	G-CERA C	CC725CH1H-100D1	342101002R1	1
DG8272	C8060	G-CERA C	CC725CH1H-100D1	342101002R1	1
DG8272	C8061	G-CERA C	CK725F1A-105Z1	332181050R1	1
DG8272	C8062	G-CERA C	CK725F1A-105Z1	332181050R1	1
DG8272	C8063	G-CERA C	CK725F1A-105Z1	332181050R1	1
DG8272	C8064	G-CERA C	CK725F1A-105Z1	332181050R1	1
DG8272	C8067	CHIP ELECT C	CEWX16V-22M	356742209R2	1
DG8272	C8068	G-CERA C	CK725F1A-105Z1	332181050R1	1
DG8272	C8069	G-CERA C	CK725F1A-105Z1	332181050R1	1
DG8272	C8070	G-CERA C	CK725F1A-105Z1	332181050R1	1
DG8272	C8071	G-CERA C	CK725F1A-105Z1	332181050R1	1
DG8272	C8072	G-CERA C	CK725F1A-105Z1	332181050R1	1
DG8272	C8073	G-CERA C	CK725F1A-105Z1	332181050R1	1
DG8272	C8074	G-CERA C	CK725F1A-105Z1	332181050R1	1
DG8272	C8075	G-CERA C	CK725F1A-105Z1	332181050R1	1
DG8272	C8076	G-CERA C	CK725F1A-105Z1	332181050R1	1
DG8272	C8078	CHIP ELECT C	CEWX16V-22M	356742209R2	1
DG8272	C8079	CHIP ELECT C	CEWX16V-10M	356741009R2	1
DG8272	C8080	G-CERA C	CK725F1A-105Z1	332181050R1	1
DG8272	C8101	G-CERA C	CK725F1A-105Z1	332181050R1	1
DG8272	C8102	CHIP ELECT C	CEWX4V-220M	3567A2219R2	1
DG8272	C8103	G-CERA C	CK725F1A-105Z1	332181050R1	1
DG8272	C8104	G-CERA C	CK725F1A-105Z1	332181050R1	1
DG8272	C8105	G-CERA C	CK725F1A-105Z1	332181050R1	1
DG8272	C8106	G-CERA C	CK725F1A-105Z1	332181050R1	1
DG8272	C8108	G-CERA C	CK725F1A-105Z1	332181050R1	1
DG8272	C8109	G-CERA C	CK725F1A-105Z1	332181050R1	1
DG8272	C8110	G-CERA C	CK725F1A-105Z1	332181050R1	1
DG8272	C8111	G-CERA C	CK725F1A-105Z1	332181050R1	1
DG8272	C8112	G-CERA C	CK725F1A-105Z1	332181050R1	1
DG8272	C8113	G-CERA C	CK725F1A-105Z1	332181050R1	1

DG8272	C8115	G-CERA C	CK725F1A-105Z1	332181050R1	1
DG8272	C8116	G-CERA C	CK725F1A-105Z1	332181050R1	1
DG8272	C8118	G-CERA C	CK725F1A-105Z1	332181050R1	1
DG8272	C8119	G-CERA C	CK725F1A-105Z1	332181050R1	1
DG8272	C8120	G-CERA C	CK725F1A-105Z1	332181050R1	1
DG8272	C8121	G-CERA C	CK725F1A-105Z1	332181050R1	1
DG8272	C8122	G-CERA C	CK725F1A-105Z1	332181050R1	1
DG8272	C8123	G-CERA C	CK725F1A-105Z1	332181050R1	1
DG8272	C8124	G-CERA C	CK725F1A-105Z1	332181050R1	1
DG8272	C8125	G-CERA C	CK725F1A-105Z1	332181050R1	1
DG8272	C8126	G-CERA C	CK725F1A-105Z1	332181050R1	1
DG8272	C8127	CHIP ELECT C	CEWX4V-220M	3567A2219R2	1
DG8272	C8128	G-CERA C	CK725F1A-105Z1	332181050R1	1
DG8272	C8129	G-CERA C	CK725F1A-105Z1	332181050R1	1
DG8272	C8130	G-CERA C	CK725F1A-105Z1	332181050R1	1
DG8272	C8131	G-CERA C	CK725F1A-105Z1	332181050R1	1
DG8272	C8132	G-CERA C	CK725F1A-105Z1	332181050R1	1
DG8272	C8133	G-CERA C	CK725F1A-105Z1	332181050R1	1
DG8272	C8134	G-CERA C	CK725F1A-105Z1	332181050R1	1
DG8272	C8135	CHIP ELECT C	CEWX4V-220M	3567A2219R2	1
DG8272	C8136	G-CERA C	CK725F1A-105Z1	332181050R1	1
DG8272	C8137	G-CERA C	CK725F1A-105Z1	332181050R1	1
DG8272	C8138	G-CERA C	CK725F1A-105Z1	332181050R1	1
DG8272	C8139	G-CERA C	CC725CHIE-102J1	342111024R1	1
DG8272	C8140	G-CERA C	CC725CH1H-220J1	342102204R1	1
DG8272	C8141	G-CERA C	CK725F1A-105Z1	332181050R1	1
DG8272	C8142	CHIP ELECT C	CEWX4V-220M	3567A2219R2	1
DG8272	C8201	CHIP ELECT C	CEWX16V-22M	356742209R2	1
DG8272	C8202	G-CERA C	CK725F1A-105Z1	332181050R1	1
DG8272	C8204	G-CERA C	CK725F1A-105Z1	332181050R1	1
DG8272	C8205	G-CERA C	CK725F1A-105Z1	332181050R1	1
DG8272	C8206	G-CERA C	CK725F1A-105Z1	332181050R1	1
DG8272	C8210	G-CERA C	CK725F1A-105Z1	332181050R1	1

DG8272	C8212	G-CERA C	CK725F1A-105Z1	332181050R1	1
DG8272	C8213	G-CERA C	CK725F1A-105Z1	332181050R1	1
DG8272	C8214	G-CERA C	CK725F1A-105Z1	332181050R1	1
DG8272	C8218	G-CERA C	CK725F1A-105Z1	332181050R1	1
DG8272	C8220	G-CERA C	CK725F1A-105Z1	332181050R1	1
DG8272	C8221	G-CERA C	CK725F1A-105Z1	332181050R1	1
DG8272	C8222	G-CERA C	CK725F1A-105Z1	332181050R1	1
DG8272	C8226	G-CERA C	CK725F1A-105Z1	332181050R1	1
DG8272	C8228	G-CERA C	CK725F1A-105Z1	332181050R1	1
DG8272	C8229	G-CERA C	CK725F1A-105Z1	332181050R1	1
DG8272	C8230	G-CERA C	CK725F1A-105Z1	332181050R1	1
DG8272	C8231	G-CERA C	CK725F1A-105Z1	332181050R1	1
DG8272	C8232	G-CERA C	CK725F1A-105Z1	332181050R1	1
DG8272	C8234	G-CERA C	CK725F1A-105Z1	332181050R1	1
DG8272	C8236	G-CERA C	CK725F1A-105Z1	332181050R1	1
DG8272	C8237	G-CERA C	CK725F1A-105Z1	332181050R1	1
DG8272	C8238	G-CERA C	CK725F1A-105Z1	332181050R1	1
DG8272	C8241	CHIP ELECT C	CEWX16V-22M	356742209R2	1
DG8272	C8242	G-CERA C	CK725F1A-105Z1	332181050R1	1
DG8272	C8301	G-CERA C	CK725F1A-105Z1	332181050R1	1
DG8272	C8302	G-CERA C	CK725F1A-105Z1	332181050R1	1
DG8272	C8303	G-CERA C	CC725CHIE-102J1	342111024R1	1
DG8272	C8304	G-CERA C	CK725F1A-105Z1	332181050R1	1
DG8272	C8305	CHIP ELECT C	CEWX4V-220M	3567A2219R2	1
DG8272	C8306	G-CERA C	CK725F1A-105Z1	332181050R1	1
DG8272	C8307	G-CERA C	CC725CHIE-102J1	342111024R1	1
DG8272	C8308	G-CERA C	CK725F1A-105Z1	332181050R1	1
DG8272	C8309	G-CERA C	CK725F1A-105Z1	332181050R1	1
DG8272	C8310	G-CERA C	CK725F1A-105Z1	332181050R1	1
DG8272	C8311	CHIP ELECT C	CEWX4V-220M	3567A2219R2	1
DG8272	C8312	G-CERA C	CK725F1A-105Z1	332181050R1	1
DG8272	C8313	CHIP ELECT C	CEWX4V-220M	3567A2219R2	1
DG8272	C8314	G-CERA C	CK725F1A-105Z1	332181050R1	1

DG8272	C8315	G-CERA C	CC725CHIE-102J1	342111024R1	1
DG8272	C8316	G-CERA C	CK725F1A-105Z1	332181050R1	1
DG8272	C8317	G-CERA C	CK725F1A-105Z1	332181050R1	1
DG8272	C8318	G-CERA C	CK725F1A-105Z1	332181050R1	1
DG8272	C8319	G-CERA C	CK725F1A-105Z1	332181050R1	1
DG8272	C8320	CHIP ELECT C	CEWX4V-220M	3567A2219R2	1
DG8272	C8321	G-CERA C	CK725F1A-105Z1	332181050R1	1
DG8272	C8322	G-CERA C	CK725F1A-105Z1	332181050R1	1
DG8272	C8323	CHIP ELECT C	CEWX4V-220M	3567A2219R2	1
DG8272	C8324	G-CERA C	CK725F1A-105Z1	332181050R1	1
DG8272	C8325	G-CERA C	CK725F1A-105Z1	332181050R1	1
DG8272	C8326	G-CERA C	CK725F1A-105Z1	332181050R1	1
DG8272	C8327	G-CERA C	CK725F1A-105Z1	332181050R1	1
DG8272	C8328	CHIP ELECT C	CEWXI6V-22M	356742209R2	1
DG8272	C8329	G-CERA C	CK725F1A-105Z1	332181050R1	1
DG8272	C8330	G-CERA C	CK725F1A-105Z1	332181050R1	1
DG8272	C8331	CHIP ELECT C	CEWXI6V-10M	356741009R2	1
DG8272	C8332	G-CERA C	CK725F1A-105Z1	332181050R1	1
DG8272	C8701	G-CERA C	CK725F1A-105Z1	332181050R1	1
DG8272	C8702	G-CERA C	CK725F1A-105Z1	332181050R1	1
DG8272	C8703	G-CERA C	CK725F1A-105Z1	332181050R1	1
DG8272	C8704	CHIP ELECT C	CEWX50V-4.7M	356780479R2	1
DG8272	C8705	G-CERA C	CK725F1E-104Z1	332161040R1	1
DG8272	C8706	G-CERA C	CK725F1A-105Z1	332181050R1	1
DG8272	C8707	G-CERA C	CK725F1A-105Z1	332181050R1	1
DG8272	C8708	G-CERA C	CK725F1A-105Z1	332181050R1	1
DG8272	C8709	CHIP ELECT C	CEWX4V-220M	3567A2219R2	1
DG8272	C8710	G-CERA C	CK725F1A-105Z1	332181050R1	1
DG8272	D5101	G-DIODE	ISS226	223266R2	1
DG8272	D5201	G-DIODE	ISS226	223266R2	1
DG8272	D5251	G-DIODE	ISS226	223266R2	1
DG8272	D8001	LED	SEC1801C	225386R2	1
DG8272	D8002	LED	SEC1401C	225383R2	1

DG8272	D8003	LED	SEC1201C	225385R2	1
DG8272	D8004	LED	SEC1201C	225385R2	1
DG8272	D8005	LED	SEC1401C	225383R2	1
DG8272	D8701	C-DIODE	ISS352	223234R2	1
DG8272	L5001	CHOKE COIL	NCH-1471	231237K022R2	1
DG8272	L5002	CHOKE COIL	NCH-1471	231237K022R2	1
DG8272	L5003	CHOKE COIL	NCH-1471	231237K022R2	1
DG8272	L5004	CHOKE COIL	NCH-1471	231237K022R2	1
DG8272	L5005	CHOKE COIL	NCH-1471	231237K022R2	1
DG8272	L8001	CHOKE COIL	NCH-1471	231237M022R2	1
DG8272	L8002	CHOKE COIL	NCH-1471	231237M022R2	1
DG8272	L8003	CHOKE COIL	NCH-1471	231237M022R2	1
DG8272	L8004	CHOKE COIL	NCH-1471	231237M022R2	1
DG8272	L8005	CHOKE COIL	NCH-1471	231237M022R2	1
DG8272	L8006	CHOKE COIL	NCH-1471	231237M022R2	1
DG8272	L8101	CHOKE COIL	NCH-1471	231237M022R2	1
DG8272	L8102	CHOKE COIL	NCH-1471	231237M022R2	1
DG8272	L8103	CHOKE COIL	NCH-1471	231237M022R2	1
DG8272	L8301	CHOKE COIL	NCH-1473	231237M047R2	1
DG8272	L8302	CHOKE COIL	NCH-1471	231237M022R2	1
DG8272	L8303	CHOKE COIL	NCH-1473	231237M047R2	1
DG8272	L8304	CHOKE COIL	NCH-1471	231237M022R2	1
DG8272	L8701	CHOKE COIL	NCH-1473	231237M047R2	1
DG8272	P4003B	PLUG	NPLG-4P930	25055977R2	N 1
DG8272	P5001A	PLUG(B to B)	IMSA-9850B-22Y900	25056206R2	1
DG8272	P5002A	PLUG	NPLG-6P932	25055979R2	1
DG8272	P5101	PIN JACK	NPJ-1PDYE402	25045591	1
DG8272	P5201	SOCKET	NSCT-4P1742	25051955	1
DG8272	P5401A	PLUG	CPB8348-0211	25056437R2	1
DG8272	P8001A	PLUG(B to B)	IMSA-9850B-28Y900	25056209R2	N 1
DG8272	P8002A	PLUG(B to B)	IMSA-9850B-20Y900	25056205R2	1
DG8272	P8302	HDMI JACK	DC1R019IDA	25052956R3	N 1
DG8272	P8701A	PLUG(B to B)	IMSA-9850B-10Y900	25056200R2	N 1

DG8272	P8702	PLUG	NPLG-8P660	25055704	1
DG8272	Q5001	IC	SAAT118E	22242060R3	1
DG8272	Q5002	IC	TC74VCXI6224FFT	2227C244DR2TO	1
DG8272	Q5004	TR	2SK3019	2216520R2	1
DG8272	Q5005	TR	2SK3019	2216520R2	1
DG8272	Q8001	IC	SIL504	22242049R3	1
DG8272	Q8002	IC	MCS04	22242050R9	1
DG8272	Q8003	IC	IC42S32200L-7TG	22242056R2	1
DG8272	Q8003 or	IC	IS42S32200B-7T	22242031R3	(1)
DG8272	Q8004	IC	TC7WZU04FU	22242078R2TO	1
DG8272	Q8005	IC	TC74VCXI6224FFT	2227C244DR2TO	1
DG8272	Q8006	IC	TC74VCXI6224FFT	2227C244DR2TO	1
DG8272	Q8007	IC	LM1117MPX-ADJ	22241648R2	1
DG8272	Q8008	TR	2SK3019	2216520R2	1
DG8272	Q8101	IC	REMBRANDT-1A	22242051R3	1
DG8272	Q8102	IC(REGULATOR)	MPC2918T	22278018ER2NE	1
DG8272	Q8201	IC	IC42S16400-7T	22241910R2	1
DG8272	Q8201 or	IC	IC42S16400-7T	22241910R3	(1)
DG8272	Q8202	IC	IC42S16400-7T	22241910R2	1
DG8272	Q8202 or	IC	IC42S16400-7T	22241910R3	(1)
DG8272	Q8203	IC	IC42S16400-7T	22241910R2	1
DG8272	Q8203 or	IC	IC42S16400-7T	22241910R3	(1)
DG8272	Q8204	IC	IC42S16400-7T	22241910R2	1
DG8272	Q8204 or	IC	IC42S16400-7T	22241910R3	(1)
DG8272	Q8205	IC	IC42S16400-7T	22241910R2	1
DG8272	Q8205 or	IC	IC42S16400-7T	22241910R3	(1)
DG8272	Q8301	IC	SIL19190CTG64	22242052R3	1
DG8272	Q8302	IC	TC7SZ125FU	22241895R2	1
DG8272	Q8303	IC	TC7SZ125FU	22241895R2	1
DG8272	Q8304	IC	NJM2860F3-33	22242087R2	1
DG8272	Q8305	IC	NJM2860F3-05	22242105R2	1
DG8272	Q8306	TR	HN1C03F-B	2216141R2	1
DG8272	Q8307	TR	2SA1774	2216410R2	1

DG8272	Q8308	TR	2SB1132	2216400R2	1
DG8272	Q8309	TR	NDC7002N	2216870R2	N 1
DG8272	Q8701	IC	MPD70F3261YGC-8EA(0089)	NSP	N 1
DG8272	Q8702	TR	NDC7002N	2216870R2	N 1
DG8272	Q8703	TR	NDC7002N	2216870R2	N 1
DG8272	Q8704	IC	BR24L08FV-W	22242070R2	N 1
DG8272	Q8705	TR	NDC7002N	2216870R2	N 1
DG8272	Q8706	IC	S-80127CNMC-JKM-T2	22241642R2	1
DG8272	R5001	C-R NET	RM7LJ220X04	43484722004R2	1
DG8272	R5002	C-R NET	RM7LJ220X04	43484722004R2	1
DG8272	R5003	G-CARBON R	RN72K1J-220FE	435032202R1	1
DG8272	R5004	G-CARBON R	RN72K1J-220FE	435032202R1	1
DG8272	R5005	G-CARBON R	RN72K1J-220FE	435032202R1	1
DG8272	R5006	G-CARBON R	RN72K1J-220FE	435032202R1	1
DG8272	R5007	G-CARBON R	RN72K1J-220FE	435032202R1	1
DG8272	R5009	G-CARBON R	RN72K1J-332FE	435033322R1	1
DG8272	R5011	G-CARBON R	RN72K1J-332FE	435033322R1	1
DG8272	R5012	G-CARBON R	RN72K1J-220FE	435032202R1	1
DG8272	R5016	G-CARBON R	RN72K1J-220FE	435032202R1	1
DG8272	R5017	G-CARBON R	RN72K1J-222FE	435032222R1	1
DG8272	R5018	G-CARBON R	RN72K1J-222FE	435032222R1	1
DG8272	R5021	G-CARBON R	RN72K1J-220FE	435032202R1	1
DG8272	R5022	G-CARBON R	RN72K1J-000JE	435030004R1	1
DG8272	R5023	G-CARBON R	RN72K1J-000JE	435030004R1	1
DG8272	R5024	G-CARBON R	RN72K1J-000JE	435030004R1	1
DG8272	R5025	G-CARBON R	RN72K1J-222FE	435032222R1	1
DG8272	R5026	G-CARBON R	RN72K1J-222FE	435032222R1	1
DG8272	R5091	G-CARBON R	RN72K1J-000JE	435030004R1	1
DG8272	R5092	G-CARBON R	RN72K1J-000JE	435030004R1	1
DG8272	R5093	G-CARBON R	RN72K1J-000JE	435030004R1	1
DG8272	R5094	G-CARBON R	RN72K1J-000JE	435030004R1	1
DG8272	R5095	G-CARBON R	RN72K1J-000JE	435030004R1	1
DG8272	R5096	G-CARBON R	RN72K1J-000JE	435030004R1	1

DG8272	R5101	G-CARBON R	RN72K1J-180FE	435031802R1	1
DG8272	R5102	G-CARBON R	RN72K1J-560FE	435035602R1	1
DG8272	R5201	G-CARBON R	RN72K1J-180FE	435031802R1	1
DG8272	R5202	G-CARBON R	RN72K1J-560FE	435035602R1	1
DG8272	R5251	G-CARBON R	RN72K1J-180FE	435031802R1	1
DG8272	R5252	G-CARBON R	RN72K1J-560FE	435035602R1	1
DG8272	R5308	G-CARBON R	RN72K1J-000JE	435030004R1	1
DG8272	R5309	G-CARBON R	RN72K1J-000JE	435030004R1	1
DG8272	R5310	G-CARBON R	RN72K1J-000JE	435030004R1	1
DG8272	R5391	G-CARBON R	RN72K1J-000JE	435030004R1	1
DG8272	R5392	G-CARBON R	RN72K1J-000JE	435030004R1	1
DG8272	R5393	G-CARBON R	RN72K1J-000JE	435030004R1	1
DG8272	R5394	G-CARBON R	RN72K1J-000JE	435030004R1	1
DG8272	R5395	G-CARBON R	RN72K1J-000JE	435030004R1	1
DG8272	R5396	G-CARBON R	RN72K1J-000JE	435030004R1	1
DG8272	R5511	G-CARBON R	RN72K1J-560FE	435035602R1	1
DG8272	R5611	G-CARBON R	RN72K1J-560FE	435035602R1	1
DG8272	R5711	G-CARBON R	RN72K1J-560FE	435035602R1	1
DG8272	R8001	G-CARBON R	RN72K1J-220JE	435032204R1	1
DG8272	R8002	G-CARBON R	RN72K1J-220JE	435032204R1	1
DG8272	R8003	G-CARBON R	RN72K1J-220JE	435032204R1	1
DG8272	R8004	G-CARBON R	RN72K1J-101JE	435031014R1	1
DG8272	R8005	G-R NET	RM7LJ100X04	43484710004R2	N
DG8272	R8006	G-R NET	RM7LJ100X04	43484710004R2	N
DG8272	R8008	G-R NET	RM7LJ100X04	43484710004R2	N
DG8272	R8009	G-R NET	RM7LJ100X04	43484710004R2	N
DG8272	R8011	G-R NET	RM7LJ100X04	43484710004R2	N
DG8272	R8012	G-R NET	RM7LJ100X04	43484710004R2	N
DG8272	R8013	G-CARBON R	RN72K1J-100JE	435031004R1	1
DG8272	R8018	G-CARBON R	RN72K1J-472JE	435034724R1	1
DG8272	R8019	G-CARBON R	RN72K1J-472JE	435034724R1	1
DG8272	R8024	G-CARBON R	RN72K1J-000JE	435030004R1	1
DG8272	R8025	G-CARBON R	RN72K1J-000JE	435030004R1	1

DG8272	R8026	C-CARBON R	RN72K1J-000JE	435030004R1	1
DG8272	R8027	C-CARBON R	RN72K1J-000JE	435030004R1	1
DG8272	R8028	C-CARBON R	RN72K1J-000JE	435030004R1	1
DG8272	R8029	C-CARBON R	RN72K1J-000JE	435030004R1	1
DG8272	R8032	C-CARBON R	RN72K1J-103JE	435031034R1	1
DG8272	R8034	C-CARBON R	RN72K1J-222JE	435032224R1	1
DG8272	R8035	C-CARBON R	RN72K1J-222JE	435032224R1	1
DG8272	R8036	C-CARBON R	RN72K1J-222JE	435032224R1	1
DG8272	R8037	C-CARBON R	RN72K1J-000JE	435030004R1	1
DG8272	R8038	C-CARBON R	RN72K1J-102JE	435031024R1	1
DG8272	R8041	C-CARBON R	RN72K1J-101JE	435031014R1	1
DG8272	R8042	C-R NET	RM7LJ103X04	43484710304R2	N 1
DG8272	R8043	C-R NET	RM7LJ103X04	43484710304R2	N 1
DG8272	R8044	C-CARBON R	RN72K1J-104JE	435031044R1	1
DG8272	R8045	C-CARBON R	RN72K1J-472JE	435034724R1	1
DG8272	R8047	C-CARBON R	RN72K1J-472JE	435034724R1	1
DG8272	R8050	C-CARBON R	RN72K1J-472JE	435034724R1	1
DG8272	R8051	C-CARBON R	RN72K1J-472JE	435034724R1	1
DG8272	R8053	C-CARBON R	RN72K1J-102JE	435031024R1	1
DG8272	R8054	C-CARBON R	RN72K1J-000JE	435030004R1	1
DG8272	R8055	C-CARBON R	RN72K1J-105JE	435031054R1	1
DG8272	R8056	C-CARBON R	RN72K1J-000JE	435030004R1	1
DG8272	R8057	C-CARBON R	RN72K1J-472JE	435034724R1	1
DG8272	R8058	C-CARBON R	RN72K1J-472JE	435034724R1	1
DG8272	R8059	C-CARBON R	RN72K1J-000JE	435030004R1	1
DG8272	R8060	C-CARBON R	RN72K1J-000JE	435030004R1	1
DG8272	R8061	C-CARBON R	RN72K1J-222JE	435032224R1	1
DG8272	R8062	C-CARBON R	RN72K1J-222JE	435032224R1	1
DG8272	R8064	C-CARBON R	RN72K1J-222JE	435032224R1	1
DG8272	R8065	C-CARBON R	RN72K1J-103JE	435031034R1	1
DG8272	R8066	C-CARBON R	RN72K1J-102JE	435031024R1	1
DG8272	R8067	C-CARBON R	RN72K1J-103JE	435031034R1	1
DG8272	R8068	C-CARBON R	RN72K1J-102JE	435031024R1	1

DG8272	R8071	C-CARBON R	RN72K1J-472JE	435034724R1	1
DG8272	R8073	C-CARBON R	RN72K1J-222JE	435032224R1	1
DG8272	R8074	C-CARBON R	RN72K1J-222JE	435032224R1	1
DG8272	R8075	C-CARBON R	RN72K1J-105FE	435031052R1	1
DG8272	R8076	C-CARBON R	RN72K1J-102FE	435031022R1	1
DG8272	R8078	C-CARBON R	RN72K1J-220JE	435032204R1	1
DG8272	R8079	C-CARBON R	RN72K1J-151FE	435031512R1	1
DG8272	R8080	C-CARBON R	RN72K1J-391FE	435033912R1	1
DG8272	R8081	C-CARBON R	RN72K1J-272FE	435032722R1	1
DG8272	R8101	C-CARBON R	RN72K1J-000JE	435030004R1	1
DG8272	R8104	C-CARBON R	RN72K1J-103JE	435031034R1	1
DG8272	R8105	C-CARBON R	RN72K1J-000JE	435030004R1	1
DG8272	R8106	C-CARBON R	RN72K1J-000JE	435030004R1	1
DG8272	R8107	C-CARBON R	RN72K1J-000JE	435030004R1	1
DG8272	R8108	C-CARBON R	RN72K1J-000JE	435030004R1	1
DG8272	R8112	C-CARBON R	RN72K1J-000JE	435030004R1	1
DG8272	R8113	C-CARBON R	RN72K1J-000JE	435030004R1	1
DG8272	R8114	C-CARBON R	RN72K1J-000JE	435030004R1	1
DG8272	R8115	C-CARBON R	RN72K1J-000JE	435030004R1	1
DG8272	R8116	C-CARBON R	RN72K1J-000JE	435030004R1	1
DG8272	R8117	C-CARBON R	RN72K1J-000JE	435030004R1	1
DG8272	R8118	C-CARBON R	RN72K1J-000JE	435030004R1	1
DG8272	R8119	C-CARBON R	RN72K1J-000JE	435030004R1	1
DG8272	R8120	C-CARBON R	RN72K1J-000JE	435030004R1	1
DG8272	R8121	C-CARBON R	RN72K1J-000JE	435030004R1	1
DG8272	R8122	C-CARBON R	RN72K1J-000JE	435030004R1	1
DG8272	R8123	C-CARBON R	RN72K1J-000JE	435030004R1	1
DG8272	R8124	C-CARBON R	RN72K1J-000JE	435030004R1	1
DG8272	R8125	C-CARBON R	RN72K1J-000JE	435030004R1	1
DG8272	R8126	C-CARBON R	RN72K1J-000JE	435030004R1	1
DG8272	R8127	C-CARBON R	RN72K1J-000JE	435030004R1	1
DG8272	R8128	C-CARBON R	RN72K1J-000JE	435030004R1	1
DG8272	R8129	C-CARBON R	RN72K1J-000JE	435030004R1	1

DG8272	R8130	C-CARBON R	RN72K11-000JE	435030004R1	1
DG8272	R8131	C-CARBON R	RN72K11-000JE	435030004R1	1
DG8272	R8132	C-CARBON R	RN72K11-220JE	435032204R1	1
DG8272	R8133	C-CARBON R	RN72K11-102JE	435031024R1	1
DG8272	R8134	C-CARBON R	RN72K11-000JE	435030004R1	1
DG8272	R8135	C-CARBON R	RN72K11-000JE	435030004R1	1
DG8272	R8136	C-CARBON R	RN72K11-103JE	435031034R1	1
DG8272	R8137	C-CARBON R	RN72K11-220JE	435032204R1	1
DG8272	R8138	C-CARBON R	RN72K11-220JE	435032204R1	1
DG8272	R8139	C-CARBON R	RN72K11-220JE	435032204R1	1
DG8272	R8140	C-CARBON R	RN72K11-220JE	435032204R1	1
DG8272	R8141	C-CARBON R	RN72K11-220JE	435032204R1	1
DG8272	R8142	C-R NET	RM7LJ220X04	43484722004R2	1
DG8272	R8143	C-R NET	RM7LJ220X04	43484722004R2	1
DG8272	R8144	C-R NET	RM7LJ220X04	43484722004R2	1
DG8272	R8145	C-R NET	RM7LJ220X04	43484722004R2	1
DG8272	R8146	C-R NET	RM7LJ220X04	43484722004R2	1
DG8272	R8147	C-R NET	RM7LJ220X04	43484722004R2	1
DG8272	R8148	C-CARBON R	RN72K11-470JE	435034704R1	1
DG8272	R8149	C-CARBON R	RN72K11-470JE	435034704R1	1
DG8272	R8150	C-CARBON R	RN72K11-470JE	435034704R1	1
DG8272	R8151	C-CARBON R	RN72K11-470JE	435034704R1	1
DG8272	R8152	C-CARBON R	RN72K11-151JE	435031514R1	1
DG8272	R8153	C-CARBON R	RN72K11-151JE	435031514R1	1
DG8272	R8161	C-CARBON R	RN72K11-000JE	435030004R1	1
DG8272	R8201	C-R NET	RM7LJ471X04	43484747104R2	1
DG8272	R8202	C-R NET	RM7LJ471X04	43484747104R2	1
DG8272	R8203	C-R NET	RM7LJ471X04	43484747104R2	1
DG8272	R8204	C-R NET	RM7LJ471X04	43484747104R2	1
DG8272	R8205	C-R NET	RM7LJ471X04	43484747104R2	1
DG8272	R8206	C-R NET	RM7LJ471X04	43484747104R2	1
DG8272	R8207	C-CARBON R	RN72K11-471JE	435034714R1	1
DG8272	R8209	C-R NET	RM7LJ471X04	43484747104R2	1

DG8272	R8210	C-R NET	RM7LJ471X04	43484747104R2	1
DG8272	R8211	C-R NET	RM7LJ471X04	43484747104R2	1
DG8272	R8212	C-R NET	RM7LJ471X04	43484747104R2	1
DG8272	R8214	C-CARBON R	RN72K1J-000JE	435030004R1	1
DG8272	R8301	C-CARBON R	RN72K1J-000JE	435030004R1	1
DG8272	R8302	C-CARBON R	RN72K1J-000JE	435030004R1	1
DG8272	R8303	C-CARBON R	RN72K1J-000JE	435030004R1	1
DG8272	R8304	C-CARBON R	RN72K1J-471JE	435034714R1	1
DG8272	R8305	C-CARBON R	RN72K1J-103JE	435031034R1	1
DG8272	R8306	C-CARBON R	RN72K1J-470JE	435034704R1	1
DG8272	R8307	C-CARBON R	RN72K1J-102JE	435031024R1	1
DG8272	R8308	C-CARBON R	RN72K1J-104JE	435031044R1	1
DG8272	R8309	C-CARBON R	RN72K1J-104JE	435031044R1	1
DG8272	R8310	C-CARBON R	RN72K1J-220JE	435032204R1	1
DG8272	R8311	C-CARBON R	RN72K1J-220JE	435032204R1	1
DG8272	R8312	C-CARBON R	RN72K1J-222JE	435032224R1	1
DG8272	R8313	C-CARBON R	RN72K1J-222JE	435032224R1	1
DG8272	R8314	C-CARBON R	RN72K1J-561FE	435035612R1	1
DG8272	R8315	C-R NET	RM7LJ000X04	43484700004R2	N
DG8272	R8316	C-R NET	RM7LJ000X04	43484700004R2	N
DG8272	R8317	C-R NET	RM7LJ000X04	43484700004R2	N
DG8272	R8318	C-R NET	RM7LJ000X04	43484700004R2	N
DG8272	R8319	C-CARBON R	RN72K1J-000JE	435030004R1	1
DG8272	R8320	C-R NET	RM7LJ000X04	43484700004R2	N
DG8272	R8321	C-R NET	RM7LJ000X04	43484700004R2	N
DG8272	R8322	C-CARBON R	RN72K1J-473JE	435034734R1	1
DG8272	R8323	C-CARBON R	RN72K1J-103JE	435031034R1	1
DG8272	R8324	C-CARBON R	RN72K1J-103JE	435031034R1	1
DG8272	R8325	C-CARBON R	RN72K1J-472JE	435034724R1	1
DG8272	R8326	C-CARBON R	RN72K1J-472JE	435034724R1	1
DG8272	R8327	C-CARBON R	RN72K1J-102JE	435031024R1	1
DG8272	R8328	C-CARBON R	RN72K1J-332JE	435033324R1	1
DG8272	R8329	C-CARBON R	RN72K1J-332JE	435033324R1	1

DG8272	R8331	C-CARBON R	RN72K1J-182JE	435031824R1	1
DG8272	R8332	C-CARBON R	RN72K1J-332JE	435033324R1	1
DG8272	R8333	C-CARBON R	RN72K1J-102JE	435031024R1	1
DG8272	R8334	C-CARBON R	RN72K1J-202JE	435032024R1	1
DG8272	R8335	C-CARBON R	RN72K1J-202JE	435032024R1	1
DG8272	R8337	C-CARBON R	RN72K1J-472JE	435034724R1	1
DG8272	R8338	C-CARBON R	RN72K1J-472JE	435034724R1	1
DG8272	R8339	C-CARBON R	RN72K1J-222JE	435032224R1	1
DG8272	R8348	C-CARBON R	RN72K1J-150FE	435031502R1	N
DG8272	R8349	C-CARBON R	RN72K1J-102FE	435031022R1	1
DG8272	R8702	C-CARBON R	RN72K1J-103JE	435031034R1	1
DG8272	R8705	C-CARBON R	RN72K1J-000JE	435030004R1	1
DG8272	R8706	C-CARBON R	RN72K1J-103JE	435031034R1	1
DG8272	R8707	C-CARBON R	RN72K1J-103JE	435031034R1	1
DG8272	R8708	C-CARBON R	RN72K1J-000JE	435030004R1	1
DG8272	R8709	C-CARBON R	RN72K1J-220JE	435032204R1	1
DG8272	R8710	C-CARBON R	RN72K1J-103JE	435031034R1	1
DG8272	R8713	C-CARBON R	RN72K1J-220JE	435032204R1	1
DG8272	R8714	C-CARBON R	RN72K1J-220JE	435032204R1	1
DG8272	R8715	C-CARBON R	RN72K1J-220JE	435032204R1	1
DG8272	R8716	C-CARBON R	RN72K1J-220JE	435032204R1	1
DG8272	R8717	C-CARBON R	RN72K1J-000JE	435030004R1	1
DG8272	R8718	C-CARBON R	RN72K1J-000JE	435030004R1	1
DG8272	R8719	C-CARBON R	RN72K1J-220JE	435032204R1	1
DG8272	R8720	C-CARBON R	RN72K1J-220JE	435032204R1	1
DG8272	R8721	C-CARBON R	RN72K1J-220JE	435032204R1	1
DG8272	R8722	C-CARBON R	RN72K1J-470JE	435034704R1	1
DG8272	R8723	C-CARBON R	RN72K1J-470JE	435034704R1	1
DG8272	R8724	C-CARBON R	RN72K1J-470JE	435034704R1	1
DG8272	R8725	C-CARBON R	RN72K1J-470JE	435034704R1	1
DG8272	R8726	C-R NET	RM7LJ220X04	43484722004R2	N
DG8272	R8727	C-R NET	RM7LJ220X04	43484722004R2	N
DG8272	R8728	C-R NET	RM7LJ103X04	43484710304R2	N

PCB NO.	CIRCUIT PART NAME	DESCRIPTION	PART NO.	REMARKS
DG8272	R8729	G-CARBON R	RN72K1J-472JE	435034724R1 1
DG8272	R8730	G-CARBON R	RN72K1J-472JE	435034724R1 1
DG8272	R8731	G-CARBON R	RN72K1J-473JE	435034734R1 1
DG8272	R8732	G-CARBON R	RN72K1J-220JE	435032204R1 1
DG8272	R8733	G-CARBON R	RN72K1J-473JE	435034734R1 1
DG8272	R8734	G-CARBON R	RN72K1J-220JE	435032204R1 1
DG8272	R8735	G-CARBON R	RN72K1J-473JE	435034734R1 1
DG8272	R8736	G-CARBON R	RN72K1J-220JE	435032204R1 1
DG8272	R8737	G-R NET	RM7LJ220X04	43484722004R2 N 1
DG8272	R8738	G-CARBON R	RN72K1J-473JE	435034734R1 1
DG8272	R8739	G-R NET	RM7LJ220X04	43484722004R2 N 1
DG8272	R8740	G-CARBON R	RN72K1J-220JE	435032204R1 1
DG8272	R8741	G-CARBON R	RN72K1J-220JE	435032204R1 1
DG8272	R8742	G-CARBON R	RN72K1J-220JE	435032204R1 1
DG8272	R8743	G-CARBON R	RN72K1J-220JE	435032204R1 1
DG8272	R8744	G-CARBON R	RN72K1J-000JE	435030004R1 1
DG8272	R8745	G-CARBON R	RN72K1J-220JE	435032204R1 1
DG8272	R8746	G-CARBON R	RN72K1J-000JE	435030004R1 1
DG8272	R8748	G-CARBON R	RN72K1J-222JE	435032224R1 1
DG8272	R8749	G-CARBON R	RN72K1J-222JE	435032224R1 1
DG8272	R8750	G-CARBON R	RN72K1J-222JE	435032224R1 1
DG8272	R8751	G-CARBON R	RN72K1J-222JE	435032224R1 1
DG8272	R8752	G-CARBON R	RN72K1J-000JE	435030004R1 1
DG8272	R8753	G-CARBON R	RN72K1J-220JE	435032204R1 1
DG8272	R8754	G-CARBON R	RN72K1J-103JE	435031034R1 1
DG8272	X5001	CRYSTAL	FCX-03-24.576MHZ	3010385R2 1
DG8272	X8001	CRYSTAL	FCX03-20.000MHZ	3010389R2 N 1
DG8272	X8002	CRYSTAL	FCX-03MX-27MHZ	3010355R2 N 1
DG8272	X8701	CERA LOCK	CSTCR5M00G53-B0	3010356R2 1
AR8263	C4004	G-CERAMIC	CK725F1A-10S21	332181050R1 1
AR8263	C4005	CHIP ELECT C	CEWX6.3V-100M	356721019R2 1

AR8263	C4008	G-CERA C	CK725F1A-105Z1	332181050R1	1
AR8263	C4009	G-CERA C	CK725F1A-105Z1	332181050R1	1
AR8263	C4010	CHIP ELECT C	CEWX6.3V-220M	356722219R2	1
AR8263	C4011	G-CERA C	CK725F1A-105Z1	332181050R1	1
AR8263	C4012	CHIP ELECT C	CEWX6.3V-100M	356721019R2	1
AR8263	C4013	CHIP ELECT C	CEWX6.3V-100M	356721019R2	1
AR8263	C4014	G-CERA C	CK725F1A-105Z1	332181050R1	1
AR8263	C4015	G-CERA C	CK725F1A-105Z1	332181050R1	1
AR8263	C4016	CHIP ELECT C	CEWX6.3V-220M	356722219R2	1
AR8263	C4017	G-CERA C	CC725CH1H-120J1	342101204R1	1
AR8263	C4018	CHIP ELECT C	CEWX6.3V-220M	356722219R2	1
AR8263	C4019	CHIP ELECT C	CEWX6.3V-220M	356722219R2	1
AR8263	C4020	G-CERA C	CK725F1A-105Z1	332181050R1	1
AR8263	C4021	G-CERA C	CK725F1A-105Z1	332181050R1	1
AR8263	C4022	G-CERA C	CK725F1A-105Z1	332181050R1	1
AR8263	C4023	G-CERA C	CK725F1A-105Z1	332181050R1	1
AR8263	C4024	G-CERA C	CC725CH1H-120J1	342101204R1	1
AR8263	C4026	G-CERA C	CK725F1A-105Z1	332181050R1	1
AR8263	C4028	G-CERA C	CK725F1A-105Z1	332181050R1	1
AR8263	C4031	G-CERA C	CK725F1A-105Z1	332181050R1	1
AR8263	C4032	CHIP ELECT C	CEWX6.3V-220M	356722219R2	1
AR8263	C4033	G-CERA C	CC725CH1H-080D1	342100802R1	1
AR8263	C4034	G-CERA C	CK725F1A-105Z1	332181050R1	1
AR8263	C4035	G-CERA C	CK725F1A-105Z1	332181050R1	1
AR8263	C4036	G-CERA C	CK725F1A-105Z1	332181050R1	1
AR8263	C4037	G-CERA C	CC725CH1H-080D1	342100802R1	1
AR8263	C4038	G-CERA C	CK725F1A-105Z1	332181050R1	1
AR8263	C4039	G-CERA C	CC725CH1H-220J1	342102204R1	1
AR8263	C4040	G-CERA C	CK725F1A-105Z1	332181050R1	1
AR8263	C4041	G-CERA C	CC725CH1H-150J1	342101504R1	1
AR8263	C4042	G-CERA C	CK725F1A-105Z1	332181050R1	1
AR8263	C4043	CHIP ELECT C	CEWX16V-47M	356744709R2	1
AR8263	C4044	G-CERA C	CK725F1A-105Z1	332181050R1	1

AR8263	C4045	G-CERA C	CK725F1A-105Z1	332181050R1	1
AR8263	C4046	G-CERA C	CK725F1A-105Z1	332181050R1	1
AR8263	C4047	G-CERA C	CC725CH1H-150J1	342101504R1	1
AR8263	C4048	CHIP ELECT C	CEWT6.3V-470M	395724717R2	1
AR8263	C4049	CHIP ELECT C	CEWX6.3V-220M	356722219R2	1
AR8263	C4050	G-CERA C	CK725F1A-105Z1	332181050R1	1
AR8263	C4051	G-CERA C	CK725F1A-105Z1	332181050R1	1
AR8263	C4052	G-CERA C	CC725CH1H-220J1	342102204R1	1
AR8263	C4053	G-CERA C	CC725CH1H-470J1	342104704R1	1
AR8263	C4054	G-CERA C	CK725F1A-105Z1	332181050R1	1
AR8263	C4055	G-CERA C	CC725CH1H-220J1	342102204R1	1
AR8263	C4056	G-CERA C	CC725CH1H-102J1	342101024R1	1
AR8263	C4057	G-CERA C	CK725F1A-105Z1	332181050R1	1
AR8263	C4058	G-CERA C	CK725F1A-105Z1	332181050R1	1
AR8263	C4059	CHIP ELECT C	CEWX6.3V-220M	356722219R2	1
AR8263	C4060	G-CERA C	CK725F1A-105Z1	332181050R1	1
AR8263	C4063	G-CERA C	CK725F1A-105Z1	332181050R1	1
AR8263	C4064	G-CERA C	CK725F1A-105Z1	332181050R1	1
AR8263	C4065	G-CERA C	CK725F1A-105Z1	332181050R1	1
AR8263	C4066	G-CERA C	CK725F1A-105Z1	332181050R1	1
AR8263	C4207	CHIP ELECT C	CEWX25V-100M	356751019R2	N
AR8263	C4208	CHIP ELECT C	CEWX25V-100M	356751019R2	N
AR8263	C4209	CHIP ELECT C	CEWX25V-100M	356751019R2	N
AR8263	C4210	CHIP ELECT C	CEWX25V-100M	356751019R2	N
AR8263	C4302	CHIP ELECT C	CEWX16V-10M	356741009R2	1
AR8263	C4303	CHIP ELECT C	CEWX16V-47M	356744709R2	1
AR8263	C4305	CHIP ELECT C	CEWX6.3V-100M	356721019R2	1
AR8263	C4307	CHIP ELECT C	CEWX6.3V-100M	356721019R2	1
AR8263	C4309	CHIP ELECT C	CE30W6.3V-100M(RVO)	396121017R2	N
AR8263	C4312	CHIP ELECT C	CE30W6.3V-100M(RVO)	396121017R2	N
AR8263	C4321	TF C	EOQ-B50V-821J	374728214	1
AR8263	C4322	TF C	EOQ-B50V-821J	374728214	1
AR8263	C4323	TF C	EOQ-B50V-821J	374728214	1

AR8263	C4324	TF C	ECQ-B50V-821J	374728214	1
AR8263	C4325	TF C	ECQ-B50V-391K	374723915	1
AR8263	C4326	TF C	ECQ-B50V-391K	374723915	1
AR8263	C4327	TF C	ECQ-B50V-391K	374723915	1
AR8263	C4328	TF C	ECQ-B50V-391K	374723915	1
AR8263	C4329	CHIP ELECT C	CEWXI6V-47M	356744709R2	1
AR8263	C4330	CHIP ELECT C	CEWXI6V-47M	356744709R2	1
AR8263	C4331	CHIP ELECT C	CEWXI6V-47M	356744709R2	1
AR8263	C4332	CHIP ELECT C	CEWXI6V-47M	356744709R2	1
AR8263	C4339	TF C	ECQ-B50V-122J	374721224	1
AR8263	C4340	TF C	ECQ-B50V-122J	374721224	1
AR8263	C4341	TF C	ECQ-B50V-471J	374724714	1
AR8263	C4342	TF C	ECQ-B50V-471J	374724714	1
AR8263	C4343	TF C	ECQ-B50V-101K	374721015	1
AR8263	C4344	TF C	ECQ-B50V-101K	374721015	1
AR8263	C4402	CHIP ELECT C	CEWXI6V-10M	356741009R2	1
AR8263	C4403	CHIP ELECT C	CEWXI6V-47M	356744709R2	1
AR8263	C4405	CHIP ELECT C	CEWX6.3V-100M	356721019R2	1
AR8263	C4407	CHIP ELECT C	CEWX6.3V-100M	356721019R2	1
AR8263	C4409	CHIP ELECT C	CE30W6.3V-100M(RVO)	396121017R2	N
AR8263	C4412	CHIP ELECT C	CE30W6.3V-100M(RVO)	396121017R2	N
AR8263	C4421	TF C	ECQ-B50V-821J	374728214	1
AR8263	C4422	TF C	ECQ-B50V-821J	374728214	1
AR8263	C4423	TF C	ECQ-B50V-821J	374728214	1
AR8263	C4424	TF C	ECQ-B50V-821J	374728214	1
AR8263	C4425	TF C	ECQ-B50V-391K	374723915	1
AR8263	C4426	TF C	ECQ-B50V-391K	374723915	1
AR8263	C4427	TF C	ECQ-B50V-391K	374723915	1
AR8263	C4428	TF C	ECQ-B50V-391K	374723915	1
AR8263	C4429	CHIP ELECT C	CEWXI6V-47M	356744709R2	1
AR8263	C4430	CHIP ELECT C	CEWXI6V-47M	356744709R2	1
AR8263	C4431	CHIP ELECT C	CEWXI6V-47M	356744709R2	1
AR8263	C4432	CHIP ELECT C	CEWXI6V-47M	356744709R2	1

AR8263	C4439	TF C	ECQ-B50V-122J	374721224		1
AR8263	C4440	TF C	ECQ-B50V-122J	374721224		1
AR8263	C4441	TF C	ECQ-B50V-471J	374724714		1
AR8263	C4442	TF C	ECQ-B50V-471J	374724714		1
AR8263	C4443	TF C	ECQ-B50V-101K	374721015		1
AR8263	C4444	TF C	ECQ-B50V-101K	374721015		1
AR8263	C4502	CHIP ELECT C	CEWXI6V-10M	356741009R2		1
AR8263	C4503	CHIP ELECT C	CEWXI6V-47M	356744709R2		1
AR8263	C4505	CHIP ELECT C	CEWX6.3V-100M	356721019R2		1
AR8263	C4507	CHIP ELECT C	CEWX6.3V-100M	356721019R2		1
AR8263	C4509	CHIP ELECT C	CE30W6.3V-100M(RVO)	396121017R2	N	1
AR8263	C4512	CHIP ELECT C	CE30W6.3V-100M(RVO)	396121017R2	N	1
AR8263	C4521	TF C	ECQ-B50V-821J	374728214		1
AR8263	C4522	TF C	ECQ-B50V-821J	374728214		1
AR8263	C4523	TF C	ECQ-B50V-821J	374728214		1
AR8263	C4524	TF C	ECQ-B50V-821J	374728214		1
AR8263	C4525	TF C	ECQ-B50V-391K	374723915		1
AR8263	C4526	TF C	ECQ-B50V-391K	374723915		1
AR8263	C4527	TF C	ECQ-B50V-391K	374723915		1
AR8263	C4528	TF C	ECQ-B50V-391K	374723915		1
AR8263	C4529	CHIP ELECT C	CEWXI6V-47M	356744709R2		1
AR8263	C4530	CHIP ELECT C	CEWXI6V-47M	356744709R2		1
AR8263	C4531	CHIP ELECT C	CEWXI6V-47M	356744709R2		1
AR8263	C4532	CHIP ELECT C	CEWXI6V-47M	356744709R2		1
AR8263	C4539	TF C	ECQ-B50V-122J	374721224		1
AR8263	C4540	TF C	ECQ-B50V-122J	374721224		1
AR8263	C4541	TF C	ECQ-B50V-471J	374724714		1
AR8263	C4542	TF C	ECQ-B50V-471J	374724714		1
AR8263	C4543	TF C	ECQ-B50V-101K	374721015		1
AR8263	C4544	TF C	ECQ-B50V-101K	374721015		1
AR8263	C4602	CHIP ELECT C	CEWXI6V-10M	356741009R2		1
AR8263	C4603	CHIP ELECT C	CEWXI6V-47M	356744709R2		1
AR8263	C4605	CHIP ELECT C	CEWX6.3V-100M	356721019R2		1

AR8263	C4607	CHIP ELECT C	CEWX6.3V-100M	356721019R2	1
AR8263	C4609	CHIP ELECT C	CE30W6.3V-100M(RVO)	396121017R2	N 1
AR8263	C4612	CHIP ELECT C	CE30W6.3V-100M(RVO)	396121017R2	N 1
AR8263	C4621	TF C	ECQ-B50V-821J	374728214	1
AR8263	C4622	TF C	ECQ-B50V-821J	374728214	1
AR8263	C4623	TF C	ECQ-B50V-821J	374728214	1
AR8263	C4624	TF C	ECQ-B50V-821J	374728214	1
AR8263	C4625	TF C	ECQ-B50V-391K	374723915	1
AR8263	C4626	TF C	ECQ-B50V-391K	374723915	1
AR8263	C4627	TF C	ECQ-B50V-391K	374723915	1
AR8263	C4628	TF C	ECQ-B50V-391K	374723915	1
AR8263	C4629	CHIP ELECT C	CEWXI6V-47M	356744709R2	1
AR8263	C4630	CHIP ELECT C	CEWXI6V-47M	356744709R2	1
AR8263	C4631	CHIP ELECT C	CEWXI6V-47M	356744709R2	1
AR8263	C4632	CHIP ELECT C	CEWXI6V-47M	356744709R2	1
AR8263	C4639	TF C	ECQ-B50V-122J	374721224	1
AR8263	C4640	TF C	ECQ-B50V-122J	374721224	1
AR8263	C4641	TF C	ECQ-B50V-471J	374724714	1
AR8263	C4642	TF C	ECQ-B50V-471J	374724714	1
AR8263	C4643	TF C	ECQ-B50V-101K	374721015	1
AR8263	C4644	TF C	ECQ-B50V-101K	374721015	1
AR8263	D4002	G-DIODE	ISS355	223269R2	1
AR8263	D4003	G-DIODE	ISS355	223269R2	1
AR8263	D4204	G-DIODE	ISS355	223269R2	1
AR8263	D4205	G-DIODE	ISS355	223269R2	1
AR8263	D4206	G-DIODE	ISS355	223269R2	1
AR8263	D4301	G-DIODE	ISS355	223269R2	1
AR8263	D4302	G-DIODE	ISS355	223269R2	1
AR8263	D4401	G-DIODE	ISS355	223269R2	1
AR8263	D4402	G-DIODE	ISS355	223269R2	1
AR8263	D4501	G-DIODE	ISS355	223269R2	1
AR8263	D4502	G-DIODE	ISS355	223269R2	1
AR8263	D4601	G-DIODE	ISS355	223269R2	1

AR8263	D4602	C-DIODE	ISS355	223269R2	1
AR8263	E4001	RETAINER	KANAGU(7-2)	27141059	1
AR8263	L4001	CORE	BLM41PG750SN1L	230950R2	N 1
AR8263	L4002	CORE	BLM41PG750SN1L	230950R2	N 1
AR8263	L4005	CORE	BLM41PG750SN1L	230950R2	N 1
AR8263	L4007	CORE	BLM41PG750SN1L	230950R2	N 1
AR8263	L4008	CORE	BLM41PG750SN1L	230950R2	1
AR8263	L4009	CORE	BLM41PG750SN1L	230950R2	1
AR8263	L4010	CORE	BLM41PG750SN1L	230950R2	1
AR8263	L4011	CORE	BLM41PG750SN1L	230950R2	1
AR8263	L4301	CORE	BLM41PG750SN1L	230950R2	N 1
AR8263	L4302	CORE	BLM41PG750SN1L	230950R2	N 1
AR8263	L4303	CORE	BLM41PG750SN1L	230950R2	N 1
AR8263	L4401	CORE	BLM41PG750SN1L	230950R2	N 1
AR8263	L4402	CORE	BLM41PG750SN1L	230950R2	N 1
AR8263	L4403	CORE	BLM41PG750SN1L	230950R2	N 1
AR8263	L4501	CORE	BLM41PG750SN1L	230950R2	N 1
AR8263	L4502	CORE	BLM41PG750SN1L	230950R2	N 1
AR8263	L4503	CORE	BLM41PG750SN1L	230950R2	N 1
AR8263	L4601	CORE	BLM41PG750SN1L	230950R2	N 1
AR8263	L4602	CORE	BLM41PG750SN1L	230950R2	N 1
AR8263	L4603	CORE	BLM41PG750SN1L	230950R2	N 1
AR8263	P1302B	PLUG	SM20B-SURS-TF	25056401R2	N 1
AR8263	P2003B	PLUG	SM20B-SURS-TF	25056401R2	N 1
AR8263	P2004B	PLUG	SM16B-SURS-TF	25056399R2	N 1
AR8263	P3002B	PLUG	SM11B-SRSS-TB	25056388R2	1
AR8263	P4003A	PLUG	NPLG-4P930	25055977R2	N 1
AR8263	P4005A	PLUG	NPLG-5P220	25055236	1
AR8263	P4007	PLUG	NPLG-6P1103	25056164R2	N 1
AR8263	P4008A	PLUG	NPLG-5P931	25055978R2	1
AR8263	P4011	BUS BAR	BBL40	27141867	1
AR8263	P4012	BUS BAR	BBL15	27141869	1
AR8263	P4202A	PLUG	SM15B-SRSS-TB	25056392R2	N 1

AR8263	P4203A	PLUG	SM14B-SRSS-TB	25056391R2	N	1
AR8263	P4950A	PLUG	NPLG-7P933	25055980R2		1
AR8263	P9102B	PLUG	NPLG-8P934	25055981R2		1
AR8263	Q4005	IC	CY7C1019BV33-15VCT	22241612R2		1
AR8263	Q4005 or	IC	CY7C1019CV33-15VCT	22241887R2	(1)	(1)
AR8263	Q4006	IC	CY7C1019BV33-15VCT	22241612R2		1
AR8263	Q4006 or	IC	CY7C1019CV33-15VCT	22241887R2	(1)	(1)
AR8263	Q4007	IC	74HCT00AF(TC74HCT00AF)	222740007R2TO		1
AR8263	Q4008	IC	TC7WH241FK	22242075R2TO	N	1
AR8263	Q4009	IC(REGURAT	NJM2391DL1-285	22278028DR2JR		1
AR8263	Q4010	IC	TC74VHC74FT	22274074ER2TO		1
AR8263	Q4012	IC	MB86344BPFV	22241847R3		1
AR8263	Q4013	IC	TC7WT74FU	22242081R2TO		1
AR8263	Q4014	IC	NJU6321PE	22241288R2		1
AR8263	Q4015	IC	TC7WH241FK	22242075R2TO		1
AR8263	Q4016	IC	NJU6321PE	22241288R2		1
AR8263	Q4017	IC	TC9246F	22240928R2		1
AR8263	Q4018	IC	TC7WH241FK	22242075R2TO	N	1
AR8263	Q4019	IC	TC7WH241FK	22242075R2TO	N	1
AR8263	Q4020	IC	TC7SZ125FU	22241895R2		1
AR8263	Q4021	IC	TC7SZ125FU	22241895R2		1
AR8263	Q4022	IC	TC7SZ125FU	22241895R2		1
AR8263	Q4207	TR	RN1404	2214490R2		1
AR8263	Q4208	TR	RN1404	2214490R2		1
AR8263	Q4213	TR	RN1404	2214490R2		1
AR8263	Q4301	IC	NJM2370U05	22241289R2		1
AR8263	Q4302	IC	WM8719EDS	22242068R2	N	1
AR8263	Q4321	IC	NJM4580M-D	22241448R2		1
AR8263	Q4322	IC	NJM4580M-D	22241448R2		1
AR8263	Q4323	IC	NJM4580M-D	22241448R2		1
AR8263	Q4324	IC	NJM4580M-D	22241448R2		1
AR8263	Q4401	IC	NJM2370U05	22241289R2		1
AR8263	Q4402	IC	WM8719EDS	22242068R2	N	1

AR8263	Q4421	IC	NJM4580M-D	222.41.448R2	1
AR8263	Q4422	IC	NJM4580M-D	222.41.448R2	1
AR8263	Q4423	IC	NJM4580M-D	222.41.448R2	1
AR8263	Q4424	IC	NJM4580M-D	222.41.448R2	1
AR8263	Q4501	IC	NJM2370U05	222.41.289R2	1
AR8263	Q4502	IC	WM8719EDS	222.42068R2	N
AR8263	Q4521	IC	NJM4580M-D	222.41.448R2	1
AR8263	Q4522	IC	NJM4580M-D	222.41.448R2	1
AR8263	Q4523	IC	NJM4580M-D	222.41.448R2	1
AR8263	Q4524	IC	NJM4580M-D	222.41.448R2	1
AR8263	Q4601	IC	NJM2370U05	222.41.289R2	1
AR8263	Q4602	IC	WM8719EDS	222.42068R2	N
AR8263	Q4621	IC	NJM4580M-D	222.41.448R2	1
AR8263	Q4622	IC	NJM4580M-D	222.41.448R2	1
AR8263	Q4623	IC	NJM4580M-D	222.41.448R2	1
AR8263	Q4624	IC	NJM4580M-D	222.41.448R2	1
AR8263	R4001	C-CARBON R	RN72K1J-470JE	435034704R1	1
AR8263	R4004	C-CARBON R	RN72K1J-470JE	435034704R1	1
AR8263	R4008	C-CARBON R	RN72K1J-000JE	435030004R1	1
AR8263	R4012	C-CARBON R	RN72K1J-000JE	435030004R1	1
AR8263	R4014	C-CARBON R	RN72K1J-000JE	435030004R1	1
AR8263	R4015	C-CARBON R	RN72K1J-000JE	435030004R1	1
AR8263	R4016	C-CARBON R	RN72K1J-000JE	435030004R1	1
AR8263	R4017	C-CARBON R	RN72K1J-000JE	435030004R1	1
AR8263	R4018	C-CARBON R	RN72K1J-000JE	435030004R1	1
AR8263	R4019	C-CARBON R	RN72K1J-000JE	435030004R1	1
AR8263	R4020	C-CARBON R	RN72K1J-000JE	435030004R1	1
AR8263	R4021	C-CARBON R	RN72K1J-000JE	435030004R1	1
AR8263	R4022	C-CARBON R	RN72K1J-102JE	435031024R1	1
AR8263	R4023	C-CARBON R	RN72K1J-102JE	435031024R1	1
AR8263	R4024	C-CARBON R	RN72K1J-102JE	435031024R1	1
AR8263	R4025	C-CARBON R	RN72K1J-000JE	435030004R1	1
AR8263	R4026	C-CARBON R	RN72K1J-000JE	435030004R1	1

AR8263	R4027	C-CARBON R	RN72K11-000JE	435030004R1	1
AR8263	R4028	C-CARBON R	RN72K11-000JE	435030004R1	1
AR8263	R4029	C-CARBON R	RN72K11-000JE	435030004R1	1
AR8263	R4030	C-CARBON R	RN72K11-000JE	435030004R1	1
AR8263	R4031	C-CARBON R	RN72K11-000JE	435030004R1	1
AR8263	R4032	C-CARBON R	RN72K11-000JE	435030004R1	1
AR8263	R4033	C-CARBON R	RN72K11-470JE	435034704R1	1
AR8263	R4036	C-CARBON R	RN72K11-470JE	435034704R1	1
AR8263	R4037	C-CARBON R	RN72K11-000JE	435030004R1	1
AR8263	R4038	C-CARBON R	RN72K11-000JE	435030004R1	1
AR8263	R4039	C-CARBON R	RN72K11-000JE	435030004R1	1
AR8263	R4040	C-CARBON R	RN72K11-000JE	435030004R1	1
AR8263	R4041	C-CARBON R	RN72K11-000JE	435030004R1	1
AR8263	R4042	C-CARBON R	RN72K11-000JE	435030004R1	1
AR8263	R4043	C-CARBON R	RN72K11-000JE	435030004R1	1
AR8263	R4050	METAL R	RNU1/2WCJ-0.82	4353538294T	1
AR8263	R4051	C-CARBON R	RN72K11-560JE	435035604R1	1
AR8263	R4052	C-CARBON R	RN72K11-560JE	435035604R1	1
AR8263	R4053	C-CARBON R	RN72K11-560JE	435035604R1	1
AR8263	R4054	C-CARBON R	RN72K11-560JE	435035604R1	1
AR8263	R4055	C-CARBON R	RN72K11-560JE	435035604R1	1
AR8263	R4056	C-CARBON R	RN72K11-102JE	435031024R1	1
AR8263	R4058	C-CARBON R	RN72K11-560JE	435035604R1	1
AR8263	R4059	C-CARBON R	RN72K11-560JE	435035604R1	1
AR8263	R4060	C-CARBON R	RN72K11-560JE	435035604R1	1
AR8263	R4061	C-CARBON R	RN72K11-560JE	435035604R1	1
AR8263	R4062	C-CARBON R	RN72K11-560JE	435035604R1	1
AR8263	R4063	C-CARBON R	RN72K11-560JE	435035604R1	1
AR8263	R4064	C-CARBON R	RN72K11-472JE	435034724R1	1
AR8263	R4065	C-CARBON R	RN72K11-102JE	435031024R1	1
AR8263	R4066	C-CARBON R	RN72K11-102JE	435031024R1	1
AR8263	R4067	C-CARBON R	RN72K11-560JE	435035604R1	1
AR8263	R4071	C-CARBON R	RN72K11-560JE	435035604R1	1

AR8263	R4072	C-CARBON R	RN72K1J-102JE	435031024R1	1
AR8263	R4073	C-CARBON R	RN72K1J-560JE	435035604R1	1
AR8263	R4074	C-CARBON R	RN72K1J-560JE	435035604R1	1
AR8263	R4075	C-CARBON R	RN72K1J-102JE	435031024R1	1
AR8263	R4076	C-CARBON R	RN72K1J-000JE	435030004R1	1
AR8263	R4077	C-CARBON R	RN72K1J-102JE	435031024R1	1
AR8263	R4078	C-CARBON R	RN72K1J-560JE	435035604R1	1
AR8263	R4079	C-CARBON R	RN72K1J-000JE	435030004R1	1
AR8263	R4081	C-CARBON R	RN72K1J-560JE	435035604R1	1
AR8263	R4082	C-CARBON R	RN72K1J-560JE	435035604R1	1
AR8263	R4083	C-CARBON R	RN72K1J-560JE	435035604R1	1
AR8263	R4084	C-CARBON R	RN72K1J-103JE	435031034R1	1
AR8263	R4085	C-CARBON R	RN72K1J-560JE	435035604R1	1
AR8263	R4086	C-CARBON R	RN72K1J-560JE	435035604R1	1
AR8263	R4087	C-CARBON R	RN72K1J-560JE	435035604R1	1
AR8263	R4088	C-CARBON R	RN72K1J-560JE	435035604R1	1
AR8263	R4090	C-CARBON R	RN72K1J-560JE	435035604R1	1
AR8263	R4091	C-CARBON R	RN72K1J-560JE	435035604R1	1
AR8263	R4092	C-CARBON R	RN72K1J-560JE	435035604R1	1
AR8263	R4093	C-CARBON R	RN72K1J-000JE	435030004R1	1
AR8263	R4094	C-CARBON R	RN72K1J-102JE	435031024R1	1
AR8263	R4096	C-CARBON R	RN72K1J-221JE	435032214R1	1
AR8263	R4097	C-CARBON R	RN72K1J-331JE	435033314R1	1
AR8263	R4098	C-CARBON R	RN72K1J-331JE	435033314R1	1
AR8263	R4099	C-CARBON R	RN72K1J-560JE	435035604R1	1
AR8263	R4100	C-CARBON R	RN72K1J-331JE	435033314R1	1
AR8263	R4101	C-CARBON R	RN72K1J-220JE	435032204R1	1
AR8263	R4102	C-CARBON R	RN72K1J-560JE	435035604R1	1
AR8263	R4103	C-CARBON R	RN72K1J-000JE	435030004R1	1
AR8263	R4105	C-CARBON R	RN72K1J-560JE	435035604R1	1
AR8263	R4106	C-CARBON R	RN72K1J-102JE	435031024R1	1
AR8263	R4107	C-CARBON R	RN72K1J-560JE	435035604R1	1
AR8263	R4108	C-CARBON R	RN72K1J-103JE	435031034R1	1

AR8263	R4109	C-CARBON R	RN72K1J-102JE	435031024R1	1
AR8263	R4110	C-CARBON R	RN72K1J-560JE	435035604R1	1
AR8263	R4111	C-CARBON R	RN72K1J-102JE	435031024R1	1
AR8263	R4112	C-CARBON R	RN72K1J-331JE	435033314R1	1
AR8263	R4113	C-CARBON R	RN72K1J-331JE	435033314R1	1
AR8263	R4114	C-CARBON R	RN72K1J-560JE	435035604R1	1
AR8263	R4117	C-CARBON R	RN72K1J-560JE	435035604R1	1
AR8263	R4118	C-CARBON R	RN72K1J-560JE	435035604R1	1
AR8263	R4119	C-CARBON R	RN72K1J-331JE	435033314R1	1
AR8263	R4120	C-CARBON R	RN72K1J-331JE	435033314R1	1
AR8263	R4121	C-CARBON R	RN72K1J-560JE	435035604R1	1
AR8263	R4122	C-CARBON R	RN72K1J-331JE	435033314R1	1
AR8263	R4123	C-CARBON R	RN72K1J-331JE	435033314R1	1
AR8263	R4124	C-CARBON R	RN72K1J-560JE	435035604R1	1
AR8263	R4126	C-CARBON R	RN72K1J-560JE	435035604R1	1
AR8263	R4127	C-CARBON R	RN72K1J-560JE	435035604R1	1
AR8263	R4128	C-CARBON R	RN72K1J-102JE	435031024R1	1
AR8263	R4129	C-CARBON R	RN72K1J-560JE	435035604R1	1
AR8263	R4130	C-CARBON R	RN72K1J-331JE	435033314R1	1
AR8263	R4132	C-CARBON R	RN72K1J-100JE	435031004R1	1
AR8263	R4133	C-CARBON R	RN72K1J-000JE	435030004R1	1
AR8263	R4134	C-CARBON R	RN72K1J-220JE	435032204R1	1
AR8263	R4135	C-CARBON R	RN72K1J-152JE	435031524R1	1
AR8263	R4136	C-CARBON R	RN72K1J-102JE	435031024R1	1
AR8263	R4137	C-CARBON R	RN72K1J-562JE	435035624R1	1
AR8263	R4138	C-CARBON R	RN72K1J-102JE	435031024R1	1
AR8263	R4139	C-CARBON R	RN72K1J-000JE	435030004R1	1
AR8263	R4140	C-CARBON R	RN72K1J-101JE	435031014R1	1
AR8263	R4141	C-CARBON R	RN72K1J-103JE	435031034R1	1
AR8263	R4142	C-CARBON R	RN72K1J-102JE	435031024R1	1
AR8263	R4143	C-CARBON R	RN72K1J-102JE	435031024R1	1
AR8263	R4144	C-CARBON R	RN72K1J-102JE	435031024R1	1
AR8263	R4145	C-CARBON R	RN72K1J-100JE	435031004R1	1

AR8263	R4147	C-CARBON R	RN72K1J-000JE	435030004R1	1
AR8263	R4150	EMIFIL	BK1608LL241-T	230959R1	1
AR8263	R4151	C-CARBON R	RN72K1J-000JE	435030004R1	1
AR8263	R4153	C-CARBON R	RN72K1J-470JE	435034704R1	1
AR8263	R4154	C-CARBON R	RN72K1J-470JE	435034704R1	1
AR8263	R4155	C-CARBON R	RN72K1J-470JE	435034704R1	1
AR8263	R4156	C-CARBON R	RN72K1J-470JE	435034704R1	1
AR8263	R4206	C-CARBON R	RN72K1J-470JE	435034704R1	1
AR8263	R4207	C-CARBON R	RN72K1J-470JE	435034704R1	1
AR8263	R4208	C-CARBON R	RN72K1J-470JE	435034704R1	1
AR8263	R4209	C-CARBON R	RN72K1J-470JE	435034704R1	1
AR8263	R4210	C-CARBON R	RN72K1J-470JE	435034704R1	1
AR8263	R4211	C-CARBON R	RN72K1J-470JE	435034704R1	1
AR8263	R4212	C-CARBON R	RN72K1J-470JE	435034704R1	1
AR8263	R4213	C-CARBON R	RN72K1J-470JE	435034704R1	1
AR8263	R4214	C-CARBON R	RN72K1J-470JE	435034704R1	1
AR8263	R4215	C-CARBON R	RN72K1J-470JE	435034704R1	1
AR8263	R4216	C-CARBON R	RN72K1J-470JE	435034704R1	1
AR8263	R4217	C-CARBON R	RN72K1J-470JE	435034704R1	1
AR8263	R4218	C-CARBON R	RN72K1J-470JE	435034704R1	1
AR8263	R4220	C-CARBON R	RN72K1J-000JE	435030004R1	1
AR8263	R4221	C-CARBON R	RN72K1J-000JE	435030004R1	1
AR8263	R4223	C-CARBON R	RN72K1J-470JE	435034704R1	1
AR8263	R4224	C-CARBON R	RN72K1J-470JE	435034704R1	1
AR8263	R4225	C-CARBON R	RN72K1J-470JE	435034704R1	1
AR8263	R4226	C-CARBON R	RN72K1J-470JE	435034704R1	1
AR8263	R4227	C-CARBON R	RN72K1J-470JE	435034704R1	1
AR8263	R4228	C-CARBON R	RN72K1J-470JE	435034704R1	1
AR8263	R4238	C-CARBON R	RN72K1J-470JE	435034704R1	1
AR8263	R4239	C-CARBON R	RN72K1J-470JE	435034704R1	1
AR8263	R4247	C-CARBON R	RN72K1J-103JE	435031034R1	1
AR8263	R4250	C-CARBON R	RN72K1J-472JE	435034724R1	1
AR8263	R4301	C-CARBON R	RN72K1J-102JE	435031024R1	1

AR8263	R4303	C-CARBON R	RN72K1J-470JE	435034704R1	1
AR8263	R4304	C-CARBON R	RN72K1J-470JE	435034704R1	1
AR8263	R4305	C-CARBON R	RN72K1J-470JE	435034704R1	1
AR8263	R4306	C-CARBON R	RN72K1J-470JE	435034704R1	1
AR8263	R4307	C-CARBON R	RN72K1J-470JE	435034704R1	1
AR8263	R4308	C-CARBON R	RN72K1J-470JE	435034704R1	1
AR8263	R4309	C-CARBON R	RN72K1J-470JE	435034704R1	1
AR8263	R4310	C-CARBON R	RN72K1J-470JE	435034704R1	1
AR8263	R4311	C-CARBON R	RN72K1J-470JE	435034704R1	1
AR8263	R4312	C-CARBON R	RN72K1J-152JE	435031524R1	1
AR8263	R4313	C-CARBON R	RN72K1J-470JE	435034704R1	1
AR8263	R4316	C-CARBON R	RN72K1J-000JE	435030004R1	1
AR8263	R4321	C-CARBON R	RN72K1J-272JE	435032724R1	1
AR8263	R4322	C-CARBON R	RN72K1J-272JE	435032724R1	1
AR8263	R4323	C-CARBON R	RN72K1J-272JE	435032724R1	1
AR8263	R4324	C-CARBON R	RN72K1J-272JE	435032724R1	1
AR8263	R4325	C-CARBON R	RN72K1J-152JE	435031524R1	1
AR8263	R4326	C-CARBON R	RN72K1J-152JE	435031524R1	1
AR8263	R4327	C-CARBON R	RN72K1J-152JE	435031524R1	1
AR8263	R4328	C-CARBON R	RN72K1J-152JE	435031524R1	1
AR8263	R4329	C-CARBON R	RN72K1J-272JE	435032724R1	1
AR8263	R4330	C-CARBON R	RN72K1J-272JE	435032724R1	1
AR8263	R4331	C-CARBON R	RN72K1J-272JE	435032724R1	1
AR8263	R4332	C-CARBON R	RN72K1J-272JE	435032724R1	1
AR8263	R4333	C-CARBON R	RN72K1J-220JE	435032204R1	1
AR8263	R4334	C-CARBON R	RN72K1J-220JE	435032204R1	1
AR8263	R4335	C-CARBON R	RN72K1J-220JE	435032204R1	1
AR8263	R4336	C-CARBON R	RN72K1J-220JE	435032204R1	1
AR8263	R4337	C-CARBON R	RN72K1J-220JE	435032204R1	1
AR8263	R4338	C-CARBON R	RN72K1J-220JE	435032204R1	1
AR8263	R4339	C-CARBON R	RN72K1J-220JE	435032204R1	1
AR8263	R4340	C-CARBON R	RN72K1J-220JE	435032204R1	1
AR8263	R4341	C-CARBON R	RN72K1J-822JE	435038224R1	1

AR8263	R4342	C-CARBON R	RN72K1J-822JE	435038224R1	1
AR8263	R4343	C-CARBON R	RN72K1J-182JE	435031824R1	1
AR8263	R4344	C-CARBON R	RN72K1J-182JE	435031824R1	1
AR8263	R4345	C-CARBON R	RN72K1J-103JE	435031034R1	1
AR8263	R4346	C-CARBON R	RN72K1J-103JE	435031034R1	1
AR8263	R4347	C-CARBON R	RN72K1J-152JE	435031524R1	1
AR8263	R4348	C-CARBON R	RN72K1J-152JE	435031524R1	1
AR8263	R4349	C-CARBON R	RN72K1J-223JE	435032234R1	1
AR8263	R4350	C-CARBON R	RN72K1J-223JE	435032234R1	1
AR8263	R4351	C-CARBON R	RN72K1J-223JE	435032234R1	1
AR8263	R4352	C-CARBON R	RN72K1J-223JE	435032234R1	1
AR8263	R4353	C-CARBON R	RN72K1J-223JE	435032234R1	1
AR8263	R4354	C-CARBON R	RN72K1J-223JE	435032234R1	1
AR8263	R4355	C-CARBON R	RN72K1J-223JE	435032234R1	1
AR8263	R4356	C-CARBON R	RN72K1J-223JE	435032234R1	1
AR8263	R4357	C-CARBON R	RN72K1J-152JE	435031524R1	1
AR8263	R4358	C-CARBON R	RN72K1J-152JE	435031524R1	1
AR8263	R4359	C-CARBON R	RN72K1J-152JE	435031524R1	1
AR8263	R4360	C-CARBON R	RN72K1J-152JE	435031524R1	1
AR8263	R4369	C-CARBON R	RN72K1J-102JE	435031024R1	1
AR8263	R4370	C-CARBON R	RN72K1J-102JE	435031024R1	1
AR8263	R4371	C-CARBON R	RN72K1J-183JE	435031834R1	1
AR8263	R4372	C-CARBON R	RN72K1J-183JE	435031834R1	1
AR8263	R4373	C-CARBON R	RN72K1J-682JE	435036824R1	1
AR8263	R4374	C-CARBON R	RN72K1J-682JE	435036824R1	1
AR8263	R4401	C-CARBON R	RN72K1J-102JE	435031024R1	1
AR8263	R4403	C-CARBON R	RN72K1J-470JE	435034704R1	1
AR8263	R4404	C-CARBON R	RN72K1J-470JE	435034704R1	1
AR8263	R4405	C-CARBON R	RN72K1J-470JE	435034704R1	1
AR8263	R4406	C-CARBON R	RN72K1J-470JE	435034704R1	1
AR8263	R4407	C-CARBON R	RN72K1J-470JE	435034704R1	1
AR8263	R4408	C-CARBON R	RN72K1J-470JE	435034704R1	1
AR8263	R4409	C-CARBON R	RN72K1J-470JE	435034704R1	1

AR8263	R4410	C-CARBON R	RN72K1J-470JE	435034704R1	1
AR8263	R4411	C-CARBON R	RN72K1J-470JE	435034704R1	1
AR8263	R4412	C-CARBON R	RN72K1J-152JE	435031524R1	1
AR8263	R4413	C-CARBON R	RN72K1J-470JE	435034704R1	1
AR8263	R4416	C-CARBON R	RN72K1J-000JE	435030004R1	1
AR8263	R4421	C-CARBON R	RN72K1J-272JE	435032724R1	1
AR8263	R4422	C-CARBON R	RN72K1J-272JE	435032724R1	1
AR8263	R4423	C-CARBON R	RN72K1J-272JE	435032724R1	1
AR8263	R4424	C-CARBON R	RN72K1J-272JE	435032724R1	1
AR8263	R4425	C-CARBON R	RN72K1J-152JE	435031524R1	1
AR8263	R4426	C-CARBON R	RN72K1J-152JE	435031524R1	1
AR8263	R4427	C-CARBON R	RN72K1J-152JE	435031524R1	1
AR8263	R4428	C-CARBON R	RN72K1J-152JE	435031524R1	1
AR8263	R4429	C-CARBON R	RN72K1J-272JE	435032724R1	1
AR8263	R4430	C-CARBON R	RN72K1J-272JE	435032724R1	1
AR8263	R4431	C-CARBON R	RN72K1J-272JE	435032724R1	1
AR8263	R4432	C-CARBON R	RN72K1J-272JE	435032724R1	1
AR8263	R4433	C-CARBON R	RN72K1J-220JE	435032204R1	1
AR8263	R4434	C-CARBON R	RN72K1J-220JE	435032204R1	1
AR8263	R4435	C-CARBON R	RN72K1J-220JE	435032204R1	1
AR8263	R4436	C-CARBON R	RN72K1J-220JE	435032204R1	1
AR8263	R4437	C-CARBON R	RN72K1J-220JE	435032204R1	1
AR8263	R4438	C-CARBON R	RN72K1J-220JE	435032204R1	1
AR8263	R4439	C-CARBON R	RN72K1J-220JE	435032204R1	1
AR8263	R4440	C-CARBON R	RN72K1J-220JE	435032204R1	1
AR8263	R4441	C-CARBON R	RN72K1J-822JE	435038224R1	1
AR8263	R4442	C-CARBON R	RN72K1J-822JE	435038224R1	1
AR8263	R4443	C-CARBON R	RN72K1J-182JE	435031824R1	1
AR8263	R4444	C-CARBON R	RN72K1J-182JE	435031824R1	1
AR8263	R4445	C-CARBON R	RN72K1J-103JE	435031034R1	1
AR8263	R4446	C-CARBON R	RN72K1J-103JE	435031034R1	1
AR8263	R4447	C-CARBON R	RN72K1J-152JE	435031524R1	1
AR8263	R4448	C-CARBON R	RN72K1J-152JE	435031524R1	1

AR8263	R4449	C-CARBON R	RN72K1J-223JE	435032234R1	1
AR8263	R4450	C-CARBON R	RN72K1J-223JE	435032234R1	1
AR8263	R4451	C-CARBON R	RN72K1J-223JE	435032234R1	1
AR8263	R4452	C-CARBON R	RN72K1J-223JE	435032234R1	1
AR8263	R4453	C-CARBON R	RN72K1J-223JE	435032234R1	1
AR8263	R4454	C-CARBON R	RN72K1J-223JE	435032234R1	1
AR8263	R4455	C-CARBON R	RN72K1J-223JE	435032234R1	1
AR8263	R4456	C-CARBON R	RN72K1J-223JE	435032234R1	1
AR8263	R4457	C-CARBON R	RN72K1J-152JE	435031524R1	1
AR8263	R4458	C-CARBON R	RN72K1J-152JE	435031524R1	1
AR8263	R4459	C-CARBON R	RN72K1J-152JE	435031524R1	1
AR8263	R4460	C-CARBON R	RN72K1J-152JE	435031524R1	1
AR8263	R4469	C-CARBON R	RN72K1J-102JE	435031024R1	1
AR8263	R4470	C-CARBON R	RN72K1J-102JE	435031024R1	1
AR8263	R4471	C-CARBON R	RN72K1J-183JE	435031834R1	1
AR8263	R4472	C-CARBON R	RN72K1J-183JE	435031834R1	1
AR8263	R4473	C-CARBON R	RN72K1J-682JE	435036824R1	1
AR8263	R4474	C-CARBON R	RN72K1J-682JE	435036824R1	1
AR8263	R4501	C-CARBON R	RN72K1J-102JE	435031024R1	1
AR8263	R4503	C-CARBON R	RN72K1J-470JE	435034704R1	1
AR8263	R4504	C-CARBON R	RN72K1J-470JE	435034704R1	1
AR8263	R4505	C-CARBON R	RN72K1J-470JE	435034704R1	1
AR8263	R4506	C-CARBON R	RN72K1J-470JE	435034704R1	1
AR8263	R4507	C-CARBON R	RN72K1J-470JE	435034704R1	1
AR8263	R4508	C-CARBON R	RN72K1J-470JE	435034704R1	1
AR8263	R4509	C-CARBON R	RN72K1J-470JE	435034704R1	1
AR8263	R4510	C-CARBON R	RN72K1J-470JE	435034704R1	1
AR8263	R4511	C-CARBON R	RN72K1J-470JE	435034704R1	1
AR8263	R4512	C-CARBON R	RN72K1J-152JE	435031524R1	1
AR8263	R4513	C-CARBON R	RN72K1J-470JE	435034704R1	1
AR8263	R4516	C-CARBON R	RN72K1J-000JE	435030004R1	1
AR8263	R4521	C-CARBON R	RN72K1J-272JE	435032724R1	1
AR8263	R4522	C-CARBON R	RN72K1J-272JE	435032724R1	1

AR8263	R4523	G-CARBON R	RN72K1J-272JE	435032724R1	1
AR8263	R4524	G-CARBON R	RN72K1J-272JE	435032724R1	1
AR8263	R4525	G-CARBON R	RN72K1J-152JE	435031524R1	1
AR8263	R4526	G-CARBON R	RN72K1J-152JE	435031524R1	1
AR8263	R4527	G-CARBON R	RN72K1J-152JE	435031524R1	1
AR8263	R4528	G-CARBON R	RN72K1J-152JE	435031524R1	1
AR8263	R4529	G-CARBON R	RN72K1J-272JE	435032724R1	1
AR8263	R4530	G-CARBON R	RN72K1J-272JE	435032724R1	1
AR8263	R4531	G-CARBON R	RN72K1J-272JE	435032724R1	1
AR8263	R4532	G-CARBON R	RN72K1J-272JE	435032724R1	1
AR8263	R4533	G-CARBON R	RN72K1J-220JE	435032204R1	1
AR8263	R4534	G-CARBON R	RN72K1J-220JE	435032204R1	1
AR8263	R4535	G-CARBON R	RN72K1J-220JE	435032204R1	1
AR8263	R4536	G-CARBON R	RN72K1J-220JE	435032204R1	1
AR8263	R4537	G-CARBON R	RN72K1J-220JE	435032204R1	1
AR8263	R4538	G-CARBON R	RN72K1J-220JE	435032204R1	1
AR8263	R4539	G-CARBON R	RN72K1J-220JE	435032204R1	1
AR8263	R4540	G-CARBON R	RN72K1J-220JE	435032204R1	1
AR8263	R4541	G-CARBON R	RN72K1J-822JE	435038224R1	1
AR8263	R4542	G-CARBON R	RN72K1J-822JE	435038224R1	1
AR8263	R4543	G-CARBON R	RN72K1J-182JE	435031824R1	1
AR8263	R4544	G-CARBON R	RN72K1J-182JE	435031824R1	1
AR8263	R4545	G-CARBON R	RN72K1J-103JE	435031034R1	1
AR8263	R4546	G-CARBON R	RN72K1J-103JE	435031034R1	1
AR8263	R4547	G-CARBON R	RN72K1J-152JE	435031524R1	1
AR8263	R4548	G-CARBON R	RN72K1J-152JE	435031524R1	1
AR8263	R4549	G-CARBON R	RN72K1J-223JE	435032234R1	1
AR8263	R4550	G-CARBON R	RN72K1J-223JE	435032234R1	1
AR8263	R4551	G-CARBON R	RN72K1J-223JE	435032234R1	1
AR8263	R4552	G-CARBON R	RN72K1J-223JE	435032234R1	1
AR8263	R4553	G-CARBON R	RN72K1J-223JE	435032234R1	1
AR8263	R4554	G-CARBON R	RN72K1J-223JE	435032234R1	1
AR8263	R4555	G-CARBON R	RN72K1J-223JE	435032234R1	1

AR8263	R4556	C-CARBON R	RN72K1J-223JE	435032234R1	1
AR8263	R4557	C-CARBON R	RN72K1J-152JE	435031524R1	1
AR8263	R4558	C-CARBON R	RN72K1J-152JE	435031524R1	1
AR8263	R4559	C-CARBON R	RN72K1J-152JE	435031524R1	1
AR8263	R4560	C-CARBON R	RN72K1J-152JE	435031524R1	1
AR8263	R4569	C-CARBON R	RN72K1J-102JE	435031024R1	1
AR8263	R4570	C-CARBON R	RN72K1J-102JE	435031024R1	1
AR8263	R4571	C-CARBON R	RN72K1J-183JE	435031834R1	1
AR8263	R4572	C-CARBON R	RN72K1J-183JE	435031834R1	1
AR8263	R4573	C-CARBON R	RN72K1J-682JE	435036824R1	1
AR8263	R4574	C-CARBON R	RN72K1J-682JE	435036824R1	1
AR8263	R4601	C-CARBON R	RN72K1J-102JE	435031024R1	1
AR8263	R4603	C-CARBON R	RN72K1J-470JE	435034704R1	1
AR8263	R4604	C-CARBON R	RN72K1J-470JE	435034704R1	1
AR8263	R4605	C-CARBON R	RN72K1J-470JE	435034704R1	1
AR8263	R4606	C-CARBON R	RN72K1J-470JE	435034704R1	1
AR8263	R4607	C-CARBON R	RN72K1J-470JE	435034704R1	1
AR8263	R4608	C-CARBON R	RN72K1J-470JE	435034704R1	1
AR8263	R4609	C-CARBON R	RN72K1J-470JE	435034704R1	1
AR8263	R4610	C-CARBON R	RN72K1J-470JE	435034704R1	1
AR8263	R4611	C-CARBON R	RN72K1J-470JE	435034704R1	1
AR8263	R4612	C-CARBON R	RN72K1J-152JE	435031524R1	1
AR8263	R4613	C-CARBON R	RN72K1J-470JE	435034704R1	1
AR8263	R4616	C-CARBON R	RN72K1J-000JE	435030004R1	1
AR8263	R4621	C-CARBON R	RN72K1J-272JE	435032724R1	1
AR8263	R4622	C-CARBON R	RN72K1J-272JE	435032724R1	1
AR8263	R4623	C-CARBON R	RN72K1J-272JE	435032724R1	1
AR8263	R4624	C-CARBON R	RN72K1J-272JE	435032724R1	1
AR8263	R4625	C-CARBON R	RN72K1J-152JE	435031524R1	1
AR8263	R4626	C-CARBON R	RN72K1J-152JE	435031524R1	1
AR8263	R4627	C-CARBON R	RN72K1J-152JE	435031524R1	1
AR8263	R4628	C-CARBON R	RN72K1J-152JE	435031524R1	1
AR8263	R4629	C-CARBON R	RN72K1J-272JE	435032724R1	1

AR8263	R4630	C-CARBON R	RN72K1J-272JE	435032724R1	1
AR8263	R4631	C-CARBON R	RN72K1J-272JE	435032724R1	1
AR8263	R4632	C-CARBON R	RN72K1J-272JE	435032724R1	1
AR8263	R4633	C-CARBON R	RN72K1J-220JE	435032204R1	1
AR8263	R4634	C-CARBON R	RN72K1J-220JE	435032204R1	1
AR8263	R4635	C-CARBON R	RN72K1J-220JE	435032204R1	1
AR8263	R4636	C-CARBON R	RN72K1J-220JE	435032204R1	1
AR8263	R4637	C-CARBON R	RN72K1J-220JE	435032204R1	1
AR8263	R4638	C-CARBON R	RN72K1J-220JE	435032204R1	1
AR8263	R4639	C-CARBON R	RN72K1J-220JE	435032204R1	1
AR8263	R4640	C-CARBON R	RN72K1J-220JE	435032204R1	1
AR8263	R4641	C-CARBON R	RN72K1J-822JE	435038224R1	1
AR8263	R4642	C-CARBON R	RN72K1J-822JE	435038224R1	1
AR8263	R4643	C-CARBON R	RN72K1J-182JE	435031824R1	1
AR8263	R4644	C-CARBON R	RN72K1J-182JE	435031824R1	1
AR8263	R4645	C-CARBON R	RN72K1J-103JE	435031034R1	1
AR8263	R4646	C-CARBON R	RN72K1J-103JE	435031034R1	1
AR8263	R4647	C-CARBON R	RN72K1J-152JE	435031524R1	1
AR8263	R4648	C-CARBON R	RN72K1J-152JE	435031524R1	1
AR8263	R4649	C-CARBON R	RN72K1J-223JE	435032234R1	1
AR8263	R4650	C-CARBON R	RN72K1J-223JE	435032234R1	1
AR8263	R4651	C-CARBON R	RN72K1J-223JE	435032234R1	1
AR8263	R4652	C-CARBON R	RN72K1J-223JE	435032234R1	1
AR8263	R4653	C-CARBON R	RN72K1J-223JE	435032234R1	1
AR8263	R4654	C-CARBON R	RN72K1J-223JE	435032234R1	1
AR8263	R4655	C-CARBON R	RN72K1J-223JE	435032234R1	1
AR8263	R4656	C-CARBON R	RN72K1J-223JE	435032234R1	1
AR8263	R4657	C-CARBON R	RN72K1J-152JE	435031524R1	1
AR8263	R4658	C-CARBON R	RN72K1J-152JE	435031524R1	1
AR8263	R4659	C-CARBON R	RN72K1J-152JE	435031524R1	1
AR8263	R4660	C-CARBON R	RN72K1J-152JE	435031524R1	1
AR8263	R4669	C-CARBON R	RN72K1J-102JE	435031024R1	1
AR8263	R4670	C-CARBON R	RN72K1J-102JE	435031024R1	1

PCB NO.	CIRCUIT	PART NAME	DESCRIPTION	PART NO.	REMARKS
AR8263	R4671	G-CARBON R	RN72K1J-183JE	435031834R1	1
AR8263	R4672	G-CARBON R	RN72K1J-183JE	435031834R1	1
AR8263	R4673	G-CARBON R	RN72K1J-682JE	435036824R1	1
AR8263	R4674	G-CARBON R	RN72K1J-682JE	435036824R1	1
AR8263	X4001	CRYSTAL	XTL-13.5M	3010368R2	1
AR8263	X4002	CRYSTAL	FCX03-22.579MHZ	3010390R2	N 1
AR8263	X4003	CRYSTAL	FCX-03-24.576MHZ	3010385R2	N 1
DG8262	C3001	CHIP ELECT C	CEWX6.3V-100M	356721019R2	1
DG8262	C3003	G-CERA C	CK725F1A-105Z1	332181050R1	1
DG8262	C3004	CHIP ELECT C	CEWX4V-220M	3567A2219R2	1
DG8262	C3006	CHIP ELECT C	CEWX4V-220M	3567A2219R2	1
DG8262	C3007	G-CERA C	CK725F1A-105Z1	332181050R1	1
DG8262	C3008	G-CERA C	CK725F1A-105Z1	332181050R1	1
DG8262	C3009	G-CERA C	CK725F1A-105Z1	332181050R1	1
DG8262	C3010	G-CERA C	CK725F1A-105Z1	332181050R1	1
DG8262	C3011	G-CERA C	CK725F1A-105Z1	332181050R1	1
DG8262	C3012	G-CERA C	CK725F1A-105Z1	332181050R1	1
DG8262	C3013	G-CERA C	CK725F1A-105Z1	332181050R1	1
DG8262	C3014	G-CERA C	CK725F1A-105Z1	332181050R1	1
DG8262	C3015	G-CERA C	CK725F1A-105Z1	332181050R1	1
DG8262	C3016	CHIP ELECT C	CEWX4V-220M	3567A2219R2	1
DG8262	C3017	G-CERA C	CK725F1A-105Z1	332181050R1	1
DG8262	C3018	G-CERA C	CK725F1A-105Z1	332181050R1	1
DG8262	C3019	G-CERA C	CK725F1A-105Z1	332181050R1	1
DG8262	C3020	G-CERA C	CK725F1A-105Z1	332181050R1	1
DG8262	C3021	G-CERA C	CK725F1A-105Z1	332181050R1	1
DG8262	C3022	G-CERA C	CK725F1A-105Z1	332181050R1	1
DG8262	C3023	G-CERA C	CK725B1C-104K1	332121045R1	1
DG8262	C3024	G-CERA C	CK725B1C-104K1	332121045R1	1
DG8262	C3025	CHIP ELECT C	CEWX4V-220M	3567A2219R2	1
DG8262	C3026	G-CERA C	CK725F1A-105Z1	332181050R1	1

DG8262	C3027	G-CERA C	CC732CH1H-180J	347341804R1	1
DG8262	C3028	G-CERA C	CC732CH1H-150J	347341504R1	1
DG8262	C3029	G-CERA C	CK725F1A-105Z1	332181050R1	1
DG8262	C3030	G-CERA C	CK725F1A-105Z1	332181050R1	1
DG8262	C3031	CHIP ELECT C	CEWX4V-220M	3567A2219R2	1
DG8262	C3032	G-CERA C	CK725F1A-105Z1	332181050R1	1
DG8262	C3033	G-CERA C	CK725F1A-105Z1	332181050R1	1
DG8262	C3034	G-CERA C	CK725F1A-105Z1	332181050R1	1
DG8262	C3035	G-CERA C	CK725F1A-105Z1	332181050R1	1
DG8262	C3036	G-CERA C	CK725F1A-105Z1	332181050R1	1
DG8262	C3037	G-CERA C	CC725CH1E-102J1	342111024R1	1
DG8262	C3038	G-CERA C	CK725F1A-105Z1	332181050R1	1
DG8262	C3039	G-CERA C	CC725CH1E-102J1	342111024R1	1
DG8262	C3040	G-CERA C	CC725CH1E-102J1	342111024R1	1
DG8262	C3041	G-CERA C	CC725CH1E-102J1	342111024R1	1
DG8262	C3042	G-CERA C	CC725CH1E-102J1	342111024R1	1
DG8262	C3043	G-CERA C	CC725CH1E-102J1	342111024R1	1
DG8262	C3044	G-CERA C	CK725B1C-104K1	332121045R1	1
DG8262	C3045	G-CERA C	CK725F1A-105Z1	332181050R1	1
DG8262	C3046	G-CERA C	CK725F1A-105Z1	332181050R1	1
DG8262	C3047	G-CERA C	CK725F1A-105Z1	332181050R1	1
DG8262	C3049	G-CERA C	CC725CH1E-102J1	342111024R1	1
DG8262	C3050	G-CERA C	CC725CH1E-102J1	342111024R1	1
DG8262	C3051	G-CERA C	CK725B1C-104K1	332121045R1	1
DG8262	C3052	G-CERA C	CC732CH1H-221J	347342214R1	1
DG8262	C3053	G-CERA C	CC732CH1H-221J	347342214R1	1
DG8262	C3055	CHIP ELECT C	CEWX4V-220M	3567A2219R2	1
DG8262	C3056	G-CERA C	CK725F1A-105Z1	332181050R1	1
DG8262	C3057	CHIP ELECT C	CEWX4V-220M	3567A2219R2	1
DG8262	C3058	G-CERA C	CC725CH1E-102J1	342111024R1	1
DG8262	C3059	G-CERA C	CK725F1A-105Z1	332181050R1	1
DG8262	C3060	G-CERA C	CK725B1A-224K1	332132245R1	1
DG8262	C3061	G-CERA C	CC732CH1H-470J	347344704R1	1

DG8262	C3062	G-CERA C	CK725F1A-105Z1	332181050R1	1
DG8262	C3501	CHIP ELECT C	CEWX4V-220M	3567A2219R2	1
DG8262	C3502	G-CERA C	CK725F1A-105Z1	332181050R1	1
DG8262	C3503	G-CERA C	CK725F1A-105Z1	332181050R1	1
DG8262	C3504	G-CERA C	CK725F1A-105Z1	332181050R1	1
DG8262	C3505	G-CERA C	CK725F1A-105Z1	332181050R1	1
DG8262	C3509	G-CERA C	CK725F1A-105Z1	332181050R1	1
DG8262	C3510	G-CERA C	CK725F1A-105Z1	332181050R1	1
DG8262	C3511	G-CERA C	CK725F1A-105Z1	332181050R1	1
DG8262	C3512	G-CERA C	CK725F1A-105Z1	332181050R1	1
DG8262	C3514	G-CERA C	CK725B1C-104K1	332121045R1	1
DG8262	C3516	G-CERA C	CK725F1A-105Z1	332181050R1	1
DG8262	C3517	G-CERA C	CC732CH1H-180J	347341804R1	1
DG8262	C3518	G-CERA C	CC732CH1H-180J	347341804R1	1
DG8262	C3520	CHIP ELECT C	CEWX4V-220M	3567A2219R2	1
DG8262	C3521	G-CERA C	CK725F1A-105Z1	332181050R1	1
DG8262	C3523	CHIP ELECT C	CEWX6.3V-100M	356721019R2	1
DG8262	C3524	G-CERA C	CK725F1A-105Z1	332181050R1	1
DG8262	C3525	CHIP ELECT C	CEWX4V-220M	3567A2219R2	1
DG8262	C3526	G-CERA C	CK725F1A-105Z1	332181050R1	1
DG8262	C3527	G-CERA C	CK725F1A-105Z1	332181050R1	1
DG8262	C3530	CHIP ELECT C	CEWX50V-1M	356780109R2	1
DG8262	C3531	CHIP ELECT C	CEWX50V-1M	356780109R2	1
DG8262	C3532	CHIP ELECT C	CEWX50V-1M	356780109R2	1
DG8262	C3533	CHIP ELECT C	CEWX50V-1M	356780109R2	1
DG8262	C3534	CHIP ELECT C	CEWX50V-1M	356780109R2	1
DG8262	C3535	G-CERA C	CK725F1A-105Z1	332181050R1	1
DG8262	C3536	G-CERA C	CK725F1A-105Z1	332181050R1	1
DG8262	C3537	CHIP ELECT C	CEWX4V-220M	3567A2219R2	1
DG8262	E4002	HOLDER	(CLAMP)	27191220	N
DG8262	L3001	CORE	BLM41PG750SN1L	230950R2	N
DG8262	L3002	CORE	BLM41PG750SN1L	230950R2	N
DG8262	L3003	CORE	BLM41PG750SN1L	230950R2	N

DG8262	L3004	CORE	BLM41PG750SN1L	230950R2	N	1
DG8262	L3005	CORE	BLM41PG750SN1L	230950R2	N	1
DG8262	L3009	CORE	DLP11SN161SL2L	230977R2	N	1
DG8262	L3010	CORE	DLP11SN161SL2L	230977R2	N	1
DG8262	L3011	CORE	DLP11SN161SL2L	230977R2	N	1
DG8262	L3012	CORE	DLP11SN161SL2L	230977R2	N	1
DG8262	L3505	CORE	BLM41PG750SN1L	230950R2	N	1
DG8262	L3507	CHOKE COIL	BLM21B222SPT	230921R2		1
DG8262	L3508	CHOKE COIL	BLM21B222SPT	230921R2		1
DG8262	L3509	CHOKE COIL	BLM21B222SPT	230921R2		1
DG8262	L3510	CHOKE COIL	BLM21B222SPT	230921R2		1
DG8262	L3511	CORE	BLM41PG750SN1L	230950R2	N	1
DG8262	L3512	CORE	BLM41PG750SN1L	230950R2	N	1
DG8262	P1301B	PLUG	SM16B-SURS-TF	25056399R2	N	1
DG8262	P3002A	PLUG	NPLG-11P1108	25056169R2	N	1
DG8262	P3003	PLUG	NPLG-10P1107	25056168R2	N	1
DG8262	P3012	PLUG	NPLG-11P1108	25056169R2	N	1
DG8262	P3019	SOCKET	CSS5004-1062G	25053028R3	N	1
DG8262	P3020	SOCKET	CSS5004-1062G	25053028R3	N	1
DG8262	P3503	PLUG(B to B)	IMSA-9850B-22Y900	25056206R2	N	1
DG8262	P3506	SOCKET	NSCT-9P2277	25052379		1
DG8262	P3507	PLUG	NPLG-6P932	25055979R2		1
DG8262	P3509	PLUG	NPLG-6P932	25055979R2		1
DG8262	P3510	PLUG	NPLG-2P29	25055038		1
DG8262	P3511	PLUG	NPLG-7P933	25055980R2		1
DG8262	P3512	PLUG	NPLG-6P932	25055979R2		1
DG8262	P3513	PLUG	NPLG-2P29	25055038		1
DG8262	Q3001	IC	LM11117MPX-ADJ	22241648R2		1
DG8262	Q3004	IC	TSB43CA42PGF	22242061R3	N	1
DG8262	Q3005	IC	74AHC541PW	22274541ER2PH	N	1
DG8262	Q3006	IC	TC74VHC74FT	22274074ER2TO		1
DG8262	Q3007	IC	TC7SH08FU	22241830R2TO		1
DG8262	Q3008	IC	TC7SZ125FU	22241895R2		1

DG8262	Q3009	IC	TLC2932IPWLE	22242062R2	N	1
DG8262	Q3010	IC	TC7WT24IFU	22241546R2		1
DG8262	Q3011	IC	TC7WH24IFU	22242076R2TO	N	1
DG8262	Q3012	IC	74AHC541PW	22274541ER2PH	N	1
DG8262	Q3501	IC	MBM29LV800TA-90PFTN (0126)	NSP	N	1
DG8262	Q3502	IC	HD64F2367VF33(0095)	222W0008R300954	N	1
DG8262	Q3503	TR	DTC144EE	DISCON		
DG8262	Q3505	IC	TC7SH08FU	2216390R2		1
DG8262	Q3506	IC	TC7SH08FU	22241830R2TO		1
DG8262	Q3508	IC	LM11117MPX-ADJ	22241830R2TO		1
DG8262	Q3509	IC	MPD4721GS	22241830R2TO		1
DG8262	Q3511	IC	S-80127CNMC-JKM-T2	22241648R2		1
DG8262	R3001	G-CARBON R	RN72K1J-000JE	22241537R2		1
DG8262	R3002	G-CARBON R	RN72K1J-121FE	22241642R2		1
DG8262	R3003	G-CARBON R	RN72K1J-201FE	435030004R1		1
DG8262	R3004	G-R NET	RM7LJ220X04	435031212R1	N	1
DG8262	R3005	G-R NET	RM7LJ220X04	43484722004R2	N	1
DG8262	R3006	G-R NET	RM7LJ220X04	43484722004R2	N	1
DG8262	R3007	G-R NET	RM7LJ220X04	43484722004R2	N	1
DG8262	R3008	G-R NET	RM7LJ220X04	43484722004R2	N	1
DG8262	R3009	G-R NET	RM7LJ220X04	43484722004R2	N	1
DG8262	R3010	G-CARBON R	RN72K1J-220JE	435032204R1		1
DG8262	R3011	G-CARBON R	RN72K1J-220JE	435032204R1		1
DG8262	R3012	G-CARBON R	RN72K1J-103JE	435031034R1		1
DG8262	R3013	G-CARBON R	RN72K1J-103FE	435031032R1		1
DG8262	R3014	G-CARBON R	RN72K1J-103JE	435031034R1		1
DG8262	R3015	G-CARBON R	RN72K1J-103FE	435031032R1		1
DG8262	R3016	G-CARBON R	RN72K1J-103FE	435031032R1		1
DG8262	R3017	G-CARBON R	RN72K1J-103FE	435031032R1		1
DG8262	R3018	G-CARBON R	RN72K1J-103JE	435031034R1		1
DG8262	R3019	G-CARBON R	RN72K1J-103FE	435031032R1		1
DG8262	R3020	G-R NET	RM7LJ103X04	43484710304R2	N	1

DG8262	R3021	C-CARBON R	RN72K1J-103FE	435031032R1	1
DG8262	R3022	C-CARBON R	RN72K1J-000JE	435030004R1	1
DG8262	R3023	C-CARBON R	RN72K1J-000JE	435030004R1	1
DG8262	R3025	C-CARBON R	RN72K1J-000JE	435030004R1	1
DG8262	R3027	C-R NET	RM7LJ103X04	43484710304R2	N
DG8262	R3028	C-R NET	RM7LJ103X04	43484710304R2	N
DG8262	R3029	C-R NET	RM7LJ103X04	43484710304R2	N
DG8262	R3041	C-CARBON R	RN72K1J-103FE	435031032R1	1
DG8262	R3042	C-CARBON R	RN72K1J-220JE	435032204R1	1
DG8262	R3043	C-R NET	RM7LJ103X04	43484710304R2	N
DG8262	R3044	C-CARBON R	RN72K1J-220JE	435032204R1	1
DG8262	R3045	C-R NET	RM7LJ103X04	43484710304R2	N
DG8262	R3046	C-CARBON R	RN72K1J-220JE	435032204R1	1
DG8262	R3047	C-R NET	RM7LJ103X04	43484710304R2	N
DG8262	R3048	C-R NET	RM7LJ103X04	43484710304R2	N
DG8262	R3049	C-CARBON R	RN72K1J-103JE	435031034R1	1
DG8262	R3050	C-R NET	RM7LJ220X04	43484722004R2	N
DG8262	R3051	C-CARBON R	RN72K1J-103JE	435031034R1	1
DG8262	R3052	C-CARBON R	RN72K1J-103JE	435031034R1	1
DG8262	R3053	C-R NET	RM7LJ220X04	43484722004R2	N
DG8262	R3054	C-CARBON R	RN72K1J-103JE	435031034R1	1
DG8262	R3056	C-CARBON R	RN72K1J-103JE	435031034R1	1
DG8262	R3057	C-CARBON R	RN72K1J-103JE	435031034R1	1
DG8262	R3058	C-CARBON R	RN72K1J-103JE	435031034R1	1
DG8262	R3059	C-CARBON R	RN72K1J-000JE	435030004R1	1
DG8262	R3060	C-CARBON R	RN72K1J-220JE	435032204R1	1
DG8262	R3061	C-CARBON R	RN72K1J-220JE	435032204R1	1
DG8262	R3062	C-CARBON R	RN72K1J-103JE	435031034R1	1
DG8262	R3079	C-CARBON R	RN72K1J-103JE	435031034R1	1
DG8262	R3080	C-CARBON R	RN72K1J-220JE	435032204R1	1
DG8262	R3081	C-CARBON R	RN72K1J-220JE	435032204R1	1
DG8262	R3082	C-CARBON R	RN72K1J-103FE	435031032R1	1
DG8262	R3083	C-CARBON R	RN72K1J-153FE	435031532R1	1

DG8262	R3084	C-CARBON R	RN72K1J-102FE	435031022R1	1
DG8262	R3085	C-CARBON R	RN72K1J-000JE	435030004R1	1
DG8262	R3086	C-CARBON R	RN72K1J-103JE	435031034R1	1
DG8262	R3087	C-CARBON R	RN72K1J-103JE	435031034R1	1
DG8262	R3089	C-R NET	RM7LJ220X04	43484722004R2	N 1
DG8262	R3090	C-R NET	RM7LJ220X04	43484722004R2	N 1
DG8262	R3091	C-CARBON R	RN72K1J-220JE	435032204R1	1
DG8262	R3092	C-CARBON R	RN72K1J-220JE	435032204R1	1
DG8262	R3093	C-CARBON R	RN72K1J-000JE	435030004R1	1
DG8262	R3094	C-CARBON R	RN72K1J-000JE	435030004R1	1
DG8262	R3095	C-CARBON R	RN72K1J-000JE	435030004R1	1
DG8262	R3096	C-CARBON R	RN72K1J-102JE	435031024R1	1
DG8262	R3097	C-CARBON R	RN72K1J-220JE	435032204R1	1
DG8262	R3098	C-CARBON R	RN72K1J-102JE	435031024R1	1
DG8262	R3099	C-CARBON R	RN72K1J-000JE	435030004R1	1
DG8262	R3100	C-CARBON R	RN72K1J-000JE	435030004R1	1
DG8262	R3101	C-CARBON R	RN72K1J-560FE	435035602R1	1
DG8262	R3102	C-CARBON R	RN72K1J-560FE	435035602R1	1
DG8262	R3103	C-CARBON R	RN72K1J-560FE	435035602R1	1
DG8262	R3104	C-CARBON R	RN72K1J-512FE	435035122R1	1
DG8262	R3105	C-CARBON R	RN72K1J-560FE	435035602R1	1
DG8262	R3106	C-CARBON R	RN72K1J-512FE	435035122R1	1
DG8262	R3107	C-CARBON R	RN72K1J-560FE	435035602R1	1
DG8262	R3108	C-CARBON R	RN72K1J-560FE	435035602R1	1
DG8262	R3109	C-CARBON R	RN72K1J-222JE	435032224R1	1
DG8262	R3110	C-CARBON R	RN72K1J-560FE	435035602R1	1
DG8262	R3111	C-CARBON R	RN72K1J-560FE	435035602R1	1
DG8262	R3112	C-CARBON R	RN72K1J-000JE	435030004R1	1
DG8262	R3113	C-CARBON R	RN72K1J-220JE	435032204R1	1
DG8262	R3501	C-R NET	RM7LJ220X04	43484722004R2	N 1
DG8262	R3502	C-CARBON R	RN72K1J-472JE	435034724R1	1
DG8262	R3503	C-CARBON R	RN72K1J-472JE	435034724R1	1
DG8262	R3504	C-R NET	RM7LJ472X04	43484747204R2	N 1

DG8262	R3505	C-CARBON R	RN72K1J-220JE	435032204R1	N	1
DG8262	R3506	C-CARBON R	RN72K1J-220JE	435032204R1	N	1
DG8262	R3507	C-CARBON R	RN72K1J-220JE	435032204R1	N	1
DG8262	R3508	C-CARBON R	RN72K1J-220JE	435032204R1	N	1
DG8262	R3509	C-CARBON R	RN72K1J-220JE	435032204R1	N	1
DG8262	R3510	C-CARBON R	RN72K1J-220JE	435032204R1	N	1
DG8262	R3511	C-R NET	RM7LJ220X04	43484722004R2	N	1
DG8262	R3512	C-R NET	RM7LJ220X04	43484722004R2	N	1
DG8262	R3514	C-R NET	RM7LJ220X04	43484722004R2	N	1
DG8262	R3515	C-R NET	RM7LJ220X04	43484722004R2	N	1
DG8262	R3516	C-R NET	RM7LJ220X04	43484722004R2	N	1
DG8262	R3517	C-CARBON R	RN72K1J-000JE	435030004R1	N	1
DG8262	R3518	C-R NET	RM7LJ220X04	43484722004R2	N	1
DG8262	R3519	C-R NET	RM7LJ220X04	43484722004R2	N	1
DG8262	R3520	C-R NET	RM7LJ220X04	43484722004R2	N	1
DG8262	R3521	C-R NET	RM7LJ220X04	43484722004R2	N	1
DG8262	R3524	C-R NET	RM7LJ220X04	43484722004R2	N	1
DG8262	R3525	C-R NET	RM7LJ220X04	43484722004R2	N	1
DG8262	R3526	C-R NET	RM7LJ220X04	43484722004R2	N	1
DG8262	R3531	C-CARBON R	RN72K1J-220JE	435032204R1	N	1
DG8262	R3532	C-CARBON R	RN72K1J-220JE	435032204R1	N	1
DG8262	R3533	C-CARBON R	RN72K1J-000JE	435030004R1	N	1
DG8262	R3534	C-CARBON R	RN72K1J-103JE	435031034R1	N	1
DG8262	R3535	C-R NET	RM7LJ220X04	43484722004R2	N	1
DG8262	R3536	C-CARBON R	RN72K1J-472JE	435034724R1	N	1
DG8262	R3537	C-CARBON R	RN72K1J-472JE	435034724R1	N	1
DG8262	R3538	C-R NET	RM7LJ220X04	43484722004R2	N	1
DG8262	R3539	C-CARBON R	RN72K1J-472JE	435034724R1	N	1
DG8262	R3540	C-CARBON R	RN72K1J-181JE	435031814R1	N	1
DG8262	R3541	C-CARBON R	RN72K1J-220JE	435032204R1	N	1
DG8262	R3542	C-R NET	RM7LJ220X04	43484722004R2	N	1
DG8262	R3543	C-CARBON R	RN72K1J-472JE	435034724R1	N	1
DG8262	R3544	C-CARBON R	RN72K1J-000JE	435030004R1	N	1

DG8262	R3545	C-R NET	RM7LJ220X04	43484722004R2	N	1
DG8262	R3546	C-R NET	RM7LJ220X04	43484722004R2	N	1
DG8262	R3547	C-R NET	RM7LJ220X04	43484722004R2	N	1
DG8262	R3549	C-R NET	RM7LJ220X04	43484722004R2	N	1
DG8262	R3550	C-R NET	RM7LJ220X04	43484722004R2	N	1
DG8262	R3551	C-R NET	RM7LJ220X04	43484722004R2	N	1
DG8262	R3552	C-CARBON R	RN72K1J-121FE	435031212R1	N	1
DG8262	R3553	C-CARBON R	RN72K1J-201FE	435032012R1	N	1
DG8262	R3554	C-R NET	RM7LJ220X04	43484722004R2	N	1
DG8262	R3555	C-CARBON R	RN72K1J-472JE	435034724R1	N	1
DG8262	R3557	C-CARBON R	RN72K1J-103JE	435031034R1	N	1
DG8262	R3558	C-CARBON R	RN72K1J-472JE	435034724R1	N	1
DG8262	R3563	C-CARBON R	RN72K1J-220JE	435032204R1	N	1
DG8262	R3564	C-R NET	RM7LJ220X04	43484722004R2	N	1
DG8262	R3565	C-R NET	RM7LJ220X04	43484722004R2	N	1
DG8262	R3566	C-CARBON R	RN72K1J-472JE	435034724R1	N	1
DG8262	R3567	C-CARBON R	RN72K1J-000JE	435030004R1	N	1
DG8262	R3568	C-CARBON R	RN72K1J-000JE	435030004R1	N	1
DG8262	R3569	C-CARBON R	RN72K1J-222JE	435032224R1	N	1
DG8262	R3570	C-CARBON R	RN72K1J-222JE	435032224R1	N	1
DG8262	R3571	C-CARBON R	RN72K1J-472JE	435034724R1	N	1
DG8262	R3574	C-CARBON R	RN72K1J-103JE	435031034R1	N	1
DG8262	R3575	C-CARBON R	RN72K1J-103JE	435031034R1	N	1
DG8262	R3576	C-CARBON R	RN72K1J-103JE	435031034R1	N	1
DG8262	R3577	C-CARBON R	RN72K1J-103JE	435031034R1	N	1
DG8262	X3001	CRYSTAL	FCX-03-24.576MHZ	3010385R2	N	1
DG8262	X3501	CRYSTAL	FCX-03-16.000MHZ	3010384R2	N	1
DG8257	P001	PWB	NCDDG-8257	25138257B		1
VD8258	P002	PWB	NCVD-8258	25138258D	N	1
VD8258	P011	PWB	NCDDG-8259	25138259	N	(1)
VD8258	P012	PWB	NCETC-8260	25138260	N	(0)
VD8258	P012	PWB	NCETC-8260	25138260	UDDIN	(1)

VD8258	P012	PWB	NCETC-8260	25138260	UPA4P	{1}
VD8258	P013	PWB	NCETC-8261	25138261	N	{0}
VD8258	P014	PWB	NCPS-8274	25138274	N	{1}
DIS8264	P001	PWB	NCDIS-8264	25138264C	N	{1}
DIS8264	P002	PWB	NCVD-8265	25138265	N	{0}
DIS8264	P002	PWB	NCVD-8265	25138265		{1}
DIS8264	P003	PWB	NCAP-8266	25138266	N	{1}
DIS8264	P004	PWB	NCSSW-8267	25138267	N	{1}
DIS8264	P005	PWB	NCDDG-8268	25138268	N	{0}
DIS8264	P005	PWB	NCDDG-8268	25138268		{0}
PS8269	P004	PWB	NCPS-8269	25138269B	N	1
UDDIN	P006	PWB	NCSSW-8271	25138271		{0}
UPA4P	P006	PWB	NCSSW-8271	25138271	N	{0}
PS8269	P005	PWB	NCPS-8270	25138270	N	{1}
DG8272	P0010	PWB	NCVD-8273	25138273		{0}
DG8272	P005	PWB	NCDDG-8272	25138272B	N	1
AR8263	P001	PWB	NCAR-8263	25138263C	N	1
AR8263	P002	PWB	NCDDG-8262	25138262	N	{0}
DG8262	P002	PWB	NCDDG-8262	25138262B	N	1

EXPLODED VIEW PARTS LIST

DPS-10.5

REF. NO.	PART NAME	DESCRIPTION	PART NO.	REMARKS
A01	CHASSIS	--	27100441A	
A02	REAR PANEL	UDDIN	27123211A	N<DDIN>
A02	REAR PANEL	UPA4P	27123212A	N<PA4P>
A03	RETAINER	(SIDE)	27141888	
A05	SCREW	USUATAMA3*8	801613	
A04	SCREW	3TTB+8B(BC)	838430088	
A06	SCREW	3P+6FN(BC)	82143006	
A07	RETAINER	(PC)	27141889	
A08	SCREW	M1.6*6(BC)	82141606	
A09	SCREW	3TTB+8B(CU)	801612	
A10	F PANEL AS	(B)UDDDPS-10.5	27212603A	N
A11	BRACKET	(C)	27130915A	
A12	CLAMP	WS-2NS	27300833	
A13	SCREW	3TTB+8B(BC)	838430088	
A14	CUSHION	(SCREW)	28141420	
A15	BRACKET	(F)	27130916B	
A16	SHEET	(F.BRA)	27150495	
A17	HOLDER	(CLAMP)	27191220	
A19	SCREW	3TTB+8B(BC)	838430088	
A21	BRACKET	(R)	27130917A	
A23	RETAINER	(CHA)	27141890	
A27	RETAINER	(HEAT)	27141770-1	
A31	RETAINER	(R)	27141891	
A35	BUSHING	--	28170070	
A37	BUSHING	L162	28170082	
A39	BUSHING	L130	28170079	
A41	BUSHING	L40	28170080	
A43	BUSHING	L18.5	28170081	
A44	SHLD PLT	(FPC)	27150492	
A45	HOLDER	KGLS-12RT	27190266	
A47	HOLDER	KGLS-18RT	27190657	
A49	HOLDER	KGLS-22S	27190369	
A50	HOLDER	KGLS-4S	27190009	
A51	RETAINER	(MPWB)	27141892A	
A53	SCREW	3TTB+8B(CU)	801612	
A55	SCREW	3P+6FN(BC)	82143006	
A57	SCREW	4TTG+8C(BC)	830440089	
A58	SCREW	3TTG+8B(CU)	830030088	
A60	SCREW	3SMH10W.SW+15B(CU)	801606	

N: New part, I: Safety part

A63	RETAINER	(PCALL1)	27141893	2
A65	RETAINER	(PCALL2)	27141894	1
A67	CUSHION	T4L100D10	28141565	3
A71	SCREW	3TTB+8B(CU)	801612	6
A73	BOTTOM BRD	--	27170334A	1
A77	BOTTOM LEG	(AS)	27175400	4
A79	CUSHION	--	28141559	4
A80	CUSHION	(LEG)	28141591	1
A81	SCREW	4TTC+10C(BC)	830440109	4
A83	S PANEL(L)	(B)	27212571A	1
A85	S PANEL(R)	(B)	27212575A	1
A87	RETAINER	(COVER)	27141895A	2
A89	SCREW	USUATAMA3*8	801613	4
A91	SCREW	RCTK4*10(BC)	801616A	8
A93	COVER	(B)	28184879A	1
A95	CUSHION	T4L20D10	28141566	9
A97	SCREW	RCTK4*10(BC)	801616A	7
A101	CUSHION	--	28141409A	1
A201	DOOR	--	28148567	1
A203	SCREW	2.6TTB+8B(BC)	838426088	2
	SCREW	2.6TTB+8B(BC)	838426088	2
	SCREW	2.6TTB+8B(BC)	838426088	2
	SCREW	2.6TTB+8B(BC)	838426088	2
A205	PLATE	(DOOR)	27262704	1
A207	BRACKET	(MECHA)	27130845	1
A211	SLIDER	--	27220063	1
A213	END CAP	(MECHABOX-L)	28125388	1
A217	END CAP	(MECHABOX-R)	28125389	1
A221	SPACER	(MARU)	27270425	4
A227	TAPE	(CU)	29110168	2
A301	CLEAR PLT	--	28192013A	1
A303	KNOB	(ST)AS10.5	28326116	1
A317	KNOB	(FP)AS	28325842	1
A323	KNOB	(GUIDE-PLAY)	28325844	1
A325	KNOB	(PLAY)AS	28325843A	3
A401	END CAP	(L)(B)	28125400A	1
A403	END CAP	(R)(B)	28125403A	1
A405	BADGE	(Integral)	28135296	1
A406	STOPPER	SPN-1.5	890035	2
A407	BADGE	VIDEO/AUDIO(B)	28135291A	1
A409	BADGE	(SACD)	28135288A	1
A411	FACET	(7)	28198977	1
A413	GUIDE	(VC)10.5(B)	27268088	1

A415	SCREW	3TTB+8B(CU)	801612		3
A417	SCREW	3P+6FN(BC)	82143006		8
A421	WIRE TIE	BSK-1	260208		10
A423	SCREW	4TTB+8C(BC)	838440089		2
A425	LABEL	(PT)10.5	29363647	N	1
A427	LABEL	LABEL,Flash	29360778		2
A429	BUSHING	CE-016 100MM	28170039		1
A609	TAPE	CLOTH-8U	29110082-1		1
A611	TAPE	TAPE (CLOTH-16U)	29110083-1		1
A613	ANTI VIB	15 x 5 x 3	24847051		1
A615	ANTI VIB	8 x 5 x 3	24847052		3
A617	SHEET	(PAPER)	29095972		1
A619	SPACER	--	27270439		1
A621	SPACER	10.5 x ϕ 8 x ϕ 3.2	27270438		1
A623	CUSHION	75 x 10 x 10.75	28141602		1
A625	CUSHION	(BUTYL) 10.8 x 10 x 10	28141552		4
A999	SPACER	--	27270443		2
E1001	CLIP	CS-1U	27255004		5
F001	FUSE	1.6A-UL/T-237	252158	! <DD1N>	1
F001 or	FUSE	1.6A-T/UL-ST2	252252	! <DD1N>	(1)
F001	FUSE	2.5A-SE-EAK FUSE	252075	! <PA4P>	1
F001 or	FUSE	2.5A-SE-TL250V	252275	! <PA4P>	(1)
F9001	FUSE	2.5A-UL/T-237	252160	! <DD1N>	1
F9001 or	FUSE	2.5A-T/UL-ST2	252254	! <DD1N>	(1)
F9001	FUSE	2.5A-SE-EAK FUSE	252075	! <PA4P>	1
F9001 or	FUSE	2.5A-SE-TL250V	252275	! <PA4P>	(1)
L901	CORE	TFCK-23-11-14	230923		1
L902	CORE	ESD-R-19DB	230983	N	1
L903	CORE	ESD-R-19DB	230983	N	1
L904	CORE	ESD-R-19DB	230983	N	1
L905	CORE	ESD-R-19DB	230983	N	1
P1001A	FFC	NCPCD-26003	204D26003		1
P1101A	SOCKET AS	NSAS-12P0829	20022261220		1
P1301	SOCKET AS	NSAS-32P1325	200KK503240UL		1
P1302	SOCKET AS	NSAS-40P1296	200KK584035UL		1
P2001	SOCKET AS	NSAS-28P1291	200KK582820UL		1
P2002	SOCKET AS	NSAS-30P1290	200KK583020UL		1
P2003	SOCKET AS	NSAS-40P1324	200KK504020UL		1
P2004	SOCKET AS	NSAS-32P1289	200KK583225UL		1
P2701	SOCKET AS	NSAS-14P1319	20022391435UL		1
P2901	SOCKET AS	NSAS-12P1272	20044191220UL		1
P3002	SOCKET AS	NSAS-22P1413	200J1392250UL	N	1
P4003	SOCKET AS	NSAS-8P1389	2009990896UL	N	1

P4005	SOCKET AS	NSAS-10P1321	2009990872UL	N	1
P4008	SOCKET AS	NSAS-10P1273	20044191050UL		1
P4202	SOCKET AS	NSAS-30P1387	200J393015UL	N	1
P4203	SOCKET AS	NSAS-28P1388	200J392815UL	N	1
P4571	SOCKET AS	NSAS-16P1297	200J391625UL		1
P4950	SOCKET AS	NSAS-14P1323	20044191415UL		1
P5402	SOCKET AS	NSAS-20P1279	200J392030UL		1
P6005	SOCKET AS	NSAS-16P1344	200J391620UL		1
P6551	SOCKET AS	NSAS-18P1345	2009990880UL		1
P6703	SOCKET AS	NSAS-20P1280	200J392010UL		1
P7010	SOCKET AS	NSAS-8P1285	200J390830UL		1
P7201	FFC	NCFC4-26043	204426043	N	1
P9102	SOCKET AS	NSAS-16P1271	20044191615UL		1
P9103	SOCKET AS	NSAS-8P1274	20044190840UL		1
P9104	SOCKET AS	NSAS-22P1269	20044192210UL		1
P9601	SOCKET AS	NSAS-24P1268	20044192445UL		1
P9602	SOCKET AS	NSAS-28P1275	20044192845UL		1
P9604	SOCKET AS	NSAS-30P1341	20044193005UL		1
T901	P TRANS	NPT-1489D	2301731	! <DD1N>	1
T901	P TRANS	NPT-1489P	2301732	! <PA4P>	1
U01	DVD Main board AS	NADG-8257-1A	IH516557-1A		1
U02	Video output terminal board AS	NAVD-8258-1M	IH516558-1M	N <DD1N>	1
U02	Video output terminal board AS	NAVD-8258-1N	IH516558-1N	N <PA4P>	1
U03	DVD Main CPU PC board AS	NADG-8259-1M	IH516559-1M	N <DD1N>	1
U03	DVD Main CPU PC board AS	NADG-8259-1N	IH516559-1N	N <PA4P>	1
U04	Component output terminal PC board AS	NAETC-8260-1M	IH516560-1M	N <DD1N>	1
U04	Component output terminal PC board AS	NAETC-8260-1N	IH516560-1N	N <PA4P>	1
U06	Power supply PC board-3 AS	NAPS-8274-1M	IH516574-1M	N <DD1N>	1
U06	Power supply PC board-3 AS	NAPS-8274-1N	IH516574-1N	N <PA4P>	1
U07	Display circuit PC board AS	NADIS-8264-1H	IH516564-1H	N	1
U08	Component/ D-terminal PC board AS	NAVD-8265-1H	IH516565-1H	N	1
U09	Audio output PC board AS	NAAF-8266-1H	IH516566-1H	N	1
U10	JOG switch PC board AS	NASW-8267-1H	IH516567-1H	N	1
U12	Power supply PC board-1 AS	NAPS-8269-1G	IH516569-1G	N <DD1N>	1
U12	Power supply PC board-1 AS	NAPS-8269-1J	IH516569-1J	N <PA4P>	1
U13	Power supply PC board-2 AS	NAPS-8270-1G	IH516570-1G	N <DD1N>	1
U13	Power supply PC board-2 AS	NAPS-8270-1J	IH516570-1J	N <PA4P>	1
U15	Digital video processor PC board AS	NADG-8272-1C	IH516572-1C		1
U16	Video input terminal PC board AS	NAVD-8273-1C	IH516573-1C		1
U18	Audio DAC PC board AS	NAAR-8263-1D	IH516563-1D	N	1
U20	IEEE1394 terminal PC board AS	NADG-8262-1	IH516562-1		1
U21	Power supply unit	NGPS-0036-100-120V	24150036	! <DD1N>	1
U21	Power supply unit	NGPS-0037-100-240V	24150037	! <PA4P>	1

Z701	SCREW	3TTW+8B(BC)	831430088	4
	DVD M	KHM-280AAA	24801016	1
Z711	LOADER MACHA	MGD-33	24801022	1
Z712	HOLDER	(PU)	24826029	1
			Mecha view	
Z713	WASHER	W2.6X7.5	87760309	2
Z714	ST SCREW	2.6TTB+6B(BC)	838426068	2
Z715	INSULATOR	(A)	24818055	2
			Ref to Exp. Mecha view	
Z716	INSULATOR	(C)	24818061	2
			Ref to Exp. Mecha view	
Z717	CUSHION	(MARU)	28141584	2
			Ref to Exp. Mecha view	
Z720	SCREW	(A)	801589	4
			Ref to Exp. Mecha view	
Z722	TAPE	TAPE(CLOTH-16L)	29110083	1
			Ref to Exp. Mecha view	
Z723	CUSHION	CUSHION	28140803	1
Z725	LABEL(DVD2)	--	29362648	1
Z727	CUSHION	T4L100D10	28141565	1

PACKING VIEW PARTS LIST

DPS-10.5

REF. NO.	PART NAME	DESCRIPTION	PART NO.	REMARKS
A501	PAD	(AS)	29092145	
A502	CARTON	10.5	29054149	N
A505	UPC LABEL	DPS-10.5	29363626	N <DDIN>
A505	EAN LABEL	DPS-10.5	29363622	N <PA4P>
A506	CASE	--	29105220	
A507	LABEL	UPA4P	29363233	<PA4P>
A509	SHEET	--	29095847	
A513	TAPE	NITTO NO.29	29110149	
A515	TAPE	NITTO 3703 W50L100	29110176	
A601	POLY BAG	350*250	29100097-1A	
A602	WRNTY CARD	(INTEGRA)	29365089A	<DDIN>
E301	PIN CORD AS	RCA3PYWRJ1.5MT	2010388	
E302	CORD AS	MINIDIN4P1.5MT	2010389	
E303	REMO CON	RC-562DV	24140562	N
E305	CORD AS	IEEE1394 1.0M	2010430	
E306	CORD AS	HDMI 1.5M	2010429	
E307	BATTERY	LR6/AA(UM-3)	3010358	
A607	POLY BAG, Battery	40.1*70*100	29100217	
E308	CORD AS	3.5-MINI PLUG	2010375	
E308 or	CORD AS	RI CORD	2010397	
E311	LABEL	(PE-LD)	29361573	
E901	AC CORD	AS-UC-2	253301HT	1 <DDIN>
E901	AC CORD	AS-SAA	253391VOL	1 <PA4P>
E001	INS MANUAL	Em(DPS-10.5)	29343659	N
E006	INST SHEET	Em	29355487B	
E010	INST SHEET	Em	29355502	

N: New part, I: Safety part

(1)

Integra Division of
ONKYO CORPORATION
Sales & Product Planning Div. : 2-1, Nisshin-cho, Neyagawa-shi, OSAKA 572-8540, JAPAN
Tel: 072-831-8023 Fax: 072-831-8124 <http://www.onkyo.com/>

Integra Division of
ONKYO U.S.A. CORPORATION
18 Park Way, Upper Saddle River, N.J. 07458, U.S.A.
Tel: 201-785-2600 Fax: 201-785-2650 <http://www.integrahometheater.com>