

ONKYO SERVICE MANUAL

COMPACT DISC AUTOMATIC CHANGER

MODEL DX-C200

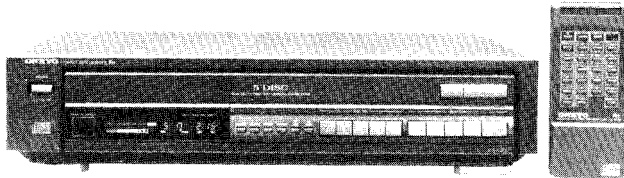

MODEL DX-C100

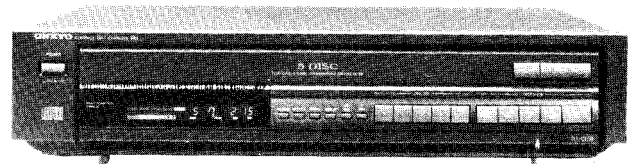

SAFETY-RELATED COMPONENT WARNING!!

COMPONENTS IDENTIFIED BY MARK  ON THE SCHEMATIC DIAGRAM AND IN THE PARTS LIST ARE CRITICAL FOR RISK OF FIRE AND ELECTRIC SHOCK. REPLACE THESE COMPONENTS WITH ONKYO PARTS WHOSE PART NUMBERS APPEAR AS SHOWN IN THIS MANUAL.

MAKE LEAKAGE-CURRENT OR RESISTANCE MEASUREMENTS TO DETERMINE THAT EXPOSED PARTS ARE ACCEPTABLY INSULATED FROM THE SUPPLY CIRCUIT BEFORE RETURNING THE APPLIANCE TO THE CUSTOMER.

SPECIFICATIONS

■ Audio

No. of channels:	2 (left and right, stereo)
Frequency response:	2-20,000 Hz \pm 1 dB
Output voltage:	2V (at 0 dB)
Dynamic range:	94 dB
S/N ratio:	96 dB
Total harmonic distortion:	0.05% (1kHz, 0 dB)
Wow and flutter:	Below measurable limit
Output impedance:	1k Ω
Load impedance:	More than 10k Ω

■ Signal Format

Sampling frequency:	176.4kHz
D-A conversion:	16-bit linear

■ Pickup

Wavelength:	
-------------	---

■ General

Power supply:	AC 60 Hz, 120V
Power consumption:	13W
Dimensions (W×H×D):	435×102.5×374 mm (17 $\frac{1}{8}$ "×4"×14 $\frac{1}{16}$ ")
Weight:	6.5 kg (14.3 lbs)

Specifications are subject to change without notice.

ONKYO
AUDIO COMPONENTS

BEFORE USE

To release the transport lock

The optical pickup is secured to prevent damage during transport. Be sure to release it before use.

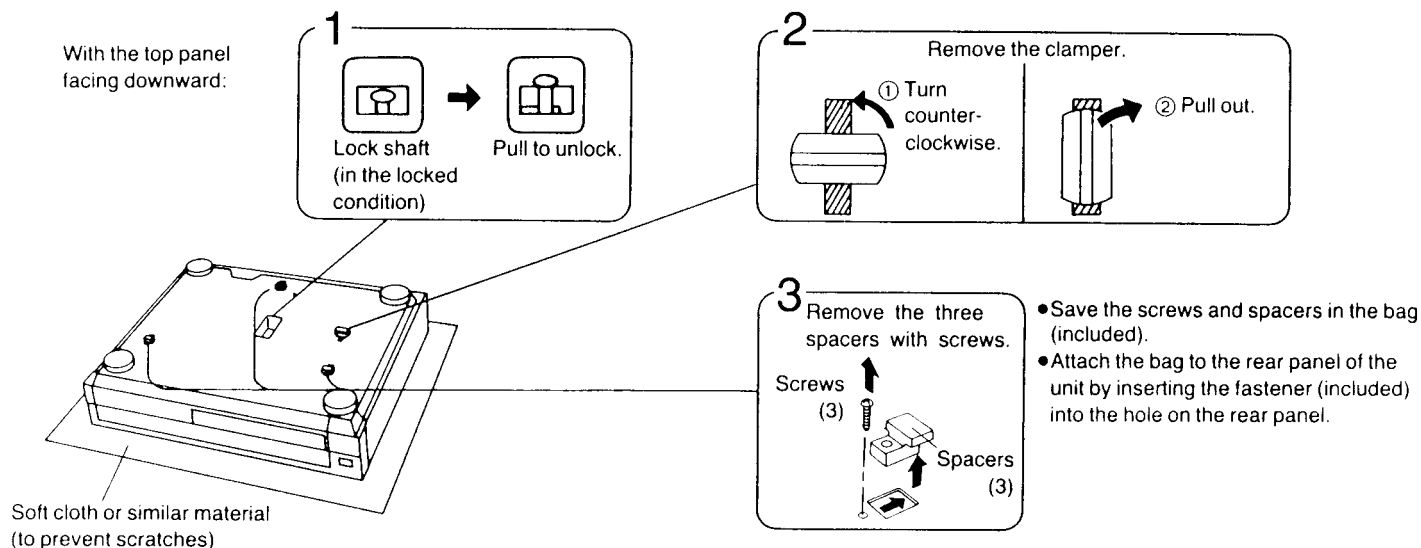

Before transporting the unit

Be sure to lock the optical pickup according to the procedures below:

- ① Turn the power on and remove all discs from the trays.
- ② Close the loading drawer and turn the power off.
- ③ Place the unit with the top panel facing downward.
- ④ Insert the three spacers into the slots and secure them with the three screws.
- ⑤ Insert the clamber into the slot and turn it clockwise.
- ⑥ Place the unit with the right panel facing downward, and press the lock shaft to the Lock position (■ → ■).

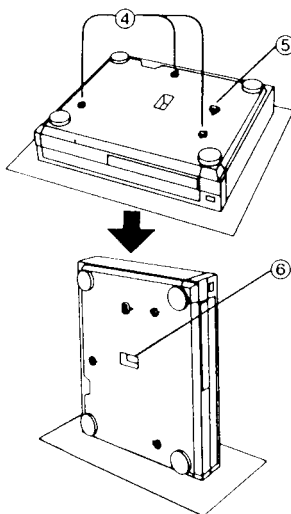

CAUTION:

- Do not transport the unit without locking the optical pickup. **SEVERE DAMAGE WILL RESULT.**
- Before tilting or transporting the unit, be sure to remove all discs from the trays. Otherwise, discs may possibly be fallen into the unit and can not be taken out.

Placement notes

- Place on a flat, level surface so that the front-rear inclination does not exceed 5°.
- Avoid places such as the following:
 - Near any equipment or device that generates strong magnetism.
 - On any heat-generating equipment or device, or in any place where the temperature is high (40°C <104°F> or higher).
 - Extremely cold places (5°C <41°F> or below).
 - Near a tuner or TV (It may cause noise in the broadcast, or disturbance of the TV picture.)
 - For long periods of time in direct sunlight.
 - In dusty or smoky locations.
 - In locations prone to vibrations.
 - In locations where the rear panel is less than 10 cm (about 4") away from the wall or back of an audio rack.
 - Within reach of children.
- Do not place heavy objects, other than system components, on top of the unit.
- When carrying or storing the unit, handle it with care so it is not subjected to any strong bumps. Always remove the disc before storing the unit for any period of time.
- To avoid problems due to vibration.
 - Do not place a book or similar object under this unit.
 - Do not route the connection cables (of this or other units) across the operation panel, across the top, or under the unit.
- Do not push down on the loading drawer while it is opened. This may cause the unit to fall.

HANDLING PRECAUTIONS FOR OPTICAL PICKUP

The laser diode in the optical pickup may break down due to potential difference caused by static electricity of clothes or human body.

So, be careful of electrostatic breakdown during repair of the optical pickup.

• Handling of optical pickup

1. Do not subject the optical pickup to static electricity as it is extremely sensitive to electrical shock.
2. To prevent the breakdown of the laser diode, an anti-static shorting pin is inserted into the flexible board. (FPC board)
When removing or connecting the short pin, finish the job in as short time as possible.
3. Take care not to apply excessive stress to the flexible board. (FPC board)
4. Do not turn the variable resistor (laser power adjustment). It has already been adjusted.

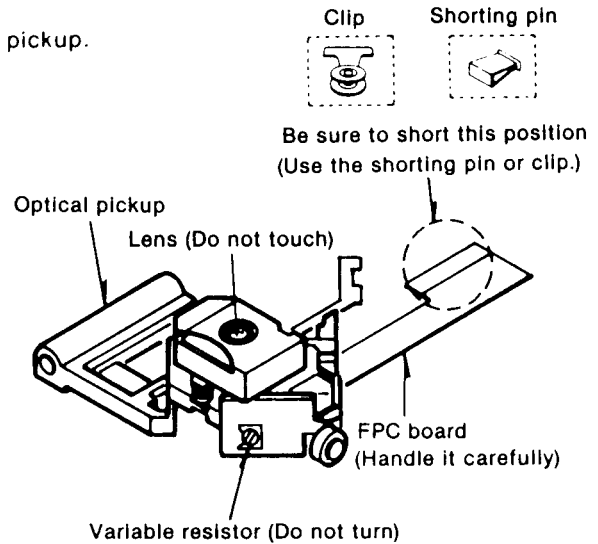

• Grounding for electrostatic breakdown prevention

1. Human body grounding
Use the anti-static wrist strap to discharge the static electricity from your body.
2. Work table grounding
Put a conductive material (sheet) or steel sheet on the area where the optical pickup is placed, and ground the sheet.

Caution:

The static electricity of your clothes will not be grounded through the wrist strap. So, take care not to let your clothes touch the optical pickup.

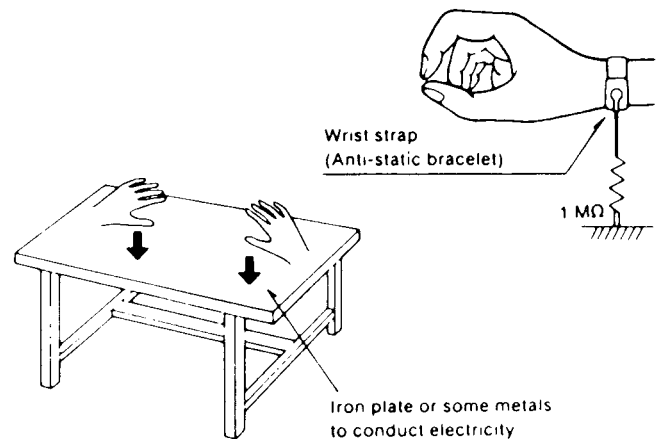

INSTRUCTIONS FOR TRAVERSE OIL

The container contains 6g (approx. 3ml) of oil.
One application (one shaft) uses 0.05ml of oil.

How to Use

- (1) Remove the guide shaft in the traverse deck from the optical pickup and clean off any dust from the guide shaft.
- (2) Apply one drop of the SZZOL31 to the tip of the guide shaft.
- (3) Hold the guide shaft so that its oiled end touches the optical pickup and insert it into the bearing while rotating it slowly.
- (4) After securing the guide shaft, move the optical pickup by hand several times to the left and right to distribute the oil on the guide shaft.

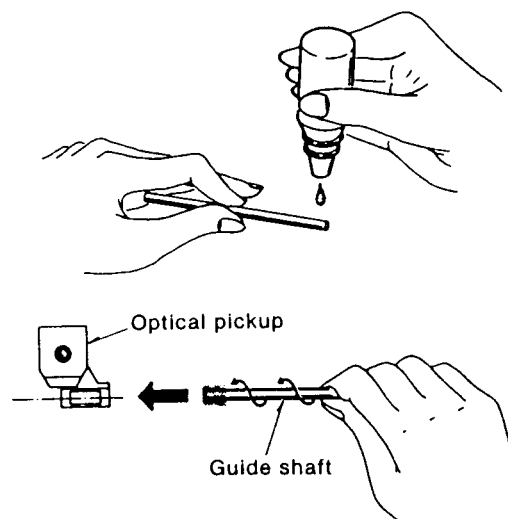

"ATTENTION SERVICER"

Some chassis components may have sharp edges. Be careful when disassembling and servicing.

BLOCK DIAGRAM

DIGITAL SIGNAL PROCESSING

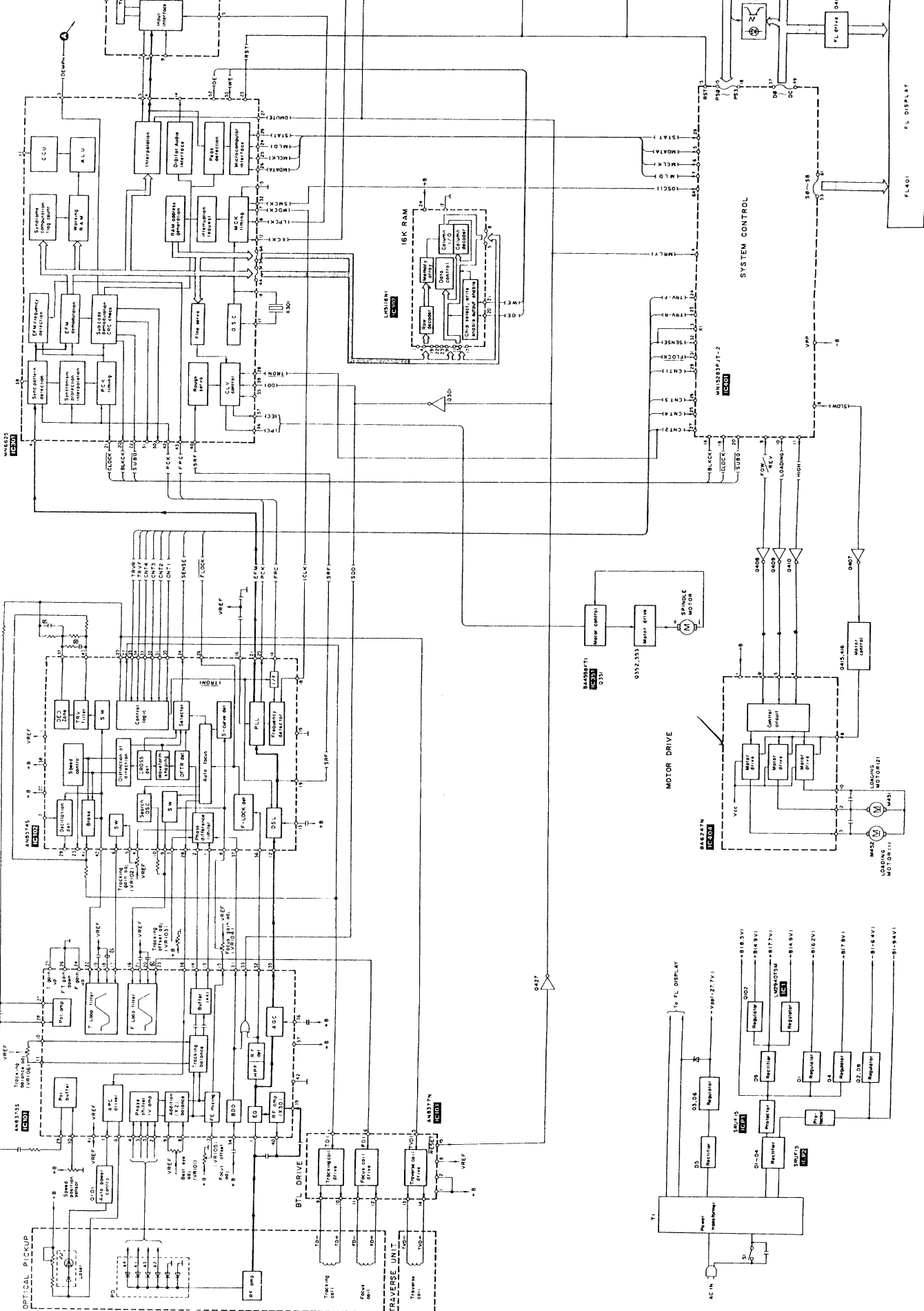

SERVO PROCESSOR

SERVO AMP

MOTOR DRIVE

SYSTEM CONTROL

PRINTED CIRCUIT BOARD—PARTS LIST

MAIN PC BOARD – PARTS LIST

CIRCUIT NO.	PART NO.	DESCRIPTION
ICs		
IC1	22240346	LM2940T5M
IC2	22240347	M51953BFP
IC301	22240348	MN6625
IC302	22240349	LH5116N1
IC351	22240350	BA4558F
IC401	22240351	MN15283PJT-2
IC403	22240352	MN15522PKE
IC404	22240353	BA6247N
IC801	22240354	SM5807ESE
IC802	22240355	LC7881B
IC803,IC804	22240350	BA4558F
IC protectors		
ICP1,ICP2	252122	△SRUF15
Transistors		
Q1	2213783 or 2213784	2SD1862-Q or 2SD1862-R
Q2	2213793 or 2213794	2SB1240-Q or 2SB1240-R
Q3	2213803, 2213804 or 2213805	2SB1238-Q, 2SB1238-R or 2SB1238-S
Q301	226037	UN4212
Q351	226036	UN4112
Q352	2213783 or 2213784	2SD1862-Q or 2SD1862-R
Q353	2213793 or 2213794	2SB1240-Q or 2SB1240-R
Q401-Q406	226037	UN4212
Q407-Q410	226036	UN4112
Q411-Q413	2201903	2SA1309-Q
Q415,Q416,	226037	UN4212
Q417	2201903	2SA1309-Q
Q419,Q420	2201903	2SA1309-Q
Q422	226037	UN4212
Q423	2201903	2SA1309-Q
Q427	226036	UN4112
Q801,Q802	2201893	2SC3311-Q
Q803,Q804	2213814, 2213815 or 2213816	2SD1450-R, 2SD1450-S or 2SD1450-T
Q805,Q807	226036	UN4112
Q808,Q809	226037	UN4212
FL tube		
F1.401	212085	RSL0047-F
Diodes		
D1-D5	223192	△1SR35200TB, Silicon
D6	224452702	MTZ27B, Zener
D7,D8	224450682	MTZ6.8B, Zener
D9	223192	△1SR35200TB, Silicon
D10	224450622	MTZ6.2B, Zener
D12	223193	MA723, Silicon
D351,D352	224450512	MTZ5.1B, Zener
D401-D408	223163	1SS133, Silicon
D410-D416	223163	1SS133, Silicon
D417	224450302	MTZ3.0B, Zener
D418	224450332	MTZ3.3B, Zener
D419-D425	223163	1SS133, Silicon
D801-D803	223163	1SS133, Silicon
D805,D806	223163	1SS133, Silicon
D830	224450362	MTZ3.6B, Zener
Coils		
L401,L403	231177	RLQZP3R3K
L451	231177	RLQZP3R3K
L454-L457	231177	RLQZP3R3K
L460,L461	231177	RLQZP3R3K
X'tal		
X301	3010164	SVQAT1693A
Ferrite beads		
Z303,Z803.4	230909	EXCELDR35V
Capacitors		
C4	354743329	3300 μ F, 16V, Elect
C5	354742229	2200 μ F, 16V, Elect.
C10,C11	354734719	470 μ F, 10V, Elect
C12,C13	354731019	100 μ F, 10V, Elect.

CIRCUIT NO.	PART NO.	DESCRIPTION
C15	354722219	220 μ F, 6.3V, Elect.
C19	354781099	0.1 μ F, 50V, Elect.
C301	354721019	100 μ F, 6.3V, Elect.
C402	354724709	47 μ F, 6.3V, Elect
C407,C801	354721019	100 μ F, 6.3V, Elect.
C803,C804	371122224	2200pF \pm 5%, 50V, Mylar
C805,C806	371123334	0.033 μ F \pm 5%, 50V, Mylar
C807,C808	354781009	10 μ F, 50V, Elect.
C809,C810	354784709	47 μ F, 50V, Elect.
C815	354780109	1 μ F, 50V, Elect.
C816	354721029	1000 μ F, 6.3V, Elect.
Filters		
Z451-Z453	3030003	DSS30654E222
Z801,Z802	3030004	DSS30654B102
Resistor		
R424	441620394	3.9ohm, 1W, Metal oxide film
Switches		
SW41	25035621	RMN0010
SW42	25035622	RMN0011
Plugs		
CN301	25055484	SJSD2225
CN403,CN452	25055485	SJSD0405
Sockets		
BT1	2009990086	REX0076-2
	2009990087	REX0160
Bracket		
	27141402	RMN0014-1, FL tube

SWITCH PC BOARD – PARTS LIST

CIRCUIT NO.	PART NO.	DESCRIPTION
S418,S419	25035623	EVOQTG05R, Switches

REMOTE SENSOR PC BOARD – PARTS LIST

CIRCUIT NO.	PART NO.	DESCRIPTION
IC602	24130005	RCD0004, Remote sensor

LINE OUT PC BOARD – PARTS LIST

CIRCUIT NO.	PART NO.	DESCRIPTION
D427	224450562	MTZ5.6B, Zener diode
RK401	25045294	RJJ33T01, Jack
JK801	25045295	RJH3201N, Jack
CN801	25055486	SJTD414-W, Plug

LOADING MOTOR (1) PC BOARD – PARTS LIST

CIRCUIT NO.	PART NO.	DESCRIPTION
S453,S454	25065392	SSPD12, Microswitch
CN453	25055488	SJTD514-W, Plug

LOADING MOTOR (2) PC BOARD – PARTS LIST

CIRCUIT NO.	PART NO.	DESCRIPTION
S451	25065392	SSPD12, Microswitch
CN451	25055489	RJS4T7ZA, Plug

SENSOR PC BOARD – PARTS LIST

CIRCUIT NO.	PART NO.	DESCRIPTION
D451,D452	24120029	SVDGP1S53, Interruptors

POWER SUPPLY PC BOARD – PARTS LIST

CIRCUIT NO.	PART NO.	DESCRIPTION
C1001	3500065A	△DE7150FZ103PAC400/125V, Capacitor IS
JK1	25050412	△SJS9237, AC inlet
CN1	25055487	SJTD614, Plug
S1	25035624	△ESB8249V, Push switch

NOTE: THE COMPONENTS IDENTIFIED BY MARK
△ ARE CRITICAL FOR RISK OF FIRE AND
ELECTRIC SHOCK. REPLACE ONLY WITH
PARTS NUMBER SPECIFIED.

SCHEMATIC DIAGRAM

(This schematic diagram may be modified at any time with development of new technology.)

Notes:

- S1 : Power switch in "on" position.
- S401 ~ 405 : Disc select (disc. 1 ~ 5) switches. [S401: 1, S402: 2, S403: 3, S404: 4, S405: 5]
- S406 : Time mode select (time mode) switch.
- S407, 408 : Skip (←← skip ►►) switches.
- S409, 410 : Search (←← search ►►) switches.
- S411 : Program/continue (program/continue) switch.
- S412 : Repeat (repeat) switch.
- S413 : Pause (pause) switch.
- S414 : Play (play) switch.
- S415 : Shuffle (random) switch.
- S416 : Stop (stop) switch.
- S418 : Disc skip (disc skip) switch.
- S419 : Open/close switch (Disc).
- S451 : Clamp switch.
- S453 : Open switch (Loading).
- S454 : Close switch (Loading).

The voltage value and waveforms are the reference voltage of this unit measured by DC electronic voltmeter (high impedance) and oscilloscope on the basis of chassis. Accordingly, there may arise some error in voltage values and waveforms depending upon the internal impedance of the tester or the measuring unit.

* The parenthesized are the values of voltage generated during playing (test disc 1kHz, L + R, 0dB), others are voltage values in stop mode.

- Important safety notice: Components identified by Δ mark have special characteristics important for safety. When replacing any of these components, use only manufacturer's specified parts.
- Voltage lines: $\text{---} \text{---} \text{---}$: Positive voltage lines and negative voltage lines.
- $\text{---} \text{---} \text{---}$: audio signal lines.

Caution!

- IC and LSI are sensitive to static electricity. Secondary trouble can be prevented by taking care during repair.
- Cover the parts boxes made of plastics with aluminum foil.
- Ground the soldering iron.
- Put a conductive mat on the work table.
- Do not touch the pins of IC or LSI with fingers directly.

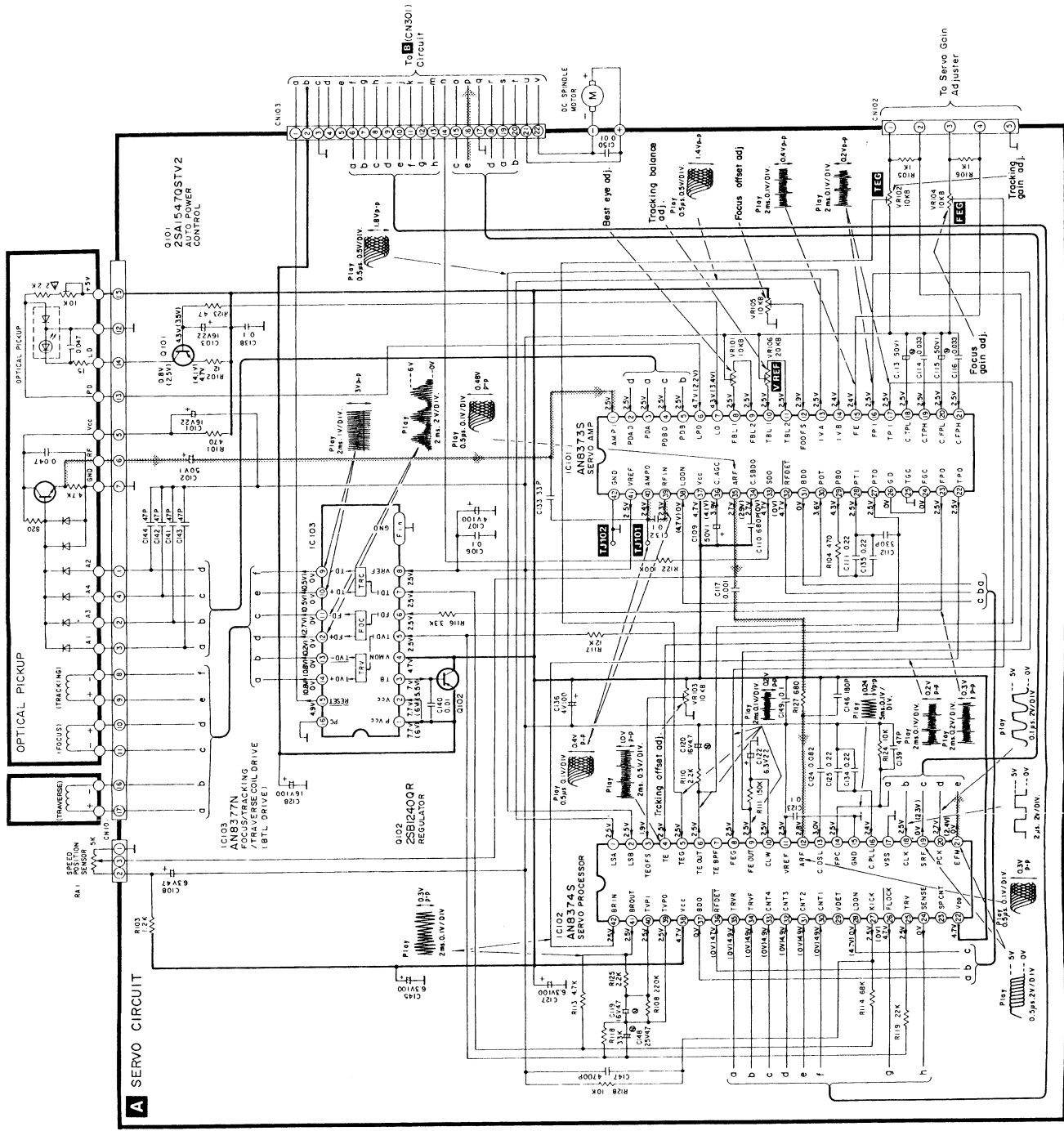

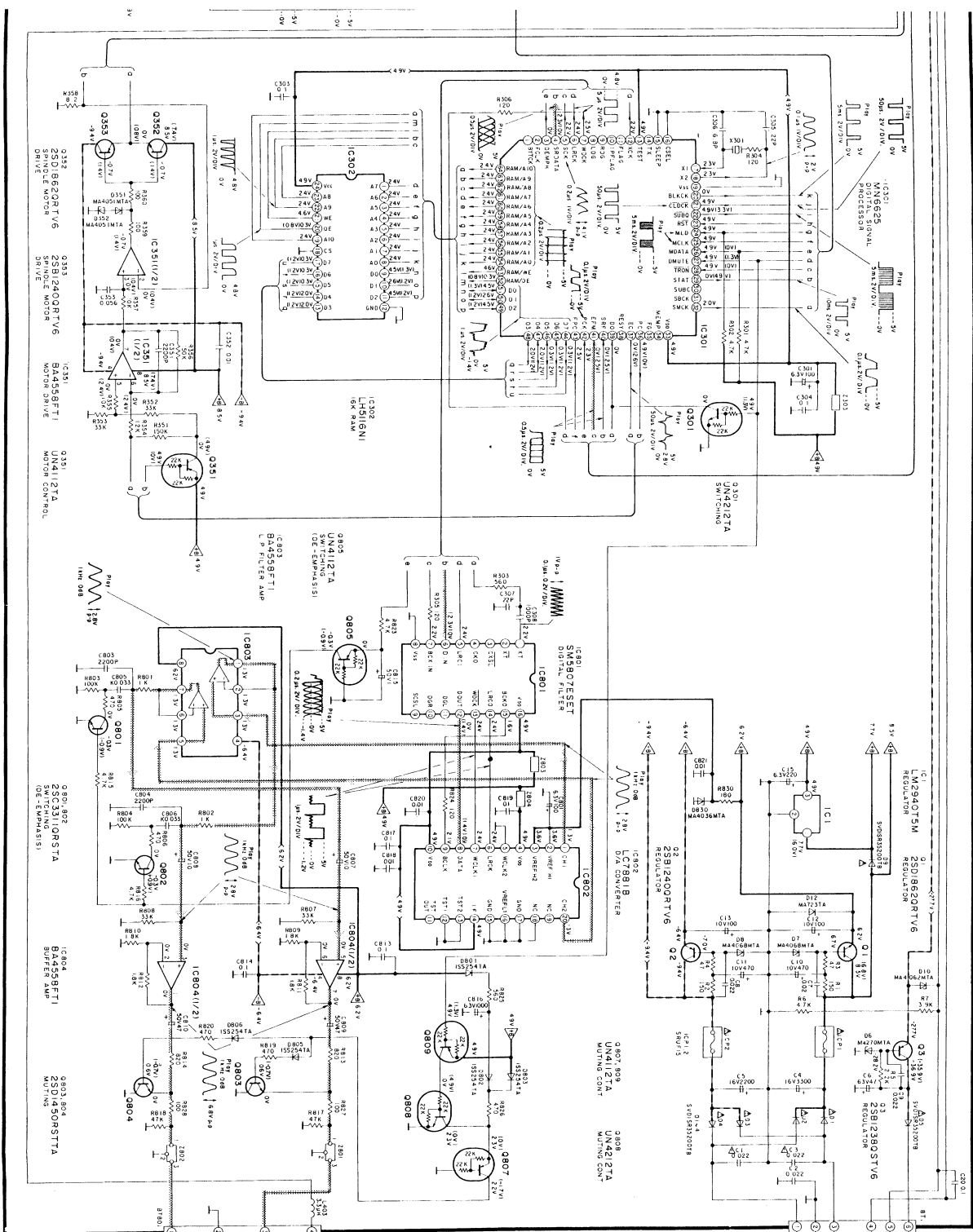

P POWER SUPPLY CIRCUIT

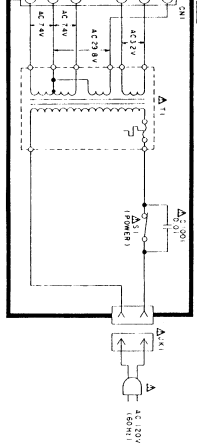

L LINE OUT CIRCUIT

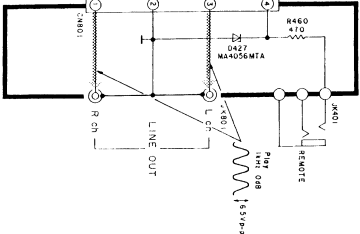

• Cabinet and chassis parts

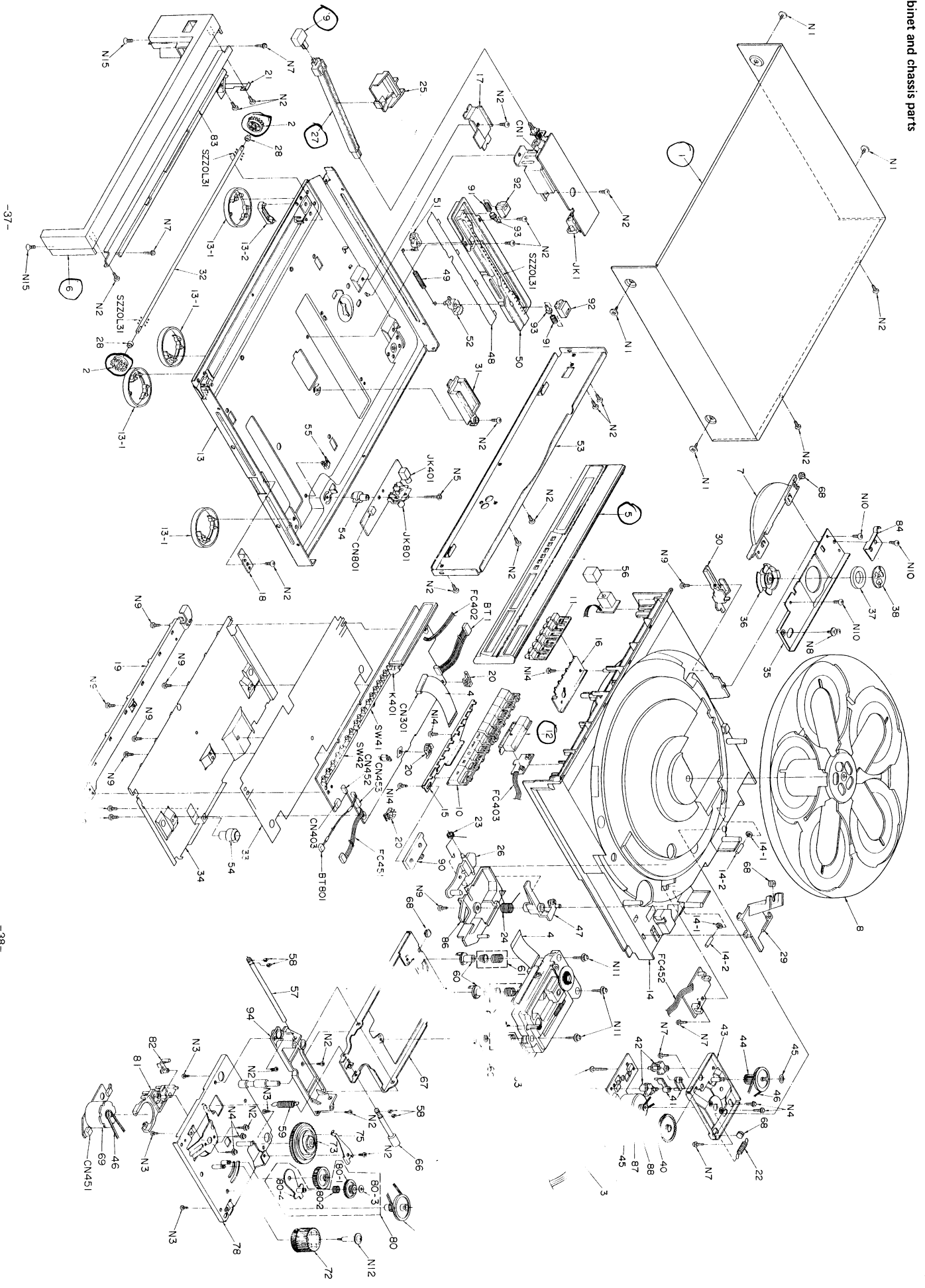

PARTS LIST

REF.NO.	PART NO.	DESCRIPTION	REF.NO.	PART NO.	DESCRIPTION
1	28184459	Cabinet	63	24503178	Spring (B)
2	27301305	Gear, timing →		24506918	Cushion rubber
3	2009990088	Connector ass'y (5P)	64	24503179	Spring (C)
4	2050026	Flat cabel (22P)		24506918	Cushion rubber
5	27215183	Front panel A ass'y	66	24506919	Roller shaft
6	27211202	Front panel B ass'y	67	27100214	Chassis
7	27301306	Cover, clamp	68	24506920	Cushion, dust cover
8	24506908	Tray, rotary	69	24502256	Motor ass'y
9	28324027	Knob, POWER	70	24506921	Gear, pulley
10	28324028	Knob, MAIN	71	24506922	Gear, main
11	28324029	Knob, SUB	72	24506923	Gear, drive
12	28324030	Knob, SKIP ←	73	24504429	Elevator cam
13	27100212	Chassis ass'y —	75	24503180	Spring
13-1	27175248	Foot —	78	24506924	Mechanism chassis ass'y
13-2	27267676	Bracket —	80	24506925	Main arm ass'y
14	28110527	Loading cabinet ass'y	80-1	24506926	Gear
15	27141399	Plate, main	80-2	24503181	Spring
16	27141400	Plate, sub	80-3	27270317	Special washer
17	27130613	Guide plate (L)	80-4	24506927	Main arm
18	27130614	Guide plate (R)	81	24506928	Holder
19	27130615	Operation frame plate	82	24506929	Switch lever
20	27301307	Earth plate	83	27130616	Bracket, panel
21	27301308	Earth plate, panel	84	27301321	Earth spring
22	27301309	Spring, friction	86	24506930	Plate, lead wire
23	27301310	Spring, lock lever	87	24506931	Guide roller
24	27301311	Spring, set lever	88	893040	E-4, E.ring
25	27267677	Guide, lead wire	89	28324031	Knob, lock unit
26	27301312	Lock lever	90	27301322	Spacer, knob
27	27273130	Rod, power switch	91	27301323	Spring, slider
28	27301313	Holder, gear shaft	92	27301324	Plate, rack
29	27190770	Tray holder	93	27220040	Slider
30	27301314	Cover, lead wire	94	24506932	Base, slider
31	27301315	Cover, lock unit	N1	801440	Special screw
32	27260295	Timing gear shaft	N2	838430088	3TTB+8B(BC), Self-tapping screw
33	28175173	Insulator sheet			
34	27150296	Shield plate	N3	838130148	3TTB+14B, Self-tapping screw
35	24506909	Clamp lid	N4	801441	26SMP.SW+4F, Sems screw
36	24506910	Clamper	N5	838130168	3TTB+16B, Self-tapping screw
37	28181025	Magnet	N6	831130100	3TTW+10P, Self-tapping screw
38	24506911	Yoke	N7	831130088	3TTW+8B, Self-tapping screw
39	24502256	Motor ass'y	N8	801442	3SMP8W.SW+8F, Sems screw
40	24506912	Drive gear	N9	838430108	3TTB+10B(BC), Self-tapping screw
41	24506913	Switch lever			
42	24506914	Switch holder	N10	838130060	3TTB+6P, Self-tapping screw
43	27100213	Loading pc board ass'y	N11	801443	Special screw
44	24506915	Pulley gear	N12	801444	Special screw
45	27270320	Washer (A)	N14	838130080	3TTB+8P, Self-tapping screw
46	24506916	Belt	N15	835426108	26TTF+10B(BC), Self-tapping screw
47	24506917	Set lever			
48	27141401	Rack cover	T1	2300552	△ NPT-C100, Power transformer
49	27301316	Spring working	A	24505280	Servo pc board ass'y
50	27301317	Rack plate	B	24505274	Main pc board ass'y
51	27301318	Working rack, front	C	24505282	Sensor pc board ass'y
52	27301319	Working rack, rear	D	24505281	Switch pc board ass'y
53	27121324	Rear panel	E	24505276	Loading motor (1) pc board ass'y
54	27190771	Pc board support			
55	27301320	Cord clamper	F	24505278	Sensor pc board ass'y
56	27301325	Cover, remocon	G	24505277	Loading motor (2) pc board ass'y
57	27260296	Guide shaft			
58	893030	E-3, E. ring	H	24505279	Power supply pc board ass'y
59	24503176	Spring			
60	27270316	Spacer, traverse	I	24505275	Line out pc board ass'y
62	24503177	Spring (A)			
	24506918	Cushion rubber			

PARTS LIST

REF.NO.	PART NO.	DESCRIPTION	REF.NO.	PART NO.	DESCRIPTION
1	28184459	Cabinet	63	24503178	Spring (B)
2	27301305	Gear, timing		24506918	Cushion rubber
3	2009990088	Connector ass'y (5P)	64	24503179	Spring (C)
4	2050026	Flat cabel (22P)		24506918	Cushion rubber
5	27215182	Front panel A ass'y	66	24506919	Roller shaft
6	27211202	Front panel B ass'y	67	27100214	Chassis
7	27301306	Cover, clamp	68	24506920	Cushuon, dust cover
8	24506908	Tray, rotary	69	24502256	Motor ass'y
9	28324027	Knob, POWER	70	24506921	Gear, pulley
10	28324028	Knob, MAIN	71	24506922	Gear, main
11	28324029	Knob, SUB	72	24506923	Gear, drive
12	28324030	Knob, SKIP	73	24504429	Elevator cam
13	27100212	Chassis ass'y	75	24503180	Spring
13-1	27175248	Foot	78	24506924	Mechanism chassis ass'y
13-2	27267676	Bracket	80	24506925	Main arm ass'y
14	28110527	Loading cabinet ass'y	80-1	24506926	Gear
15	27141399	Plate, main	80-2	24503181	Spring
16	27141400	Plate, sub	80-3	27270317	Special washer
17	27130613	Guide plate (L)	80-4	24506927	Main arm
18	27130614	Guide plate (R)	81	24506928	Holder
19	27130615	Operation frame plate	82	24506929	Switch lever
20	27301307	Earth plate	83	27130616	Bracket, panel
21	27301308	Earth plate, panel	84	27301321	Earth spring
22	27301309	Spring, friction	86	24506930	Plate, lead wire
23	27301310	Spring, lock lever	87	24506931	Guide roller
24	27301311	Spring, set lever	88	893040	E-4, E.ring
25	27267677	Guide, lead wire	89	28324031	Knob, lock unit
26	27301312	Lock lever	90	27301322	Spacer, knob
27	27273130	Rod, power switch	91	27301323	Spring, slider
28	27301313	Holder, gear shaft	92	27301324	Plate, rack
29	27190770	Tray holder	93	27220040	Slider
30	27301314	Cover, lead wire	94	24506932	Base, slider
31	27301315	Cover, lock unit	N1	801440	Special screw
32	27260295	Timing gear shaft	N2	838430088	3TTB+8B(BC), Self-tapping screw
33	28175173	Insulator sheet			
34	27150296	Shield plate	N3	838130148	3TTB+14B, Self-tapping screw
35	24506909	Clamp lid	N4	801441	26SMP.SW+4F, Sems screw
36	24506910	Clamper	N5	838130168	3TTB+16B, Self-tapping screw
37	28181025	Magnet	N6	831130100	3TTW+10P, Self-tapping screw
38	24506911	Yoke	N7	831130088	3TTW+8B, Self-tapping screw
39	24502256	Motor ass'y	N8	801442	3SMP8W.SW+8F, Sems screw
40	24506912	Drive gear	N9	838430108	3TTB+10B(BC), Self-tapping screw
41	24506913	Switch lever			
42	24506914	Switch holder	N10	838130060	3TTB+6P, Self-tapping screw
43	27100213	Loading pc board ass'y	N11	801443	Special screw
44	24506915	Pulley gear	N12	801444	Special screw
45	27270320	Washer (A)	N14	838130080	3TTB+8P, Self-tapping screw
46	24506916	Belt	N15	835426108	26TTF+10B(BC), Self-tapping screw
47	24506917	Set lever			
48	27141401	Rack cover	T1	2300552	▲NPT-C100, Power transformer
49	27301316	Spring working	A	24505280	Servo pc board ass'y
50	27301317	Rack plate	B	24505273	Main pc board ass'y
51	27301318	Working rack, front	D	24505281	Switch pc board ass'y
52	27301319	Working rack, rear	E	24505276	Loading motor (1) pc board ass'y
53	27121323	Rear panel			
54	27190771	Pc board support	F	24505278	Sensor pc board ass'y
55	27301320	Cord clamper	G	24505277	Loading motor (2) pc board ass'y
57	27260296	Guide shaft			
58	893030	E-3, E. ring	H	24505279	Power supply pc board ass'y
59	24503176	Spring			
60	27270316	Spacer, traverse	I	24505275	Line out pc board ass'y
62	24503177	Spring (A)			
	24506918	Cushion rubber			

PRINTED CIRCUIT BOARD – PARTS LIST

MAIN PC BOARD – PARTS LIST

CIRCUIT NO.	PART NO.	DESCRIPTION
ICs		
IC1	22240346	LM2940T5M
IC2	22240347	M51953BFF
IC301	22240348	<u>MN6625</u>
IC302	22240349	LH5116N1
IC351	22240350	BA4558F
IC401	22240351	MN15283PJT-2
IC403	22240352	MN15522PKE
IC404	22240353	BA6247N
IC801	22240354	SM5807ESE
IC802	22240355	LC7881B
IC803,IC804	22240350	BA4558F
IC protectors		
ICP1,ICP2	252122	△SRUF15
Transistors		
Q1	2213783 or 2213784	2SD1862-Q or 2SD1862-R
Q2	2213793 or 2213794	2SB1240-Q or 2SB1240-R
Q3	2213803, 2213804 or 2213805	2SB1238-Q, 2SB1238-R or 2SB1238-S
Q301	226037	UN4212
Q351	226036	UN4112
Q352	2213783 or 2213784	2SD1862-Q or 2SD1862-R
Q353	2213793 or 2213794	2SB1240-Q or 2SB1240-R
Q401-Q406	226037	UN4212
Q407-Q410	226036	UN4112
Q411-Q413	2201903	2SA1309-Q
Q415,Q416	226037	UN4212
Q417	2201903	2SA1309-Q
Q419,Q420	2201903	2SA1309-Q
Q422	226037	UN4212
Q423	2201903	2SA1309-Q
Q427	226036	UN4112
Q801,Q802	2201893	2SC3311-Q
Q803,Q804	2213814, 2213815 or 2213816	2SD1450-R, 2SD1450-S or 2SD1450-T
Q805,Q807	226036	UN4112
Q808,Q809	226037	UN4212
FL tube		
FL401	212085	RSL0047-F
Diodes		
D1-D5	223192	△ISR35200TB, Silicon
D6	224452702	MTZ27B, Zener
D7,D8	224450682	MTZ6.8B, Zener
D9	223192	△ISR35200TB, Silicon
D10	224450622	MTZ6.2B, Zener
D12	223193	MA723, Silicon
D351,D352	224450512	MTZ5.1B, Zener
D401-D408	223163	ISS133, Silicon
D410-D416	223163	ISS133, Silicon
D417	224450302	MTZ3.0B, Zener
D418	224450332	MTZ3.3B, Zener
D419-D425	223163	ISS133, Silicon
D801-D803	223163	ISS133, Silicon
D805,D806	223163	ISS133, Silicon
D830	224450362	MTZ3.6B, Zener
Coils		
L401,L403	231177	RLOZP3R3K
L451	231177	RLOZP3R3K
L454-L457	231177	RLOZP3R3K
L460,L461	231177	RLOZP3R3K
X'tal		
X301	3010164	SVQAT1693A
Ferrite beads		
Z303,Z803,4	230909	EXCELDR35V
Capacitors		
C4	354743329	3300 μ F, 16V, Elect
C5	354742229	2200 μ F, 16V, Elect.
C10,C11	354734719	470 μ F, 10V, Elect
C12,C13	354731019	100 μ F, 10V, Elect.

CIRCUIT NO.	PART NO.	DESCRIPTION
C15	354722219	220 μ F, 6.3V, Elect.
C19	354781099	0.1 μ F, 50V, Elect.
C301	354721019	100 μ F, 6.3V, Elect.
C402	354724709	47 μ F, 6.3V, Elect
C407,C801	354721019	100 μ F, 6.3V, Elect.
C803,C804	371122224	2200pF \pm 5%, 50V, Mylar
C805,C806	371123334	0.033 μ F \pm 5%, 50V, Mylar
C807,C808	354781009	10 μ F, 50V, Elect.
C809,C810	354784709	47 μ F, 50V, Elect.
C815	354780109	1 μ F, 50V, Elect.
C816	354721029	1000 μ F, 6.3V, Elect.
Filters		
Z451-Z453	3030003	DSS30654E222
Z801,Z802	3030004	DSS30654B102
Resistor		
R424	441620394	3.9ohm, 1W, Metal oxide film
Switches		
SW41	25035621	RMN0010
SW42	25035622	RMN0011
Plugs		
CN301	25055484	SJSD2225
CN403,CN452	25055485	SJSD0405
Sockets		
BT1	2009990086	REX0076-2
	2009990087	REX0160
Bracket		
	27141402	RMN0014-1, FL tube

SWITCH PC BOARD – PARTS LIST

CIRCUIT NO.	PART NO.	DESCRIPTION
S418,S419	25035623	EVQQTG05R, Switches

LINE OUT PC BOARD – PARTS LIST

CIRCUIT NO.	PART NO.	DESCRIPTION
D427	224450562	MTZ5.6B, Zener diode
RK401	25045294	RJJ33T01, Jack
JK801	25045295	RJH3201N, Jack
CN801	25055486	SJTD414-W, Plug

LOADING MOTOR (1) PC BOARD – PARTS LIST

CIRCUIT NO.	PART NO.	DESCRIPTION
S453,S454	25065392	SSPD12, Microswitch
CN453	25055488	SJTD514-W, Plug

LOADING MOTOR (2) PC BOARD – PARTS LIST

CIRCUIT NO.	PART NO.	DESCRIPTION
S451	25065392	SSPD12, Microswitch
CN451	25055489	RJS4T7ZA, Plug

SENSOR PC BOARD – PARTS LIST

CIRCUIT NO.	PART NO.	DESCRIPTION
D451,D452	24120029	SVDGP1S53, Interruptors

POWER SUPPLY PC BOARD – PARTS LIST

CIRCUIT NO.	PART NO.	DESCRIPTION
C1001	3500065A	△DE7150FZ103PAC400/125V, Capacitor IS
JK1	25050412	△SJS9237, AC inlet
CN1	25055487	SJTD614, Plug
S1	25035624	△ESB8249V, Push switch

NOTE: THE COMPONENTS IDENTIFIED BY MARK △ ARE CRITICAL FOR RISK OF FIRE AND ELECTRIC SHOCK. REPLACE ONLY WITH PARTS NUMBER SPECIFIED.

