



SERVICE BULLETIN
NO:99010-r1

LAST REVISED :00/03/02
 DATE : 99/09/03

MODELS : TX-DS575

SUBJECT : Noise is heard from "VOLUME MIN" to "VOLUME 1".

Symptom:

When MASTER VOLUME is raised from "VOLUME MIN" to "VOLUME 1", the noise is heard from front speaker, center speaker, and rear speaker.

Cause:

The gain of the following circuit from master volume is higher, and the residual noise in the amplifier was larger.

Procedure for service:

Please improve the complaint goods without "A" added at the end of serial numbers as follows.

- a. The gain of all channels is reduced.
- b. Noise decrease
- c. Distortion rate improvement

Because the distortion rate worsens by reducing the gain, please do measures of item C.

If the volume position is raised about 30 degrees, the noise becomes as well as before measures when measures are executed.

The following service improvement ideas have the effect of the improvement of about 7~9dB.

Circuit No.	Before	After	Parts No.	Remarks
a. Gain reduce (NAVD-6566)				
R3183,R3283	39kohm	18kohm	417341834	Front L/R
R3184,R3284	47kohm	10kohm	417341034	Front L/R
R3384,R3484,R3584	22kohm	6.8kohm	417346824	Center,Surround
R3683	330ohm	820ohm	417348214	Sub-woofer
b. Noise decrease (NAVD-6566)				
Q3180,Q3181,Q3281	NJM4558L	NJM4580L-D	22240312	Front L/R
C3183,C3185,C3283 C3285,C3383,C3483 C3583	27pF	220pF	345022214	>100KHz
c. Distortion rate improvement				
R3199(NAVD-6566)	100kohm	220kohm	417342244	Additional
J231(NAVD-6566) (*1)	J231	10kohm	417341034	
R7089(NADIS-6576) (*2)	220ohm	10kohm	433121034R1	

NOTE : *1 and *2 are same modification. Please modify *1 or *2.





**SERVICE BULLETIN
 NO:00005**

MANAGER
 Akira Mori
 2000/07/05

GL
 Seiji Ichikami
 2000/07/04

DESIGN
 Masaaki Yokochi
 2000/05/15

MODELS : TX-DS575

SUBJECT : Change of parts

1. Microprocessor

This model is used the microprocessor of 3 types.

When replace the microprocessor Q7001, refer to the remarks below.

Item	Description	Part No.	Contain of change	Remarks	Application
1	MPD780208GF-045-3BA	22241343		Use item 2 instead of 1. Refer to note below.	MD:1-10600 13001-14600 MP:5001-6900
2	MPD780208GF-047-3BA	22241398	Elimination of 2nd PLL circuit	Use same IC.	MD:10601-13000 14601- MP:1-5000 6901-
3	MPD780208GF-056-3BA	22241419	Improvement of noise when DOLBY.	Use same IC.	From Oct. 1999

Note: When you change the microprocessor from 045-3BA to 047-3BA, remove 2nd PLL circuit and change the setting of A/D,D/A Converter IC Q8501.

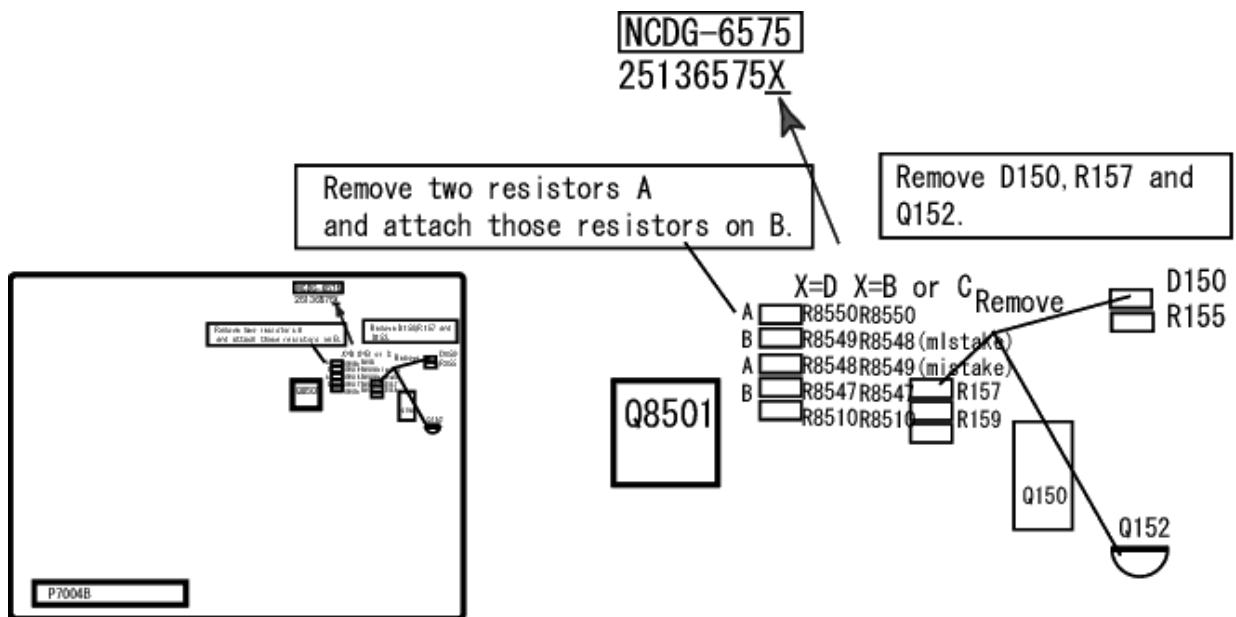

ONKYO
ONKYO USA CORPORATION
200 Williams Drive • Ramsey NJ 07446
201-825-7950 Fax 201-825-8150

Date: 04/13/03

Ref #: TXDS575MUTE

Title: TX-DS575

Classification: Service Tip

Symptom: Receiver shuts down when source, Speakers are selected or volume is set to MIN. position.

Solution: Defective components

Referring to Page 41 and 42 of service manual find all location of muting transistors used. Anyone of the following transistors at location Q3383, 3483, 3186, 3187, 3188, 3684, 3683, 3583, 3283, 3183 may be leaky. In the exception of Q3187 and Q3188, the emitter voltage of the above-described components should not exhibit any DC volt presence in excess of 12mv to max 20mv while operating.

Mute duration is governed by C3194. Muting control DC volt (+2.6) passes through Q3185. The base of all muting transistors is -12vdc when unit is operating normal. When in mute mode, muting transistors base voltage goes to approximate +2.6vdc.

Q3184 pins 1,2,3,4,8,9,10,11 are expected to be DC free. If Any DC is noticed, Q3184 may be defective.

Troubleshooting Steps and Procedure:

Since the unit is likely to shut down if any one of the function switches or volume controls reach MIN, do the followings to keep the unit ON.

- 1) On the power amplifier PCB locate P601A. Then Short all the connector pins together.
- 2) Locate Front amplifier input connector P520A. Short all the connector pins together EXCEPT FIRST PIN, which is 24vdc carrier. This condition will allow the unit to stay ON allowing troubleshooting without unit shutting down.

** Do not forget to remove or clean short when service is complete.

ONKYO**ONKYO USA CORPORATION**
200 Williams Drive • Ramsey NJ 07446
201-825-7950 Fax 201-825-8150**Date:** 11/21/99**Ref #:** TXDS575DSP**Title:** TX-DS575**Classification:** Service Tip**Symptom:** Audio cuts out or intermittent audio from either digital or analog inputs.**Solution:** Loose components

In some units Q710 may become loose following poor solder flow in production. What may be assumed as a DSP PCB malfunction, has been found to be mainly a loose Q710, while in some cases Q708, Q709, and Q114 have also been found with one or more of their solder pins loose. This unit will not work if any of the data lines, pin 8 through pin 17 of Q707, fails to reach Q710, Q709 and or Q708.

****Note:** Q114 input select IC crystal is only ON (working) when input is in analog mode. When digital input source is selected X103 is normally turned off. Please do not assume this as defect.

ONKYO®

Authorized Service Center Support

*Title***TX-DS575***Classification***Service Tip***Symptom*

Audio cuts out or intermitent audio from either digital or analog inputs.

Reason

Loose components

Solution

In some units Q710 may become loose following poor solder flow in production. What may be assumed as a PCB malfunction, has been found to be mainly a loose Q710, while in some cases Q708, Q709, and Q114 have also been found with one or more of their solder pins loose. This unit will not work if any of the data lines, pin 8 through pin 17 of Q707, fails to reach Q710, Q709 and or Q708.

**



	DATE: 03/20/01
Model: TX-DS484, TX-DS575, TX-575X, TX-DS676, TX-DS777	Ref: DTS-Re-EQ-1
<i>Classification: Mandatory</i>	
Problem: Intermittent audio drop out or flutter.	

When a **DTS** program material is being played, it is possible the audio may at some point tend to break-up or flutter. This is not a failure in the product, when the **Re-EQ** setting is left in the **ON** position, it will affect the **DTS** operation. The RE-EQ setting should not be used when playing DTS material. Re-EQ must be **OFF** for DTS to work properly.

"In the parameter setting of Owners Manual, **DTS** was included when using the RE-EQ setting effectively. That is a print error."

No service is required except customer education.



Ref# 01DS575XAM

01/27/01

TXDS575X

AM Radio interference

Classification: Service Tip

In some cases, an AM radio transmitting near by the consumer house (3miles or less of radius est.) may cause audio of the modulated AM signal be heard through center and rear channels regardless of input setting. AM broadcast Frequency range 1360Khz ~1510Khz.

On Volume PCB NCVD-6746, add D204 with 1SS133 Part Number #223163. In place of C3686 place a jumper. Resolder any loose RCA plugs and ground connectors.

For more technical questions send email to svceng@onkyousa.com

Audio Data from Q8501 Pin 9 arrives at Pin 8 of Q114.

Same data will find its way out at pin 20 of Q114.

It is important X0-XI Pin 5, and Pin 6 work correct and that 12.2Mhz oscillation is present. No noticable drift or Jitter should be noticed.

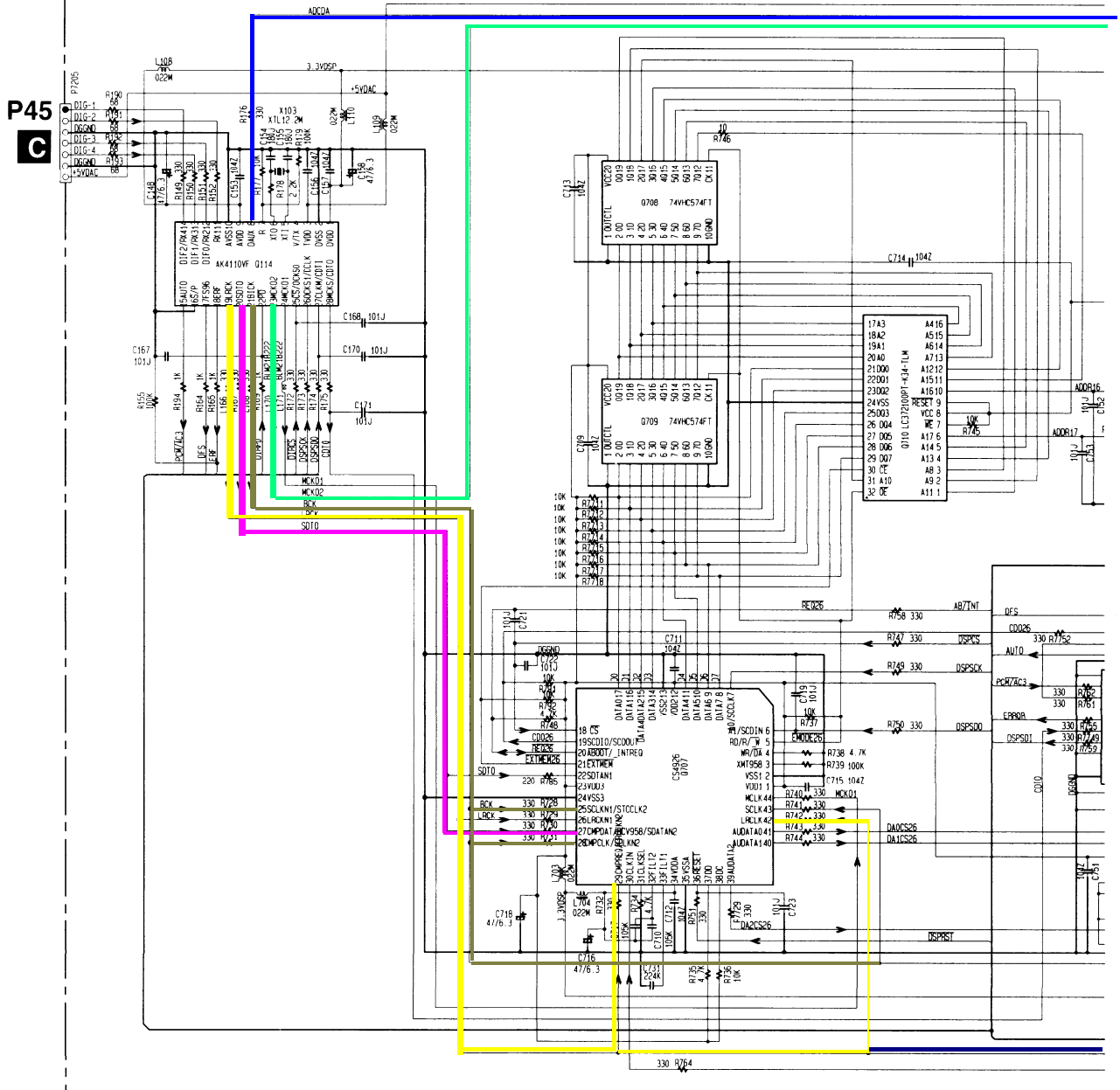

Analog Digital

Q114 Pin 15 = L → =H

Q114 Pin 17 = H → =L

It is conditional that audio data is present at Pin 8 (DAUX) of Q114 and that X-tal X103 is ON in-order for Q114 to operate properly. The digital condition set forth at Pin 15 and 17 along a presence of digital data at Pin 13, 12 and 11 will turn OFF X103.

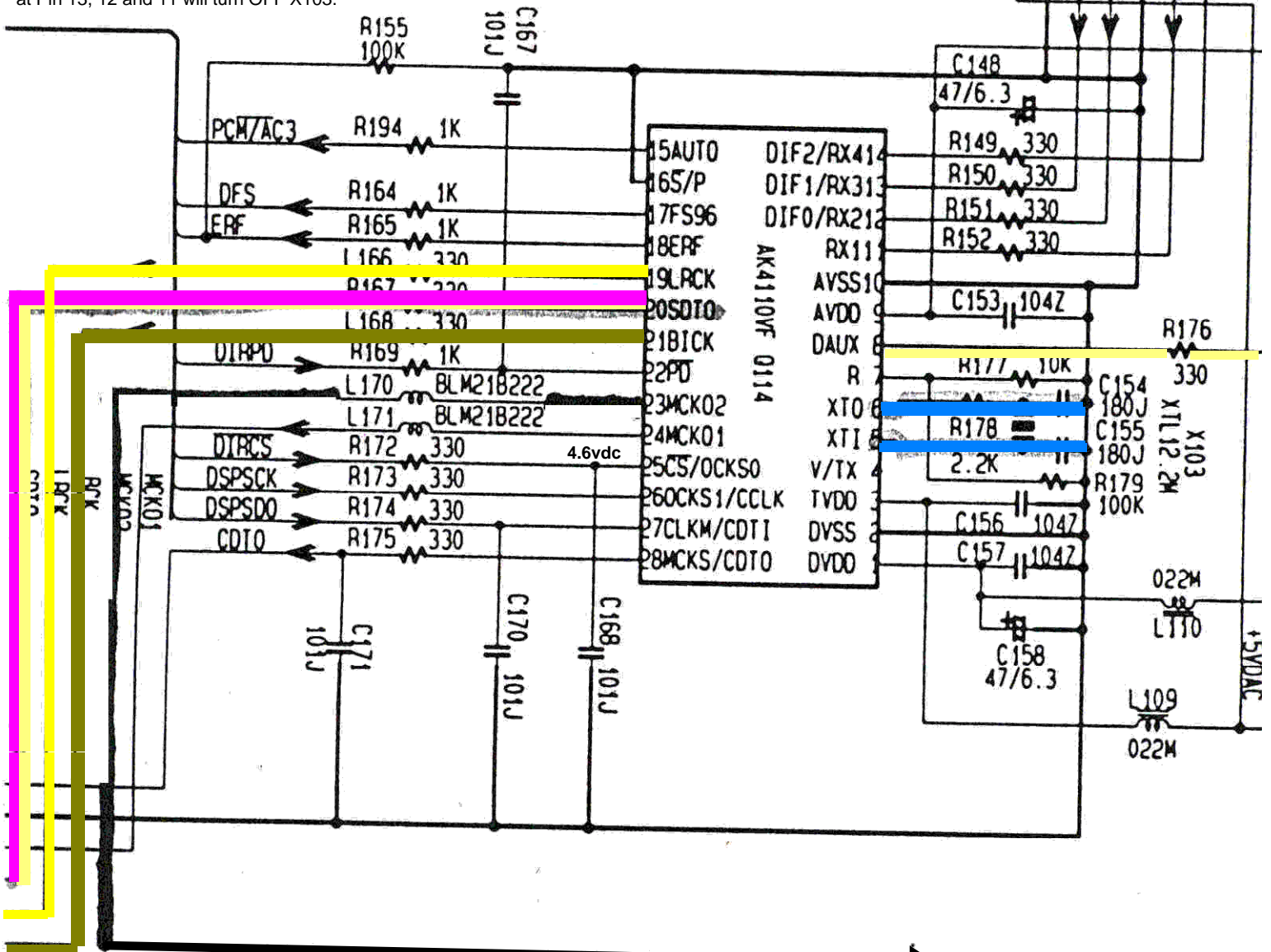

Q114 waveforms when input is analog.

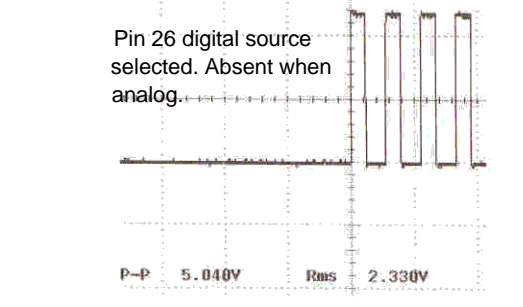
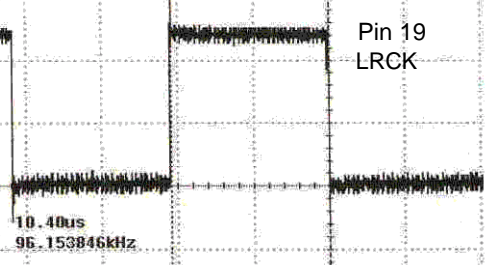
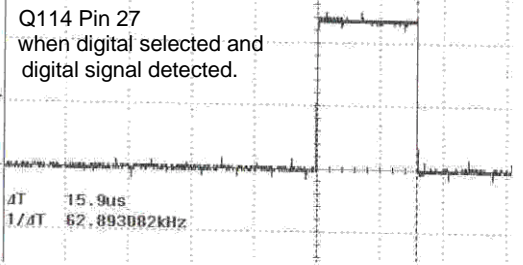
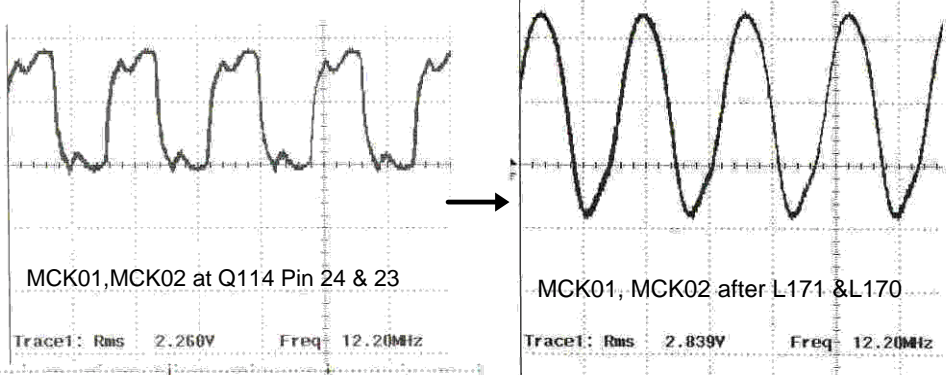

This is a part of more technical information to follow.

To help troubleshoot this model for audio related problem the following easy to follow method has been adapted.
Problem: Audio Analog via any source goes in and no audio out. Unit is not in protection mode.

1. Assuming that you have signal present at the CD input, we will chase the signal as follows. When we do, we will consider all supply voltages are up and up. No ripple voltage is seen over the DC supply line.
2. Remove the DSP PCB and set it flat with the component side accessible. Check for signal at pin 2 and 6, of Q101 and Q102. **Please note that the pin label of Q101 and Q102 is incorrect.** Pin 1 and 7 are output of those same IC's.
3. Balanced output of Q101 and Q102 arrive at pin 29,30,31 and 32.
4. Check for Master clock at Pin 39 of Q8501. If NO...
5. Go and check Q114 pin 5 and 6 Xtal. If OK got to 6. If NO Q114 or X is not working. Replace Q114 and X103.
6. Check Pin 23 and 24 to see if MCKO2 and MCKO1 are running. If YES ...
7. Check for data out at pin 9 of Q8501. If YES ...
8. Check for the data again at pin 8 of Q114. If YES...
9. Look for the data return at pin 20 and sample rate at pin 19. If NO Q114 is possibly defective.
10. Pin 19 through 23 of Q114 working no Audio. Check for data present at pin 22 of Q707. If OK...
11. Check for DC state at connector P7001A "AMUT". If high (>.400vdc) go back to DSP pin 30 of Q707. This point also should have a clock coming from Q702 pin 5. If NO...
12. Check for the ripple voltage level on this IC Q702 and condition of X701 oscillation level. No distortion allowed. If NO ... check Q702 for defect or X701. Replace.
13. If pin 5 of Q702 is good, Check DC voltage of Q707 pin 8,9,10,11,14,15,16,17 (8bit line) to the memory IC Q710. They should all read equal and just about 3.4Vdc. Data on all pins should be identical. If not Q710 is defective with Q708 and Q709 on suspect list. It is also worth noting that before assuming Q710, Q708, Q709 is bad, check for broken or loose R7711 through R7718.
14. When normal the following DC voltages appear at the following pins. See chart. Input is DVD digital set for PCM output or a CD player can be used.

Q707 operating as PCM, digital input.

Pin#	01	02	03	04	05	06	07	08	09	10	11
DC volt	3.3	0	0	0	3.3	0	0	3.3	3.3	3.3	3.3
Pin#	12	13	14	15	16	17	18	19	20	21	22
DC volt	3.3	0	3.3	3.3	3.3	3.3	4.8	3.3	4.9	3.3	.9
Pin#	23	24	25	26	27	28	29	30	31	32	33
DC volt	3.3	0	1.7	1.7	.9	1.7	1.7	1.7	0	2.8	2.2
Pin#	34	35	36	37	38	39	40	41	42	43	44
DC volt	3.4	0	4.8	3.3	3.3	1.1	1	1	1.7	1.7	1.7

Input Coax 1 Setting Digital

Q114 pin reference as follows.

X103 is off since input is digital.

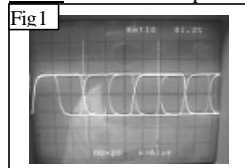

Pin 12 data is OK

Fig2: Pin 26 and 27 clock is OFF when digital signal is present at pin 12.
Pin 15 has no signal.

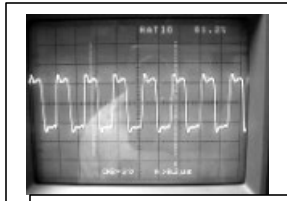
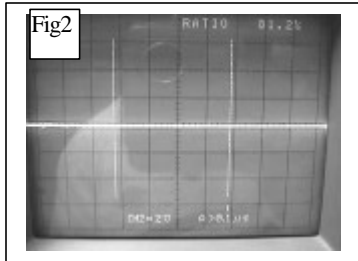

*Data is present at pin 20. (.15us)
Pin 19 and pin 20 appears like this when signal is present at pin 12*

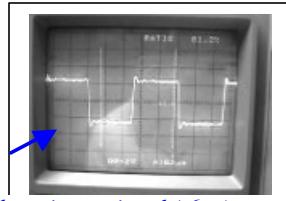

Without input signal (.6us)

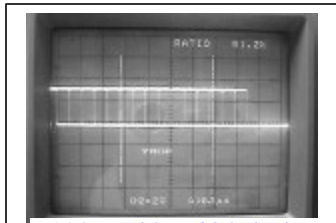

Q114, pin 23 and 24 clock is present and appears normal.

X701 is oscillating and is within spec 12.2Mhz

Q707 (problem begins to show at:)

Pin 39 and 41 has no data.

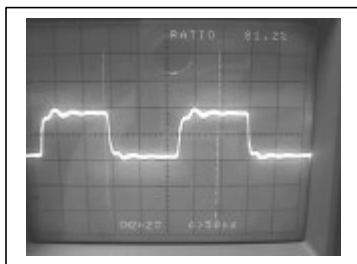

Pin 30 appears this way.

Pin 29

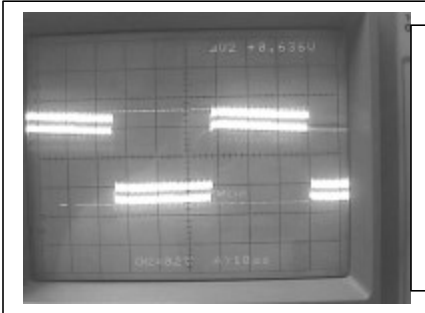
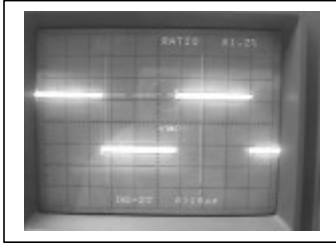

Pin 41 has a problem as seen. This point is normally 4.5vpp rather than .636vpp. The data appears to be corrupted or very low. If the unit is working properly this point becomes very high and clear data is present. At the same time when the unit appears to work, Q707 temperature runs warmer than when it is not.

At this point a re-check of pin 8 through 17 revealed that some of the data line DC voltages were not as they should be. See chart.

Q710 Defective. Replaced and unit worked.



Title : TXDS575 (AM Noise)

Date: 11/05/1999

Classification : Optional

Symptom : AM Radio and Hum noise in subwoofers

Reason

In some cases, an AM radio transmitting near by the consumer's house (4miles or less of radius est.) may cause audio of the modulated signal be heard in all function settings in center and rear channels. AM broadcast Frequency range 1360Khz ~1490Khz. *When used along some high impedance input subwoofers whose power supply employ 3pin (grounded) version, there is a possibility of hum noise heard.

Solution

On Volume PCB NCVD-6566, add D202 with 1SS133. Add C209 with .01uf/50V ceramic disc capacitor. Remove C3686 and put it in place of C3685. In place of C3686 place a jumper. Re-solder any loose RCA plugs and ground connectors.

ONKYO**ONKYO USA CORPORATION**
200 Williams Drive • Ramsey NJ 07446
201-825-7950 Fax 201-825-8150**Date:** 11/21/99**Ref #:** TXDS575DSP**Title:** TX-DS575**Classification:** Service Tip**Symptom:** Audio cuts out or intermittent audio from either digital or analog inputs.**Solution:** Loose components

In some units Q710 may become loose following poor solder flow in production. What may be assumed as a DSP PCB malfunction, has been found to be mainly a loose Q710, while in some cases Q708, Q709, and Q114 have also been found with one or more of their solder pins loose. This unit will not work if any of the data lines, pin 8 through pin 17 of Q707, fails to reach Q710, Q709 and or Q708.

****Note:** Q114 input select IC crystal is only ON (working) when input is in analog mode. When digital input source is selected X103 is normally turned off. Please do not assume this as defect.

ONKYO
ONKYO USA CORPORATION
200 Williams Drive • Ramsey NJ 07446
201-825-7950 Fax 201-825-8150

Date: 04/13/03

Ref #: TXDS575XMUTE

Title: TX-DS575X

Classification: Service Tip

Symptom: Receiver shuts down when source, Speakers are selected or volume is set to MIN. position.

Solution: Defective components

Referring to Page 41 and 42 of service manual find all location of muting transistors used. Anyone of the following transistors at location Q3383, 3483, 3186, 3187, 3188, 3684, 3683, 3583, 3283, 3183 may be leaky. In the exception of Q3187 and Q3188, the emitter voltage of the above-described components should not exhibit any DC volt presence in excess of 12mv to max 20mv while operating.

Mute duration is governed by C3194. Muting control DC volt (+2.6) passes through Q3185. The base of all muting transistors is -12vdc when unit is operating normal. When in mute mode, muting transistors base voltage goes to approximate +2.6vdc.

Q3184 pins 1,2,3,4,8,9,10,11 are expected to be DC free. If Any DC is noticed, Q3184 may be defective.

Troubleshooting Steps and Procedure:

Since the unit is likely to shut down if any one of the function switches or volume controls reach MIN, do the followings to keep the unit ON.

- 1) On the power amplifier PCB locate P601A. Then Short all the connector pins together.
- 2) Locate Front amplifier input connector P520A. Short all the connector pins together EXCEPT FIRST PIN, which is 24vdc carrier. This condition will allow the unit to stay ON allowing troubleshooting without unit shutting down.

** Do not forget to remove or clean short when service is complete.