

TX-DS575 / TX-DS575X Analog Processing

Pin 31 and 32 balanced input for Right channel(RED); Pin 29 and 30 balanced input for Left channel (GREEN)
 Q8501 have combination of ADC and DAC.

Pin 29 ~32 are balanced inputs to ADC. Internally the analog signal goes through High Pass Limiter before it is clocked to L/R out.

Master Clock MCK02 is made available from at Pin 39. Source of MCK02 is Q114.

Pin 9 provides a serial audio data output derived from the analog inputs 29~32 whose data rate is dependant on L/R Clock at Pin 5 and Master Clock at Pin 39. The L/R clock and Serial Data may look alike except Pin 9 has data incorporated within the L/R clock. Pin 9 serial data will arrive at Q114 at Pin 8.

"The analog signal that goes in at Pin 29~32 does not come come out as analog through Pin 23~28 before it has a chance of being processed as above"

Q101 services as inverting amplifier While Q102 non inverting. Note correction On PIN 5,6,.

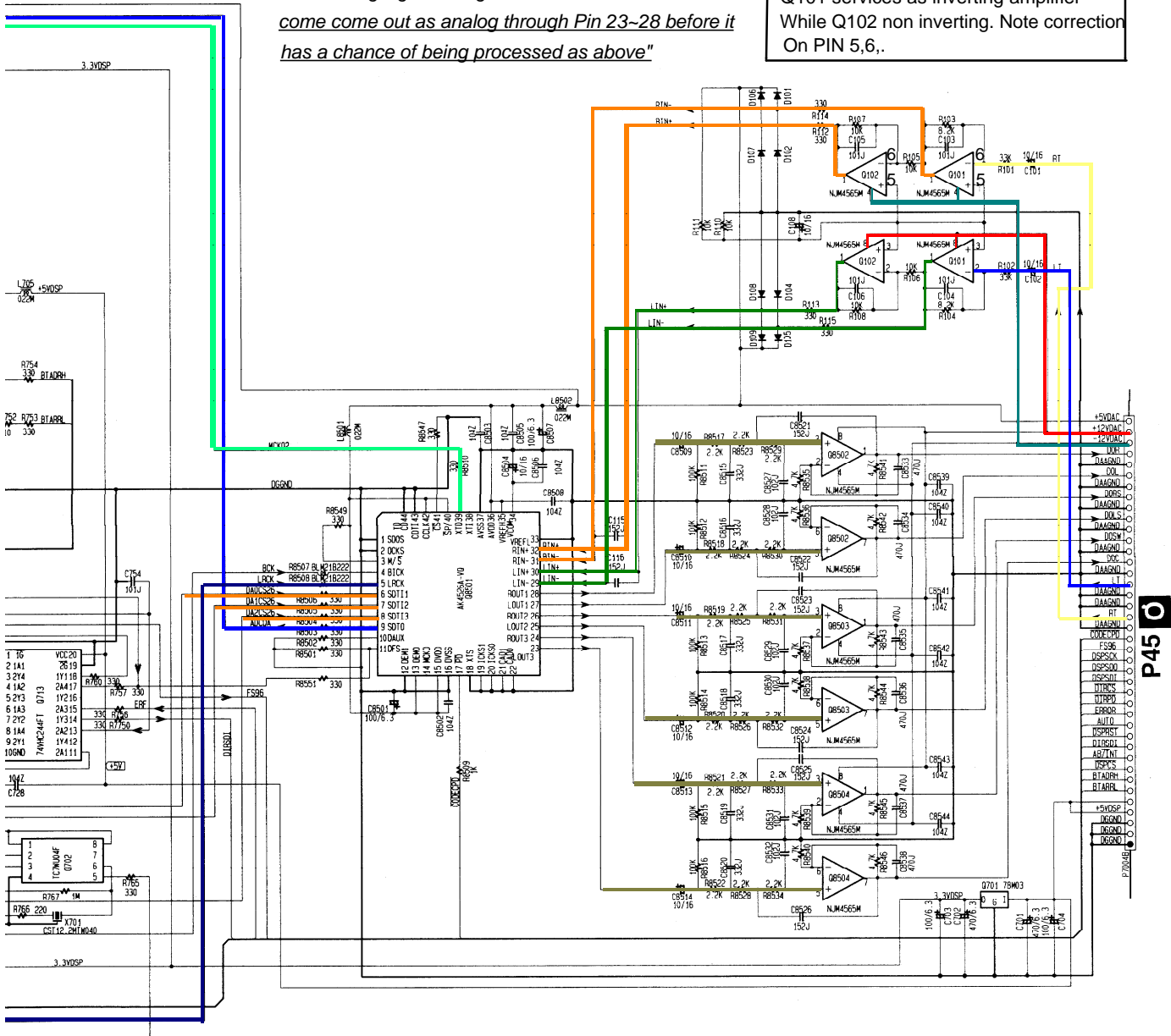

Audio Data from Q8501 Pin 9 arrives at Pin 8 of Q114.

Same data will find its way out at pin 20 of Q114.

It is important X0-XI Pin 5, and Pin 6 work correct and that 12.2Mhz oscillation is present. No noticable drift or Jitter should be noticed.

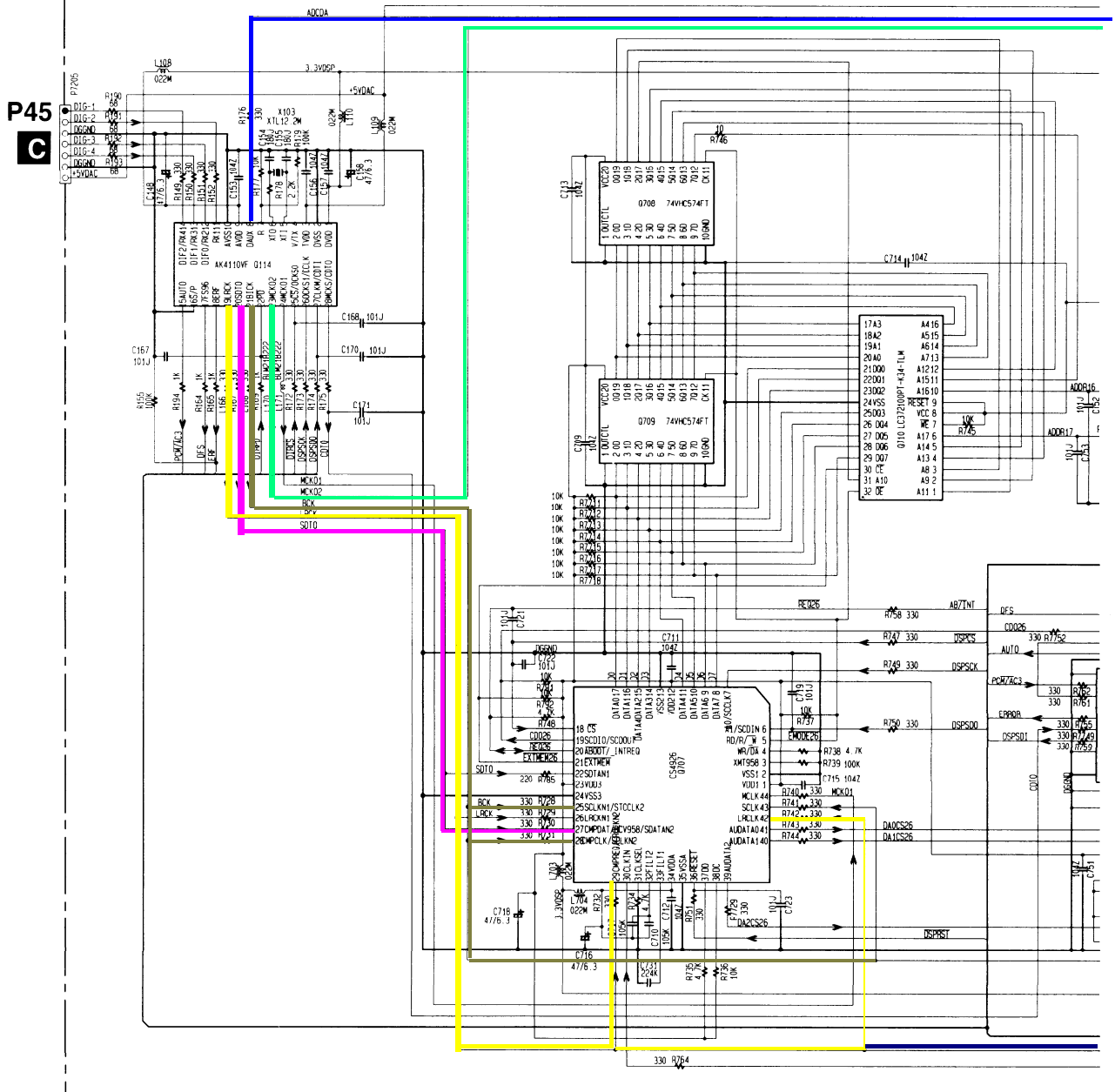

Analog Digital

Q114 Pin 15 = L → =H

Q114 Pin 17 = H → =L

It is conditional that audio data is present at Pin 8 (DAUX) of Q114 and that X-tal X103 is ON in-order for Q114 to operate properly. The digital condition set forth at Pin 15 and 17 along a presence of digital data at Pin 13, 12 and 11 will turn OFF X103.

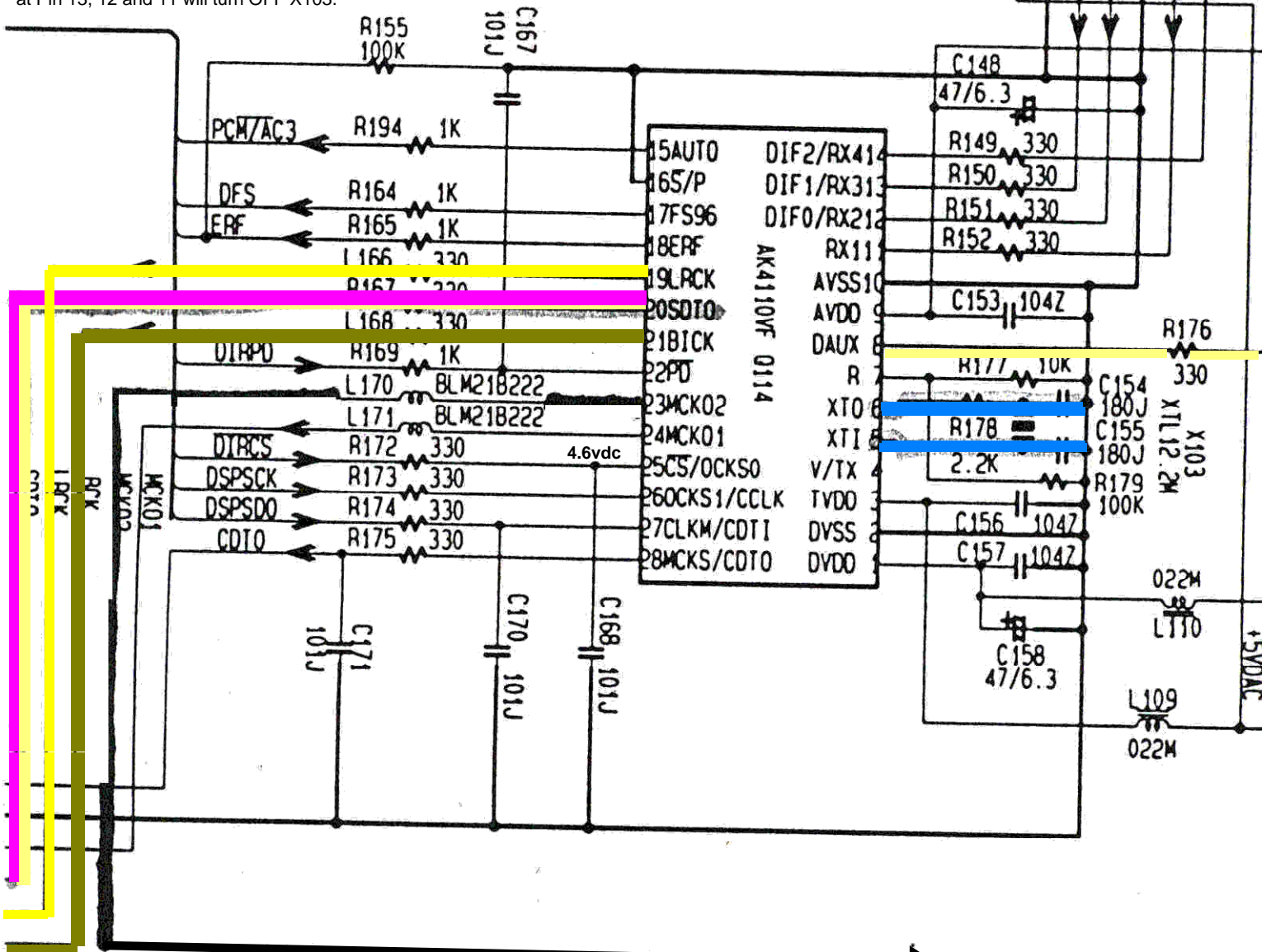

Q114 waveforms when input is analog.

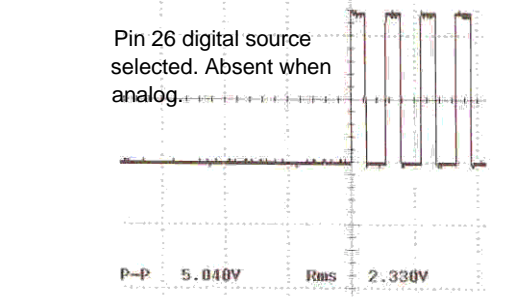
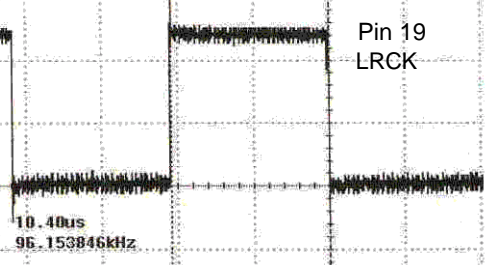
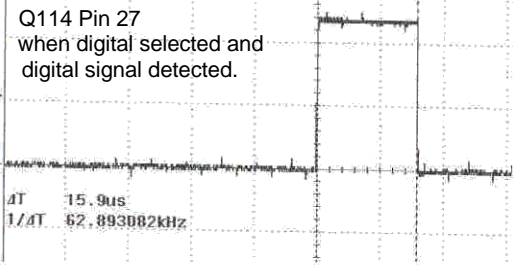
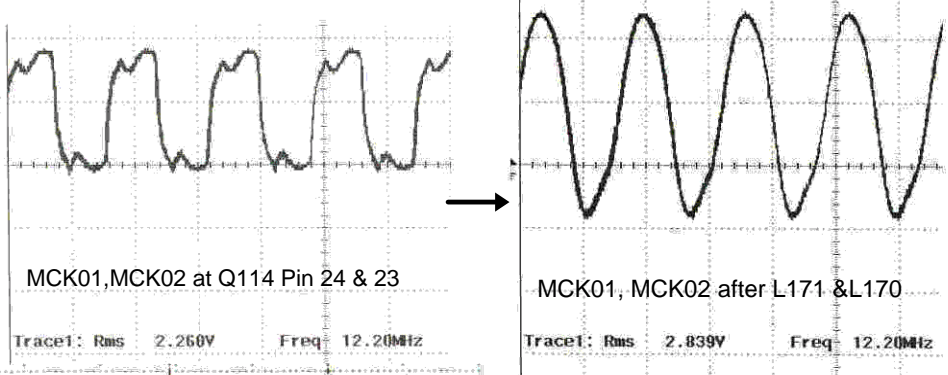

This is a part of more technical information to follow.

To help troubleshoot this model for audio related problem the following easy to follow method has been adapted.
Problem: Audio Analog via any source goes in and no audio out. Unit is not in protection mode.

1. Assuming that you have signal present at the CD input, we will chase the signal as follows. When we do, we will consider all supply voltages are up and up. No ripple voltage is seen over the DC supply line.
2. Remove the DSP PCB and set it flat with the component side accessible. Check for signal at pin 2 and 6, of Q101 and Q102. **Please note that the pin label of Q101 and Q102 is incorrect.** Pin 1 and 7 are output of those same IC's.
3. Balanced output of Q101 and Q102 arrive at pin 29,30,31 and 32.
4. Check for Master clock at Pin 39 of Q8501. If NO...
5. Go and check Q114 pin 5 and 6 Xtal. If OK got to 6. If NO Q114 or X is not working. Replace Q114 and X103.
6. Check Pin 23 and 24 to see if MCKO2 and MCKO1 are running. If YES ...
7. Check for data out at pin 9 of Q8501. If YES ...
8. Check for the data again at pin 8 of Q114. If YES...
9. Look for the data return at pin 20 and sample rate at pin 19. If NO Q114 is possibly defective.
10. Pin 19 through 23 of Q114 working no Audio. Check for data present at pin 22 of Q707. If OK...
11. Check for DC state at connector P7001A "AMUT". If high (>.400vdc) go back to DSP pin 30 of Q707. This point also should have a clock coming from Q702 pin 5. If NO...
12. Check for the ripple voltage level on this IC Q702 and condition of X701 oscillation level. No distortion allowed. If NO ... check Q702 for defect or X701. Replace.
13. If pin 5 of Q702 is good, Check DC voltage of Q707 pin 8,9,10,11,14,15,16,17 (8bit line) to the memory IC Q710. They should all read equal and just about 3.4Vdc. Data on all pins should be identical. If not Q710 is defective with Q708 and Q709 on suspect list. It is also worth noting that before assuming Q710, Q708, Q709 is bad, check for broken or loose R7711 through R7718.
14. When normal the following DC voltages appear at the following pins. See chart. Input is DVD digital set for PCM output or a CD player can be used.

Q707 operating as PCM, digital input.

Pin#	01	02	03	04	05	06	07	08	09	10	11
DC volt	3.3	0	0	0	3.3	0	0	3.3	3.3	3.3	3.3
Pin#	12	13	14	15	16	17	18	19	20	21	22
DC volt	3.3	0	3.3	3.3	3.3	3.3	4.8	3.3	4.9	3.3	.9
Pin#	23	24	25	26	27	28	29	30	31	32	33
DC volt	3.3	0	1.7	1.7	.9	1.7	1.7	1.7	0	2.8	2.2
Pin#	34	35	36	37	38	39	40	41	42	43	44
DC volt	3.4	0	4.8	3.3	3.3	1.1	1	1	1.7	1.7	1.7

Input Coax 1 Setting Digital

Q114 pin reference as follows.

X103 is off since input is digital.

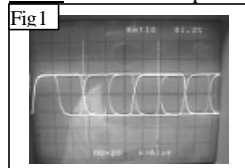

Pin 12 data is OK

Fig2: Pin 26 and 27 clock is OFF when digital signal is present at pin 12.
Pin 15 has no signal.

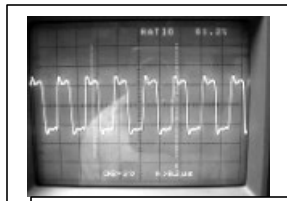
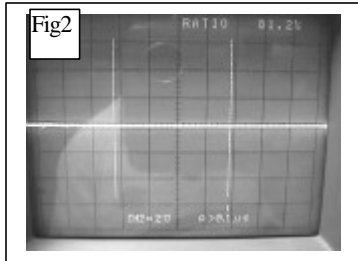

*Data is present at pin 20. (.15us)
Pin 19 and pin 20 appears like this when signal is present at pin 12*

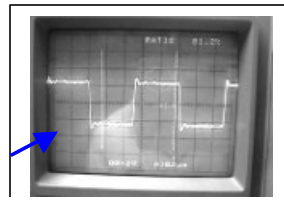

Without input signal (.6us)

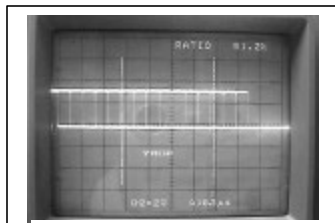

Q114, pin 23 and 24 clock is present and appears normal.

X701 is oscillating and is within spec 12.2Mhz

Q707 (problem begins to show at:)

Pin 39 and 41 has no data.

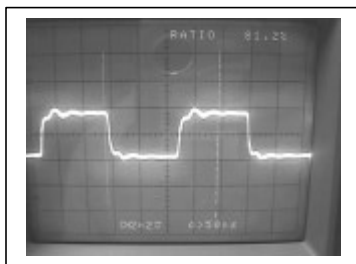

Pin 30 appears this way.

Pin 29

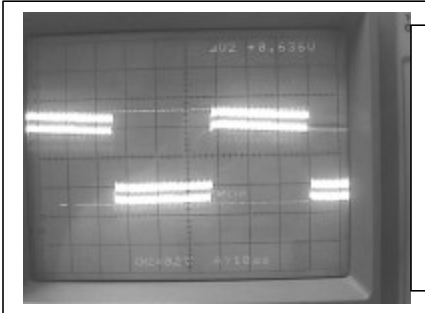
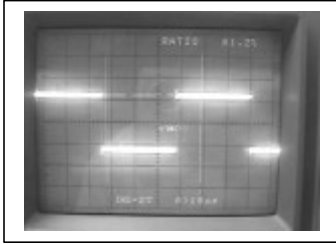

Pin 41 has a problem as seen. This point is normally 4.5vpp rather than .636vpp. The data appears to be corrupted or very low. If the unit is working properly this point becomes very high and clear data is present. At the same time when the unit appears to work, Q707 temperature runs warmer than when it is not.

At this point a re-check of pin 8 through 17 revealed that some of the data line DC voltages were not as they should be. See chart.

Q710 Defective. Replaced and unit worked.