

ONKYO® SERVICE MANUAL

AV RECEIVER TX-DS989

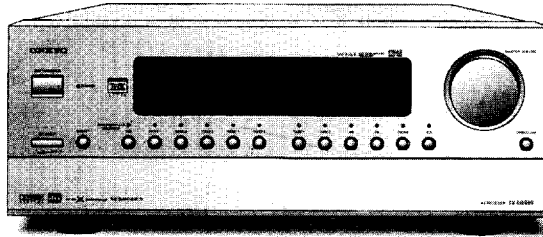

Black, Silver and Golden models

BUD,GUDT	120V AC, 60Hz
BUP/SUP	230V AC, 50Hz
BUPT/GUPT	230V AC, 50Hz
BUPA	230V AC, 50Hz

SAFETY-RELATED COMPONENT WARNING!!

COMPONENTS IDENTIFIED BY MARK Δ ON THE SCHEMATIC DIAGRAM AND IN THE PARTS LIST ARE CRITICAL FOR RISK OF FIRE AND ELECTRIC SHOCK. REPLACE THESE COMPONENTS WITH ONKYO PARTS WHOSE PART NUMBERS APPEAR AS SHOWN IN THIS MANUAL.

MAKE LEAKAGE-CURRENT OR RESISTANCE MEASUREMENTS TO DETERMINE THAT EXPOSED PARTS ARE ACCEPTABLY INSULATED FROM THE SUPPLY CIRCUIT BEFORE RETURNING THE APPLIANCE TO THE CUSTOMER.

TABLE OF CONTENTS

- Specifications..... 2
- Service procedures..... 3
- Panel views..... 4
 - Front panel..... 4
 - Remote controller..... 5
 - Rear panel..... 6
- Example of how to connect equipment..... 8
- Disassembling procedures..... 10
- Assembling procedures..... 11
- IC block diagrams and descriptions..... 13
- Adjustment and confirmation..... 27
- Main microprocessor terminal descriptions..... 29
- Main microprocessor connection diagram..... 31
- Sub microprocessor connection diagram..... 33
- Sub microprocessor connection diagram..... 35
- FL tube view..... 36
- PCB connection view..... 37
- Wiring view..... 39
- Block diagram..... 41
- PCB view, parts list, and schematic diagram..... 43
 - Main microprocessor, Power supply..... 43
 - Display, Sub microprocessor..... 51
 - Audio 1..... 57
 - Audio 2..... 61
 - Power amplifier 1, Power supply..... 65
 - Power amplifier 2..... 70
 - Video..... 76
 - Component video..... 81
 - Multi channel 83
 - DSP 85
- Exploded view 90
- Parts list..... 92
 - Front panel exploded view 93
 - Packing view..... 95



SPECIFICATIONS

AMPLIFIER SECTION

Continuous Average Power output (FTC)

All channels: 130 watts per channel min. RMS at 8 ohms, 2 channels driven from 20 Hz to 20 kHz with no more than 0.05% total harmonic distortion. 170 watts min. RMS at 6 ohms, 2 channels driven from 1 kHz with no more than 0.1% total harmonic distortion.

Continuous Power output (DIN) 160 watts at 6 ohms
 Maximum Power output (EIAJ) 200 watts at 6 ohms
 Dynamic Power Output (Stereo) 2×300 watts at 3 ohms
 2×230 watts at 4 ohms
 2×150 watts at 8 ohms

Total Harmonic Distortion: 0.05% at rated power
 0.05% at 1 Watt output
 IM Distortion: 0.05% at rated power
 0.05% at 1 Watt output
 Damping Factor: 60 at 8 ohms

Damping Factor:

Input Sensitivity and Impedance

PHONO: 2.5 mV, 50 kohms
 LINE (CD, TAPE 1-2, DVD, VIDEO 1-5): 200 mV, 50 kohms
 MULTICHANNEL INPUT (FRONT L/C/R, SURROUND L/R, SURROUND BACK L/R): 200 mV, 50 kohms
 (SUBWOOFER): 36 mV, 50 kohms
 AMP IN (FRONT L/C/R) : 1 V, 50 kohms
 COAXIAL 1-5 (DIGITAL): 0.5 Vp-p, 75 ohms
 DVD, VIDEO1-5: 1 Vp-p, 75 ohms
 1 Vp-p, 75 ohms (Y)
 0.28 Vp-p, 75 ohms (C)
 1 Vp-p, 75 ohms (Y)
 0.5 Vp-p, 75 ohms (Pb, Pr)

COMPONENT VIDEO 1-3:

Output Level and Impedance

Rec out (TAPE 1-2, VIDEO 1-2): 200 mV, 2.2 kohms
 Pre out: 1 V, 470 ohms
 ZONE 2 OUT: 100mV, 470 ohms
 VIDEO (VIDEO 1-2, MONITOR OUT, ZONE 2 OUT): 1 Vp-p, 75 ohms
 1 Vp-p, 75 ohms (Y)
 0.28 p-p, 75 ohms (C)

COMPONENT VIDEO OUT:

Phono Overload: 110 mV RMS at 1 kHz, 0.5% T.H.D.
 Frequency Response: 20 Hz to 30 kHz : 1dB
 (CD in Direct mode)

5 Hz to 100 kHz : +1dB,-3dB
 (CD in Direct mode)
 20 to 20 kHz :±0.8 dB

RIAA Deviation:

Tone Control

Bass: ±10 dB at 100 Hz
 Treble: ±10 dB at 10 kHz

Signal-to-Noise Ratio (Stereo)

Phono: 80 dB (IHF A, 5 mV input)
 CD/Tape: 100 dB (IHF A, 0.5 V input)

TUNER SECTION

FM

Tuning Range: 87.5 ~ 108.0 MHz (50 kHz steps)

Usable Sensitivity

Mono: 11.2 dBf, 1.0 μV (75 ohms IHF)
 0.9 μV (75 ohms DIN)
 Stereo: 17.2 dBf, 2.0 μV (75 ohms IHF)
 23 μV (75 ohms DIN)

50 dB Quieting Sensitivity

Mono: 17.2 dBf, 2.0 μV (75 ohms)
 Stereo: 37.2 dBf, 20 μV (75 ohms)

Capture Ratio: 2.0 dB

Image Rejection Ratio

40 dB (120V model)
 85 dB (Other models)
 90 dB

IF Rejection Ratio:

Signal-to-Noise Ratio

Mono: 76 dB
 Stereo: 70 dB

Alternate Channel Attenuation:

Selectivity:

AM Suppression Ratio:

Total Harmonic Distortion

Mono: 0.2%
 Stereo: 0.3%

Frequency Response:

30 Hz ~ 15 kHz, ±1.0 dB

Stereo Separation:

45 dB at 1 kHz
 30 dB at 100 Hz ~ 10 kHz

AM

Tuning Range

U.S.A model: 530~1,710 kHz (10 kHz steps)

European model:

Asian model:

Usable Sensitivity:

Image Rejection Ratio:

IF Rejection Ratio:

Signal-to-Noise Ratio:

Total Harmonic Distortion:

0.7%

GENERAL

Power Supply:

AC 120 V, 60 Hz
 AC 230 V, 50 Hz
 AC 220 V, 50 Hz
 11 A

Power Consumption:

735 W

Dimensions (W×H×D):

17-1/8"×7-11/16"×17-3/4"

Weight:

48.5 lbs.

REMOTE CONTROLLER

Transmitter:

Signal range:

Power supply:

Infrared
 Approx. 5 meters, 16 ft.
 Two "AA" batteries (1.5 V×2)

Specifications and features are subject to change without notice.

SERVICE PROCEDURES

1. Replacing the fuses

 This symbol located near the fuses indicates that the fuse used is fast operating type. For continued protection against fire hazard, replace with same type fuse. For fuse rating refer to the marking adjacent to the symbol.

 Ce symbole indique que le fusible utilise est a rapide. Pour une protection permanente, n'utiliser que fusibles de meme type. Ce dernier est la qu le present symbol est appse.

CIRCUIT NO.	PART NO.	DESCRIPTION
F9001	252196	12A-UL, Primary <D/DT>
F9002	252079	6.3A-SE-EAK,Primary <P/PT/GT/A>
F9003	252075	2.5A-SE-EAK.AC outlet <P/PT/A>

Note: <D>:120V model only
 <P>: European model only
 <DT>: Asian model only for 120V
 <PT>:Asian model only for 230V
 <GT>: 220V model only
 <A>: Australian model only

2. To initialize the unit

This device employs a microprocessor to perform various functions and operations. If interference generated by an external power supply, radio wave, or other electrical source results in accident which causes the specified operations and functions to operate abnormally. To perform a result, please follow the procedure below.

- 1.Turn the Power switch to on.
- 2.Press and hold down the VIDEO-1 button, then press the STANDBY/ON button.
- 3.After "clear" is displayed, the preset memory and each mode stored in the memory, such as surround, are initialized and will return to the factory setting.
- 4.Disconnect the power supply cord.

3. Safety-check out

(Only U.S.A. model)
 After correcting the original service problem, perform the following safety check before releasing the set to the customer. Connect the insulating-resistance tester between the plug of power supply cord and screw on the back panel. Specifications: 3.3Mohm ± 10% at 500V.

4. Memory Preservation

This unit does not require memory preservation batteries. A built-in memory power back-up system preserves the contents of the memory during power failures and even when the unit is unplugged. The unit must be plugged in order to charge the back-up system.
 The memory preservation period after the unit has been unplugged varies depending on climate and placement of the unit. On the average, memory contents are protected over a period of a few weeks after the last time the unit has been unplugged. This period is shorter when the unit is exposed to a highly humid climate.

5. Changing the AM band step

When you change the band step, change the parts as shown below.

	To 10kHz	To 9kHz
R7091	Short	Open
R7191	Open	10kohm
R7276	Short	Open
R7277	Short	Open
R7376	Open	10kohm
R7377	Open	10kohm

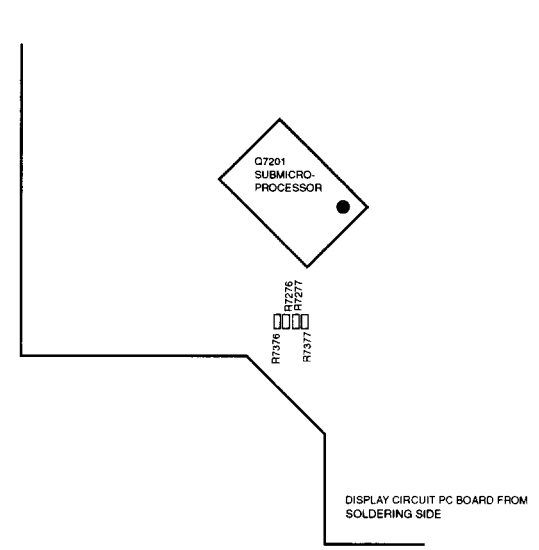
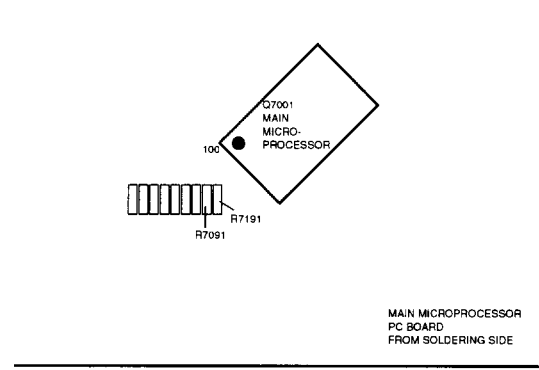

6. Connection of computer

When you change the program of microprocessor or control the unit by the computer, connect the cable RS232C of straight type between a computer and terminal RS232 on the rear panel.

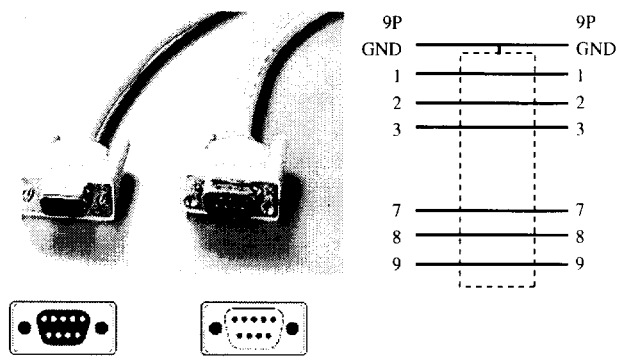

DISASSEMBLING PROCEDURES

1. Top cover

Remove two screws A holding the top cover and bracket.
 Remove six screws B holding the top cover and chassis.
 Remove two screws C holding the top cover and the rear panel.
 Lift up the top cover and remove it.

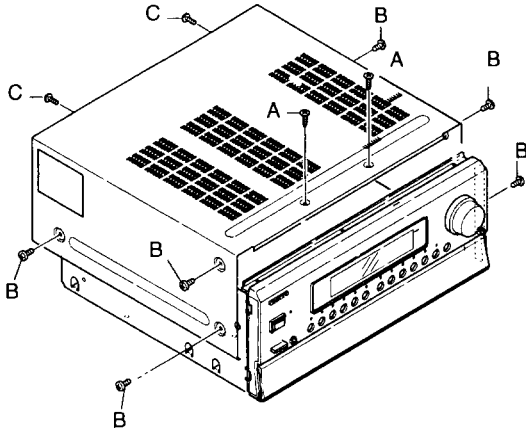

2. Front panel assembly

Remove the top cover.
 Disconnect two FFCs on the sockets of P7201B and P7202A.
 Remove three screws D holding the front panel and chassis from the top side.
 Remove six screws D holding the front panel and chassis from the bottom side.

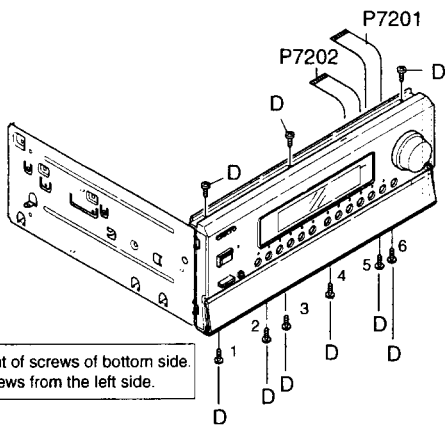

Attachment of screws of bottom side.
 Attach screws from the left side.

3. Bottom board

Remove four screws E holding the leg and chassis.
 Remove ten screws F holding the bottom panel and chassis.

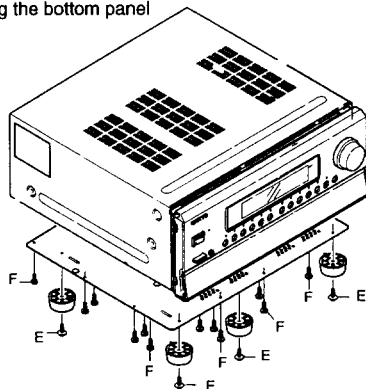

4. Power amplifier PC board block

Remove the top cover.
 Remove the rear panel. (Refer to the item of rear panel)
 Cut the binder G of the left side on the bracket PT.
 Remove a screw H.(UD model only)
 Remove a screw J holding the holder K and remove the holder J.
 Remove the five screws L holding the PC board assembly M.
 (When the screw driver touches the PC board N, press it to the arrow mark.)
 Remove the four screws O holding the brackets and chassis.
 Lifter up the power amplifier PC board block.

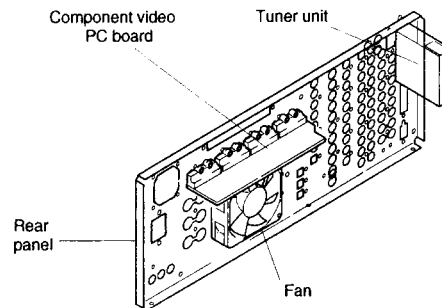
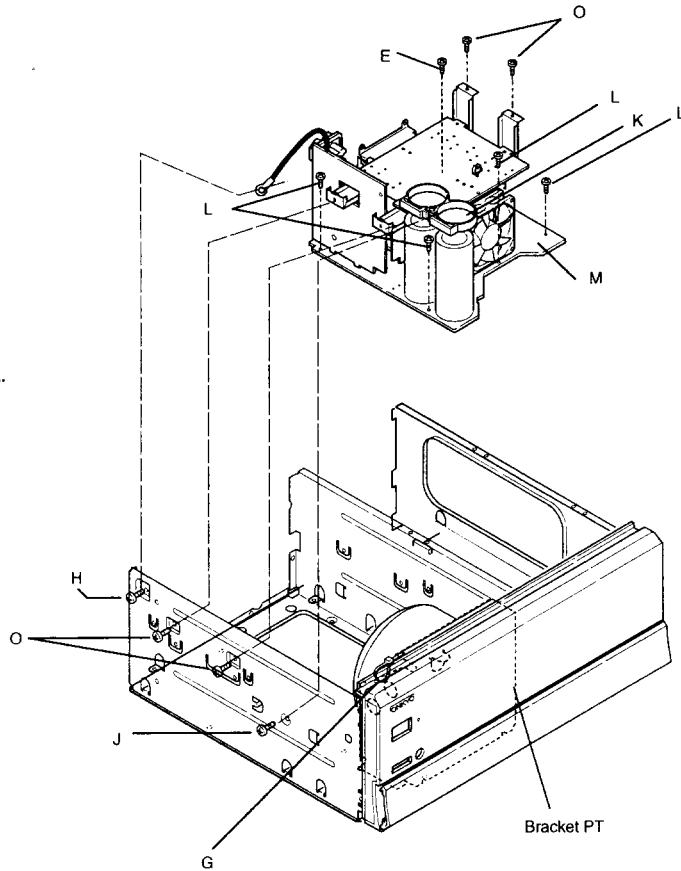

Note: When you remove the rear panel, you are not necessary to remove the parts above.

5. Rear panel

When PC board assembly are removed, remove the rear panel.
 Remove the 12 screws A holding the rear panel and the chassis.
 Remove the four special screws C.
 Remove the 32 screws D to K.
 Remove the two screws L.

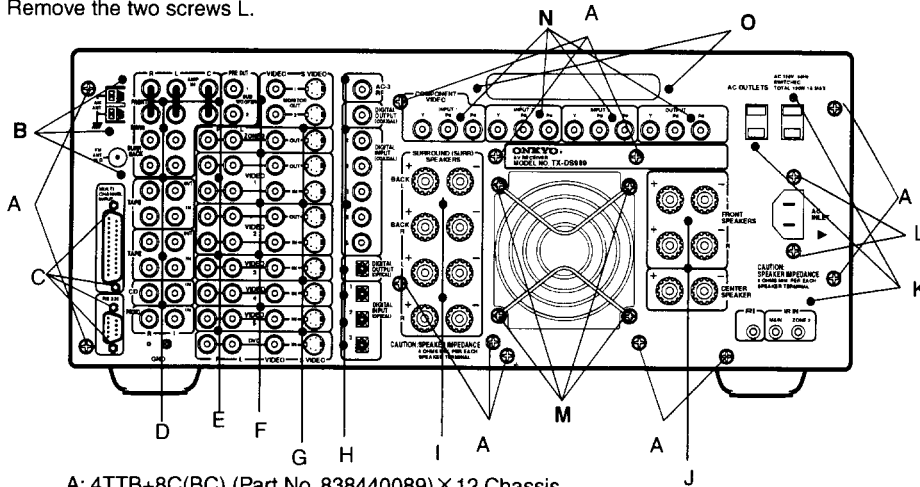

- A: 4TTB+8C(BC) (Part No. 838440089) × 12 Chassis
- B: 3TTB+6B(BC) (Part No. 838430068) × 3 Tuner unit
- C: Special screw (This screw is included to Terminal) × 4 Multi channel input PC board
- D: 3TTB+8B(BC) (Part No. 838430088) × 5 Main circuit PC board
- E: 3TTB+8B(BC) (Part No. 838430088) × 4 Input/output terminal PC board
- F: 3TTB+8B(BC) (Part No. 838430088) × 5 Video terminal PC board
- G: 3TTB+8B(BC) (Part No. 838430088) × 4 S video terminal PC board
- H: 3TTB+8B(BC) (Part No. 838430088) × 7 DSP circuit PC board
- I: 3TTB+8B(BC) (Part No. 838430088) × 2 Speaker terminal PC board
- J: 3TTB+8B(BC) (Part No. 838430088) × 2 Speaker terminal PC board
- K: 3TTB+8B(BC) (Part No. 838430088) × 3 Primary circuit PC board
- L: 4TTB+8C(BC) (Part No. 838440089) × 2 Primary circuit PC board
- M: 5STP+10BQ(BC) (Part No. 833450102) × 4 Fan
- N: 3TTB+8B(BC) (Part No. 838430088) × 4 Component video PC board
- O: 3TTB+8B(BC) (Part No. 838430088) × 2 Cover

ASSEMBLING PROCEDURES

1. Attachment of door knob

When you replace the door knob assembly of left side, cut the two knobs below.

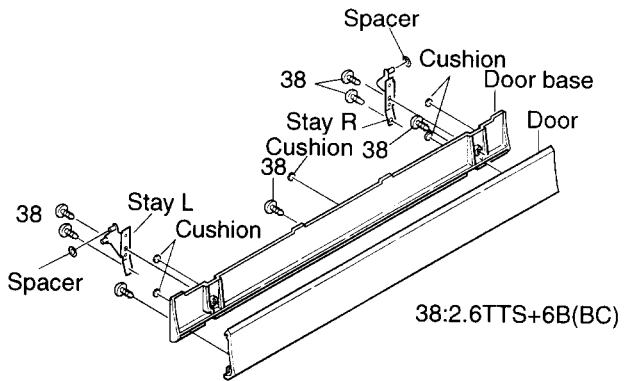
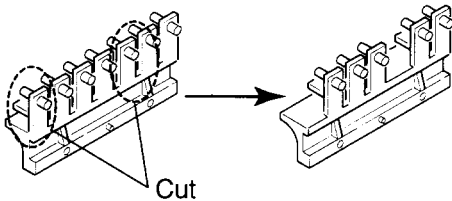

2. Attachment of door

Put the cushions according to the center of rib.

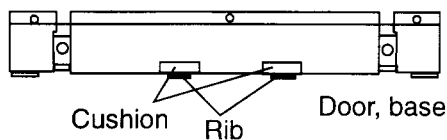

Inley the door base to the door.
 Put the five cushions on the door base.
 Attach the stay L and the stay R.
 Put the spacers on the stay L and the stay R.

3. Attachment of holders

Apply the foil G-902S (Part No. 260447) on the lever L and the lever R.

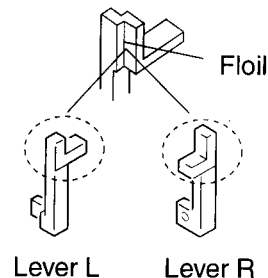

4.Attachment of shaft assembly

Apply Floil on the groove of holders.

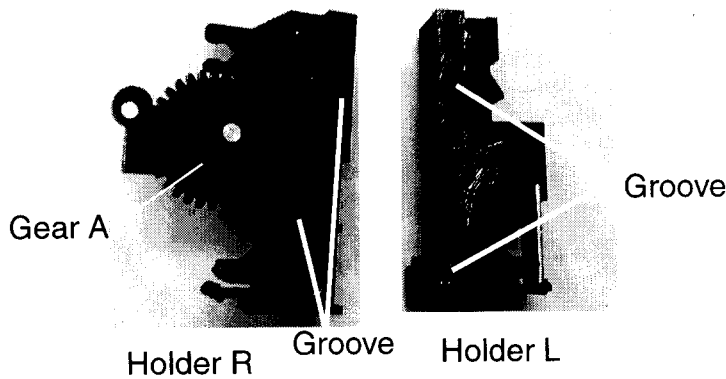

Attach the gear S as shown below.

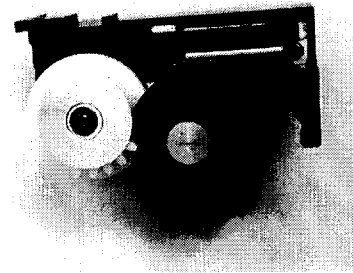

Hang the spring from the down side of lever. Attach the gear A to the holder R, and insert the shaft A to fix the gear A.

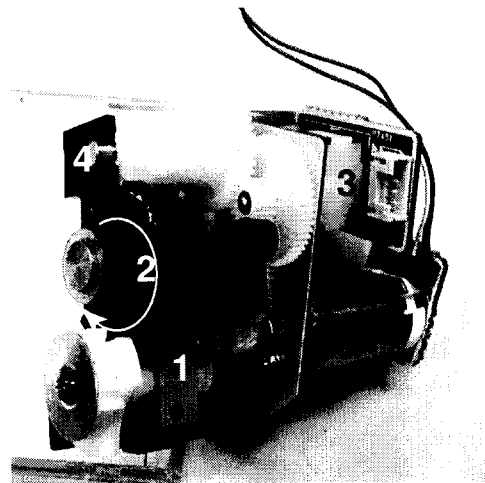
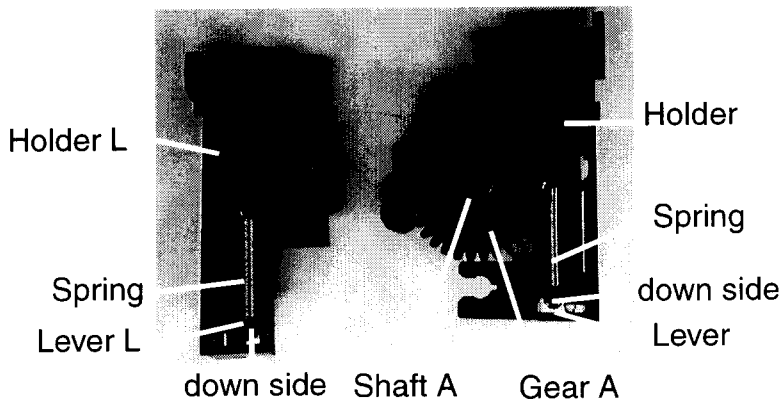

- 1.Insert the retainer S.
- 2.Turn the gear A clockwise fully.
- 3.Insert the headphone jack to the hole of front panel.
- 4.Attach the motor assembly.
- 5.Attach the part above on the front panel.

Insert the shaft to the shaft L and the shaft R.

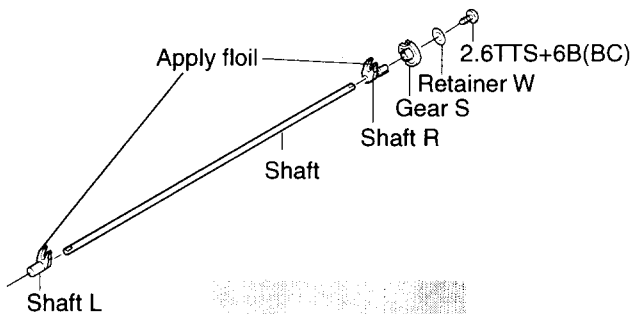

Turn Gear A counter clockwise fully.

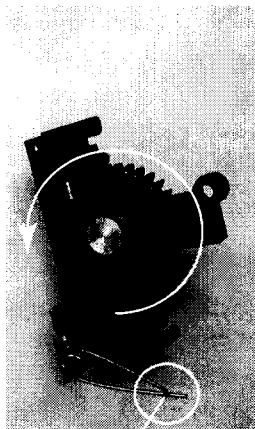

Cross

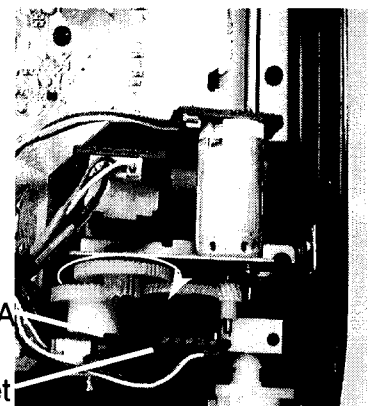

PC board A
Plastic rivet
Turn the gear clockwise fully and insert the PC board A.
Fix the PC board by the plastic rivet.

ADJUSTMENT AND CONFIRMATION

1. Idling current adjustment

Before Idling adjustment, turn the trimming resistors R5340 to R5346 to counter clockwise.
 Connect the DC voltmeter to sockets P5110 to P5116.
 After turn POWER to ON, adjust the trimming resistors R5340 to R5346 so that the reading of voltmeter becomes 1.0 mV.
 After adjustment, attach the top cover.
 Confirm the voltage of points above after five minutes.
 When less than 3 mV: Readjust the trimming resistors above so that the voltage becomes 3.5 ± 0.5 mV.
 When 3 mV to 5 mV: It is not necessary to adjust.
 When more than 5 mV: Readjust the trimming resistors above so that the voltage becomes 4.5 ± 0.5 mV.
 Note: No load and No signal

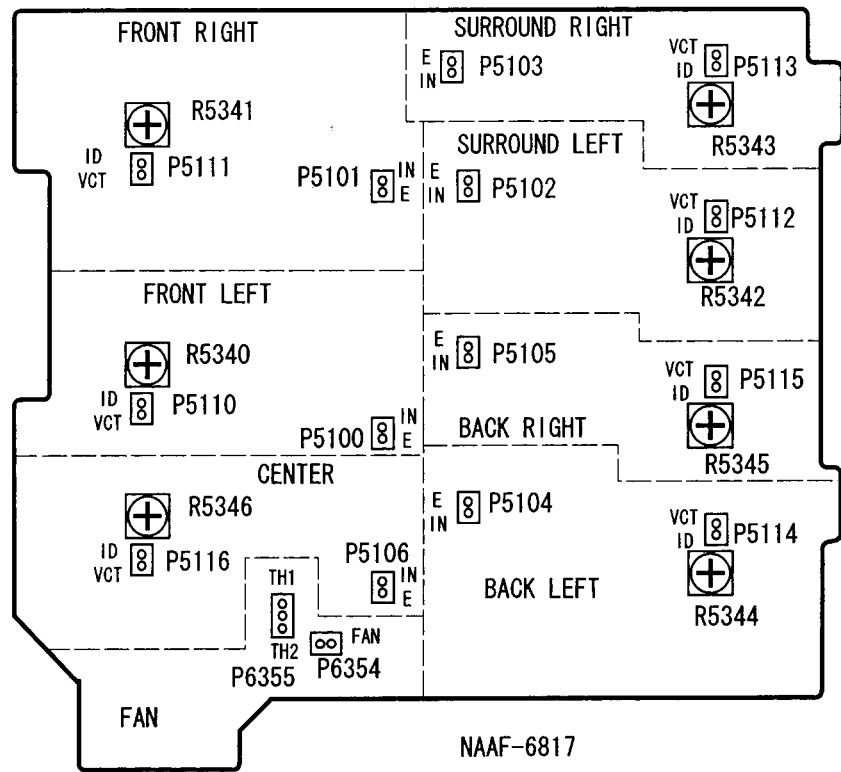

Confirmation of protection circuit

1. Confirmation of operation of speaker relay
 - Confirm that the speaker relay turns ON approximate 5 seconds after the power switch is turned ON.
 - Confirm that the speaker relay turns OFF immediately after the power switch is turned OFF.
2. Confirmation of DC detection circuit
 - Press and hold down CD button, then press DISPLAY and STANDBY buttons at the same time.
 - During "Test-1 00" on the FL tube light on, press VIDEO 1 button to set the unit to "Test-1 00" mode.
 - Apply DC 1.5~3V to the MULTI CHANNEL INPUT terminal of each channel with no load.
 - Confirm that the speaker relay turns OFF.
 - Apply DC -1.5~-3V to MULTI CHANNEL INPUT terminal of each channel with no load.
 - Confirm that the speaker relay turns OFF and it turns ON after a second.
 - Note: Don't apply DC more than 1 second.
 - When the speaker relay does not turn OFF, repeat the operation above several times.
3. Confirmation of Current detection circuit
 - Set the unit to "Test-1 00" mode.
 - Connect Differentiator and apply the 200Hz square signal to the MULTI CHANNEL INPUT of each channel.
 - Adjust the attenuator or Volume so that the output level becomes 70 V p-p.
 - Confirm that the speaker relay turns OFF when a 1.5 ohm load is connected.

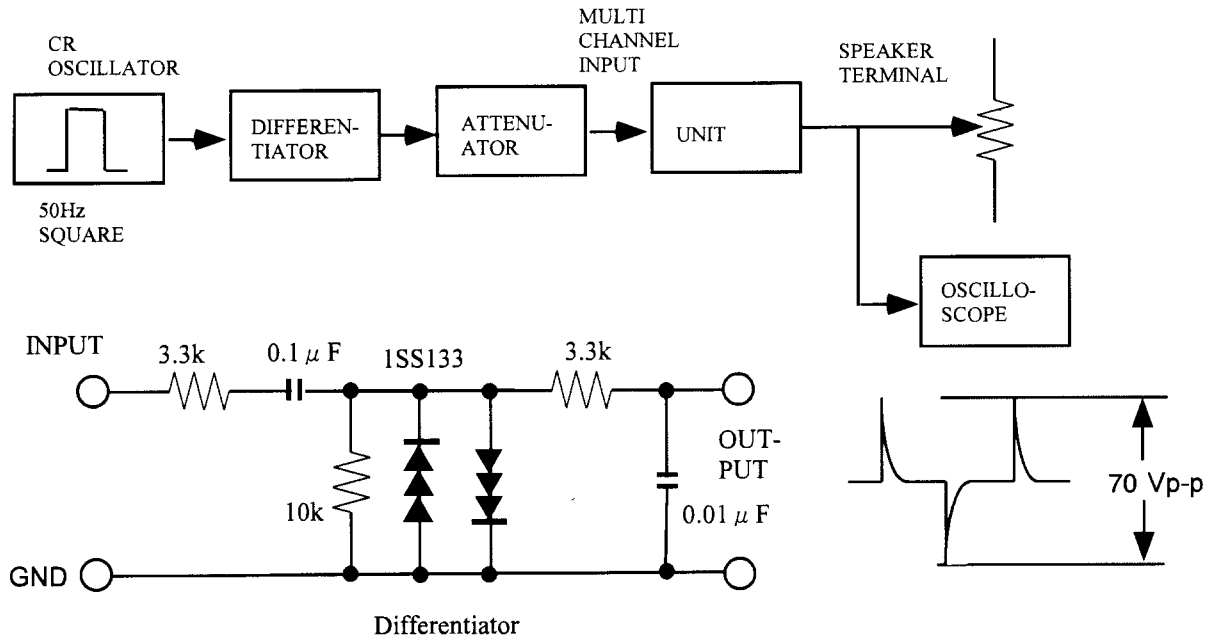

Confirmation of headphone operation

When the headphones are plugged in, confirm that the listening mode automatically changes to STEREO and output to the speakers is stopped.

Confirmation of fan operation

Set the unit to the test mode "TEST1-00".
Apply the signal (1kHz, -30dB) to MULTI CHANNEL terminal except SUBWOOFER terminal with no load.
Confirm that the fan operates after a few seconds.

Confirmation of thermal protect operation

Set the unit to the test mode "TEST1-00".
Connect the metal oxide film resistor 2.7 kohm 1W between terminals of +22V and TH2 on the test point P6355.
Confirm that "Thermal Protect" is displayed on the FL tube.

Confirmation of reading and writing operation of flash memory

Press and hold down CD button, then press DISPLAY and POWER buttons at the same time.
During "TEST1-00" on the FL tube light on and off, press VIDEO 4 button to set the unit to the confirmation mode of this item.
Confirm the display on FL tube.

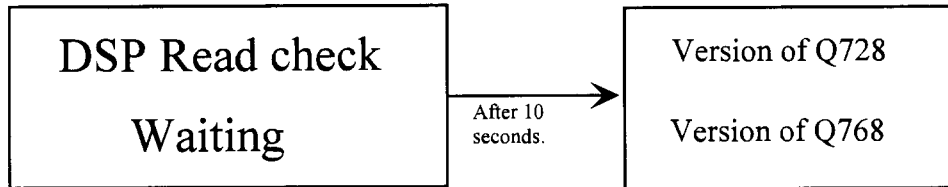

FL tube

After confirmation, turn the POWER switch to OFF to reset the unit.

Test Mode

1. Turn POWER button on.
2. Press and hold down CD button, then press DISPLAY and STANDBY buttons at the same time.
3. During "Test-1 00" on the FL tube lights on, press CD, VIDEO 1, VIDEO 2, or VIDEO 3 button to set the unit to the test mode shown below.
4. Press ZONE 2 or REC button to select the test item.

Button Operation in the Test Mode

Button Operation	Test Mode	Test	Item
CD	FL tube		
VIDEO 1	Protect/Tuner	Test -1	00,01
VIDEO 2	Audio	Test -2	00 to 25
VIDEO 3	Audio	Test -3	00 to 13
ZONE 2	UP of item		
REC	DOWN of item		

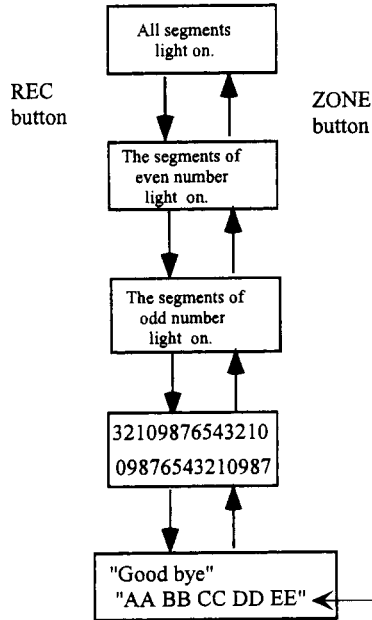
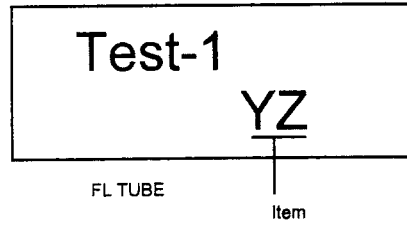

AA: Power amplifier function : "AM" with Power amplifier, " " without Power amplifier
 BB: Video mode: "PL" PAL available, "NS" NTSC
 CC: 12V trigger function: "TR" Available, " " No available
 DD: RDS function: "RD" Available, " " No available
 EE: Region: "EU" Europe, "SA" Asia, "US" U.S.A., "JP" Japan

Ex. European model AM PL RD EU

MAIN MICROPROCESSOR TERMINAL DESCRIPTION

No.	Function	I/O	Act	Description
1	FDATA	O	H	Serial data output terminal of function switch for input and configuration.
2	FCLK	O	CLK	Serial clock output terminal of function switch for input and configuration.
3	CFSTB	O	H	Serial clock output terminal of function switch for configuration.
4	TDATA	O	H	Serial data output terminal of tone control IC.
5	TCLK	O	CLK	Serial clock output terminal of tone control IC.
6	-TCS1	O	L	Chip select output terminal of tone control IC for front channel.
7	-TCS2	O	L	Serial data output terminal of tone control IC for center and sub woofer.
8	VSS	I		Input terminal to switch the bus width of external data. Connect to the ground.
9	VSS	I		Input terminal to switch processor mode. Connect to the ground.
10	VPDATA	O	H	Serial data output terminal of electrical volume and PLL ICs.
11	VPCLK	O	CLK	Serial clock output terminal of electrical volume and PLL ICs.
12	-RESET	I		System reset input terminal.
13	XOUT	O		Oscillator circuit output terminal of main clock.
14	VSS	I		Power supply terminal. Connect to the ground.
15	XIN	I		Oscillator circuit input terminal of main clock.
16	VCC	I		Power supply terminal. Connect to +5V.
18	VSTB	O	H	Strobe output terminal of electrical volume.
19	-RDSSCK	I	CLK	Clock input terminal from RDS modulator IC.
20	-POFF	I	L	Input terminal for power failure detection.
21	PLLCE	O	H	Strobe output terminal of PLL IC.
22	RDSDATA	I	H	Data input terminal from RDS modulator IC.
23	RDSSIG	I	H	Check terminal of the signal from RDS modulator.
24	-STEREO	I	L	FM stereo broadcast detection terminal.
25	-SD	I	L	Signal strength detection terminal of tuner.
26	DIGSO	O	H	Serial data output terminal to DSP ICs.
27	DIGSI	I	H	Serial data input terminal from DSP and DIR ICs.
28	DIGSCK	O	CLK	Serial clock output terminal to DSP ICs.
29	-INTRQ1	I	L	INTRQ input terminal from DSP2.
30	-INTRQ2	I	L	INTRQ input terminal from DSP1.

No.	Function	I/O	Act	Description
31	2NDPLLCS	O	H	Serial chip select output terminal of second PLL IC.
32	2NDPLLLOCK	I	H	Lock detection input terminal from second PLL IC
33	~AD/DIR	O	H	ADC/DIR select output terminal
34	~SUBREQ	I	L	Request input terminal from sub microprocessor
35	MAINSO	O	H	Serial data output terminal of sub microprocessor
36	MAINSI	I	H	Serial data input terminal from sub microprocessor
37	MAINSCK	O	CLK	Serial clock output terminal of sub microprocessor
38	~MAINREQ	O	L	Request output terminal from sub microprocessor
39	XSTATE	I	H	Source clock change monitor input terminal (DIR)
40	ERROR	I	H	Flag input terminal for PLL lock error or data error.
41				Port of flash memory rewriting (DIR)
42	CSFLAG	I	H	Update flag input terminal of head 40 bits of channel status
43	~RFDIRrst	O	L	DIR/AC-3 RF RESET output terminal (common)
44	RFSYNC	I	H	Synchronizing input terminal for AC-3 RF
45	~DARST	O	L	Reset signal output terminal for DAC
46				Port of flash memory rewriting (DIR)
47	~ADRST	O	L	Reset signal output terminal for ADC
48	DFS	O	H	Sampling frequency control output terminal for ADC/DAC
49	APGLOCK	I	H	Not used.
50	F0	O	H	Not used.
51	F1	O	H	Not used.
52	F2	O	H	Not used.
53	TUMUT	O	H	Muting control output terminal for tuner section
54	MRMUT	O	H	Muting control output terminal for zone 2.
55	HPMUT	O	H	Muting control output terminal for headphone
56	AMUT	O	H	Muting control output terminal for analog section
57	SPRL	O	H	Speaker relay control output terminal
58	POWERL	O	H	Power relay control output terminal
59	~TRG12A	O	L	Not used.
60	~TRG12B	O	L	Not used.
61	~PRTCTTHM	I	L	Thermal protection detection input terminal
62	VCC	I		Power supply terminal. +5V.
63	PRTCTV	I	H	Current/Voltage detection input terminal of protection circuit
64	VSS	I		Power supply terminal. Connect to the ground.
65	ADR2916	O	H	Control output terminal for address 16 of flash memory IC Q728
66	ADR2917	O	H	Control output terminal for address 17 of flash memory IC Q728
67	ADR2918	O	H	Control output terminal for address 18 of flash memory IC Q728
68	ADR3017	O	H	Control output terminal for address 17 of flash memory IC Q768
69	ADR3015	O	H	Control output terminal for address 15 of flash memory IC Q768
70	ADR3016	O	H	Control output terminal for address 16 of flash memory IC Q768
71	~DSPCS2	O	L	Chip select output terminal to DSP IC 2
72	~DSPCS1	O	L	Chip select output terminal to DSP IC 1
73	2NDPLLCLK	O	CLK	Serial clock output terminal to second PLL IC
74	~DIRCS	O	L	Chip select output terminal to DIR IC
75	~DACCS	O	L	Chip select output terminal to DAC
76	~DSPRST2	O	L	Reset output terminal to DSP IC 2
77	~DSPRST1	O	L	Reset output terminal to DSP IC 1
78	IEEEMOD1	O	H	IEEE mode select output terminal. High level when clock of two lines and data of a line.
79	IEEEMOD2	O	H	IEEE mode select output terminal. High level when clock of two lines and data of four lines.
80	DSPMOD	O	H	High level when DSP 1.
81	IEEEMOD1CLK	O	H	Select output terminal of clock master or slave.
82	~CSFLASH	O	L	Chip select output terminal of flash memory ICs.
83	~CSSRAM	O	L	Chip select output terminal of SRAM ICs
84	~AUDIO	I	L	Audio detect input terminal of DIR IC
85	AUTO	I	H	Auto detect input terminal of DIR IC
86	DIGCS	O	H	Chip select output terminal of digital input switch
87	MPOWER	O	L	Initializing of power amplifier.
88	ADR2915	O	H	Address 15 control output terminal of flash memory
91	9k/~10k	I	H	Initializing input terminal for band step of AM
92	MSPORT4	O	H	Not used.
93	~SUBPOFF	O	L	Signal control output terminal for power off of sub microprocessor
94	MSPORT2	O	H	Not used.
95	MSPORT1	O	H	Not used.
96	VSS	I		Power supply terminal for AD converter
97	~SUBRESET	O	L	Reset control terminal for sub microprocessor
98	VREF	I		Reference voltage input terminal for A/D converter
99	VCC	I		Power supply terminal for A/D converter. Connect to 5V.
100	IPSTB	O	H	Strobe output terminal for function switch

MICROPROCESSOR CONNECTION DIAGRAM

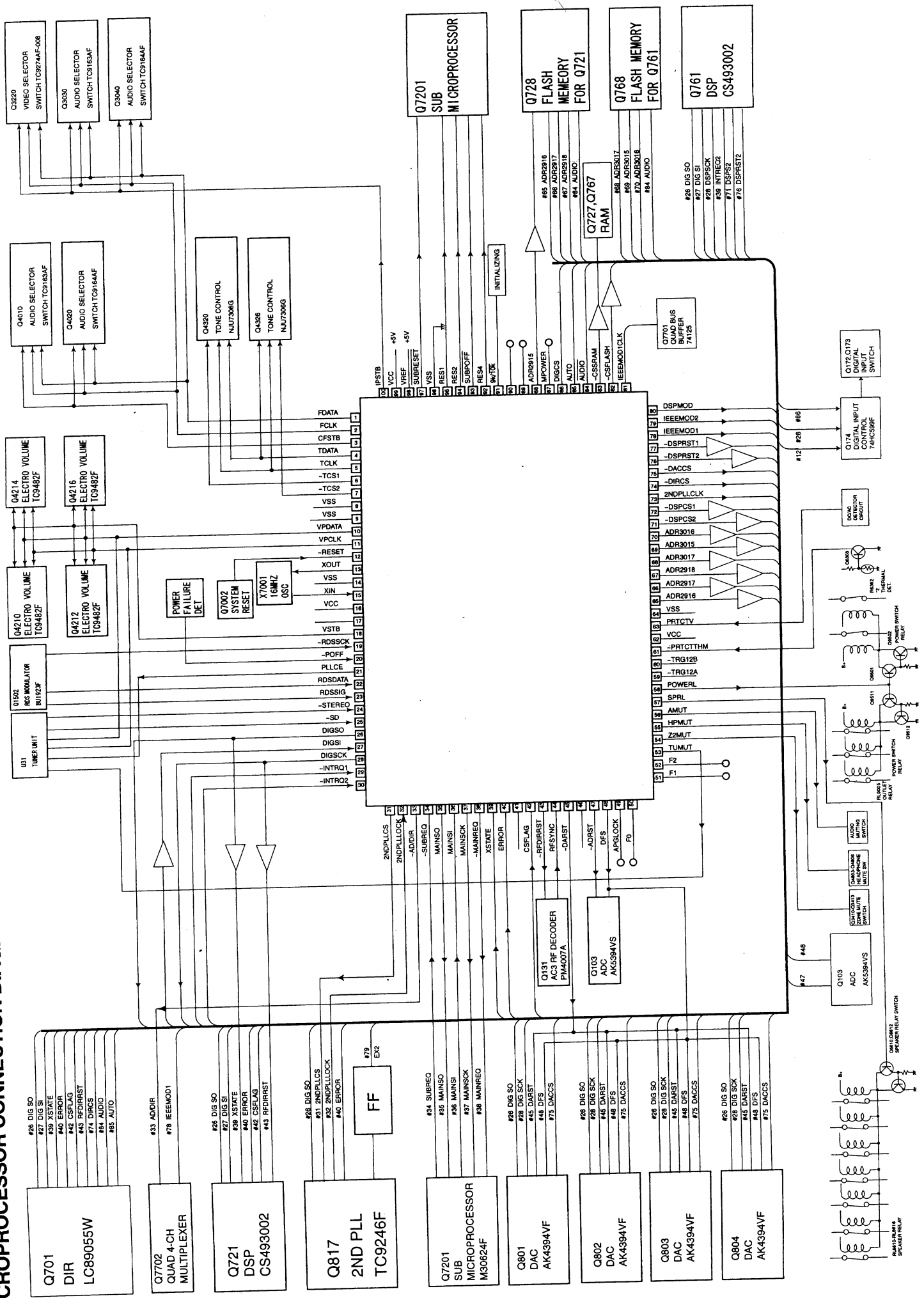

MICROPROCESSOR SECTION DIAGRAM

TX-DS989

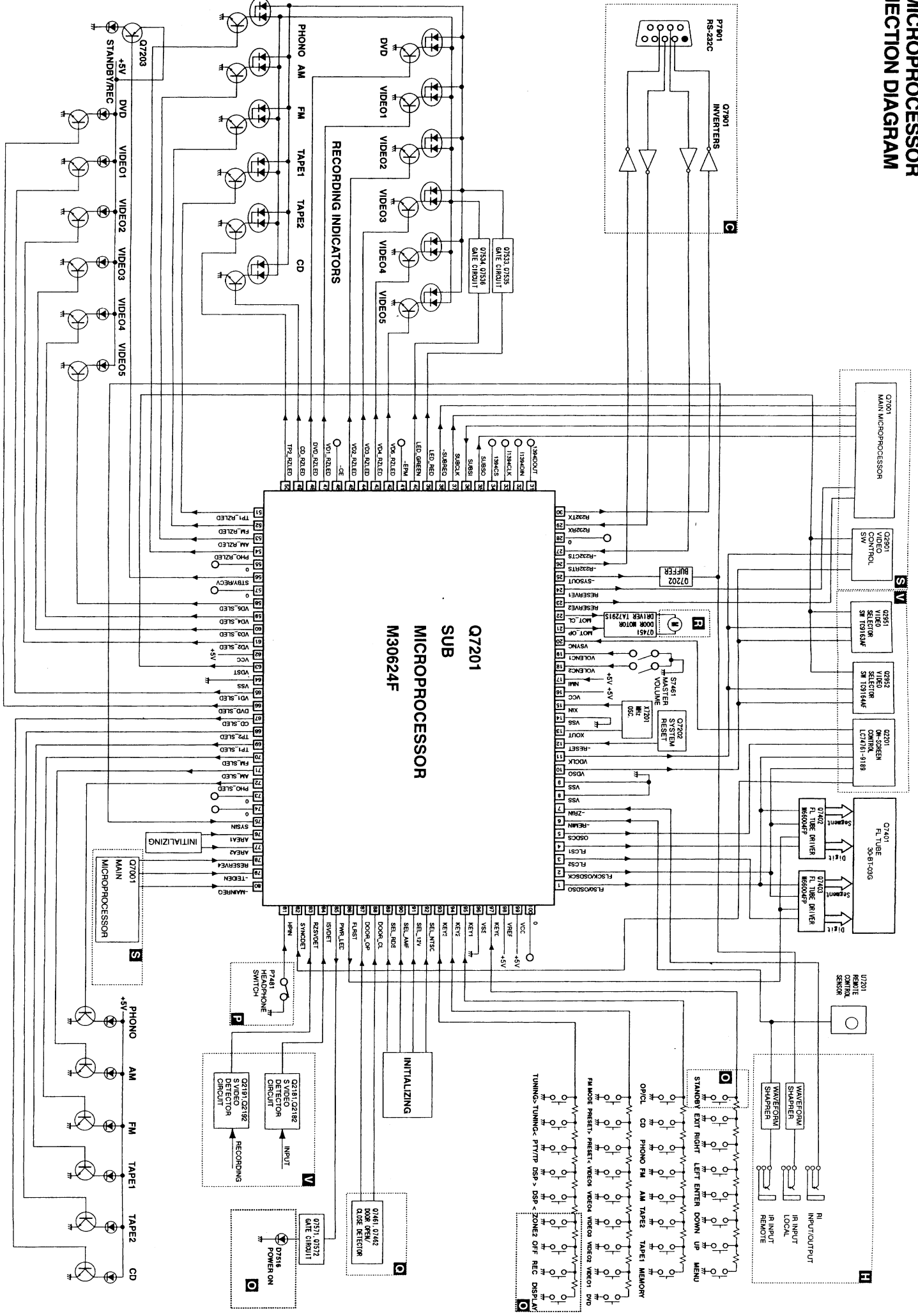

SUB MICROPROCESSOR TERMINAL DESCRIPTION

No.	Function	I/O	Act.	Description	No.	Function	I/O	Act.	Description
1	FLS0/OSDSO	O	0	Serial data output terminal for FL tube driver and on-screen ICs.	51	TP1_RZLED	O	H	Control output terminal for Tape 1 recording or Zone 2 LED.
2	FLSCK/OSDSCK	O	CLK	Serial clock output terminal for FL tube driver and on-screen ICs.	52	FM_RZLED	O	H	Control output terminal for FM recording or Zone 2 LED.
3	FLCS1	O	H	Chip selection output for FL tube driver IC 2.	53	AM_RZLED	O	H	Control output terminal for AM recording or Zone 2 LED.
4	FLCS2	O	H	Chip selection output for FL tube driver IC 1.	54	PHO_RZLED	O	H	Control output terminal for Photo recording or Zone 2 LED.
5	OSDCS	O	H	Chip selection output for on-screen IC.	55		O	0	Not used.
6	-REMIN	I	L	Signal input terminal from remote control.	56	STBY/RECV	O	L	Control output terminal for Standby/Received indicator.
7	-ZRIN	I	L	Signal input terminal from remote control for zone 2.	57		O	0	Not used.
8	VSS			Switch input terminal for external data bus. Connect to ground terminal.	58	VD5_SLED	O	H	Control output pin for Video 5 indicator.
9	VSS			Switch input terminal for processor mode. Connect to ground terminal.	59	VD4_SLED	O	H	Control output terminal for Video 4 indicator.
10	VD5O	O		Serial data output terminal for video function switch IC.	60	VD3_SLED	O	H	Control output terminal for Video 3 indicator.
11	VDCLK	O	CLK	Serial clock output terminal for video function switch IC.	61	VD2_SLED	O	H	Control output terminal for Video 2 indicator.
12	-RESET			Reset input terminal of microprocessor.	62	VCC			Power supply terminal. Connect to 5V.
13	XOUT			Oscillator output terminal of main clock.	63	VDST	O		Chip selection output terminal for video function switch.
14	VSS			Power supply terminal. Connect to ground terminal.	64	VSS			Ground terminal.
15	XIN			Oscillator input terminal of main clock.	65	VD1_SLED	O	H	Control output terminal for Video 1 indicator.
16	VCC			Power supply terminal. Connect to +5V.	66	DVD_SLED	O	H	Control output terminal for DVD indicator.
17	NMI	I	0	Connect to 5V.	67	CD_SLED	O	H	Control output terminal for CD indicator.
18	VOLENC2	I	H	Input B terminal from rotary encoder for main volume.	68	TP2_SLED	O	H	Control output terminal for Tape 2 indicator.
19	VOLENC1	I	H	Input A terminal from rotary encoder for main volume.	69	TP1_SLED	O	H	Control output terminal for Tape 1 indicator.
20	VSYNC	I	H	Video vertical synchronizing signal input terminal to judge synchronizing.	70	FM_SLED	O	H	Control output terminal for Video -1 indicator.
21	MOT_OP	O	H	Control output terminal to open the door.	71	AM_SLED	O	H	Control output terminal for Video -1 indicator.
22	MOT_CL	O	H	Control output terminal to close the door.	72	PHO_SLED	O	H	Control output terminal for Video -1 indicator.
23	RESERVE2	O	H	Transfer request output terminal for main microprocessor.	73		O	0	Not used.
24	RESERVE1	O	H	Transfer request output terminal for main microprocessor.	74		O	0	Not used.
25	-SYSOUT	O	L	RI code output terminal.	75	SYSDIN	I		Input terminal for RI code.
26	-R232RTS	O	L	Transfer request output terminal for RS232C.	76	AREA1	I		Initializing input terminal for tuner band
27	-R232CTS	I	L	Transfer data output terminal for RS232C.	77	AREA2	I		Initializing input terminal for tuner band
28		O	0	Not used.	78	RESERVE4	I		Transfer request input terminal for main microprocessor.
29	R232RX	I	H	Receiving input terminal for RS232C	79	-TEIDEN	I		Detection input terminal of power failure from main microprocessor.
30	R232TX	O	H	Transfer output terminal for RS232C.	80	-MAINREQ	I		transfer request input terminal for main microprocessor.
31	I1394DOUT	O	0	Serial data output terminal for main microprocessor.	81	HPIN	I	H	It is impression KEY input terminal (A/D input of 0) as for 0V.
32	I1394DIN	I		Serial data input terminal for main microprocessor.	82	SYNDET	I	H	External synchronizing signal input terminal for on-screen IC.
33	I1394CLK	O	CLK	Serial clock output terminal for main microprocessor.	83	RZSVDET	I	H	S video signal detection input terminal for recording signal.
34		O	0	Not used.	84	ISVDET	I	H	S video signal detection input terminal for input signal.
35	SUBSO	O	L	Serial data output terminal to main microprocessor.	85	PWR_LED	O	H	Control output terminal for Power LED.
36	SUBSI	I	L	Serial data input terminal from main microprocessor.	86	FLRST	O	L	Reset terminal for FL tube driver IC
37	SUBCLK	O	CLK	Serial clock input terminal from main microprocessor	87	DOOR_OP	I	L	Detection input terminal to open the door.
38	-SUBREQ	O	L	Request signal output terminal to main microprocessor.	88	DOOR_CL	I	L	Detection input terminal to close the door.
39	LED_RED	O	H	Output terminal to light up the red LED.	89	SEL_RDS	I	H	Initializing input terminal for RDS broadcast
40	LED_GREEN	O	H	Output terminal to light up green LED.	90	SEL_AMP	I	H	Initializing input terminal for main amplifier
41	-EPM	O	L	EPM input terminal to write program.	91	SEL_12V	I	H	Initializing input terminal for 12V trigger
42	VD5_RZLED	O	H	Control output terminal for Video 5 recording or Zone 2 LED.	92	SEL_NTSC	I	H	Initializing input terminal for NTSC.
43	VD4_RZLED	O	H	Control output terminal for Video 4 recording or Zone 2 LED.	93	KEY3	I		Operation key connection input terminal
44	VD3_RZLED	O	H	Control output terminal for Video 3 recording or Zone 2 LED.	94	KEY2	I		Operation key connection input terminal
45	VD2_RZLED	O	H	Control output terminal for Video 2 recording or Zone 2 LED.	95	KEY1	I		Operation key connection input terminal
46	-CE	O	L	Chip enable input terminal to write program.	96	VSS			Power supply terminal for AD converter. Connect to ground terminal.
47	VD1_RZLED	O	H	Control output terminal for Video 1 recording or Zone 2 LED.	97	KEY0	I		Operation key connection input terminal
48	DVD_RZLED	O	H	Control output terminal for DVD recording or Zone 2 LED.	98	VREF			Reference voltage input terminal for AD converter.
49	CD_RZLED	O	H	Control output terminal for CD recording or Zone 2 LED.	99	VCC			Power supply terminal for AD converter.
50	TP2_RZLED	O	H	Control output terminal for Tape 2 recording or Zone 2 LED.	100		O	0	Not used.

FL TUBE VIEW

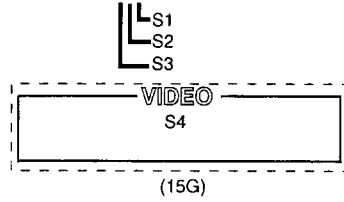
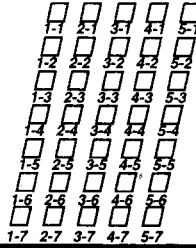
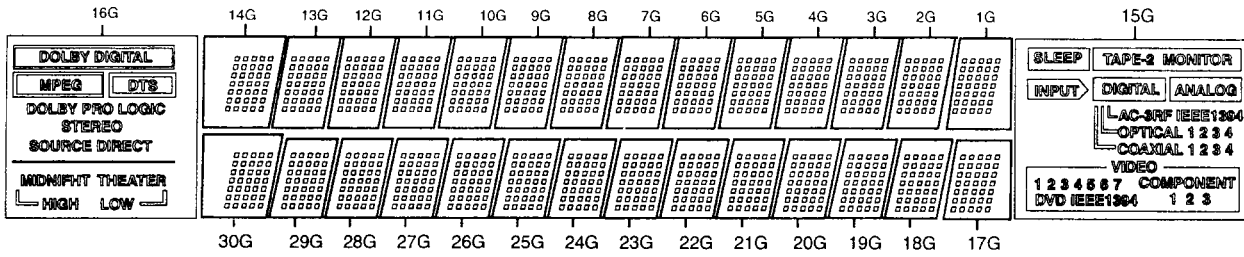

	30G~17G	16G	15G	14G~1G		30G~17G	16G	15G	14G~1G
P1	—	—	SLEEP	1-1	P36	1-1	—	—	—
P2	—	—	TAPE-2 MONITOR	2-1	P37	2-1	—	—	—
P3	—	—	INPUT	3-1	P38	3-1	—	—	—
P4	—	—	DIGITAL	4-1	P39	4-1	—	—	—
P5	—	—	ANALOG	5-1	P40	5-1	—	—	—
P6	—	—	—	1-2	P41	1-2	—	—	—
P7	—	—	S1	2-2	P42	2-2	—	—	—
P8	—	—	AC-SRF	3-2	P43	3-2	—	—	—
P9	—	—	IEEE1394	4-2	P44	4-2	—	—	—
P10	—	—	S2	5-2	P45	5-2	—	—	—
P11	—	—	OPTICAL	1-3	P46	1-3	—	—	—
P12	—	—	1 (OPTICAL)	2-3	P47	2-3	—	—	—
P13	—	—	2 (OPTICAL)	3-3	P48	3-3	—	—	—
P14	—	—	3 (OPTICAL)	4-3	P49	4-3	—	—	—
P15	—	—	4 (OPTICAL)	5-3	P50	5-3	—	—	—
P16	—	—	S3	1-4	P51	1-4	—	—	—
P17	—	—	COAXIAL	2-4	P52	2-4	—	—	—
P18	—	—	1 (COAXIAL)	3-4	P53	3-4	—	—	—
P19	—	—	2 (COAXIAL)	4-4	P54	4-4	—	—	—
P20	—	—	3 (COAXIAL)	5-4	P55	5-4	—	—	—
P21	—	—	4 (COAXIAL)	1-5	P56	1-5	—	—	—
P22	—	—	S4	2-5	P57	2-5	—	—	—
P23	—	DOLBY DIGITAL	1 (VIDEO)	3-5	P58	3-5	—	—	—
P24	—	(DOLBY DIGITAL)	2 (VIDEO)	4-5	P59	4-5	—	—	—
P25	—	MPEG	3 (VIDEO)	5-5	P60	5-5	—	—	—
P26	—	(MPEG)	4 (VIDEO)	1-6	P61	1-6	—	—	—
P27	—	DTS	5 (VIDEO)	2-6	P62	2-6	—	—	—
P28	—	(DTS)	6 (VIDEO)	3-6	P63	3-6	—	—	—
P29	—	DOLBY PRO LOGIC	7 (VIDEO)	4-6	P64	4-6	—	—	—
P30	—	STEREO	DVD	5-6	P65	5-6	—	—	—
P31	—	SOURCE DIRECT	IEEE1394	1-7	P66	1-7	—	—	—
P32	—	—	COMPONENT	2-7	P67	2-7	—	—	—
P33	—	MIDNIGHT THEATER	1 (COMPONENT)	3-7	P68	3-7	—	—	—
P34	—	L-HIGH	2 (COMPONENT)	4-7	P69	4-7	—	—	—
P35	—	LOW	3 (COMPONENT)	5-7	P70	5-7	—	—	—

BOARD CONNECTION VIEW

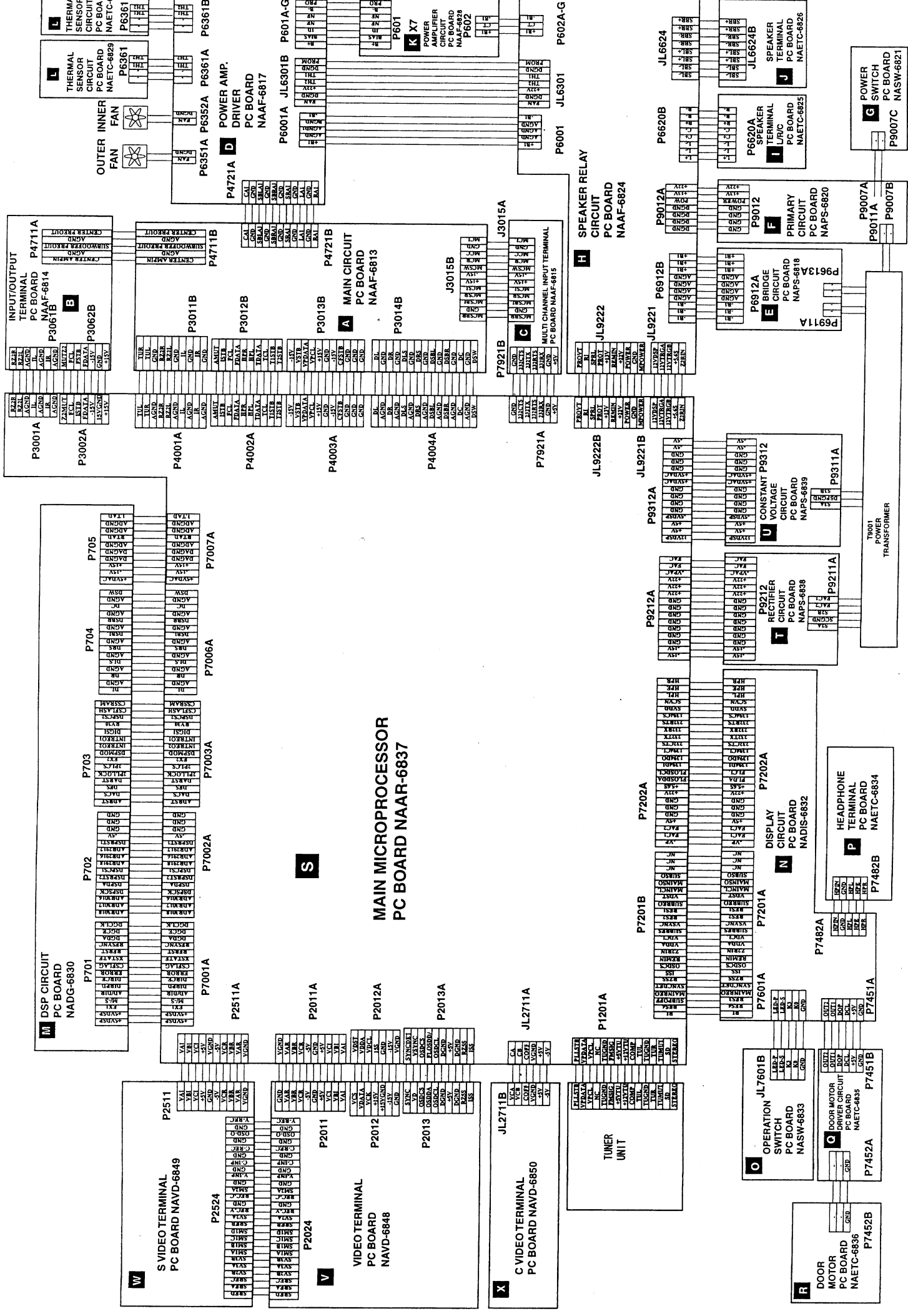

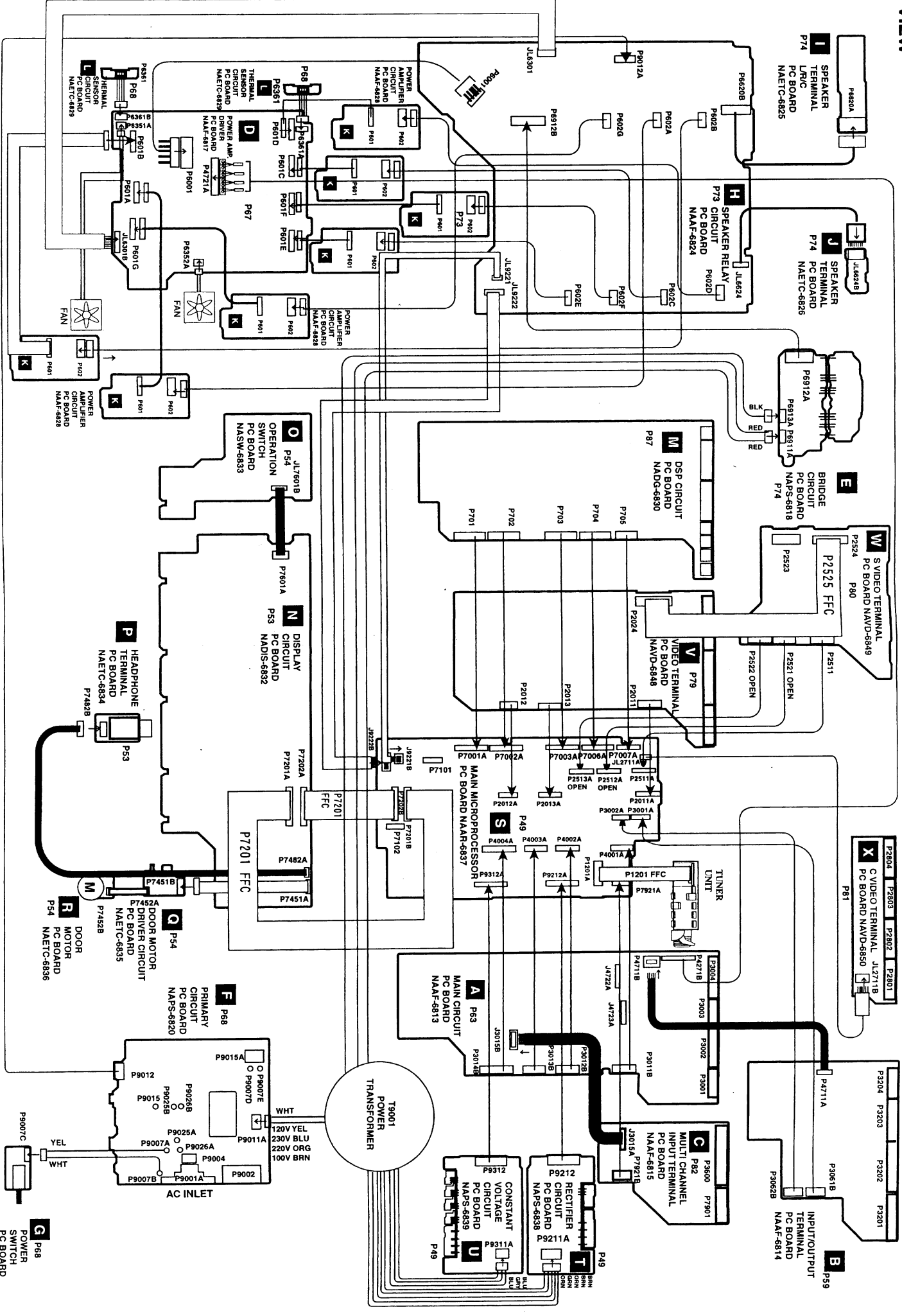

G P88
POWER SWITCH
PC BOARD
NASW-6821

BLOCK DIAGRAM

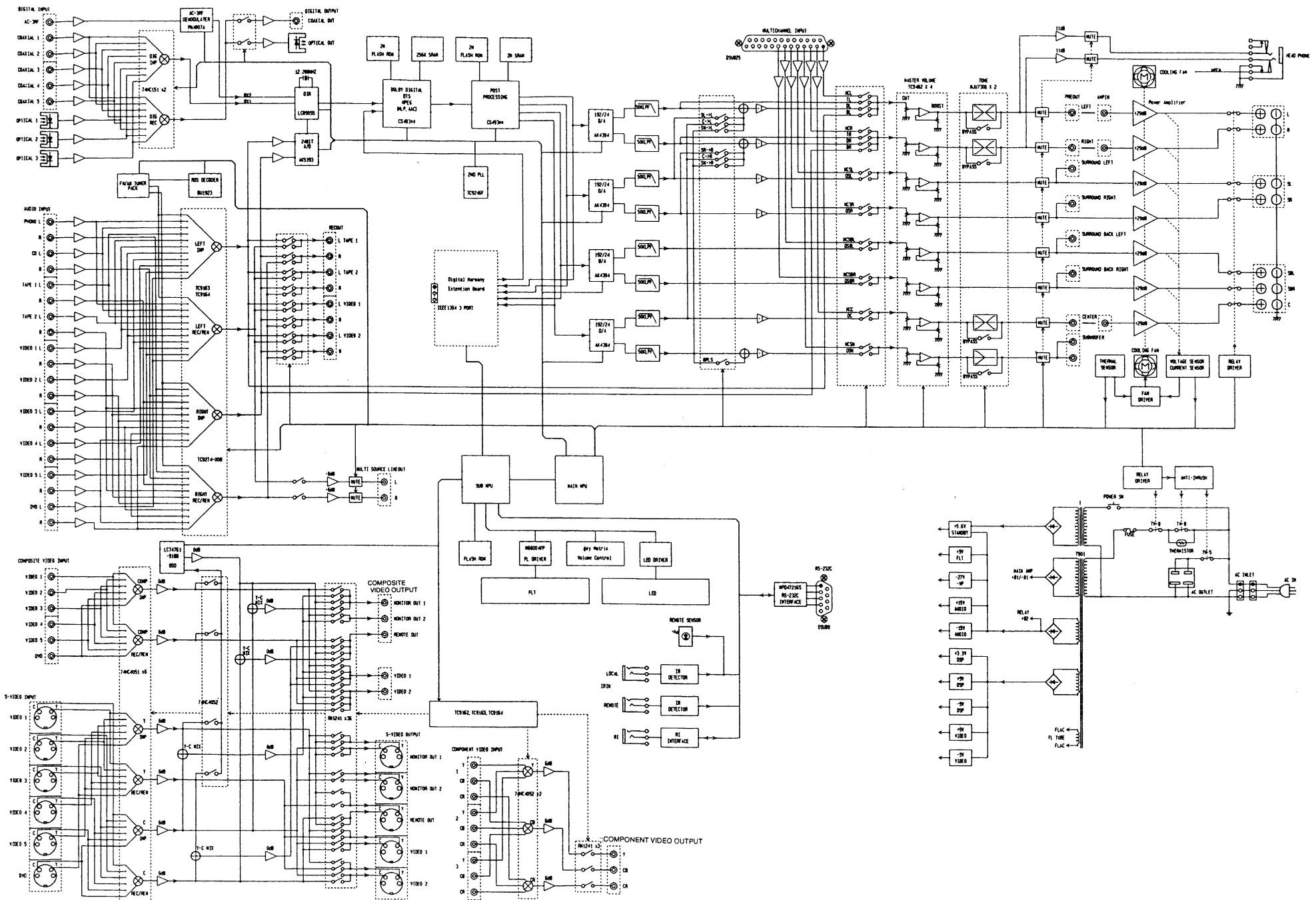

PRINTED CIRCUIT BOARD-PARTS LIST

MAIN MICROPROCESSOR CIRCUIT PC BOARD (NAAR-6837-1A/1B/1C) CIRCUIT NO.

CIRCUIT NO.	PART NO.	DESCRIPTION	PART NO.	DESCRIPTION	
			Sockets		
			JL2711A	25051090 NSCT-6P877	
			P1201A	25052211 NSCT-15P2108	
			P7201B,P7202A	25052220 NSCT-24P2117	
			Plugs		
			JL9221B	25055626 NPLG-5P588	
			JL9222B	25055631 NPLG-10P593	
			P2011A	25055412 NPLG-10P394	
			P2012A	25055409 NPLG-7P391	
			P2013A	25055412 NPLG-10P394	
			P2511A-P2513A	25055412 NPLG-10P394	
			P3001A,P3002A	25055409 NPLG-7P391	
			P4001A-P4003A	25055412 NPLG-10P394	
			P4004A	25055417 NPLG-15P399	
			P7001A-P7003A	25055417 NPLG-15P399	
			P7006A	25055417 NPLG-15P399	
			P7007A	25055412 NPLG-10P394	
			P7101A,P7102A	25055704 NPLG-8P660	
			P7921A	25055409 NPLG-7P391	
			P9212A,P9312A	25055417 NPLG-15P399	
			Heat sinks		
			Q9203A	27160466 RAD-136	
			Q9231A	27160357 (S3)	
			Q9323A	27160209 RAD-67	
			Screws		
			Q9203B,Q9323B	82143010 3P+10FN(BC)	
			Q9231B,Q9232B	838430088 3TTB+8B(BC)	
			RECTIFIER CIRCUIT PC BOARD (NAPS-6838-1A/1B/1C)		
			CIRCUIT NO.	PART NO.	DESCRIPTION
				IC	
			Q9202	222790155MI	M5F79M15L
				Diode	
			D9201	22380022F or	RBV402 or
				22380285F	RS403M
				Capacitors	
			C9205-C9211	394062227	2200 μ F,35V, Elect.
			C9214	353780229	2.2 μ F,50V, Elect.
			C9216	353741009	10 μ F,16V, Elect.
				Thermistors	
			R9201,R9202	4000197	RUE700
				Resistors	
			R9208,R9210	452730394F	3.9 Ω \pm 5%,2W, Metal
			R9211,R9231	453532294	0.22 Ω \pm 5%,1/2W, Metal
			R9221	453530824	8.2 Ω \pm 5%,1/2W, Metal
			R9401	453530224	2.2 Ω \pm 5%,1/2W, Metal
				Socket	
			P9212	25050683	NSCT-15P487
				Plug	
			P9211A	25055177	NPLG-5P161
			CONSTANT VOLTAGE CIRCUIT PC BOARD (NAPS-6839-1A/1B/1C)		
			CIRCUIT NO.	PART NO.	DESCRIPTION
				ICs	
			Q9302	222780053JRC	NJM78L05A
			Q9303,Q9322	222790055JRC	NJM79M05FA
			Q9304	222780055JRC	NJM78M05FA
				Transistor	
			Q9301	2202176	2SB1370-F
				Diode	
			D9301	22380022F or	RBV402 or
				22380285F	RS403M
				Capacitors	
			C9305-C9309	394043327	3300 μ F,16V, Elect.
			C9311,C9314	353741009	10 μ F,16V, Elect.
			C9312,C9323	353780229	2.2 μ F,50V, Elect.
			C9316,C9325	353741009	10 μ F,16V, Elect.
Q1502	22241297R2	BU1923F <P>			
Q1701	222780125JRCW	NJM78M12FA			
Q1702	222780053JRC	NJM78L05A			
Q2901	22240981R2	TC9162AF			
Q4801	22241383R2	NJM4565M-D			
Q4821	22241449R2 or	NJM5532M-D or			
	22241409R2	BA15532F			
Q7001	22241363M989	M30624FGFP or			
	No spare part	M30624FGAFP			
Q9203	222780155MI	M5F78M15L			
Q9231	222780565JRC	NJM78M56FA			
Q9232	222780055JRC	NJM78M05FA			
Q9323	222780055JRC	NJM78M05FA			
		Transistors			
Q1501	2213143R2	2SC2712-O <P>			
Q4803-Q4806	2215410R2	RN1441			
Q7002	2214490R2	RN1404			
Q7101	2214530R2	RN2402			
Q7102,Q7104	2213143R2	2SC2712-O			
Q7103,Q7105	2214530R2	RN2402			
Q7106	2213143R2	2SC2712-O			
Q9221	2211644 or	2SA965-Y or			
	2211643	2SA965-O			
		Diodes			
D7001,D7002	223234R2	1SS352			
D7004-D7006	223234R2	1SS352			
D7003	224490620R2	UDZ6.2B			
D9221,D9222	22380260 or	RL1N4003 or			
D9231-D9233	22380035	GP104003E			
D9223	224493300R2	UDZ33B			
D9251-D9254	223234R2	1SS352			
		Coils			
L1501	231237M022R2	NCH-1471 <P>			
L7001	231237M022R2	NCH-1471			
		Crystals			
X1501	3010321	HC-49/U034.332MHz <P>			
X7001	3010322	CST16.00MXW0C1			
		Capacitors			
C1503	355721019	100 μ F,6.3V, Elect. <P>			
C1505	354721019	100 μ F,6.3V, Elect. <P>			
C1512,C7025	354780339	3.3 μ F,50V, Elect.			
C1521,C1702	354741009	10 μ F,16V, Elect.			
C1704	354741009	10 μ F,16V, Elect.			
C4801-C4808	354741009	10 μ F,16V, Elect.			
C7001,C7002	354721019	100 μ F,6.3V, Elect.			
C7007	354780109	1 μ F,50V, Elect.			
C7009	3000078	DX-5R5L104,Super			
C7010	375524744	0.47 μ F \pm 5%,50V,Plastic			
C7012	354722219	220 μ F,6.3V, Elect.			
C7101-C7103	354741009	10 μ F,16V, Elect.			
C9213	353741009	10 μ F,16V, Elect.			
C9221,C9222	354781019	100 μ F,50V, Elect.			
C9223,C9224	354780229	2.2 μ F,50V, Elect.			
C9231	354751029	1000 μ F,25V, Elect.			
C9234,C9235	354741019	100 μ F,16V, Elect.			
C9251	354741019	100 μ F,16V, Elect.			
C9326	353780229	2.2 μ F,50V, Elect.			
		Resistors			
R2904	49163103406	RM1/10J-10K*6			
R9203	452730394F	3.9 Ω \pm 5%,2W, Metal			
R9207	452730394F	3.9 Ω \pm 5%,2W, Metal			
R9222	453530824	8.2 Ω \pm 5%,1/2W, Metal			
R9232	443522204	22 Ω \pm 5%,1/2W, Metal oxide			
R9233	443522204	22 Ω \pm 5%,1/2W, Metal oxide			
R9321	452730394F	3.9 Ω \pm 5%,2W, Metal			

NOTE: <D>: 120V model only
 <P>: European model only
 <PT>: Asian model only for 230V
 <DT>: Asian model only for 120V
 <GT>: 220V model only
 <A>: Australian model only
 : Black model only
 <S>: Silver model only
 <G>: Golden model only

CIRCUIT NO. PART NO. DESCRIPTION

Thermistors		
R9301,R9302	4000197	RUE700
Resistors		
R9303,R9306	452730394F	3.9Ω ±5%,2W, Metal
R9305	453530474	4.7Ω ±5%,1/2W, Metal
R9307,R9309	453532294	0.22Ω ±5%,1/2W, Metal
R9322	452730394F	3.9Ω ±5%,2W, Metal
R9324	453532294	0.22Ω ±5%,1/2W, Metal
Socket		
P9312	25050683	NSCT-15P487
Plug		
P9311A	25055175	NPLG-3P159

NOTE: <D>: 120V model only
 <P>: European model only
 <PT>: Asian model only for 230V
 <DT>: Asian model only for 120V
 <G>: 220V model only
 <A>: Australian model only
 <J>: Japanese model only

TC9162AF (Analog Switch)

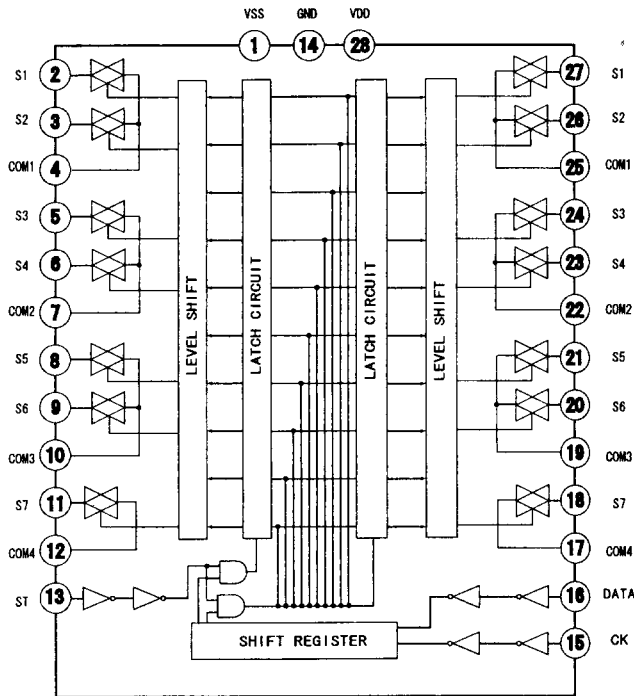

Pin No.	Symbol	Function
1	VSS	Negative power supply
14	GND	Ground
28	VDD	Positive power supply
2, 3, 5, 6, 8, 9, 11	S1~S7	Input/output terminals
27, 26, 24, 23, 21, 20, 18	S1~S7	Input/output terminals
4, 7, 10, 12	COM1~COM4	Common terminals
25, 22, 19, 17	COM1~COM4	Common terminals
13	ST	Strobe input terminal for data reading
15	CK	Clock input terminal for data transfer
16	DATA	Data input terminal for switch

BU1923F (RDS Decoder)

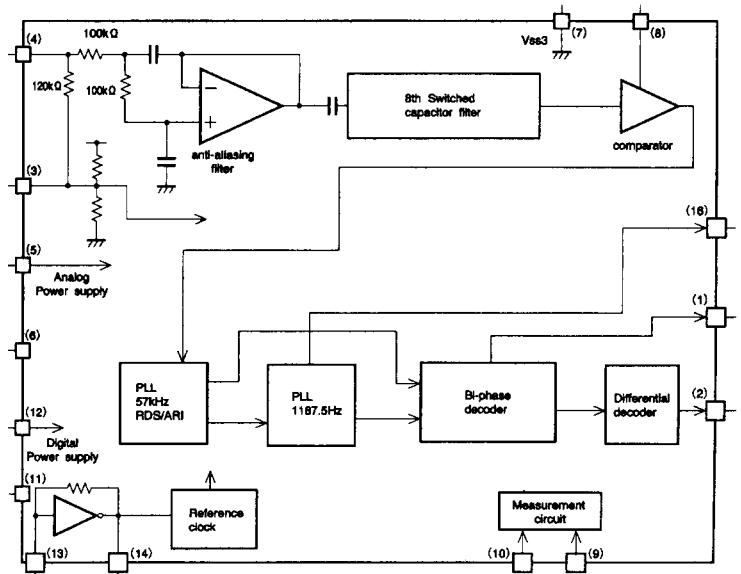
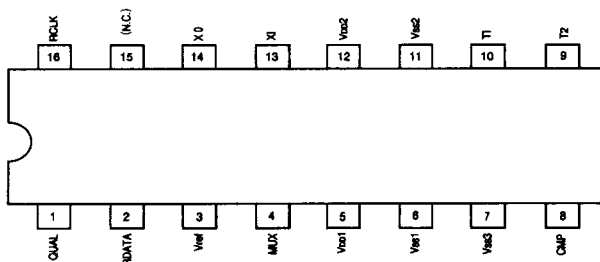

SCHEMATIC DIAGRAM

Display, Sub microprocessor

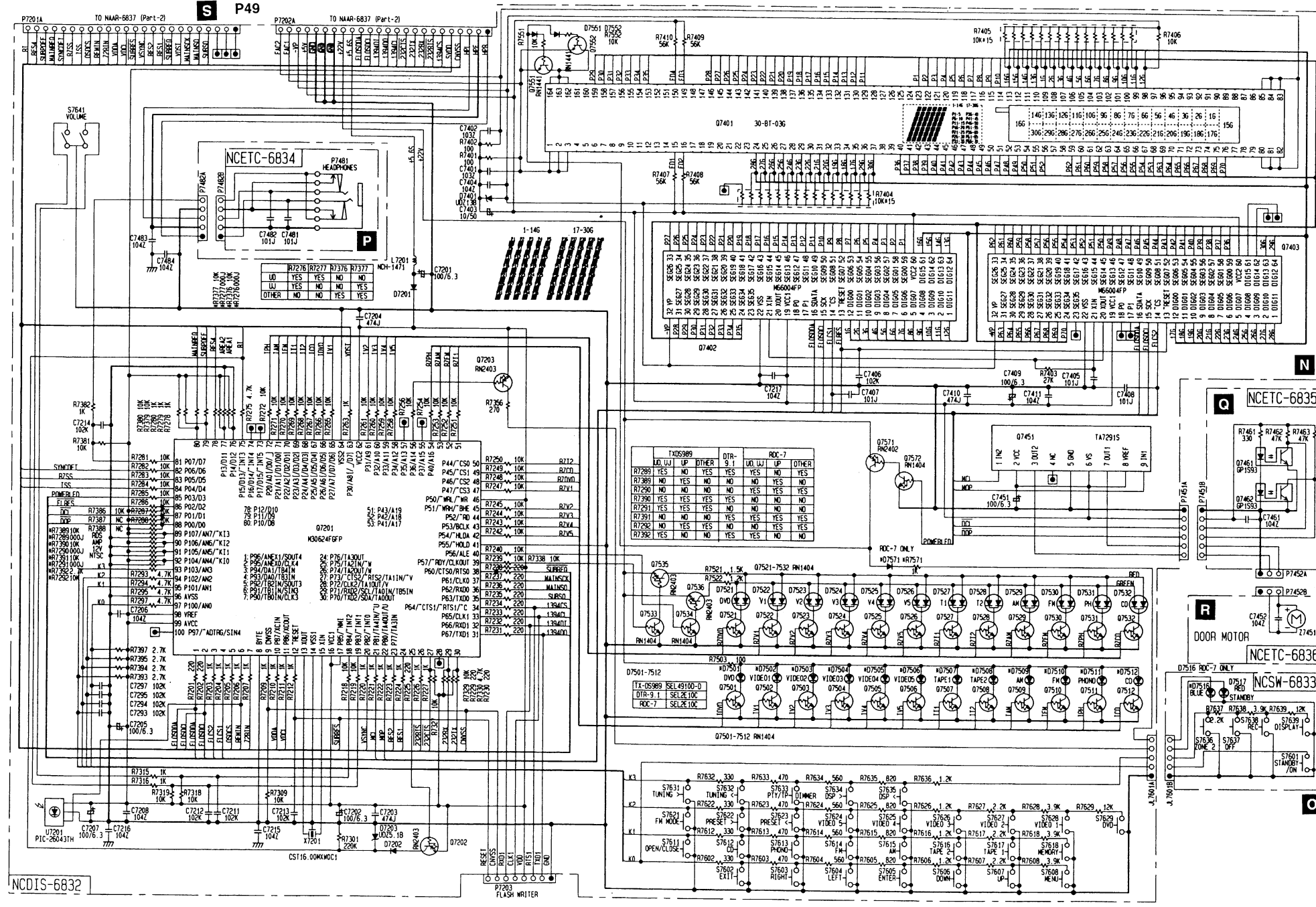

PRINTED CIRCUIT BOARD-PARTS LIST

DISPLAY CIRCUIT PC BOARD (NADIS-6832-1A/1B/1C/1D)

CIRCUIT NO.	PART NO.	DESCRIPTION
FL tube		
Q7401	212208	30-BT-03G
Remote sensor		
U7201	241329	PIC-26043TH2
ICs		
Q7201	22241363S989	M30624FGFP or
	No spare part	M30624FGAFP
Q7402,Q7403	22240685R9	M66004FP
Q7451	22240239	TA7291S
Transistors		
Q7202,Q7203	2214540R2	RN2403
Q7501-Q7512	2214470R2	RN1402
Q7521-Q7532	2214470R2	RN1402
Q7533,Q7534	2214490R2	RN1404
Q7535,Q7536	2214540R2	RN2403
Q7551,Q7552	2215410R2	RN1441
Q7571	2214540R2	RN2403
Q7572	2214470R2	RN1402
Diodes		
D7201,D7202	223234R2	1SS352
D7203	224490510R2	UDZ5.1B
D7401	224491300R2	UDZ13B
D7501-D7512	225291DT	SEL4910D-D
D7521-D7532	225375	SML1216C
D7551,D7552	223234R2	1SS352
Oscillator		
X7201	3010322	CST16.000MXW0C1
Coils		
L7201	231237M022R2	NCH-1471
L7202	233454K220	NCH-1452 220K
R7201,R7202	230921R2	BLM21B222SPT
Capacitors		
C7201,C7202	355721019	100 μ F,6.3V, Elect.
C7203,C7204	375524744	0.47 μ F \pm 5%,50V,Plastic
C7205,C7207	355721019	100 μ F,6.3V, Elect.
C7403	355781009	10 μ F,50V, Elect.
C7409,C7451	355721019	100 μ F,6.3V, Elect.
C7410	375524744	0.47 μ F \pm 5%,50V,Plastic
C7412-C7414	375524744	0.47 μ F \pm 5%,50V,Plastic
Resistors		
R7404,R7405	49163103415	RM1/10J-10K*15,Array
R7504	453530474	4.7 Ω \pm 5%,1/2W, Metal
Rotary encoder		
S7641	25065595	EC16B3625,Volume
Switches		
S7602-S7608	25035699	NPS-111-S662
S7611-S7618	25035699	NPS-111-S662
S7621-S7629	25035699	NPS-111-S662
S7631-S7635	25035699	NPS-111-S662
Sockets		
P7201,P7202	25052220	NSCT-24P2117
P7451A	2002E391215	NSAS-12P0796
P7482A	2009990587UL	NSAS-10P0798
JL7601A	25051089	NSCT-5P876
Holder		
Q7401A	27190987	(FL)

OPERATION SWITCH PC BOARD (NASW-6833-1A/1B/1C/1D)

CIRCUIT NO.	PART NO.	DESCRIPTION
D7516	225290	SEL4110R,LED
JL7601B	25051089	NSCT-5P876,Socket
S7601	25035699	NPS-111-S662,Push switch
S7636-S7639	25035699	NPS-111-S662,Push switch

HEADPHONE TERMINAL PC BOARD (NAETC-6834-1A/1B/1C/1D)

CIRCUIT NO.	PART NO.	DESCRIPTION
P7481	25045385	YKB26-5153,Headphone
P7482B	25055369	NPLG-5P352,Plug

DOOR MOTOR DRIVE CIRCUIT PC BOARD (NAETC-6835-1A/1B/1C/1D)

CIRCUIT NO.	PART NO.	DESCRIPTION
P7451B	25055370	NPLG-6P353,Plug
Q7461,Q7462	24120081	GP1S93,Photo coupler

DOOR MOTOR PC BOARD (NAETC-6836-1A/1B/1C/1D)

CIRCUIT NO.	PART NO.	DESCRIPTION
P7452	200EE390615	NSAS-6P0795, Socket

TA7291S (Motor Driver)

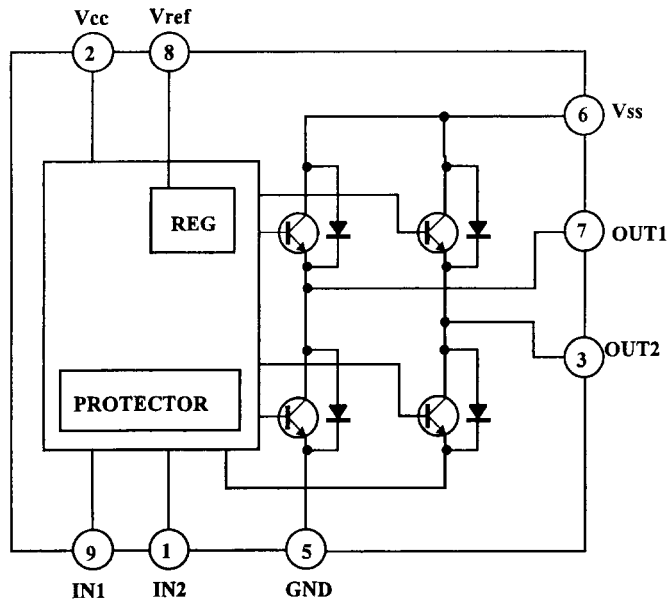

INPUT		OUTPUT		MODE
IN1	IN2	OUT1	OUT2	
0	0	∞	∞	STOP
1	0	H	L	CW/CCW
0	1	L	H	CCW/CW
1	1	L	L	BRAKE

CCW:Counter-clockwise direction

CW:Clockwise direction

PRINTED CIRCUIT BOARD-PARTS LIST

MAIN CIRCUIT PC BOARD (NAAF-6813-1A/1B)

CIRCUIT NO.	PART NO.	DESCRIPTION	CIRCUIT NO.	PART NO.	DESCRIPTION
	ICs			Capacitors	
Q3000,Q3020	22241448R2	NJM4580M-D	C4386	374724724	4700pF±5%,50V,Plastic
Q3022,Q3024	22241448R2	NJM4580M-D	C4500,C4501	393884707	47 μ F,50V, Elect.
Q3030,Q4010	22240943R2	TC9163AF	C4502-C4505	393384707	47 μ F,50V, Elect.
Q3040,Q4020	22241221R2	TC9164AF	C4506,C4507	393884707	47 μ F,50V, Elect.
Q4000,Q4006	22241472R2	NJM2114M-D	C4510-C4515	374723324	3300pF±5%,50V,Plastic <D/I>
Q4002	22241448R2	NJM4580M-D		374722224	220pF±10%,50V,Plastic <P/PT/DT/G/A>
Q4200,Q4202	22241449R2 or	NJM5532M-D or	C4520,C4521	374721015	100pF±10%,50V,Plastic <D/I>
Q4204,Q4206	22241409R2	BA15532F		374724714	470pF±5%,50V,Plastic <P/PT/DT/G/A>
Q4210,Q4212	22241444R2	TC9482F	C4608	393362217	220 μ F,35V, Elect.
Q4214,Q4216	22241444R2	TC9482F	C4700	354721019	100 μ F,6.3V, Elect.
Q4300,Q4306	22241450R2	NJM2082M-D		Terminals	
Q4310,Q4316	22241449R2 or	NJM5532M-D or	P3001	25045615	NPJ-4PDRW422,CD/PHONO
	22241409R2	BA15532F	P3002	25045618 or	NPJ-6PDRW425 or
Q4320,Q4326	22241451R9	NJU7306G		25045318	NPJ-6PDBL175,TAPE2
	Transistors		P3003	25045616 or	NPJ-4PDRW423 or
Q4500-Q4507	2213631 or	RN1241-A or		25045491	NPJ-4PDBL308
Q4510-Q4517	2213632	RN1241-B	P3004	25045623	NPJ-6PDRW430
	Diode			Sockets	
D4700	224490510R2	UDZ5.1B	J3015B	25051096	NSCT-12P883
	Capacitors		J4711B	25050282	NSCT-5P110
C3000,C3001	374721015	100pF±10%,50V,Plastic <D/I>	P3011B-P3013B	25050678	NSCT-10P482
C3000,C3001	374722215	220pF±10%,50V,Plastic <P/PT/DT/G/A>	P3014B	25050683	NSCT-15P487
C3002,C3003	393384707	47 μ F,50V, Elect.	P4721	2009990605	NSAS-26P0819
C3004,C3005	374721524	1500pF±5%,50V,Plastic <P/PT/DT/G/A>		Bars	
C3006,C3007	393381017	100 μ F,50V, Elect.	P3031,P4032	27141754	BBL60
C3008,C3009	374726824	6800pF±5%,50V,Plastic	P4031,P4033	27141753	BBL50
C3010,C3011	374721824	1800pF±5%,50V,Plastic	P4034	27141754	BBL60
C3012,C3013	393384707	47 μ F,50V, Elect.	P4035	27141753	BBL50
C3020-C3025	374721015	100pF±10%,50V,Plastic <D/I>		INPUT/OUTPUT TERMINAL PC BOARD (NAAF-6814-1A/1B)	
C3020-C3025	374724714	470pF±5%,50V,Plastic <P/PT/DT/G/A>	CIRCUIT NO.	PART NO.	DESCRIPTION
C3026,C3027	393884707	47 μ F,50V, Elect.		ICs	
C3028-C3031	393384707	47 μ F,50V, Elect.	Q3200,Q3202	22241448R2	NJM4580M-D
C3110-C3113	393344707	47 μ F,16V, Elect.	Q3204,Q3206	22241448R2	NJM4580M-D
C3116,C3117	393344717	470 μ F,16V, Elect.	Q3208,Q3210	22241448R2	NJM4580M-D
C4000-C4003	363153304	33pF±5%,500V,Plastic	Q3220	22240829	TC9274N-008
C4006,C4350	363153304	33pF±5%,500V,Plastic	Q3400	22241448R2	NJM4580M-D
C4007,C4357	374721024	1000pF±5%,50V,Plastic		Transistors	
C4100,C4101	393884707	47 μ F,50V, Elect.	Q3410-Q3413	2213631 or	RN1241-A or
C4110,C4111	355744709	47 μ F,16V, Elect.		2213632	RN1241-B
C4114,C4115	355744709	47 μ F,16V, Elect.		Capacitors	
C4120,C4121	393384707	47 μ F,50V, Elect.	C3200-C3211	374721015	100pF±10%,50V,Plastic <D/I>
C4122,C4123	355744709	47 μ F,16V, Elect.		374724714	470pF±5%,50V,Plastic <P/PT/DT/G/A>
C4126,C4127	393384707	47 μ F,50V, Elect.	C3212,C3213	393884707	47 μ F,50V, Elect.
C4200,C4201	393884707	47 μ F,50V, Elect.	C3214-C3223	393384707	47 μ F,50V, Elect.
C4203-C4205	393384707	47 μ F,50V, Elect.	C3310,C3311	393344707	47 μ F,16V, Elect.
C4206,C4207	393884707	47 μ F,50V, Elect.	C3314,C3315	393344707	47 μ F,16V, Elect.
C4210,C4211	393884707	47 μ F,50V, Elect.	C3400-C3403	393384707	47 μ F,50V, Elect.
C4212-C4215	393384707	47 μ F,50V, Elect.	C3404,C3405	374721024	1000pF±5%,50V,Plastic
C4216,C4217	393884707	47 μ F,50V, Elect.	C4516	374722224	2200pF±5%,50V,Plastic <P/PT/DT/G/A>
C4220,C4221	393880227	2.2 μ F,50V, Elect.		374723324	3300pF±5%,50V,Plastic <D/I>
C4222-C4225	393380227	2.2 μ F,50V, Elect.	C4517	374721044	0.1 μ F±5%,50V,Plastic
C4226,C4227	393880227	2.2 μ F,50V, Elect.	C4526	374721015	100pF±10%,50V,Plastic <D/I>
C4230,C4231	393884707	47 μ F,50V, Elect.		374724714	470pF±5%,50V,Plastic <P/PT/DT/G/A>
C4232-C4235	393384707	47 μ F,50V, Elect.		Terminals	
C4236,C4237	393884707	47 μ F,50V, Elect.	P3201-P3203	25045618 or	NPJ-6PDRW425 or
C4240-C4246	363151002	10pF±0.5pF,500V,Plastic		25045318	NPJ-6PDBL175
C4247	374722224	2200pF±5%,50V,Plastic	P3204	25045613 or	NPJ-4PDB420 or
C4300,C4301	393884707	47 μ F,50V, Elect.		25045614	NPJ-4PDB421
C4306,C4307	393884707	47 μ F,50V, Elect.		Sockets	
C4351,C4356	363153304	33pF±5%,500V,Plastic	J4711A	25051109	NSCT-5P896
C4360,C4361	393341007	10 μ F,16V, Elect.	P3061B,P3062B	25050675	NSCT-7P479
C4366	393341007	10 μ F,16V, Elect.			
C4370,C4371	374721044	0.1 μ F±5%,50V,Plastic			
C4376	374721044	0.1 μ F±5%,50V,Plastic			
C4380,C4381	374724724	4700pF±5%,50V,Plastic			

NOTE: <D>: 120V model only
 <P>: European model only
 <PT>: Asian model only for 230V
 <DT>: Asian model only for 120V
 <GT>: 220V model only
 <A>: Australian model only
 : Black model only
 <S>: Silver model only
 <G>: Golden model only

SCHEMATIC DIAGRAM

Audio 1

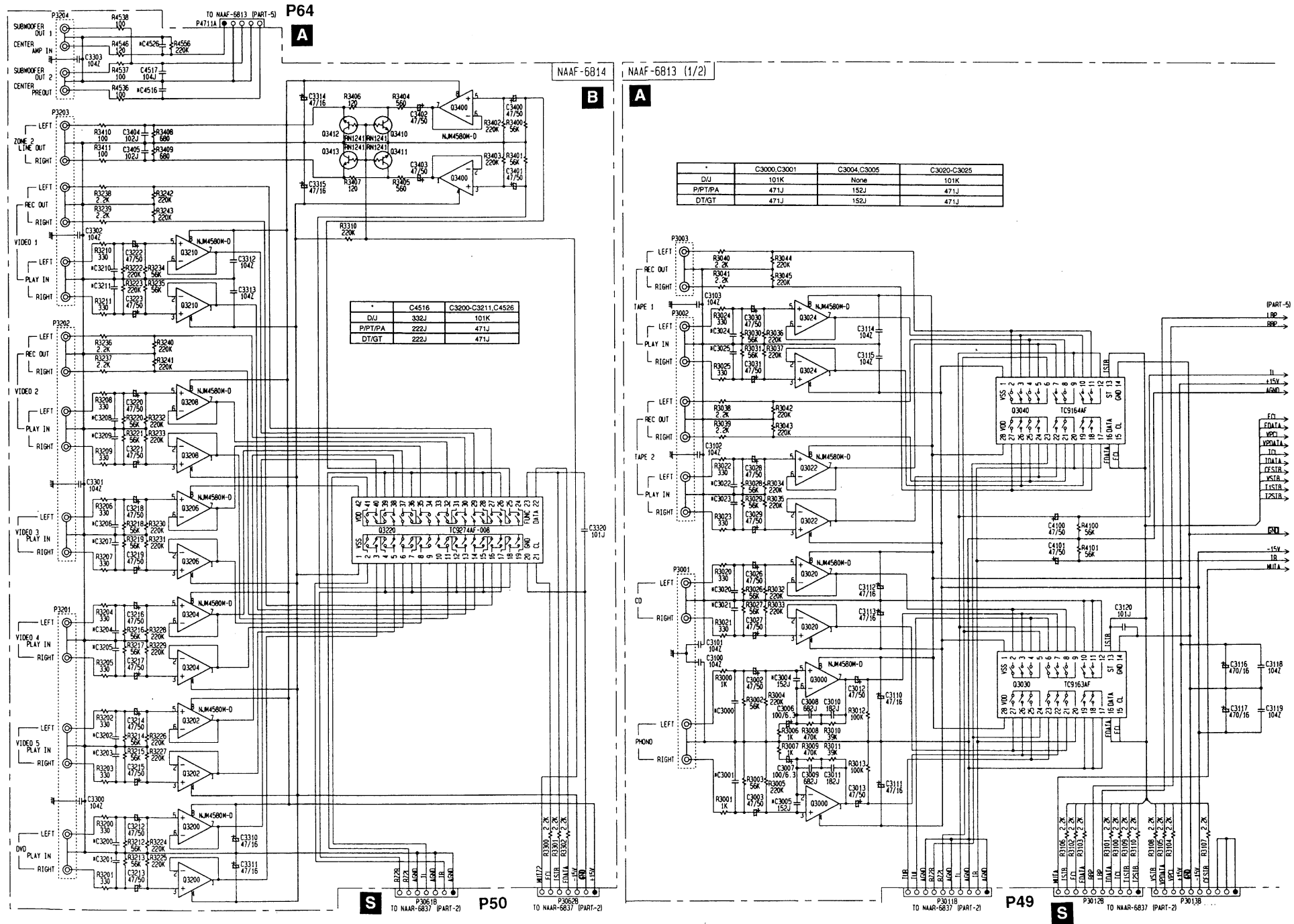

SCHEMATIC DIAGRAM
Audio 2

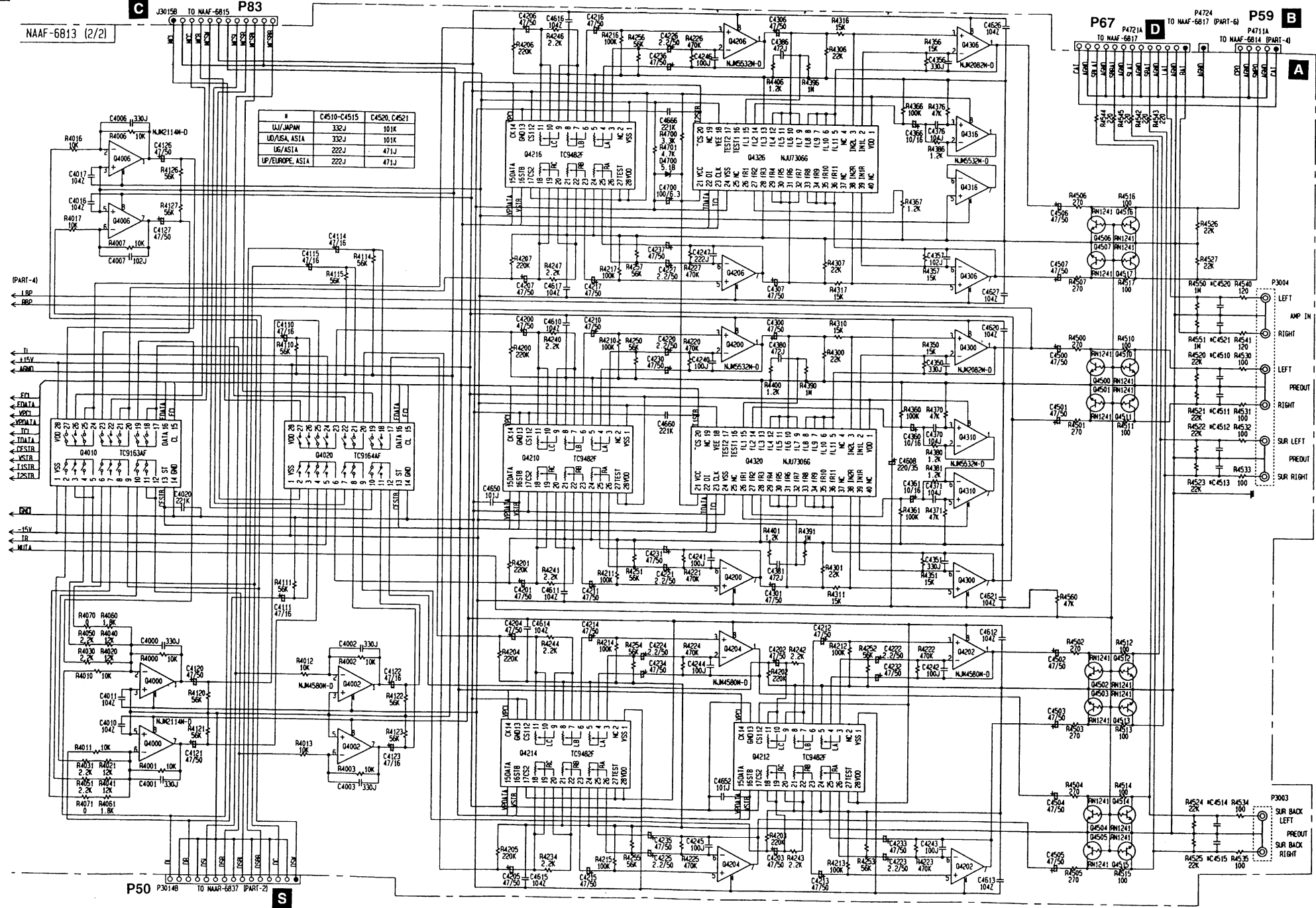

SCHEMATIC DIAGRAM Power Amplifier 1

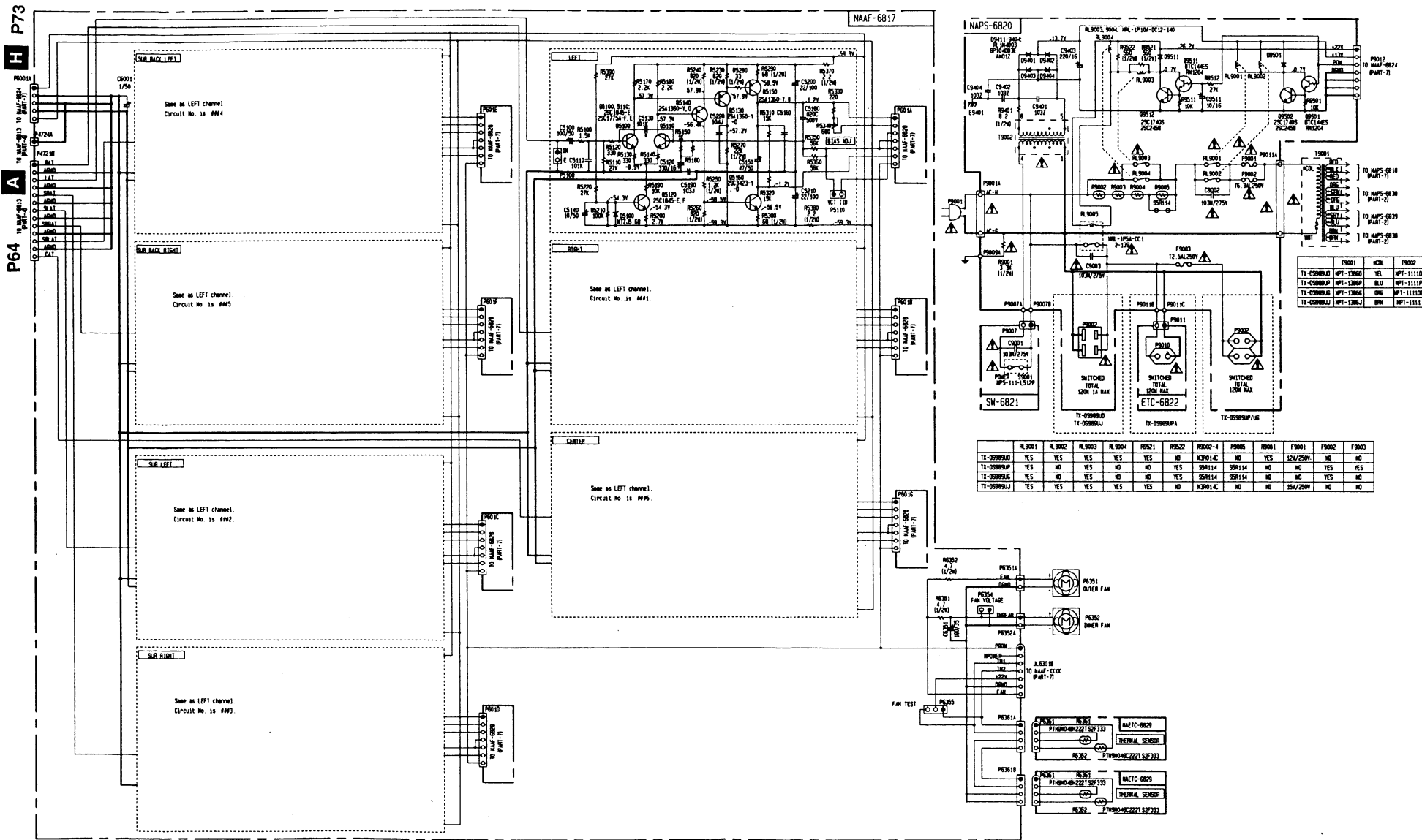

CAUTION
FOR CONTINUED PROTECTION AGAINST FIRE HAZARD, REPAIR ONLY WITH FUSE OF SAME TYPE AND RATING INDICATED.

ATTENTION
AFTER D'ASSURER UNE PROTECTION PERMANENTE CONTRE LES RISQUES D'INCENDIE, REPARER SEULEMENT AVEC UN FUSIBLE DE MEME TYPE ET DE MEME RATING INDIQUE (SANS UN OUI).

THIS SYMBOL LOCATED NEAR THE FUSE INDICATES THAT THE FUSE USED IS SLOW BLOWING TYPE FOR CONTINUED PROTECTION AGAINST FIRE HAZARD. REPLACE WITH SAME TYPE FUSE. FAILURE TO DO SO MAY CAUSE DAMAGE TO THE EQUIPMENT.

CE SYMBOLE INDIQUE QUE LE FUSIBLE UTILISÉ EST À DÉTENTE LENTE POUR UNE PROTECTION PERMANENTE CONTRE LES RISQUES D'INCENDIE. REMPLACEZ LE FUSIBLE PAR UN FUSIBLE DE MEME TYPE ET DE MEME RATING INDIQUE (A OUI LE PRESENT SYMBOLE EST).

PRINTED CIRCUIT BOARD-PARTS LIST

NOTE: THE COMPONENTS IDENTIFIED BY MARK  ARE CRITICAL FOR RISK OF FIRE AND ELECTRIC SHOCK. REPLACE ONLY WITH PART NUMBER SPECIFIED.

POWER AMPLIFIER DRIVER CIRCUIT



















PC BOARD (NAAF-6817-1A/1B/1C/1D)

CIRCUIT NO. PART NO. DESCRIPTION



CIRCUIT NO.	PART NO.	DESCRIPTION
Transistors		
Q5100-Q5106	2211733, 2210755 or 2210756	* 2SC1845-E, * 2SC1775A-E or * 2SC1775A-F
Q5110-Q5116	2211733, 2210755 or 2210756	* 2SC1845-E, * 2SC1775A-E or * 2SC1775A-F
Q5120-Q5126	2211733 or 2211732	2SC1845-E or 2SC1845-F
Q5130-Q5136	2202094 or 2202093	2SA1360-Y or 2SA1360-O
Q5140-Q5146	2202094 or 2202093	2SA1360-Y or 2SA1360-O
Q5150-Q5156	2202104 or 2202103	2SC3423-Y or 2SC3423-O
Diodes		
D5100-D5106	224470562	MTZJ5.6B
Capacitors		
C5100-C5106	393881017	100 μ F, 50V, Elect.
C5110-C5116	374721015	100pF \pm 10%, 50V, Plastic
C5120-C5126	393843317	330 μ F, 16V, Elect.
C5130-C5136	374721015	100pF \pm 10%, 50V, Plastic
C5140-C5146	393381007	10 μ F, 50V, Elect.
C5150-C5156	393384707	47 μ F, 50V, Elect.
C5180-C5186	363150202	2pF \pm 0.5pF, 500V, Plastic
C5190-C5196	374721034	0.01 μ F \pm 5%, 50V, Plastic
C5200-C5206	393392207	22 μ F, 100V, Elect.
C5210-C5216	393392207	22 μ F, 100V, Elect.
C5220-C5226	374723344	0.33 μ F \pm 5%, 50V, Plastic
C6001	393380107	1 μ F, 50V, Elect.
C6351	393361017	100 μ F, 35V, Elect.
Resistors		
R5230-R5236	443528214	820 Ω \pm 5%, 1/2W, Metal oxide
R5240-R5246	443528214	820 Ω \pm 5%, 1/2W, Metal oxide
R5250-R5256	443533224	3.3k Ω \pm 5%, 1/2W, Metal oxide
R5260-R5266	443528214	820 Ω \pm 5%, 1/2W, Metal oxide
R5270-R5276	443522234	22k Ω \pm 5%, 1/2W, Metal oxide
R5280-R5286	443523304	33 Ω \pm 5%, 1/2W, Metal oxide
R5290-R5296	443526804	68 Ω \pm 5%, 1/2W, Metal oxide
R5300-R5306	443526804	68 Ω \pm 5%, 1/2W, Metal oxide
R5340-R5346	5200365	N06HR680BE, Trimming
R5370-R5376	453530224	2.2 Ω \pm 5%, 1/2W, Metal
R5380-R5386	453530224	2.2 Ω \pm 5%, 1/2W, Metal
R6351, R6352	453530474	4.7 Ω \pm 5%, 1/2W, Metal
Plugs		
JL6301B	25055628	NPLG-7P590
P4721A	25055143	NPLG-13P127
P5100-P5106	25055038	NPLG-2P29
P5110-P5116	25055038	NPLG-2P29
P6001A	25055177	NPLG-5P161
P601A-P601G	25055137	NPLG-7P121
P6351A, P6352A	25055099	NPLG-2P83
P6354	25055038	NPLG-2P29
P6355	25055042	NPLG-3P32
P6361A, P6361B	25055148	NPLG-4P132
Clamps		
P5071	27190541	WS-1NS
P6356	27190540-1	Holder
Radiators		
Q5150A-Q5156A	27160315	RAD-95(B)
Q5160A-Q5166A	27160315	RAD-95(B)
Tapping screws		
Q5150B-Q5156B	838430107	3TTB+10S(BC)
Q5160B-Q5166B	838430107	3TTB+10S(BC)

PRIMARY CIRCUIT PC BOARD (NAPS-6820-1A/1B/1C/1D)

CIRCUIT NO. PART NO. DESCRIPTION

CIRCUIT NO.	PART NO.	DESCRIPTION
Transistors		
Q9501, Q9511	221282 or 2213560	DTC114ES or RN1204
Q9502, Q9512	2213284, 2212115 or 2213285	2SC1740S-R, 2SC2458-GR or 2SC1740S-S
Diodes		
D9401-D9404	22380035 or 22380260	GP104003E or RLIN4003
D9501, D9511	223163 or 223205	1SS133 or 1SS270A
Power transformer		
T9002	2300670A  , 2300671A  , 2300672A  , 2301238 	NPT-1111D <D/DT>, NPT-1111P <P/PT/A>, NPT-1111DG <G>, NPT-1111 <J>
Capacitors		
C9002, C9003	35001965 	RE275V-103M
C9403	393342217	220 μ F, 16V, Elect.
C9511	393341007	10 μ F, 16V, Elect.
Thermistors		
R9002-R9004	4000147	S5R114 <P/PT/G/A>
	4000148	M3R014C <D/DT/J>
R9005	4000147	S5R114 <P/PT/G/A>
Resistors		
R9001	431533355 	3.3M Ω , 1/2W, Solid <D/DT>
R9401	453530824	8.2 Ω \pm 5%, 1/2W, Metal
R9521	443525614	560 Ω \pm 5%, 1/2W, Metal oxide <D/DT>
R9522	443525614	560 Ω \pm 5%, 1/2W, Metal oxide <P/PT/G/A>
Relays		
RL9001	25065584 	NRL-1P10A-DC12-140 <P/PT/G/A>
RL9001, RL9002	25065599 	NRL-1P5A-DC12-149 <D/DT/J>
RL9003	25065584 	NRL-1P10A-DC12-140 <P/PT/G/A>
RL9003, RL9004	25065599 	NRL-1P5A-DC12-149 <D/DT/J>
RL9005	25065583 	NRL-1P5A-DC12-139
Fuse holders		
F9001A	250113 	SN5051 <D/DT/J>
F9002A	25050065 	YSH403T <P/PT/G/A>
F9003A	25050065 	YSH403T <P/PT>
AC inlet		
P9001A	25055960 	NPLG-2P913 <D/DT/P/PT/G/A>
	25055880 	NPLG-3P836 <J>
Sockets		
P9002	25051125 	NSCT-4P912 <P/PT/G/K>
	25051126 	NSCT-4P913 <D/DT>
P9007	2009990606	NSAS-4P0820
P9012	25050675	NSCT-7P479
Plug		
P9011A	25055675	NPLG-2P631

POWER SWITCH PC BOARD (NASW-6821-1A/1B/1C/1D)

CIRCUIT NO.	PART NO.	DESCRIPTION
C9001	35001965 	RE275V-103M, Capacitor IS
S9001	25035550 	NPS-111-L512P, Power switch
P9007C	25055676	NPLG-2P632, Plug

THERMAL SENSOR CIRCUIT PC BOARD (NAETC-6829-1A/1B)

CIRCUIT NO.	PART NO.	DESCRIPTION
R6361	4000155	PTH9M04BH222TS2F333, Thermistor
R6362	4000150	PTH9M04BC222TS2F333, Thermistor
P6361	2006320815	NSAS-08P0292, Socket

Replacement for transistor of mark * , if necessary must be made from the same beta group (HFE) as the original type.

PRINTED CIRCUIT BOARD-PARTS LIST

NOTE: THE COMPONENTS IDENTIFIED BY MARK  ARE CRITICAL FOR RISK OF FIRE AND ELECTRIC SHOCK. REPLACE ONLY WITH PART NUMBER SPECIFIED.

SPEAKER RELAY CIRCUIT PC BOARD (NAAF-6824-1A/1B)			CIRCUIT NO.	PART NO.	DESCRIPTION
CIRCUIT NO.	PART NO.	DESCRIPTION		Sockets	
	Photo interrupters		JL6301A	25051091	NSCT-7P878
Q6201,Q6211	24120080 or	PC817X or	JL6624A	25051092	NSCT-8P879
	24120043	ON3131	JL9221A	25051089	NSCT-5P876
	Transistors		JL9222A	25051094	NSCT-10P881
Q6202,Q6203	2213290 or	DTC114ES or	P5950	2009990583	NSAS-8P0792
Q6212,Q6213	2214230	RN1202	P5952	2009990584	NSAS-8P0793
Q6301	2212445	2SK365-GR	P6001	2009990581	NSAS-10P0790
Q6302-Q6304	2213284 or	2SC1740S-R or	P602A-P602G	2009990406	NSAS-6P0543
Q6700,Q6702	2212115	2SC2458-GR		Plugs	
Q6305,Q6306	221282 or	DTC114ES or	P6620B	25055678	NPLG-8P634
Q6611	2213560	RN1204	P6912B	25055661	NPLG-10P617
Q6307	2202116 or	2SD2061-F or	P9012A	25055409	NPLG-7P391
	2202115	2SD2061-E		Clamps	
Q6612	2211164	2SC2120-Y	P6801	27300833	WS-2NS
Q6704,Q6706	2213284 or	2SC1740S-R or	P6802	27190608-1	UA-0 V0
Q6710,Q6712	2212115	2SC2458-GR		Heat sink	
Q6707	2213354 or	2SA933S-R or	Q6307A	27160461	RAD-132
	2212125	2SA1048-GR		Tapping screw	
Q6714,Q6716	2213284 or	2SC1740S-R or	Q6307B	838430107	3TTB+10S(BC)
	2212115	2SC2458-GR			
Q6718	2211793 or	2SA992-E or			
	2211792	2SA992-F			
	Diodes				
D6201	223163,	1SS133,			
D6301-D6307	223205 or	1SS270A or	C6630,C6631	374731024	1000pF±5%,100V,Plastic capacitor <P/PT/G/A>
D6610-D6616	223222	WG713A	C6636,C6646	374731024	1000pF±5%,100V,Plastic capacitor <P/PT/G/A>
D6308	224471303	MTZJ13C (Before change)	C6640,C6641	374721024	1000pF±5%,50V,Plastic capacitor <P/PT/G/A>
	224471003	MTZJ10C (After change)			
		To improve the sound of fan.	P6620A	25051127	NSCT-8P914,Socket
D6309,D6310	22380035,	GP104003E,	P6630	25060297	NTM-6PDMN228,Speaker terminal
D6914,D6915	22380046 or	AM01Z or			
D6921,D6922	22380260	RL1N4003			
D6731	224470512	MTZJ5.1B			
D6931,D6932	22380035,	GP104003E,			
	22380046 or	AM01Z or			
	22380260	RL1N4003			
	Capacitors				
C6201,C6211	374722234	0.022 μ F±5%,50V,Plastic			
C6202	393321017	100 μ F,6.3V, Elect.			
C6301-C6303	393361017	100 μ F,35V, Elect.			
C6510-C6516	393391007	10 μ F,100V, Elect.			
C6520-C6526	393391007	10 μ F,100V, Elect.			
C6530-C6536	374734734	0.047 μ F±5%,100V,Plastic			
C6632,C6633	374731024	1000pF±5%,100V,Plastic <P/PT/G/A>			
C6642,C6643	374721024	1000pF±5%,50V,Plastic <P/PT/G/A>			
C6700,C6702	393322217	220 μ F,6.3V, Elect.	C6912,C6913	374731044	0.1 μ F±5%,100V,Plastic
C6704,C6706	393322217	220 μ F,6.3V, Elect.			
C6731	393380107	1 μ F,50V, Elect.	R6912,R6913	453532294	0.22 Ω ±5%,1/2W, Metal
C6914,C6915	3504355	22000 μ F,80V, Elect.			
	Resistors				
R6310	443621224	1.2k Ω ±5%,1W, Metal oxide	P6912A	25051050	NSCT-10P837
R6510-R6516	453532294	0.22 Ω ±5%,1/2W, Metal			
R6520-R6526	453532294	0.22 Ω ±5%,1/2W, Metal	P6911A	25055676	NPLG-2P632
R6530-R6536	443621804	18 Ω ±5%,1W, Metal oxide	P6913A	25055881	NPLG-2P837
R6540-R6546	443621804	18 Ω ±5%,1W, Metal oxide			
R6550-R6556	443621804	18 Ω ±5%,1W, Metal oxide			
R6914,R6915	443621834	18k Ω ±5%,1W, Metal oxide			
	Terminals				
P6201,P6211	25045204	HSJ0847-01-010,IR			
P6221	25045204	HSJ0847-01-010,RI			
P6632	25060298	NTM-4PDMN229,Speaker			
	Relays				
RL6610-RL6616	25065574	NRL-1P5A-DC24-134			

SPEAKER TERMINAL L/R/C PC BOARD (NAETC-6825-1A/1B)

CIRCUIT NO.	PART NO.	DESCRIPTION
C6630,C6631	374731024	1000pF±5%,100V,Plastic capacitor <P/PT/G/A>
C6636,C6646	374731024	1000pF±5%,100V,Plastic capacitor <P/PT/G/A>
C6640,C6641	374721024	1000pF±5%,50V,Plastic capacitor <P/PT/G/A>
P6620A	25051127	NSCT-8P914,Socket
P6630	25060297	NTM-6PDMN228,Speaker terminal

SPEAKER TERMINAL PC BOARD (NAETC-6826-1A/1B)

CIRCUIT NO.	PART NO.	DESCRIPTION
C6634,C6635	374731024	1000pF±5%,100V,Plastic <P/PT/G/A>
C6644,C6645	374721024	1000pF±5%,50V,Plastic <P/PT/G/A>
JL6624B	25055629	NPLG-8P591,Plug
P6634	25060298	NTM-4PDMN229,Speaker terminal

BRIDGE CIRCUIT PC BOARD (NAETC-6818-1A/1B/1C/1D)

CIRCUIT NO.	PART NO.	DESCRIPTION
	Diode	
D6910	22380303,	RBV-2506,
	22380304 or	D25XB60 or
	22380305	RS2505M
	Capacitors	
C6912,C6913	374731044	0.1 μ F±5%,100V,Plastic
	Resistors	
R6912,R6913	453532294	0.22 Ω ±5%,1/2W, Metal
	Socket	
P6912A	25051050	NSCT-10P837
	Plugs	
P6911A	25055676	NPLG-2P632
P6913A	25055881	NPLG-2P837

NOTE: <D>: 120V model only
<P>: European model only
<PT>: Asian model only for 230V
<DT>: Asian model only for 120V
<G>: 220V model only
<A>: Australian model only
<J>: Japanese model only

A B C D E F G

CHEMATIC DIAGRAM
Power amplifier 2

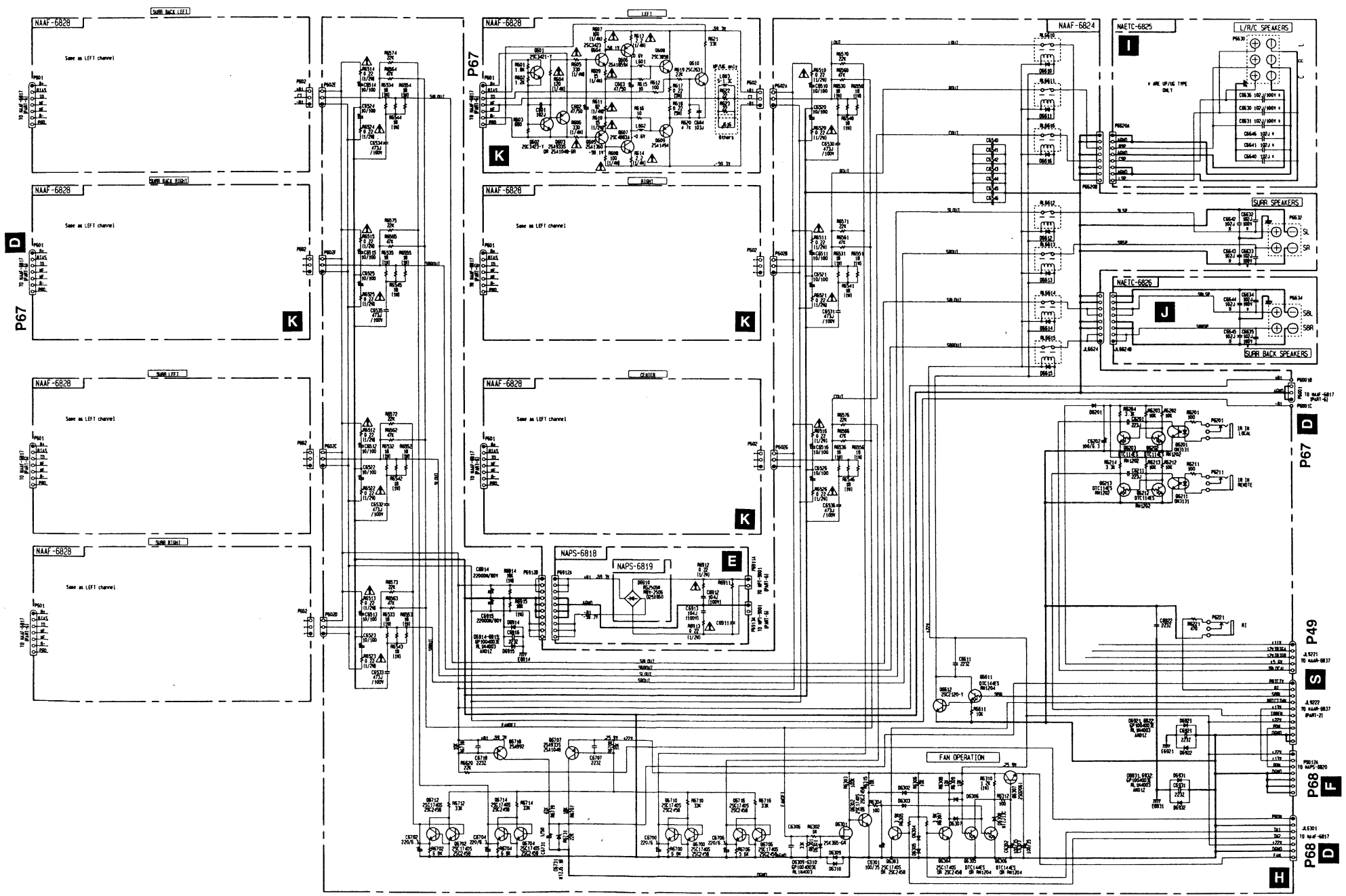

PRINTED CIRCUIT BOARD-PARTS LIST

POWER AMPLIFIER CIRCUIT PC BOARD (NAAF-6828-1A/1B)

CIRCUIT NO.	PART NO.	DESCRIPTION
Transistors		
Q601	2212654	2SC3421-Y
Q602	2202104	2SC3423-Y
Q603	2213354 or 2212125	2SA933S-R or 2SA1048-GR
Q604	2202104	2SC3423-Y
Q605	2202094	2SA1360-Y
Q606	2203334 or 2203333	* 2SA1859A-Y or * 2SA1859A-O
Q607	2203344 or 2203343	* 2SC4883A-Y or * 2SC4883A-O
Q608	2201874, 2201873 or 2201876	* 2SC3858-Y, * 2SC3858-O or * 2SC3858-P
Q609	2201864, 2201863 or 2201866	* 2SA1494-Y, * 2SA1494-O or * 2SA1494-P
Q610	2214984 or 2214985	2SC2631-R or 2SC2631-S
Coils		
L601,L602	5597-45502	FR core
L603	231176SY	S-1.3C <P/PT/G/A>
Capacitors		
C601	374721024	1000pF±5%,50V,Plastic
C602,C603	393384707	47 μ F,50V, Elect.
C604	374721034	0.01 μ F±5%,50V,Plastic
Resistors		
R604	415471214	△ 120 Ω ±5%,1/4W, Carbon
R605,R606	415473314	△ 330 Ω ±5%,1/4W, Carbon
R607,R608	415471014	△ 100 Ω ±5%,1/4W, Carbon
R609,R610	415471504	△ 15 Ω ±5%,1/4W, Carbon
R611	415478204	△ 82 Ω ±5%,1/4W, Carbon
R613,R614	415470224	△ 2.2 Ω ±5%,1/4W, Carbon
R617,R618	4000076	MPC74-5WK-0.22,Metal plate
Socket		
P601	2009990585	NSAS-14P0794
Plug		
P602	25055166	NPLG-3P150
Heat sinks		
Q606A,Q607A	27160461	RAD-132
Screws		
Q604A	838430167	3TTB+16S(BC),Tapping
Q606B,P607B	82143006	3P+6FN(BC),Pan head
Nut		
Q604B	863430	N-3FN(BC)

NOTE: THE COMPONENTS IDENTIFIED BY MARK △
ARE CRITICAL FOR RISK OF FIRE AND
ELECTRIC SHOCK. REPLACE ONLY WITH
PART NUMBER SPECIFIED.

Replacement for transistor of mark * , if necessary
must be made from the same beta group (HFE) as
the original type.

PRINTED CIRCUIT BOARD-PARTS LIST

VIDEO TERMINAL PC BOARD (NAVD-6848-1A/1B)

CIRCUIT NO.	PART NO.	DESCRIPTION
ICs		
Q2001,Q2002	222740515R2	74HC4051AF
Q2011,Q2111	22241443R2	TK15420M
Q2151,Q2171	22241443R2	TK15420M
Q2201	22241037	LC74761-9189
Q2202	222740525R2	74HC4052AF
Q2521	22241443R2	TK15420M
Q2951	22240943R2	TC9163AF
Q2952	22241221R2	TC9164AF
Transistors		
Q2012,Q2022	2213145R2	2SC2712-GR
Q2013,Q2023	2214375R2	2SA1162-GR
Q2041-Q2046	2216031R2 or	RN1444-A or
Q2053-Q2056	2216032R2	RN1444-B
Q2061-Q2064	2216031R2 or	RN1444-A or
Q2071-Q2074	2216032R2	RN1444-B
Q2101	2213145R2	2SC2712-GR
Q2112,Q2121	2213145R2	2SC2712-GR
Q2113,Q2133	2214375R2	2SA1162-GR
Q2132	2213145R2	2SC2712-GR
Q2141,Q2161	2213145R2	2SC2712-GR
Q2181,Q2191	2213145R2	2SC2712-GR
Q2182,Q2192	2214490R2	RN1404
Q2203,Q2252	2213145R2	2SC2712-GR
Q2253	2214375R2	2SA1162-GR
Q2522,Q2622	2213145R2	2SC2712-GR
Q2523,Q2623	2214375R2	2SA1162-GR
Diodes		
D2011,D2012	223234R2	1SS352
D2021,D2022	223234R2	1SS352
D2111,D2112	223234R2	1SS352
D2131,D2132	223234R2	1SS352
D2181,D2182	223234R2	1SS352
D2191,D2192	223234R2	1SS352
D2201	223234R2	1SS352
D2251,D2252	223234R2	1SS352
D2521,D2522	223234R2	1SS352
D2621,D2622	223234R2	1SS352
Coils		
L2201	231237K022R2	NCH-1471
L2202	231292J056R2	NCH-1572
Crystals		
X2201	3010167	XTL-14.32M
X2202	3010238	XTL-17.73M <P/PT/DT/G/A>
Capacitors		
C2011,C2021	354744719	470 μ F,16V, Elect.
C2023,C2024	354741019	100 μ F,16V, Elect.
C2111,C2113	354741019	100 μ F,16V, Elect.
C2114,C2131	354741019	100 μ F,16V, Elect.
C2151,C2171	354741019	100 μ F,16V, Elect.
C2173,C2174	354741019	100 μ F,16V, Elect.
C2181,C2191	354741009	10 μ F,16V, Elect.
C2182,C2192	354780229	2.2 μ F,50V, Elect.
C2183,C2193	354784799	0.47 μ F,50V, Elect.
C2209,C2216	354780109	1 μ F,50V, Elect.
C2212,C2221	354741019	100 μ F,16V, Elect.
C2214	354783399	0.33 μ F,50V, Elect.
C2215	374726824	6800pF \pm 5%,50V,Plastic
C2217	374722234	0.022 μ F \pm 5%,50V,Plastic
C2220	354784799	0.47 μ F,50V, Elect.
C2222	375524744	0.47 μ F \pm 5%,50V,Plastic

CIRCUIT NO.	PART NO.	DESCRIPTION
Capacitors		
C2223,C2226	354741019	100 μ F,16V, Elect.
C2251,C2253	354741019	100 μ F,16V, Elect.
C2254	354741019	100 μ F,16V, Elect.
C2521,C2621	354744719	470 μ F,16V, Elect.
C2523,C2524	354741019	100 μ F,16V, Elect.
C2951,C2925	354741009	10 μ F,16V, Elect.
Terminals		
P2001,P2002	25045566	NPJ-4PDYE381
P2003	25045363	NPJ-3PDYE208
Sockets		
P2011,P2013	25050678	NSCT-10P482
P2012	25050675	NSCT-7P479
P2024	25052259	NSCT-26P2156

S VIDEO TERMINAL PC BOARD (NAVD-6849-1A/1B)

CIRCUIT NO.	PART NO.	DESCRIPTION
ICs		
Q2501,Q2502	222740515R2	74HC4051AF
Q2511	22241443R2	TK15420M
Q2601,Q2602	222740515R2	74HC4051AF
Transistors		
Q2512,Q2612	2213145R2	2SC2712-GR
Q2513,Q2613	2214375R2	2SA1162-GR
Q2541-Q2543	2216031R2 or	RN1444-A or
Q2552,Q2553	2216032R2	RN1444-B
Q2561,Q2562	2216031R2 or	RN1444-A or
Q2571,Q2572	2216032R2	RN1444-B
Q2641-Q2643	2216031R2 or	RN1444-A or
Q2652,Q2653	2216032R2	RN1444-B
Q2661,Q2662	2216031R2 or	RN1444-A or
Q2671,Q2672	2216032R2	RN1444-B
Diodes		
D2511,D2512	223234R2	1SS352
D2611,D2612	223234R2	1SS352
Capacitors		
C2501,C2502	354741019	100 μ F,16V, Elect.
C2511,C2611	354744719	470 μ F,16V, Elect.
C2513,C2514	354741019	100 μ F,16V, Elect.
C2613,C2614	354741019	100 μ F,16V, Elect.
Sockets		
P2501-P2503	25051957	NSCT-12P1744
P2504	25051956	NSCT-8P1743
P2511	25050678	NSCT-10P482
P2521,P2522	25050678	NSCT-10P482
P2523	25052253	NSCT-20P2150
P2524	25052259	NSCT-26P2156

A

B

C

D

E

F

G

SCHEMATIC DIAGRAM
Video

NCVD-6848

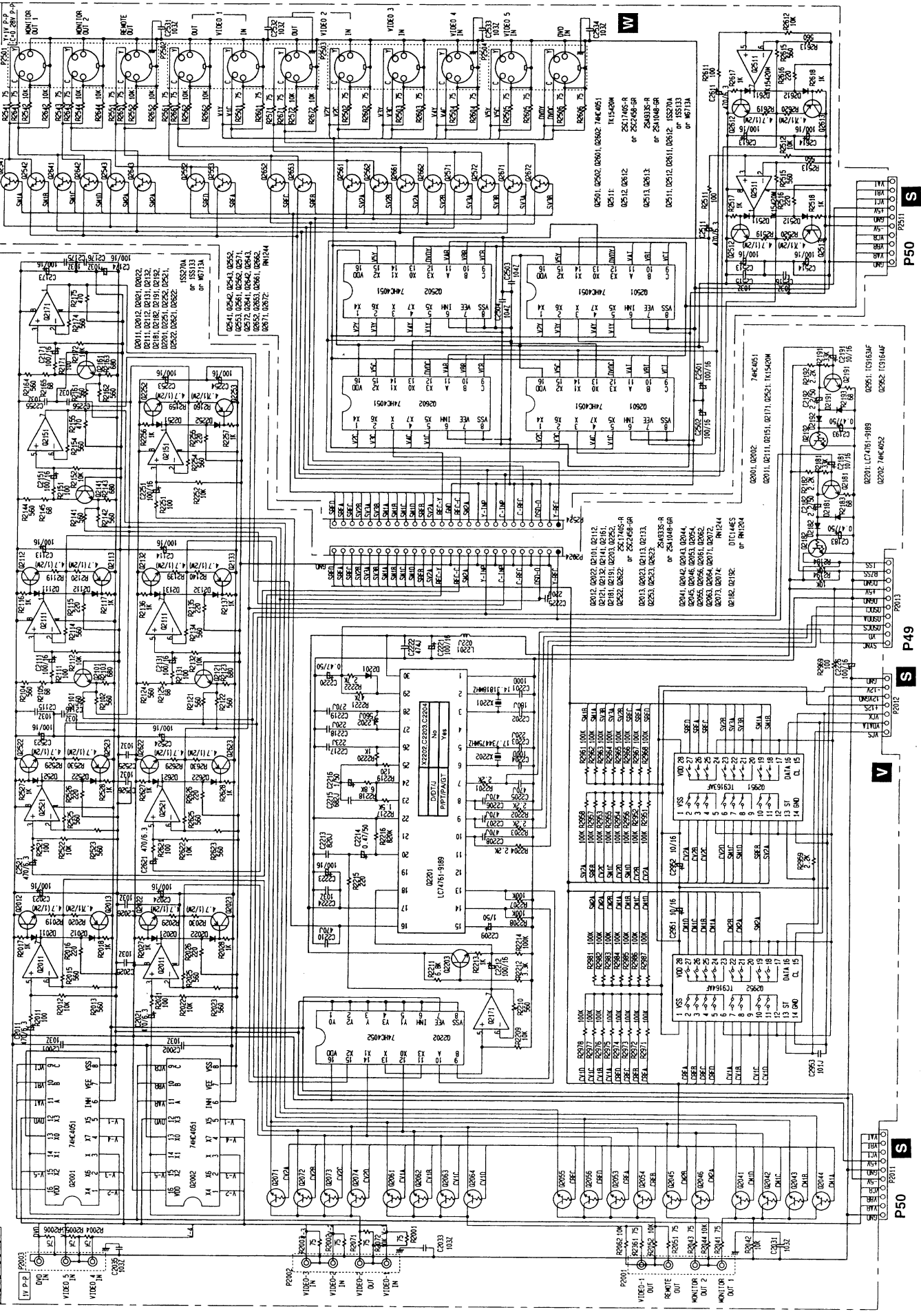

SCHEMATIC DIAGRAM

Component video

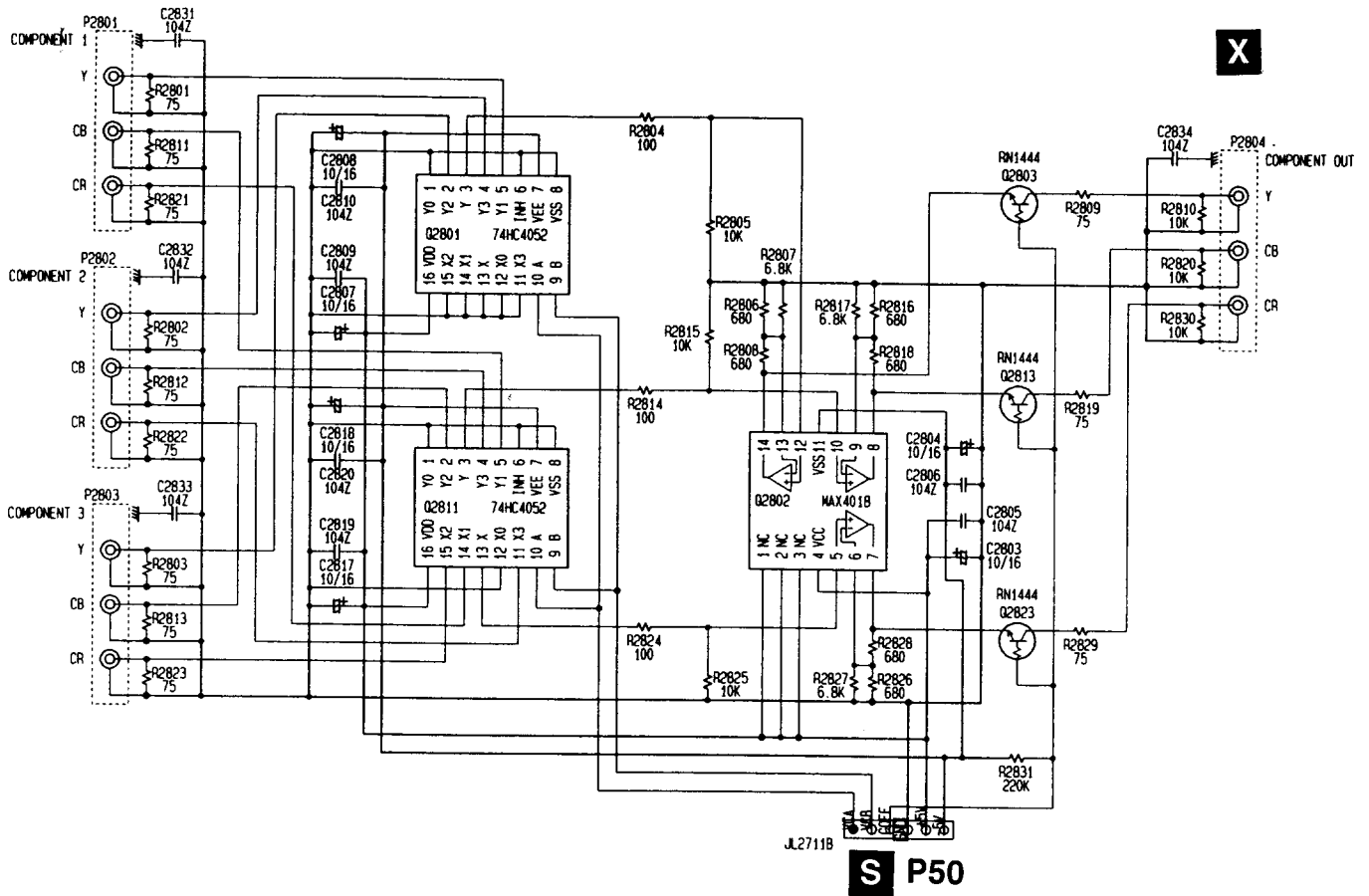

PRINTED CIRCUIT BOARD-PARTS LIST

COMPONENT VIDEO TERMINAL PC BOARD (NAVD-6850-1A/1B)

CIRCUIT NO.	PART NO.	DESCRIPTION
ICs		
Q2801,Q2811	222740525R2	74HC4052AF
Q2802	22241440R2	MAX4018ESD
Transistors		
Q2803,Q2813	2216031R2 or	RN1444-A or
Q2823	2216032R2	RN1444-B
Capacitors		
C2803,C2804	354741009	10 μF,16V, Elect.
C2807,C2808	354741009	10 μF,16V, Elect.
C2817,C2818	354741009	10 μF,16V, Elect.
Terminals		
P2801-P2804	25045607	NPJ-3PDGLR414
Plug		
JL2711B	25055627	NPLG-6P589

SCHEMATIC DIAGRAM

NAAF-6815

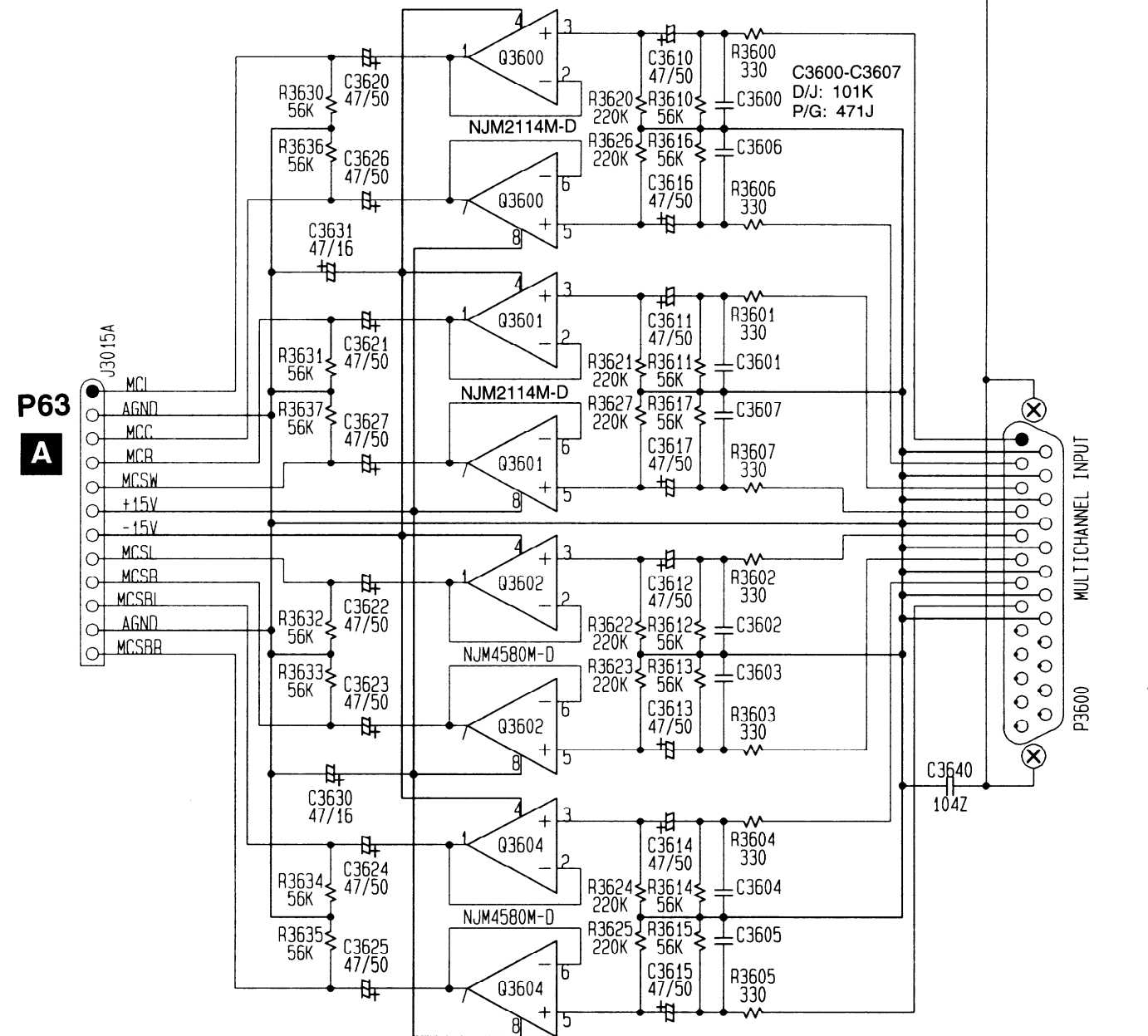
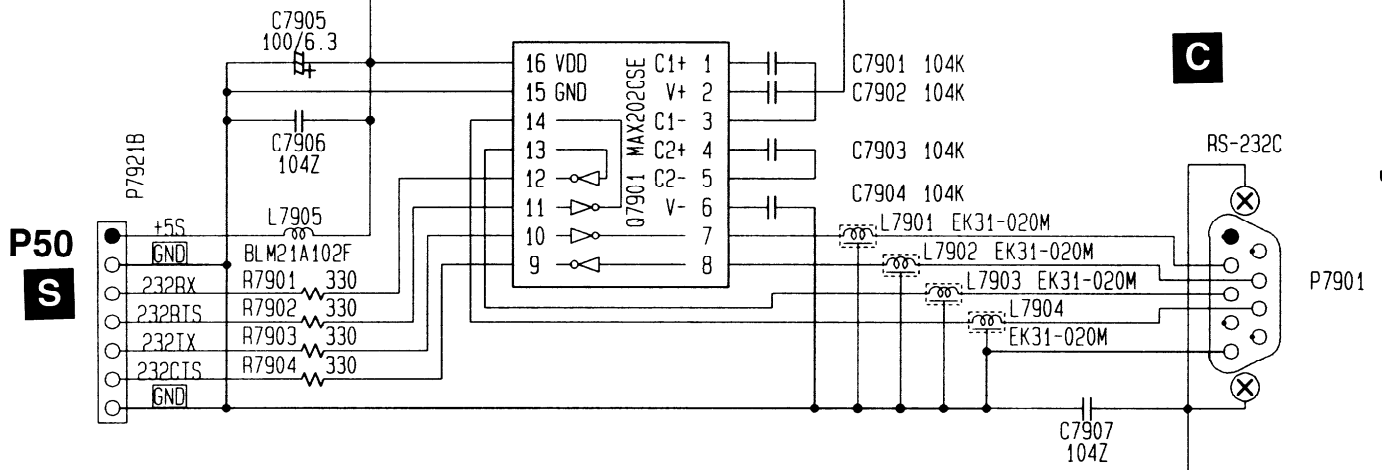

A

B

C

D

SCHEMATIC DIAGRAM DSP Circuit

1

2

3

4

5

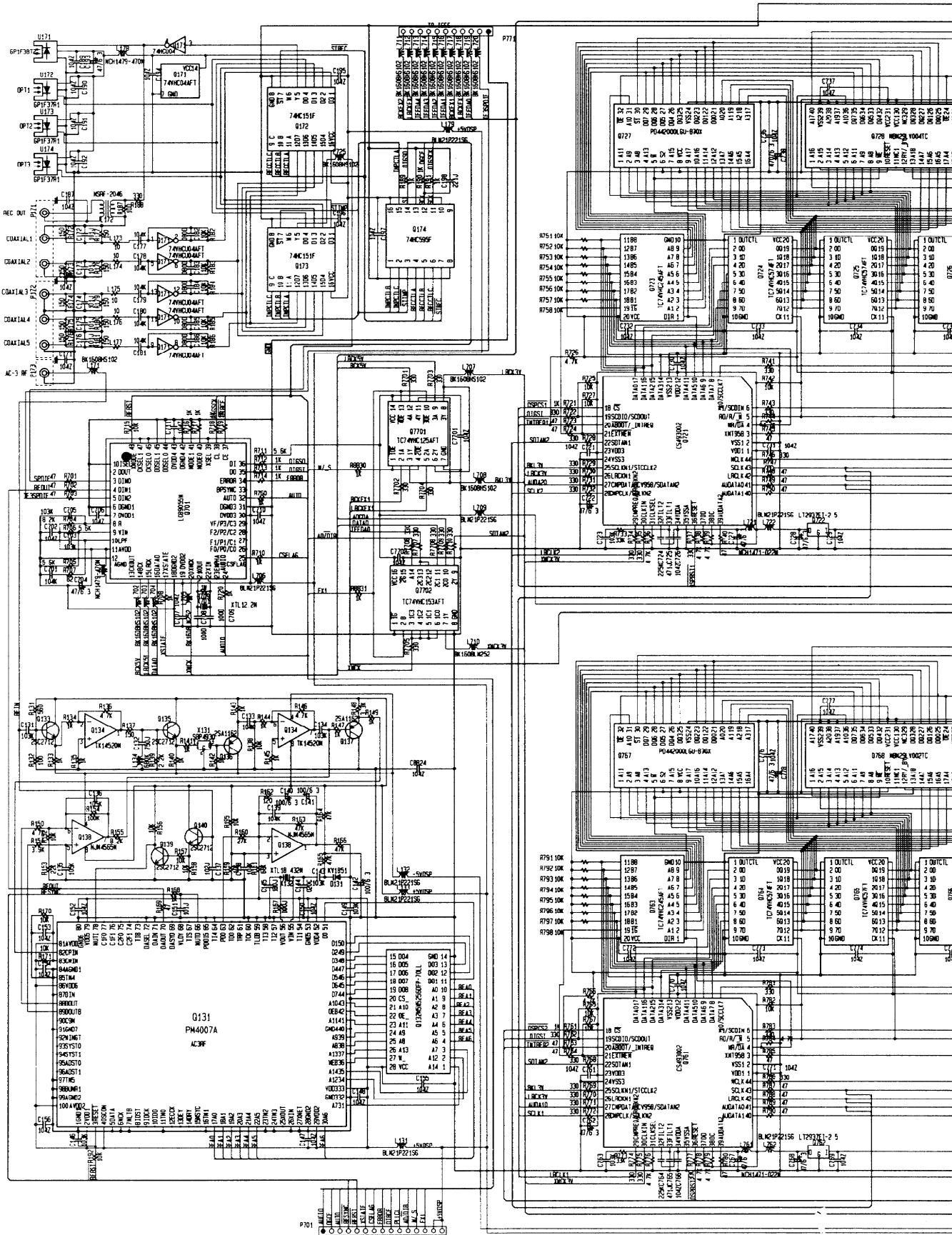

S P49

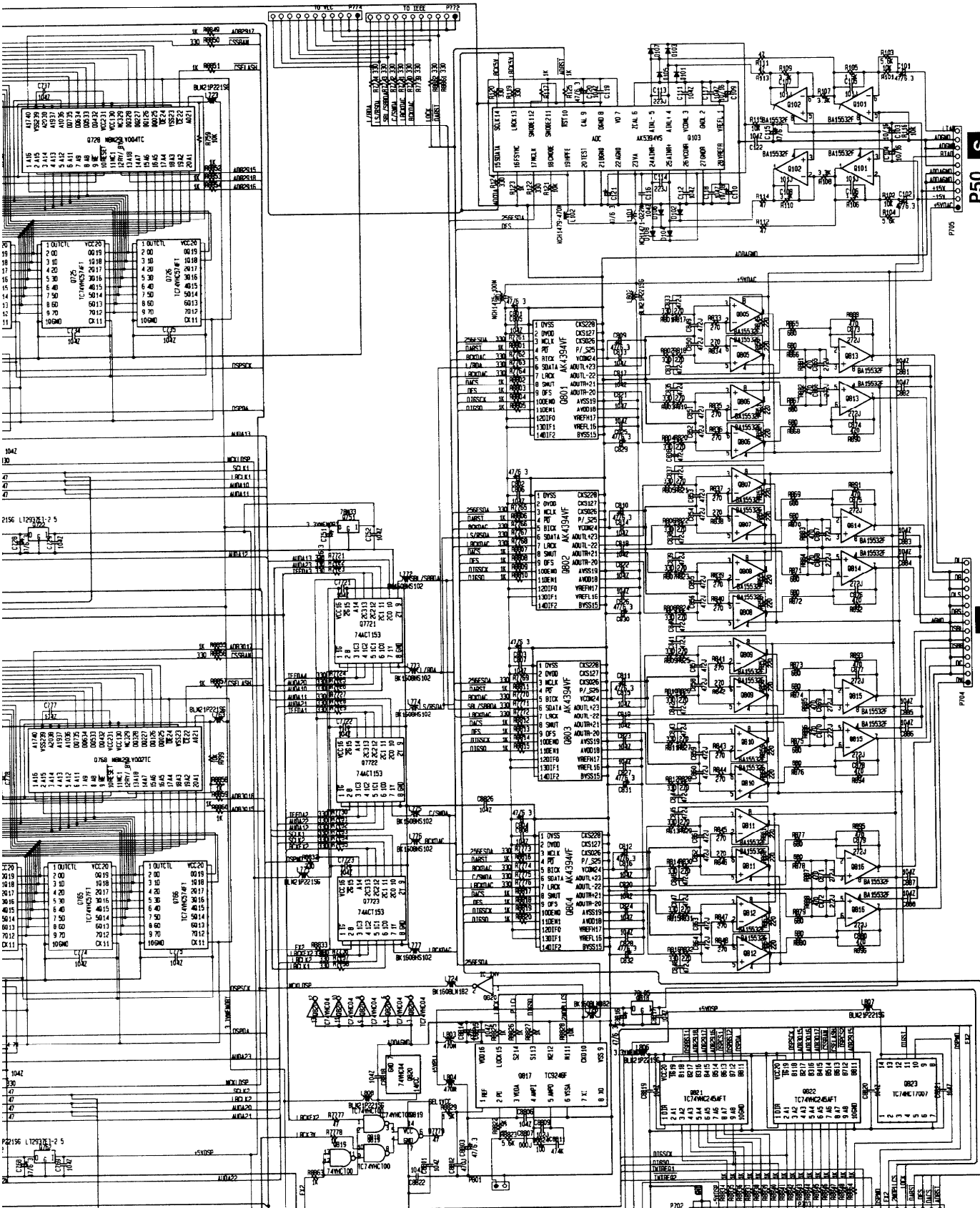

P50 S

P50 S

P49 S

PRINTED CIRCUIT BOARD-PARTS LIST

MULTI CHANNEL INPUT TERMINAL PC BOARD (NAAF-6815-1A/1B)

CIRCUIT NO.	PART NO.	DESCRIPTION
ICs		
Q3600,Q3601	22241472R2	NJM2114M-D
Q3602,Q3604	22241448R2	NJM4580M-D
Q7901	22241447R2	MAX202CSE
Coils		
L7901-L7904	230954	EK31-020M
L7905	230948R2	BLM21A102F
Capacitors		
C3600-C3607	374721015	100pF±10%,50V,Plastic <D/J>
C3600-C3607	374724714	470pF±5%,50V,Plastic <P/PT/DT/G/A>
C3610,C3611	393884707	47 μ F,50V, Elect.
C3612-C3615	393884707	47 μ F,50V, Elect.
C3616,C3617	393884707	47 μ F,50V, Elect.
C3620,C3621	393884707	47 μ F,50V, Elect.

MULTI CHANNEL INPUT TERMINAL PC BOARD (NAAF-6815-1A/1B)

CIRCUIT NO.	PART NO.	DESCRIPTION
C3622-C3625	393384707	47 μ F,50V, Elect.
C3626,C3627	393884707	47 μ F,50V, Elect.
C3630,C3631	393344707	47 μ F,16V, Elect.
C7905	354721019	100 μ F,6.3V, Elect.
Sockets		
P3600	25052380	NSCT-25P2276
P7901	25052379	NSCT-9P2277
P7921B	25050675	NSCT-7P479
J3015A	25051096	NSCT-12P883
Bar		
P3611	27141754	BBL60

PRINTED CIRCUIT BOARD-PARTS LIST

CIRCUIT NO.	PART NO.	DESCRIPTION	CIRCUIT NO.	PART NO.	DESCRIPTION
	ICs			Coils	
Q101,Q102	22241409R2 or 22241449R2	BA15532F or NJM5532M-D	L101 L102,L178	231237M022R2 231237K470R2	NCH-1471 NCH-1479
Q103	22241452R2	AK5393VS	L131-L133	230949R2	BLM21P221SG
Q131	22241107R3	PM4007A	L134	233493K680S	NCH-1487 680K
Q132	22241207R2, 22240985R2, 22241108R2 or 22241208R9	M5M5256DPF-55L, TC55257CFL-85, M5M5256DFP-70L or LH52266CN-70LL	L171 L172 L179	230955R2 232136 233454K220	BK1608HS102-T NSRF-2046 NCH-1452 220K
Q134	22241443R2	TK15420M	L701,L803	231237K470R2	NCH-1479
Q138	22241383R2	NJM4565M-D	L702-L704	230955R2	BK1608HS102-T
Q171	22274004HR2TO	TC74VHC04FT	L705,L710	230956R2	BK1608LM252-T
Q172,Q173	222741515R2TO	TC74HC151F	L706	230949R2	BLM21P221SG
Q174	222745955R2	74HC595F	L707,L708	230955R2	BK1608HS102-T
Q701	22241454R3	LC89055W-RA8	L709,L722	230949R2	BLM21P221SG
Q721	22241456R9	CS493002-CL	L711-L720	230955R2	BK1608HS102-T
Q722	22241468R2	LM2937IMP-2.5	L721,L761	231237M022R2	NCH-1471
Q723,Q763	22274245ER2TO	TC74VHC245AFT	L723,L763	231237K220R2	NCH-1477
Q724-Q726	22274574ER2TO	TC74VHC574FT	L724,L726	230958R1	BK1608LM182-T
Q727	22241459R3	MPD442000LGU-B70X	L725,L772	230955R2	BK1608HS102-T
Q728	22241457R3 or 22241530R3	MBM29LV004TC-90PTN or MBM29LV008TA-90PTN	L762,L771 L773-L777	230949R2 230955R2	BLM21P221SG BK1608HS102-T
Q751	22278033ER2NEC	MPC29M33T	L801	231237K100R2	NCH-1475
Q761	22241456R9	CS493002-CL	L802	230949R2	BLM21P221SG
Q762	22241468R2	LM2937IMP-2.5	L804	231237K470R2	NCH-1479
Q764-Q766	22274574ER2TO	TC74VHC574FT	L806-L808	230949R2	BLM21P221SG
Q767	22241459R3	MPD442000LGU-B70X	R169	230956R2	BK1608LM252-T
Q768	22241458R3, 22241457R3 or 22241530R3	MBM29LV002TC-90PTN, MBM29LV004TC-90PTN or MBM29LV008TA-90PTN	C101,C102 C103,C104 C109,C110 C115,C120 C121,C193 C140-C142 C199	356724709R2 356741009R2 356741009R2 356724709R2 356721019R2 354721019	47 μ F,6.3V, Elect. 10 μ F,16V, Elect. 10 μ F,16V, Elect. 47 μ F,6.3V, Elect. 47 μ F,6.3V, Elect. 100 μ F,6.3V, Elect. 100 μ F,6.3V, Elect.
Q7701	22274125ER2TO	TC74VHC125FT	C704,C722 C727,C728 C738,C778 C751,C762 C767,C768	356724709R2 356724709R2 354724719 356724709R2 356724709R2	47 μ F,6.3V, Elect. 47 μ F,6.3V, Elect. 470 μ F,6.3V, Elect. 47 μ F,6.3V, Elect. 47 μ F,6.3V, Elect.
Q7702	22274153ER2TO	TC74VHC153FT	C801-C804 C809-C812 C829-C832 C8803,C8814	356724709R2 356724709R2 356724709R2 356724709R2	47 μ F,6.3V, Elect. 47 μ F,6.3V, Elect. 47 μ F,6.3V, Elect. 47 μ F,6.3V, Elect.
Q7721-Q7723	22274153AR2TO	TC74ACT153F	C8816	356724709R2	47 μ F,6.3V, Elect.
Q801-Q804	22241453R2	AK4394VF			
Q805-Q816	22241409R2 or 22241449R2	BA15532F or NJM5532M-D			
Q817	22240928R2	TC9246F			
Q818	222780053R2JR	NJM78L05UA			
Q819	22274000GR2TO	TC74VHCT00AFT			
Q820	22274004HR2TO	TC74VHC04FT			
Q821,Q822	22274245ER2TO	TC74VHC245AFT			
Q823	222740077R2TO	TC74HCT700AF			
	Photo couplers				
U171	24120079	GP1F38T2			
U172-U174	24120078	GP1F37R1			
	Transistors				
Q133,Q135	2213145R2	2SC2712-GR	P173	25045477	NPJ-1PDBL295
Q136,Q137	2214375R2	2SA1162-GR	P171,P172	25045624	NPJ-3PDO431
Q139,Q140	2213145R2	2SC2712-GR			
	Diodes				
D101-D108	223234R2	1SS352	P701-P704 P705 P771,P772	25050683 25050678 25052439R2	NSCT-15P487 NSCT-10P482 NSCT-11P2336
D131	223236R2	KV1851-TL			
	Crystals				
X132	3010279R2	XTL-18.432M			
X701	3010323R2	HC-49/U03C 12.288MHz			
	Filter				
X131	3010263	SBP-4930			
				Cushions	
				28141429	DAC

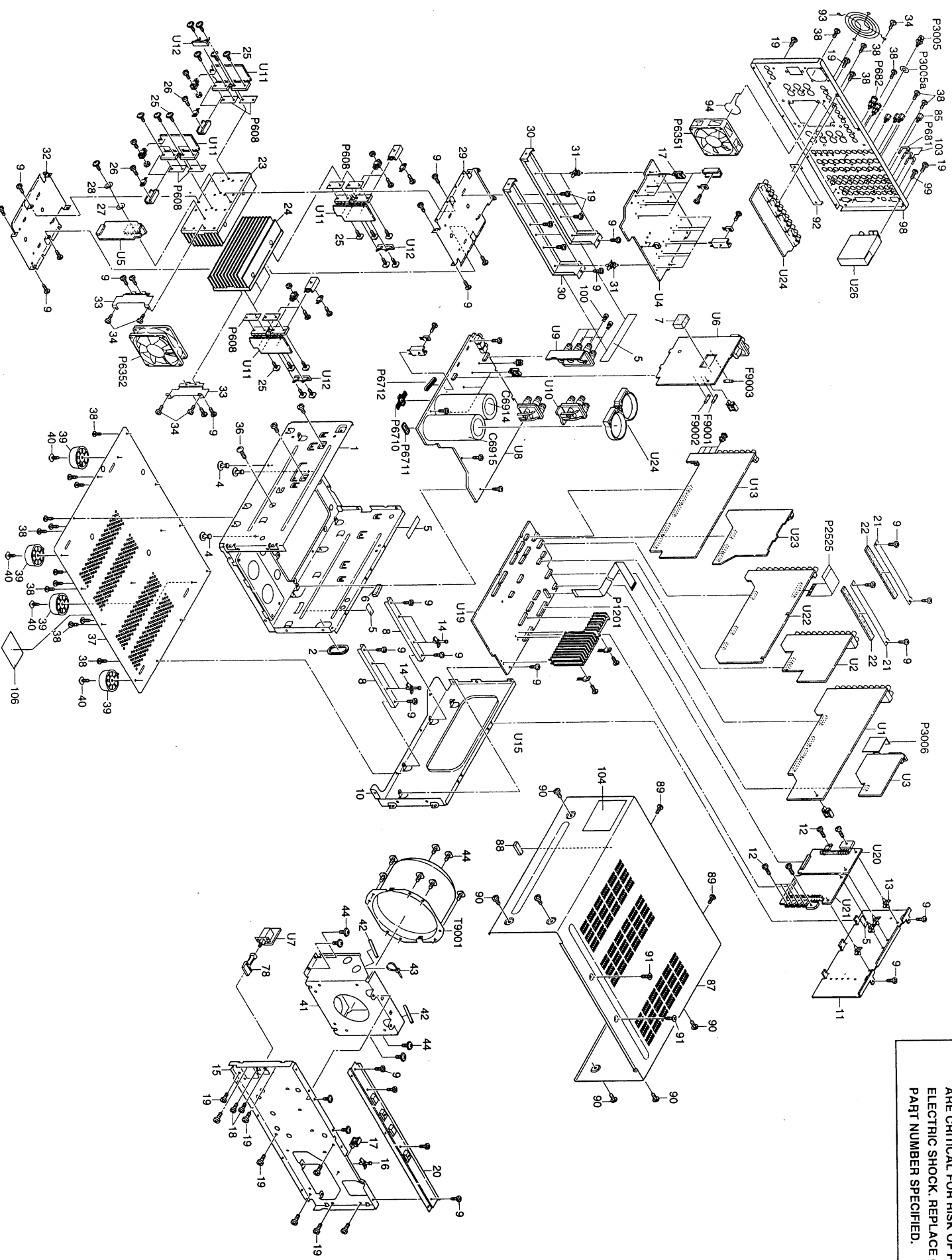

NOTE: THE COMPONENTS IDENTIFIED BY MARK  ARE CRITICAL FOR RISK OF FIRE AND ELECTRIC SHOCK. REPLACE ONLY WITH PART NUMBER SPECIFIED.

PARTS LIST

REF. NO.	PART NO.	DESCRIPTION	REF. NO.	PART NO.	DESCRIPTION
101	28141432	t1.5*12*4, Cushion	U6	1A871520-1A	NAPS-6820-1A, Primary circuit PC board ass'y <D/DT>
102	29362686	Label, door		1A871520-1B	NAPS-6820-1B, Primary circuit PC board ass'y <P/PT>
103	29362630	Label, processor		1A871520-1C	NAPS-6820-1C, Primary circuit PC board ass'y <GT>
104	29362591	Label		1A871520-1E	NAPS-6820-1E, Primary circuit PC board ass'y <A>
105	29362609	Label PT	U7	1A871521-1A	NASW-6821-1A, Power switch PC board ass'y <D/DT>
106	29360788	△ Label, flash <D>		1A871521-1B	NASW-6821-1B, Power switch PC board ass'y <P/PT>
C6914	3504355	CE62W80V22000M, Elect. Capacitor		1A871521-1C	NASW-6821-1C, Power switch PC board ass'y <GT>
C6915	3504355	CE62W80V22000M, Elect. Capacitor		1A871521-1E	NASW-6821-1E, Power switch PC board ass'y <A>
F9001	252196	△ 12A-UL/T-314, Fuse <D/DT>	U8	1A871524-1A	NAAF-6824-1A, Speaker relay circuit PC board ass'y <D/DT>
F9002	252079	△ 6.3A-SE-EAK, Fuse <P/PT/GT/A>		1A871524-1B	NAAF-6824-1B, Speaker relay circuit PC board ass'y <P/PT/GT/A>
F9003	252075	△ 2.5A-SE-EAK, Fuse <P/PT/A>	U9	1A871525-1A	NAETC-6825-1A, Speaker terminal L/R/C PC board ass'y <D/DT>
P1201	2047152512	NCFC7-152512, Flexible flat cable		1A871525-1B	NAETC-6825-1B, Speaker terminal L/R/C PC board ass'y <P/PT/GT/A>
P2525	2047261022	NCFC7-261022, Flexible flat cable	U10	1A871526-1A	NAETC-6826-1A, Speaker terminal PC board ass'y <D/DT>
P3005	25060151	Ground terminal		1A871526-1B	NAETC-6826-1B, Speaker terminal PC board ass'y <P/PT/GT/A>
P3005a	87643010	W3*10F(BC), Flat washer	U11	1A871528-1A	NAAF-6828-1A, Power amplifier circuit PC board ass'y <D/DT>
P3006	27262657	Shield plate		1A871528-1B	NAAF-6828-1B, Power amplifier circuit PC board ass'y <P/PT/GT/A>
P608	223031	BFG20E-2, Isolated sheet	U12	1A871529-1A	NAETC-6829-1A, Thermal sensor PC board ass'y <D/DT>
P6351	24502311 or 24502312	D08A-24TG(EX) or 3110KL-05W-B40, Fan		1A871529-1B	NAETC-6829-1B, Thermal sensor PC board ass'y <P/PT/GT/A>
P6352	24502310 or 24502309	D09T-24TG(EX) or 3610KL05WB40F12, Fan	U13	1A871530-1	NADG-6830-1, DSP circuit PC board ass'y
P6710	27301856	Bus bar	U14	1A871532-1A	NADIS-6832-1A, Display circuit PC board ass'y <D>
P6711	27301944	Bus bar		1A871532-1B	NADIS-6832-1B, Display circuit PC board ass'y <P>
P6712	27141723	Retainer, bus		1A871532-1C	NADIS-6832-1C, Display circuit PC board ass'y <PT/DT/GT/A>
P681	25055945	NPLG-2P898, Plug	U15	1A871533-1A	NASW-6833-1A, Operation switch PC board ass'y <D>
P682	25055959	NPLG-1P912, Shorted plug		1A871533-1B	NASW-6833-1B, Operation switch PC board ass'y <P>
P7201	2047242512	NCFC7-242512, Flexible flat cable		1A871533-1C	NASW-6833-1C, Operation switch PC board ass'y <PT/DT/GT/A>
P7202	2047242512	NCFC7-242512, Flexible flat cable	U16	1A871534-1A	NAETC-6834-1A, Headphone terminal PC board ass'y <D>
P9001	253297KAW △ AS-UC-2, Power supply cord <D/DT> 253298KAW △ AS-CEE-3, Power supply cord <P/PT/GT/A>			1A871534-1B	NAETC-6834-1B, Headphone terminal PC board ass'y <P>
T9001	2301446 △ NPT-1386D, Power transformer <D/DT> 2301447 △ NPT-1386P, Power transformer <P/PT/A> 2301448 △ NPT-1386G, Power transformer <GT>			1A871534-1C	NAETC-6834-1C, Headphone terminal PC board ass'y <PT/DT/GT/A>
U1	1A871513-1A NAAF-6813-1A, Main circuit PC board ass'y <D> 1A871513-1B NAAF-6813-1B, Main circuit PC board ass'y <P/PT/DT/GT/A>		U17	1A871535-1A NAETC-6835-1A, Door motor drive circuit PC board ass'y <D> 1A871535-1B NAETC-6835-1B, Door motor drive circuit PC board ass'y <P>	
U2	1A871514-1A NAAF-6814-1A, Input/output terminal PC board ass'y <D> 1A871514-1B NAAF-6814-1B, Input/output terminal PC board ass'y <P/PT/DT/GT/A>		U18	1A871535-1C NAETC-6835-1C, Door motor drive circuit PC board ass'y <PT/DT/GT/A> 1A871536-1A NAETC-6836-1A, Door motor PC board ass'y <D> 1A871536-1B NAETC-6836-1B, Door motor PC board ass'y <P> 1A871536-1C NAETC-6836-1C, Door motor PC board ass'y <PT/DT/GT/A>	
U3	1A871515-1A NAAF-6815-1A, Multi channel input terminal PC board ass'y <D> 1A871515-1B NAAF-6815-1B, Multi channel input terminal PC board ass'y <P/PT/DT/GT/A>		U19	1A871537-1A NAAR-6837-1A, Main microprocessor circuit PC board ass'y <D> 1A871537-1B NAAR-6837-1B, Main microprocessor circuit PC board ass'y <P>	
U4	1A871517-1A NAAF-6817-1A, Power amplifier driver circuit PC board ass'y <D/DT> 1A871517-1B NAAF-6817-1B, Power amplifier driver circuit PC board ass'y <P/PT> 1A871517-1C NAAF-6817-1C, Power amplifier driver circuit PC board ass'y <GT> 1A871517-1E NAAF-6817-1E, Power amplifier driver circuit PC board ass'y <A>		U20	1A871537-1C NAAR-6837-1C, Main microprocessor circuit PC board ass'y <PT/DT/GT/A> 1A871538-1A NAPS-6838-1A, Rectifier circuit PC board ass'y <D> 1A871538-1B NAPS-6838-1B, Rectifier circuit PC board ass'y <P> 1A871538-1C NAPS-6838-1C, Rectifier circuit PC board ass'y <PT/DT/GT/A>	
U5	1A871518-1A NAPS-6818-1A, Bridge circuit PC board ass'y <D/DT> 1A871518-1B NAPS-6818-1B, Bridge circuit PC board ass'y <P/PT> 1A871518-1C NAPS-6818-1C, Bridge circuit PC board ass'y <GT> 1A871518-1E NAPS-6818-1E, Bridge circuit PC board ass'y <A>		U21	1A871539-1A NAPS-6839-1A, Constant voltage circuit PC board ass'y <D> 1A871539-1B NAPS-6839-1B, Constant voltage circuit PC board ass'y <P> 1A871539-1C NAPS-6839-1C, Constant voltage circuit PC board ass'y <PT/DT/GT/A>	
			U22	1A871548-1A NAVD-6848-1A, Video terminal PC board ass'y <D> 1A871548-1B NAVD-6848-1B, Video terminal PC board ass'y <P/PT/DT/GT/A>	
			U23	1A871549-1A NAVD-6849-1A, S video terminal PC board ass'y <D> 1A871549-1B NAVD-6849-1B, S video terminal PC board ass'y <P/PT/DT/GT/A>	
			U24	1A871550-1A NAVD-6850-1A, Component video terminal PC board ass'y <D> 1A871550-1B NAVD-6850-1B, Component video terminal PC board ass'y <P/PT/DT/GT/A>	
			U26	240134 TFCE1U114A, Tuner unit <D/DT> 240135 TFCE1E512A, Tuner unit <P/PT/GT/A>	

Front panel exploded view

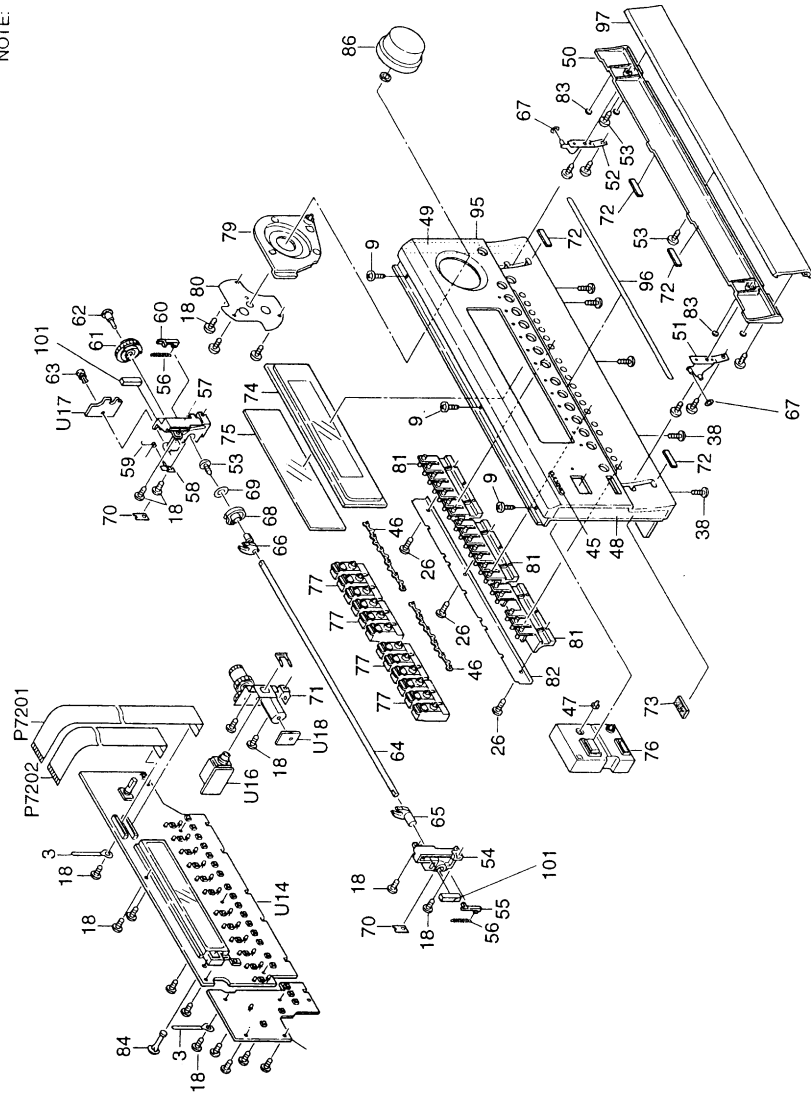

NOTE:
 -Black model only
 <S>-Silver model only
 <G>-Golden model only
 <D>- 120V model only
 <P>-European model only
 <PT>-Asian model only for 230V
 <DT>-Asian model only for 120V
 <GT>- 220V model only
 <A>- Australian model only

REF. NO.	PART NO.	DESCRIPTION
61	27301943	Gear A
62	27260364	Shaft A
63	880011	NRP-355, Plastic rivet
64	27260363	Shaft
65	27260365A	Shaft L
66	27260366A	Shaft R
67	27270218	Spacer
68	27301942	Gear S
69	27141759	Retainer W
70	27141752	Retainer S
71	24804045B	Motor
72	28141426	t1.5*25*5, Cushion
73	28141430	Cushion
74	28191875A	Clear plate
75	28133392	Back plate
76	28133393	Back plate <G/S>
77	28325735	Knob, power
78	28325736	Knob, power <G>
79	28325780	Knob, power <S>
80	28325737A	Knob, selector
81	28325738A	Knob, selector <G>
82	28325781	Knob, selector <S>
83	28325739A	Knob, power 2
84	28325740A	Knob, power 2 <G>
85	28325763	Knob, power 2 <S>
86	27268014B	Guide, volume
87	27268015B	Guide, volume <G>
88	27268032A	Guide, volume <S>
89	27130838	Bracket, volume
90	28325723A	Knob, door
91	28325724A	Knob, door <G>
92	28325784	Knob, door <S>
93	27141755	Bracket, knob
94	28140860	Cushion
95	27190926	KGPS-18RF, Holder
96	801588	Special screw
97	28325732	Knob, volume
98	28325733	Knob, volume <G>
99	28325785	Knob, volume <S>
100	28184773A	Top cover
101	28184774A	Top cover <G>
102	28184785	Top cover <S>
103	28141422	t12*15*30, Cushion
104	838430088	3TTB+8B(BC), Self-tapping screw <G/S>
105	838240089	4TTB+8C(NI), Self-tapping screw <G/S>
106	838440089	4TTB+8C(BC), Self-tapping screw
107	801597A	Special screw
108	801598	Special screw <G>
109	801599	Special screw <S>
110	28184772	Cover
111	28184771A	Cover, rear
112	29095874	Sheet, fan
113	27212178A	Front panel <D>
114	27212179A	Front panel <P>
115	27212180A	Front panel <PT/A>
116	27212181A	Front panel <G>
117	27212227	Front panel <S>
118	27262646	Plate L <D/PT/GT/DT/A>
119	27262647	Plate L <P>
120	28148430	Door
121	28148431	Door <G>
122	28148450	Door <S>
123	27122690	Rear panel <D/DT>
124	27122692	Rear panel <P/PT>
125	27122784	Rear panel <A>
126	838430068	3TTB+6B(BC), Self-tapping screw
127	880009	NRP-345, Plastic rivet <P/PT/A/GT>

REF. NO.	PART NO.	DESCRIPTION	REF. NO.	PART NO.	DESCRIPTION
48	28125368	End cap L 	48	28125368	End cap L
49	28125370	End cap L <G>	49	28125377	End cap L <S>
50	28125371	End cap R 	50	28125369	End cap R <G>
51	28125372	End cap R <S>	50	28125378	End cap R <S>
52	28148434	Door base 	50	28148433	Door base <G>
53	28148449	Door base <G>	51	28183002A	Door base <S>
54	834426068	2.6TTS+6B(BC), Self-tapping screw	51	28183003A	Slay R
55	27191094A	Holder L	52	834426068	2.6TTS+6B(BC), Self-tapping screw
56	27180577	Spring	54	27191094A	Holder L
57	27191095A	Holder R	55	28335065A	Lever L
58	27141758A	Retainer SP	56	27180577	Spring
59	27180579	Spring, door	57	27191095A	Holder R
60	28335066A	Lever R	58	27141758A	Retainer SP
61	82143010	3P+10FN(BC), Pan head screw	59	27180579	Spring, door
62	87643008	W3*8F(BC), Washer	60	28335066A	Lever R
63	871430	SW-3(BC), Spring washer			
64	27130835	Bracket H2			
65	27130834	Bracket HU			
66	27190011	KGLS-6S, Holder			
67	27130836	Bracket HL			
68	833450102	5STP+10BQ(BC), Self-tapping screw			
69	27190983A	Holder CH			
70	837440169	4TTT+16C(BC), Self-tapping screw			
71	27170309	Bottom board			
72	838430088	3TTB+8B(BC), Self-tapping screw			
73	27175317	Leg			
74	27130780B	Bracket PT			
75	28170071	Bushing			
76	260208	Wire tie			
77	830440089	4TTC+8C(BC), Self-tapping screw			
78	28135243	Badge 			
79	28135242	Badge <G/S>			
80	28198903	Facet			
81	28198908	Facet (1)			

Front panel exploded view

REF. NO.	PART NO.	DESCRIPTION	REF. NO.	PART NO.	DESCRIPTION
1	27100319-1	Chassis	26	82143010	3P+10FN(BC), Pan head screw
2	28170070	Bushing	27	87643008	W3*8F(BC), Washer
3	27255004	CS-1U, Clip	28	871430	SW-3(BC), Spring washer
4	27190813	KGPS-10RF, Holder	29	27130835	Bracket HU
5	29110083	Cloth tape	30	27130834	Bracket H2
6	28141421	t8*10*30, Cushion	31	27190011	KGLS-6S, Holder
7	28141423	t16*20*30, Cushion	32	27130836	Bracket HL
8	27130778	Bracket P	33	27130833	Bracket, fan
9	838130088	3TTB+8B, Self-tapping screw	34	833450102	5STP+10BQ(BC), Self-tapping screw
10	27115259B	Side bracket	35	27190983A	Holder CH
11	27160462	Heat sink S	36	837440169	4TTT+16C(BC), Self-tapping screw
12	838430107	3TTB+10S(BC), Self-tapping screw	37	27170309	Bottom board
13	27190009	KGLS-4S, Holder	38	838430088	3TTB+8B(BC), Self-tapping screw
14	27190902	KGPS-16S, Holder	39	27175317	Leg
15	27130779E	Bracket, shield	40	831430088	3TTW+8B(BC), Self-tapping screw
16	27190938	KGPS-8S, Holder	41	27130780B	Bracket PT
17	27300833	WS-2NS, Clamp, wire	42	28170071	Bushing
18	82143006	3P+6FN(BC), Pan head screw	43	260208	Wire tie
19	838440089	4TTB+8C(BC), Self-tapping screw	44	830440089	4TTC+8C(BC), Self-tapping screw
20	27130832A	Bracket F	45	28135243	Badge
21	27130837-1	Bracket U		28135242	Badge <G/S>
22	28141095	Cushion	46	28198903	Facet
23	27160463	Heat sink L	47	28198908	Facet (1)
24	27160464	Heat sink R			
25	801433	3SMS8W.SW+14B(BC), Special screw			

REF. NO.	PART NO.	DESCRIPTION
61	27301943	Gear A
62	27260364	Shaft A
63	880011	NRP-355, Plastic rivet
64	27260363	Shaft
65	27260365A	Shaft L
66	27260366A	Shaft R
67	27270218	Spacer
68	27301942	Gear S
69	27141759	Retainer W
70	27141752	Retainer S
71	24804045B	Motor
72	28141426	t1.5*25*5, Cushion
73	28141430	Cushion
74	28191875A	Clear plate
75	28133392	Back plate
	28133393	Back plate <G/S>
76	28325735	Knob, power
	28325736	Knob, power <G>
	28325780	Knob, power <S>
77	28325737A	Knob, selector
	28325738A	Knob, selector <G>
	28325781	Knob, selector <S>
78	28325739A	Knob, power 2
	28325740A	Knob, power 2 <G>
	28325783	Knob, power 2 <S>
79	27268014B	Guide, volume
	27268015B	Guide, volume <G>
	27268032A	Guide, volume <S>
80	27130838	Bracket, volume
81	28325723A	Knob, door
	28325724A	Knob, door <G>
	28325784	Knob, door <S>
82	27141755	Bracket, knob
83	28140860	Cushion
84	27190926	KGPS-18RF, Holder
85	801588	Special screw
86	28325732	Knob, volume
	28325733	Knob, volume <G>
	28325785	Knob, volume <S>
87	28184773A	Top cover
	28184774A	Top cover <G>
	28184785	Top cover <S>
88	28141422	t12*15*30, Cushion
89	838430088	3TTB+8B(BC), Self-tapping screw
90	838240089	4TTB+8C(NI), Self-tapping screw <G/S>
	838440089	4TTB+8C(BC), Self-tapping screw
91	801597A	Special screw
	801598	Special screw <G>
	801599	Special screw <S>
92	28184772	Cover
93	28184771A	Cover, rear
94	29095874	Sheet, fan
95	27212178A	Front panel <D>
	27212179A	Front panel <P>
	27212180A	Front panel <PT/A>
	27212181A	Front panel <G>
	27212227	Front panel <S>
96	27262646	Plate L <D/PT/GT/DT/A>
	27262647	Plate L <P>
97	28148430	Door
	28148431	Door <G>
	28148450	Door <S>
98	27122690	Rear panel <D/DT>
	27122692	Rear panel <P/PT>
	27122784	Rear panel <A>
99	838430068	3TTB+6B(BC), Self-tapping screw
100	880009	NRP-345, Plastic rivet <P/PT/AVGT>

REF. NO.	PART NO.	DESCRIPTION
48	28125368	End cap L
	28125370	End cap L <G>
	28125377	End cap L <S>
49	28125369	End cap R
	28125371	End cap R <G>
	28125378	End cap R <S>
50	28148433	Door base
	28148434	Door base <G>
	28148449	Door base <S>
51	28183002A	Stay L
52	28183003A	Stay R
53	834426068	2.6TTS+6B(BC), Self-tapping screw
54	27191094A	Holder L
55	28335065A	Lever L
56	27180577	Spring
57	27191095A	Holder R
58	27141758A	Retainer SP
59	27180579	Spring, door
60	28335066A	Lever R

PACKING VIEW

Printed matters

UD

- 29095866 Sheet
- 29365083A Warranty card
- 29342897 Instruction sheet
- 29342896A Instruction manual E

UP

- 29342849A Instruction manual E
- 29342850 Instruction manual F
- 29342851 Instruction manual S
- 29342852 Instruction manual G
- 29342853 Instruction manual D
- 29342854 Instruction manual SW
- 29342855 Instruction manual I

UPT/UDT/UGT

- 29342849A Instruction manual E
- 29342856 Instruction manual T

UPA

- 29342849A Instruction man
- Warranty card

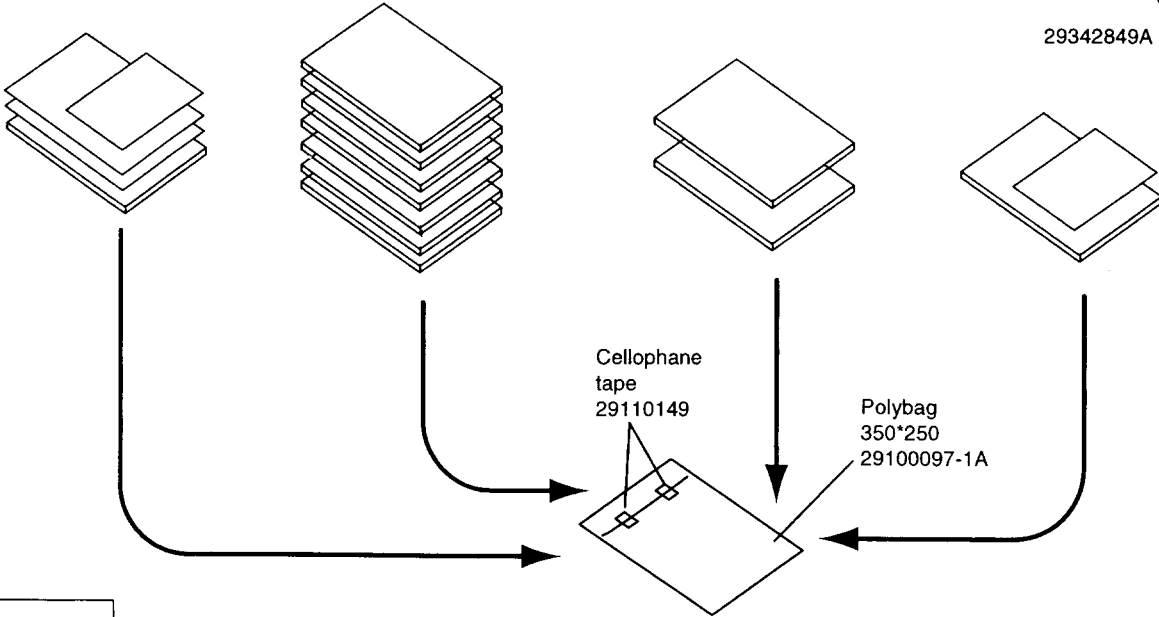

Accessory

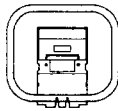

AM loop antenna 1
232140



T-shaped FM antenna 1
292142 (UD)
292116 (Other models)

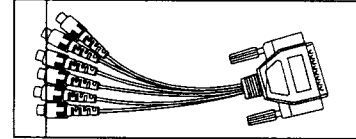

DB-25 RCA6ch cable 1
2010386

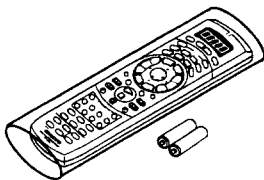

Remote controller 1
RC-390M
24140398B
Batteries (AA, R6, or UM-3) 2
3010054

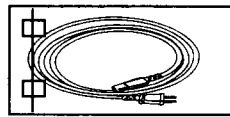

Power cord 1
AS-UC-2 253297 (UD)
AS-CEE-3 253298 (Other models)

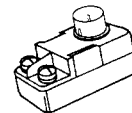

Antenna adaptor 1
25065462 (UPT,UDT,UGT)

