

ONKYO® SERVICE MANUAL

Ref. No. 4259
032011/
062011

AV RECEIVER MODEL TX-NR509(B)/(S)

North American and Taiwan models ---> "MUSIC OPTIMIZER"
European, Australian and Asian models ---> "PURE AUDIO"

North American and Taiwan models ---> "DIMMER"
European, Australian and Asian models ---> "RT/TPY/TP"

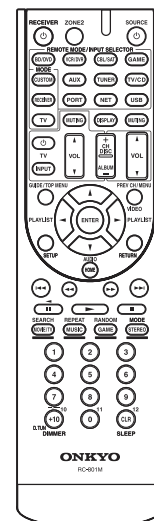
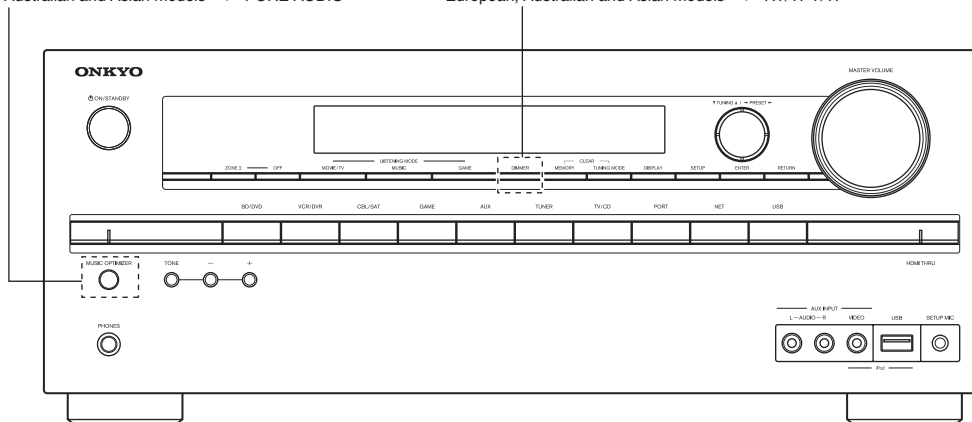

RC-801M

TX-NR509 Black and silver models

B MDD, B MDC, B MDF	120V AC, 60Hz
B MMK, B MMQ, B MMR	220-240V AC, 50/60Hz
B MPP, B MPB, B MPA, S MPP	230V AC, 50Hz

TX-NR509 for HT-S6405 Black model

B MPP	230V AC, 50Hz
-------	---------------

TX-NR509 for AVX-690 Black model

B MPP, B MPB	230V AC, 50Hz
--------------	---------------

SAFETY-RELATED COMPONENT WARNING!!

COMPONENTS IDENTIFIED BY MARK \triangle ON THE SCHEMATIC DIAGRAM AND IN THE PARTS LIST ARE CRITICAL FOR RISK OF FIRE AND ELECTRIC SHOCK. REPLACE THESE COMPONENTS WITH ONKYO PARTS WHOSE PART NUMBERS APPEAR AS SHOWN IN THIS MANUAL.

MAKE LEAKAGE-CURRENT OR RESISTANCE MEASUREMENTS TO DETERMINE THAT EXPOSED PARTS ARE ACCEPTABLY INSULATED FROM THE SUPPLY CIRCUIT BEFORE RETURNING THE APPLIANCE TO THE CUSTOMER.

ONKYO SOUND & VISION CORPORATION
Service Department

EXPLODED VIEWS-1

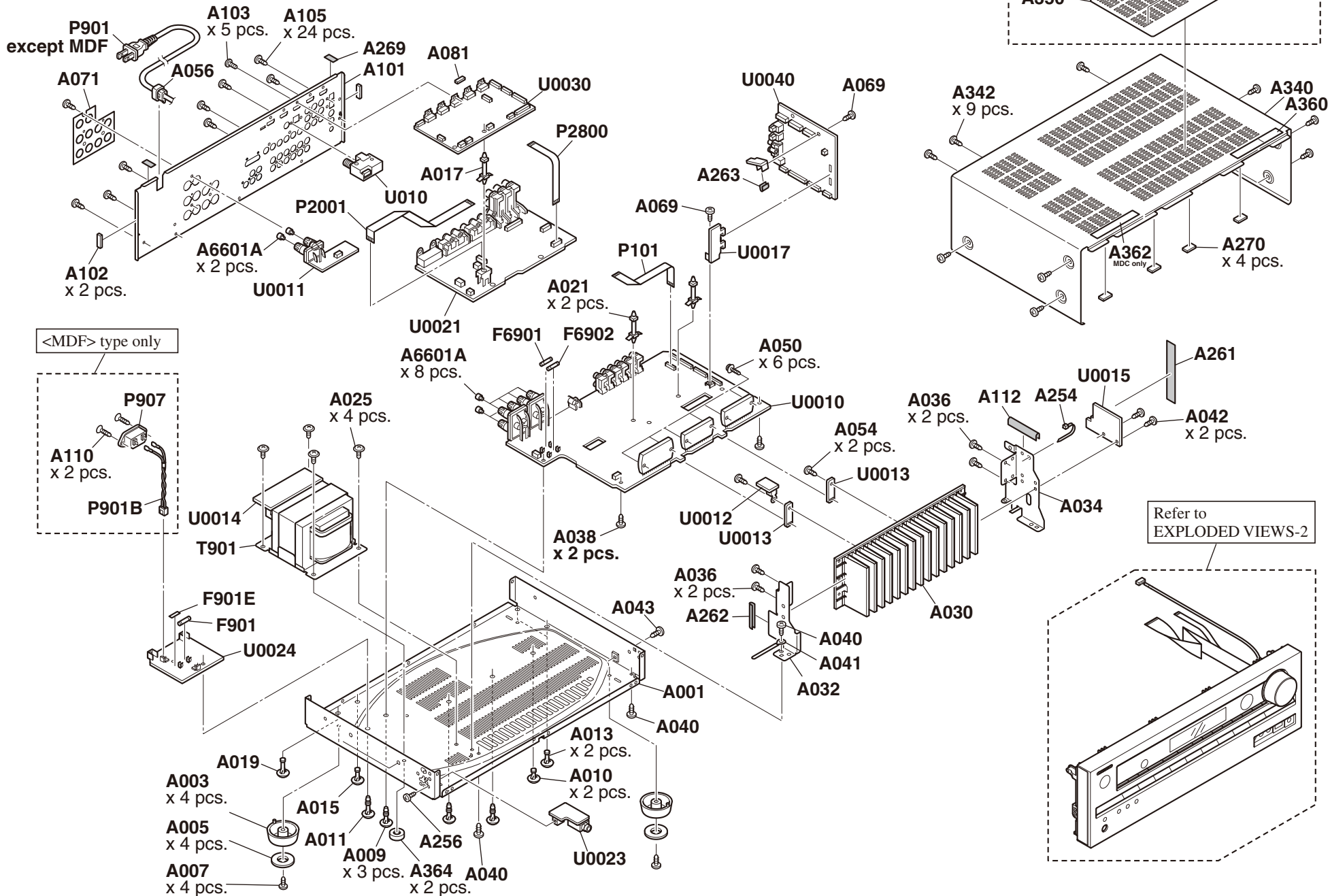

EXPLODED VIEWS-2

<Fig-1>

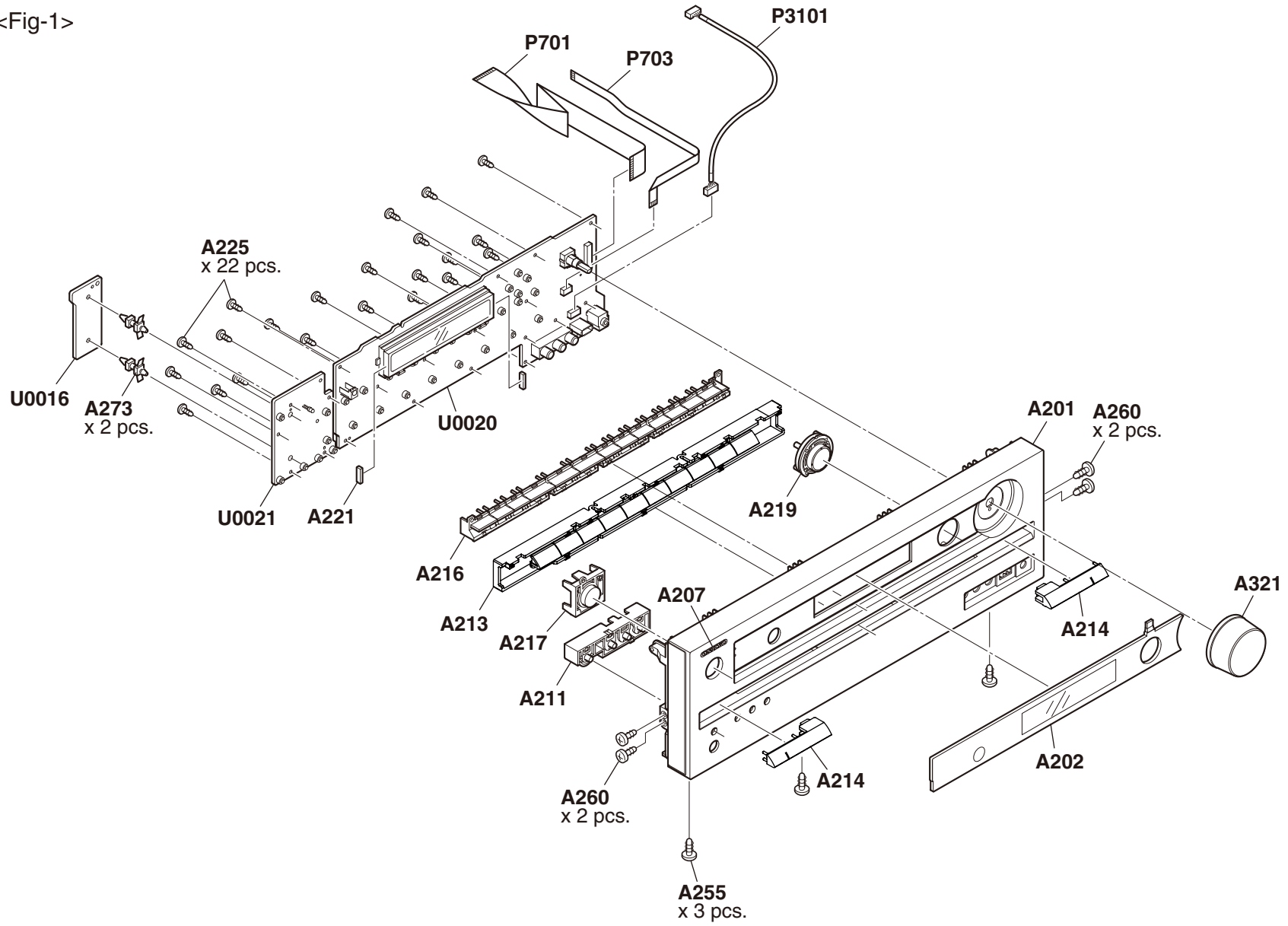

SCHEMATIC DIAGRAM/ BLOCK DIAGRAM-1

BLOCK DIAGRAM

AUDIO SECTION PART-1

TX-NR509/TX-NA509/HT-R590 BLOCK DIAGRAM AUDIO Section (PART-1)

1
2
3
4
5

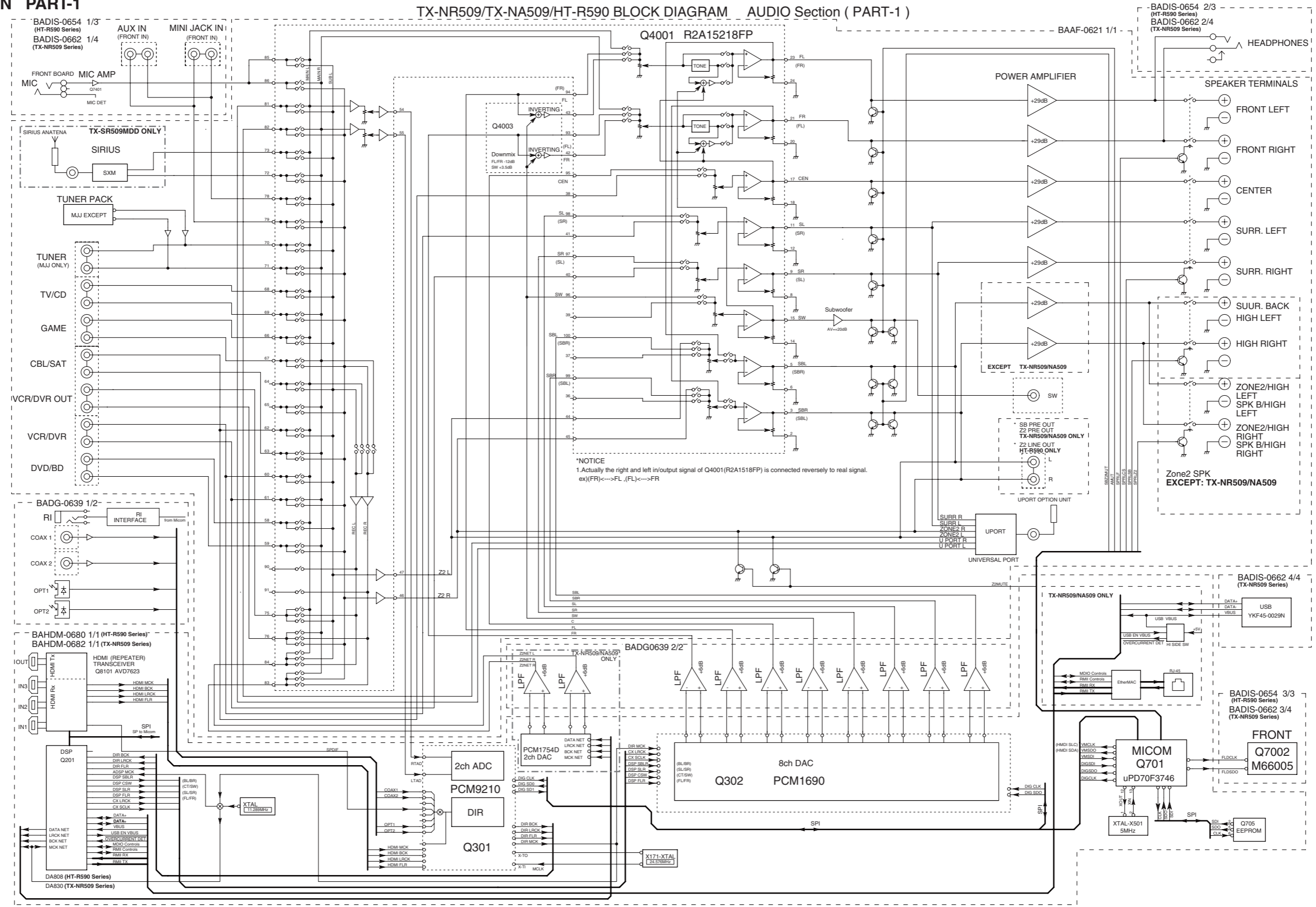

***NOTICE**
 1. Actually the right and left in/output signal of Q4001(R2A1518FP) is connected reversely to real signal.
 ex) (FR) <-> FL, (FL) <-> FR

EXCEPT TX-NR509/NA509

SB PRE OUT
 Z2 PRE OUT
 TX-NR509/NA509 ONLY
 Z2 LINE OUT
 HT-R590 ONLY

Zone2 SPK
 EXCEPT: TX-NR509/NA509

BADIS-0662 4/4
 (TX-NR509 Series)

BADIS-0654 3/3
 (HT-R590 Series)
 BADIS-0662 3/4
 (TX-NR509 Series)

FRONT
 Q7002
 M66005

Q705
 EEPROM

SCHEMATIC DIAGRAM/ BLOCK DIAGRAM-2

BLOCK DIAGRAM VIDEO SECTION PART-2

Model No. TX-SR309/509/609/TX-SA509/609/HT-R290/390/548/590/690/990/HT-RC330/360/DTR-20.3/30.3

SCHEMATIC DIAGRAM (PART-2)

BLOCK DIAGRAM(VIDEO)

1

2

3

4

5

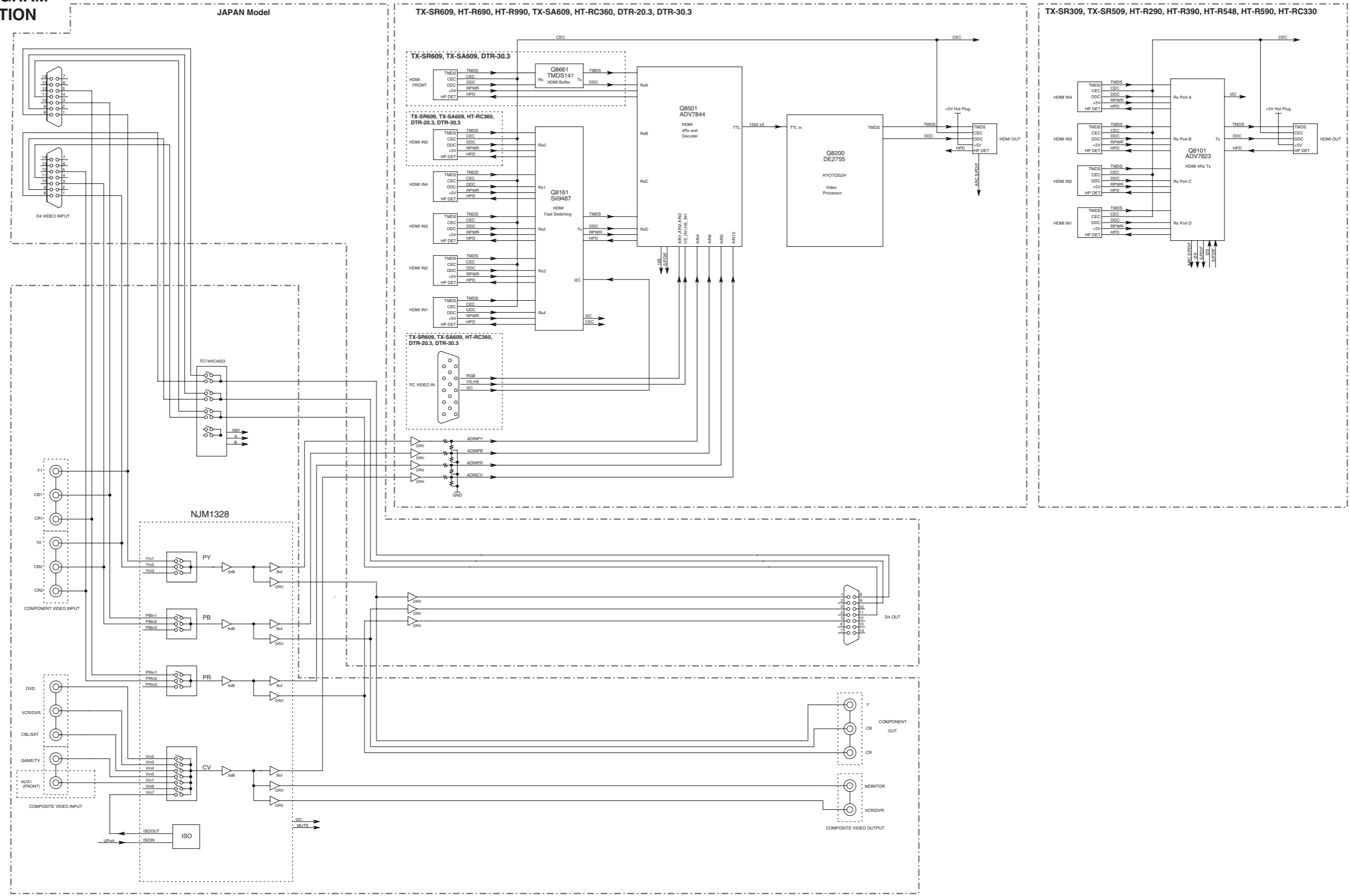

SCHEMATIC DIAGRAM/ BLOCK DIAGRAM-3
AUDIO INPUT SECTION PART-3

MODEL NO. TX-NR509/ TX-NR579/ TX-NA579/ HT-R590/ HT-R690/ HT-R990 SCHEMATIC DIAGRAM (PART-3) AUDIO INPUT

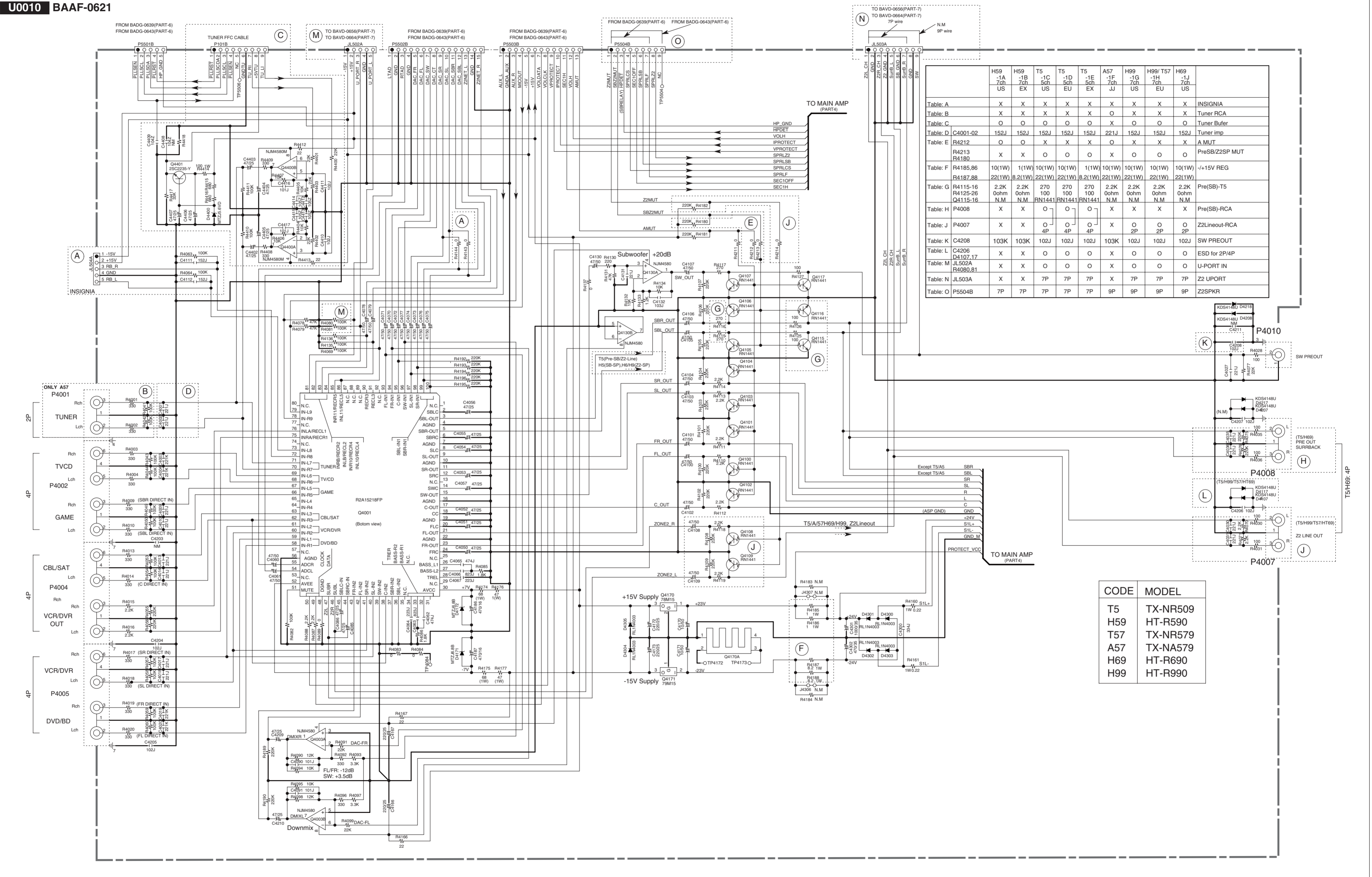
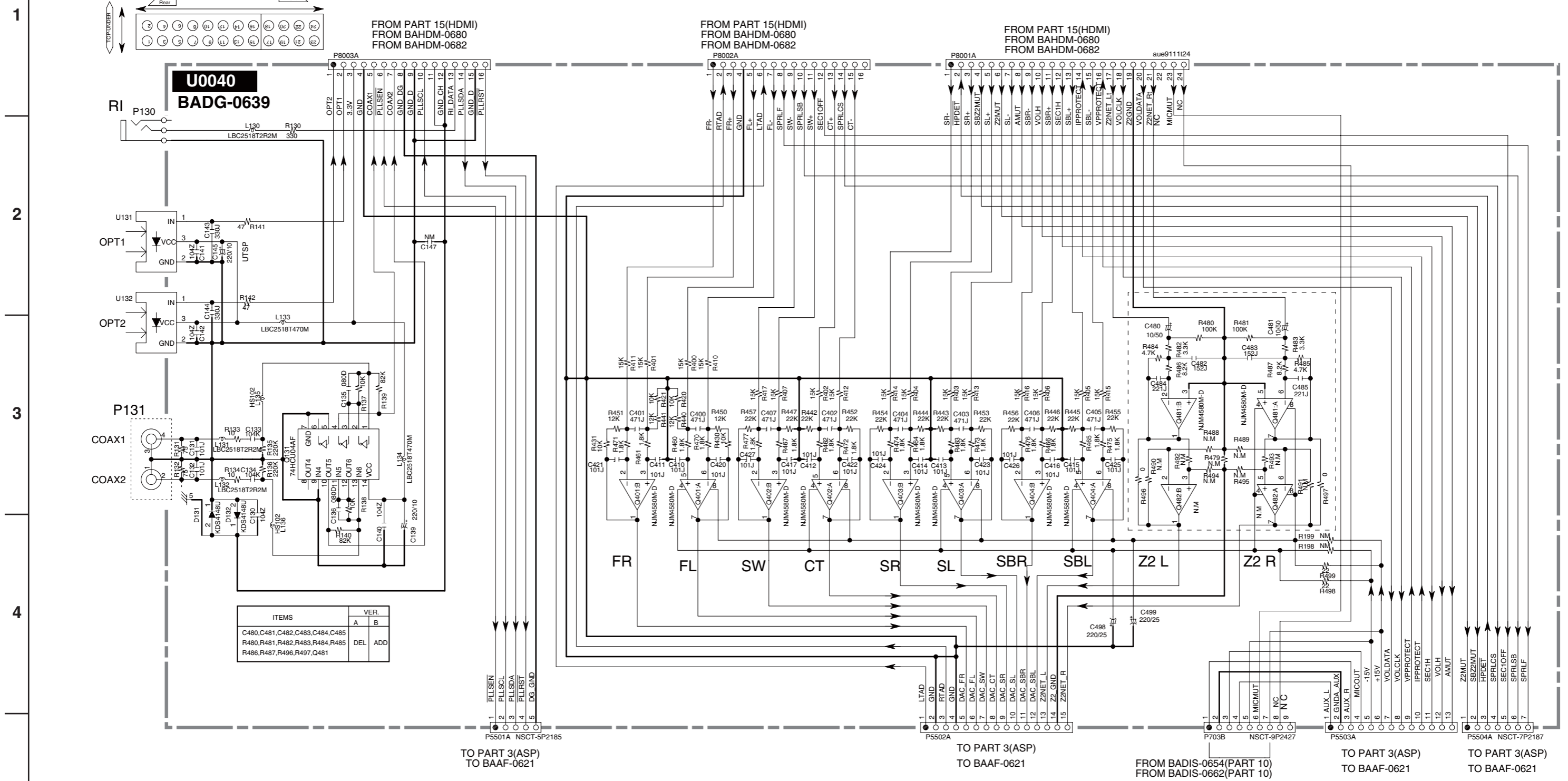

Table A	H59	H59	T5	T5	T5	A57	H99	H99/ T57	H69	
Table B	-1A	-1B	-1C	-1D	-1E	-1F	-1G	-1H	-1J	INSIGNIA
Table C	7ch	7ch	5ch	5ch	5ch	7ch	7ch	7ch	7ch	Tuner RCA
Table D	US	EX	US	EU	EX	J	US	EU	US	Tuner Buffer
Table E	C4001-02	152J	152J	152J	152J	221J	152J	152J	152J	Tuner Imp
Table F	R4212	O	O	X	X	O	X	X	X	A MUT
Table G	R4213	X	X	O	O	O	O	O	O	PreSB/Z2SP MUT
Table H	R4185,86	10(1W)	1(1W)	10(1W)	10(1W)	1(1W)	10(1W)	10(1W)	10(1W)	-15V REG
Table I	R4187,88	22(1W)	8.2(1W)	22(1W)	22(1W)	8.2(1W)	22(1W)	22(1W)	22(1W)	
Table J	R4115-16	2.2K	2.2K	270	270	270	2.2K	2.2K	2.2K	Pre(SB)-T5
Table K	R4125-26	0ohm	0ohm	100	100	100	0ohm	0ohm	0ohm	
Table L	Q4115-16	N.M.	N.M.	RN1441	RN1441	RN1441	N.M.	N.M.	N.M.	
Table M	P4008	X	X	O	O	O	X	X	X	Pre(SB)-RCA
Table N	P4007	X	X	O	O	O	X	O	O	Z2Lineout-RCA
Table O	C4208	103K	103K	102J	102J	102J	103K	102J	102J	SW PREOUT
Table P	C4206	D4107.17	X	X	O	O	O	X	O	ESD for 2P/4P
Table Q	JL502A	R4080,81	X	X	O	O	O	O	O	U-PORT IN
Table R	JL503A	Q4115-16	X	X	7P	7P	X	7P	7P	Z2 UPORT
Table S	P5504B	R4185-86	7P	7P	7P	7P	7P	9P	9P	Z2SPKR

CODE	MODEL
T5	TX-NR509
H59	HT-R590
T57	TX-NR579
A57	TX-NA579
H69	HT-R690
H99	HT-R990

SCHEMATIC DIAGRAM/ BLOCK DIAGRAM-6
DG_A SECTION PART-6

HT-R590/TX-NR509 Schematic Diagram (Part-6) DG_A Section



ITEMS	VER.	
	A	B
C480,C481,C482,C483,C484,C485	DEL	ADD
R480,R481,R482,R483,R484,R485	DEL	ADD
R486,R487,R496,R497,Q481	DEL	ADD

1
2
3
4
5

TO PART 3(ASP)
TO BAAF-0621

TO PART 3(ASP)
TO BAAF-0621

FROM BADIS-0654(PART 10)
FROM BADIS-0662(PART 10)

TO PART 3(ASP)
TO BAAF-0621

TO PART 3(ASP)
TO BAAF-0621

SCHEMATIC DIAGRAM/ BLOCK DIAGRAM-7

VIDEO SECTION PART-7

MODEL No. TX-NR509/ TX-NA509/ HT-R590/ HT-R690/ HT-R990/TX-NR609/ TX-NA609/ HT-RC360/ DTR-20.3/ DTR-30.3 SCHEMATIC DIAGRAM(Part-7) VIDEO SECTION

U0021 BAVD-0664
U0022 BAVD-0672

1

2

3

4

5

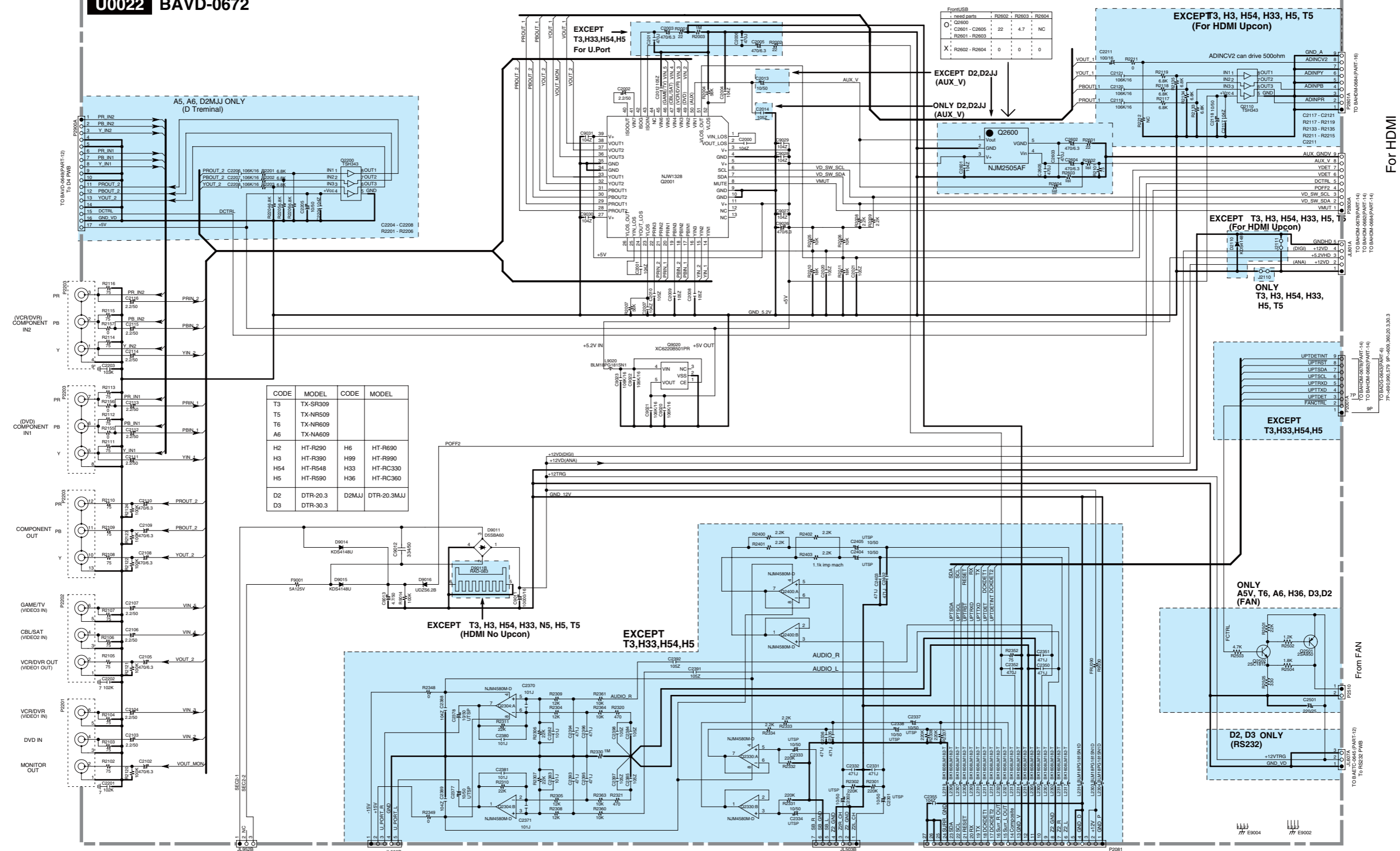

CODE	MODEL	CODE	MODEL
T3	TX-SR309		
T5	TX-NR509		
T6	TX-NR609		
A6	TX-NA609		
H2	HT-R290	H6	HT-R690
H3	HT-R390	H99	HT-R990
H4	HT-R548	H33	HT-RC330
H5	HT-R590	H36	HT-RC360
D2	DTR-20.3	D2MJJ	DTR-20.3MJJ
D3	DTR-30.3		

FrontUSB
need parts

O	Q2600			
X	C2601 - C2605	22	4.7	NC
X	R2601 - R2603			
X	R2602 - R2604	0	0	0

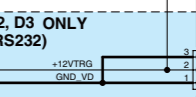
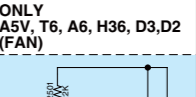
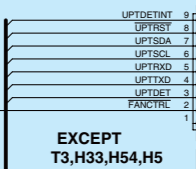
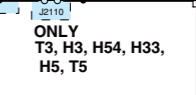
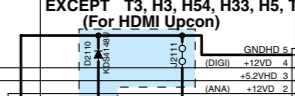
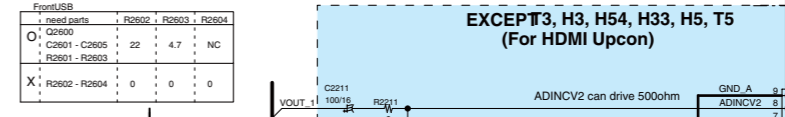
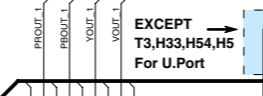
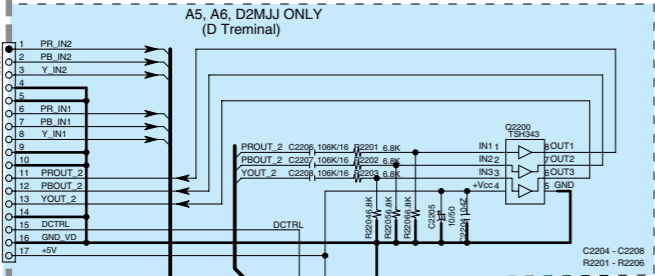

TO BAETC-0618(PART-4)
TO BAETC-0625(PART-4)
TO BAETC-0631(PART-4)
TO AMP PWB

TO BAAF-0614(PART-3)
TO BAAF-0621(PART-3)
TO BAAF-0628(PART-3)
TO AMP PWB

TO BAAF-0614(PART-3)
TO BAAF-0621(PART-3)
TO BAAF-0628(PART-3)
TO AMP PWB

TO UP-A1L
TO iPod Dock

TO BAND048(PART-16)

TO BAND048(PART-14)

TO BAND048(PART-14)

TO BAND048(PART-14)

TO BAND048(PART-14)

TO BAND048(PART-14)

TO BAND048(PART-14)

TO BAND048(PART-14)

For HDMI

From FAN

7P-490.090.079 9P-460.360.0.3.3.3

E9004 E9002

SCHEMATIC DIAGRAM/ BLOCK DIAGRAM-9
DISPLAY SECTION
PART-9

Model No. TX-NR509/609/HT-R690/990/HT-RC360 Schematic Diagram (Part-9) Display Section

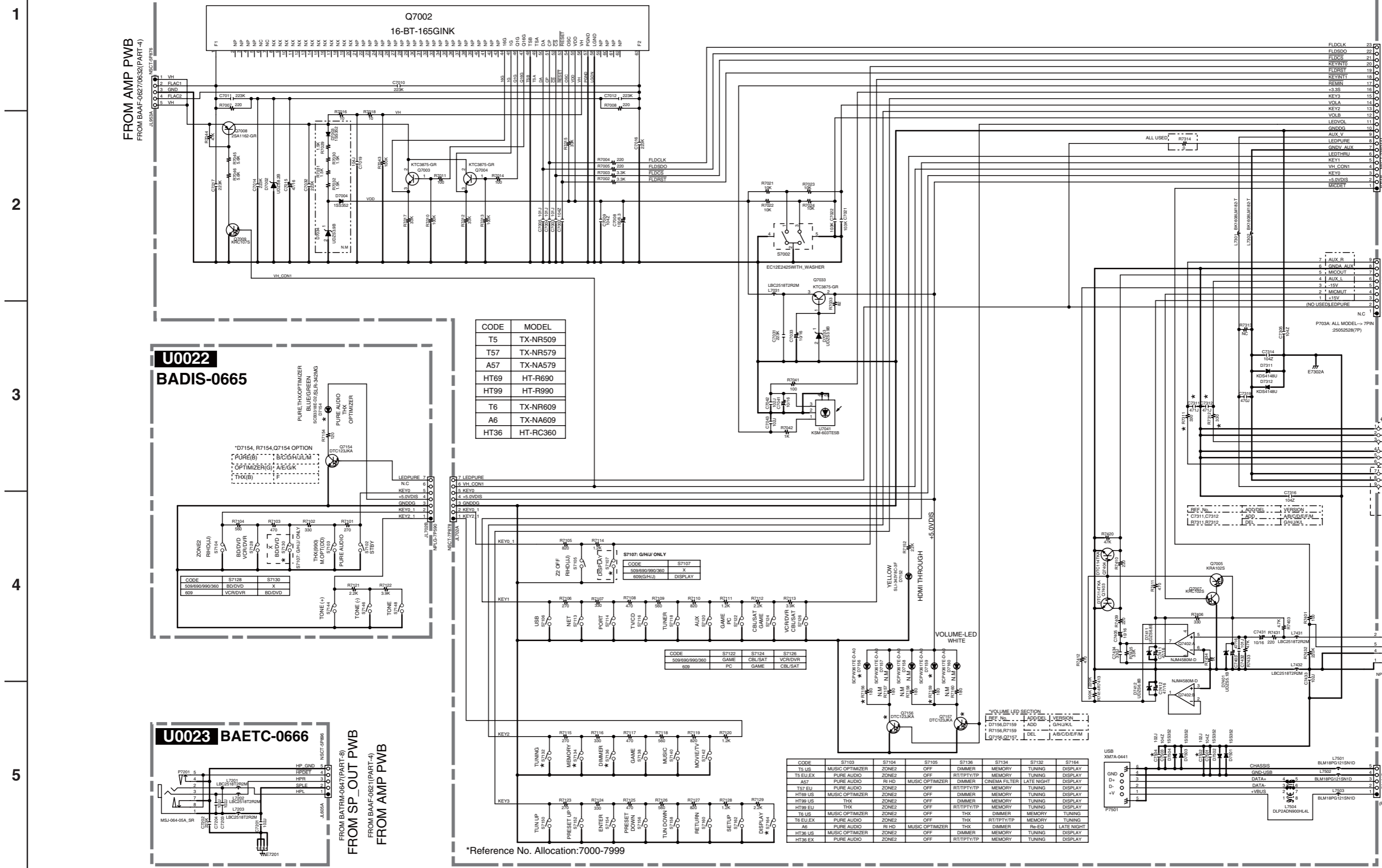

U0020 BADIS-0663

U0022 BADIS-0665

U0023 BAETC-0666

FROM AMP PWB
FROM BAAF-0627/0632(PART-4)

FROM BATM-0647(PART-8)
FROM BAAF-0621(PART-4)
FROM AMP PWB

TO BAHDM-0682/0684(PART-15)
TO BADG-0643(PART-6)
TO HDMI/DG-B PWB

TO BADG-0639/0643(PART-6)
TO DG-A/B PWB

TO BAHDM-0682(PART-21)
TO HDMI PWB

CODE	MODEL
T5	TX-NR509
T57	TX-NR579
A57	TX-NA579
HT69	HT-R690
HT99	HT-R990
T6	TX-NR609
A6	TX-NA609
HT36	HT-RC360

CODE	S7107
509/690/990/360	X
609	GHJ/KL

CODE	S7122	S7124	S7126
509/690/990/360	GAME	CBUS/SAT	VCR/DVR
609	PC	GAME	CBUS/SAT



CODE	S7103	S7104	S7105	S7136	S7134	S7132	S7164
T5 US	MUSIC OPTIMIZER	ZONE2	OFF	DIMMER	MEMORY	TUNING	DISPLAY
T5 EU/EX	PURE AUDIO	ZONE2	OFF	RTTPTV/TP	MEMORY	TUNING	DISPLAY
A57	PURE AUDIO	THX	OFF	MUSIC OPTIMIZER	DIMMER	CINEMA FILTER	LATE NIGHT
T57 EU	PURE AUDIO	ZONE2	OFF	RTTPTV/TP	MEMORY	TUNING	DISPLAY
HT69 US	MUSIC OPTIMIZER	ZONE2	OFF	DIMMER	MEMORY	TUNING	DISPLAY
HT99 US	THX	ZONE2	OFF	DIMMER	MEMORY	TUNING	DISPLAY
HT99 EU	THX	ZONE2	OFF	RTTPTV/TP	MEMORY	TUNING	DISPLAY
T6 US	MUSIC OPTIMIZER	ZONE2	OFF	THX	DIMMER	MEMORY	TUNING
T6 EU/EX	PURE AUDIO	ZONE2	OFF	THX	DIMMER	MEMORY	TUNING
A6	PURE AUDIO	RH/D	MUSIC OPTIMIZER	THX	DIMMER	R-EO	LATE NIGHT
HT36 US	MUSIC OPTIMIZER	ZONE2	OFF	DIMMER	MEMORY	TUNING	DISPLAY
HT36 EX	PURE AUDIO	ZONE2	OFF	RTTPTV/TP	MEMORY	TUNING	DISPLAY

*Reference No. Allocation:7000-7999

A B C D E
SCHEMATIC DIAGRAM/ BLOCK DIAGRAM-10
POWER SUPPLY SECTION PART-10

Model No. TX-NR509/609/HT-R690/990/HT-RC360
 Schematic Diagram (Part-10) PS Section

- ・印は火災、感電の危険に關与する部品の為、必ず指定部品を使用の事。
 ・電圧表示は無信号時に測定した直流電圧を示す。
 (単位V、入力抵抗100kΩ/V以上の電圧計)
- ・記入なき電解コンデンサの単位はμF/WVである。
 ・記入なきコンデンサの単位はpF/50WVである。
 例 0.30→3pF 3.30→33pF 3.31→330pF 3.33→0.033μF
- ・本配線図は基本配線図につき性能改善等により予告なく変更する事がある。

- * THE COMPONENTS IDENTIFIED BY MARK  ARE CRITICAL FOR SAFETY. REPLACE ONLY WITH PART NUMBER SPECIFIED.
- * VOLTAGE (MEASURED WITH VOLT METER) IS DC VOLTAGE. (NO INPUT SIGNAL)
- * ELECTROLYTIC CAPACITORS () ARE IN μF/WV.
- * ALL CAPACITORS ARE IN pF/50WV UNLESS OTHERWISE NOTED.
- EX) 0.30→3pF 3.30→33pF 3.31→330pF 3.33→0.033μF
- * CIRCUIT IS SUBJECT TO CHANGE FOR IMPROVEMENT.

CAUTION



FOR CONTINUED PROTECTION AGAINST FIRE HAZARD, REPLACE ONLY WITH FUSE OF SAME TYPE AND RATING INDICATED.

ATTENTION



CAUTION AFIN D'ASSURER UNE PROTECTION PERMANENTE CONTRE LES RISQUES D'INCENDIE, REMPLACER UNIQUEMENT PAR UN FUSIBLE DE MEME TYPE ET CALIBRATION COMME INDIQUE.



THIS SYMBOL LOCATED NEAR THE FUSE INDICATES THAT THE FUSE USED IS SLOW OPERATING TYPE FOR CONTINUED PROTECTION AGAINST FIRE HAZARD. REPLACE WITH SAME TYPE FUSE. FOR FUSE RATING REFER TO THE MAKING ADJACENT TO THE SYMBOL.



CE SYMBOLE INDIQUE QUE LE FUSIBLE UTILISE EST A LENT, E POUR UNE PROTECTION PERMANENTE. N'UTILISER QUE DES FUSIBLES DE MEME TYPE. CE DERNIER EST INDIQUE LA QU LE PRESENT SYMBOLE EST APOSE.

		T902		
TYPE	T5	A5	HT69	HT99
D,F	NPT-1520JQ	---	NPT-1520JQ	NPT-1520JQ
P,M	NPT-1520GQ	---	---	NPT-1520GQ
J	---	NPT-1520JQ	---	---
TYPE	T6	A6	HT36	
D,F	NPT-1520JQ	---	NPT-1520JQ	
P,M	NPT-1520GQ	---	NPT-1520GQ	
J	---	NPT-1520JQ	---	

CODE	MODEL
T5	TX-NR509
	TX-NR579
A5	TX-NA579
HT69	HT-R690
HT99	HT-R990
T6	TX-NR609
A6	TX-NA609
HT36	HT-RC360

TYPE	AC
D,F	120V / 60HZ
P,M	230-240V / 50HZ
J	100V / 50/60HZ

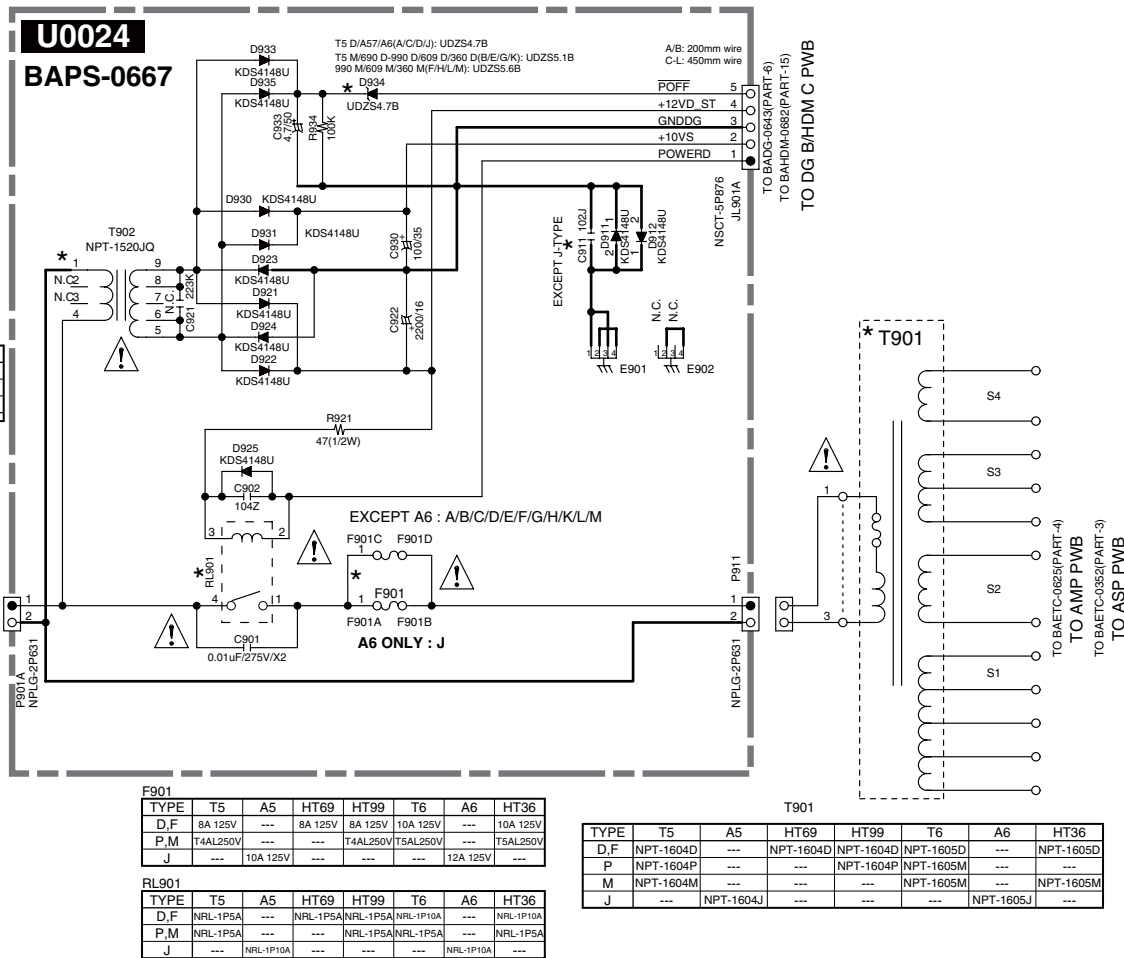

1

2

3

4

SCHEMATIC DIAGRAM/ BLOCK DIAGRAM-18
DIR/ DAC SECTION

1 U0040
BAHDM-0040

Model No. TX-NR509/TX-NA509/TX-NA509V

SCHEMATIC DIAGRAM (PART-18) DIR/DAC Section

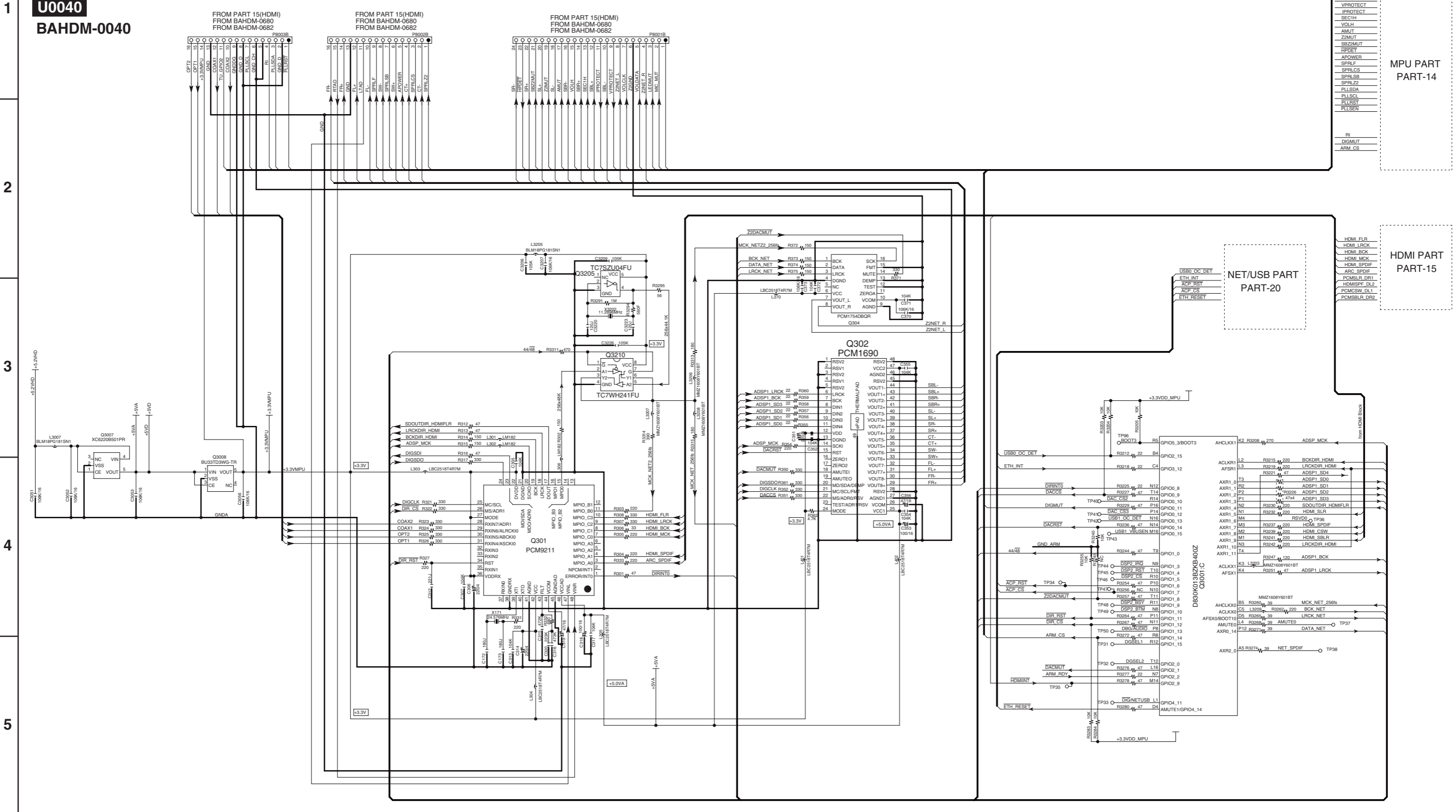

2

3

4

5

MIC MUT
LED MUT
VOL DATA
VOL CLK
VPROTECT
IPROTECT
SECH
VOL H
AMUT
Z2MUT
SBZMUT
RPDET
APPOWER
SPR F
SPR L CS
SPR L S2
FLI SDA
FLI SCL
FLI RST
FLI SEN

RI
DIG MUT
ARM CS

MPU PART PART-14

HDMI FLR
HDMI LRCK
HDMI BCK
HDMI MCK
HDMI SPDIF
PCMSBLR DR1
HDMISPF DL2
PCMSCSW DL1
PCMSBLR DR2

HDMI PART PART-15

NET/USB PART PART-20

USB OC_DET
ETH_INT
ACP_RST
ACP_CS
ETH_RESET

GPIO5_3/BOOT3
GPIO2_15
GPIO3_12
GPIO0_8
GPIO0_9
GPIO0_10
GPIO0_11
GPIO0_12
GPIO0_13
GPIO0_14
GPIO0_15
GPIO1_0
GPIO1_3
GPIO1_4
GPIO1_5
GPIO1_6
GPIO1_7
GPIO1_8
GPIO1_9
GPIO1_10
GPIO1_11
GPIO1_12
GPIO1_13
GPIO1_14
GPIO1_15
GPIO2_0
GPIO2_1
GPIO2_2
GPIO2_9
GPIO4_11
AMUTE1/GPIO4_14

DIR_INT0
DIR_CS
DIR_RST
DIR_RDY
ARM_CS
ARM_RST
ETH_RESET
DACMUT
Z2DACMUT
MCK_NET_256S
BCK_NET
DATA_NET
LRCK_NET
VCC
ZEROA
VOUT_L
VOUT_R
AGND
VCC
VCC2
AGND2
VOUT1
VOUT2
VOUT3
VOUT4
VOUT5
VOUT6
VOUT7
VOUT8
VOUT9
VOUT10
VOUT11
VOUT12
VOUT13
VOUT14
VOUT15
VOUT16
VOUT17
VOUT18
VOUT19
VOUT20
VOUT21
VOUT22
VOUT23
VOUT24
VOUT25
VOUT26
VOUT27
VOUT28
VOUT29
VOUT30
VOUT31
VOUT32
VOUT33
VOUT34
VOUT35
VOUT36
VOUT37
VOUT38
VOUT39
VOUT40
VOUT41
VOUT42
VOUT43
VOUT44
VOUT45
VOUT46
VOUT47
VOUT48
VOUT49
VOUT50
VOUT51
VOUT52
VOUT53
VOUT54
VOUT55
VOUT56
VOUT57
VOUT58
VOUT59
VOUT60
VOUT61
VOUT62
VOUT63
VOUT64
VOUT65
VOUT66
VOUT67
VOUT68
VOUT69
VOUT70
VOUT71
VOUT72
VOUT73
VOUT74
VOUT75
VOUT76
VOUT77
VOUT78
VOUT79
VOUT80
VOUT81
VOUT82
VOUT83
VOUT84
VOUT85
VOUT86
VOUT87
VOUT88
VOUT89
VOUT90
VOUT91
VOUT92
VOUT93
VOUT94
VOUT95
VOUT96
VOUT97
VOUT98
VOUT99
VOUT100
VOUT101
VOUT102
VOUT103
VOUT104
VOUT105
VOUT106
VOUT107
VOUT108
VOUT109
VOUT110
VOUT111
VOUT112
VOUT113
VOUT114
VOUT115
VOUT116
VOUT117
VOUT118
VOUT119
VOUT120
VOUT121
VOUT122
VOUT123
VOUT124
VOUT125
VOUT126
VOUT127
VOUT128
VOUT129
VOUT130
VOUT131
VOUT132
VOUT133
VOUT134
VOUT135
VOUT136
VOUT137
VOUT138
VOUT139
VOUT140
VOUT141
VOUT142
VOUT143
VOUT144
VOUT145
VOUT146
VOUT147
VOUT148
VOUT149
VOUT150
VOUT151
VOUT152
VOUT153
VOUT154
VOUT155
VOUT156
VOUT157
VOUT158
VOUT159
VOUT160
VOUT161
VOUT162
VOUT163
VOUT164
VOUT165
VOUT166
VOUT167
VOUT168
VOUT169
VOUT170
VOUT171
VOUT172
VOUT173
VOUT174
VOUT175
VOUT176
VOUT177
VOUT178
VOUT179
VOUT180
VOUT181
VOUT182
VOUT183
VOUT184
VOUT185
VOUT186
VOUT187
VOUT188
VOUT189
VOUT190
VOUT191
VOUT192
VOUT193
VOUT194
VOUT195
VOUT196
VOUT197
VOUT198
VOUT199
VOUT200
VOUT201
VOUT202
VOUT203
VOUT204
VOUT205
VOUT206
VOUT207
VOUT208
VOUT209
VOUT210
VOUT211
VOUT212
VOUT213
VOUT214
VOUT215
VOUT216
VOUT217
VOUT218
VOUT219
VOUT220
VOUT221
VOUT222
VOUT223
VOUT224
VOUT225
VOUT226
VOUT227
VOUT228
VOUT229
VOUT230
VOUT231
VOUT232
VOUT233
VOUT234
VOUT235
VOUT236
VOUT237
VOUT238
VOUT239
VOUT240
VOUT241
VOUT242
VOUT243
VOUT244
VOUT245
VOUT246
VOUT247
VOUT248
VOUT249
VOUT250
VOUT251
VOUT252
VOUT253
VOUT254
VOUT255
VOUT256
VOUT257
VOUT258
VOUT259
VOUT260
VOUT261
VOUT262
VOUT263
VOUT264
VOUT265
VOUT266
VOUT267
VOUT268
VOUT269
VOUT270
VOUT271
VOUT272
VOUT273
VOUT274
VOUT275
VOUT276
VOUT277
VOUT278
VOUT279
VOUT280
VOUT281
VOUT282
VOUT283
VOUT284
VOUT285
VOUT286
VOUT287
VOUT288
VOUT289
VOUT290
VOUT291
VOUT292
VOUT293
VOUT294
VOUT295
VOUT296
VOUT297
VOUT298
VOUT299
VOUT300
VOUT301
VOUT302
VOUT303
VOUT304
VOUT305
VOUT306
VOUT307
VOUT308
VOUT309
VOUT310
VOUT311
VOUT312
VOUT313
VOUT314
VOUT315
VOUT316
VOUT317
VOUT318
VOUT319
VOUT320
VOUT321
VOUT322
VOUT323
VOUT324
VOUT325
VOUT326
VOUT327
VOUT328
VOUT329
VOUT330
VOUT331
VOUT332
VOUT333
VOUT334
VOUT335
VOUT336
VOUT337
VOUT338
VOUT339
VOUT340
VOUT341
VOUT342
VOUT343
VOUT344
VOUT345
VOUT346
VOUT347
VOUT348
VOUT349
VOUT350
VOUT351
VOUT352
VOUT353
VOUT354
VOUT355
VOUT356
VOUT357
VOUT358
VOUT359
VOUT360
VOUT361
VOUT362
VOUT363
VOUT364
VOUT365
VOUT366
VOUT367
VOUT368
VOUT369
VOUT370
VOUT371
VOUT372
VOUT373
VOUT374
VOUT375
VOUT376
VOUT377
VOUT378
VOUT379
VOUT380
VOUT381
VOUT382
VOUT383
VOUT384
VOUT385
VOUT386
VOUT387
VOUT388
VOUT389
VOUT390
VOUT391
VOUT392
VOUT393
VOUT394
VOUT395
VOUT396
VOUT397
VOUT398
VOUT399
VOUT400
VOUT401
VOUT402
VOUT403
VOUT404
VOUT405
VOUT406
VOUT407
VOUT408
VOUT409
VOUT410
VOUT411
VOUT412
VOUT413
VOUT414
VOUT415
VOUT416
VOUT417
VOUT418
VOUT419
VOUT420
VOUT421
VOUT422
VOUT423
VOUT424
VOUT425
VOUT426
VOUT427
VOUT428
VOUT429
VOUT430
VOUT431
VOUT432
VOUT433
VOUT434
VOUT435
VOUT436
VOUT437
VOUT438
VOUT439
VOUT440
VOUT441
VOUT442
VOUT443
VOUT444
VOUT445
VOUT446
VOUT447
VOUT448
VOUT449
VOUT450
VOUT451
VOUT452
VOUT453
VOUT454
VOUT455
VOUT456
VOUT457
VOUT458
VOUT459
VOUT460
VOUT461
VOUT462
VOUT463
VOUT464
VOUT465
VOUT466
VOUT467
VOUT468
VOUT469
VOUT470
VOUT471
VOUT472
VOUT473
VOUT474
VOUT475
VOUT476
VOUT477
VOUT478
VOUT479
VOUT480
VOUT481
VOUT482
VOUT483
VOUT484
VOUT485
VOUT486
VOUT487
VOUT488
VOUT489
VOUT490
VOUT491
VOUT492
VOUT493
VOUT494
VOUT495
VOUT496
VOUT497
VOUT498
VOUT499
VOUT500
VOUT501
VOUT502
VOUT503
VOUT504
VOUT505
VOUT506
VOUT507
VOUT508
VOUT509
VOUT510
VOUT511
VOUT512
VOUT513
VOUT514
VOUT515
VOUT516
VOUT517
VOUT518
VOUT519
VOUT520
VOUT521
VOUT522
VOUT523
VOUT524
VOUT525
VOUT526
VOUT527
VOUT528
VOUT529
VOUT530
VOUT531
VOUT532
VOUT533
VOUT534
VOUT535
VOUT536
VOUT537
VOUT538
VOUT539
VOUT540
VOUT541
VOUT542
VOUT543
VOUT544
VOUT545
VOUT546
VOUT547
VOUT548
VOUT549
VOUT550
VOUT551
VOUT552
VOUT553
VOUT554
VOUT555
VOUT556
VOUT557
VOUT558
VOUT559
VOUT560
VOUT561
VOUT562
VOUT563
VOUT564
VOUT565
VOUT566
VOUT567
VOUT568
VOUT569
VOUT570
VOUT571
VOUT572
VOUT573
VOUT574
VOUT575
VOUT576
VOUT577
VOUT578
VOUT579
VOUT580
VOUT581
VOUT582
VOUT583
VOUT584
VOUT585
VOUT586
VOUT587
VOUT588
VOUT589
VOUT590
VOUT591
VOUT592
VOUT593
VOUT594
VOUT595
VOUT596
VOUT597
VOUT598
VOUT599
VOUT600
VOUT601
VOUT602
VOUT603
VOUT604
VOUT605
VOUT606
VOUT607
VOUT608
VOUT609
VOUT610
VOUT611
VOUT612
VOUT613
VOUT614
VOUT615
VOUT616
VOUT617
VOUT618
VOUT619
VOUT620
VOUT621
VOUT622
VOUT623
VOUT624
VOUT625
VOUT626
VOUT627
VOUT628
VOUT629
VOUT630
VOUT631
VOUT632
VOUT633
VOUT634
VOUT635
VOUT636
VOUT637
VOUT638
VOUT639
VOUT640
VOUT641
VOUT642
VOUT643
VOUT644
VOUT645
VOUT646
VOUT647
VOUT648
VOUT649
VOUT650
VOUT651
VOUT652
VOUT653
VOUT654
VOUT655
VOUT656
VOUT657
VOUT658
VOUT659
VOUT660
VOUT661
VOUT662
VOUT663
VOUT664
VOUT665
VOUT666
VOUT667
VOUT668
VOUT669
VOUT670
VOUT671
VOUT672
VOUT673
VOUT674
VOUT675
VOUT676
VOUT677
VOUT678
VOUT679
VOUT680
VOUT681
VOUT682
VOUT683
VOUT684
VOUT685
VOUT686
VOUT687
VOUT688
VOUT689
VOUT690
VOUT691
VOUT692
VOUT693
VOUT694
VOUT695
VOUT696
VOUT697
VOUT698
VOUT699
VOUT700
VOUT701
VOUT702
VOUT703
VOUT704
VOUT705
VOUT706
VOUT707
VOUT708
VOUT709
VOUT710
VOUT711
VOUT712
VOUT713
VOUT714
VOUT715
VOUT716
VOUT717
VOUT718
VOUT719
VOUT720
VOUT721
VOUT722
VOUT723
VOUT724
VOUT725
VOUT726
VOUT727
VOUT728
VOUT729
VOUT730
VOUT731
VOUT732
VOUT733
VOUT734
VOUT735
VOUT736
VOUT737
VOUT738
VOUT739
VOUT740
VOUT741
VOUT742
VOUT743
VOUT744
VOUT745
VOUT746
VOUT747
VOUT748
VOUT749
VOUT750
VOUT751
VOUT752
VOUT753
VOUT754
VOUT755
VOUT756
VOUT757
VOUT758
VOUT759
VOUT760
VOUT761
VOUT762
VOUT763
VOUT764
VOUT765
VOUT766
VOUT767
VOUT768
VOUT769
VOUT770
VOUT771
VOUT772
VOUT773
VOUT774
VOUT775
VOUT776
VOUT777
VOUT778
VOUT779
VOUT780
VOUT781
VOUT782
VOUT783
VOUT784
VOUT785
VOUT786
VOUT787
VOUT788
VOUT789
VOUT790
VOUT791
VOUT792
VOUT793
VOUT794
VOUT795
VOUT796
VOUT797
VOUT798
VOUT799
VOUT800
VOUT801
VOUT802
VOUT803
VOUT804
VOUT805
VOUT806
VOUT807
VOUT808
VOUT809
VOUT810
VOUT811
VOUT812
VOUT813
VOUT814
VOUT815
VOUT816
VOUT817
VOUT818
VOUT819
VOUT820
VOUT821
VOUT822
VOUT823
VOUT824
VOUT825
VOUT826
VOUT827
VOUT828
VOUT829
VOUT830
VOUT831
VOUT832
VOUT833
VOUT834
VOUT835
VOUT836
VOUT837
VOUT838
VOUT839
VOUT840
VOUT841
VOUT842
VOUT843
VOUT844
VOUT845
VOUT846
VOUT847
VOUT848
VOUT849
VOUT850
VOUT851
VOUT852
VOUT853
VOUT854
VOUT855
VOUT856
VOUT857
VOUT858
VOUT859
VOUT860
VOUT861
VOUT862
VOUT863
VOUT864
VOUT865
VOUT866
VOUT867
VOUT868
VOUT869
VOUT870
VOUT871
VOUT872
VOUT873
VOUT874
VOUT875
VOUT876
VOUT877
VOUT878
VOUT879
VOUT880
VOUT881
VOUT882
VOUT883
VOUT884
VOUT885
VOUT886
VOUT887
VOUT888
VOUT889
VOUT890
VOUT891
VOUT892
VOUT893
VOUT894
VOUT895
VOUT896
VOUT897
VOUT898
VOUT899
VOUT900
VOUT901
VOUT902
VOUT903
VOUT904
VOUT905
VOUT906
VOUT907
VOUT908
VOUT909
VOUT910
VOUT911
VOUT912
VOUT913
VOUT914
VOUT915
VOUT916
VOUT917
VOUT918
VOUT919
VOUT920
VOUT921
VOUT922
VOUT923
VOUT924
VOUT925
VOUT926
VOUT927
VOUT928
VOUT929
VOUT930
VOUT931
VOUT932
VOUT933
VOUT934
VOUT935
VOUT936
VOUT937
VOUT938
VOUT939
VOUT940
VOUT941
VOUT942
VOUT943
VOUT944
VOUT945
VOUT946
VOUT947
VOUT948
VOUT949
VOUT950
VOUT951
VOUT952
VOUT953
VOUT954
VOUT955
VOUT956
VOUT957
VOUT958
VOUT959
VOUT960
VOUT961
VOUT962
VOUT963
VOUT964
VOUT965
VOUT966
VOUT967
VOUT968
VOUT969
VOUT970
VOUT971
VOUT972
VOUT973
VOUT974
VOUT975
VOUT976
VOUT977
VOUT978
VOUT979
VOUT980
VOUT981
VOUT982
VOUT983
VOUT984
VOUT985
VOUT986
VOUT987
VOUT988
VOUT989
VOUT990
VOUT991
VOUT992
VOUT993
VOUT994
VOUT995
VOUT996
VOUT997
VOUT998
VOUT999
VOUT1000

A B C D E F G H

SCHEMATIC DIAGRAM/ BLOCK DIAGRAM-19

1ST DSP MEMORY SECTION
PART-19

Model No. TX-NR509/TX-NA509/TX-NA509V
1stDSP Memory Section

SCHEMATIC DIAGRAM (PART-19)

1

2

3

4

5

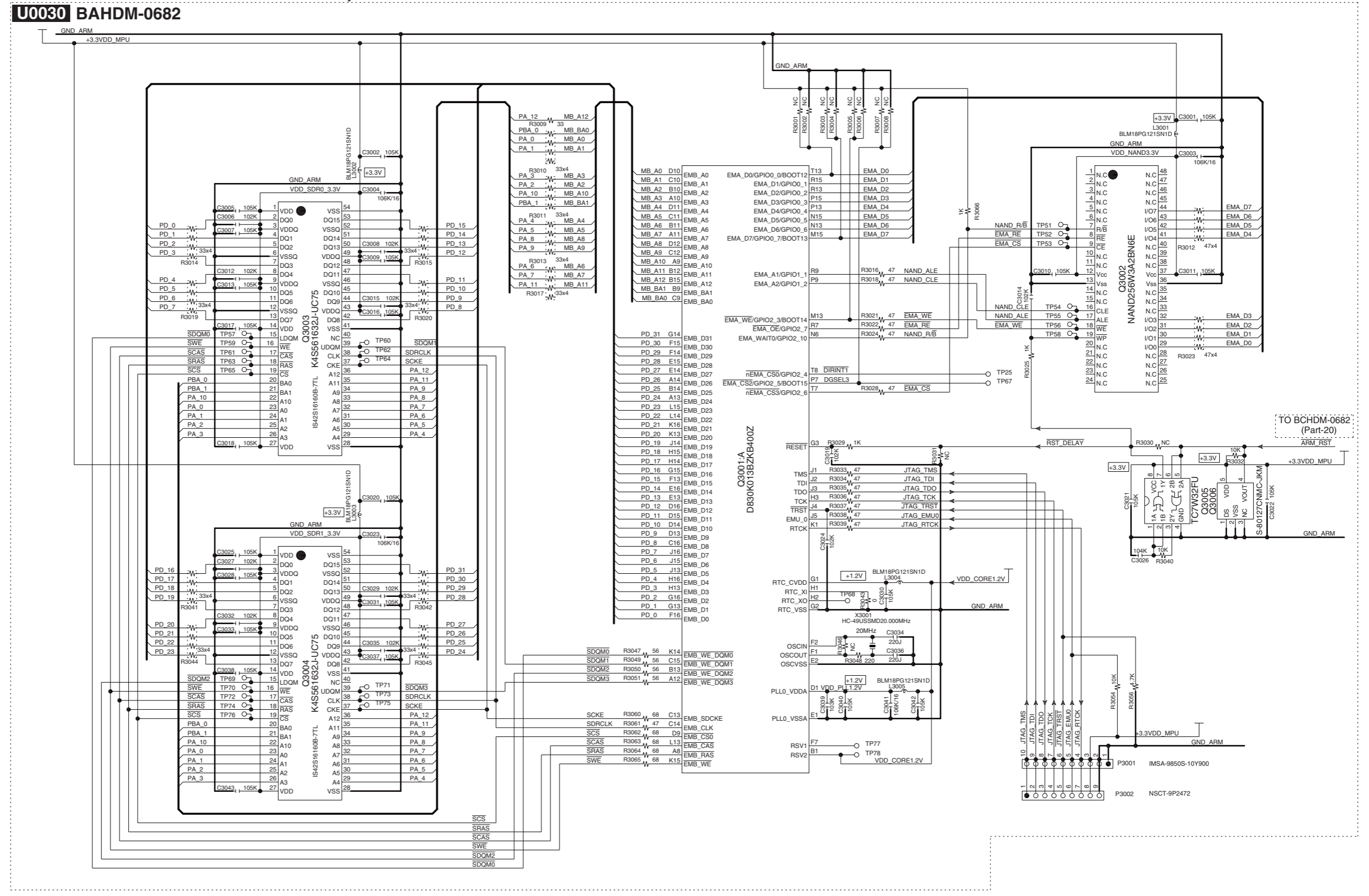

TO BCHDM-0682
(Part-20)

SCHEMATIC DIAGRAM/ BLOCK DIAGRAM-20

NET/ USB POWER SECTION

PART-20

U0030 BAHDM-0682

Model No. TX-NR509/TX-NA509/TX-NA509V

SCHEMATIC DIAGRAM (PART-20)

NET/USB Power Section

R3115 or R3116	BOOT2
R3111 or R3112	BOOT5
R3109 or R3110	BOOT6
R3107 or R3108	BOOT7

Boot Opt.			
BOOT7	L	H	L
BOOT1	H	H	L
BOOT0	H	L	L
BOOT3	H	L	L
BOOT2	H	L	L

BOOT3 is always pulled up.

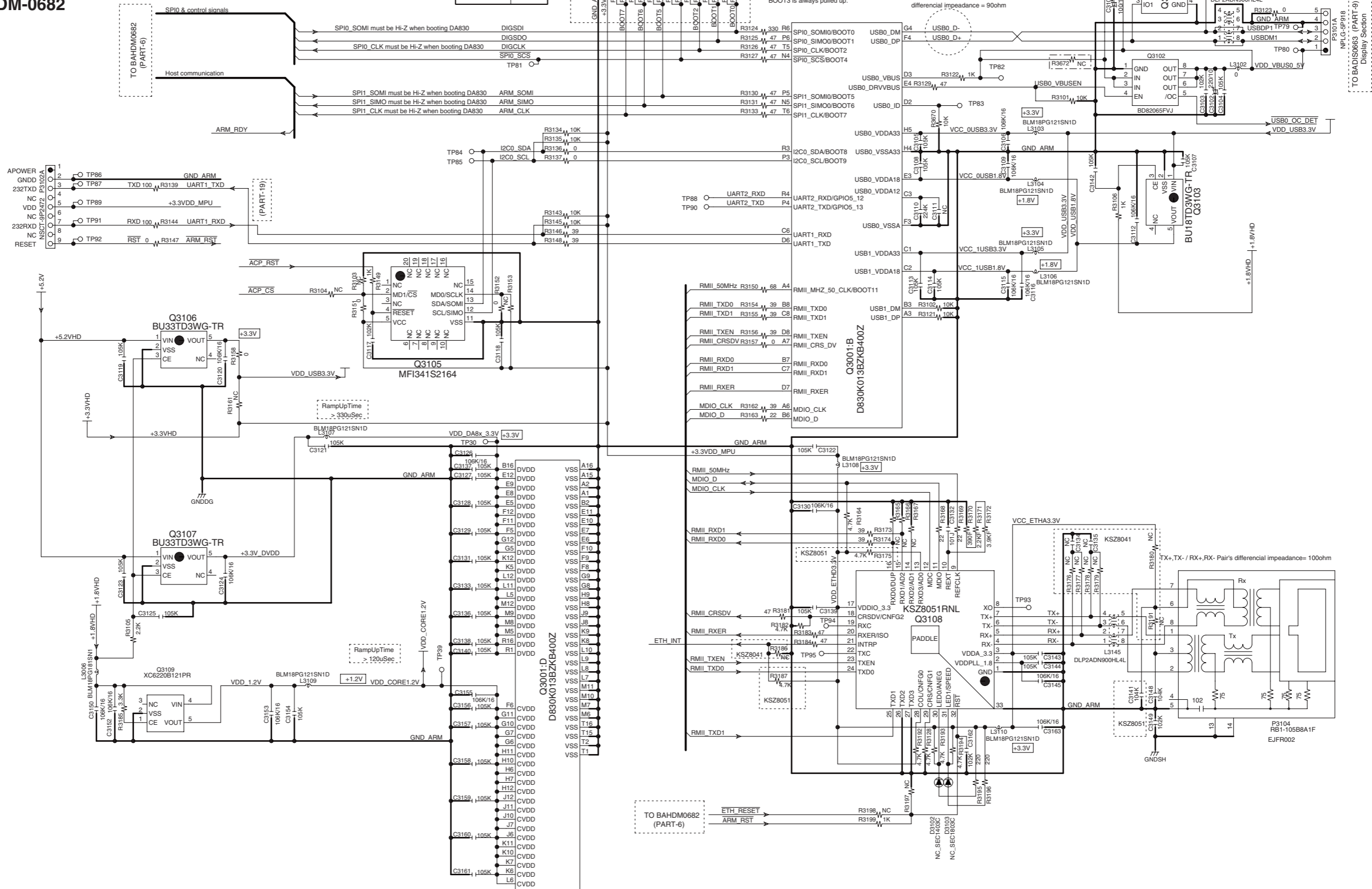

1

2

3

4

5

TO BAHDM0682 (PART-9)
NPLG-9P-918
P3101A
Display Section

TO BAHDM0682 (PART-6)
ETH RESET
ARM_RST

A

B

C

D

E

F

G

H

PRINTED CIRCUIT BOARD VIEWS-1

U001

BAAF-0621
(U0010 to U0017)

A-side view

1

2

3

4

5

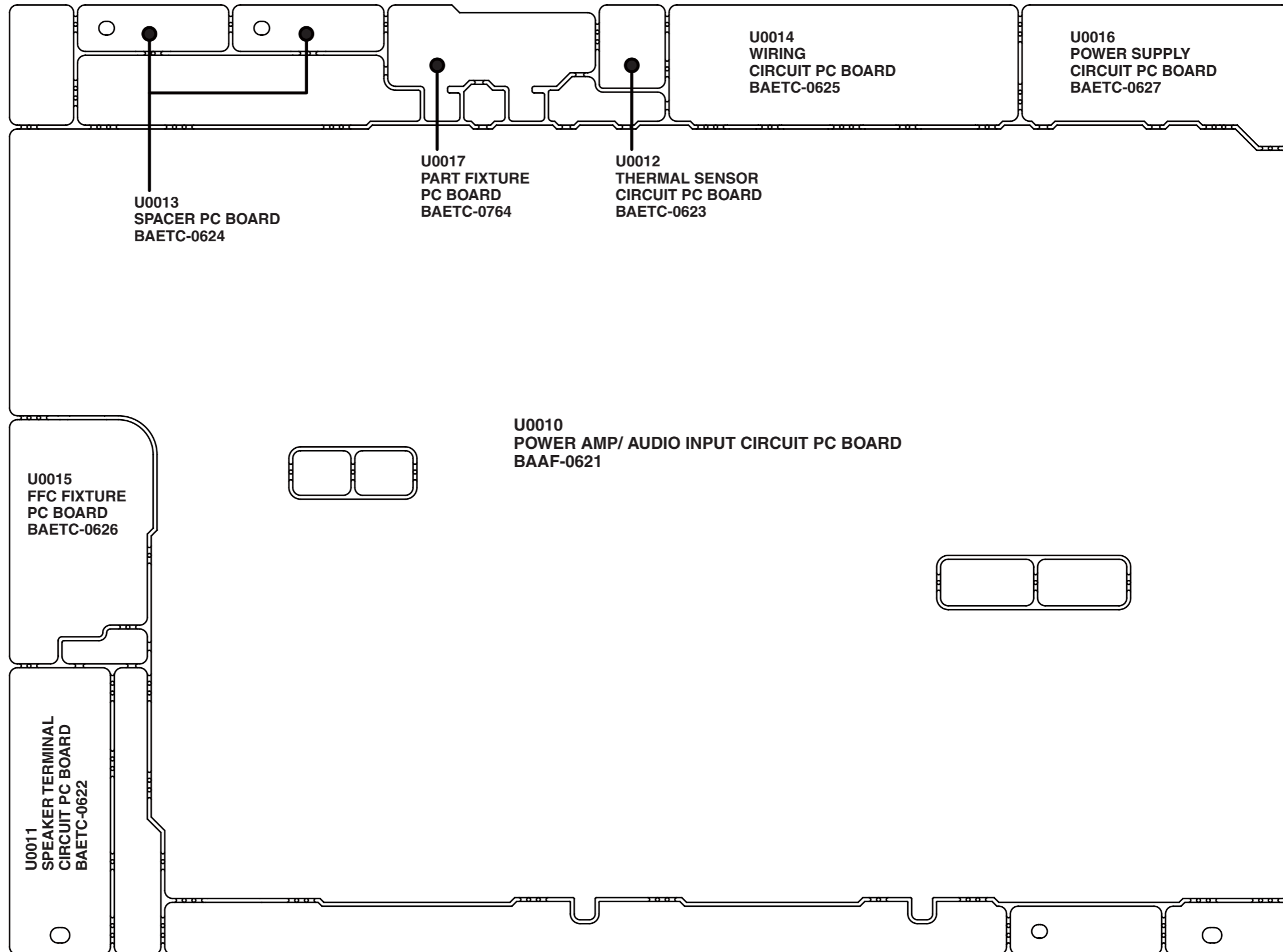

A B C D E F G H
PRINTED CIRCUIT BOARD VIEWS-1A

U001
BAAF-0621
(U0010 to U0017)
A-side view

1

2

3

4

5

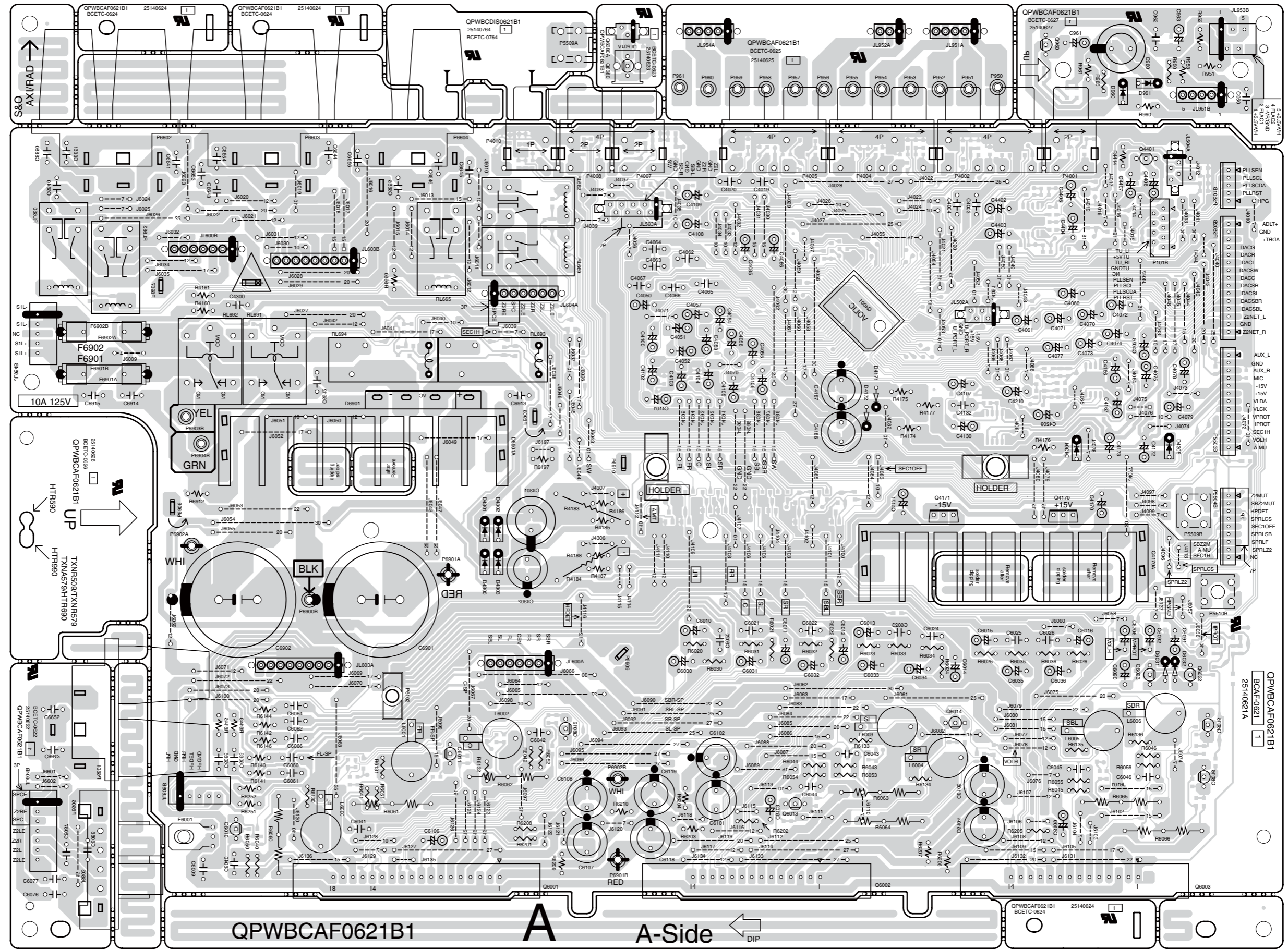

QPWBCAF0621B1

A

A-Side

DIP

QPWBCAF0621B1
BCETC-0621
25140621A

QPWBCAF0621B1
BCETC-0624
25140624

A B C D E F G H

PRINTED CIRCUIT BOARD VIEWS-1B

U001
BAAF-0621
(U0010 to U0017)
B-side view

1

2

3

4

5

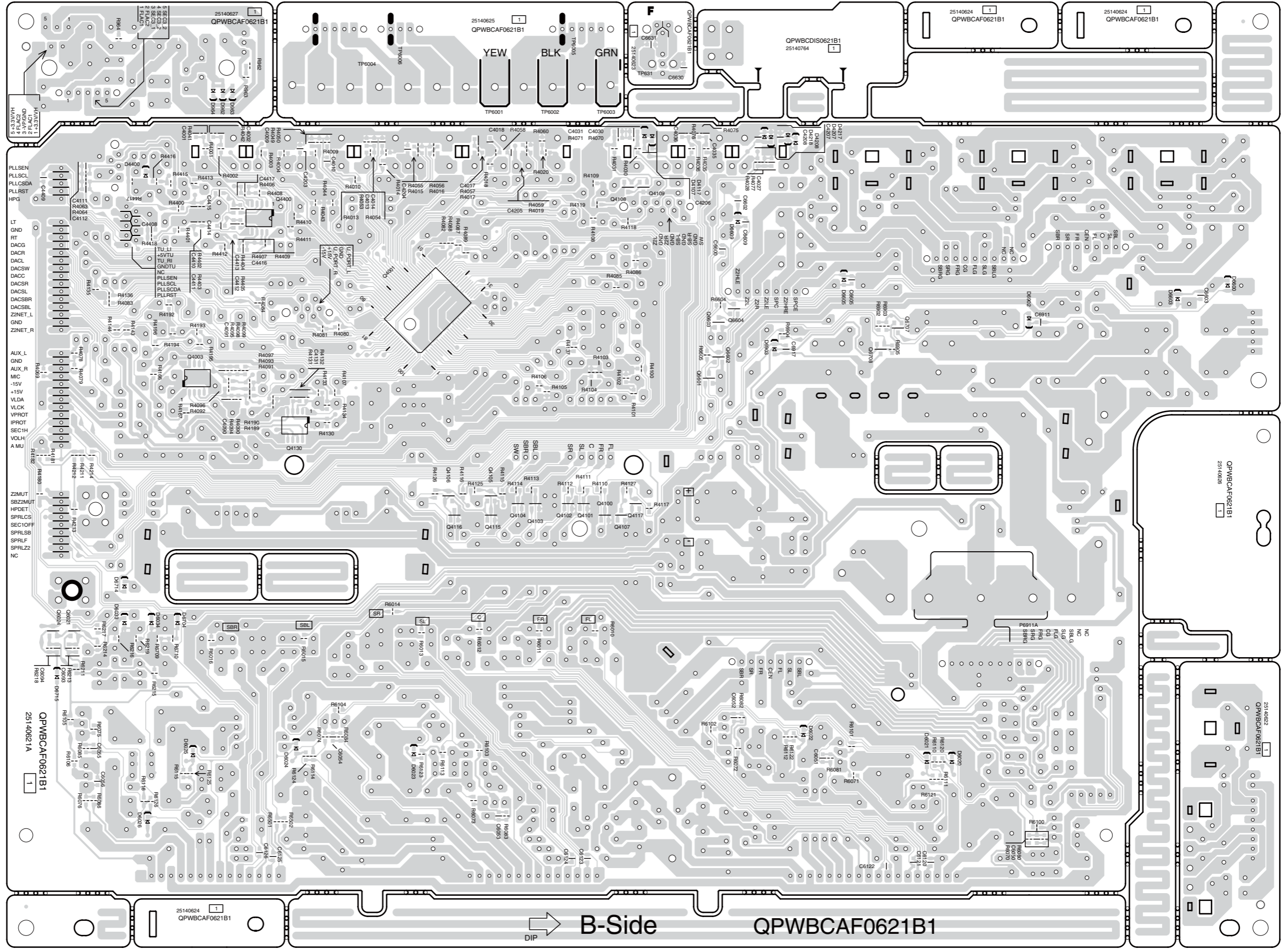

DIP → **B-Side** **QPWBCAF0621B1**

A

B

C

D

E

F

G

H

PRINTED CIRCUIT BOARD VIEWS-2

U002

BADIS-0663
(U0020 to U0024)

A-side view

1

2

3

4

5

U0020
DISPLAY CIRCUIT PC BOARD
BADIS-0663

U0023
HEADPHONES
CIRCUIT PC BOARD
BAETC-0666

U0021
VIDEO INPUT TERMINALS CIRCUIT PC BOARD
BAVD-0664

U0024
POWER SUPPLY CIRCUIT PC BOARD
BAPS-0667

U0022
STANDBY ETC. SWITCH
CIRCUIT PC BOARD
BAETC-0665

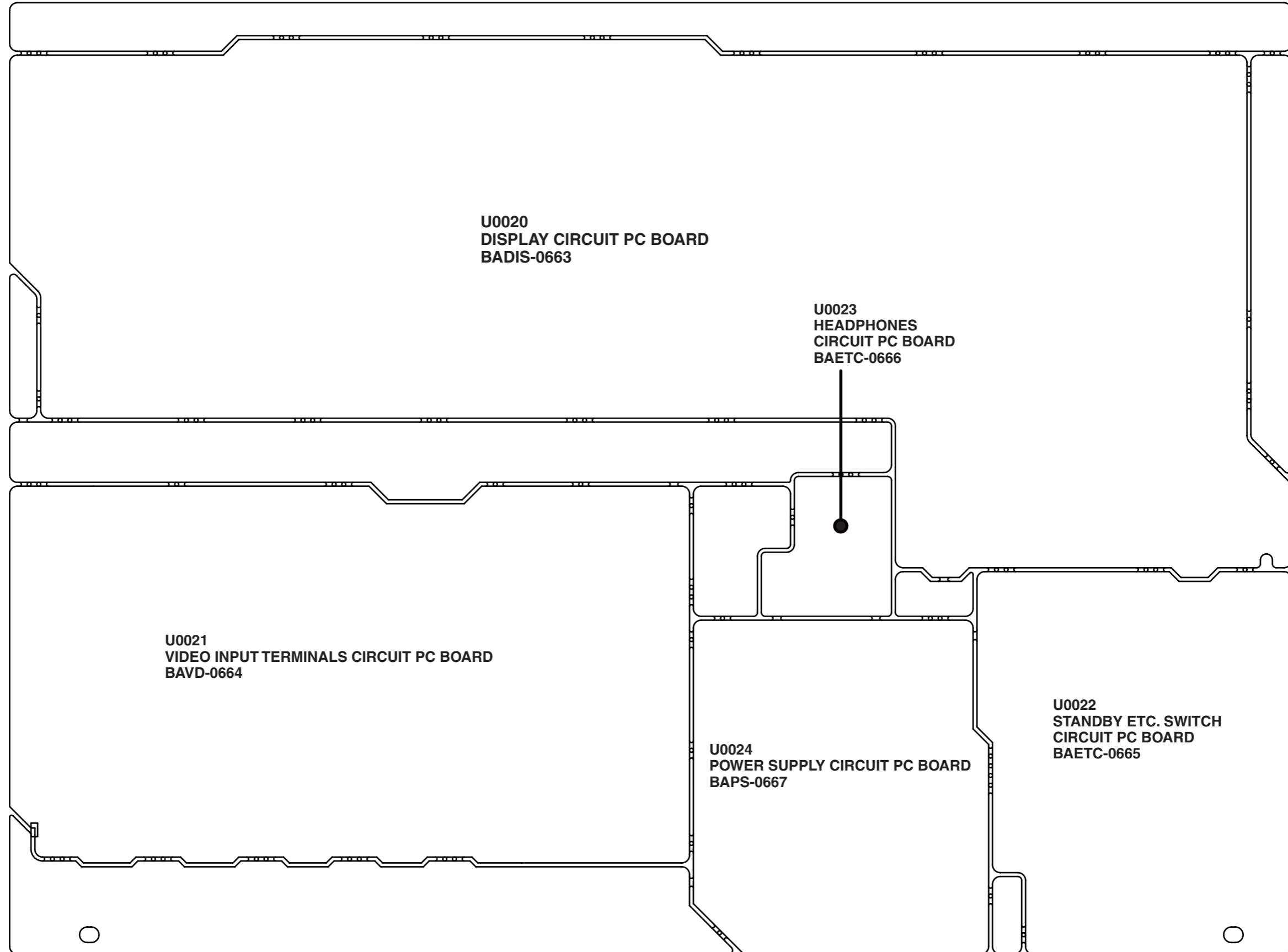

A B C D E F G H

U002
BADIS-0663
(U0020 to U0024)
A-side view

1

2

3

4

5

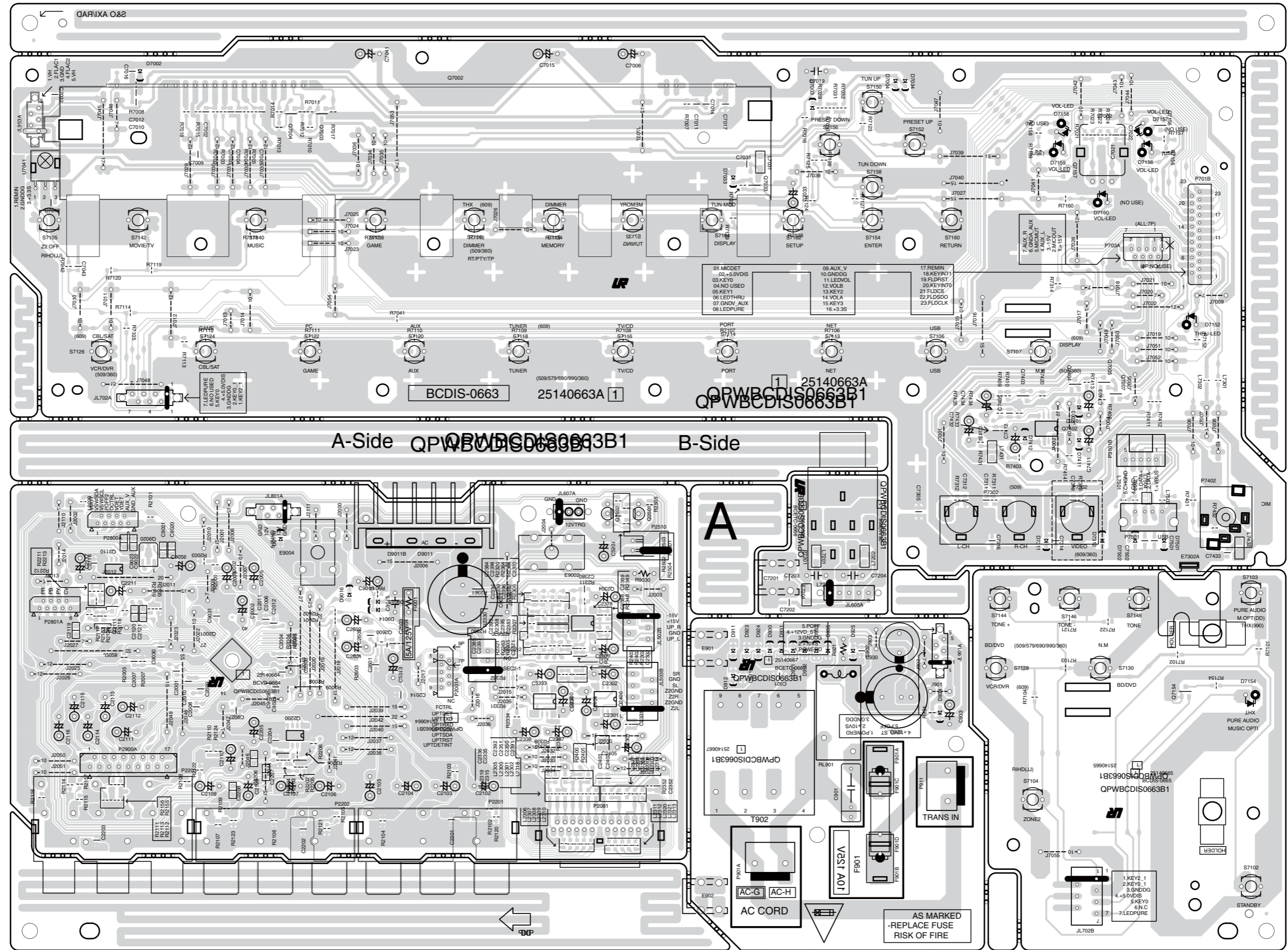

A-Side QPWBCDIS0663B1 B-Side

A

AC CORD
 AC-G AC-H
 V21 A01
 F901
 AS MARKED - REPLACE FUSE RISK OF FIRE

1 KEY2.1
 2 KEY0.1
 3 GND/DG
 4.5 5V0V5
 5 KEY0
 6 NC
 7 LED/PURE

A

B

C

D

E

F

G

H

PRINTED CIRCUIT BOARD VIEWS-2B

U002

BADIS-0663
(U0020 to U0024)

B-side view

1

2

3

4

5

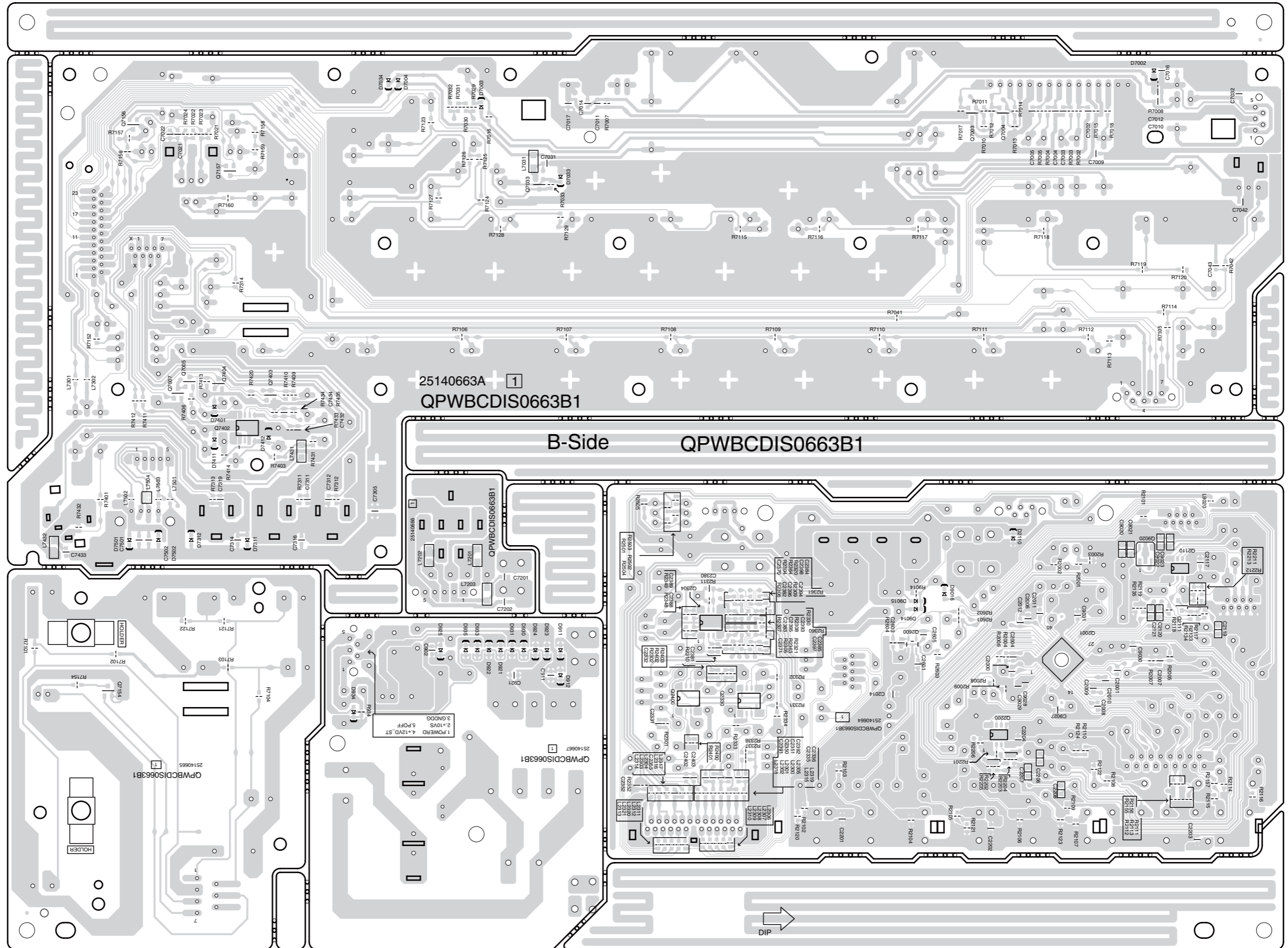

A B C D E F G H

PRINTED CIRCUIT BOARD VIEWS-3

U003
HDMI CIRCUIT BOARD
BAHDM-0682
A-side view

1

2

3

4

5

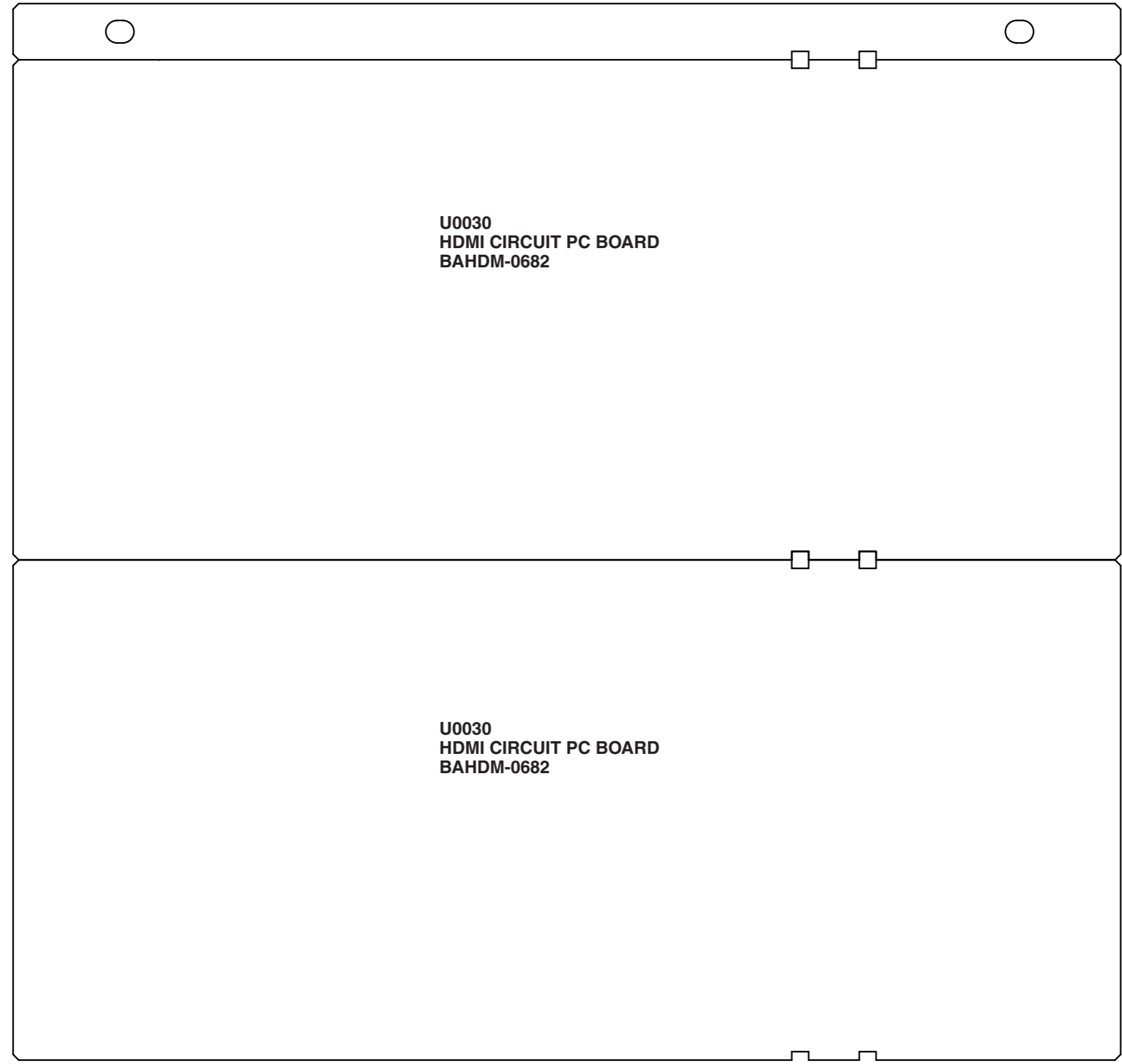



A B C D E F G H

PRINTED CIRCUIT BOARD VIEWS-3A

U003
HDMI CIRCUIT PC BOARD
BAHDM-0682
(U0030 x 2)

A-side view

 A-side pattern
 B-side pattern

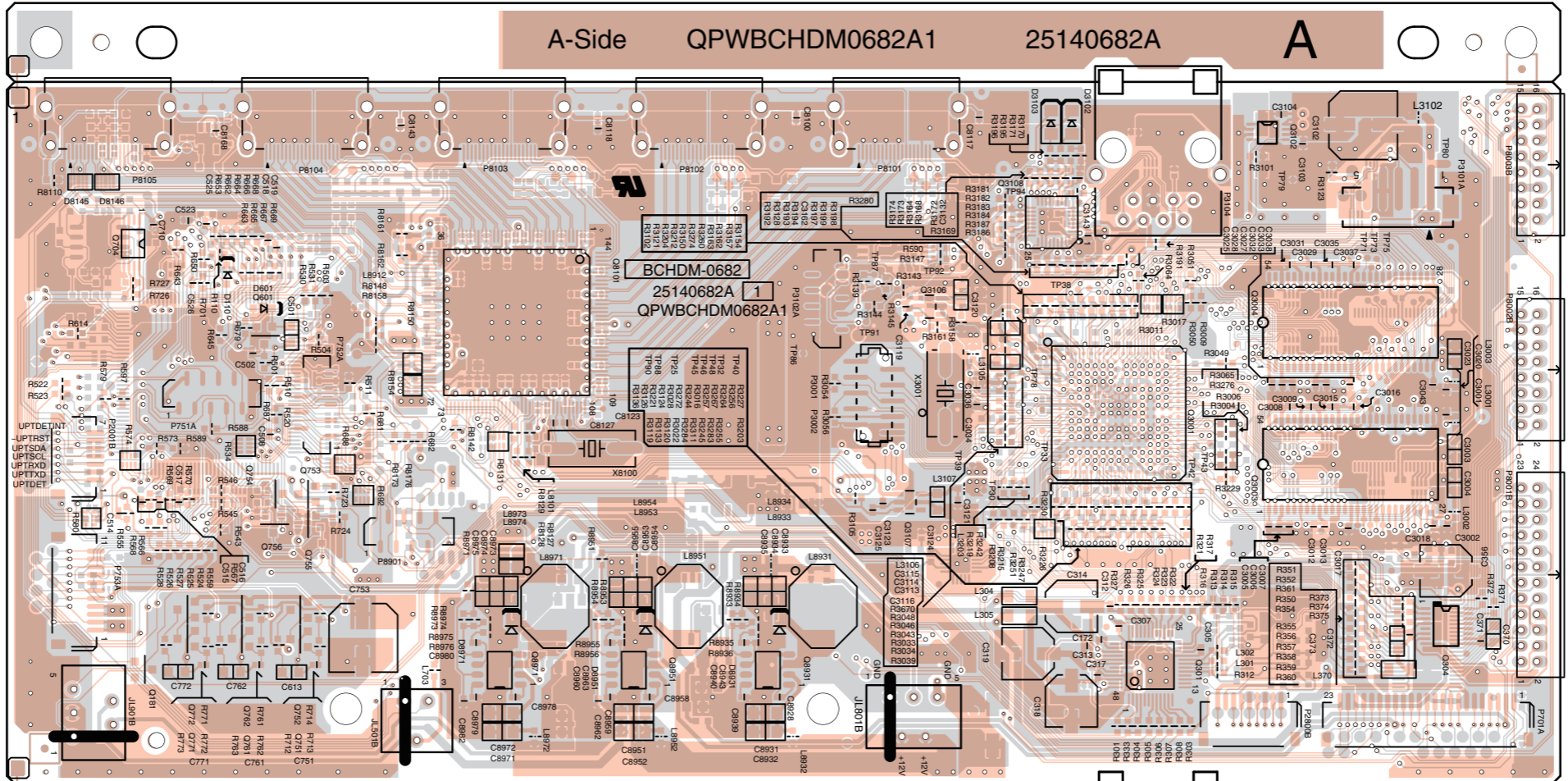

Same as above

1

2

3

4

5

A B C D E F G H

PRINTED CIRCUIT BOARD VIEWS-3B

U003

HDMI CIRCUIT PC BOARD
BAHDM-0682
(U0030 x 2)

B-side view

A-side pattern
B-side pattern

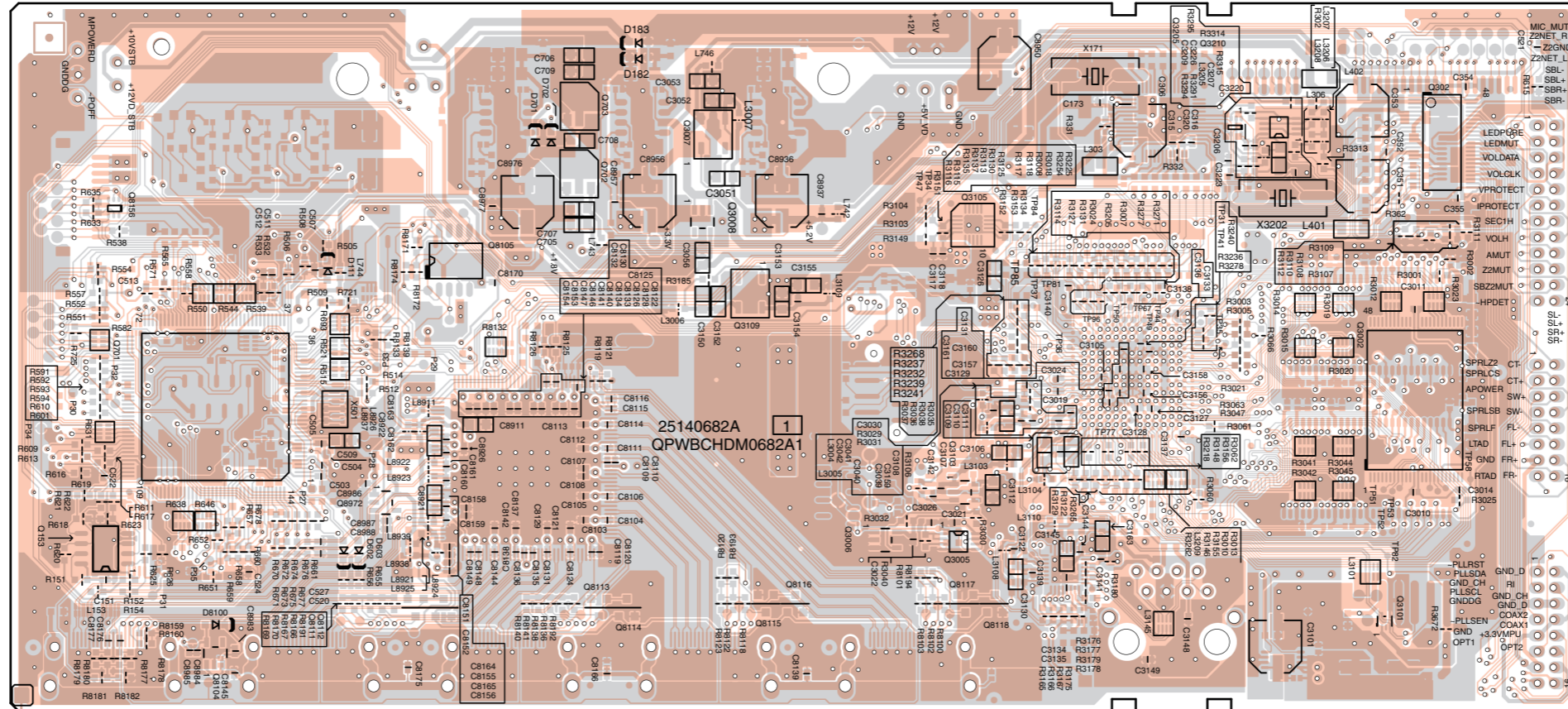

Same as above

QPWBCHDM0682A1

25140682A

B-side

A B C D E F G H

PRINTED CIRCUIT BOARD VIEWS-4

U004 DIGITAL INPUT TERMINAL
CIRCUIT PC BOARD
BADG-0639
A-side view

1
2
3
4
5

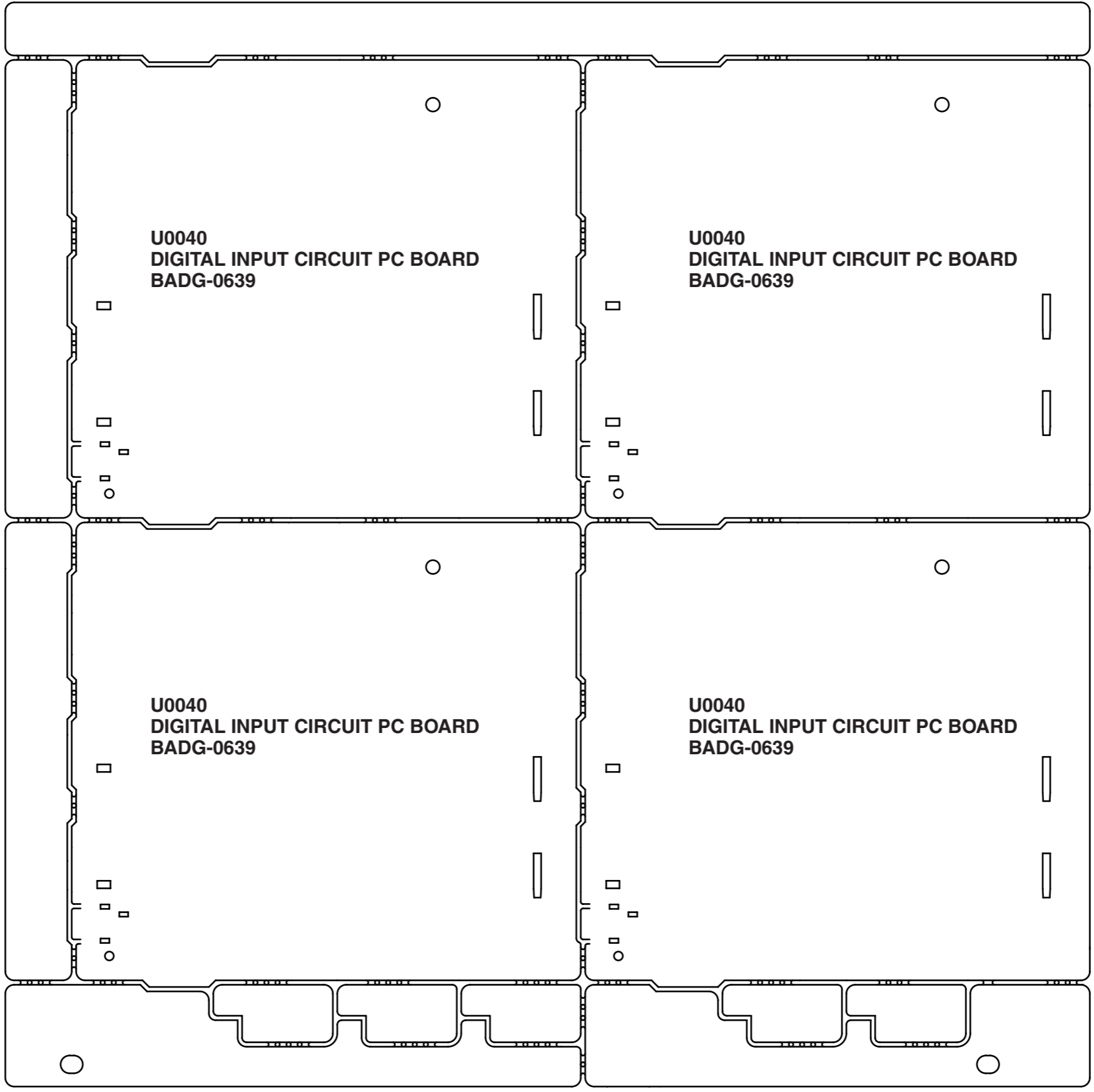

A B C D E F G H

PRINTED CIRCUIT BOARD VIEWS-4A

U004 DIGITAL INPUT TERMINAL
CIRCUIT PC BOARD
BADG-0639
A-side view

1

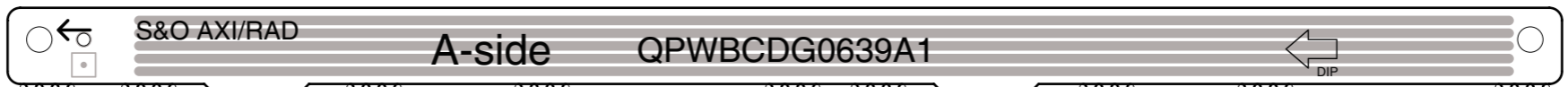

2

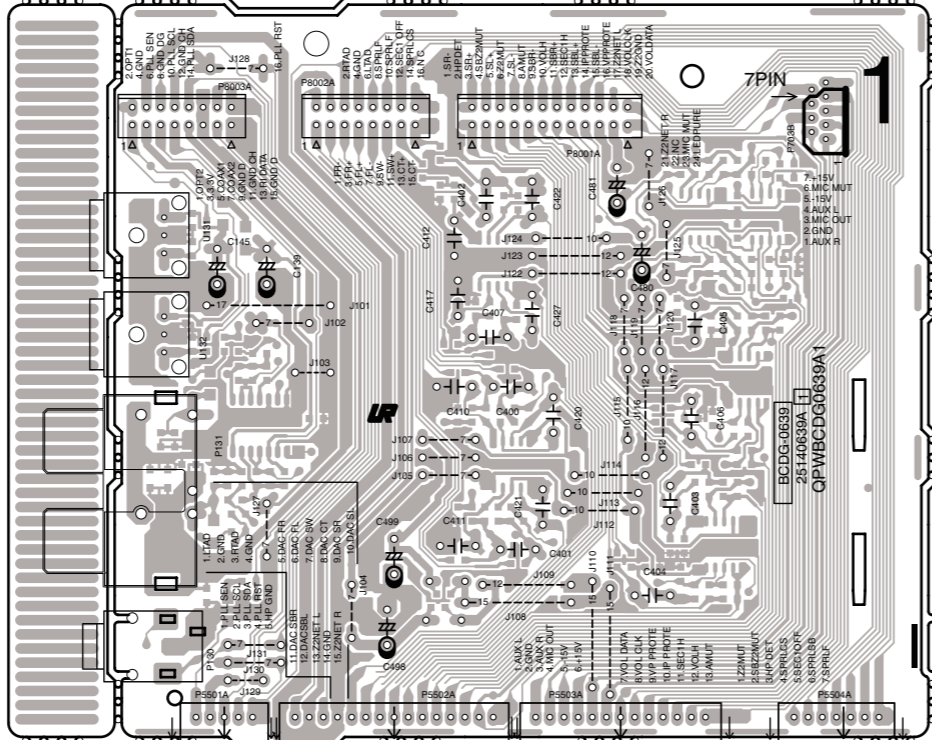

Same as "1"

2

3

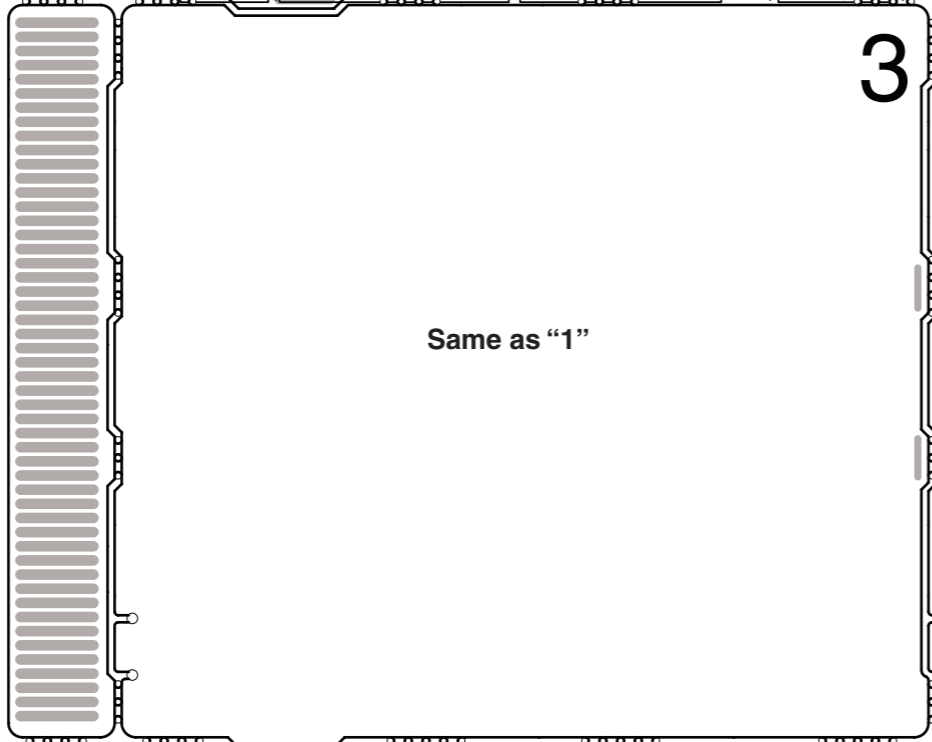

Same as "1"

4

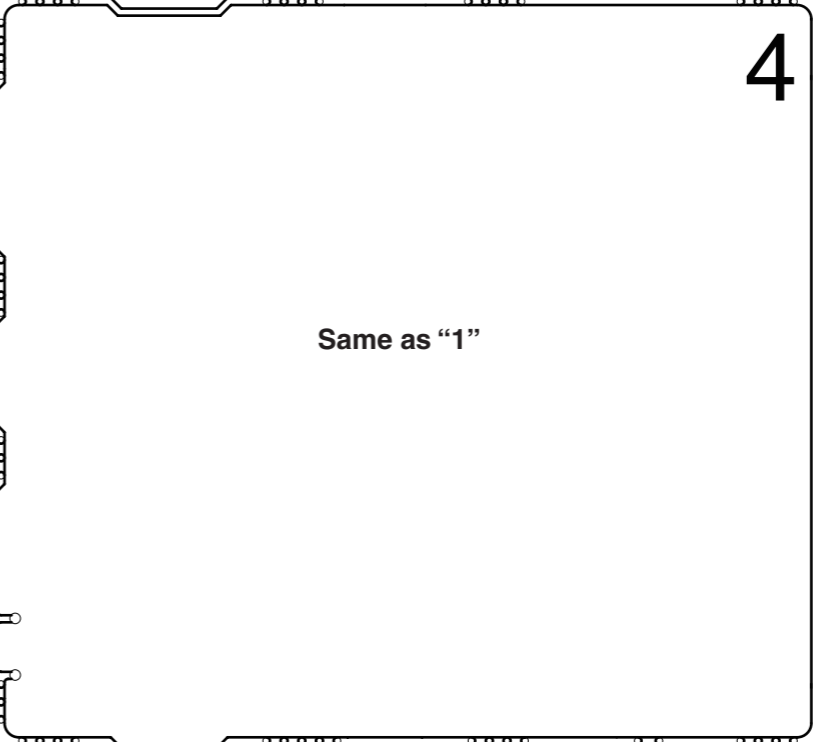

Same as "1"

5

A B C D E F G H

PRINTED CIRCUIT BOARD VIEWS-4B

U004 DIGITAL INPUT TERMINAL
CIRCUIT PC BOARD
BADG-0639
B-side view

1

2

3

4

5

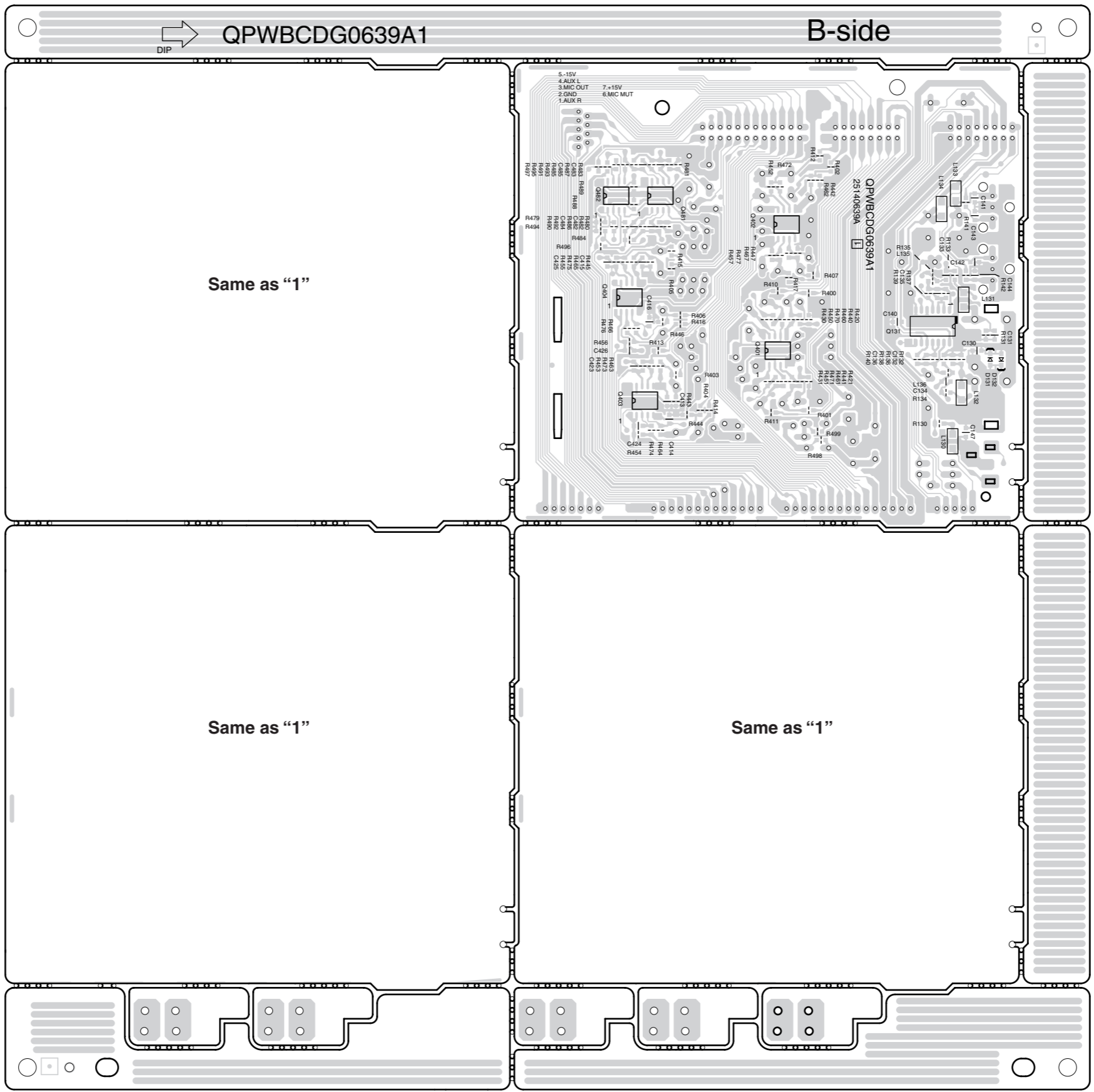

TX-NR509**<Note>**

Parts marked by "NSP" are generally unavailable because they are not in our Master Spare Parts List.

NOTE : THE COMPONENTS IDENTIFIED BY THE MARK ! ARE CRITICAL FOR RISK OF FIRE AND ELECTRIC SHOCK. REPLACE ONLY WITH PART NUMBER SPECIFIED.

<Notes>

(B) : Black model

(S) : Silver model

<MDC> : 120V,Canadian model

<MDD> : 120V,USA model

<MDF> : 120V,Taiwanese model

<MMK> : 220-240V, Korean model

<MMQ> : 220-240V,Hong kong model

<MMR> : 220-240V,Chinese model

<MPA> : 230V,Australian model

<MPB> : 230V,UK model

<MPP> : 230V,CE(European) country model

EXPLODED VIEW PARTS LIST

REF. NO.	PART NAME	DESCRIPTION	Q'TY	PART NO. (SN)	REMARKS
[CHASSIS SCREW]					
A001	CHASSIS	TX-SR507	1	27100533D	
A003	LEG	(B)	4	27175464	
A005	CUSHION	(ZUL)	4	28141877	
A007	SCREW	3TTB+8B(3BC)	4	838430088GR	
A009	HOLDER	KGLS-8RT	3	27190503A	
A010	HOLDER	KGPS-8RF	1	27191044	
A011	HOLDER	KGLS-10RT	1	27190428A	
A013	HOLDER	KGPS-14RF	2	27190802	
A015	HOLDER	KGPS-14RF	1	27190802	
A017	HOLDER	KGLS-16S	1	27190607	
A019	HOLDER	KGPS-16RF	1	27190991	
A021	HOLDER	KGLS-22S	2	27190369	
A025	SCREW	4TTC+8C(3BC)SR	4	801658	
A030	HEAT SINK	509	1	27160656	
A032	RETAINER	(HL)	1	27142159	

A034	RETAINER	(HR)	1	27142223A	
A036	SCREW	3TTB+8B(3BC)	4	838430088GR	
A038	SCREW	3TTB+8B(3BC)	2	838430088GR	
A040	SCREW	3TTB+8B(3BC)	3	838430088GR	
A041	CLIP	CS-1U	1	27255004	
A042	SCREW	3TTB+8B(3BC)	2	838430088GR	
A043	SCREW	3TTB+8B(3CM)SR	1	801637	
A050	SCREW	3SMS8WSW+18B3CM	4	801636	
A054	SCREW	3TTB+8B(3BC)	2	838430088GR	
A056	BUSHING	S-RELIEF #2271	1	27300750	! <MDC, MDD, MMK, MMQ, MMR, MPA, MPB, MPP>
A058	LABEL	(PT)	1	29363379-1	
A060	WIRE TIE	BSK-1	2	260208	
A069	SCREW	3TTB+8B(3BC)	1	838430088GR	
A071	LABEL	(SP)509	1	29391417	<MDC, MDD, MDF, MMK, MMQ, MMR, MPA, MPB, MPP>
A080	IB CUSHION	W15*3t TAPE	1	28141585	
A081	CUSHION	(BUTYL)	1	28141748	
A090	CUSHION	(BUTYL)	1	28141748	
A101	REAR PANEL	509DD	1	27124239B	N <MDC, MDD>
A101	REAR PANEL	509PP	1	27124240C	N <MPB, MPP, MPA>
A101	REAR PANEL	509MR	1	27124241B	N <MMR>
A101	REAR PANEL	509MQ	1	27124242B	N <MMK, MMQ>
A101	REAR PANEL	TXNR509DF	1	27124296B	N <MDF>
A102	CUSHION	---	2	28141799	
A103	SCREW	3P+6FN(3BC)	5	82143006GR	<MPP, MDC, MDD, MDF, MMK, MMQ, MMR, MPA, MPB>
A105	SCREW	3TTB+8B(3BC)	24	838430088GR	<MPP, MDC, MDD, MDF, MMK, MMQ, MMR, MPA, MPB>
A109	SCREW	3P+6FN(3BC)	2	82143006GR	<MPP, MDC, MDD, MDF, MMK, MMQ, MMR, MPA, MPB>
A110	SCREW	3TTF+10B(3BC)	2	835430108GR	<MDF>
A111	TAPE	TAPE(CLOTH-16U)	1	29110083	<MDF>
[CABINET]					
A201	F PANEL	TX-NR509(B)DD	1	27213431C	N <B MDC, MDD, MDF>
A201	F PANEL	TX-NR509(B)PP	1	27213432C	N <B MPP, MMK, MMQ, MMR, MPA, MPB>
A201	F PANEL	TX-NR509(S)PP	1	27213433C	N <S MPP>
A202	CLEAR PLT	TX-NR509 MDC	1	28192338B	<B MDC, MDD, MDF>
A202	CLEAR PLT	TX-NR509 MPP	1	28192339B	<B MPP, MMK, MMQ, MMR, MPA, MPB>

A202	CLEAR PLT	TX-NR509(S)MPP	1	28192345B	N <S MPP>
A207	BADGE	---	1	28135317	
A211	KNOB	(TONE)(B)	1	28326918	
A211	KNOB	(TONE)(S)	1	28326919	<S>
A212	FACET	---	2	28200054	
A213	KNOB	(INP)(B)	1	28326916A	
A213	KNOB	(INP)(S)	1	28326917A	<S>
A214	KNOB	(INP-L)(B)	1	28326920B	
A214	KNOB	(INP-L)(S)	1	28326921B	N <S>
A215	KNOB	(INP-R)(B)	1	28326936B	
A215	KNOB	(INP-R)(S)	1	28326937B	N <S>
A216	KNOB	(SEL)	1	28326906A	
A217	KNOB	(STBY)(B)	1	28326904	
A217	KNOB	(STBY)(S)	1	28326905	<S>
A219	KNOB	(CUR)	1	28326907B	
A221	IB CUSHION	W15*3t TAPE	1	28141585	
A225	SCREW	2.6TTB+8B(3BC)	22	838426088GR	
A242	WIRE TIE	BSK-1	1	260208	
A254	WIRE TIE	BSK-1	7	260208	
A255	SCREW	3TTB+8B(3BC)	3	838430088GR	
A256	SCREW	3TTB+8B(3BC)	1	838430088GR	
A260	SCREW	3TTB+8B(3BC)	4	838430088GR	
A261	TAPE	TAPE(CLOTH-16U)	1	29110083	
A262	TAPE	TAPE(CLOTH-16U)	1	29110083	
A264	TAPE	TAPE(CLOTH-16U)	1	29110083	
A268	CUSHION	---	1	28141681	
A270	CUSHION	(FELT)t1x20x10	4	28141859	
A271	TAPE	TAPE(CLOTH-16U)	1	29110083	
A273	HOLDER	KGLS-4S	2	27190009	
A321	KNOB	(VOL)AS(B)	1	28326914	
A321	KNOB	(VOL)AS(S)	1	28326915	<S>
A340	COVER	(B) (Bent)	1	28210087A	
A340	COVER	(B) (Not Bent)	1	28210087AZ	
A340	COVER	(S) (Bent)	1	28210088A	<S>

A342	SCREW	3TTB+8B(3CM)SR	9	801637	<S>
A342	SCREW	3TTB+8B(3BC)	9	838430088GR	
A350	PLATE	(COVER)B	1	27262881	<B MMQ>
A354	HOLDER	(PLATE)	6	27191337	<B MMQ>
A360	LABEL	(COVER)	1	29390767	
A362	LABEL	HOOKUP-ONKYO	1	29363194	<MDC, MDD>
[TRANS COIL]					
T901	P TRANS	NPT-1604D	1	2302012	! <MDC, MDD, MDF>
T901	P TRANS	NPT-1604P	1	2302013	! <MPB, MPP, MPA>
T901	P TRANS	NPT-1604M	1	2302014	! <MMK, MMQ, MMR>
[SW TRM]					
F6901	FUSE	10A-UL/T-233	1	252330GR	!
F6901 or	FUSE	10A-T/UL-ST2	(1)	252333GR	!
F6902	FUSE	10A-UL/T-233	1	252330GR	!
F6902 or	FUSE	10A-T/UL-ST2	(1)	252333GR	!
F901	FUSE	8A-UL/T-233	1	252329GR	! <MDC, MDD, MDF>
F901 or	FUSE	8A-T/UL-ST2	(1)	252261GR	! <MDC, MDD, MDF>
F901	FUSE	4A-SE-EAK	1	252077GR	! <MPP, MMK, MMQ, MMR, MPA, MPB>
F901 or	FUSE	4A-SE-TL250V	(1)	252277GR	! <MPP, MMK, MMQ, MMR, MPA, MPB>
F901E	LABEL	LABEL	1	29360842	! <MDC, MDD, MDF>
F901E	LABEL	T4AL250V	1	29361732A	! <MPP, MMK, MMQ, MMR, MPA, MPB>
P101	FFC	NCFC7-091512	1	2047091512	
P2001	FFC	NCFC5-072012	1	2045072012	
P2800	FFC	NCFC5-091012	1	2045091012	
P3101	SOCKET AS	NSAS-10P1924	1	2009991224UL	
P6601A	P RIVET	JB-407A-C	10	880052	<MPP, MMK, MMQ, MMR, MPA, MPB>
P701	FFC	NCFC5-232212	1	2045232212	
P703	FFC	NCFC5-072512	1	2045072512	
P901	AC CORD	AS-UC-2	1	253368AYUN	! <MDC, MDD>
P901 or	AC CORD	AS-UC-2	(1)	253368BLTK	! <MDC, MDD>
P901	AC CORD	AS-CEE-2	1	253306VOL	! <MPP, MMK>
P901 or	AC CORD	AS-CEE-2	(1)	253374YUN	! <MPP, MMK>
P901	AC CORD	AS-CCC	1	253355VOL	! <MMR>
P901 or	AC CORD	AS-CCC	(1)	253377LTK	! <MMR>

P901	AC CORD	AS-SAA	1	253388LTK	!	<MPA>
P901	AC CORD	AS-BS	1	253198LTK	!	<MMQ>
P901	AC CORD	AS-BS	1	253198LTK	!	<MPB>
P901 or	AC CORD	AS-BS	(1)	253198VOL	!	<MPB>
P901B	FASTON AS	FASTON SOCKET	1	1F999026A	!	<MDF>
P907	AC INLET	R301X2PSn	1	25053358	!	<MDF>
[TUNER UNIT]						
U001	U0010 ~ U0017	BAAF-0621-1C *	1	1B258521-1C	N	<MDC, MDD, MDF>
U0010	Power Amp/ Audio Input Terminals Circuit PC board ass'y	BAAF-0621-1C	1	1B2585621-1C	N	<MDC, MDD, MDF>
U0011	Speaker Terminals Circuit PC board ass'y	BAETC-0622-1C	1	1B2585622-1C	N	<MDC, MDD, MDF>
U0012	Thermal Senser Circuit PC board ass'y	BAETC-0623-1C	1	1B2585623-1C	N	<MDC, MDD, MDF>
U0013	Spacer PC board	BAETC-0624-1C	1	1B2585624-1C	N	<MDC, MDD, MDF>
U0014	Secondary Wiring Circuit PC board ass'y	BAETC-0625-1C	1	1B2585625-1C	N	<MDC, MDD, MDF>
U0015	FFC Fixture PC board	BAETC-0626-1C	1	1B2585626-1C	N	<MDC, MDD, MDF>
U0016	Power supply Circuit PC board ass'y	BAETC-0627-1C	1	1B2585627-1C	N	<MDC, MDD, MDF>
U0017	Part Fixture PC board	BAETC-0764-1C	1	1B2585764-1C	N	<MDC, MDD, MDF>
U001	U0010 ~ U0017	BAAF-0621-1D *	1	1B258521-1D	N	<MPP, MPA, MPB>
U0010	Power Amp/ Audio Input Terminals Circuit PC board ass'y	BAAF-0621-1D	1	1B2585621-1D	N	<MPP, MPA, MPB>
U0011	Speaker Terminals Circuit PC board ass'y	BAETC-0622-1D	1	1B2585622-1D	N	<MPP, MPA, MPB>
U0012	Thermal Senser Circuit PC board ass'y	BAETC-0623-1D	1	1B2585623-1D	N	<MPP, MPA, MPB>
U0013	Spacer PC board	BAETC-0624-1D	1	1B2585624-1D	N	<MPP, MPA, MPB>
U0014	Secondary Wiring Circuit PC board ass'y	BAETC-0625-1D	1	1B2585625-1D	N	<MPP, MPA, MPB>
U0015	FFC Fixture PC board	BAETC-0626-1D	1	1B2585626-1D	N	<MPP, MPA, MPB>
U0016	Power supply Circuit PC board ass'y	BAETC-0627-1D	1	1B2585627-1D	N	<MPP, MPA, MPB>
U0017	Part Fixture PC board	BAETC-0764-1D	1	1B2585764-1D	N	<MPP, MPA, MPB>
U001	U0010 ~ U0017	BAAF-0621-1E *	1	1B258521-1E	N	<MMK, MMQ, MMR>
U0010	Power Amp/ Audio Input Terminals Circuit PC board ass'y	BAAF-0621-1E	1	1B2585621-1E	N	<MMK, MMQ, MMR>
U0011	Speaker Terminals Circuit PC board ass'y	BAETC-0622-1E	1	1B2585622-1E	N	<MMK, MMQ, MMR>
U0012	Thermal Senser Circuit PC board ass'y	BAETC-0623-1E	1	1B2585623-1E	N	<MMK, MMQ, MMR>
U0013	Spacer PC board	BAETC-0624-1E	1	1B2585624-1E	N	<MMK, MMQ, MMR>
U0014	Secondary Wiring Circuit PC board ass'y	BAETC-0625-1E	1	1B2585625-1E	N	<MMK, MMQ, MMR>
U0015	FFC Fixture PC board	BAETC-0626-1E	1	1B2585626-1E	N	<MMK, MMQ, MMR>
U0016	Power supply Circuit PC board ass'y	BAETC-0627-1E	1	1B2585627-1E	N	<MMK, MMQ, MMR>
U0017	Part Fixture PC board	BAETC-0764-1E	1	1B2585764-1E	N	<MMK, MMQ, MMR>

U002	U0020 ~ U0024	BADIS-0663-1A *	1	1B258563-1A	N <MDC, MDD, MDF>
U0020	Display Circuit PC board ass'y	BADIS-0663-1A	1	1B2585663-1A	N <MDC, MDD, MDF>
U0021	Video Input Terminals Circuit PC board ass'y	BAVD-0664-1A	1	1B2585664-1A	N <MDC, MDD, MDF>
U0022	Standby etc. Switch Circuit PC board ass'y	BAETC-0665-1A	1	1B2585665-1A	N <MDC, MDD, MDF>
U0023	Headphones Circuit PC board ass'y	BAETC-0666-1A	1	1B2585666-1A	N <MDC, MDD, MDF>
U0024	Power supply Circuit PC board ass'y	BAETC-0667-1A	1	1B2585667-1A	N <MDC, MDD, MDF>
U002	U0020 ~ U0024	BADIS-0663-1B *	1	1B258563-1B	N <MPP, MMK, MMQ, MMR, MPA, MPB>
U0020	Display Circuit PC board ass'y	BADIS-0663-1B	1	1B2585663-1B	N <MPP, MMK, MMQ, MMR, MPA, MPB>
U0021	Video Input Terminals Circuit PC board ass'y	BAVD-0664-1B	1	1B2585664-1B	N <MPP, MMK, MMQ, MMR, MPA, MPB>
U0022	Standby etc. Switch Circuit PC board ass'y	BAETC-0665-1B	1	1B2585665-1B	N <MPP, MMK, MMQ, MMR, MPA, MPB>
U0023	Headphones Circuit PC board ass'y	BAETC-0666-1B	1	1B2585666-1B	N <MPP, MMK, MMQ, MMR, MPA, MPB>
U0024	Power supply Circuit PC board ass'y	BAETC-0667-1B	1	1B2585667-1B	N <MPP, MMK, MMQ, MMR, MPA, MPB>
U003	U0030 x 2 pcs.	BAHDM-0682-1A *	1	1B258582-1A	N <MDC, MDD, MDF>
U0030	HDMI Circuit PC board ass'y	BAHDM-0682-1A	1	1B2585682-1A	N <MDC, MDD, MDF>
U003	U0030 x 2 pcs.	BAHDM-0682-1B *	1	1B258582-1B	N <MPP, MMK, MMQ, MMR, MPA, MPB>
U0030	HDMI Circuit PC board ass'y	BAHDM-0682-1B	1	1B2585682-1B	N <MPP, MMK, MMQ, MMR, MPA, MPB>
U004	U0040 x 4 pcs.	BADG-0639-1B *	1	1B258539-1B	N
U0040	Digital Input Terminals Circuit PC board ass'y	BADG-0639-1B	1	1B2585639-1B	N
U010	TUNER UNIT	KST-MW004MS1-S89S	1	240171	<MDC, MDD, MDF>
U010	TUNER UNIT	KST-MW104MS1-S89	1	240172	<MPP, MMK, MMQ, MMR, MPA, MPB>

TX-NR509**PACKING PROCEDURES PARTS LIST****<Notes>**

(B) : Black model

(S) : Silver model

<MDC> : 120V,Canadian model

<MDD> : 120V,USA model

<MDF> : 120V,Taiwanese model

<MMK> : 220-240V, Korean model

<MMQ> : 220-240V,Hong kong model

<MMR> : 220-240V,Chinese model

<MPA> : 230V,Australian model

<MPB> : 230V,UK model
 <MPP> : 230V,CE(European) country model
 <6405MPP> : For System **HT-S6405**, 230V,CE(European) country model
 <690MPP> : For System **AVX-690**, 230V,CE(European) country model
 <690MPB> : For System **AVX-690**, 230V,UK model

REF. NO.	PART NAME	DESCRIPTION	Q'TY	PART NO. (SN)	REMARKS
[PACKING]					
A601	PAD AS	(AS)509 L & R	1	29092576A	<MDC, MDD, MDF, MMK, MMQ, MMR, MPA, MPB, MPP>
A601A	PAD	(L)509	1	29092577A	<MDC, MDD, MDF, MMK, MMQ, MMR, MPA, MPB, MPP>
A601B	PAD	(R)509	1	29092578A	<MDC, MDD, MDF, MMK, MMQ, MMR, MPA, MPB, MPP>
A601	PAD AS	(AS)HTR690 L & R	1	29092594A	<690MPB, 690MPP, 6405MPP>
A601A	PAD	(L)HTR690	1	29092595A	<690MPB, 690MPP, 6405MPP>
A601B	PAD	(R)HTR690	1	29092596A	<690MPB, 690MPP, 6405MPP>
A605	POLY BAG	w850 x d650	1	29100245	
A606	TAPE	(SEROHAN)NITTO NO.29	1	29110149	
A608	SHEET	---	1	29095906	<690MPB, 690MPP, 6405MPP, MDC, MDD, MDF, MMK, MMR, MPA, MPB, MPP>
A608	SHEET	T0.5 x 600 x 500	1	29096097	<MMQ>
A610	SHEET	(PAD)	1	29096095	<MPP>
A611	TAPE	(SEROHAN)NITTO NO.29	1	29110149	
A701	CARTON	509DD	1	29055202	N <B MDC, MDD, MDF>
A701	CARTON	509	1	29055203A	N <B MMK, MMQ, MMR, MPA, MPB, MPP, S MPP>
A704A	UPC LABEL	509BMDD	1	29391462	N <B MDD>
A704A	UPC LABEL	509BMDC	1	29391463	N <B MDC>
A704A	EAN LABEL	509BMPB	1	29391466	N <B MPB>
A704A	EAN LABEL	509BMDF	1	29391467	N <B MDF>
A704A	EAN LABEL	509BMMR	1	29391468	N <B MMR>
A704A	EAN LABEL	509BMPA	1	29391470	N <B MPA>
A704A	LABEL	(DES)NR509CBMPP	1	29391523	N <B 6405MPP>
A704A	LABEL	(DES)509C2BMPP	1	29391710	N <B 690MPP>
A704A	LABEL	(DES)509C2BMPB	1	29391711	N <B 690MPB>
A704A	EAN LABEL	509BMPP	1	29391464B	N <B MPP>
A704A	EAN LABEL	509SMPP	1	29391465B	N <S MPP>
A704A	EAN LABEL	509BMMK	1	29391469A	N <B MMK>

A704A	EAN LABEL	509BMMQ	1	29391471A	N <B MMQ>
A707	LABEL	(CHINA)	1	29390952A	<MMR>
A755	LABEL	(CCC)	1	29364396	<MMR>
A760	PP TAPE	W50 SBT-70	1	29110200	<MDC, MDD, MDF, MMK, MMQ, MMR, MPA, MPB, MPP>
[ACCESSARY]					
A672	POLY BAG	w250 x d350	1	29100250A	<690MPB, 690MPP, 6405MPP, MMK, MMQ, MPA, MPB, MPP>
A673	POLY BAG	---	1	29100225A	<690MPB, 690MPP, 6405MPP>
A674	POLY BAG	D250 x d300 x W300(t0.04)	1	29100256A	
A675	POLY BAG	w250 x d350	1	29100250A	<690MPP, 6405MPP>
A676	TAPE	(SEROHAN)NITTO NO.29	1	29110149	
A677	TAPE	(SEROHAN)NITTO NO.29	1	29110149	<690MPP, 6405MPP>
A678	SHEET	(PAD)	1	29096131	<690MPB, 690MPP, 6405MPP>
A679	TAPE	(SEROHAN)NITTO NO.29	1	29110149	<690MPB, 690MPP, 6405MPP>
A680	PP TAPE	W50 SBT-70	1	29110200	<690MPB, 690MPP, 6405MPP>
A801	INS MANUAL	En(TXNR509)	1	29400571A	N <690MPB, 690MPP, 6405MPP, MDD, MDF, MMK, MMQ, MPA, MPB>
A802	INS MANUAL	FrEs(TXNR509)	1	29400574A	N <690MPP, 6405MPP>
A803	INS MANUAL	DaFiNo(HTR548)	1	29400677A	N <690MPP>
A805	INS MANUAL	ItDe(TXNR509)	1	29400578A	N <690MPP, 6405MPP>
A806	INS MANUAL	NISv(TXNR509)	1	29400579A	N <690MPP, 6405MPP>
A806	INS MANUAL	Cs(TXNR509)	1	29400582A	N <MMR>
A807	INS MANUAL	Ct(TXNR509)	1	29400581A	N <MMQ>
A809	INS MANUAL	Ar(TXNR509)	1	29400580	N <MMQ>
A810	INS MANUAL	Ar(QC ImportantSheet)	1	29344373B	<MMQ>
A811	INS MANUAL	En-QSS(TXNR509)	1	29400573	N <MDD, MDF, MMK, MMQ, MPA, MPB>
A811	INS MANUAL	En-QSS(HTS6405)	1	29400615	N <6405MPP>
A811	INS MANUAL	En-QSS(AVX690)	1	29400676	N <690MPB, 690MPP>
A812	INS MANUAL	Cs-QSS(TXNR509)	1	29400583	N <MMR>
A815	INS MANUAL	JaEn(SW_License_509-5009)	1	29400575	N <690MPB, 690MPP, 6405MPP, MDC, MDD, MDF, MMK, MMQ, MMR, MPA, MPB, MPP>
A826	INST SHEET	U11(2010_RIHD)	1	29355782A	<690MPB, 690MPP, 6405MPP, MDC, MDD, MDF, MMK, MMQ, MMR, MPA, MPB, MPP>
A827	INS MANUAL	EnFrEs(InternetRadio_ONK)	1	29400576	N <MDC, MDD>
A828	INS MANUAL	EnDe(Last.fm_Napster)	1	29400577	N <690MPB, 690MPP, 6405MPP, MPB, MPP>
A830	INST SHEET	WEEE	1	29355793A	<690MPB, 690MPP, 6405MPP, MPB, MPP>
A833	INST SHEET	CHINA ROHS	1	29355616B	<MMR>
A835	HANDBILL	(UP-A1)US	1	29380155A	<MDC, MDD>

A835	HANDBILL	(UP-A1)EU	1	29380156A	<690MPB, 690MPP, 6405MPP, MPB, MPP>
A840	INS MANUAL	U9(2011_Prepro)	1	29400572A	N <690MPB, 690MPP, 6405MPP, MDC, MDD, MDF, MMK, MMQ, MMR, MPA, MPB, MPP>
A841	INS MANUAL	U1En(SKS-HT648)	1	29400781	N <6405MPP>
A842	INS MANUAL	U8(HTP-770)	1	29400119A	<6405MPP>
A841	INS MANUAL	U8(HTP-770)	1	29400119A	<690MPB, 690MPP>
A842	INS MANUAL	U2EnDe(HTP-644)	1	29400833	N <690MPB, 690MPP>
A843	INST SHEET	(TX-SR309_HP)	1	29355831	
A855	REMO CON	RC-801M	1	24140801	N
A856	MIC	MIC-7000	1	245044	
A858	ANT COIL	NMA-3057	1	232140	
A859	FM ANT AS	Type W	1	292191	
A860	LABEL	(SPCABLE)2009	1	29390881	<MDC, MDD, MDF, MMK, MMQ, MMR, MPA, MPB, MPP>
A861	BATTERY	R6/AA(UM-3)	2	3010194	<690MPB, 690MPP, 6405MPP, MDC, MDD, MDF, MMK, MMQ, MPA, MPB, MPP>
A861 or	BATTERY	R6/AA(UM-3)	(2)	3010054	<690MPB, 690MPP, 6405MPP, MDC, MDD, MDF, MMK, MMQ, MPA, MPB, MPP>
A883	WRNTY CARD	(ONKYO-CH)	1	29365098C	<MMR>
A884	WRNTY CARD	MGQ	1	29365099B	<MMQ>
A885	WRNTY CARD	(ONKYO)	1	29365135	<MDC, MDD>
A888	LABEL	(APV)	1	29390190	<MMR>
A890	INS MANDSK	U7(TX-NR609)	1	29500003	N <MDC, MPP>
A891	INS MANUAL	QSG_En(TX-NR509/609)	1	29400938	N <MDC, MPP>
A892	INS MANUAL	QSG_Fr(TX-NR509/609)	1	29400939	N <MDC, MPP>
A893	INS MANUAL	QSG_Es(TX-NR509/609)	1	29400940	N <MDC, MPP>
A894	INS MANUAL	SAFETY_U3	1	29400883	<MDC>
A894	INS MANUAL	QSG_It(TX-NR509/609)	1	29400941	N <MPP>
A895	INS MANUAL	QSG_De(TX-NR509/609)	1	29400942	N <MPP>
A896	INS MANUAL	QSG_Ni(TX-NR509/609)	1	29400943	N <MPP>
A897	INS MANUAL	QSG_Sv(TX-NR509/609)	1	29400944	N <MPP>
A898	INS MANUAL	QSG_Fi(TX-NR509/609)	1	29400945	N <MPP>
A899	INS MANUAL	SAFETY_U10	1	29400884	<MPP>

TX-NR509

PC BOARD PARTS LIST

U001 U0010 ~ U0017

BAAF-0621-1C/D/E

1 1B258521-1C/D/E

U0010	Power Amp/ Audio Input Terminals PC board ass'y	BAAF-0621-1C/D/E	1	1B2585621-1C/D/E
U0011	Speaker Terminals Circuit PC board ass'y	BAETC-0622-1C/D/E	1	1B2585622-1C/D/E
U0012	Thermal Senser Circuit PC board ass'y	BAETC-0623-1C/D/E	1	1B2585623-1C/D/E
U0013	Spacer PC board	BAETC-0624-1C/D/E	1	1B2585624-1C/D/E
U0014	Secondary Wiring Circuit PC board ass'y	BAETC-0625-1C/D/E	1	1B2585625-1C/D/E
U0015	FFC Fixture PC board	BAETC-0626-1C/D/E	1	1B2585626-1C/D/E
U0016	Power supply Circuit PC board ass'y	BAETC-0627-1C/D/E	1	1B2585627-1C/D/E
U0017	Part Fixture PC board	BAETC-0764-1C/D/E	1	1B2585764-1C/D/E

CIRCUIT NO.	PART NAME	DESCRIPTION	Q'TY	PART NO. (SN)	REMARKS
[SEMI CONDUCTOR]					
D4107	C-DIODE	DA2J10100	1	223303R2	
D4107 or	C-DIODE	1SS352	(1)	223234R2	
D4107 or	C-DIODE	1SS355	(1)	223269R2	
D4107 or	C-DIODE	MA2J111	(1)	223279R2	
D4107 or	C-DIODE	KDS4148U	(1)	223283R2	
D4117	C-DIODE	DA2J10100	1	223303R2	
D4117 or	C-DIODE	1SS352	(1)	223234R2	
D4117 or	C-DIODE	1SS355	(1)	223269R2	
D4117 or	C-DIODE	MA2J111	(1)	223279R2	
D4117 or	C-DIODE	KDS4148U	(1)	223283R2	
D4171	ZENER D	MTZJ6.8B	1	224470682T	
D4172	ZENER D	MTZJ6.8B	1	224470682T	
D4208	C-DIODE	DA2J10100	1	223303R2	
D4208 or	C-DIODE	1SS352	(1)	223234R2	
D4208 or	C-DIODE	1SS355	(1)	223269R2	
D4208 or	C-DIODE	MA2J111	(1)	223279R2	
D4208 or	C-DIODE	KDS4148U	(1)	223283R2	
D4218	C-DIODE	DA2J10100	1	223303R2	
D4218 or	C-DIODE	1SS352	(1)	223234R2	
D4218 or	C-DIODE	1SS355	(1)	223269R2	
D4218 or	C-DIODE	MA2J111	(1)	223279R2	
D4218 or	C-DIODE	KDS4148U	(1)	223283R2	
D4300	DIODE	RL1N4003	1	22380260T	

D4300 or	DIODE	GP104003E	(1)	22380035T
D4301	DIODE	RL1N4003	1	22380260T
D4301 or	DIODE	GP104003E	(1)	22380035T
D4302	DIODE	RL1N4003	1	22380260T
D4302 or	DIODE	GP104003E	(1)	22380035T
D4303	DIODE	RL1N4003	1	22380260T
D4303 or	DIODE	GP104003E	(1)	22380035T
D4304	DIODE	RL1N4003	1	22380260T
D4304 or	DIODE	GP104003E	(1)	22380035T
D4305	DIODE	RL1N4003	1	22380260T
D4305 or	DIODE	GP104003E	(1)	22380035T
D4400	ZENER D	DZ2J056M0L	1	224760560R2
D4400 or	ZENER D	UDZS5.6B	(1)	224550560R2
D6020	C-DIODE	DA2J10100	1	223303R2
D6020 or	C-DIODE	1SS352	(1)	223234R2
D6020 or	C-DIODE	1SS355	(1)	223269R2
D6020 or	C-DIODE	MA2J111	(1)	223279R2
D6020 or	C-DIODE	KDS4148U	(1)	223283R2
D6021	C-DIODE	DA2J10100	1	223303R2
D6021 or	C-DIODE	1SS352	(1)	223234R2
D6021 or	C-DIODE	1SS355	(1)	223269R2
D6021 or	C-DIODE	MA2J111	(1)	223279R2
D6021 or	C-DIODE	KDS4148U	(1)	223283R2
D6022	C-DIODE	DA2J10100	1	223303R2
D6022 or	C-DIODE	1SS352	(1)	223234R2
D6022 or	C-DIODE	1SS355	(1)	223269R2
D6022 or	C-DIODE	MA2J111	(1)	223279R2
D6022 or	C-DIODE	KDS4148U	(1)	223283R2
D6023	C-DIODE	DA2J10100	1	223303R2
D6023 or	C-DIODE	1SS352	(1)	223234R2
D6023 or	C-DIODE	1SS355	(1)	223269R2
D6023 or	C-DIODE	MA2J111	(1)	223279R2
D6023 or	C-DIODE	KDS4148U	(1)	223283R2
D6024	C-DIODE	DA2J10100	1	223303R2

D6024 or	C-DIODE	ISS352	(1)	223234R2	
D6024 or	C-DIODE	ISS355	(1)	223269R2	
D6024 or	C-DIODE	MA2J111	(1)	223279R2	
D6024 or	C-DIODE	KDS4148U	(1)	223283R2	
D6031	DIODE	ISS133	1	223163T	
D6032	DIODE	ISS133	1	223163T	
D6600	C-DIODE	DA2J10100	1	223303R2	
D6600 or	C-DIODE	ISS352	(1)	223234R2	
D6600 or	C-DIODE	ISS355	(1)	223269R2	
D6600 or	C-DIODE	MA2J111	(1)	223279R2	
D6600 or	C-DIODE	KDS4148U	(1)	223283R2	
D6603	C-DIODE	DA2J10100	1	223303R2	
D6603 or	C-DIODE	ISS352	(1)	223234R2	
D6603 or	C-DIODE	ISS355	(1)	223269R2	
D6603 or	C-DIODE	MA2J111	(1)	223279R2	
D6603 or	C-DIODE	KDS4148U	(1)	223283R2	
D6704	ZENER D	DZ2J033M0L	1	224760330R2	N
D6704 or	ZENER D	UDZS3.3B	(1)	224550330R2	
D6714	C-DIODE	DA2J10100	1	223303R2	
D6714 or	C-DIODE	ISS352	(1)	223234R2	
D6714 or	C-DIODE	ISS355	(1)	223269R2	
D6714 or	C-DIODE	MA2J111	(1)	223279R2	
D6714 or	C-DIODE	KDS4148U	(1)	223283R2	
D6715	C-DIODE	DA2J10100	1	223303R2	
D6715 or	C-DIODE	ISS352	(1)	223234R2	
D6715 or	C-DIODE	ISS355	(1)	223269R2	
D6715 or	C-DIODE	MA2J111	(1)	223279R2	
D6715 or	C-DIODE	KDS4148U	(1)	223283R2	
D6901	DIODE	D10XB60H	1	22380337	
D6901A	HEAT SINK	RAD-196	1	27160545	
D6901D	SCREW	3P+10FN(3BC)	1	82143010GR	
D6902	C-DIODE	DA2J10100	1	223303R2	
D6902 or	C-DIODE	ISS352	(1)	223234R2	
D6902 or	C-DIODE	ISS355	(1)	223269R2	

D6902 or	C-DIODE	MA2J111	(1)	223279R2	
D6902 or	C-DIODE	KDS4148U	(1)	223283R2	
D6903	C-DIODE	DA2J10100	1	223303R2	
D6903 or	C-DIODE	1SS352	(1)	223234R2	
D6903 or	C-DIODE	1SS355	(1)	223269R2	
D6903 or	C-DIODE	MA2J111	(1)	223279R2	
D6903 or	C-DIODE	KDS4148U	(1)	223283R2	
D960	DIODE	RL1N4003	1	22380260T	
D961	DIODE	RL1N4003	1	22380260T	
D962	ZENER D	DZ2J220M0L	1	224762200R2	N
D962 or	ZENER D	UDZS22B	(1)	224552200R2	
D963	ZENER D	DZ2J220M0L	1	224762200R2	N
D963 or	ZENER D	UDZS22B	(1)	224552200R2	
Q4001	IC	R2A15218FP	1	22242605R3	
Q4003	IC	NJM4580M-D	1	22241448R2	
Q4100	TR	RN1441	1	2215410R2	
Q4101	TR	RN1441	1	2215410R2	
Q4102	TR	RN1441	1	2215410R2	
Q4103	TR	RN1441	1	2215410R2	
Q4104	TR	RN1441	1	2215410R2	
Q4105	TR	RN1441	1	2215410R2	
Q4106	TR	RN1441	1	2215410R2	
Q4107	TR	RN1441	1	2215410R2	
Q4108	TR	RN1441	1	2215410R2	
Q4109	TR	RN1441	1	2215410R2	
Q4115	TR	RN1441	1	2215410R2	
Q4116	TR	RN1441	1	2215410R2	
Q4117	TR	RN1441	1	2215410R2	
Q4130	IC	NJM4580M-D	1	22241448R2	
Q4170	IC	78M15HF(NJM78M15FA)	1	222780155JRC	
Q4170 or	IC	UPC78M15AHF-AZ	(1)	222780155NEC	
Q4170A	HEAT SINK	RAD-196	1	27160545	
Q4170B	SCREW	3P+10FN(3BC)	1	82143010GR	
Q4171	IC	79M15HF(NJM79M15FA)	1	222790155JRC	

Q4171 or	IC	UPC79M15HF-AZ	(1)	222790155NEC	
Q4171B	SCREW	3P+10FN(3BC)	1	82143010GR	
Q4400	IC	NJM4580M-D	1	22241448R2	
Q4401	TR	2SC2235-Y(TPE6_F)	1	2211654T	
[NOTICE]					
Q6001, Q6002 and the surrounding parts have been changed as follows in the middle of production. Refer to SCHEMATIC-DIAGRAM-4(AMP. SECTION)					
Change C6120, C6121 and C6122 at the same time when Q6001 is changed.					
Q6001	IC	STK-443-530-E	1	222148	BEFORE
		↓		↓	
	IC	STK-443-530N-E	1	222152	AFTER
C6120	C-CERA C	CC725CH1H-101J1	0	342101014R1	BEFORE
			↓		
	C-CERA C	CC725CH1H-101J1	1	342101014R1	AFTER
C6121	C-CERA C	CC725CH1H-101J1	0	342101014R1	BEFORE
			↓		
	C-CERA C	CC725CH1H-101J1	1	342101014R1	AFTER
C6122	C-CERA C	CC725CH1H-101J1	0	342101014R1	BEFORE
			↓		
	C-CERA C	CC725CH1H-101J1	1	342101014R1	AFTER
Change C6123, C6124 and C6127 at the same time when Q6002 is changed.					
Q6002	IC	STK-442-730-E	1	222150	N BEFORE
		↓		↓	
	IC	STK-442-730N-E	1	222153	AFTER
C6123	C-CERA C	CC725CH1H-561J1	0	342105614R1	BEFORE
			↓		
	C-CERA C	CC725CH1H-561J1	1	342105614R1	AFTER
C6124	C-CERA C	CC725CH1H-561J1	0	342105614R1	BEFORE
			↓		
	C-CERA C	CC725CH1H-561J1	1	342105614R1	AFTER
Q6010	TR	2SC2240-BL(TPE2_F)	1	2211406T	
Q6011	TR	2SC2240-BL(TPE2_F)	1	2211406T	
Q6012	TR	2SC2240-BL(TPE2_F)	1	2211406T	
Q6013	TR	2SC2240-BL(TPE2_F)	1	2211406T	
Q6014	TR	2SC2240-BL(TPE2_F)	1	2211406T	

Q6021	TR	2SA1163-BL(TE85L_F)	1	2216756R2
Q6022	TR	2SC2240-BL(TPE2_F)	1	2211406T
Q6023	TR	2SC2240-BL(TPE2_F)	1	2211406T
Q6024	TR	2SA1163-BL(TE85L_F)	1	2216756R2
Q6380	IC	LM61CIZ	1	22242212
Q6380A	RETAINER	(PTH)	1	27141884-1
Q6601	TR	KRC105S	1	2217290R2
Q6601 or	TR	DTC123JKA	(1)	2216690R2
Q6602	TR	KRC105S	1	2217290R2
Q6602 or	TR	DTC123JKA	(1)	2216690R2
Q6707	TR	KTC3875-GR	1	2216175R2
Q6707 or	TR	2SC2712-GR	(1)	2213145R2
Q6708	TR	KTC3875-GR	1	2216175R2
Q6708 or	TR	2SC2712-GR	(1)	2213145R2
Q960	TR	2SC2235-Y(TPE6_F)	1	2211654T
Q960 or	TR	2SC2235-O(TPE6_F)	(1)	2211653T
[TRANS COIL]				
L6000	S COIL	SC-0.8X6.0X29.5T-4RV-C	1	231394AS
L6001	S COIL	SC-0.8X6.0X29.5T-4RV-C	1	231394AS
L6002	S COIL	SC-0.8X6.0X29.5T-4RV-C	1	231394AS
L6003	S COIL	SC-0.8X6.0X29.5T-4RV-C	1	231394AS
L6004	S COIL	SC-0.8X6.0X29.5T-4RV-C	1	231394AS
[CAPACITOR]				
C4001	C-CERA C	CC725CH1H-152J1	1	342101524R1
C4002	C-CERA C	CC725CH1H-152J1	1	342101524R1
C4003	UPZ C	2AUPZTF221JE	1	376332214T
C4004	UPZ C	2AUPZTF221JE	1	376332214T
C4009	C-CERA C	CC725CH1H-221J1	1	342102214R1
C4010	C-CERA C	CC725CH1H-221J1	1	342102214R1
C4013	C-CERA C	CC725CH1H-221J1	1	342102214R1
C4014	C-CERA C	CC725CH1H-221J1	1	342102214R1
C4017	C-CERA C	CC725CH1H-221J1	1	342102214R1
C4018	C-CERA C	CC725CH1H-221J1	1	342102214R1
C4019	UPZ C	2AUPZTF221JE	1	376332214T

C4020	UPZ C	2AUPZTF221JE	1	376332214T
C4027	C-CERA C	CC725CH1H-221J1	1	342102214R1
C4030	C-CERA C	CC725CH1H-221J1	1	342102214R1
C4031	C-CERA C	CC725CH1H-221J1	1	342102214R1
C4035	C-CERA C	CC725CH1H-221J1	1	342102214R1
C4036	C-CERA C	CC725CH1H-221J1	1	342102214R1
C4050	UTSP C	CE04W25V-47M(UTSP)	1	397554707T
C4051	UTSP C	CE04W25V-47M(UTSP)	1	397554707T
C4052	UTSP C	CE04W25V-47M(UTSP)	1	397554707T
C4053	UTSP C	CE04W25V-47M(UTSP)	1	397554707T
C4054	UTSP C	CE04W25V-47M(UTSP)	1	397554707T
C4055	UTSP C	CE04W25V-47M(UTSP)	1	397554707T
C4056	UTSP C	CE04W25V-47M(UTSP)	1	397554707T
C4057	UTSP C	CE04W25V-47M(UTSP)	1	397554707T
C4060	UTSP C	CE04W50V 47M(UTSP)	1	397584707T
C4061	UTSP C	CE04W50V 47M(UTSP)	1	397584707T
C4062	TF C	ECQ-V50V-474J	1	374724744T
C4063	TF C	ECQ-V50V-823J	1	374728234T
C4064	TF C	ECQ-V50V-223J	1	374722234T
C4065	TF C	ECQ-V50V-474J	1	374724744T
C4066	TF C	ECQ-V50V-823J	1	374728234T
C4067	TF C	ECQ-V50V-223J	1	374722234T
C4070	UTSP C	CE04W50V 47M(UTSP)	1	397584707T
C4071	UTSP C	CE04W50V 47M(UTSP)	1	397584707T
C4072	UTSP C	CE04W50V 47M(UTSP)	1	397584707T
C4073	UTSP C	CE04W50V 47M(UTSP)	1	397584707T
C4074	UTSP C	CE04W50V 47M(UTSP)	1	397584707T
C4075	UTSP C	CE04W50V 47M(UTSP)	1	397584707T
C4076	UTSP C	CE04W50V 47M(UTSP)	1	397584707T
C4077	UTSP C	CE04W50V 47M(UTSP)	1	397584707T
C4078	UTSP C	CE04W50V 47M(UTSP)	1	397584707T
C4079	UTSP C	CE04W50V 47M(UTSP)	1	397584707T
C4085	UTSP C	CE04W25V-47M(UTSP)	1	397554707T
C4086	UTSP C	CE04W25V-47M(UTSP)	1	397554707T

C4090	C-CERA C	CC725CH1H-101J1	1	342101014R1	
C4091	C-CERA C	CC725CH1H-101J1	1	342101014R1	
C4100	UTSP C	CE04W50V-47M(UTSP)	1	397584707T	
C4101	UTSP C	CE04W50V-47M(UTSP)	1	397584707T	
C4102	UTSP C	CE04W50V-47M(UTSP)	1	397584707T	
C4103	UTSP C	CE04W50V-47M(UTSP)	1	397584707T	
C4104	UTSP C	CE04W50V-47M(UTSP)	1	397584707T	
C4105	UTSP C	CE04W50V-47M(UTSP)	1	397584707T	
C4106	UTSP C	CE04W50V-47M(UTSP)	1	397584707T	
C4107	UTSP C	CE04W50V-47M(UTSP)	1	397584707T	
C4108	UTSP C	CE04W50V-47M(UTSP)	1	397584707T	
C4109	UTSP C	CE04W50V-47M(UTSP)	1	397584707T	
C4130	UTSP C	CE04W50V-47M(UTSP)	1	397584707T	
C4131	C-CERA C	CC725CH1H-221J1	1	342102214R1	
C4132	TF C	ECQ-V50V-103J	1	374721034T	
C4166	UTSP C	CE04W25V-220M(UTSP)	1	397552217T	
C4167	UTSP C	CE04W25V-220M(UTSP)	1	397552217T	
C4170	UTSP C	CE04W50V-10M(UTSP)	1	397581007T	
C4171	UTSP C	CE04W50V-10M(UTSP)	1	397581007T	
C4172	UTSP C	CE04W25V-220M(UTSP)	1	397552217T	
C4173	UTSP C	CE04W25V-220M(UTSP)	1	397552217T	
C4186	UTSP C	CE04W16V-470M(UTSP)	1	397544717T	
C4187	UTSP C	CE04W16V-470M(UTSP)	1	397544717T	
C4204	C-CERA C	CC725CH1H-102J1	1	342101024R1	
C4205	C-CERA C	CC725CH1H-102J1	1	342101024R1	
C4206	C-CERA C	CC725CH1H-102J1	1	342101024R1	
C4208	C-CERA C	CC725CH1H-102J1	1	342101024R1	
C4209	UTSP C	CE04W25V-47M(UTSP)	1	397554707T	
C4210	UTSP C	CE04W25V-47M(UTSP)	1	397554707T	
C4300	TF C	ECQ-V50V-334J	1	374723344T	
C4301	VR C	CE04W35V-1000M(VR)	1	394661027S	
C4301 or	JAMICON	CE04W35V-1000M	(1)	398561027S	
C4302	VR C	CE04W35V-470M(VR)	1	394664717T	
C4302 or	JAMICON	CE04W35V-470M	(1)	398564717T	N

C4402	UTSP C	CE04W25V-47M(UTSP)	1	397554707T
C4403	UTSP C	CE04W25V-47M(UTSP)	1	397554707T
C4404	UTSP C	CE04W25V-47M(UTSP)	1	397554707T
C4405	UTSP C	CE04W25V-47M(UTSP)	1	397554707T
C4406	UTSP C	CE04W25V-47M(UTSP)	1	397554707T
C4407	UTSP C	CE04W25V-47M(UTSP)	1	397554707T
C4408	C-CERA C	CK725F1E-104Z1	1	332161040R1
C4409	C-CERA C	CK725F1E-104Z1	1	332161040R1
C4410	C-CERA C	CC725CH1H-681J1	1	342106814R1
C4411	C-CERA C	CC725CH1H-681J1	1	342106814R1
C4412	C-CERA C	CK725F1A-105Z1	1	332181050R1
C4413	C-CERA C	CK725F1A-105Z1	1	332181050R1
C4414	C-CERA C	CK725F1A-105Z1	1	332181050R1
C4415	C-CERA C	CK725F1A-105Z1	1	332181050R1
C4416	C-CERA C	CC725CH1H-101J1	1	342101014R1
C4417	C-CERA C	CC725CH1H-101J1	1	342101014R1
C6009	TF C	ECQ-V50V-333J	1	374723334T
C6010	UTSP C	CE04W50V 47M(UTSP)	1	397584707T
C6011	UTSP C	CE04W50V 47M(UTSP)	1	397584707T
C6012	UTSP C	CE04W50V 47M(UTSP)	1	397584707T
C6013	UTSP C	CE04W50V 47M(UTSP)	1	397584707T
C6014	UTSP C	CE04W50V 47M(UTSP)	1	397584707T
C6020	UPZ C	2AUPZTF471JE	1	376334714T
C6021	UPZ C	2AUPZTF471JE	1	376334714T
C6022	UPZ C	2AUPZTF471JE	1	376334714T
C6023	UPZ C	2AUPZTF471JE	1	376334714T
C6024	UPZ C	2AUPZTF471JE	1	376334714T
C6030	UTSP C	CE04W25V-220M(UTSP)	1	397552217T
C6031	UTSP C	CE04W25V-220M(UTSP)	1	397552217T
C6032	UTSP C	CE04W25V-220M(UTSP)	1	397552217T
C6033	UTSP C	CE04W25V-220M(UTSP)	1	397552217T
C6034	UTSP C	CE04W25V-220M(UTSP)	1	397552217T
C6040	CERA C	CC45CH50V-030D	1	345340302T
C6041	CERA C	CC45CH50V-030D	1	345340302T

C6042	CERA C	CC45CH50V-030D	1	345340302T
C6043	CERA C	CC45CH50V-030D	1	345340302T
C6044	CERA C	CC45CH50V-030D	1	345340302T
C6050	C-CERA C	CK725B1H-472K1	1	332104725R1
C6051	C-CERA C	CK725B1H-472K1	1	332104725R1
C6052	C-CERA C	CK725B1H-472K1	1	332104725R1
C6053	C-CERA C	CK725B1H-472K1	1	332104725R1
C6054	C-CERA C	CK725B1H-472K1	1	332104725R1
C6060	TF C	ECQ-V50V-473J	1	374724734T
C6061	TF C	ECQ-V50V-473J	1	374724734T
C6062	TF C	ECQ-V50V-473J	1	374724734T
C6063	TF C	ECQ-V50V-473J	1	374724734T
C6064	TF C	ECQ-V50V-473J	1	374724734T
C6090	UTSP C	CE04W25V-100M(UTSP)	1	397551017T
C6091	UTSP C	CE04W50V-1M(UTSP)	1	397580107T
C6092	UTSP C	CE04W50V-1M(UTSP)	1	397580107T
C6093	C-CERA C	CK725F1E-104Z1	1	332161040R1
C6094	C-CERA C	CK725F1E-104Z1	1	332161040R1
C6101	UTSP C	CE04W63V-100M(UTSP)	1	397571017T
C6102	UTSP C	CE04W63V-100M(UTSP)	1	397571017T
C6103	UTSP C	CE04W50V 47M(UTSP)	1	397584707T
C6106	UTSP C	CE04W50V 47M(UTSP)	1	397584707T
C6107	UTSP C	CE04W63V-100M(UTSP)	1	397571017T
C6108	UTSP C	CE04W63V-100M(UTSP)	1	397571017T
C6118	UTSP C	CE04W63V-100M(UTSP)	1	397571017T
C6119	UTSP C	CE04W63V-100M(UTSP)	1	397571017T
C6600	C-CERA C	CC725CH1H-102J1	1	342101024R1
C6602	C-CERA C	CC725CH1H-102J1	1	342101024R1
C6603	C-CERA C	CC725CH1H-102J1	1	342101024R1
C6630	C-CERA C	CK725F1E-104Z1	1	332161040R1
C6640	MKT C	B32529C0102J289	1	376491024T
C6641	MKT C	B32529C0102J289	1	376491024T
C6642	MKT C	B32529C0102J289	1	376491024T
C6643	MKT C	B32529C0102J289	1	376491024T

C6644	MKT C	B32529C0102J289	1	376491024T
C6650	TF C	ECQ-V50V-103J	1	374721034T
C6651	TF C	ECQ-V50V-103J	1	374721034T
C6652	TF C	ECQ-V50V-103J	1	374721034T
C6653	TF C	ECQ-V50V-103J	1	374721034T
C6654	TF C	ECQ-V50V-103J	1	374721034T
C6706	UTSP C	CE04W50V-10M(UTSP)	1	397581007T
C6901	ELECT C	CE69W63V-8200MB	1	3504420
C6902	ELECT C	CE69W63V-8200MB	1	3504420
C6911	C-CERA C	CC725CH1H-102J1	1	342101024R1
C6912	TF C	ECQ-V50V-334J	1	374723344T
C6913	TF C	ECQ-V50V-334J	1	374723344T
C6917	C-CERA C	CC725CH1H-102J1	1	342101024R1
C950	TF C	ECQ-V50V-104J	1	374721044T
C960	VR C	CE04W63V-220M(VR)	1	394672217T
C960 or	JAMICON	CE04W63V-220M	(1)	398572217T
C961	UTSP C	CE04W50V 47M(UTSP)	1	397584707T
C962	TF C	ECQ-V50V-104J	1	374721044T
C963	UTSP C	CE04W50V 47M(UTSP)	1	397584707T

[RESISTOR]

R4003	C-CARBON R	RN72K1J-331JE	1	435033314R1
R4004	C-CARBON R	RN72K1J-331JE	1	435033314R1
R4009	C-CARBON R	RN72K1J-331JE	1	435033314R1
R4010	C-CARBON R	RN72K1J-331JE	1	435033314R1
R4013	C-CARBON R	RN72K1J-331JE	1	435033314R1
R4014	C-CARBON R	RN72K1J-331JE	1	435033314R1
R4015	C-CARBON R	RN72K1J-222JE	1	435032224R1
R4016	C-CARBON R	RN72K1J-222JE	1	435032224R1
R4017	C-CARBON R	RN72K1J-331JE	1	435033314R1
R4018	C-CARBON R	RN72K1J-331JE	1	435033314R1
R4019	C-CARBON R	RN72K1J-331JE	1	435033314R1
R4020	C-CARBON R	RN72K1J-331JE	1	435033314R1
R4028	C-CARBON R	RN72K1J-101JE	1	435031014R1
R4030	C-CARBON R	RN72K1J-101JE	1	435031014R1

R4031	C-CARBON R	RN72KIJ-101JE	1	435031014R1
R4035	C-CARBON R	RN72KIJ-101JE	1	435031014R1
R4036	C-CARBON R	RN72KIJ-101JE	1	435031014R1
R4043	C-CARBON R	RN72KIJ-104JE	1	435031044R1
R4044	C-CARBON R	RN72KIJ-104JE	1	435031044R1
R4049	C-CARBON R	RN72KIJ-104JE	1	435031044R1
R4050	C-CARBON R	RN72KIJ-104JE	1	435031044R1
R4053	C-CARBON R	RN72KIJ-104JE	1	435031044R1
R4054	C-CARBON R	RN72KIJ-104JE	1	435031044R1
R4055	C-CARBON R	RN72KIJ-224JE	1	435032244R1
R4056	C-CARBON R	RN72KIJ-224JE	1	435032244R1
R4057	C-CARBON R	RN72KIJ-104JE	1	435031044R1
R4058	C-CARBON R	RN72KIJ-104JE	1	435031044R1
R4059	C-CARBON R	RN72KIJ-104JE	1	435031044R1
R4060	C-CARBON R	RN72KIJ-104JE	1	435031044R1
R4069	C-CARBON R	RN72KIJ-104JE	1	435031044R1
R4070	C-CARBON R	RN72KIJ-222JE	1	435032224R1
R4071	C-CARBON R	RN72KIJ-222JE	1	435032224R1
R4075	C-CARBON R	RN72KIJ-224JE	1	435032244R1
R4076	C-CARBON R	RN72KIJ-224JE	1	435032244R1
R4077	C-CARBON R	RN72KIJ-223JE	1	435032234R1
R4078	C-CARBON R	RN72KIJ-473JE	1	435034734R1
R4079	C-CARBON R	RN72KIJ-473JE	1	435034734R1
R4080	C-CARBON R	RN72KIJ-104JE	1	435031044R1
R4081	C-CARBON R	RN72KIJ-104JE	1	435031044R1
R4082	C-CARBON R	RN72KIJ-104JE	1	435031044R1
R4083	C-CARBON R	RN72KIJ-000JE	1	435030004R1
R4084	C-CARBON R	RN72KIJ-000JE	1	435030004R1
R4085	C-CARBON R	RN72KIJ-182JE	1	435031824R1
R4086	C-CARBON R	RN72KIJ-182JE	1	435031824R1
R4087	C-CARBON R	RN72KIJ-222JE	1	435032224R1
R4088	C-CARBON R	RN72KIJ-222JE	1	435032224R1
R4089	C-CARBON R	RN72KIJ-000JE	1	435030004R1
R4090	C-CARBON R	RN72KIJ-123JE	1	435031234R1

R4091	C-CARBON R	RN72KIJ-223JE	1	435032234R1
R4092	C-CARBON R	RN72KIJ-331JE	1	435033314R1
R4093	C-CARBON R	RN72KIJ-332JE	1	435033324R1
R4094	C-CARBON R	RN72KIJ-103JE	1	435031034R1
R4095	C-CARBON R	RN72KIJ-103JE	1	435031034R1
R4096	C-CARBON R	RN72KIJ-331JE	1	435033314R1
R4097	C-CARBON R	RN72KIJ-332JE	1	435033324R1
R4098	C-CARBON R	RN72KIJ-123JE	1	435031234R1
R4099	C-CARBON R	RN72KIJ-223JE	1	435032234R1
R4100	C-CARBON R	RN72KIJ-224JE	1	435032244R1
R4101	C-CARBON R	RN72KIJ-224JE	1	435032244R1
R4102	C-CARBON R	RN72KIJ-224JE	1	435032244R1
R4103	C-CARBON R	RN72KIJ-224JE	1	435032244R1
R4104	C-CARBON R	RN72KIJ-224JE	1	435032244R1
R4105	C-CARBON R	RN72KIJ-224JE	1	435032244R1
R4106	C-CARBON R	RN72KIJ-224JE	1	435032244R1
R4107	C-CARBON R	RN72KIJ-224JE	1	435032244R1
R4108	C-CARBON R	RN72KIJ-224JE	1	435032244R1
R4109	C-CARBON R	RN72KIJ-224JE	1	435032244R1
R4110	C-CARBON R	RN72KIJ-222JE	1	435032224R1
R4111	C-CARBON R	RN72KIJ-222JE	1	435032224R1
R4112	C-CARBON R	RN72KIJ-222JE	1	435032224R1
R4113	C-CARBON R	RN72KIJ-222JE	1	435032224R1
R4114	C-CARBON R	RN72KIJ-222JE	1	435032224R1
R4115	C-CARBON R	RN72KIJ-271JE	1	435032714R1
R4116	C-CARBON R	RN72KIJ-271JE	1	435032714R1
R4117	C-CARBON R	RN72KIJ-271JE	1	435032714R1
R4118	C-CARBON R	RN72KIJ-222JE	1	435032224R1
R4119	C-CARBON R	RN72KIJ-222JE	1	435032224R1
R4125	C-CARBON R	RN72KIJ-101JE	1	435031014R1
R4126	C-CARBON R	RN72KIJ-101JE	1	435031014R1
R4127	C-CARBON R	RN72KIJ-101JE	1	435031014R1
R4130	C-CARBON R	RN72KIJ-221JE	1	435032214R1
R4131	C-CARBON R	RN72KIJ-473JE	1	435034734R1

R4132	C-CARBON R	RN72K1J-153JE	1	435031534R1	
R4133	C-CARBON R	RN72K1J-122JE	1	435031224R1	
R4134	C-CARBON R	RN72K1J-103JE	1	435031034R1	
R4135	C-CARBON R	RN72K1J-104JE	1	435031044R1	
R4136	C-CARBON R	RN72K1J-104JE	1	435031044R1	
R4137	C-CARBON R	RN72K1J-000JE	1	435030004R1	
R4160	METAL R	RNU1WCJ-0.22	1	453632294T	
R4161	METAL R	RNU1WCJ-0.22	1	453632294T	
R4166	C-CARBON R	RN72K1J-220JE	1	435032204R1	
R4167	C-CARBON R	RN72K1J-220JE	1	435032204R1	
R4174	METAL O R	RS1WBJ-68	1	443626804T	
R4175	METAL O R	RS1WBJ-68	1	443626804T	
R4176	METAL O R	RS1WBJ-47	1	443624704T	
R4177	METAL O R	RS1WBJ-47	1	443624704T	
R4180	C-CARBON R	RN72K1J-224JE	1	435032244R1	
R4181	C-CARBON R	RN72K1J-224JE	1	435032244R1	
R4182	C-CARBON R	RN72K1J-224JE	1	435032244R1	
R4185	METAL O R	RS1WBJ-10	1	443621004T	<MDC, MDD, MDF, , MPA, MPB, MPP>
R4185	METAL R	RNU1WCJ-1	1	453630104T	<MMK, MMQ, MMR>
R4186	METAL O R	RS1WBJ-10	1	443621004T	<MDC, MDD, MDF, MPA, MPB, MPP>
R4186	METAL R	RNU1WCJ-1	1	453630104T	<MMK, MMQ, MMR>
R4187	METAL O R	RS1WBJ-22	1	443622204T	<MDC, MDD, MDF, MPA, MPB, MPP>
R4187	METAL R	RNU1WCJ-8.2	1	453630824T	<MMK, MMQ, MMR>
R4188	METAL O R	RS1WBJ-22	1	443622204T	<MDC, MDD, MDF, MPA, MPB, MPP>
R4188	METAL R	RNU1WCJ-8.2	1	453630824T	<MMK, MMQ, MMR>
R4189	C-CARBON R	RN72K1J-224JE	1	435032244R1	
R4190	C-CARBON R	RN72K1J-224JE	1	435032244R1	
R4192	C-CARBON R	RN72K1J-224JE	1	435032244R1	
R4193	C-CARBON R	RN72K1J-224JE	1	435032244R1	
R4194	C-CARBON R	RN72K1J-224JE	1	435032244R1	
R4195	C-CARBON R	RN72K1J-224JE	1	435032244R1	
R4196	C-CARBON R	RN72K1J-224JE	1	435032244R1	
R4211	C-CARBON R	RN72K1J-000JE	1	435030004R1	
R4213	C-CARBON R	RN72K1J-000JE	1	435030004R1	

R4214	C-CARBON R	RN72K1J-000JE	1	435030004R1
R4400	C-CARBON R	RN72K1J-223JE	1	435032234R1
R4401	C-CARBON R	RN72K1J-223JE	1	435032234R1
R4402	C-CARBON R	RN72K1J-333JE	1	435033334R1
R4403	C-CARBON R	RN72K1J-333JE	1	435033334R1
R4404	C-CARBON R	RN72K1J-223JE	1	435032234R1
R4405	C-CARBON R	RN72K1J-223JE	1	435032234R1
R4406	C-CARBON R	RN72K1J-273JE	1	435032734R1
R4407	C-CARBON R	RN72K1J-273JE	1	435032734R1
R4408	C-CARBON R	RN72K1J-331JE	1	435033314R1
R4409	C-CARBON R	RN72K1J-331JE	1	435033314R1
R4410	C-CARBON R	RN72K1J-104JE	1	435031044R1
R4411	C-CARBON R	RN72K1J-104JE	1	435031044R1
R4412	C-CARBON R	RN72K1J-220JE	1	435032204R1
R4413	C-CARBON R	RN72K1J-220JE	1	435032204R1
R4414	METAL O R	RS1WBJ-100	1	443621014T
R4415	C-CARBON R	RN72K1J-681JE	1	435036814R1
R4416	C-CARBON R	RN72K1J-681JE	1	435036814R1
R4417	C-CARBON R	RN72K1J-333JE	1	435033334R1
R6010	C-CARBON R	RN72K1J-102JE	1	435031024R1
R6011	C-CARBON R	RN72K1J-102JE	1	435031024R1
R6012	C-CARBON R	RN72K1J-102JE	1	435031024R1
R6013	C-CARBON R	RN72K1J-102JE	1	435031024R1
R6014	C-CARBON R	RN72K1J-102JE	1	435031024R1
R6020	CARBON R	R16J-56K	1	417345634T
R6021	CARBON R	R16J-56K	1	417345634T
R6022	CARBON R	R16J-56K	1	417345634T
R6023	CARBON R	R16J-56K	1	417345634T
R6024	CARBON R	R16J-56K	1	417345634T
R6030	CARBON R	R16J-2.2K	1	417342224T
R6031	CARBON R	R16J-2.2K	1	417342224T
R6032	CARBON R	R16J-2.2K	1	417342224T
R6033	CARBON R	R16J-2.2K	1	417342224T
R6034	CARBON R	R16J-2.2K	1	417342224T

R6040	CARBON R	R16J-120K	1	417341244T
R6041	CARBON R	R16J-120K	1	417341244T
R6042	CARBON R	R16J-120K	1	417341244T
R6043	CARBON R	R16J-120K	1	417341244T
R6044	CARBON R	R16J-120K	1	417341244T
R6050	CARBON R	R16J-120K	1	417341244T
R6051	CARBON R	R16J-120K	1	417341244T
R6052	CARBON R	R16J-120K	1	417341244T
R6053	CARBON R	R16J-120K	1	417341244T
R6054	CARBON R	R16J-120K	1	417341244T
R6060	METAL PR	MPR2W+2W OR22	1	4000234
R6060 or	METAL P R	RF-2EGPJR22	(1)	4000243
R6061	METAL PR	MPR2W+2W OR22	1	4000234
R6061 or	METAL P R	RF-2EGPJR22	(1)	4000243
R6062	METAL PR	MPR2W+2W OR22	1	4000234
R6062 or	METAL P R	RF-2EGPJR22	(1)	4000243
R6063	METAL PR	MPR2W+2W OR22	1	4000234
R6063 or	METAL P R	RF-2EGPJR22	(1)	4000243
R6064	METAL PR	MPR2W+2W OR22	1	4000234
R6064 or	METAL P R	RF-2EGPJR22	(1)	4000243
R6070	C-CARBON R	RN72KIJ-563JE	1	435035634R1
R6071	C-CARBON R	RN72KIJ-563JE	1	435035634R1
R6072	C-CARBON R	RN72KIJ-563JE	1	435035634R1
R6073	C-CARBON R	RN72KIJ-563JE	1	435035634R1
R6074	C-CARBON R	RN72KIJ-563JE	1	435035634R1
R6080	C-CARBON R	RN72KIJ-123JE	1	435031234R1
R6081	C-CARBON R	RN72KIJ-123JE	1	435031234R1
R6082	C-CARBON R	RN72KIJ-123JE	1	435031234R1
R6083	C-CARBON R	RN72KIJ-123JE	1	435031234R1
R6084	C-CARBON R	RN72KIJ-123JE	1	435031234R1
R6100	C-CARBON R	RN72KIJ-333JE	1	435033334R1
R6101	C-CARBON R	RN72KIJ-333JE	1	435033334R1
R6102	C-CARBON R	RN72KIJ-333JE	1	435033334R1
R6103	C-CARBON R	RN72KIJ-333JE	1	435033334R1

R6104	C-CARBON R	RN72KIJ-333JE	1	435033334R1
R6110	C-CARBON R	RN72KIJ-473JE	1	435034734R1
R6111	C-CARBON R	RN72KIJ-473JE	1	435034734R1
R6112	C-CARBON R	RN72KIJ-473JE	1	435034734R1
R6113	C-CARBON R	RN72KIJ-473JE	1	435034734R1
R6114	C-CARBON R	RN72KIJ-473JE	1	435034734R1
R6120	C-CARBON R	RN72KIJ-473JE	1	435034734R1
R6121	C-CARBON R	RN72KIJ-473JE	1	435034734R1
R6122	C-CARBON R	RN72KIJ-473JE	1	435034734R1
R6123	C-CARBON R	RN72KIJ-473JE	1	435034734R1
R6124	C-CARBON R	RN72KIJ-473JE	1	435034734R1
R6130	CARBON R	R16J-4.7	1	417340474T
R6131	CARBON R	R16J-4.7	1	417340474T
R6132	CARBON R	R16J-4.7	1	417340474T
R6133	CARBON R	R16J-4.7	1	417340474T
R6134	CARBON R	R16J-4.7	1	417340474T
R6140	METAL R	RNU1WCJ-8.2	1	453630824T
R6141	METAL R	RNU1WCJ-8.2	1	453630824T
R6142	METAL R	RNU1WCJ-8.2	1	453630824T
R6143	METAL R	RNU1WCJ-8.2	1	453630824T
R6144	METAL R	RNU1WCJ-8.2	1	453630824T
R6201	CARBON R	R16J-33K	1	417343334T
R6202	METAL O R	RS1/2WBJ-56K	1	443525634T
R6203	METAL O R	RS1WBJ-100	1	443621014T
R6204	METAL O R	RS1WBJ-100	1	443621014T
R6209	METAL O R	RS1WBJ-100	1	443621014T
R6210	METAL O R	RS1WBJ-100	1	443621014T
R6211	C-CARBON R	RN72KIJ-333JE	1	435033334R1
R6213	C-CARBON R	RN72KIJ-103JE	1	435031034R1
R6214	C-CARBON R	RN72KIJ-473JE	1	435034734R1
R6216	C-CARBON R	RN72KIJ-223JE	1	435032234R1
R6217	C-CARBON R	RN72KIJ-473JE	1	435034734R1
R6218	C-CARBON R	RN72KIJ-103JE	1	435031034R1
R6219	C-CARBON R	RN72KIJ-223JE	1	435032234R1

R6251	METAL O R	RS1/2WBJ-390	1	443523914T	
R6252	METAL O R	RS1/2WBJ-390	1	443523914T	
R6690	METAL O R	RS1/2WBJ-10	1	443521004T	
R6709	C-CARBON R	RN72KIJ-562JE	1	435035624R1	
R6710	C-CARBON R	RN72KIJ-562JE	1	435035624R1	
R6902	C-CARBON R	RN72KIJ-102JE	1	435031024R1	
R6903	C-CARBON R	RN72KIJ-473JE	1	435034734R1	
R6904	C-CARBON R	RN72KIJ-102JE	1	435031024R1	
R6905	C-CARBON R	RN72KIJ-473JE	1	435034734R1	
R6912	METAL R	RNU1/2WCJ-0.1	1	453531094T	
R950	CARBON R	R16J-1	1	417340104T	
R951	METAL O R	RS1/2WBJ-10	1	443521004T	
R952	METAL O R	RS1/2WBJ-15	1	443521504T	
R960	METAL R	RNU1WCJ-8.2	1	453630824T	
R962	C-CARBON R	RN72KIJ-272JE	1	435032724R1	
R963	C-CARBON R	RN72KIJ-272JE	1	435032724R1	
R964	C-CARBON R	RN72KIJ-333JE	1	435033334R1	
R965	CARBON R	R16J-3.3	1	417340334T	
[SW TRM]					
E6001	RETAINER	MET37-0002	1	27142009T	
F6901A	FUSE HOL	NSCT-1P2031	1	25052133T	!
F6901B	FUSE HOL	NSCT-1P2031	1	25052133T	!
F6902A	FUSE HOL	NSCT-1P2031	1	25052133T	!
F6902B	FUSE HOL	NSCT-1P2031	1	25052133T	!
JL501A	WIRE HOL	NSCT-3P874	1	25051087	
JL502A	WIRE HOL	NSCT-5P876	1	25051089	
JL503A	WIRE HOL	NSCT-9P880	1	25051093	
JL600A	WIRE HOL	NSCT-7P898	1	25051111	
JL600B	WIRE HOL	NSCT-7P898	1	25051111	
JL603A	WIRE HOL	NSCT-9P900	1	25051113	
JL603B	WIRE HOL	NSCT-9P900	1	25051113	
JL604A	WIRE HOL	NSCT-7P898	1	25051111	
JL604B	SOCKET	NSCT-3P95	1	25050267	
JL605B	SOCKET	NSCT-5P97	1	25050269	

JL951A	WIRE HOL	NSCT-5P896	1	25051109
JL951B	WIRE HOL	NSCT-5P896	1	25051109
JL952A	WIRE HOL	NSCT-3P894	1	25051107
JL953B	WIRE TRAP	NPLG-5P588	1	25055626
JL954A	WIRE HOL	NSCT-5P896	1	25051109
JL954B	SOCKET	NSCT-5P97	1	25050269
P101B	SOCKET	NSCT-9P2102	1	25052205
P4002	PIN JACK	NPJ-4PDWR690	1	25045922
P4004	PIN JACK	NPJ-4PDWWR624	1	25045845
P4005	PIN JACK	NPJ-4PDWWR624	1	25045845
P4007	PIN JACK	NPJ-4PDWRNT684	1	25045916
P4010	PIN JACK	NPJ-1PDP555	1	25045773
P5501B	PLUG	NPLG-5P0960	1	25056010
P5502B	PLUG	NPLG-15P0970	1	25056020
P5503B	PLUG	NPLG-13P0968	1	25056018
P5504B	PLUG	NPLG-7P0962	1	25056012
P5509A	TRM	NTM-1P233(M1969)	1	25060302
P5509B	TRM	NTM-1P232(M1700)	1	25060301
P6102	HOLDER	(CRAMP) UA-0 V0	1	27190608-1
P6601	TRM	NTM-2PDMCR400	1	25060472
P6602	TRM	NTM-4PDMNRR420	1	25060492
P6603	TRM	NTM-4PDMNRR420	1	25060492
P6900	CRIMP AS	CRIMP AS	1	20799165UL
P6901	CRIMP AS	CRIMP AS	1	2069925202UL
P6902	CRIMP AS	CRIMP AS	1	2069925189UL
P6903	CRIMP AS	CRIMP AS	1	20799163UL
P6904	CRIMP AS	CRIMP AS	1	20799164UL
P6906	WS CLAMP	CB-71683(L=50)	1	260261
P6908	WS CLAMP	CB-71683(L=50)	1	260261
P6909	WS CLAMP	CB-71683(L=50)	1	260261
P6911A	RETAINER	(BUS-D)TX-SR606	1	27142100
RL660	RELAY	NRL-2P5A-DC24-129	1	25065563A
RL660 or	RELAY	NRL-2P8A-DC24-144	(1)	25065590
RL660 or	RELAY	NRL-2P5A-DC24-193	(1)	25065703

RL662	RELAY	NRL-2P5A-DC24-129	1	25065563A
RL662 or	RELAY	NRL-2P8A-DC24-144	(1)	25065590
RL662 or	RELAY	NRL-2P5A-DC24-193	(1)	25065703
RL663	RELAY	NRL-2P5A-DC24-129	1	25065563A
RL663 or	RELAY	NRL-2P5A-DC24-193	(1)	25065703
RL691	RELAY	NRL-1P10A-DC12-196	1	25065707
RL691 or	RELAY	NRL-1P10A-DC12-197	(1)	25065708
RL691 or	RELAY	NRL-1P10A-DC12-198	(1)	25065709
RL692	RELAY	NRL-1P10A-DC12-196	1	25065707
RL692 or	RELAY	NRL-1P10A-DC12-197	(1)	25065708
RL692 or	RELAY	NRL-1P10A-DC12-198	(1)	25065709
RL693	RELAY	NRL-1P10A-DC12-140	1	25065584
RL693 or	RELAY	NRL-1P10A-DC12-143	(1)	25065588
RL694	RELAY	NRL-1P10A-DC12-140	1	25065584
RL694 or	RELAY	NRL-1P10A-DC12-143	(1)	25065588

U002	U0020 ~ U0024	BADIS-0663-1A/B	1	1B258563-1A/B
U0020	Display Circuit PC board ass'y	BADIS-0663-1A/B	1	1B2585663-1A/B
U0021	Video Input Terminals Circuit PC board ass'y	BAVD-0664-1A/B	1	1B2585664-1A/B
U0022	Standby etc. Switch Circuit PC board ass'y	BAETC-0665-1A/B	1	1B2585665-1A/B
U0023	Headphones Circuit PC board ass'y	BAETC-0666-1A/B	1	1B2585666-1A/B
U0024	Power supply Circuit PC board ass'y	BAETC-0667-1A/B	1	1B2585667-1A/B

CIRCUIT NO.	PART NAME	DESCRIPTION	Q'TY	PART NO. (SN)	REMARKS
[SEMI CONDUCTOR]					
D7002	ZENER D	DZ2J082M0L	1	224760820R2	N
D7002 or	ZENER D	UDZS8.2B	(1)	224550820R2	
D7033	ZENER D	DZ2J039M0L	1	224760390R2	N
D7033 or	ZENER D	UDZS3.9B	(1)	224550390R2	
D7152	LED	SLI-343Y8C-3F	1	225491	
D7154	LED	SLR-342MG	1	225365	<MDC, MDD, MDF>
D7154	LED	SCB3318E-D2	1	225487	<MPP, MMK, MMQ, MMR, MPA, MPB, MPP>
D7311	C-DIODE	DA2J10100	1	223303R2	
D7311 or	C-DIODE	1SS352	(1)	223234R2	

D7311 or	C-DIODE	ISS355	(1)	223269R2	
D7311 or	C-DIODE	MA2J111	(1)	223279R2	
D7311 or	C-DIODE	KDS4148U	(1)	223283R2	
D7312	C-DIODE	DA2J10100	1	223303R2	
D7312 or	C-DIODE	ISS352	(1)	223234R2	
D7312 or	C-DIODE	ISS355	(1)	223269R2	
D7312 or	C-DIODE	MA2J111	(1)	223279R2	
D7312 or	C-DIODE	KDS4148U	(1)	223283R2	
D7401	ZENER D	DZ2J051M0L	1	224760510R2	N
D7401 or	ZENER D	UDZS5.1B	(1)	224550510R2	
D7411	ZENER D	DZ2J068M0L	1	224760680R2	N
D7411 or	ZENER D	UDZS6.8B	(1)	224550680R2	
D7412	ZENER D	DZ2J068M0L	1	224760680R2	N
D7412 or	ZENER D	UDZS6.8B	(1)	224550680R2	
D7501	C-DIODE	DA2J10100	1	223303R2	
D7501 or	C-DIODE	ISS352	(1)	223234R2	
D7501 or	C-DIODE	ISS355	(1)	223269R2	
D7501 or	C-DIODE	MA2J111	(1)	223279R2	
D7501 or	C-DIODE	KDS4148U	(1)	223283R2	
D7502	C-DIODE	DA2J10100	1	223303R2	
D7502 or	C-DIODE	ISS352	(1)	223234R2	
D7502 or	C-DIODE	ISS355	(1)	223269R2	
D7502 or	C-DIODE	MA2J111	(1)	223279R2	
D7502 or	C-DIODE	KDS4148U	(1)	223283R2	
D7503	C-DIODE	DA2J10100	1	223303R2	
D7503 or	C-DIODE	ISS352	(1)	223234R2	
D7503 or	C-DIODE	ISS355	(1)	223269R2	
D7503 or	C-DIODE	MA2J111	(1)	223279R2	
D7503 or	C-DIODE	KDS4148U	(1)	223283R2	
D7504	C-DIODE	DA2J10100	1	223303R2	
D7504 or	C-DIODE	ISS352	(1)	223234R2	
D7504 or	C-DIODE	ISS355	(1)	223269R2	
D7504 or	C-DIODE	MA2J111	(1)	223279R2	
D7504 or	C-DIODE	KDS4148U	(1)	223283R2	

D9011	DIODE	D5SBA60	1	22380070F	<MDC, MDD, MDF, MMK, MMQ, MMR, MPA, MPB, MPP>
D9014	C-DIODE	DA2J10100	1	223303R2	
D9014 or	C-DIODE	1SS352	(1)	223234R2	
D9014 or	C-DIODE	1SS355	(1)	223269R2	
D9014 or	C-DIODE	MA2J111	(1)	223279R2	
D9014 or	C-DIODE	KDS4148U	(1)	223283R2	
D9015	C-DIODE	DA2J10100	1	223303R2	
D9015 or	C-DIODE	1SS352	(1)	223234R2	
D9015 or	C-DIODE	1SS355	(1)	223269R2	
D9015 or	C-DIODE	MA2J111	(1)	223279R2	
D9015 or	C-DIODE	KDS4148U	(1)	223283R2	
D9016	ZENER D	DZ2J062M0L	1	224760620R2	N
D9016 or	ZENER D	UDZS6.2B	(1)	224550620R2	
D911	C-DIODE	DA2J10100	1	223303R2	
D911 or	C-DIODE	1SS352	(1)	223234R2	
D911 or	C-DIODE	1SS355	(1)	223269R2	
D911 or	C-DIODE	MA2J111	(1)	223279R2	
D911 or	C-DIODE	KDS4148U	(1)	223283R2	
D912	C-DIODE	DA2J10100	1	223303R2	
D912 or	C-DIODE	1SS352	(1)	223234R2	
D912 or	C-DIODE	1SS355	(1)	223269R2	
D912 or	C-DIODE	MA2J111	(1)	223279R2	
D912 or	C-DIODE	KDS4148U	(1)	223283R2	
D921	C-DIODE	DA2J10100	1	223303R2	
D921 or	C-DIODE	1SS352	(1)	223234R2	
D921 or	C-DIODE	1SS355	(1)	223269R2	
D921 or	C-DIODE	MA2J111	(1)	223279R2	
D921 or	C-DIODE	KDS4148U	(1)	223283R2	
D922	C-DIODE	DA2J10100	1	223303R2	
D922 or	C-DIODE	1SS352	(1)	223234R2	
D922 or	C-DIODE	1SS355	(1)	223269R2	
D922 or	C-DIODE	MA2J111	(1)	223279R2	
D922 or	C-DIODE	KDS4148U	(1)	223283R2	
D923	C-DIODE	DA2J10100	1	223303R2	

D923 or	C-DIODE	ISS352	(1)	223234R2	
D923 or	C-DIODE	ISS355	(1)	223269R2	
D923 or	C-DIODE	MA2J111	(1)	223279R2	
D923 or	C-DIODE	KDS4148U	(1)	223283R2	
D924	C-DIODE	DA2J10100	1	223303R2	
D924 or	C-DIODE	ISS352	(1)	223234R2	
D924 or	C-DIODE	ISS355	(1)	223269R2	
D924 or	C-DIODE	MA2J111	(1)	223279R2	
D924 or	C-DIODE	KDS4148U	(1)	223283R2	
D925	C-DIODE	DA2J10100	1	223303R2	
D925 or	C-DIODE	ISS352	(1)	223234R2	
D925 or	C-DIODE	ISS355	(1)	223269R2	
D925 or	C-DIODE	MA2J111	(1)	223279R2	
D925 or	C-DIODE	KDS4148U	(1)	223283R2	
D930	C-DIODE	DA2J10100	1	223303R2	
D930 or	C-DIODE	ISS352	(1)	223234R2	
D930 or	C-DIODE	ISS355	(1)	223269R2	
D930 or	C-DIODE	MA2J111	(1)	223279R2	
D930 or	C-DIODE	KDS4148U	(1)	223283R2	
D931	C-DIODE	DA2J10100	1	223303R2	
D931 or	C-DIODE	ISS352	(1)	223234R2	
D931 or	C-DIODE	ISS355	(1)	223269R2	
D931 or	C-DIODE	MA2J111	(1)	223279R2	
D931 or	C-DIODE	KDS4148U	(1)	223283R2	
D933	C-DIODE	DA2J10100	1	223303R2	
D933 or	C-DIODE	ISS352	(1)	223234R2	
D933 or	C-DIODE	ISS355	(1)	223269R2	
D933 or	C-DIODE	MA2J111	(1)	223279R2	
D933 or	C-DIODE	KDS4148U	(1)	223283R2	
D934	ZENER D	DZ2J047M0L	1	224760470R2	<MDC, MDD, MDF>
D934 or	ZENER D	UDZS4.7B	(1)	224550470R2	<MDC, MDD, MDF>
D934	ZENER D	DZ2J051M0L	1	224760510R2	N <MPP, MMK, MMQ, MMR, MPA, MPB, MPP>
D934 or	ZENER D	UDZS5.1B	(1)	224550510R2	<MPP, MMK, MMQ, MMR, MPA, MPB, MPP>
D935	C-DIODE	DA2J10100	1	223303R2	

D935 or	C-DIODE	ISS352	(1)	223234R2	
D935 or	C-DIODE	ISS355	(1)	223269R2	
D935 or	C-DIODE	MA2J111	(1)	223279R2	
D935 or	C-DIODE	KDS4148U	(1)	223283R2	
Q2001	IC	NJW1328	1	22242691R3	
Q2304	IC	NJM4580M-D	1	22241448R2	
Q2330	IC	NJM4580M-D	1	22241448R2	<MDC, MDD, MDF, MMK, MMQ, MMR, MPA, MPB, MPP>
Q2400	IC	NJM4580M-D	1	22241448R2	<MDC, MDD, MDF, MMK, MMQ, MMR, MPA, MPB, MPP>
Q2600	IC	NJM2505AF	1	22242490R2	
Q2600 or	IC	BH7673G-TR	(1)	22242661R2	
Q7002	FL TUBE	16-BT-165GINK	1	212276	N
Q7002A	HOLDER	(FL)	1	27191303	
Q7003	TR	KTC3875-GR	1	2216175R2	
Q7004	TR	KTC3875-GR	1	2216175R2	
Q7005	TR	KRA102S	1	2216220R2	
Q7007	TR	KRC102S	1	2216190R2	
Q7008	TR	2SA1162-GR	1	2214375R2	
Q7009	TR	KRC107S	1	2216340R2	
Q7033	TR	KTC3875-GR	1	2216175R2	
Q7154	TR	DTC123JKA	1	2216690R2	
Q7402	IC	NJM4580M-D	1	22241448R2	
Q7403	TR	DTC114TKA	1	2216670R2	
Q7404	TR	DTC114TKA	1	2216670R2	
Q9020	IC	XC6220B501PR	1	22242692R2	
[TRANS COIL]					
L2300	EMIFIL	BK1608LM182-T	1	230958R1	
L2301	EMIFIL	BK1608LM182-T	1	230958R1	
L2302	EMIFIL	BK1608LM182-T	1	230958R1	<MDC, MDD, MDF, MMK, MMQ, MMR, MPA, MPB, MPP>
L2303	CORE	BLM18PG181SN1D	1	2350005R1	
L2304	CORE	BLM18PG181SN1D	1	2350005R1	
L2305	EMIFIL	BK1608LM182-T	1	230958R1	
L2306	EMIFIL	BK1608LM182-T	1	230958R1	
L2307	EMIFIL	BK1608LM182-T	1	230958R1	
L2308	EMIFIL	BK1608LM182-T	1	230958R1	

L2309	EMIFIL	BK1608LM182-T	1	230958R1	
L2310	EMIFIL	BK1608LM182-T	1	230958R1	
L2311	EMIFIL	BK1608LM182-T	1	230958R1	
L2312	EMIFIL	BK1608LM182-T	1	230958R1	
L2313	EMIFIL	BK1608LM182-T	1	230958R1	
L2314	EMIFIL	BK1608LM182-T	1	230958R1	
L2315	EMIFIL	BK1608LM182-T	1	230958R1	
L2316	CORE	BLM18PG181SN1D	1	2350005R1	
L2317	EMIFIL	BK1608LM182-T	1	230958R1	<MDC, MDD, MDF, MMK, MMQ, MMR, MPA, MPB, MPP>
L2318	EMIFIL	BK1608LM182-T	1	230958R1	<MDC, MDD, MDF, MMK, MMQ, MMR, MPA, MPB, MPP>
L2319	EMIFIL	BK1608LM182-T	1	230958R1	<MDC, MDD, MDF, MMK, MMQ, MMR, MPA, MPB, MPP>
L2320	EMIFIL	BK1608LM182-T	1	230958R1	<MDC, MDD, MDF, MMK, MMQ, MMR, MPA, MPB, MPP>
L2321	EMIFIL	BK1608LM182-T	1	230958R1	<MDC, MDD, MDF, MMK, MMQ, MMR, MPA, MPB, MPP>
L7031	CHOKE COIL	LBC2518T2R2M	1	231364M022R2	
L7201	CHOKE COIL	LBC2518T2R2M	1	231364M022R2	
L7202	CHOKE COIL	LBC2518T2R2M	1	231364M022R2	
L7203	CHOKE COIL	LBC2518T2R2M	1	231364M022R2	
L7301	EMIFIL	BK1608LM182-T	1	230958R1	
L7302	EMIFIL	BK1608LM182-T	1	230958R1	
L7431	CHOKE COIL	LBC2518T2R2M	1	231364M022R2	
L7432	CHOKE COIL	LBC2518T2R2M	1	231364M022R2	
L7501	CORE	BLM18PG121SN1D	1	2350006R1	
L7502	CORE	BLM18PG121SN1D	1	2350006R1	
L7503	CORE	BLM18PG121SN1D	1	2350006R1	
L9020	CORE	BLM18PG181SN1D	1	2350005R1	
T902	P TRANS	NPT-1520JQ	1	2301812A	! <MDC, MDD, MDF>
T902	P TRANS	NPT-1520GQ	1	2301813A	! <MPP, MMK, MMQ, MMR, MPA, MPB, MPP>
[CAPACITOR]					
C2000	C-CERA C	CK725F1E-104Z1	1	332161040R1	
C2001	C-CERA C	CK725F1E-104Z1	1	332161040R1	
C2002	VR C	CE04W50V-2.2M(VR)	1	394680227T	
C2002 or	JAMICON	CE04W50V-2.2M	(1)	398580227T	
C2003	VR C	CE04W6.3V-470M(VR)	1	394624717T	
C2003 or	JAMICON	CE04W6.3V-470M	(1)	398524717T	

C2004	C-CERA C	CK725F1E-104Z1	1	332161040R1
C2005	VR C	CE04W6.3V-470M(VR)	1	394624717T
C2005 or	JAMICON	CE04W6.3V-470M	(1)	398524717T
C2006	C-CERA C	CC725CH1H-470J1	1	342104704R1
C2007	C-CERA C	CK725F1E-104Z1	1	332161040R1
C2008	C-CERA C	CK725F1A-105Z1	1	332181050R1
C2009	C-CERA C	CK725F1A-105Z1	1	332181050R1
C2010	C-CERA C	CK725F1A-105Z1	1	332181050R1
C2011	C-CERA C	CC725CH1H-470J1	1	342104704R1
C2012	C-CERA C	CK725F1A-105Z1	1	332181050R1
C2013	VR C	CE04W50V-10M(VR)	1	394681007T
C2013 or	JAMICON	CE04W50V-10M	(1)	398581007T
C2020	C-CERA C	CK725F1A-105Z1	1	332181050R1
C2021	C-CERA C	CK725F1A-105Z1	1	332181050R1
C2102	VR C	CE04W6.3V-470M(VR)	1	394624717T
C2102 or	JAMICON	CE04W6.3V-470M	(1)	398524717T
C2103	VR C	CE04W50V-2.2M(VR)	1	394680227T
C2103 or	JAMICON	CE04W50V-2.2M	(1)	398580227T
C2104	VR C	CE04W50V-2.2M(VR)	1	394680227T
C2104 or	JAMICON	CE04W50V-2.2M	(1)	398580227T
C2105	VR C	CE04W6.3V-470M(VR)	1	394624717T
C2105 or	JAMICON	CE04W6.3V-470M	(1)	398524717T
C2106	VR C	CE04W50V-2.2M(VR)	1	394680227T
C2106 or	JAMICON	CE04W50V-2.2M	(1)	398580227T
C2107	VR C	CE04W50V-2.2M(VR)	1	394680227T
C2107 or	JAMICON	CE04W50V-2.2M	(1)	398580227T
C2108	VR C	CE04W6.3V-470M(VR)	1	394624717T
C2108 or	JAMICON	CE04W6.3V-470M	(1)	398524717T
C2109	VR C	CE04W6.3V-470M(VR)	1	394624717T
C2109 or	JAMICON	CE04W6.3V-470M	(1)	398524717T
C2110	VR C	CE04W6.3V-470M(VR)	1	394624717T
C2110 or	JAMICON	CE04W6.3V-470M	(1)	398524717T
C2111	VR C	CE04W50V-2.2M(VR)	1	394680227T
C2111 or	JAMICON	CE04W50V-2.2M	(1)	398580227T

C2112	VR C	CE04W50V-2.2M(VR)	1	394680227T	
C2112 or	JAMICON	CE04W50V-2.2M	(1)	398580227T	
C2113	VR C	CE04W50V-2.2M(VR)	1	394680227T	
C2113 or	JAMICON	CE04W50V-2.2M	(1)	398580227T	
C2114	VR C	CE04W50V-2.2M(VR)	1	394680227T	
C2114 or	JAMICON	CE04W50V-2.2M	(1)	398580227T	
C2115	VR C	CE04W50V-2.2M(VR)	1	394680227T	
C2115 or	JAMICON	CE04W50V-2.2M	(1)	398580227T	
C2116	VR C	CE04W50V-2.2M(VR)	1	394680227T	
C2116 or	JAMICON	CE04W50V-2.2M	(1)	398580227T	
C2201	C-CERA C	CK725B1H-102K1	1	332101025R1	
C2202	C-CERA C	CK725B1H-102K1	1	332101025R1	
C2203	C-CERA C	CK725B1H-103K1	1	332101035R1	
C2301	UTSP C	CE04W50V-10M(UTSP)	1	397581007T	<MDC, MDD, MDF, MMK, MMQ, MMR, MPA, MPB, MPP>
C2302	UTSP C	CE04W50V-10M(UTSP)	1	397581007T	<MDC, MDD, MDF, MMK, MMQ, MMR, MPA, MPB, MPP>
C2331	C-CERA C	CC725CH1H-471J1	1	342104714R1	<MDC, MDD, MDF, MMK, MMQ, MMR, MPA, MPB, MPP>
C2332	C-CERA C	CC725CH1H-471J1	1	342104714R1	<MDC, MDD, MDF, MMK, MMQ, MMR, MPA, MPB, MPP>
C2333	UTSP C	CE04W50V-10M(UTSP)	1	397581007T	<MDC, MDD, MDF, MMK, MMQ, MMR, MPA, MPB, MPP>
C2334	UTSP C	CE04W50V-10M(UTSP)	1	397581007T	<MDC, MDD, MDF, MMK, MMQ, MMR, MPA, MPB, MPP>
C2335	C-CERA C	CC725CH1H-471J1	1	342104714R1	<MDC, MDD, MDF, MMK, MMQ, MMR, MPA, MPB, MPP>
C2336	C-CERA C	CC725CH1H-471J1	1	342104714R1	<MDC, MDD, MDF, MMK, MMQ, MMR, MPA, MPB, MPP>
C2337	UTSP C	CE04W50V-10M(UTSP)	1	397581007T	<MDC, MDD, MDF, MMK, MMQ, MMR, MPA, MPB, MPP>
C2338	UTSP C	CE04W50V-10M(UTSP)	1	397581007T	<MDC, MDD, MDF, MMK, MMQ, MMR, MPA, MPB, MPP>
C2350	C-CERA C	CC725CH1H-471J1	1	342104714R1	
C2351	C-CERA C	CC725CH1H-471J1	1	342104714R1	
C2352	C-CERA C	CC725CH1H-470J1	1	342104704R1	
C2355	C-CERA C	CK725F1E-104Z1	1	332161040R1	
C2370	C-CERA C	CC725CH1H-101J1	1	342101014R1	
C2371	C-CERA C	CC725CH1H-101J1	1	342101014R1	
C2377	UTSP C	CE04W50V-10M(UTSP)	1	397581007T	
C2378	UTSP C	CE04W50V-10M(UTSP)	1	397581007T	
C2380	C-CERA C	CC725CH1H-101J1	1	342101014R1	
C2381	C-CERA C	CC725CH1H-101J1	1	342101014R1	
C2382	C-CERA C	CC725CH1H-101J1	1	342101014R1	

C2383	C-CERA C	CC725CH1H-101J1	1	342101014R1	
C2384	C-CERA C	CK725F1A-105Z1	1	332181050R1	
C2385	C-CERA C	CK725F1A-105Z1	1	332181050R1	
C2388	C-CERA C	CK725F1E-104Z1	1	332161040R1	
C2389	C-CERA C	CK725F1E-104Z1	1	332161040R1	
C2391	C-CERA C	CK725F1A-105Z1	1	332181050R1	
C2392	C-CERA C	CK725F1A-105Z1	1	332181050R1	
C2393	C-CERA C	CC725CH1H-471J1	1	342104714R1	
C2394	C-CERA C	CC725CH1H-471J1	1	342104714R1	
C2395	C-CERA C	CC725CH1H-471J1	1	342104714R1	
C2396	C-CERA C	CC725CH1H-471J1	1	342104714R1	
C2397	C-CERA C	CK725F1A-105Z1	1	332181050R1	
C2398	C-CERA C	CK725F1A-105Z1	1	332181050R1	
C2402	C-CERA C	CC725CH1H-471J1	1	342104714R1	<MDC, MDD, MDF, MMK, MMQ, MMR, MPA, MPB, MPP>
C2403	C-CERA C	CC725CH1H-471J1	1	342104714R1	<MDC, MDD, MDF, MMK, MMQ, MMR, MPA, MPB, MPP>
C2404	UTSP C	CE04W50V-10M(UTSP)	1	397581007T	<MDC, MDD, MDF, MMK, MMQ, MMR, MPA, MPB, MPP>
C2405	UTSP C	CE04W50V-10M(UTSP)	1	397581007T	<MDC, MDD, MDF, MMK, MMQ, MMR, MPA, MPB, MPP>
C2601	C-CERA C	CK725F1E-104Z1	1	332161040R1	
C2602	VR C	CE04W6.3V-470M(VR)	1	394624717T	
C2602 or	JAMICON	CE04W6.3V-470M	(1)	398524717T	
C2603	C-CERA C	CC725CH1H-470J1	1	342104704R1	
C2604	VR C	CE04W6.3V-470M(VR)	1	394624717T	
C2604 or	JAMICON	CE04W6.3V-470M	(1)	398524717T	
C2605	C-CERA C	CC725CH1H-470J1	1	342104704R1	
C7002	C-CERA C	CK725F1E-104Z1	1	332161040R1	
C7003	C-CERA C	CC725CH1H-101J1	1	342101014R1	
C7004	C-CERA C	CC725CH1H-101J1	1	342101014R1	
C7005	C-CERA C	CC725CH1H-101J1	1	342101014R1	
C7008	ELECT C	CE04W6.3V-100M(S)	1	353721019T	
C7009	C-CERA C	CK725F1E-104Z1	1	332161040R1	
C7010	C-CERA C	CK725B1H-223K1	1	332102235R1	
C7011	C-CERA C	CK725B1H-223K1	1	332102235R1	
C7012	C-CERA C	CK725B1H-223K1	1	332102235R1	
C7014	C-CERA C	CK725B1H-223K1	1	332102235R1	

C7015	ELECT C	CE04W16V-47M(S)	1	353744709T	
C7016	C-CERA C	CK725B1H-223K1	1	332102235R1	
C7017	C-CERA C	CK725B1H-223K1	1	332102235R1	
C7019	TF C	ECQ-V50V-104J	1	374721044T	
C7021	C-CERA C	CK725B1H-103K1	1	332101035R1	
C7022	C-CERA C	CK725B1H-103K1	1	332101035R1	
C7031	C-CERA C	CK725B1H-223K1	1	332102235R1	
C7032	C-CERA C	CK725B1H-223K1	1	332102235R1	
C7033	ELECT C	CE04W16V-10M(S)	1	353741009T	
C7041	ELECT C	CE04W16V-10M(S)	1	353741009T	
C7042	C-CERA C	CC725CH1H-102J1	1	342101024R1	
C7043	C-CERA C	CC725CH1H-102J1	1	342101024R1	
C7201	C-CERA C	CC725CH1H-102J1	1	342101024R1	
C7202	C-CERA C	CK725B1H-223K1	1	332102235R1	
C7203	MKT C	B32529C0102J289	1	376491024T	
C7204	MKT C	B32529C0102J289	1	376491024T	
C7305	C-CERA C	CK725F1E-104Z1	1	332161040R1	
C7311	C-CERA C	CC725CH1H-471J1	1	342104714R1	<MDC, MDD, MDF, MMK, MMQ, MMR, MPA, MPB, MPP>
C7312	C-CERA C	CC725CH1H-471J1	1	342104714R1	<MDC, MDD, MDF, MMK, MMQ, MMR, MPA, MPB, MPP>
C7314	C-CERA C	CK725F1E-104Z1	1	332161040R1	
C7316	C-CERA C	CK725F1E-104Z1	1	332161040R1	
C7319	C-CERA C	CC725CH1H-470J1	1	342104704R1	
C7403	ELECT C	CE04W16V-47M(S)	1	353744709T	
C7405	ELECT C	CE04W16V-10M(S)	1	353741009T	
C7411	ELECT C	CE04W16V-47M(S)	1	353744709T	
C7412	ELECT C	CE04W16V-47M(S)	1	353744709T	
C7431	ELECT C	CE04W16V-10M(S)	1	353741009T	
C7432	C-CERA C	CC725CH1H-101J1	1	342101014R1	
C7433	C-CERA C	CC725CH1H-102J1	1	342101024R1	
C7434	C-CERA C	CC725CH1H-330J1	1	342103304R1	
C7501	C-CERA C	CK725F1E-104Z1	1	332161040R1	
C7503	C-CERA C	CK725F1E-104Z1	1	332161040R1	
C901	IS C	LE103-C3.5	1	3800042S	!
C901 or	IS C	ECQU2A103MLC	(1)	3800039S	!

C9011	VR C	CE04W16V-1000M(VR)	1	394641037S	
C9012	TF C	ECQ-V50V-334J	1	374723344T	
C9013	VR C	CE04W50V-4.7M(VR)	1	394680477T	
C9013 or	JAMICON	CE04W50V-4.7M	(1)	398580477T	
C902	C-CERA C	CK725F1E-104Z1	1	332161040R1	
C9020	C-CERA C	CK732B16V-106K	1	332071065R2	
C9021	C-CERA C	CK732B16V-106K	1	332071065R2	
C9022	C-CERA C	CK732B16V-106K	1	332071065R2	
C9023	C-CERA C	CK732B16V-106K	1	332071065R2	
C9026	VR C	CE04W6.3V-470M(VR)	1	394624717T	
C9026 or	JAMICON	CE04W6.3V-470M	(1)	398524717T	
C9027	C-CERA C	CK725F1E-104Z1	1	332161040R1	
C9028	C-CERA C	CK725F1E-104Z1	1	332161040R1	
C9029	C-CERA C	CK725F1E-104Z1	1	332161040R1	
C9030	C-CERA C	CK725F1E-104Z1	1	332161040R1	
C9031	C-CERA C	CK725F1E-104Z1	1	332161040R1	
C911	C-CERA C	CC725CH1H-102J1	1	342101024R1	<MDC, MDD, MDF, MMK, MMQ, MMR, MPA, MPB, MPP>
C921	C-CERA C	CK725B1H-223K1	1	332102235R1	
C922	VR C	CE04W16V-2200M(VR)	1	394642227S	
C922 or	JAMICON	CE04W16V-2200M	(1)	398542227S	N
C930	VR C	CE04W16V-470M(VR)	1	394644717T	<MDC, MDD, MDF, MMK, MMQ, MMR, MPA, MPB, MPP>
C930 or	JAMICON	CE04W16V-470M	(1)	398544717T	N <MDC, MDD, MDF, MMK, MMQ, MMR, MPA, MPB, MPP>
C933	UTSP C	CE04W50V-4.7M(UTSP)	1	397580477T	
[RESISTOR]					
R2001	C-CARBON R	RN72K1J-220JE	1	435032204R1	
R2002	C-CARBON R	RN72K1J-220JE	1	435032204R1	
R2003	C-CARBON R	RN72K1J-105JE	1	435031054R1	
R2004	C-CARBON R	RN72K1J-563JE	1	435035634R1	
R2005	C-CARBON R	RN72K1J-103JE	1	435031034R1	
R2006	C-CARBON R	RN72K1J-103JE	1	435031034R1	
R2007	C-CARBON R	RN72K1J-563JE	1	435035634R1	
R2008	C-CARBON R	RN72K1J-222JE	1	435032224R1	
R2009	C-CARBON R	RN72K1J-222JE	1	435032224R1	
R2010	C-CARBON R	RN72K1J-183JE	1	435031834R1	

R2011	C-CARBON R	RN72KIJ-183JE	1	435031834R1	
R2101	C-CARBON R	RN72KIJ-750JE	1	435037504R1	
R2102	C-CARBON R	RN72KIJ-750JE	1	435037504R1	
R2103	C-CARBON R	RN72KIJ-750JE	1	435037504R1	
R2104	C-CARBON R	RN72KIJ-750JE	1	435037504R1	
R2105	C-CARBON R	RN72KIJ-750JE	1	435037504R1	
R2106	C-CARBON R	RN72KIJ-750JE	1	435037504R1	
R2107	C-CARBON R	RN72KIJ-750JE	1	435037504R1	
R2108	C-CARBON R	RN72KIJ-750JE	1	435037504R1	
R2109	C-CARBON R	RN72KIJ-750JE	1	435037504R1	
R2110	C-CARBON R	RN72KIJ-750JE	1	435037504R1	
R2111	C-CARBON R	RN72KIJ-750JE	1	435037504R1	
R2112	C-CARBON R	RN72KIJ-750JE	1	435037504R1	
R2113	C-CARBON R	RN72KIJ-750JE	1	435037504R1	
R2114	C-CARBON R	RN72KIJ-750JE	1	435037504R1	
R2115	C-CARBON R	RN72KIJ-750JE	1	435037504R1	
R2116	C-CARBON R	RN72KIJ-750JE	1	435037504R1	
R2120	C-CARBON R	RN72KIJ-104JE	1	435031044R1	
R2121	C-CARBON R	RN72KIJ-104JE	1	435031044R1	
R2122	C-CARBON R	RN72KIJ-104JE	1	435031044R1	
R2123	C-CARBON R	RN72KIJ-104JE	1	435031044R1	
R2124	C-CARBON R	RN72KIJ-104JE	1	435031044R1	
R2155	C-CARBON R	RN72KIJ-000JE	1	435030004R1	
R2156	C-CARBON R	RN72KIJ-000JE	1	435030004R1	
R2157	C-CARBON R	RN72KIJ-000JE	1	435030004R1	
R2301	C-CARBON R	RN72KIJ-224JE	1	435032244R1	<MDC, MDD, MDF, MMK, MMQ, MMR, MPA, MPB, MPP>
R2302	C-CARBON R	RN72KIJ-224JE	1	435032244R1	<MDC, MDD, MDF, MMK, MMQ, MMR, MPA, MPB, MPP>
R2304	C-CARBON R	RN72KIJ-123JE	1	435031234R1	
R2305	C-CARBON R	RN72KIJ-123JE	1	435031234R1	
R2306	C-CARBON R	RN72KIJ-223JE	1	435032234R1	
R2307	C-CARBON R	RN72KIJ-223JE	1	435032234R1	
R2308	C-CARBON R	RN72KIJ-123JE	1	435031234R1	
R2309	C-CARBON R	RN72KIJ-123JE	1	435031234R1	
R2310	C-CARBON R	RN72KIJ-223JE	1	435032234R1	

R2311	C-CARBON R	RN72KIJ-223JE	1	435032234R1	
R2320	C-CARBON R	RN72KIJ-471JE	1	435034714R1	
R2321	C-CARBON R	RN72KIJ-471JE	1	435034714R1	
R2330	C-CARBON R	RN72KIJ-105JE	1	435031054R1	
R2331	C-CARBON R	RN72KIJ-224JE	1	435032244R1	<MDC, MDD, MDF, MMK, MMQ, MMR, MPA, MPB, MPP>
R2332	C-CARBON R	RN72KIJ-224JE	1	435032244R1	<MDC, MDD, MDF, MMK, MMQ, MMR, MPA, MPB, MPP>
R2333	C-CARBON R	RN72KIJ-222JE	1	435032224R1	<MDC, MDD, MDF, MMK, MMQ, MMR, MPA, MPB, MPP>
R2334	C-CARBON R	RN72KIJ-222JE	1	435032224R1	<MDC, MDD, MDF, MMK, MMQ, MMR, MPA, MPB, MPP>
R2337	C-CARBON R	RN72KIJ-224JE	1	435032244R1	<MDC, MDD, MDF, MMK, MMQ, MMR, MPA, MPB, MPP>
R2338	C-CARBON R	RN72KIJ-224JE	1	435032244R1	<MDC, MDD, MDF, MMK, MMQ, MMR, MPA, MPB, MPP>
R2348	C-CARBON R	RN72KIJ-000JE	1	435030004R1	
R2349	C-CARBON R	RN72KIJ-000JE	1	435030004R1	
R2352	C-CARBON R	RN72KIJ-750JE	1	435037504R1	
R2360	C-CARBON R	RN72KIJ-103JE	1	435031034R1	
R2361	C-CARBON R	RN72KIJ-103JE	1	435031034R1	
R2363	C-CARBON R	RN72KIJ-103JE	1	435031034R1	
R2364	C-CARBON R	RN72KIJ-103JE	1	435031034R1	
R2400	C-CARBON R	RN72KIJ-222FE	1	435032222R1	<MDC, MDD, MDF, MMK, MMQ, MMR, MPA, MPB, MPP>
R2401	C-CARBON R	RN72KIJ-222FE	1	435032222R1	<MDC, MDD, MDF, MMK, MMQ, MMR, MPA, MPB, MPP>
R2402	C-CARBON R	RN72KIJ-222FE	1	435032222R1	<MDC, MDD, MDF, MMK, MMQ, MMR, MPA, MPB, MPP>
R2403	C-CARBON R	RN72KIJ-222FE	1	435032222R1	<MDC, MDD, MDF, MMK, MMQ, MMR, MPA, MPB, MPP>
R2601	C-CARBON R	RN72KIJ-220JE	1	435032204R1	
R2602	C-CARBON R	RN72KIJ-220JE	1	435032204R1	
R2603	C-CARBON R	RN72KIJ-047JE	1	435030474R1	
R7002	C-CARBON R	RN72KIJ-332JE	1	435033324R1	
R7003	C-CARBON R	RN72KIJ-332JE	1	435033324R1	
R7004	C-CARBON R	RN72KIJ-221JE	1	435032214R1	
R7005	C-CARBON R	RN72KIJ-221JE	1	435032214R1	
R7007	C-CARBON R	RN72KIJ-221JE	1	435032214R1	
R7008	C-CARBON R	RN72KIJ-221JE	1	435032214R1	
R7010	C-CARBON R	RN72KIJ-104JE	1	435031044R1	
R7011	C-CARBON R	RN72KIJ-101JE	1	435031014R1	
R7012	C-CARBON R	RN72KIJ-333JE	1	435033334R1	
R7013	C-CARBON R	RN72KIJ-104JE	1	435031044R1	

R7014	C-CARBON R	RN72KIJ-101JE	1	435031014R1
R7015	C-CARBON R	RN72KIJ-333JE	1	435033334R1
R7016	C-CARBON R	RN72KIJ-100JE	1	435031004R1
R7017	C-CARBON R	RN72KIJ-333JE	1	435033334R1
R7018	C-CARBON R	RN72KIJ-100JE	1	435031004R1
R7021	C-CARBON R	RN72KIJ-103JE	1	435031034R1
R7022	C-CARBON R	RN72KIJ-103JE	1	435031034R1
R7023	C-CARBON R	RN72KIJ-103JE	1	435031034R1
R7024	C-CARBON R	RN72KIJ-103JE	1	435031034R1
R7033	C-CARBON R	RN72KIJ-820JE	1	435038204R1
R7041	C-CARBON R	RN72KIJ-101JE	1	435031014R1
R7042	C-CARBON R	RN72KIJ-102JE	1	435031024R1
R7043	C-CARBON R	RN72KIJ-104JE	1	435031044R1
R7044	C-CARBON R	RN72KIJ-473JE	1	435034734R1
R7045	C-CARBON R	RN72KIJ-562JE	1	435035624R1
R7046	C-CARBON R	RN72KIJ-562JE	1	435035624R1
R7101	C-CARBON R	RN72KIJ-271JE	1	435032714R1
R7102	C-CARBON R	RN72KIJ-331JE	1	435033314R1
R7103	C-CARBON R	RN72KIJ-471JE	1	435034714R1
R7104	C-CARBON R	RN72KIJ-561JE	1	435035614R1
R7105	C-CARBON R	RN72KIJ-821JE	1	435038214R1
R7106	C-CARBON R	RN72KIJ-271JE	1	435032714R1
R7107	C-CARBON R	RN72KIJ-331JE	1	435033314R1
R7108	C-CARBON R	RN72KIJ-471JE	1	435034714R1
R7109	C-CARBON R	RN72KIJ-561JE	1	435035614R1
R7110	C-CARBON R	RN72KIJ-821JE	1	435038214R1
R7111	C-CARBON R	RN72KIJ-122JE	1	435031224R1
R7112	C-CARBON R	RN72KIJ-222JE	1	435032224R1
R7113	C-CARBON R	RN72KIJ-392JE	1	435033924R1
R7114	C-CARBON R	RN72KIJ-122JE	1	435031224R1
R7115	C-CARBON R	RN72KIJ-271JE	1	435032714R1
R7116	C-CARBON R	RN72KIJ-331JE	1	435033314R1
R7117	C-CARBON R	RN72KIJ-471JE	1	435034714R1
R7118	C-CARBON R	RN72KIJ-561JE	1	435035614R1

R7119	C-CARBON R	RN72K1J-821JE	1	435038214R1	
R7120	C-CARBON R	RN72K1J-122JE	1	435031224R1	
R7121	C-CARBON R	RN72K1J-222JE	1	435032224R1	
R7122	C-CARBON R	RN72K1J-392JE	1	435033924R1	
R7123	C-CARBON R	RN72K1J-271JE	1	435032714R1	
R7124	C-CARBON R	RN72K1J-331JE	1	435033314R1	
R7125	C-CARBON R	RN72K1J-471JE	1	435034714R1	
R7126	C-CARBON R	RN72K1J-561JE	1	435035614R1	
R7127	C-CARBON R	RN72K1J-821JE	1	435038214R1	
R7128	C-CARBON R	RN72K1J-122JE	1	435031224R1	
R7129	C-CARBON R	RN72K1J-222JE	1	435032224R1	
R7152	C-CARBON R	RN72K1J-222JE	1	435032224R1	
R7154	C-CARBON R	RN72K1J-121JE	1	435031214R1	<MDC, MDD, MDF>
R7154	C-CARBON R	RN72K1J-272JE	1	435032724R1	<MPP, MMK, MMQ, MMR, MPA, MPB, MPP>
R7311	C-CARBON R	RN72K1J-331JE	1	435033314R1	<MDC, MDD, MDF, MMK, MMQ, MMR, MPA, MPB, MPP>
R7312	C-CARBON R	RN72K1J-331JE	1	435033314R1	<MDC, MDD, MDF, MMK, MMQ, MMR, MPA, MPB, MPP>
R7314	C-CARBON R	RN72K1J-000JE	1	435030004R1	
R7401	C-CARBON R	RN72K1J-101JE	1	435031014R1	
R7403	C-CARBON R	RN72K1J-472JE	1	435034724R1	
R7406	C-CARBON R	RN72K1J-331JE	1	435033314R1	
R7409	C-CARBON R	RN72K1J-221JE	1	435032214R1	
R7410	C-CARBON R	RN72K1J-221JE	1	435032214R1	
R7411	C-CARBON R	RN72K1J-471JE	1	435034714R1	
R7412	C-CARBON R	RN72K1J-471JE	1	435034714R1	
R7413	C-CARBON R	RN72K1J-224JE	1	435032244R1	
R7414	C-CARBON R	RN72K1J-104JE	1	435031044R1	
R7420	C-CARBON R	RN72K1J-473JE	1	435034734R1	
R7431	C-CARBON R	RN72K1J-221JE	1	435032214R1	
R7432	C-CARBON R	RN72K1J-224JE	1	435032244R1	
R7433	C-CARBON R	RN72K1J-473JE	1	435034734R1	
R7434	C-CARBON R	RN72K1J-102JE	1	435031024R1	
R7435	C-CARBON R	RN72K1J-333JE	1	435033334R1	
R9014	C-CARBON R	RN72K1J-104JE	1	435031044R1	
R9030	THERMISTOR	FUSB090F	1	4000252T	

R921	METAL O R	RS1/2WBJ-47	1	443524704T	
R922	C-CARBON R	RN72K1J-823JE	1	435038234R1	<MDC, MDD, MDF>
R934	C-CARBON R	RN72K1J-104JE	1	435031044R1	
[SW TRM]					
E7201	TRM-423(SCREW)	NEJITANSI ST3	1	25060495	
E7302A	RETAINER	(GND)	1	27142222A	
E9002	RETAINER	(JOINT)	1	27142069	
E901	TRM-423(SCREW)	NEJITANSI ST3	1	25060495	
E902	TRM-423(SCREW)	NEJITANSI ST3	1	25060495	
F9001	FUSE	5A-UL-125V	1	252385T	!
F901C	FUSE HOL	NSCT-1P2031	1	25052133T	! <MDC, MDD, MDF, MMK, MMQ, MMR, MPA, MPB, MPP>
F901D	FUSE HOL	NSCT-1P2031	1	25052133T	! <MDC, MDD, MDF, MMK, MMQ, MMR, MPA, MPB, MPP>
F901E	LABEL	LABEL	1	29360842	<MDC, MDD, MDF>
F901E	LABEL	T4AL250V	1	29361732A	<MPP, MMK, MMQ, MMR, MPA, MPB, MPP>
JL502B	WIRE TRAP	NPLG-5P588	1	25055626	
JL503B	WIRE TRAP	NPLG-7P590	1	25055628	<MDC, MDD, MDF, MMK, MMQ, MMR, MPA, MPB, MPP>
JL605A	WIRE HOL	NSCT-5P896	1	25051109	
JL702A	WIRE HOL	NSCT-7P878	1	25051091	
JL702B	WIRE TRAP	NPLG-7P590	1	25055628	
JL801A	WIRE HOL	NSCT-5P876	1	25051089	
JL901A	WIRE HOL	NSCT-5P876	1	25051089	
JL952B	SOCKET	NSCT-3P95	1	25050267	
JL953A	WIRE HOL	NSCT-5P876	1	25051089	
P2001A	SOCKET	NSCT-7P2398	1	25052501	<MDC, MDD, MDF, MMK, MMQ, MMR, MPA, MPB, MPP>
P2081	SOCKET	NNA1-01-006	1	25053357	
P2201	PIN JACK	NPJ-3PDYYY560	1	25045778	
P2202	PIN JACK	NPJ-3PDYYY560	1	25045778	
P2203	PIN JACK	NPJ-9PDGLRGLRGLR563	1	25045781	
P2800A	SOCKET	NSCT-9P2400	1	25052503	
P3101B	PLUG	NPLG-5P352	1	25055369	
P701B	SOCKET	NSCT-23P2441	1	25052544	
P703A	SOCKET	NSCT-7P2425	1	25052528	
P7201	ST JACK	MSJ-064-05A SR	1	25045783	
P7201 or	ST JACK	YKB21-5005	(1)	25045724	

P7302	PIN JACK	NPJ-3PDB720	1	25045957	N <MDC, MDD, MDF, MMK, MMQ, MMR, MPA, MPB, MPP>
P7402	ST JACK	MSJ-035-05C B AG SR type	1	25045879	
P7501	SOCKET	000010211-00027	1	25053411	
P901A	PLUG	NPLG-2P631	1	25055675	!
P911	PLUG	NPLG-2P631	1	25055675	!
RL901	RELAY	NRL-1P5A-DC9-179	1	25065669	! <MDC, MDD, MDF, MMK, MMQ, MMR, MPA, MPB, MPP>
RL901 or	RELAY	NRL-1P10A-DC9-188	(1)	25065693	! <MDC, MDD, MDF, MMK, MMQ, MMR, MPA, MPB, MPP>
S7002	R ENCODE	EC12E2425WITH WASHER	1	25065655W	
S7102	PUSH SW	NPS-111-S681	1	25035718T	
S7103	PUSH SW	NPS-111-S681	1	25035718T	
S7104	PUSH SW	NPS-111-S681	1	25035718T	
S7105	PUSH SW	NPS-111-S681	1	25035718T	
S7106	PUSH SW	NPS-111-S681	1	25035718T	
S7113	PUSH SW	NPS-111-S681	1	25035718T	
S7114	PUSH SW	NPS-111-S681	1	25035718T	
S7116	PUSH SW	NPS-111-S681	1	25035718T	
S7118	PUSH SW	NPS-111-S681	1	25035718T	
S7120	PUSH SW	NPS-111-S681	1	25035718T	
S7122	PUSH SW	NPS-111-S681	1	25035718T	
S7124	PUSH SW	NPS-111-S681	1	25035718T	
S7126	PUSH SW	NPS-111-S681	1	25035718T	
S7128	PUSH SW	NPS-111-S681	1	25035718T	
S7132	PUSH SW	NPS-111-S681	1	25035718T	
S7134	PUSH SW	NPS-111-S681	1	25035718T	
S7136	PUSH SW	NPS-111-S681	1	25035718T	
S7138	PUSH SW	NPS-111-S681	1	25035718T	
S7140	PUSH SW	NPS-111-S681	1	25035718T	
S7142	PUSH SW	NPS-111-S681	1	25035718T	
S7144	PUSH SW	NPS-111-S681	1	25035718T	
S7146	PUSH SW	NPS-111-S681	1	25035718T	
S7148	PUSH SW	NPS-111-S681	1	25035718T	
S7150	PUSH SW	NPS-111-S681	1	25035718T	
S7152	PUSH SW	NPS-111-S681	1	25035718T	
S7154	PUSH SW	NPS-111-S681	1	25035718T	

S7156	PUSH SW	NPS-111-S681	1	25035718T
S7158	PUSH SW	NPS-111-S681	1	25035718T
S7160	PUSH SW	NPS-111-S681	1	25035718T
S7162	PUSH SW	NPS-111-S681	1	25035718T
S7164	PUSH SW	NPS-111-S681	1	25035718T

[TUNER UNIT]

U7041	REMO SENS	KSM-603TE5B	1	24130019
-------	-----------	-------------	---	----------

U003	U0030 x 2 pcs.	BAHDM-0682-1A/B	1B258582-1A/B
U0030	HDMI Circuit PC board ass'y	BAHDM-0682-1A/B	1B2585682-1A/B

CIRCUIT NO.	PART NAME	DESCRIPTION	Q'TY	PART NO. (SN)	REMARKS
[SEMI CONDUCTOR]					
D110	C-DIODE	DA2J10100	1	223303R2	
D110 or	C-DIODE	1SS352	(1)	223234R2	
D110 or	C-DIODE	1SS355	(1)	223269R2	
D110 or	C-DIODE	MA2J111	(1)	223279R2	
D110 or	C-DIODE	KDS4148U	(1)	223283R2	
D111	C-DIODE	DA2J10100	1	223303R2	
D111 or	C-DIODE	1SS352	(1)	223234R2	
D111 or	C-DIODE	1SS355	(1)	223269R2	
D111 or	C-DIODE	MA2J111	(1)	223279R2	
D111 or	C-DIODE	KDS4148U	(1)	223283R2	
D182	C-DIODE	DA2J10100	1	223303R2	
D182 or	C-DIODE	1SS352	(1)	223234R2	
D182 or	C-DIODE	1SS355	(1)	223269R2	
D182 or	C-DIODE	MA2J111	(1)	223279R2	
D182 or	C-DIODE	KDS4148U	(1)	223283R2	
D183	C-DIODE	DA2J10100	1	223303R2	
D183 or	C-DIODE	1SS352	(1)	223234R2	
D183 or	C-DIODE	1SS355	(1)	223269R2	
D183 or	C-DIODE	MA2J111	(1)	223279R2	
D183 or	C-DIODE	KDS4148U	(1)	223283R2	
D601	C-DIODE	DA2J10100	1	223303R2	

D601 or	C-DIODE	ISS352	(1)	223234R2
D601 or	C-DIODE	ISS355	(1)	223269R2
D601 or	C-DIODE	MA2J111	(1)	223279R2
D601 or	C-DIODE	KDS4148U	(1)	223283R2
D602	C-DIODE	DA2J10100	1	223303R2
D602 or	C-DIODE	ISS352	(1)	223234R2
D602 or	C-DIODE	ISS355	(1)	223269R2
D602 or	C-DIODE	MA2J111	(1)	223279R2
D602 or	C-DIODE	KDS4148U	(1)	223283R2
D603	C-DIODE	DA2J10100	1	223303R2
D603 or	C-DIODE	ISS352	(1)	223234R2
D603 or	C-DIODE	ISS355	(1)	223269R2
D603 or	C-DIODE	MA2J111	(1)	223279R2
D603 or	C-DIODE	KDS4148U	(1)	223283R2
D701	C-DIODE	DA2J10100	1	223303R2
D701 or	C-DIODE	ISS352	(1)	223234R2
D701 or	C-DIODE	ISS355	(1)	223269R2
D701 or	C-DIODE	MA2J111	(1)	223279R2
D701 or	C-DIODE	KDS4148U	(1)	223283R2
D702	C-DIODE	DA2J10100	1	223303R2
D702 or	C-DIODE	ISS352	(1)	223234R2
D702 or	C-DIODE	ISS355	(1)	223269R2
D702 or	C-DIODE	MA2J111	(1)	223279R2
D702 or	C-DIODE	KDS4148U	(1)	223283R2
D8100	C-DIODE	DA2J10100	1	223303R2
D8100 or	C-DIODE	ISS352	(1)	223234R2
D8100 or	C-DIODE	ISS355	(1)	223269R2
D8100 or	C-DIODE	MA2J111	(1)	223279R2
D8100 or	C-DIODE	KDS4148U	(1)	223283R2
D8145	ESD D	AOZ8804ADI	1	225502R2
D8146	ESD D	AOZ8804ADI	1	225502R2
D8931	DIODE	RB050M-30	1	22380367R2
D8951	DIODE	RB050M-30	1	22380367R2
D8971	DIODE	RB050M-30	1	22380367R2

Q153	IC	R1EX25064ASA00A	1	22242581R2	
Q181	TR	KRC105S	1	2217290R2	
Q181 or	TR	RN1405	(1)	2214500R2	
Q3001	IC	D830K013BZKB400Z	1	22242694R3	N
Q3002	IC(DSP)	NAND256W3A2BN6E(0409)	1	222W0092R304096	
Q3003	IC	IS42S16160C-7TL	1	22242592R3	
Q3003 or	IC	EM63A165TSB-7G	(1)	22242751R3	N
Q3004	IC	IS42S16160C-7TL	1	22242592R3	
Q3004 or	IC	EM63A165TSB-7G	(1)	22242751R3	N
Q3005	IC	TC7W32FU	1	22241162R2	
Q3006	IC	S-80127CNMC-JKM-T2	1	22241642R2	
Q3007	IC	XC6220B501PR	1	22242692R2	
Q3008	IC	BU33TD3WG-TR	1	22242715R2	N
Q301	IC	PCM9211PTR	1	22242703R2	
Q302	IC	PCM1690DCAR	1	22242599R2	
Q304	IC	PCM1754DBQR	1	22242598R2	
Q3101	IC	TPD2E001DRLR	1	22242589R2	
Q3102	IC	BD82065FVJ	1	22242718R2	
Q3103	IC	BU18TD3WG-TR	1	22242716R2	
Q3105	IC	MFI341S2164	1	22242594R2	
Q3106	IC	BU33TD3WG-TR	1	22242715R2	N
Q3107	IC	BU33TD3WG-TR	1	22242715R2	N
Q3108	IC	KSZ8051RNL	1	22242723R2	N
Q3109	IC	XC6220B121PR	1	22242626R2	
Q3205	IC	TC7SZU04FU	1	22242512R2TO	
Q3210	IC	TC7WH241FU(Te12L_F)	1	22242076R2TO	
Q601	TR	KRC104S	1	2216210R2	
Q601 or	TR	RN1404	(1)	2214490R2	
Q701	IC(MIAN MICROPROCESSOR)	MPD70F3746GJ-GAE-AX(0408)	1	222W0079R304080	
Q702	IC	S-812C33AUA-C2N	1	22242222R2	
Q703	IC	S-812C56AUA-C3K	1	22242207R2	
Q704	IC	SN74CB3Q3305PWR	1	22242258R2	
Q751	TR	KRC104S	1	2216210R2	
Q751 or	TR	RN1404	(1)	2214490R2	

Q752	TR	KRA102S	1	2216220R2
Q752 or	TR	RN2402	(1)	2214530R2
Q753	TR	KRA107S	1	2216350R2
Q753 or	TR	RN2407(TE85L_F)	(1)	2216360R2
Q754	TR	KRC102S	1	2216190R2
Q754 or	TR	RN1402	(1)	2214470R2
Q755	TR	KRA107S	1	2216350R2
Q755 or	TR	RN2407(TE85L_F)	(1)	2216360R2
Q756	TR	KRC102S	1	2216190R2
Q756 or	TR	RN1402	(1)	2214470R2
Q761	TR	KRC104S	1	2216210R2
Q761 or	TR	RN1404	(1)	2214490R2
Q762	TR	KRA102S	1	2216220R2
Q762 or	TR	RN2402	(1)	2214530R2
Q771	TR	KRC104S	1	2216210R2
Q771 or	TR	RN1404	(1)	2214490R2
Q772	TR	KRA102S	1	2216220R2
Q772 or	TR	RN2402	(1)	2214530R2
Q8101	IC	ADV7623	1	22242625R3
Q8104	IC	MM3404A50NRE	1	22242701R2
Q8105	IC(HDMI/VIDEO)	W25Q16CVSSIG(0410)	1	222W0118R204105
Q8111	TR	KRC101S	1	2216330R2
Q8111 or	TR	RN1401(TE85L_F)	(1)	2214460R2
Q8112	TR	KRC101S	1	2216330R2
Q8112 or	TR	RN1401(TE85L_F)	(1)	2214460R2
Q8113	TR	KRC101S	1	2216330R2
Q8113 or	TR	RN1401(TE85L_F)	(1)	2214460R2
Q8114	TR	KRC101S	1	2216330R2
Q8114 or	TR	RN1401(TE85L_F)	(1)	2214460R2
Q8115	TR	KRC101S	1	2216330R2
Q8115 or	TR	RN1401(TE85L_F)	(1)	2214460R2
Q8116	TR	KRC101S	1	2216330R2
Q8116 or	TR	RN1401(TE85L_F)	(1)	2214460R2
Q8117	TR	KRC101S	1	2216330R2

Q8117 or	TR	RN1401(TE85L_F)	(1)	2214460R2
Q8118	TR	KRC101S	1	2216330R2
Q8118 or	TR	RN1401(TE85L_F)	(1)	2214460R2
Q8156	TR ARRAY	UM6K1N	1	226066R2
Q8931	IC	MP2363DN-LF-Z	1	22242627R2
Q8951	IC	MP2363DN-LF-Z	1	22242627R2
Q8971	IC	MP2363DN-LF-Z	1	22242627R2
Q8972	IC	BU18TD3WG-TR	1	22242716R2
[TRANS COIL]				
L153	CORE	BLM18PG181SN1D	1	2350005R1
L3001	CORE	BLM18PG121SN1D	1	2350006R1
L3002	CORE	BLM18PG121SN1D	1	2350006R1
L3003	CORE	BLM18PG121SN1D	1	2350006R1
L3004	CORE	BLM18PG121SN1D	1	2350006R1
L3005	CORE	BLM18PG121SN1D	1	2350006R1
L3006	CORE	BLM18PG181SN1D	1	2350005R1
L3007	CORE	BLM18PG181SN1D	1	2350005R1
L301	EMIFIL	BK1608LM182-T	1	230958R1
L302	EMIFIL	BK1608LM182-T	1	230958R1
L303	CHOKE COIL	LBC2518T4R7M	1	231364M047R2
L304	CHOKE COIL	LBC2518T4R7M	1	231364M047R2
L305	CHOKE COIL	LBC2518T4R7M	1	231364M047R2
L306	EMIFIL	BK1608LM182-T	1	230958R1
L3102	C-CARBON R	RN72K1J-000JE	1	435030004R1
L3103	CORE	BLM18PG121SN1D	1	2350006R1
L3104	CORE	BLM18PG121SN1D	1	2350006R1
L3105	CORE	BLM18PG121SN1D	1	2350006R1
L3106	CORE	BLM18PG121SN1D	1	2350006R1
L3107	CORE	BLM18PG121SN1D	1	2350006R1
L3108	CORE	BLM18PG121SN1D	1	2350006R1
L3109	CORE	BLM18PG121SN1D	1	2350006R1
L3110	CORE	BLM18PG121SN1D	1	2350006R1
L3145	CORE	DLP2ADN900HL4L	1	230990R2
L3203	CORE	MMZ1608Y601BT	1	2350004R1

L3205	CORE	BLM18PG181SN1D	1	2350005R1	
L3206	CORE	MMZ1608Y601BT	1	2350004R1	
L3207	CORE	MMZ1608Y601BT	1	2350004R1	
L3208	EMIFIL	BK1608LL241-T	1	230959R1	
L3209	CORE	MMZ1608Y601BT	1	2350004R1	
L370	CHOKE COIL	LBC2518T4R7M	1	231364M047R2	
L401	CHOKE COIL	LBC2518T4R7M	1	231364M047R2	
L402	CHOKE COIL	LBC2518T4R7M	1	231364M047R2	
L703	CORE	BLM18PG181SN1D	1	2350005R1	
L742	CORE	BLM18PG181SN1D	1	2350005R1	
L743	CORE	BLM18PG181SN1D	1	2350005R1	
L744	CORE	BLM18PG181SN1D	1	2350005R1	
L746	CORE	BLM18PG181SN1D	1	2350005R1	
L8101	EMIFIL	BK1608LM182-T	1	230958R1	
L8911	CORE	BLM18PG181SN1D	1	2350005R1	
L8912	CORE	BLM18PG181SN1D	1	2350005R1	
L8921	CORE	BLM18PG181SN1D	1	2350005R1	
L8922	CORE	BLM18PG181SN1D	1	2350005R1	
L8923	CORE	BLM18PG181SN1D	1	2350005R1	
L8931	CHOKE COIL	CDRH8D43_100	1	231371P100R2	N
L8931 or	CHOKE COIL	0182-7E08Q-100M-RA	(1)	231396M100R2	
L8931 or	CHOKE COIL	SWRH8D43C-100MT	(1)	231445M100R2	
L8932	CORE	BLM18PG181SN1D	1	2350005R1	
L8933	CORE	BLM18PG181SN1D	1	2350005R1	
L8934	CORE	BLM18PG181SN1D	1	2350005R1	
L8937	CORE	BLM18PG181SN1D	1	2350005R1	
L8938	CORE	BLM18PG181SN1D	1	2350005R1	
L8939	CORE	BLM18PG181SN1D	1	2350005R1	
L8951	CHOKE COIL	CDRH8D43_100	1	231371P100R2	N
L8951 or	CHOKE COIL	0182-7E08Q-100M-RA	(1)	231396M100R2	
L8951 or	CHOKE COIL	SWRH8D43C-100MT	(1)	231445M100R2	
L8952	CORE	BLM18PG181SN1D	1	2350005R1	
L8953	CORE	BLM18PG181SN1D	1	2350005R1	
L8954	CORE	BLM18PG181SN1D	1	2350005R1	

L8971	CHOKE COIL	CDRH8D43_100	1	231371P100R2	N
L8971 or	CHOKE COIL	0182-7E08Q-100M-RA	(1)	231396M100R2	
L8971 or	CHOKE COIL	SWRH8D43C-100MT	(1)	231445M100R2	
L8972	CORE	BLM18PG181SN1D	1	2350005R1	
L8973	CHOKE COIL	BLM21PG221SN1	1	230949R2	
L8974	CHOKE COIL	BLM21PG221SN1	1	230949R2	
X171	CRYSTAL	HC-49SMD24.576MHz+/-50ppm	1	3010494R2	
X3001	CRYSTAL	HC-49USSMD20.000MHz	1	3010504R2	
X3202	CRYSTAL	HC-49SMD11.2896MHz	1	3010480R2	
X501	CERA LOCK	CSTCR5M00G53-B0	1	3010356R2	
X8100	CRYSTAL	HC-49USSMD28.6363MHz	1	3010491R2	

[CAPACITOR]

C151	C-CERA C	CK725B1C-104K0	1	332011045R1	
C172	C-CERA C	CC725CH1H-150J0	1	342031504R1	
C173	C-CERA C	CC725CH1H-150J0	1	342031504R1	
C3001	C-CERA C	CK725B1A-105K0	1	332001055R1	
C3002	C-CERA C	CK725B1A-105K0	1	332001055R1	
C3003	C-CERA C	CK732B16V-106K	1	332071065R2	
C3004	C-CERA C	CK732B16V-106K	1	332071065R2	
C3005	C-CERA C	CK725B1A-105K0	1	332001055R1	
C3006	C-CERA C	CK725B1H-102K0	1	332031025R1	N
C3007	C-CERA C	CK725B1A-105K0	1	332001055R1	
C3008	C-CERA C	CK725B1H-102K0	1	332031025R1	N
C3009	C-CERA C	CK725B1A-105K0	1	332001055R1	
C3010	C-CERA C	CK725B1A-105K0	1	332001055R1	
C3011	C-CERA C	CK725B1A-105K0	1	332001055R1	
C3012	C-CERA C	CK725B1H-102K0	1	332031025R1	N
C3013	C-CERA C	CK725B1A-105K0	1	332001055R1	
C3014	C-CERA C	CK725B1H-102K0	1	332031025R1	N
C3015	C-CERA C	CK725B1H-102K0	1	332031025R1	N
C3016	C-CERA C	CK725B1A-105K0	1	332001055R1	
C3017	C-CERA C	CK725B1A-105K0	1	332001055R1	
C3018	C-CERA C	CK725B1A-105K0	1	332001055R1	
C3019	C-CERA C	CK725B1H-102K0	1	332031025R1	N

C3020	C-CERA C	CK725B1A-105K0	1	332001055R1	
C3021	C-CERA C	CK725B1A-105K0	1	332001055R1	
C3022	C-CERA C	CK725B1A-105K0	1	332001055R1	
C3023	C-CERA C	CK732B16V-106K	1	332071065R2	
C3024	C-CERA C	CK725B1H-102K0	1	332031025R1	N
C3025	C-CERA C	CK725B1A-105K0	1	332001055R1	
C3026	C-CERA C	CK725B1C-104K0	1	332011045R1	
C3027	C-CERA C	CK725B1H-102K0	1	332031025R1	N
C3028	C-CERA C	CK725B1A-105K0	1	332001055R1	
C3029	C-CERA C	CK725B1H-102K0	1	332031025R1	N
C3030	C-CERA C	CK725B1A-105K0	1	332001055R1	
C3031	C-CERA C	CK725B1A-105K0	1	332001055R1	
C3032	C-CERA C	CK725B1H-102K0	1	332031025R1	N
C3033	C-CERA C	CK725B1A-105K0	1	332001055R1	
C3034	C-CERA C	CC725CH1H-390J0	1	342033904R1	
C3035	C-CERA C	CK725B1H-102K0	1	332031025R1	N
C3036	C-CERA C	CC725CH1H-390J0	1	342033904R1	
C3037	C-CERA C	CK725B1A-105K0	1	332001055R1	
C3038	C-CERA C	CK725B1A-105K0	1	332001055R1	
C3039	C-CERA C	CK725B1C-103K0	1	332011035R1	
C3040	C-CERA C	CK725B1A-105K0	1	332001055R1	
C3041	C-CERA C	CK732B16V-106K	1	332071065R2	
C3042	C-CERA C	CK725B1A-105K0	1	332001055R1	
C3043	C-CERA C	CK725B1A-105K0	1	332001055R1	
C305	C-CERA C	CK725B1C-104K0	1	332011045R1	
C3051	C-CERA C	CK732B16V-106K	1	332071065R2	
C3052	C-CERA C	CK732B16V-106K	1	332071065R2	
C3053	C-CERA C	CK732B16V-106K	1	332071065R2	
C3056	C-CERA C	CK732B16V-106K	1	332071065R2	
C306	CHIP ELECT C	CEWX4V-220M	1	3981G2217R2	
C307	C-CERA C	CK725B1C-104K0	1	332011045R1	
C3101	CHIP ELECT C	CEWX16V-100M	1	398141017R2	
C3102	CHIP ELECT C	CEWX10V-220M	1	398132217R2	
C3103	C-CERA C	CK725B1H-102K0	1	332031025R1	N

C3104	C-CERA C	CK725B1A-105K0	1	332001055R1	
C3105	C-CERA C	CK725B1A-105K0	1	332001055R1	
C3106	C-CERA C	CK732B16V-106K	1	332071065R2	
C3107	C-CERA C	CK725B1A-105K0	1	332001055R1	
C3108	C-CERA C	CK725B1A-105K0	1	332001055R1	
C3109	C-CERA C	CK732B16V-106K	1	332071065R2	
C3110	C-CERA C	CK725B1A-224K0	1	332002245R1	N
C3112	C-CERA C	CK732B16V-106K	1	332071065R2	
C3113	C-CERA C	CK725B1A-105K0	1	332001055R1	
C3114	C-CERA C	CK725B1A-105K0	1	332001055R1	
C3115	C-CERA C	CK732B16V-106K	1	332071065R2	
C3116	C-CERA C	CK732B16V-106K	1	332071065R2	
C3117	C-CERA C	CK725B1H-102K0	1	332031025R1	N
C3118	C-CERA C	CK725B1A-105K0	1	332001055R1	
C3119	C-CERA C	CK725B1A-105K0	1	332001055R1	
C312	C-CERA C	CC725CH1H-221J0	1	342032214R1	
C3120	C-CERA C	CK732B16V-106K	1	332071065R2	
C3121	C-CERA C	CK725B1A-105K0	1	332001055R1	
C3122	C-CERA C	CK725B1A-105K0	1	332001055R1	
C3123	C-CERA C	CK725B1A-105K0	1	332001055R1	
C3124	C-CERA C	CK732B16V-106K	1	332071065R2	
C3125	C-CERA C	CK725B1A-105K0	1	332001055R1	
C3126	C-CERA C	CK732B16V-106K	1	332071065R2	
C3127	C-CERA C	CK725B1A-105K0	1	332001055R1	
C3128	C-CERA C	CK725B1A-105K0	1	332001055R1	
C3129	C-CERA C	CK725B1A-105K0	1	332001055R1	
C313	C-CERA C	CK725B1C-104K0	1	332011045R1	
C3130	C-CERA C	CK732B16V-106K	1	332071065R2	
C3131	C-CERA C	CK725B1A-105K0	1	332001055R1	
C3132	C-CERA C	CC725CH1H-101J0	1	342031014R1	
C3133	C-CERA C	CK725B1A-105K0	1	332001055R1	
C3136	C-CERA C	CK725B1A-105K0	1	332001055R1	
C3137	C-CERA C	CK725B1A-105K0	1	332001055R1	
C3138	C-CERA C	CK725B1A-105K0	1	332001055R1	

C3139	C-CERA C	CK725B1A-105K0	1	332001055R1	
C314	CHIP ELECT C	CEWX4V-220M	1	3981G2217R2	
C3140	C-CERA C	CK725B1A-105K0	1	332001055R1	
C3141	C-CERA C	CK725B1C-104K0	1	332011045R1	
C3142	C-CERA C	CK725B1A-105K0	1	332001055R1	
C3143	C-CERA C	CK725B1A-105K0	1	332001055R1	
C3144	C-CERA C	CK725B1A-105K0	1	332001055R1	
C3145	C-CERA C	CK732B16V-106K	1	332071065R2	
C3148	C-CERA C	CK725B1C-104K0	1	332011045R1	
C3149	C-CERA C	CK725B1H-102K0	1	332031025R1	N
C315	C-CERA C	CK725B1H-472K0	1	332034725R1	N
C3150	C-CERA C	CK732B16V-106K	1	332071065R2	
C3152	C-CERA C	CK732B16V-106K	1	332071065R2	
C3153	C-CERA C	CK732B16V-106K	1	332071065R2	
C3154	C-CERA C	CK725B1A-105K0	1	332001055R1	
C3155	C-CERA C	CK732B16V-106K	1	332071065R2	
C3156	C-CERA C	CK725B1A-105K0	1	332001055R1	
C3157	C-CERA C	CK725B1A-105K0	1	332001055R1	
C3158	C-CERA C	CK725B1A-105K0	1	332001055R1	
C3159	C-CERA C	CK725B1A-105K0	1	332001055R1	
C316	C-CERA C	CK725B1C-473K0	1	332014735R1	
C3160	C-CERA C	CK725B1A-105K0	1	332001055R1	
C3161	C-CERA C	CK725B1A-105K0	1	332001055R1	
C3162	C-CERA C	CK725B1H-102K0	1	332031025R1	N
C3163	C-CERA C	CK732B16V-106K	1	332071065R2	
C317	C-CERA C	CK725B1C-104K0	1	332011045R1	
C318	CHIP ELECT C	CEWX16V-100M	1	398141017R2	
C319	CHIP ELECT C	CEWX16V-47M	1	398144707R2	
C320	C-CERA C	CK725B1E-223K0	1	332022235R1	
C3206	C-CERA C	CK725B1A-105K0	1	332001055R1	
C3207	C-CERA C	CK732B16V-106K	1	332071065R2	
C3209	C-CERA C	CK725B1A-105K0	1	332001055R1	
C3220	C-CERA C	CC725CH1H-090D0	1	342030902R1	
C3223	C-CERA C	CC725CH1H-120J0	1	342031204R1	

C3226	C-CERA C	CK725B1A-105K0	1	332001055R1	
C351	CHIP ELECT C	CEWX4V-220M	1	3981G2217R2	
C352	C-CERA C	CK725B1C-104K0	1	332011045R1	
C353	CHIP ELECT C	CEWX16V-100M	1	398141017R2	
C354	C-CERA C	CK725B1C-104K0	1	332011045R1	
C355	C-CERA C	CK725B1C-104K0	1	332011045R1	
C356	CHIP ELECT C	CEWX16V-47M	1	398144707R2	
C370	C-CERA C	CK732B16V-106K	1	332071065R2	
C371	C-CERA C	CK725B1C-104K0	1	332011045R1	
C372	C-CERA C	CK725B1C-104K0	1	332011045R1	
C373	C-CERA C	CK732B16V-106K	1	332071065R2	
C501	C-CERA C	CK732B16V-106K	1	332071065R2	
C502	C-CERA C	CK725B1C-104K0	1	332011045R1	
C503	C-CERA C	CK725B1C-104K0	1	332011045R1	
C504	C-CERA C	CK725B1C-104K0	1	332011045R1	
C505	C-CERA C	CK725B1C-104K0	1	332011045R1	
C507	C-CERA C	CK725B1C-104K0	1	332011045R1	
C508	C-CERA C	CK725B1C-104K0	1	332011045R1	
C509	C-CERA C	CK732B16V-106K	1	332071065R2	
C511	C-CERA C	CK725B1H-102K0	1	332031025R1	N
C512	C-CERA C	CK725B1H-102K0	1	332031025R1	N
C513	C-CERA C	CC725CH1H-101J0	1	342031014R1	
C514	C-CERA C	CC725CH1H-101J0	1	342031014R1	
C515	C-CERA C	CC725CH1H-101J0	1	342031014R1	
C516	C-CERA C	CC725CH1H-101J0	1	342031014R1	
C517	C-CERA C	CK725B1C-104K0	1	332011045R1	
C518	C-CERA C	CK725B1H-102K0	1	332031025R1	N
C519	C-CERA C	CK725B1H-102K0	1	332031025R1	N
C520	C-CERA C	CK725B1H-102K0	1	332031025R1	N
C522	C-CERA C	CK725B1C-104K0	1	332011045R1	
C523	C-CERA C	CK725B1H-102K0	1	332031025R1	N
C524	C-CERA C	CK725B1H-102K0	1	332031025R1	N
C525	C-CERA C	CK725B1C-104K0	1	332011045R1	
C526	C-CERA C	CK725B1H-102K0	1	332031025R1	N

C527	C-CERA C	CK725B1H-102K0	1	332031025R1	N
C613	C-CERA C	CK732B1C-474K	1	337394745R1	
C705	C-CERA C	CK732B16V-106K	1	332071065R2	
C706	C-CERA C	CK732B16V-106K	1	332071065R2	
C707	C-CERA C	CK732B16V-106K	1	332071065R2	
C708	C-CERA C	CK732B16V-106K	1	332071065R2	
C709	C-CERA C	CK732B16V-106K	1	332071065R2	
C710	C-CERA C	CK725B1C-104K0	1	332011045R1	
C751	C-CERA C	CK725B1A-105K0	1	332001055R1	
C753	CHIP ELECT C	CEWT6.3V-470M	1	395724717R2	
C761	C-CERA C	CK725B1A-105K0	1	332001055R1	
C762	C-CERA C	CK732B1C-474K	1	337394745R1	
C771	C-CERA C	CK725B1A-105K0	1	332001055R1	
C772	C-CERA C	CK732B1C-474K	1	337394745R1	
C8100	C-CERA C	CK725B1H-102K0	1	332031025R1	N
C8103	C-CERA C	CK725B1C-104K0	1	332011045R1	
C8104	C-CERA C	CK725B1H-102K0	1	332031025R1	N
C8105	C-CERA C	CK725B1C-104K0	1	332011045R1	
C8106	C-CERA C	CK725B1H-102K0	1	332031025R1	N
C8107	C-CERA C	CK725B1C-104K0	1	332011045R1	
C8108	C-CERA C	CK725B1H-102K0	1	332031025R1	N
C8109	C-CERA C	CK725B1C-104K0	1	332011045R1	
C8110	C-CERA C	CK725B1H-102K0	1	332031025R1	N
C8111	C-CERA C	CK725B1C-104K0	1	332011045R1	
C8112	C-CERA C	CK725B1H-102K0	1	332031025R1	N
C8113	C-CERA C	CK725B1C-104K0	1	332011045R1	
C8114	C-CERA C	CK725B1H-102K0	1	332031025R1	N
C8115	C-CERA C	CK725B1C-104K0	1	332011045R1	
C8116	C-CERA C	CK725B1H-102K0	1	332031025R1	N
C8117	C-CERA C	CK725B1H-102K0	1	332031025R1	N
C8118	C-CERA C	CK725B1H-102K0	1	332031025R1	N
C8119	C-CERA C	CK725B1C-104K0	1	332011045R1	
C8120	C-CERA C	CK725B1H-102K0	1	332031025R1	N
C8121	C-CERA C	CK725B1C-104K0	1	332011045R1	

C8122	C-CERA C	CK725B1C-104K0	1	332011045R1	
C8123	CERA C	CC725CH1H-070C0	1	342030701R1	
C8124	C-CERA C	CK725B1H-102K0	1	332031025R1	N
C8125	C-CERA C	CK725B1H-102K0	1	332031025R1	N
C8126	C-CERA C	CK725B1C-104K0	1	332011045R1	
C8127	CERA C	CC725CH1H-070C0	1	342030701R1	
C8128	C-CERA C	CK725B1H-102K0	1	332031025R1	N
C8129	C-CERA C	CK725B1C-104K0	1	332011045R1	
C8130	C-CERA C	CK725B1H-102K0	1	332031025R1	N
C8131	C-CERA C	CK725B1H-102K0	1	332031025R1	N
C8132	C-CERA C	CK725B1H-102K0	1	332031025R1	N
C8133	C-CERA C	CK725B1C-104K0	1	332011045R1	
C8134	C-CERA C	CK725B1H-102K0	1	332031025R1	N
C8135	C-CERA C	CK725B1C-104K0	1	332011045R1	
C8136	C-CERA C	CK725B1H-102K0	1	332031025R1	N
C8137	C-CERA C	CK725B1C-104K0	1	332011045R1	
C8138	C-CERA C	CK725B1H-102K0	1	332031025R1	N
C8139	C-CERA C	CK725B1H-102K0	1	332031025R1	N
C8140	C-CERA C	CK725B1C-104K0	1	332011045R1	
C8141	C-CERA C	CK725B1H-102K0	1	332031025R1	N
C8142	C-CERA C	CK725B1C-104K0	1	332011045R1	
C8143	C-CERA C	CK725B1H-102K0	1	332031025R1	N
C8144	C-CERA C	CK725B1H-102K0	1	332031025R1	N
C8145	C-CERA C	CK725B1H-102K0	1	332031025R1	N
C8146	C-CERA C	CK725B1C-104K0	1	332011045R1	
C8147	C-CERA C	CK725B1H-102K0	1	332031025R1	N
C8148	C-CERA C	CK725B1C-104K0	1	332011045R1	
C8149	C-CERA C	CK725B1H-102K0	1	332031025R1	N
C8151	C-CERA C	CK725B1C-104K0	1	332011045R1	
C8152	C-CERA C	CK725B1H-102K0	1	332031025R1	N
C8153	C-CERA C	CK725B1C-104K0	1	332011045R1	
C8154	C-CERA C	CK725B1H-102K0	1	332031025R1	N
C8155	C-CERA C	CK725B1C-104K0	1	332011045R1	
C8156	C-CERA C	CK725B1H-102K0	1	332031025R1	N

C8158	C-CERA C	CK725B1C-104K0	1	332011045R1	
C8159	C-CERA C	CK725B1H-102K0	1	332031025R1	N
C8160	C-CERA C	CK725B1C-104K0	1	332011045R1	
C8161	C-CERA C	CK725B1H-102K0	1	332031025R1	N
C8162	C-CERA C	CK725B1C-104K0	1	332011045R1	
C8163	C-CERA C	CK725B1H-102K0	1	332031025R1	N
C8164	C-CERA C	CK725B1C-104K0	1	332011045R1	
C8165	C-CERA C	CK725B1H-102K0	1	332031025R1	N
C8166	C-CERA C	CK725B1H-102K0	1	332031025R1	N
C8168	C-CERA C	CK725B1H-102K0	1	332031025R1	N
C8170	C-CERA C	CK725B1C-104K0	1	332011045R1	
C8175	C-CERA C	CK725B1H-102K0	1	332031025R1	N
C8176	C-CERA C	CK725B1A-105K0	1	332001055R1	
C8177	C-CERA C	CK725B1A-105K0	1	332001055R1	
C8911	C-CERA C	CK732B16V-106K	1	332071065R2	
C8921	C-CERA C	CK732B16V-106K	1	332071065R2	
C8922	C-CERA C	CK732B16V-106K	1	332071065R2	
C8926	C-CERA C	CK725B1A-105K0	1	332001055R1	
C8928	C-CERA C	CK725B1E-223K0	1	332022235R1	
C8931	C-CERA C	CK725B1E-106K	1	332221065R2	
C8932	C-CERA C	CK725B1E-106K	1	332221065R2	
C8933	C-CERA C	CK732B16V-106K	1	332071065R2	
C8934	C-CERA C	CK732B16V-106K	1	332071065R2	
C8935	C-CERA C	CK732B16V-106K	1	332071065R2	
C8936	CHIP ELECT C	CEWX16V-100M	1	398141017R2	
C8937	C-CERA C	CK725B1C-104K0	1	332011045R1	
C8939	C-CERA C	CK725B1C-104K0	1	332011045R1	
C8940	C-CERA C	CK725B1C-103K0	1	332011035R1	
C8950	CHIP ELECT C	CEWX16V-100M	1	398141017R2	
C8951	C-CERA C	CK725B1E-106K	1	332221065R2	
C8952	C-CERA C	CK725B1E-106K	1	332221065R2	
C8953	C-CERA C	CK732B16V-106K	1	332071065R2	
C8954	C-CERA C	CK732B16V-106K	1	332071065R2	
C8955	C-CERA C	CK732B16V-106K	1	332071065R2	

C8956	CHIP ELECT C	CEWX16V-100M	1	398141017R2
C8957	C-CERA C	CK725B1C-104K0	1	332011045R1
C8958	C-CERA C	CK725B1E-223K0	1	332022235R1
C8959	C-CERA C	CK725B1C-104K0	1	332011045R1
C8960	C-CERA C	CK725B1C-103K0	1	332011035R1
C8963	C-CERA C	CC725CH1H-151J0	1	342031514R1
C8971	C-CERA C	CK725B1E-106K	1	332221065R2
C8972	C-CERA C	CK725B1E-106K	1	332221065R2
C8973	C-CERA C	CK732B16V-106K	1	332071065R2
C8974	C-CERA C	CK732B16V-106K	1	332071065R2
C8975	C-CERA C	CK732B16V-106K	1	332071065R2
C8976	CHIP ELECT C	CEWX16V-100M	1	398141017R2
C8977	C-CERA C	CK725B1C-104K0	1	332011045R1
C8978	C-CERA C	CK725B1E-223K0	1	332022235R1
C8979	C-CERA C	CK725B1C-104K0	1	332011045R1
C8980	C-CERA C	CK725B1E-682K0	1	332026825R1
C8983	C-CERA C	CK725B1A-105K0	1	332001055R1
C8984	C-CERA C	CK725B1A-105K0	1	332001055R1
C8985	C-CERA C	CK725B1A-105K0	1	332001055R1
C8986	C-CERA C	CK725B1A-105K0	1	332001055R1
C8987	C-CERA C	CK725B1A-105K0	1	332001055R1
C8988	C-CERA C	CK725B1A-105K0	1	332001055R1

[RESISTOR]

R110	C-CARBON R	RN72K1J-103JE	1	435031034R1
R151	C-CARBON R	RN72K1J-103JE	1	435031034R1
R152	C-CARBON R	RN72K1J-103JE	1	435031034R1
R154	C-CARBON R	RN72K1J-103JE	1	435031034R1
R3009	C-CARBON R	RN72K1J-330JE	1	435033304R1
R301	C-CARBON R	RN72K1J-470JE	1	435034704R1
R3010	C-R NET	RM7LJ330X04	1	43484733004R2
R3011	C-R NET	RM7LJ330X04	1	43484733004R2
R3012	C-R NET	RM7LJ470X04	1	43484747004R2
R3013	C-R NET	RM7LJ330X04	1	43484733004R2
R3014	C-R NET	RM7LJ330X04	1	43484733004R2

R3015	C-R NET	RM7LJ330X04	1	43484733004R2
R3016	C-CARBON R	RN72K1J-470JE	1	435034704R1
R3017	C-R NET	RM7LJ330X04	1	43484733004R2
R3018	C-CARBON R	RN72K1J-470JE	1	435034704R1
R3019	C-R NET	RM7LJ330X04	1	43484733004R2
R302	C-CARBON R	RN72K1J-151JE	1	435031514R1
R3020	C-R NET	RM7LJ330X04	1	43484733004R2
R3021	C-CARBON R	RN72K1J-470JE	1	435034704R1
R3022	C-CARBON R	RN72K1J-470JE	1	435034704R1
R3023	C-R NET	RM7LJ470X04	1	43484747004R2
R3024	C-CARBON R	RN72K1J-470JE	1	435034704R1
R3025	C-CARBON R	RN72K1J-102JE	1	435031024R1
R3028	C-CARBON R	RN72K1J-470JE	1	435034704R1
R3029	C-CARBON R	RN72K1J-102JE	1	435031024R1
R303	C-CARBON R	RN72K1J-221JE	1	435032214R1
R3032	C-CARBON R	RN72K1J-103JE	1	435031034R1
R3033	C-CARBON R	RN72K1J-470JE	1	435034704R1
R3034	C-CARBON R	RN72K1J-470JE	1	435034704R1
R3035	C-CARBON R	RN72K1J-470JE	1	435034704R1
R3036	C-CARBON R	RN72K1J-470JE	1	435034704R1
R3037	C-CARBON R	RN72K1J-470JE	1	435034704R1
R3038	C-CARBON R	RN72K1J-470JE	1	435034704R1
R3039	C-CARBON R	RN72K1J-470JE	1	435034704R1
R304	C-CARBON R	RN72K1J-221JE	1	435032214R1
R3040	C-CARBON R	RN72K1J-103JE	1	435031034R1
R3041	C-R NET	RM7LJ330X04	1	43484733004R2
R3042	C-R NET	RM7LJ330X04	1	43484733004R2
R3043	C-CARBON R	RN72K1J-000JE	1	435030004R1
R3044	C-R NET	RM7LJ330X04	1	43484733004R2
R3045	C-R NET	RM7LJ330X04	1	43484733004R2
R3047	C-CARBON R	RN72K1J-560JE	1	435035604R1
R3048	C-CARBON R	RN72K1J-221JE	1	435032214R1
R3049	C-CARBON R	RN72K1J-560JE	1	435035604R1
R305	C-CARBON R	RN72K1J-221JE	1	435032214R1

R3050	C-CARBON R	RN72K1J-560JE	1	435035604R1
R3051	C-CARBON R	RN72K1J-560JE	1	435035604R1
R3054	C-CARBON R	RN72K1J-103JE	1	435031034R1
R3056	C-CARBON R	RN72K1J-472JE	1	435034724R1
R306	C-CARBON R	RN72K1J-330JE	1	435033304R1
R3060	C-CARBON R	RN72K1J-680JE	1	435036804R1
R3061	C-CARBON R	RN72K1J-470JE	1	435034704R1
R3062	C-CARBON R	RN72K1J-680JE	1	435036804R1
R3063	C-CARBON R	RN72K1J-680JE	1	435036804R1
R3064	C-CARBON R	RN72K1J-680JE	1	435036804R1
R3065	C-CARBON R	RN72K1J-680JE	1	435036804R1
R3066	C-CARBON R	RN72K1J-102JE	1	435031024R1
R307	C-CARBON R	RN72K1J-331JE	1	435033314R1
R308	C-CARBON R	RN72K1J-331JE	1	435033314R1
R3101	C-CARBON R	RN72K1J-103JE	1	435031034R1
R3102	C-CARBON R	RN72K1J-103JE	1	435031034R1
R3105	C-CARBON R	RN72K1J-222JE	1	435032224R1
R3106	C-CARBON R	RN72K1J-102JE	1	435031024R1
R3108	C-CARBON R	RN72K1J-103JE	1	435031034R1
R3110	C-CARBON R	RN72K1J-103JE	1	435031034R1
R3111	C-CARBON R	RN72K1J-103JE	1	435031034R1
R3113	C-CARBON R	RN72K1J-103JE	1	435031034R1
R3115	C-CARBON R	RN72K1J-332JE	1	435033324R1
R3117	C-CARBON R	RN72K1J-332JE	1	435033324R1
R3119	C-CARBON R	RN72K1J-332JE	1	435033324R1
R312	C-CARBON R	RN72K1J-470JE	1	435034704R1
R3121	C-CARBON R	RN72K1J-103JE	1	435031034R1
R3122	C-CARBON R	RN72K1J-102JE	1	435031024R1
R3123	C-CARBON R	RN72K1J-000JE	1	435030004R1
R3124	C-CARBON R	RN72K1J-331JE	1	435033314R1
R3125	C-CARBON R	RN72K1J-470JE	1	435034704R1
R3126	C-CARBON R	RN72K1J-470JE	1	435034704R1
R3127	C-CARBON R	RN72K1J-470JE	1	435034704R1
R3128	C-CARBON R	RN72K1J-472JE	1	435034724R1

R3129	C-CARBON R	RN72K1J-470JE	1	435034704R1
R313	C-CARBON R	RN72K1J-470JE	1	435034704R1
R3130	C-CARBON R	RN72K1J-470JE	1	435034704R1
R3131	C-CARBON R	RN72K1J-470JE	1	435034704R1
R3133	C-CARBON R	RN72K1J-470JE	1	435034704R1
R3134	C-CARBON R	RN72K1J-103JE	1	435031034R1
R3135	C-CARBON R	RN72K1J-103JE	1	435031034R1
R3136	C-CARBON R	RN72K1J-000JE	1	435030004R1
R3137	C-CARBON R	RN72K1J-000JE	1	435030004R1
R3139	C-CARBON R	RN72K1J-101JE	1	435031014R1
R314	C-CARBON R	RN72K1J-151JE	1	435031514R1
R3143	C-CARBON R	RN72K1J-392JE	1	435033924R1
R3144	C-CARBON R	RN72K1J-101JE	1	435031014R1
R3145	C-CARBON R	RN72K1J-392JE	1	435033924R1
R3146	C-CARBON R	RN72K1J-390JE	1	435033904R1
R3147	C-CARBON R	RN72K1J-000JE	1	435030004R1
R3148	C-CARBON R	RN72K1J-390JE	1	435033904R1
R3149	C-CARBON R	RN72K1J-102JE	1	435031024R1
R315	C-CARBON R	RN72K1J-151JE	1	435031514R1
R3150	C-CARBON R	RN72K1J-680JE	1	435036804R1
R3151	C-CARBON R	RN72K1J-000JE	1	435030004R1
R3152	C-CARBON R	RN72K1J-000JE	1	435030004R1
R3154	C-CARBON R	RN72K1J-390JE	1	435033904R1
R3155	C-CARBON R	RN72K1J-390JE	1	435033904R1
R3156	C-CARBON R	RN72K1J-390JE	1	435033904R1
R3157	C-CARBON R	RN72K1J-000JE	1	435030004R1
R3158	C-CARBON R	RN72K1J-000JE	1	435030004R1
R316	C-CARBON R	RN72K1J-470JE	1	435034704R1
R3162	C-CARBON R	RN72K1J-390JE	1	435033904R1
R3163	C-CARBON R	RN72K1J-220JE	1	435032204R1
R3164	C-CARBON R	RN72K1J-472JE	1	435034724R1
R3168	C-CARBON R	RN72K1J-220JE	1	435032204R1
R3169	C-CARBON R	RN72K1J-220JE	1	435032204R1
R317	C-CARBON R	RN72K1J-331JE	1	435033314R1

R3170	C-CARBON R	RN72KIJ-391FE	1	435033912R1
R3171	C-CARBON R	RN72KIJ-222FE	1	435032222R1
R3172	C-CARBON R	RN72KIJ-392FE	1	435033922R1
R3173	C-CARBON R	RN72KIJ-390JE	1	435033904R1
R3174	C-CARBON R	RN72KIJ-390JE	1	435033904R1
R3175	C-CARBON R	RN72KIJ-472JE	1	435034724R1
R3181	C-CARBON R	RN72KIJ-470JE	1	435034704R1
R3182	C-CARBON R	RN72KIJ-472JE	1	435034724R1
R3183	C-CARBON R	RN72KIJ-470JE	1	435034704R1
R3184	C-CARBON R	RN72KIJ-470JE	1	435034704R1
R3185	C-CARBON R	RN72KIJ-332JE	1	435033324R1
R3187	C-CARBON R	RN72KIJ-472JE	1	435034724R1
R3192	C-CARBON R	RN72KIJ-472JE	1	435034724R1
R3193	C-CARBON R	RN72KIJ-472JE	1	435034724R1
R3194	C-CARBON R	RN72KIJ-472JE	1	435034724R1
R3199	C-CARBON R	RN72KIJ-102JE	1	435031024R1
R3203	C-CARBON R	RN72KIJ-103JE	1	435031034R1
R3204	C-CARBON R	RN72KIJ-103JE	1	435031034R1
R3205	C-CARBON R	RN72KIJ-103JE	1	435031034R1
R3208	C-CARBON R	RN72KIJ-271JE	1	435032714R1
R321	C-CARBON R	RN72KIJ-331JE	1	435033314R1
R3212	C-CARBON R	RN72KIJ-220JE	1	435032204R1
R3215	C-CARBON R	RN72KIJ-221JE	1	435032214R1
R3218	C-CARBON R	RN72KIJ-220JE	1	435032204R1
R3219	C-CARBON R	RN72KIJ-221JE	1	435032214R1
R322	C-CARBON R	RN72KIJ-331JE	1	435033314R1
R3221	C-CARBON R	RN72KIJ-470JE	1	435034704R1
R3225	C-CARBON R	RN72KIJ-220JE	1	435032204R1
R3226	C-R NET	RM7LJ470X04	1	43484747004R2
R3227	C-CARBON R	RN72KIJ-470JE	1	435034704R1
R3229	C-CARBON R	RN72KIJ-470JE	1	435034704R1
R323	C-CARBON R	RN72KIJ-331JE	1	435033314R1
R3230	C-CARBON R	RN72KIJ-221JE	1	435032214R1
R3232	C-CARBON R	RN72KIJ-221JE	1	435032214R1

R3236	C-CARBON R	RN72KIJ-470JE	1	435034704R1
R3237	C-CARBON R	RN72KIJ-221JE	1	435032214R1
R3239	C-CARBON R	RN72KIJ-221JE	1	435032214R1
R324	C-CARBON R	RN72KIJ-331JE	1	435033314R1
R3240	C-CARBON R	RN72KIJ-103JE	1	435031034R1
R3241	C-CARBON R	RN72KIJ-221JE	1	435032214R1
R3242	C-CARBON R	RN72KIJ-221JE	1	435032214R1
R3244	C-CARBON R	RN72KIJ-470JE	1	435034704R1
R3247	C-CARBON R	RN72KIJ-121JE	1	435031214R1
R325	C-CARBON R	RN72KIJ-331JE	1	435033314R1
R3251	C-CARBON R	RN72KIJ-470JE	1	435034704R1
R3254	C-CARBON R	RN72KIJ-470JE	1	435034704R1
R3255	C-CARBON R	RN72KIJ-103JE	1	435031034R1
R3257	C-CARBON R	RN72KIJ-470JE	1	435034704R1
R326	C-CARBON R	RN72KIJ-331JE	1	435033314R1
R3260	C-CARBON R	RN72KIJ-390JE	1	435033904R1
R3262	C-CARBON R	RN72KIJ-221JE	1	435032214R1
R3264	C-CARBON R	RN72KIJ-470JE	1	435034704R1
R3265	C-CARBON R	RN72KIJ-390JE	1	435033904R1
R3267	C-CARBON R	RN72KIJ-470JE	1	435034704R1
R3268	C-CARBON R	RN72KIJ-390JE	1	435033904R1
R327	C-CARBON R	RN72KIJ-221JE	1	435032214R1
R3271	C-CARBON R	RN72KIJ-390JE	1	435033904R1
R3272	C-CARBON R	RN72KIJ-470JE	1	435034704R1
R3274	C-CARBON R	RN72KIJ-390JE	1	435033904R1
R3276	C-CARBON R	RN72KIJ-470JE	1	435034704R1
R3277	C-CARBON R	RN72KIJ-220JE	1	435032204R1
R3278	C-CARBON R	RN72KIJ-470JE	1	435034704R1
R3280	C-CARBON R	RN72KIJ-470JE	1	435034704R1
R3283	C-CARBON R	RN72KIJ-103JE	1	435031034R1
R3284	C-CARBON R	RN72KIJ-103JE	1	435031034R1
R3291	C-CARBON R	RN72KIJ-105JE	1	435031054R1
R3294	C-CARBON R	RN72KIJ-561FE	1	435035612R1
R3295	C-CARBON R	RN72KIJ-560JE	1	435035604R1

R331	C-CARBON R	RN72KIJ-221JE	1	435032214R1
R3311	C-CARBON R	RN72KIJ-471JE	1	435034714R1
R3313	C-CARBON R	RN72KIJ-181JE	1	435031814R1
R3314	C-CARBON R	RN72KIJ-391JE	1	435033914R1
R3315	C-CARBON R	RN72KIJ-181JE	1	435031814R1
R332	C-CARBON R	RN72KIJ-681JE	1	435036814R1
R333	C-CARBON R	RN72KIJ-221JE	1	435032214R1
R350	C-CARBON R	RN72KIJ-331JE	1	435033314R1
R351	C-CARBON R	RN72KIJ-331JE	1	435033314R1
R352	C-CARBON R	RN72KIJ-331JE	1	435033314R1
R354	C-CARBON R	RN72KIJ-221JE	1	435032214R1
R355	C-CARBON R	RN72KIJ-220JE	1	435032204R1
R356	C-CARBON R	RN72KIJ-220JE	1	435032204R1
R357	C-CARBON R	RN72KIJ-220JE	1	435032204R1
R358	C-CARBON R	RN72KIJ-220JE	1	435032204R1
R359	C-CARBON R	RN72KIJ-220JE	1	435032204R1
R360	C-CARBON R	RN72KIJ-220JE	1	435032204R1
R361	C-CARBON R	RN72KIJ-331JE	1	435033314R1
R362	C-CARBON R	RN72KIJ-472JE	1	435034724R1
R3670	C-CARBON R	RN72KIJ-103JE	1	435031034R1
R371	C-CARBON R	RN72KIJ-331JE	1	435033314R1
R372	C-CARBON R	RN72KIJ-151JE	1	435031514R1
R373	C-CARBON R	RN72KIJ-151JE	1	435031514R1
R374	C-CARBON R	RN72KIJ-151JE	1	435031514R1
R375	C-CARBON R	RN72KIJ-151JE	1	435031514R1
R501	C-CARBON R	RN72KIJ-473JE	1	435034734R1
R503	C-CARBON R	RN72KIJ-103JE	1	435031034R1
R504	C-CARBON R	RN72KIJ-000JE	1	435030004R1
R505	C-CARBON R	RN72KIJ-103JE	1	435031034R1
R506	C-CARBON R	RN72KIJ-221JE	1	435032214R1
R508	C-CARBON R	RN72KIJ-105JE	1	435031054R1
R509	C-CARBON R	RN72KIJ-221JE	1	435032214R1
R510	C-CARBON R	RN72KIJ-470JE	1	435034704R1
R511	C-CARBON R	RN72KIJ-103JE	1	435031034R1

R512	C-CARBON R	RN72K1J-221JE	1	435032214R1
R514	C-CARBON R	RN72K1J-221JE	1	435032214R1
R515	C-R NET	RM7LJ470X04	1	43484747004R2
R520	C-CARBON R	RN72K1J-103JE	1	435031034R1
R521	C-R NET	RM7LJ470X04	1	43484747004R2
R527	C-CARBON R	RN72K1J-103JE	1	435031034R1
R528	C-CARBON R	RN72K1J-103JE	1	435031034R1
R532	C-CARBON R	RN72K1J-472JE	1	435034724R1
R533	C-CARBON R	RN72K1J-472JE	1	435034724R1
R534	C-R NET	RM7LJ103X04	1	43484710304R2
R538	C-CARBON R	RN72K1J-103JE	1	435031034R1
R539	C-R NET	RM7LJ470X04	1	43484747004R2
R543	C-CARBON R	RN72K1J-103JE	1	435031034R1
R544	C-R NET	RM7LJ221X04	1	43484722104R2
R545	C-CARBON R	RN72K1J-470JE	1	435034704R1
R546	C-CARBON R	RN72K1J-470JE	1	435034704R1
R550	C-R NET	RM7LJ470X04	1	43484747004R2
R551	C-CARBON R	RN72K1J-103JE	1	435031034R1
R552	C-CARBON R	RN72K1J-103JE	1	435031034R1
R554	C-CARBON R	RN72K1J-103JE	1	435031034R1
R555	C-CARBON R	RN72K1J-272JE	1	435032724R1
R557	C-CARBON R	RN72K1J-103JE	1	435031034R1
R558	C-CARBON R	RN72K1J-470JE	1	435034704R1
R559	C-CARBON R	RN72K1J-272JE	1	435032724R1
R565	C-CARBON R	RN72K1J-470JE	1	435034704R1
R566	C-CARBON R	RN72K1J-103JE	1	435031034R1
R567	C-CARBON R	RN72K1J-470JE	1	435034704R1
R568	C-CARBON R	RN72K1J-103JE	1	435031034R1
R569	C-CARBON R	RN72K1J-102JE	1	435031024R1
R570	C-CARBON R	RN72K1J-273JE	1	435032734R1
R571	C-CARBON R	RN72K1J-102JE	1	435031024R1
R573	C-CARBON R	RN72K1J-221JE	1	435032214R1
R574	C-R NET	RM7LJ470X04	1	43484747004R2
R579	C-CARBON R	RN72K1J-470JE	1	435034704R1

R580	C-R NET	RM7LJ103X04	1	43484710304R2
R582	C-R NET	RM7LJ221X04	1	43484722104R2
R588	C-CARBON R	RN72K1J-103JE	1	435031034R1
R591	C-CARBON R	RN72K1J-470JE	1	435034704R1
R592	C-CARBON R	RN72K1J-470JE	1	435034704R1
R593	C-CARBON R	RN72K1J-221JE	1	435032214R1
R594	C-CARBON R	RN72K1J-221JE	1	435032214R1
R597	C-CARBON R	RN72K1J-470JE	1	435034704R1
R601	C-CARBON R	RN72K1J-221JE	1	435032214R1
R609	C-CARBON R	RN72K1J-102JE	1	435031024R1
R610	C-CARBON R	RN72K1J-221JE	1	435032214R1
R611	C-CARBON R	RN72K1J-102JE	1	435031024R1
R613	C-CARBON R	RN72K1J-102JE	1	435031024R1
R614	C-CARBON R	RN72K1J-103JE	1	435031034R1
R616	C-CARBON R	RN72K1J-103JE	1	435031034R1
R617	C-CARBON R	RN72K1J-221JE	1	435032214R1
R618	C-CARBON R	RN72K1J-103JE	1	435031034R1
R619	C-CARBON R	RN72K1J-470JE	1	435034704R1
R620	C-CARBON R	RN72K1J-103JE	1	435031034R1
R621	C-CARBON R	RN72K1J-221JE	1	435032214R1
R622	C-CARBON R	RN72K1J-470JE	1	435034704R1
R623	C-CARBON R	RN72K1J-103JE	1	435031034R1
R625	C-CARBON R	RN72K1J-470JE	1	435034704R1
R626	C-CARBON R	RN72K1J-103JE	1	435031034R1
R631	C-R NET	RM7LJ470X04	1	43484747004R2
R633	C-CARBON R	RN72K1J-103JE	1	435031034R1
R635	C-CARBON R	RN72K1J-103JE	1	435031034R1
R638	C-R NET	RM7LJ470X04	1	43484747004R2
R643	C-CARBON R	RN72K1J-103JE	1	435031034R1
R645	C-CARBON R	RN72K1J-221JE	1	435032214R1
R646	C-R NET	RM7LJ221X04	1	43484722104R2
R650	C-CARBON R	RN72K1J-221JE	1	435032214R1
R651	C-CARBON R	RN72K1J-103JE	1	435031034R1
R652	C-CARBON R	RN72K1J-102JE	1	435031024R1

R653	C-CARBON R	RN72K1J-105JE	1	435031054R1	
R655	C-CARBON R	RN72K1J-223JE	1	435032234R1	
R656	C-CARBON R	RN72K1J-223JE	1	435032234R1	
R657	C-CARBON R	RN72K1J-224JE	1	435032244R1	
R658	C-CARBON R	RN72K1J-221JE	1	435032214R1	
R659	C-CARBON R	RN72K1J-273JE	1	435032734R1	
R660	C-CARBON R	RN72K1J-221JE	1	435032214R1	
R661	C-CARBON R	RN72K1J-221JE	1	435032214R1	
R662	C-CARBON R	RN72K1J-000JE	1	435030004R1	<MDC, MDD, MDF, MMK, MMQ, MMR, MPA, MPB, MPP>
R664	C-CARBON R	RN72K1J-000JE	1	435030004R1	<MDC, MDD, MDF, MMK, MMQ, MMR, MPA, MPB, MPP>
R666	C-CARBON R	RN72K1J-103JE	1	435031034R1	<MDC, MDD, MDF, MMK, MMQ, MMR, MPA, MPB, MPP>
R667	C-CARBON R	RN72K1J-103JE	1	435031034R1	<MDC, MDD, MDF, MMK, MMQ, MMR, MPA, MPB, MPP>
R668	C-CARBON R	RN72K1J-103JE	1	435031034R1	<MDC, MDD, MDF>
R669	C-CARBON R	RN72K1J-103JE	1	435031034R1	<MPP, MMK, MMQ, MMR, MPA, MPB>
R669	C-CARBON R	RN72K1J-333JE	1	435033334R1	<MDC, MDD, MDF>
R670	C-CARBON R	RN72K1J-472JE	1	435034724R1	
R671	C-CARBON R	RN72K1J-272JE	1	435032724R1	
R672	C-CARBON R	RN72K1J-472JE	1	435034724R1	
R673	C-CARBON R	RN72K1J-272JE	1	435032724R1	
R674	C-CARBON R	RN72K1J-472JE	1	435034724R1	
R675	C-CARBON R	RN72K1J-272JE	1	435032724R1	
R676	C-CARBON R	RN72K1J-472JE	1	435034724R1	
R677	C-CARBON R	RN72K1J-272JE	1	435032724R1	
R678	C-CARBON R	RN72K1J-224JE	1	435032244R1	
R679	C-CARBON R	RN72K1J-224JE	1	435032244R1	
R681	C-CARBON R	RN72K1J-473JE	1	435034734R1	
R682	C-CARBON R	RN72K1J-103JE	1	435031034R1	
R687	C-CARBON R	RN72K1J-103JE	1	435031034R1	
R688	C-R NET	RM7LJ103X04	1	43484710304R2	
R692	C-R NET	RM7LJ472X04	1	43484747204R2	
R693	C-R NET	RM7LJ470X04	1	43484747004R2	
R701	C-CARBON R	RN72K1J-000JE	1	435030004R1	
R712	C-CARBON R	RN72K1J-102JE	1	435031024R1	
R713	C-CARBON R	RN72K1J-222JE	1	435032224R1	

R714	C-CARBON R	RN72KIJ-103JE	1	435031034R1
R721	C-CARBON R	RN72KIJ-103JE	1	435031034R1
R723	C-CARBON R	RN72KIJ-101JE	1	435031014R1
R724	C-CARBON R	RN72KIJ-101JE	1	435031014R1
R725	C-CARBON R	RN72KIJ-221JE	1	435032214R1
R726	C-CARBON R	RN72KIJ-273JE	1	435032734R1
R727	C-CARBON R	RN72KIJ-103JE	1	435031034R1
R761	C-CARBON R	RN72KIJ-103JE	1	435031034R1
R762	C-CARBON R	RN72KIJ-222JE	1	435032224R1
R763	C-CARBON R	RN72KIJ-102JE	1	435031024R1
R771	C-CARBON R	RN72KIJ-103JE	1	435031034R1
R772	C-CARBON R	RN72KIJ-222JE	1	435032224R1
R773	C-CARBON R	RN72KIJ-102JE	1	435031024R1
R8100	C-CARBON R	RN72KIJ-102JE	1	435031024R1
R8101	C-CARBON R	RN72KIJ-000JE	1	435030004R1
R8102	C-CARBON R	RN72KIJ-473JE	1	435034734R1
R8103	C-CARBON R	RN72KIJ-473JE	1	435034734R1
R8110	C-CARBON R	RN72KIJ-000JE	1	435030004R1
R8118	C-CARBON R	RN72KIJ-102JE	1	435031024R1
R8119	C-CARBON R	RN72KIJ-102JE	1	435031024R1
R8120	C-CARBON R	RN72KIJ-000JE	1	435030004R1
R8121	C-CARBON R	RN72KIJ-102JE	1	435031024R1
R8122	C-CARBON R	RN72KIJ-473JE	1	435034734R1
R8123	C-CARBON R	RN72KIJ-473JE	1	435034734R1
R8125	C-CARBON R	RN72KIJ-101JE	1	435031014R1
R8126	C-CARBON R	RN72KIJ-101JE	1	435031014R1
R8127	C-CARBON R	RN72KIJ-330JE	1	435033304R1
R8128	C-CARBON R	RN72KIJ-331JE	1	435033314R1
R8129	C-CARBON R	RN72KIJ-330JE	1	435033304R1
R8131	C-R NET	RM7LJ330X04	1	43484733004R2
R8132	C-R NET	RM7LJ101X04	1	43484710104R2
R8133	C-CARBON R	RN72KIJ-103JE	1	435031034R1
R8136	C-CARBON R	RN72KIJ-102JE	1	435031024R1
R8138	C-CARBON R	RN72KIJ-000JE	1	435030004R1

R8139	C-CARBON R	RN72KIJ-103JE	1	435031034R1
R8140	C-CARBON R	RN72KIJ-473JE	1	435034734R1
R8141	C-CARBON R	RN72KIJ-473JE	1	435034734R1
R8142	C-CARBON R	RN72KIJ-220JE	1	435032204R1
R8148	C-CARBON R	RN72KIJ-473JE	1	435034734R1
R8150	C-R NET	RM7LJ470X04	1	43484747004R2
R8154	C-R NET	RM7LJ220X04	1	43484722004R2
R8158	C-CARBON R	RN72KIJ-473JE	1	435034734R1
R8159	C-CARBON R	RN72KIJ-182JE	1	435031824R1
R8160	C-CARBON R	RN72KIJ-182JE	1	435031824R1
R8161	C-CARBON R	RN72KIJ-821FE	1	435038212R1
R8162	C-CARBON R	RN72KIJ-680JE	1	435036804R1
R8166	C-CARBON R	RN72KIJ-102JE	1	435031024R1
R8167	C-CARBON R	RN72KIJ-000JE	1	435030004R1
R8169	C-CARBON R	RN72KIJ-473JE	1	435034734R1
R8170	C-CARBON R	RN72KIJ-473JE	1	435034734R1
R8172	C-CARBON R	RN72KIJ-103JE	1	435031034R1
R8173	C-CARBON R	RN72KIJ-000JE	1	435030004R1
R8174	C-CARBON R	RN72KIJ-473JE	1	435034734R1
R8176	C-CARBON R	RN72KIJ-000JE	1	435030004R1
R8177	C-CARBON R	RN72KIJ-101JE	1	435031014R1
R8178	C-CARBON R	RN72KIJ-101JE	1	435031014R1
R8179	C-CARBON R	RN72KIJ-101JE	1	435031014R1
R8180	C-CARBON R	RN72KIJ-101JE	1	435031014R1
R8181	C-CARBON R	RN72KIJ-100JE	1	435031004R1
R8182	C-CARBON R	RN72KIJ-100JE	1	435031004R1
R8191	C-CARBON R	RN72KIJ-103JE	1	435031034R1
R8192	C-CARBON R	RN72KIJ-103JE	1	435031034R1
R8193	C-CARBON R	RN72KIJ-103JE	1	435031034R1
R8194	C-CARBON R	RN72KIJ-103JE	1	435031034R1
R8933	C-CARBON R	RN72KIJ-563FE	1	435035632R1
R8934	C-CARBON R	RN72KIJ-274FE	1	435032742R1
R8935	C-CARBON R	RN72KIJ-103FE	1	435031032R1
R8936	C-CARBON R	RN72KIJ-822JE	1	435038224R1

R8951	C-CARBON R	RN72KIJ-102JE	1	435031024R1	
R8953	C-CARBON R	RN72KIJ-273FE	1	435032732R1	
R8955	C-CARBON R	RN72KIJ-103FE	1	435031032R1	
R8956	C-CARBON R	RN72KIJ-562JE	1	435035624R1	
R8971	C-CARBON R	RN72KIJ-102JE	1	435031024R1	
R8973	C-CARBON R	RN72KIJ-103FE	1	435031032R1	
R8975	C-CARBON R	RN72KIJ-103FE	1	435031032R1	
R8976	C-CARBON R	RN72KIJ-332JE	1	435033324R1	
[SW TRM]					
JL501B	WIRE TRAP	NPLG-3P586	1	25055624	
JL801B	WIRE TRAP	NPLG-5P588	1	25055626	
JL901B	WIRE TRAP	NPLG-5P588	1	25055626	
P2001B	SOCKET	IMSA-9618S-07A	1	25053332R2	N
P2001Bor	SOCKET	07FMN-SMT-A-TF	(1)	25052824R2	
P2800B	SOCKET	IMSA-9618S-09A	1	25053334R2	
P2800Bor	SOCKET	09FMN-SMT-A-TF	(1)	25052826R2	
P3101A	PLUG	NPLG-5P918	1	25055965R2	
P3102A	SOCKET	NSCT-9P2472	1	25052575R2	
P3104	SOCKET	RB1-105B8A1F	1	25053409	N
P3104 or	SOCKET	SI-60073-F	(1)	25053307	
P3104 or	SOCKET	EJFR0002	(1)	25056668	
P701A	SOCKET	IMSA-9618S-23A	1	25053348R2	
P701Aor	SOCKET	23FMN-SMT-A-TF	(1)	25052840R2	N
P751A	SOCKET	NSCT-9P2472	1	25052575R2	
P8001B	SOCKET	IMSA-9111S-24L	1	25053259	
P8002B	SOCKET	IMSA-9111S-16L	1	25053258	
P8003B	SOCKET	IMSA-9111S-16L	1	25053258	
P8101	SOCKET	TCX3400-111387	1	25053406R3	
P8101 or	SOCKET	YKF45-7037V	(1)	25053253R3	
P8101 or	SOCKET	HDMI(47266-4101)	(1)	25053389R3	
P8101 or	SOCKET	061-043-079	(1)	25053407R3	
P8102	SOCKET	TCX3400-111387	1	25053406R3	
P8102 or	SOCKET	YKF45-7037V	(1)	25053253R3	
P8102 or	SOCKET	HDMI(47266-4101)	(1)	25053389R3	

P8102 or	SOCKET	061-043-079	(1)	25053407R3
P8103	SOCKET	TCX3400-111387	1	25053406R3
P8103 or	SOCKET	YKF45-7037V	(1)	25053253R3
P8103 or	SOCKET	HDMI(47266-4101)	(1)	25053389R3
P8103 or	SOCKET	061-043-079	(1)	25053407R3
P8104	SOCKET	TCX3400-111387	1	25053406R3
P8104 or	SOCKET	YKF45-7037V	(1)	25053253R3
P8104 or	SOCKET	HDMI(47266-4101)	(1)	25053389R3
P8104 or	SOCKET	061-043-079	(1)	25053407R3
P8105	SOCKET	TCX3400-111387	1	25053406R3
P8105 or	SOCKET	YKF45-7037V	(1)	25053253R3
P8105 or	SOCKET	HDMI(47266-4101)	(1)	25053389R3
P8105 or	SOCKET	061-043-079	(1)	25053407R3
P8901	SOCKET	NSCT-8P2471	1	25052574R2

U004	U0030 x 4 pcs.	BADG-0639-1B	1	1B258539-1B
U0040	Digital Input Terminals Circuit PC board ass'y	BADG-0639-1B *	1	1B2585639-1B

CIRCUIT NO.	PART NAME	DESCRIPTION	Q'TY	PART NO. (SN)	REMARKS
[SEMI CONDUCTOR]					
D131	C-DIODE	DA2J10100	1	223303R2	
D131 or	C-DIODE	1SS352	(1)	223234R2	
D131 or	C-DIODE	1SS355	(1)	223269R2	
D131 or	C-DIODE	MA2J111	(1)	223279R2	
D131 or	C-DIODE	KDS4148U	(1)	223283R2	
D132	C-DIODE	DA2J10100	1	223303R2	
D132 or	C-DIODE	1SS352	(1)	223234R2	
D132 or	C-DIODE	1SS355	(1)	223269R2	
D132 or	C-DIODE	MA2J111	(1)	223279R2	
D132 or	C-DIODE	KDS4148U	(1)	223283R2	
Q131	IC	TC74HCU04AF	1	222740046R2TO	
Q401	IC	NJM4580M-D	1	22241448R2	
Q402	IC	NJM4580M-D	1	22241448R2	
Q403	IC	NJM4580M-D	1	22241448R2	

Q404	IC	NJM4580M-D	1	22241448R2
Q481	IC	NJM4580M-D	1	22241448R2
[TRANS COIL]				
L130	CHOKE COIL	LBC2518T2R2M	1	231364M022R2
L131	CHOKE COIL	LBC2518T2R2M	1	231364M022R2
L132	CHOKE COIL	LBC2518T2R2M	1	231364M022R2
L133	CHOKE COIL	LBC2518T470M	1	231364M470R2
L134	CHOKE COIL	LBC2518T470M	1	231364M470R2
L135	EMIFIL	BK1608HS102-T	1	230955R2
L136	EMIFIL	BK1608HS102-T	1	230955R2
[CAPACITOR]				
C130	C-CERA C	CK725F1E-104Z1	1	332161040R1
C131	C-CERA C	CC725CH1H-101J1	1	342101014R1
C132	C-CERA C	CC725CH1H-101J1	1	342101014R1
C133	C-CERA C	CK725B1C-104K1	1	332121045R1
C134	C-CERA C	CK725B1C-104K1	1	332121045R1
C135	C-CERA C	CC725CH1H-080D1	1	342100802R1
C136	C-CERA C	CC725CH1H-080D1	1	342100802R1
C139	UTSP C	CE04W10V-220M(UTSP)	1	397532217T
C140	C-CERA C	CK725F1E-104Z1	1	332161040R1
C141	C-CERA C	CK725F1E-104Z1	1	332161040R1
C142	C-CERA C	CK725F1E-104Z1	1	332161040R1
C143	C-CERA C	CC725CH1H-330J1	1	342103304R1
C144	C-CERA C	CC725CH1H-330J1	1	342103304R1
C145	UTSP C	CE04W10V-220M(UTSP)	1	397532217T
C400	UPZ C	2AUPZTF471JE	1	376334714T
C401	UPZ C	2AUPZTF471JE	1	376334714T
C402	UPZ C	2AUPZTF471JE	1	376334714T
C403	UPZ C	2AUPZTF471JE	1	376334714T
C404	UPZ C	2AUPZTF471JE	1	376334714T
C405	UPZ C	2AUPZTF471JE	1	376334714T
C406	UPZ C	2AUPZTF471JE	1	376334714T
C407	UPZ C	2AUPZTF471JE	1	376334714T
C410	UPZ C	2AUPZTF101JE	1	376331014T

C411	UPZ C	2AUPZTF101JE	1	376331014T
C412	UPZ C	2AUPZTF101JE	1	376331014T
C413	C-CERA C	CC725CH1H-101J1	1	342101014R1
C414	C-CERA C	CC725CH1H-101J1	1	342101014R1
C415	C-CERA C	CC725CH1H-101J1	1	342101014R1
C416	C-CERA C	CC725CH1H-101J1	1	342101014R1
C417	UPZ C	2AUPZTF101JE	1	376331014T
C420	UPZ C	2AUPZTF101JE	1	376331014T
C421	UPZ C	2AUPZTF101JE	1	376331014T
C422	UPZ C	2AUPZTF101JE	1	376331014T
C423	C-CERA C	CC725CH1H-101J1	1	342101014R1
C424	C-CERA C	CC725CH1H-101J1	1	342101014R1
C425	C-CERA C	CC725CH1H-101J1	1	342101014R1
C426	C-CERA C	CC725CH1H-101J1	1	342101014R1
C427	UPZ C	2AUPZTF101JE	1	376331014T
C480	UTSP C	CE04W50V-10M(UTSP)	1	397581007T
C481	UTSP C	CE04W50V-10M(UTSP)	1	397581007T
C482	C-CERA C	CC725CH1H-152J1	1	342101524R1
C483	C-CERA C	CC725CH1H-152J1	1	342101524R1
C484	C-CERA C	CC725CH1H-221J1	1	342102214R1
C485	C-CERA C	CC725CH1H-221J1	1	342102214R1
C498	UTSP C	CE04W25V-220M(UTSP)	1	397552217T
C499	UTSP C	CE04W25V-220M(UTSP)	1	397552217T

[RESISTOR]

R130	C-CARBON R	RN72K1J-331JE	1	435033314R1
R131	C-CARBON R	RN72K1J-750JE	1	435037504R1
R132	C-CARBON R	RN72K1J-750JE	1	435037504R1
R133	C-CARBON R	RN72K1J-100JE	1	435031004R1
R134	C-CARBON R	RN72K1J-100JE	1	435031004R1
R135	C-CARBON R	RN72K1J-224JE	1	435032244R1
R136	C-CARBON R	RN72K1J-224JE	1	435032244R1
R137	C-CARBON R	RN72K1J-103JE	1	435031034R1
R138	C-CARBON R	RN72K1J-103JE	1	435031034R1
R139	C-CARBON R	RN72K1J-823JE	1	435038234R1

R140	C-CARBON R	RN72KIJ-823JE	1	435038234R1
R141	C-CARBON R	RN72KIJ-470JE	1	435034704R1
R142	C-CARBON R	RN72KIJ-470JE	1	435034704R1
R400	C-CARBON R	RN72KIJ-153JE	1	435031534R1
R401	C-CARBON R	RN72KIJ-153JE	1	435031534R1
R402	C-CARBON R	RN72KIJ-153JE	1	435031534R1
R403	C-CARBON R	RN72KIJ-153JE	1	435031534R1
R404	C-CARBON R	RN72KIJ-153JE	1	435031534R1
R405	C-CARBON R	RN72KIJ-153JE	1	435031534R1
R406	C-CARBON R	RN72KIJ-153JE	1	435031534R1
R407	C-CARBON R	RN72KIJ-153JE	1	435031534R1
R410	C-CARBON R	RN72KIJ-153JE	1	435031534R1
R411	C-CARBON R	RN72KIJ-153JE	1	435031534R1
R412	C-CARBON R	RN72KIJ-153JE	1	435031534R1
R413	C-CARBON R	RN72KIJ-153JE	1	435031534R1
R414	C-CARBON R	RN72KIJ-153JE	1	435031534R1
R415	C-CARBON R	RN72KIJ-153JE	1	435031534R1
R416	C-CARBON R	RN72KIJ-153JE	1	435031534R1
R417	C-CARBON R	RN72KIJ-153JE	1	435031534R1
R420	C-CARBON R	RN72KIJ-103JE	1	435031034R1
R421	C-CARBON R	RN72KIJ-103JE	1	435031034R1
R430	C-CARBON R	RN72KIJ-103JE	1	435031034R1
R431	C-CARBON R	RN72KIJ-103JE	1	435031034R1
R440	C-CARBON R	RN72KIJ-123JE	1	435031234R1
R441	C-CARBON R	RN72KIJ-123JE	1	435031234R1
R442	C-CARBON R	RN72KIJ-223JE	1	435032234R1
R443	C-CARBON R	RN72KIJ-223JE	1	435032234R1
R444	C-CARBON R	RN72KIJ-223JE	1	435032234R1
R445	C-CARBON R	RN72KIJ-223JE	1	435032234R1
R446	C-CARBON R	RN72KIJ-223JE	1	435032234R1
R447	C-CARBON R	RN72KIJ-223JE	1	435032234R1
R450	C-CARBON R	RN72KIJ-123JE	1	435031234R1
R451	C-CARBON R	RN72KIJ-123JE	1	435031234R1
R452	C-CARBON R	RN72KIJ-223JE	1	435032234R1

R453	C-CARBON R	RN72KIJ-223JE	1	435032234R1
R454	C-CARBON R	RN72KIJ-223JE	1	435032234R1
R455	C-CARBON R	RN72KIJ-223JE	1	435032234R1
R456	C-CARBON R	RN72KIJ-223JE	1	435032234R1
R457	C-CARBON R	RN72KIJ-223JE	1	435032234R1
R460	C-CARBON R	RN72KIJ-182JE	1	435031824R1
R461	C-CARBON R	RN72KIJ-182JE	1	435031824R1
R462	C-CARBON R	RN72KIJ-182JE	1	435031824R1
R463	C-CARBON R	RN72KIJ-182JE	1	435031824R1
R464	C-CARBON R	RN72KIJ-182JE	1	435031824R1
R465	C-CARBON R	RN72KIJ-182JE	1	435031824R1
R466	C-CARBON R	RN72KIJ-182JE	1	435031824R1
R467	C-CARBON R	RN72KIJ-182JE	1	435031824R1
R470	C-CARBON R	RN72KIJ-182JE	1	435031824R1
R471	C-CARBON R	RN72KIJ-182JE	1	435031824R1
R472	C-CARBON R	RN72KIJ-182JE	1	435031824R1
R473	C-CARBON R	RN72KIJ-182JE	1	435031824R1
R474	C-CARBON R	RN72KIJ-182JE	1	435031824R1
R475	C-CARBON R	RN72KIJ-182JE	1	435031824R1
R476	C-CARBON R	RN72KIJ-182JE	1	435031824R1
R477	C-CARBON R	RN72KIJ-182JE	1	435031824R1
R480	C-CARBON R	RN72KIJ-104JE	1	435031044R1
R481	C-CARBON R	RN72KIJ-104JE	1	435031044R1
R482	C-CARBON R	RN72KIJ-332JE	1	435033324R1
R483	C-CARBON R	RN72KIJ-332JE	1	435033324R1
R484	C-CARBON R	RN72KIJ-472JE	1	435034724R1
R485	C-CARBON R	RN72KIJ-472JE	1	435034724R1
R486	C-CARBON R	RN72KIJ-822JE	1	435038224R1
R487	C-CARBON R	RN72KIJ-822JE	1	435038224R1
R496	C-CARBON R	RN72KIJ-000JE	1	435030004R1
R497	C-CARBON R	RN72KIJ-000JE	1	435030004R1
R498	C-CARBON R	RN72KIJ-220JE	1	435032204R1
R499	C-CARBON R	RN72KIJ-220JE	1	435032204R1

[SW TRM]

P130	ST JACK	MSJ-035-22	1	25045887
P130 or	JACK	YKB21-5130	(1)	25045387
P131	PIN JACK	NPJ-2PDOO626	1	25045847
P5501A	SOCKET	NSCT-5P2185	1	25052288
P5502A	SOCKET	NSCT-15P2195	1	25052298
P5503A	SOCKET	NSCT-13P2193	1	25052296
P5504A	SOCKET	NSCT-7P2187	1	25052290
P703B	SOCKET	NSCT-7P2425	1	25052528
P8001A	PLUG	IMSA-9111B-24	1	25056625
P8002A	PLUG	IMSA-9111B-16	1	25056620
P8003A	PLUG	IMSA-9111B-16	1	25056620
[TUNER UNIT]				
U131	PHT CP	JSR1165-001recieving	1	24120143
U132	PHT CP	JSR1165-001recieving	1	24120143

ONKYO

ONKYO SOUND & VISION CORPORATION

Technical Support, Service Dept.: 2-1, Nisshin-cho, Neyagawa-shi, OSAKA 572-8540, JAPAN
Tel: 072-831-8023 Fax: 072-831-8163

ONKYO U.S.A. CORPORATION

18 Park Way, Upper Saddle River, N.J. 07458, U.S.A.
Tel: 800-229-1687, 201-785-2600 Fax: 201-785-2650
<http://www.us.onkyo.com/>

ONKYO EUROPE ELECTRONICS GmbH

Liegnitzerstrasse 6, 82194 Groebenzell, GERMANY
Tel: +49-8142-4401-0 Fax: +49-8142-4401-555
<http://www.eu.onkyo.com/>

ONKYO EUROPE ELECTRONICS GmbH (UK BRANCH)

The Coach House 81A High Street, Marlow, Buckinghamshire, SL7 1AB, UK
Tel: +44-(0)1628-473-350 Fax: +44-(0)1628-401-700

ONKYO CHINA LIMITED

Unit 1033, 10/F, Star House, No 3, Salisbury Road, Tsim Sha Tsui Kowloon, Hong Kong.
Tel: 852-2429-3118 Fax: 852-2428-9039
<http://www.ch.onkyo.com/>