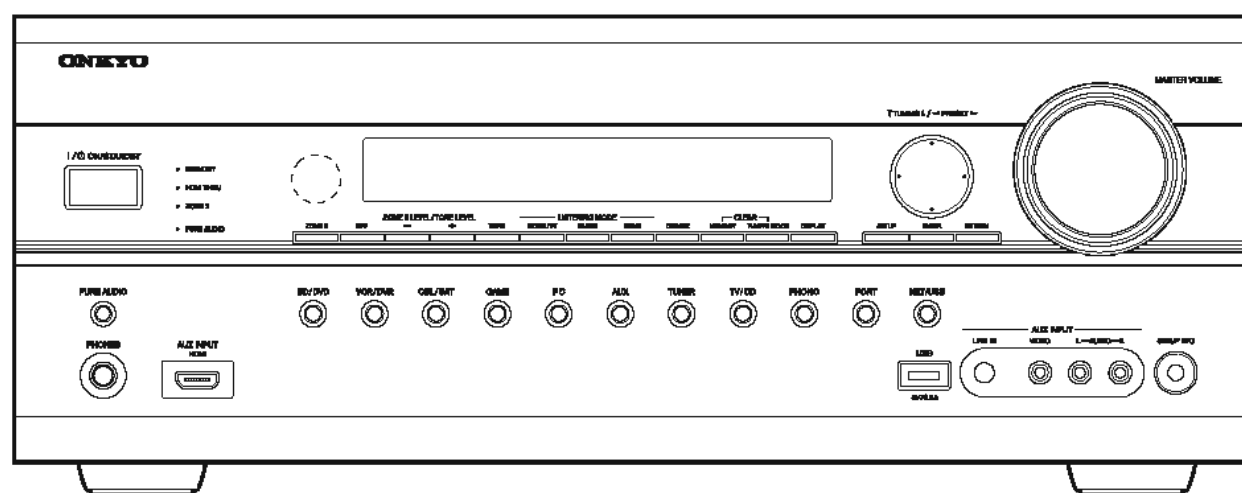
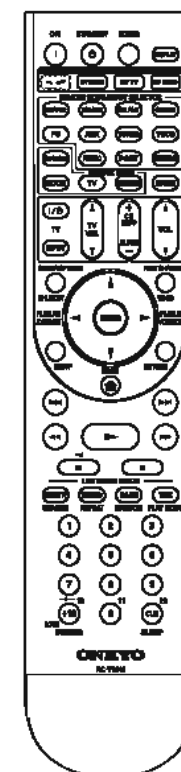

ONKYO SERVICE MANUAL

AV RECEIVER MODEL TX-NR708(B)/(S)

**Black and Silver models**

RC-768M

B MDC, B MDF	120V AC, 60Hz
B MMP, B MMA, S MMP	220-240V AC, 50/60Hz
B MMR, B MMQ	220-240V AC, 50/60Hz

SAFETY-RELATED COMPONENT WARNING!!

COMPONENTS IDENTIFIED BY MARK  ON THE SCHEMATIC DIAGRAM AND IN THE PARTS LIST ARE CRITICAL FOR RISK OF FIRE AND ELECTRIC SHOCK. REPLACE THESE COMPONENTS WITH ONKYO PARTS WHOSE PART NUMBERS APPEAR AS SHOWN IN THIS MANUAL.

MAKE LEAKAGE-CURRENT OR RESISTANCE MEASUREMENTS TO DETERMINE THAT EXPOSED PARTS ARE ACCEPTABLY INSULATED FROM THE SUPPLY CIRCUIT BEFORE RETURNING THE APPLIANCE TO THE CUSTOMER.

SERVICE PROCEDURE-1

1. Replacing the fuses

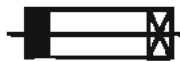
 This symbol located near the fuse indicates that the fuse used is slow operating type, For continued protection against fire hazard, replace with same type fuse, For fuse rating, refer to the marking adjacent to the symbol.

 Ce symbole indique que le fusible utilise est e lent. Pour une protection permanente, n'utiliser que des fusibles de meme type. Ce dernier est indique la qu le present symbol est apposre.

REF NO.	PART NAME	DESCRIPTION	PART NO.	REMARKS
F2000	FUSE	4A-UL/T-233	252325GR	
F2000 or	FUSE	4A-T/UL-ST2	252257GR	
F2001	FUSE	2A-UL/T-233	252320GR	
F2001 or	FUSE	2A-T/UL-ST2	252253GR	
F6901	FUSE	15A-TUL-250V	252303GR	
F6901 or	FUSE	15A-UL/T-314	252197GR	
F6902	FUSE	15A-TUL-250V	252303GR	
F6902 or	FUSE	15A-UL/T-314	252197GR	
F901	FUSE	10A-UL-ST6 N1	252382GR	<MDC, MDF, MJJ>
F901	FUSE	5A-SE-EAK	252078GR	<MMA, MMP, MMQ, MMR>
F901 or	FUSE	5A-SE-TL250V	252278GR	<MMA, MMP, MMQ, MMR>

<Notes>

- <MDC> : 120V,Canadian model
- <MMP> : 230V,CE(European) country model
- <MMA> : 230V,Australian model
- <MMQ> : 220/230-240V,Hong kong model
- <MMR> : 220/230-240V,Chinese model

2. Safety check out

(U.S.A. model only)

After correcting the original service problem, perform the following safety check before releasing the unit to the customer.

Leakage current Check

Measure the leakage current to a known earth ground (water pipe or conduct etc.) by connecting a leakage current tester between the earth ground and exposed metal parts of the unit (input/output ground terminals, screw heads or metal overlays etc.).

Plug the power supply cord directly into a 120Vac 60Hz wall socket and turn ON/STANDBY button on.

Any current measured must not exceed 0.5mA.

3. Memory Backup

This model uses a EE-PROM IC in order to retain radio presets and other settings. So, memory contents will be kept eternally with no care.

4. To initialize the unit

1. ON/STANDBY (Power On)

2. VCR/DVR + ON/STANDBY.

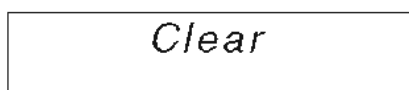

→ Stand-by

Preset memory and each mode stored in the memory, are initialized and will return to the factory settings.

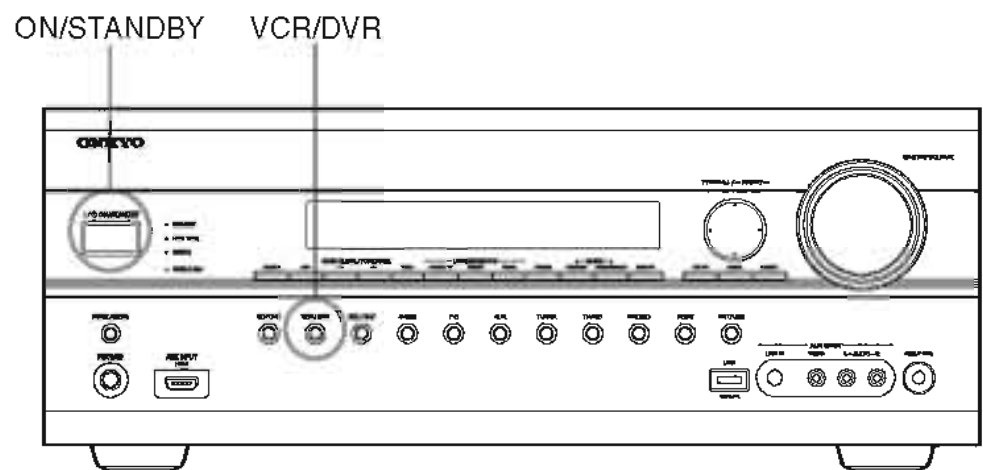

SERVICE PROCEDURE-2

5. To check version of Microprocessor, DSP and Video FW(Firmware)

1. ON/STANDBY (Power On)
2. DISPLAY + ON/STANDBY.

[e.g.] TX-NR808 Main:
1.03/10729AM

3. TONE ► [Tone +] ---> Forward [] : DTR-40.2/ 50.2, DHC-40.2
TONE ◀ [Tone -] ---> Reversed.

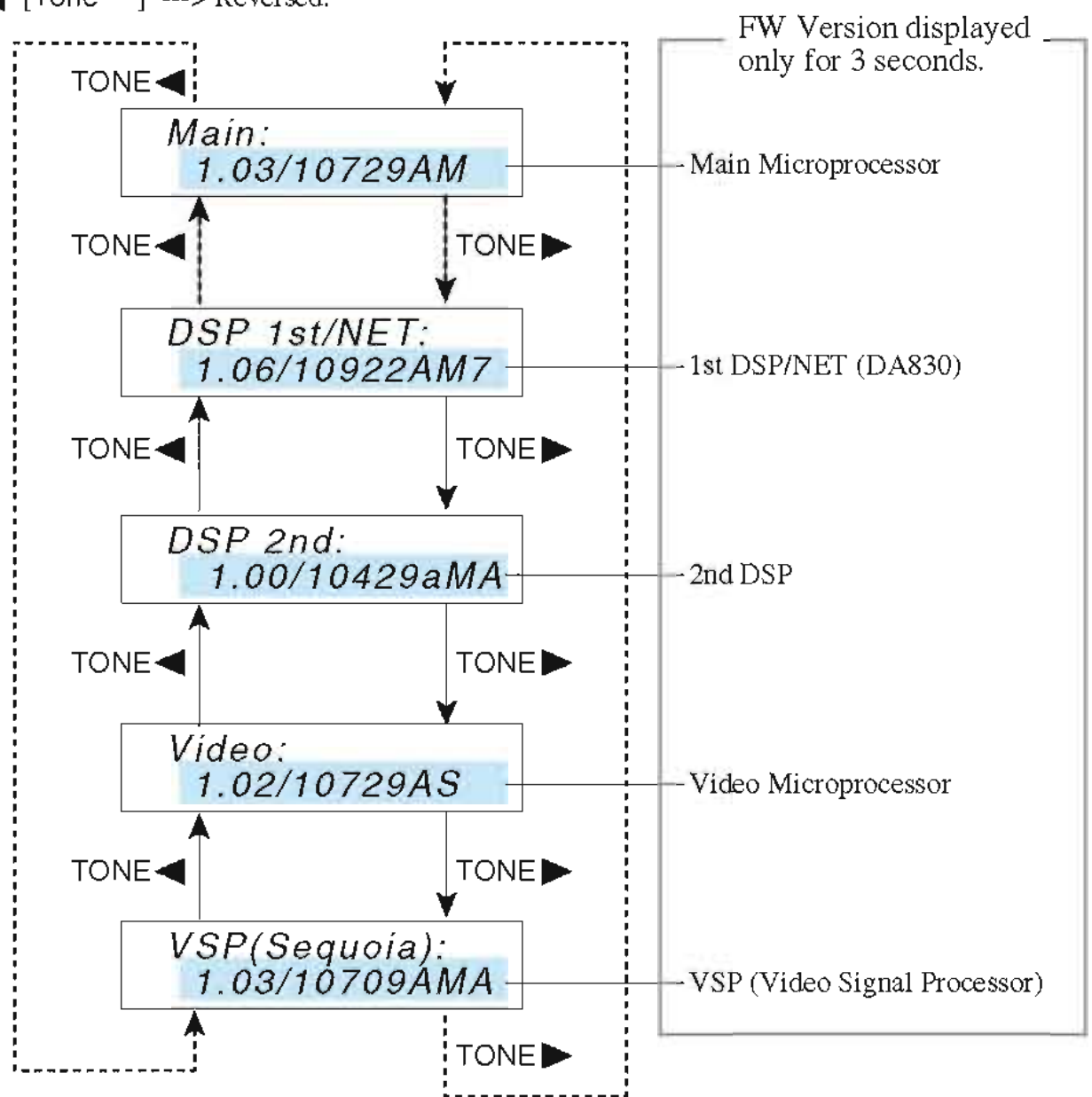

4. ON/STANDBY (Power Off).

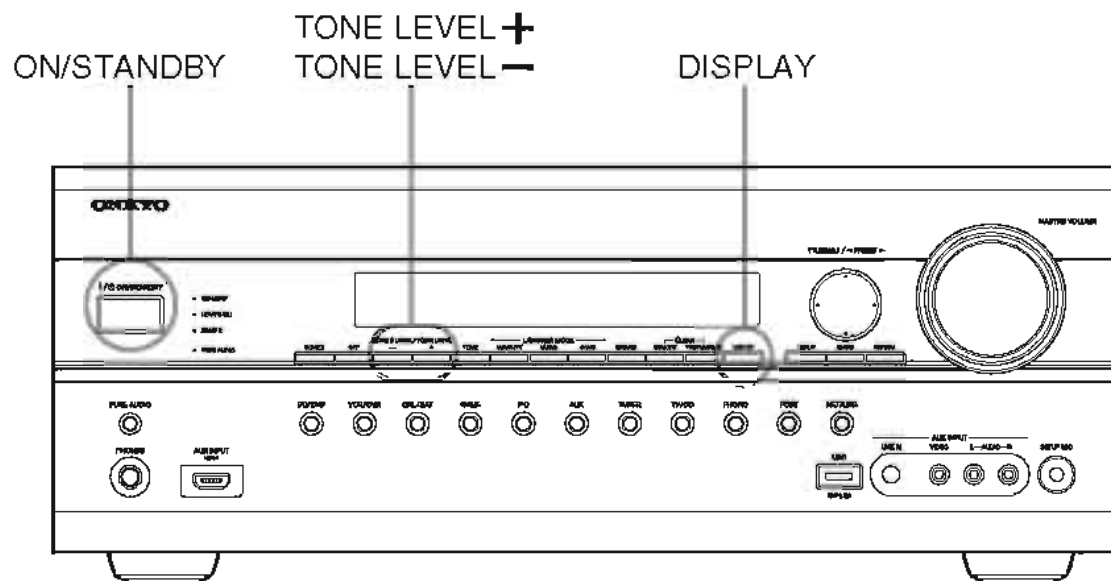

EXPLODED VIEWS-1

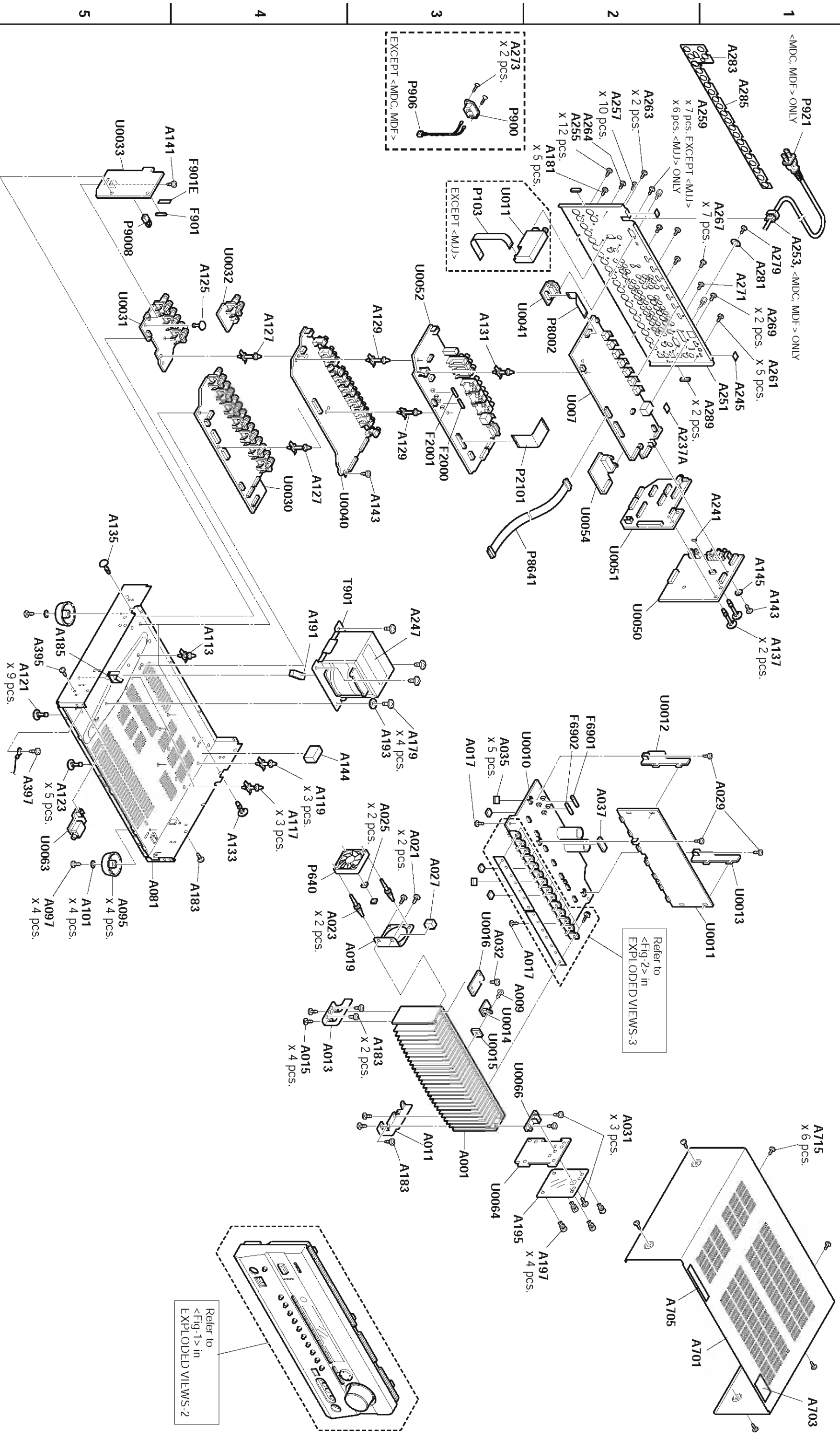

EXPLODED VIEWS-2

<Fig-1>

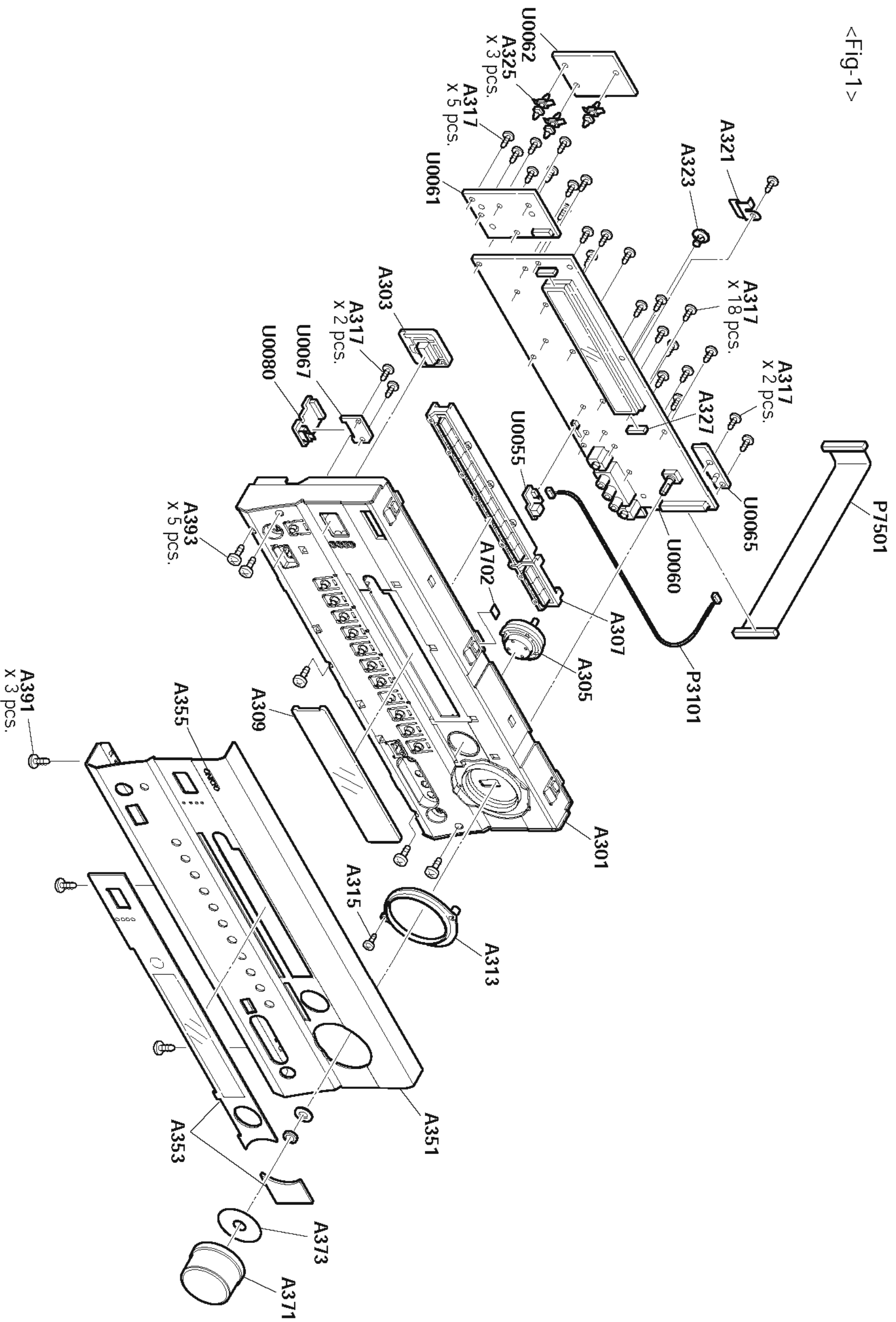

EXPLODED VIEWS-3

<Fig-2>

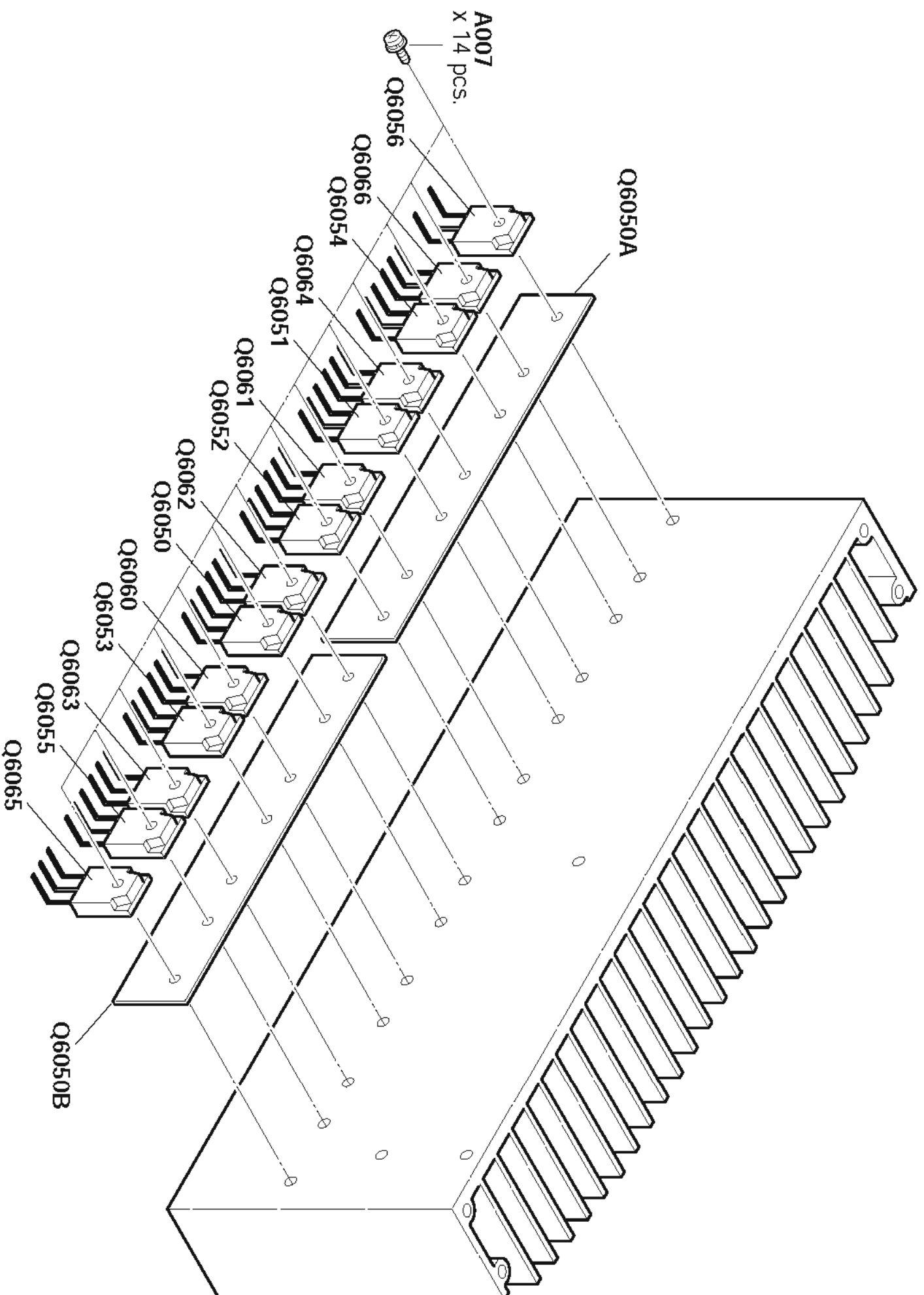

SCHEMATIC DIAGRAMS - 1
BLOCK DIAGRAM AUDIO SECTION

A B C D E F G H I J K

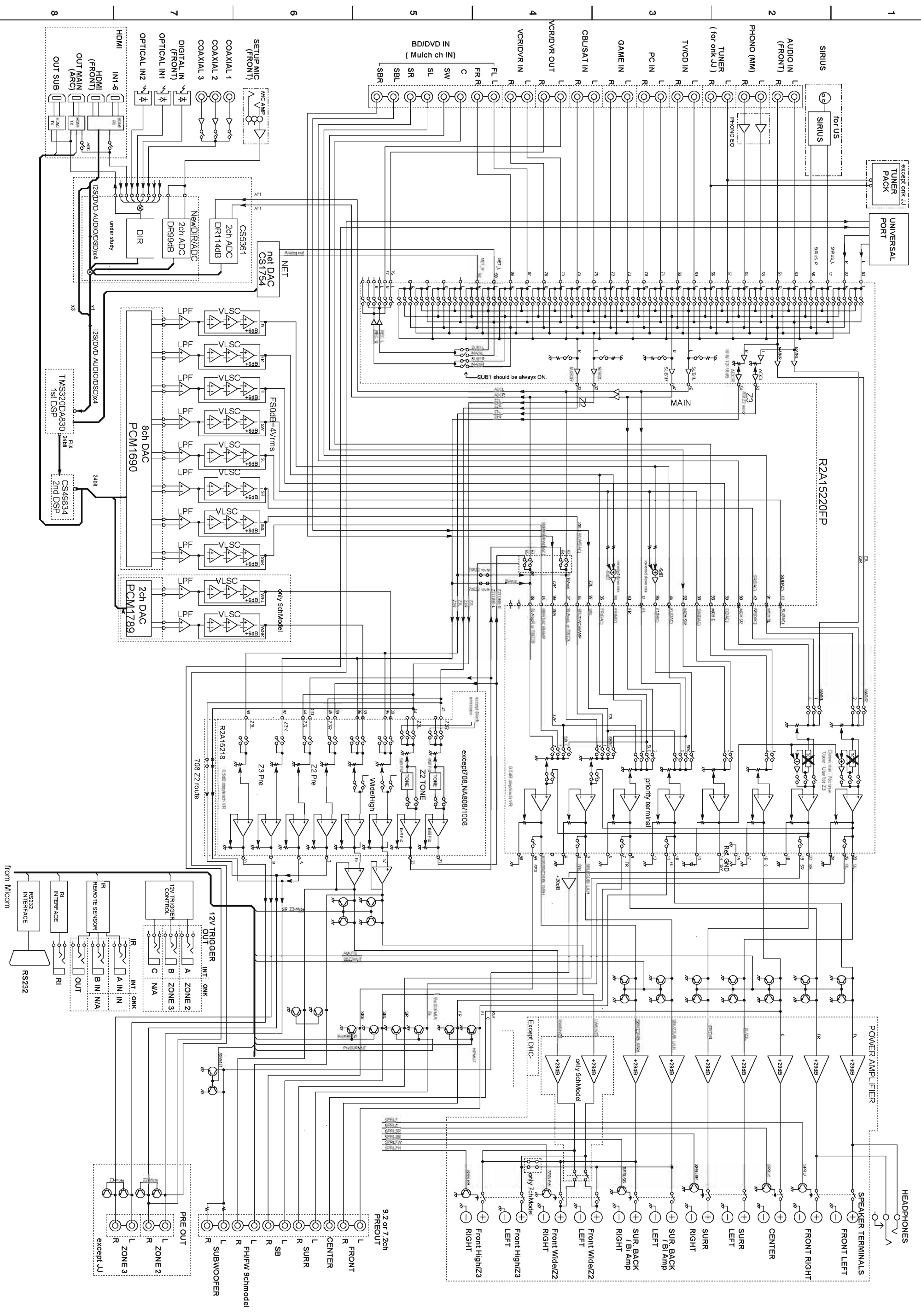

SCHEMATIC DIAGRAMS - 2
BLOCK DIAGRAM VIDEO SECTION

A B C D E F G H I J K

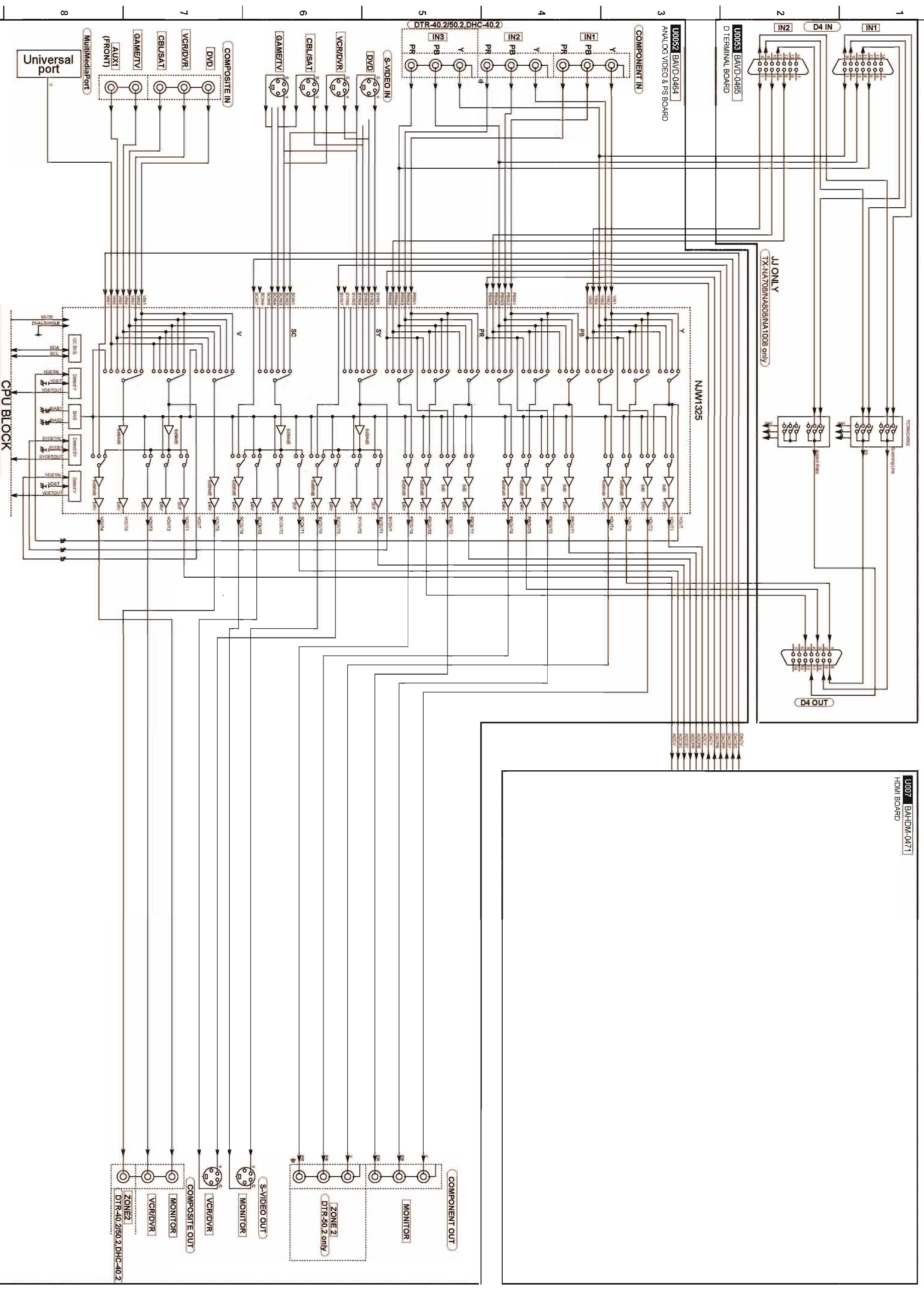

SCHEMATIC DIAGRAMS - 3
BLOCK DIAGRAM HDMI SECTION

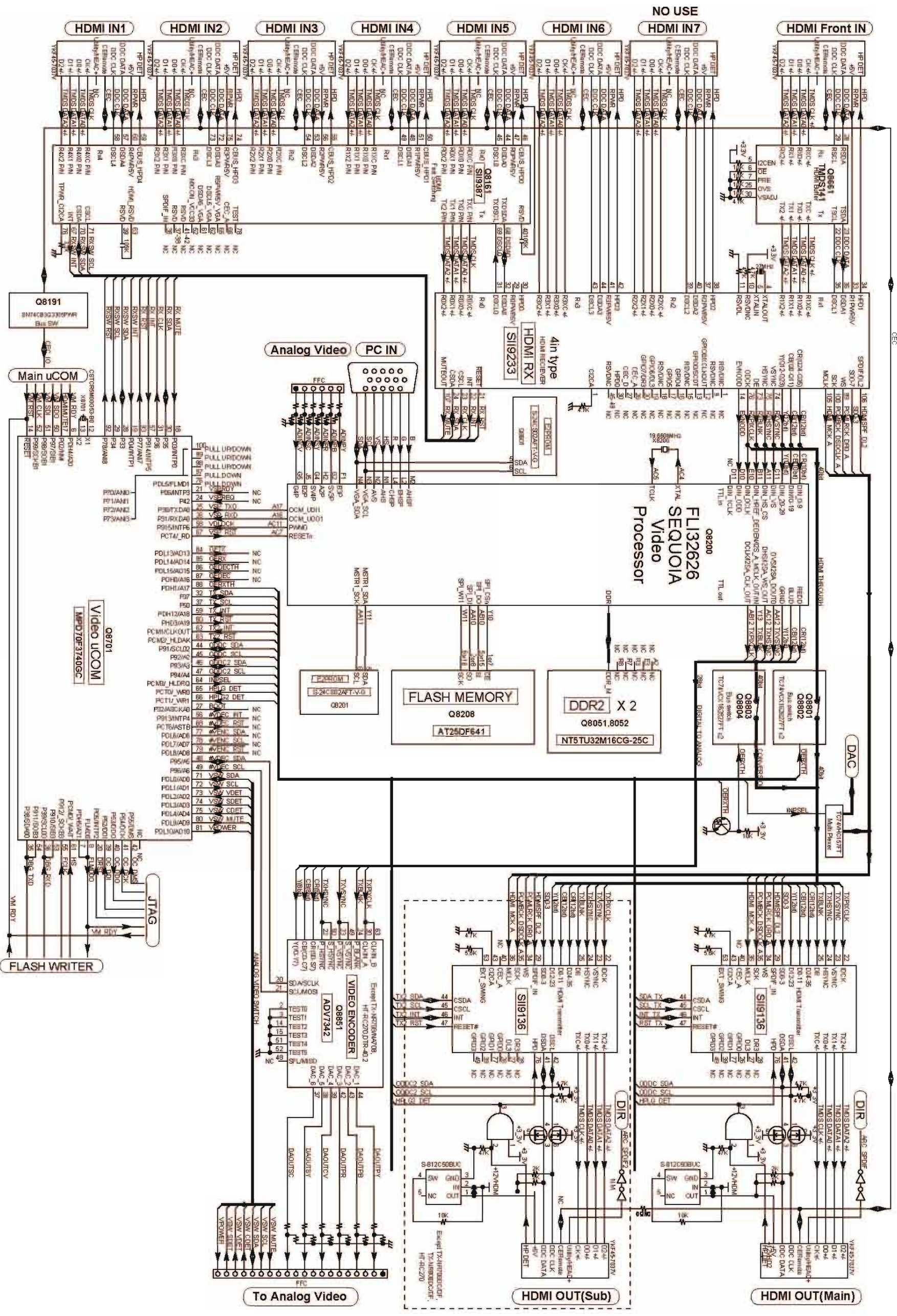

SCHEMATIC DIAGRAMS - 4
BLOCK DIAGRAM DSP/ETHERNET/USB SECTION

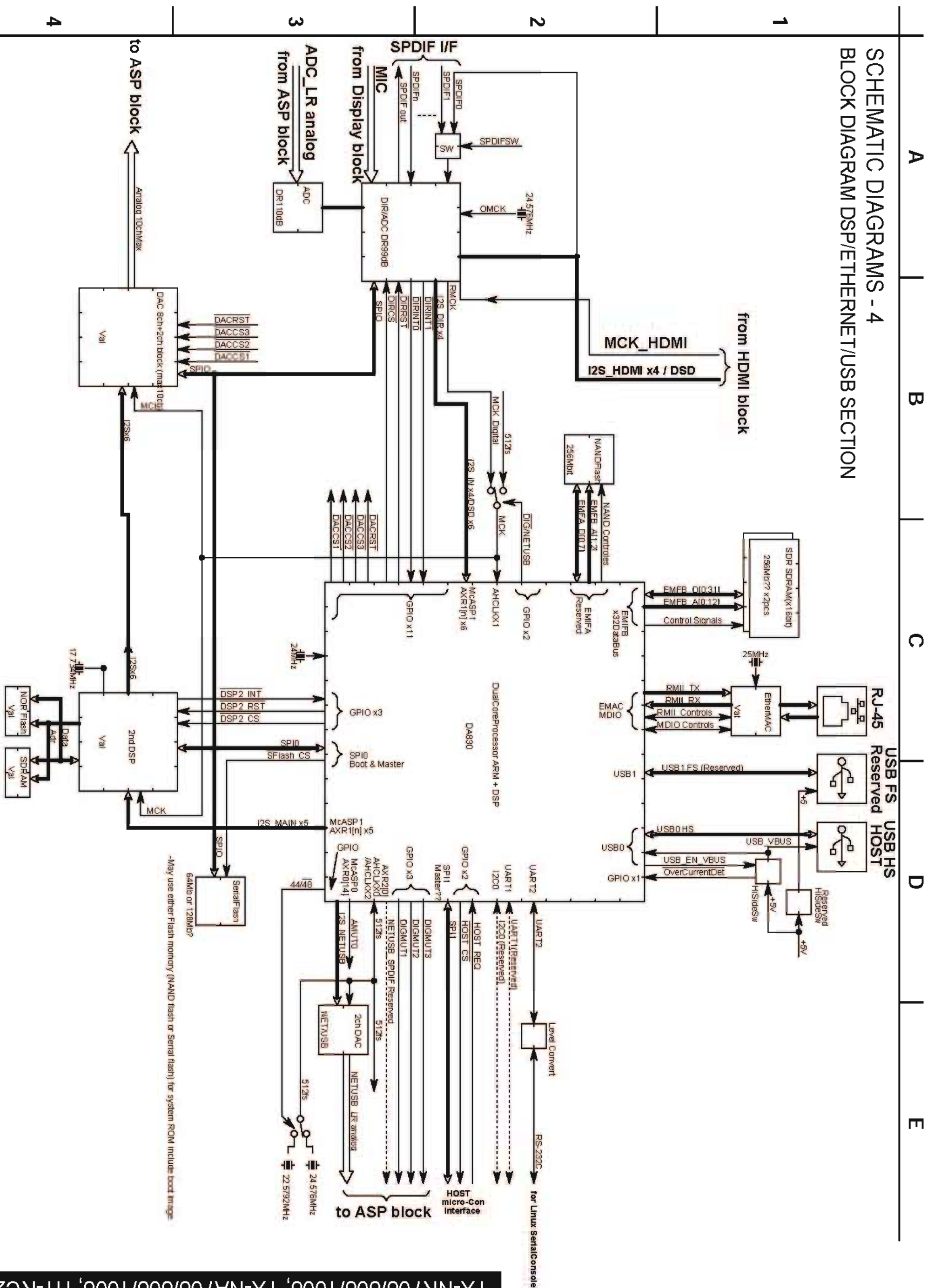

SCHEMATIC DIAGRAMS - 7
AMP (VOLTAGE AMP) SECTION

A B C D E F G H I J K

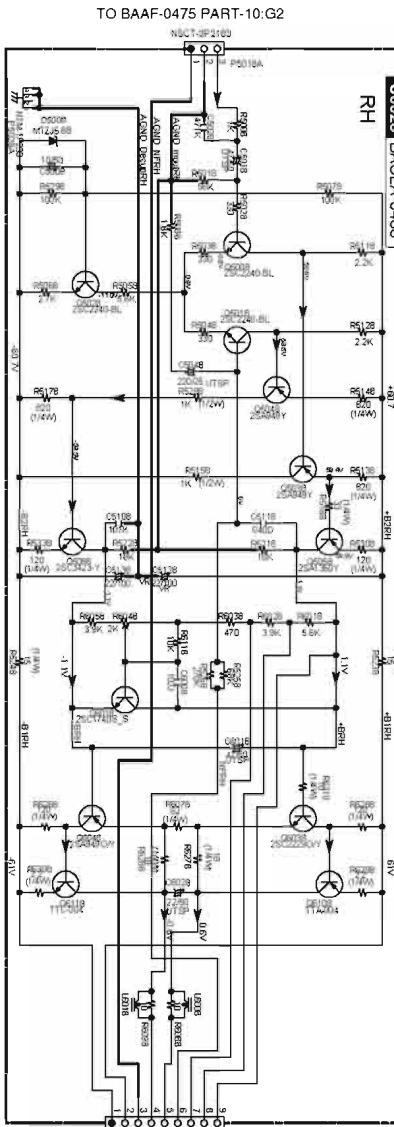
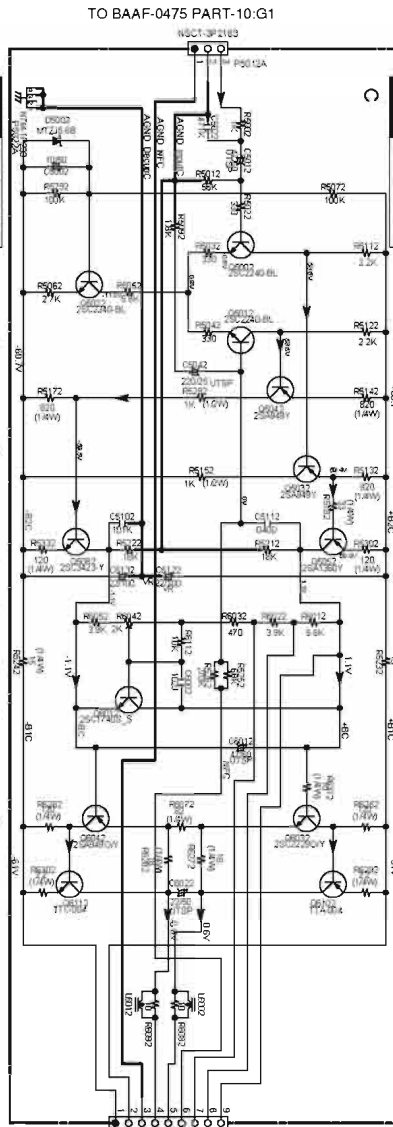
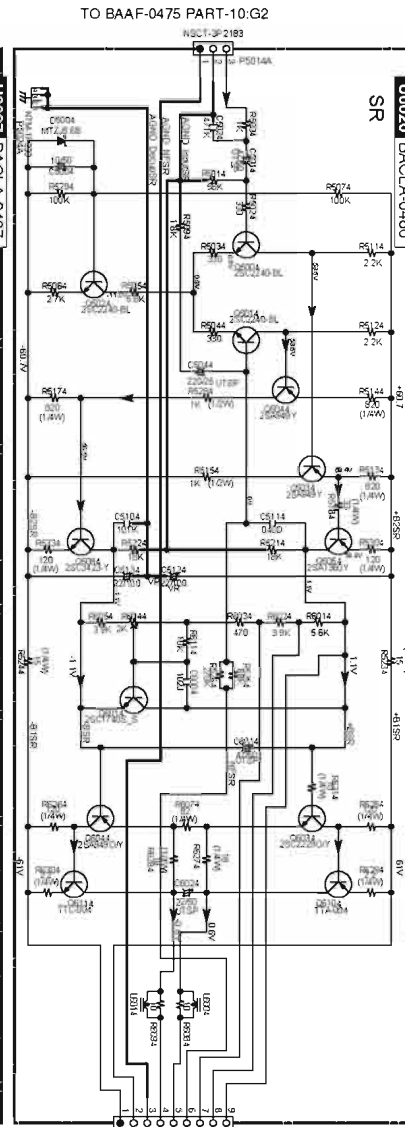
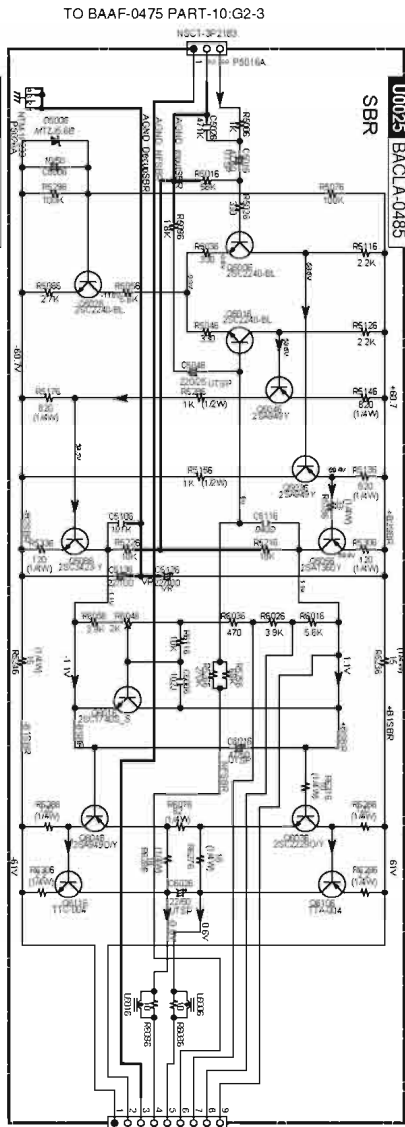
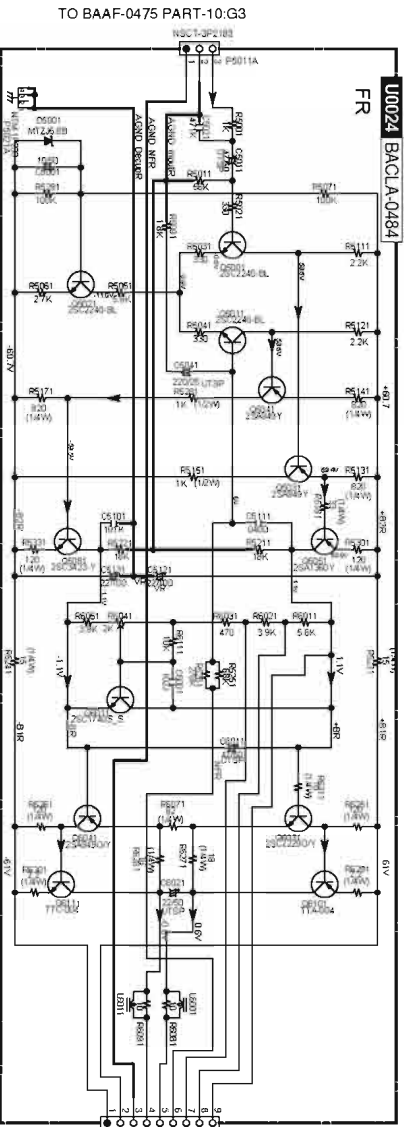

NOTE
DO NOT SCHEMATICALLY REPLACE "X" COMPONENTS WITH "Y" COMPONENTS UNLESS THE PARTS LIST SPECIFICALLY CALLS FOR EXCHANGE.
Circuit number is different, but as for the circuit being the same, there is compatibility. If you will exchange these pc board assembly, re-adjust the idling current.
If you will exchange these pc board assembly, re-adjust the idling current.

U0024(BACLA-0484, FR ch)
U0025(BACLA-0485, SBR ch)
U0026(BACLA-0486, SR ch)
U0027(BACLA-0487, C ch)
U0028(BACLA-0488, RH ch, TX-NR1008/NA1008 only)

U0020(BACLA-0480, FL ch)
U0021(BACLA-0481, SBL ch)
U0022(BACLA-0482, SL ch)
U0023(BACLA-0483, LH ch, TX-NR1008/NA1008 only)

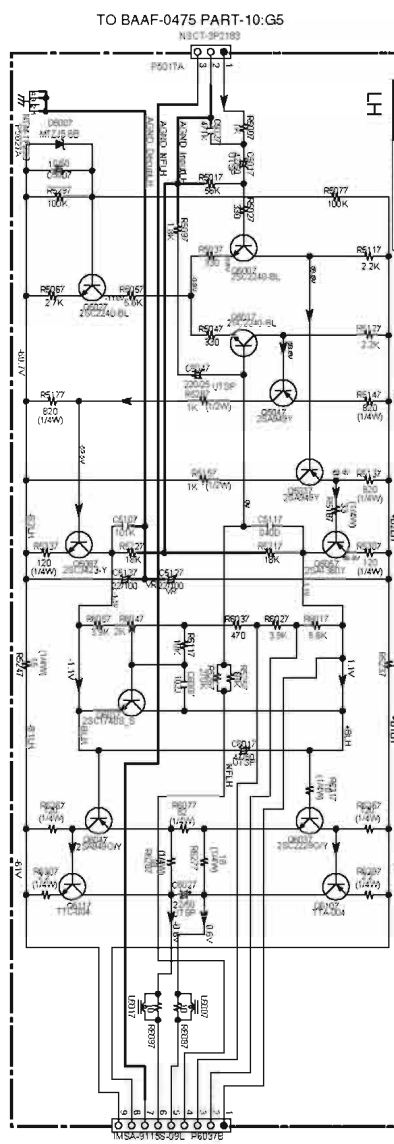
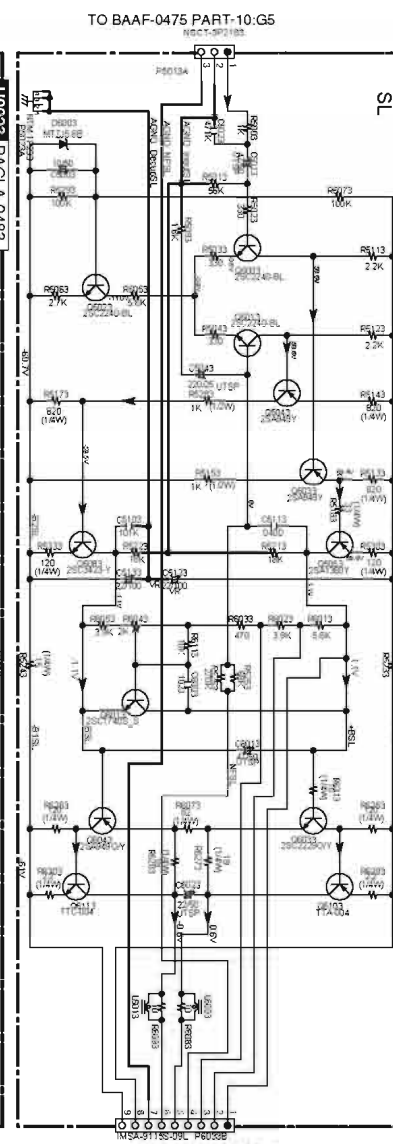
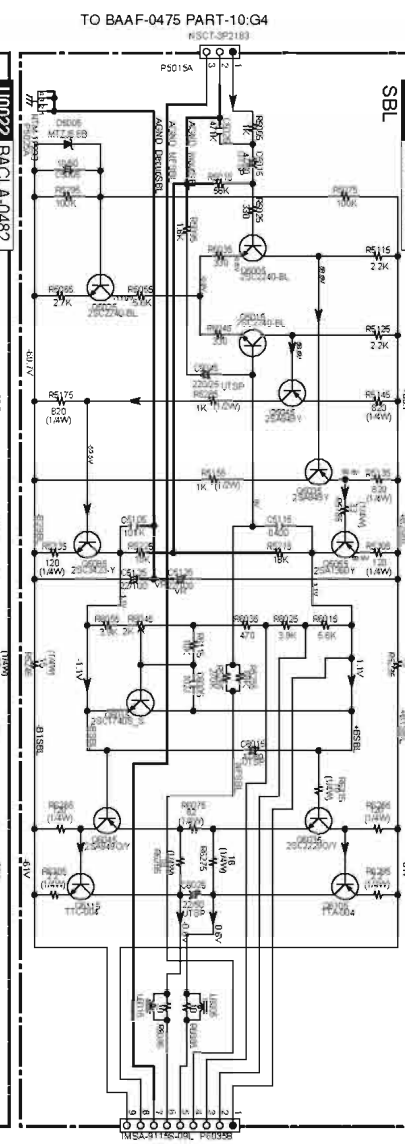
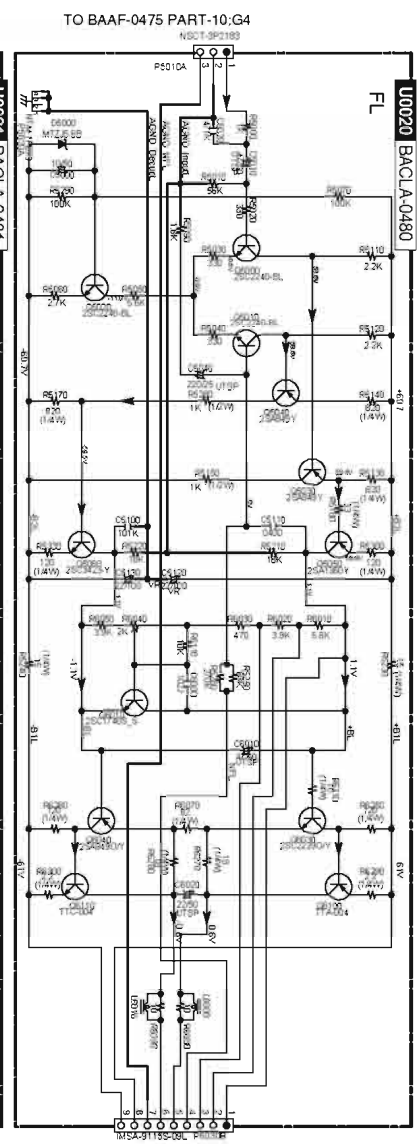

TABLE

1. Refer to 4.0 to determine when power on (Power Monitor) is active.

2. To adjust the remaining voltage and/or frequency, refer to the following values.

Adjustment point	Resistance value	Frequency value
4.0.1	10kΩ	4.0V
4.0.2	10kΩ	4.0V
4.0.3	10kΩ	4.0V
4.0.4	10kΩ	4.0V
4.0.5	10kΩ	4.0V
4.0.6	10kΩ	4.0V
4.0.7	10kΩ	4.0V
4.0.8	10kΩ	4.0V
4.0.9	10kΩ	4.0V
4.0.10	10kΩ	4.0V
4.0.11	10kΩ	4.0V
4.0.12	10kΩ	4.0V
4.0.13	10kΩ	4.0V
4.0.14	10kΩ	4.0V
4.0.15	10kΩ	4.0V
4.0.16	10kΩ	4.0V
4.0.17	10kΩ	4.0V
4.0.18	10kΩ	4.0V
4.0.19	10kΩ	4.0V
4.0.20	10kΩ	4.0V
4.0.21	10kΩ	4.0V
4.0.22	10kΩ	4.0V
4.0.23	10kΩ	4.0V
4.0.24	10kΩ	4.0V
4.0.25	10kΩ	4.0V
4.0.26	10kΩ	4.0V
4.0.27	10kΩ	4.0V
4.0.28	10kΩ	4.0V
4.0.29	10kΩ	4.0V
4.0.30	10kΩ	4.0V
4.0.31	10kΩ	4.0V
4.0.32	10kΩ	4.0V
4.0.33	10kΩ	4.0V
4.0.34	10kΩ	4.0V
4.0.35	10kΩ	4.0V
4.0.36	10kΩ	4.0V
4.0.37	10kΩ	4.0V
4.0.38	10kΩ	4.0V
4.0.39	10kΩ	4.0V
4.0.40	10kΩ	4.0V
4.0.41	10kΩ	4.0V
4.0.42	10kΩ	4.0V
4.0.43	10kΩ	4.0V
4.0.44	10kΩ	4.0V
4.0.45	10kΩ	4.0V
4.0.46	10kΩ	4.0V
4.0.47	10kΩ	4.0V
4.0.48	10kΩ	4.0V
4.0.49	10kΩ	4.0V
4.0.50	10kΩ	4.0V
4.0.51	10kΩ	4.0V
4.0.52	10kΩ	4.0V
4.0.53	10kΩ	4.0V
4.0.54	10kΩ	4.0V
4.0.55	10kΩ	4.0V
4.0.56	10kΩ	4.0V
4.0.57	10kΩ	4.0V
4.0.58	10kΩ	4.0V
4.0.59	10kΩ	4.0V
4.0.60	10kΩ	4.0V
4.0.61	10kΩ	4.0V
4.0.62	10kΩ	4.0V
4.0.63	10kΩ	4.0V
4.0.64	10kΩ	4.0V
4.0.65	10kΩ	4.0V
4.0.66	10kΩ	4.0V
4.0.67	10kΩ	4.0V
4.0.68	10kΩ	4.0V
4.0.69	10kΩ	4.0V
4.0.70	10kΩ	4.0V
4.0.71	10kΩ	4.0V
4.0.72	10kΩ	4.0V
4.0.73	10kΩ	4.0V
4.0.74	10kΩ	4.0V
4.0.75	10kΩ	4.0V
4.0.76	10kΩ	4.0V
4.0.77	10kΩ	4.0V
4.0.78	10kΩ	4.0V
4.0.79	10kΩ	4.0V
4.0.80	10kΩ	4.0V
4.0.81	10kΩ	4.0V
4.0.82	10kΩ	4.0V
4.0.83	10kΩ	4.0V
4.0.84	10kΩ	4.0V
4.0.85	10kΩ	4.0V
4.0.86	10kΩ	4.0V
4.0.87	10kΩ	4.0V
4.0.88	10kΩ	4.0V
4.0.89	10kΩ	4.0V
4.0.90	10kΩ	4.0V
4.0.91	10kΩ	4.0V
4.0.92	10kΩ	4.0V
4.0.93	10kΩ	4.0V
4.0.94	10kΩ	4.0V
4.0.95	10kΩ	4.0V
4.0.96	10kΩ	4.0V
4.0.97	10kΩ	4.0V
4.0.98	10kΩ	4.0V
4.0.99	10kΩ	4.0V
4.0.100	10kΩ	4.0V

1. Refer to 4.0 to determine when power on (Power Monitor) is active.

2. To adjust the remaining voltage and/or frequency, refer to the following values.

3. All components are standard values.

4. All components are standard values.

5. All components are standard values.

6. All components are standard values.

7. All components are standard values.

8. All components are standard values.

9. All components are standard values.

10. All components are standard values.

11. All components are standard values.

12. All components are standard values.

13. All components are standard values.

14. All components are standard values.

15. All components are standard values.

16. All components are standard values.

17. All components are standard values.

18. All components are standard values.

19. All components are standard values.

20. All components are standard values.

21. All components are standard values.

22. All components are standard values.

23. All components are standard values.

24. All components are standard values.

25. All components are standard values.

26. All components are standard values.

27. All components are standard values.

28. All components are standard values.

29. All components are standard values.

30. All components are standard values.

31. All components are standard values.

32. All components are standard values.

33. All components are standard values.

34. All components are standard values.

35. All components are standard values.

36. All components are standard values.

37. All components are standard values.

38. All components are standard values.

39. All components are standard values.

40. All components are standard values.

41. All components are standard values.

42. All components are standard values.

43. All components are standard values.

44. All components are standard values.

45. All components are standard values.

46. All components are standard values.

47. All components are standard values.

48. All components are standard values.

49. All components are standard values.

50. All components are standard values.

51. All components are standard values.

52. All components are standard values.

53. All components are standard values.

54. All components are standard values.

55. All components are standard values.

56. All components are standard values.

57. All components are standard values.

58. All components are standard values.

59. All components are standard values.

60. All components are standard values.

61. All components are standard values.

62. All components are standard values.

63. All components are standard values.

64. All components are standard values.

65. All components are standard values.

66. All components are standard values.

67. All components are standard values.

68. All components are standard values.

69. All components are standard values.

70. All components are standard values.

71. All components are standard values.

72. All components are standard values.

73. All components are standard values.

74. All components are standard values.

75. All components are standard values.

76. All components are standard values.

77. All components are standard values.

78. All components are standard values.

79. All components are standard values.

80. All components are standard values.

81. All components are standard values.

82. All components are standard values.

83. All components are standard values.

84. All components are standard values.

85. All components are standard values.

86. All components are standard values.

87. All components are standard values.

88. All components are standard values.

89. All components are standard values.

90. All components are standard values.

91. All components are standard values.

92. All components are standard values.

93. All components are standard values.

94. All components are standard values.

95. All components are standard values.

96. All components are standard values.

97. All components are standard values.

98. All components are standard values.

99. All components are standard values.

100. All components are standard values.

1 2 3 4 5 6 7 8

SCHEMATIC DIAGRAMS - 8
POWERAMP (FINAL STAGE) SECTION

NOTE:
X1 in SCHEMATIC of PARTS 'X' indicates the target location of the flag or socket, X=to DRK, Y=to W&S.

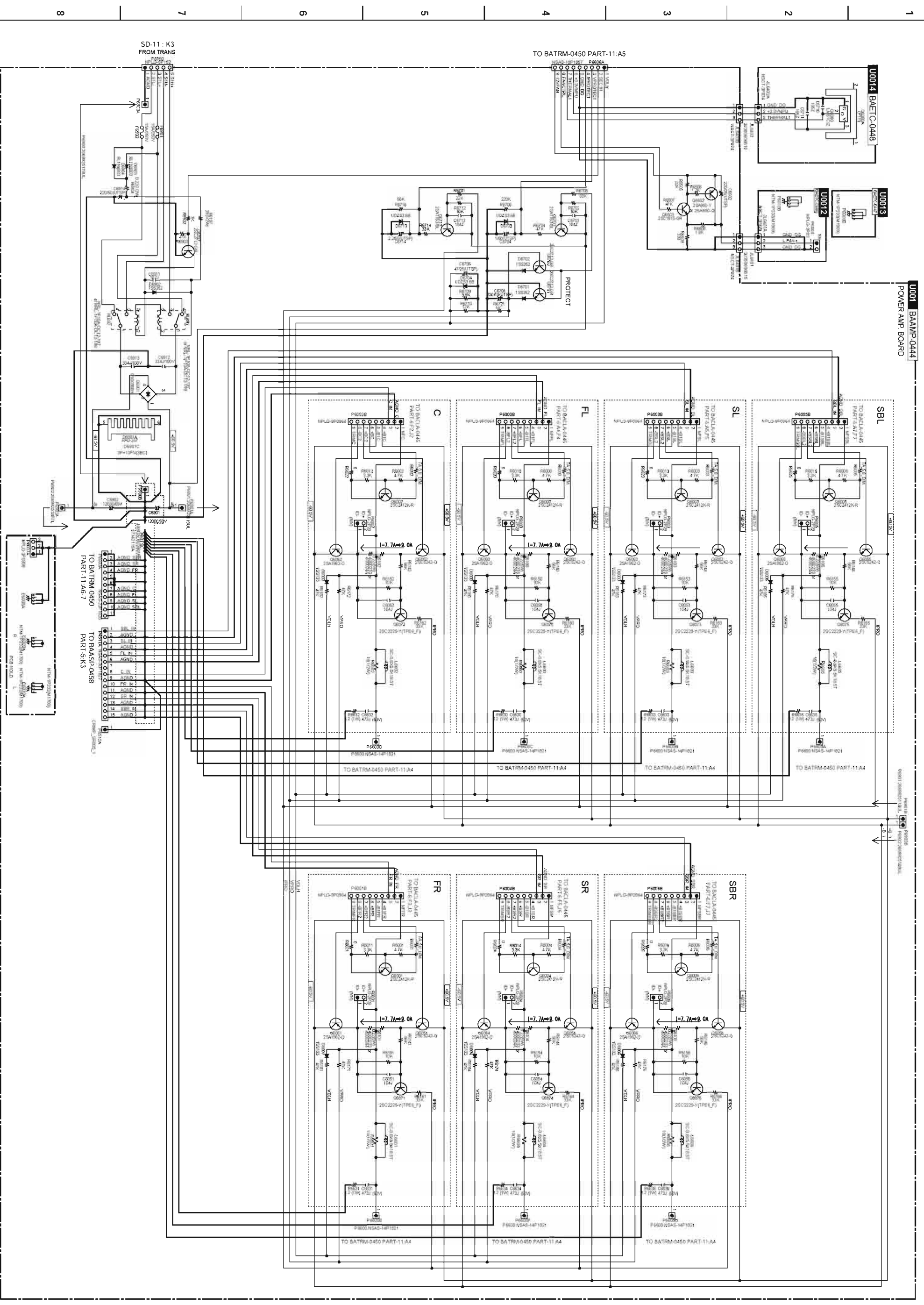

SCHEMATIC DIAGRAMS - 9
POWER AMP (FINAL STAGE) SECTION

NOTE:
XY is "SCHEMATIC OF PART 0474" located in the same location of the filing of block X44 to EHWK, Y=1 to 4E6.

U0010 BAAMP-0474
POWER AMP BOARD

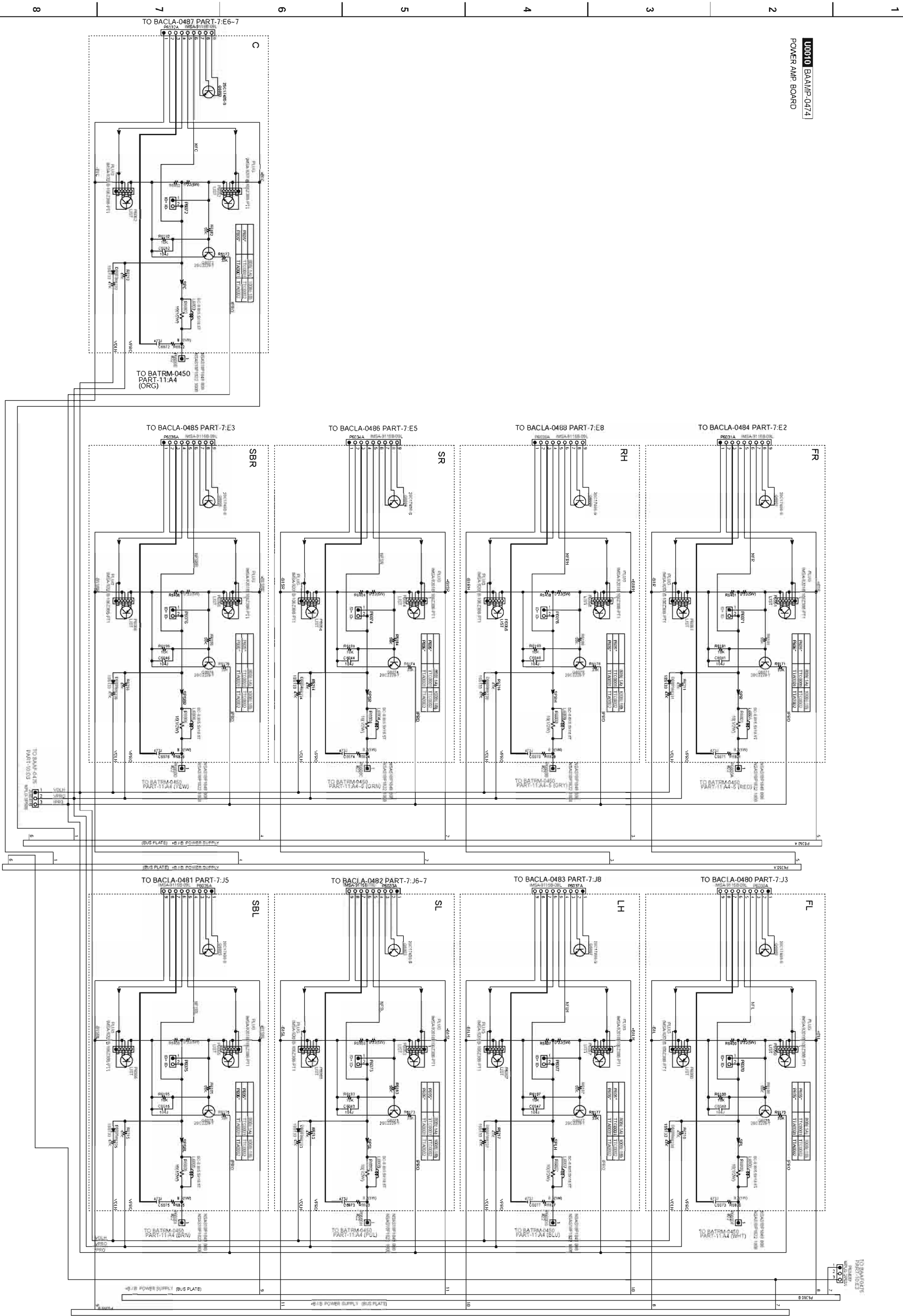

SCHEMATIC DIAGRAMS - 10
AMP (POWER SUPPLY, PROTECT, ETC.) SECTION

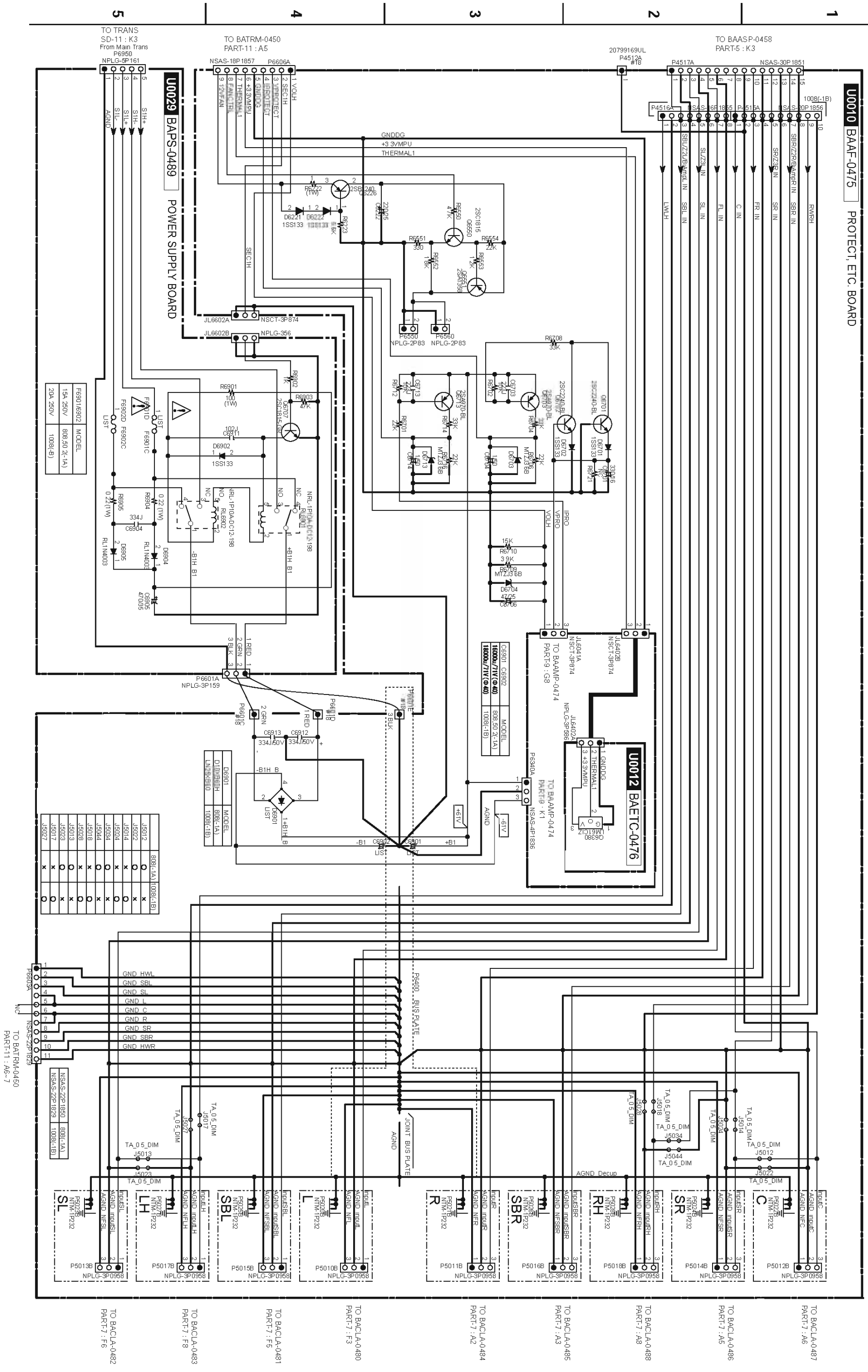

F6901	F6902	MODEL
15A 250V	808 50 2(-1A)	
20A 250V	1008(-B)	

C6901	C6902	MODEL
1000u/7V(9.4)	808 50 2(-1A)	
1000u/7V(9.4)	1008(-B)	

C6901	C6902	MODEL
1000u/7V(9.4)	808 50 2(-1A)	
1000u/7V(9.4)	1008(-B)	

J5012	808(-1A) 1008(-B)
J5022	X
J5014	X
J5024	X
J5034	X
J5044	X
J5018	X
J5028	X
J5013	X
J5023	X
J5017	X
J5027	X

D6901	MODEL
D1102H1H	808(-1A)
D1102H1H	1008(-B)

P5013B	NPLG-3P0958
P5017B	NPLG-3P0958
P5015B	NPLG-3P0958
P5010B	NPLG-3P0958
P5011B	NPLG-3P0958
P5016B	NPLG-3P0958
P5018B	NPLG-3P0958
P5014B	NPLG-3P0958
P5012B	NPLG-3P0958

TA 0.5_DIM	J5017
TA 0.5_DIM	J5027
TA 0.5_DIM	J5013
TA 0.5_DIM	J5023
TA 0.5_DIM	J5018
TA 0.5_DIM	J5028
TA 0.5_DIM	J5013
TA 0.5_DIM	J5023

TO BAACL-0487	PART:7 :A6
TO BAACL-0486	PART:7 :A5
TO BAACL-0485	PART:7 :A3
TO BAACL-0488	PART:7 :A8
TO BAACL-0489	PART:7 :A8
TO BAACL-0484	PART:7 :A2
TO BAACL-0480	PART:7 :F3
TO BAACL-0481	PART:7 :F5
TO BAACL-0483	PART:7 :F8
TO BAACL-0482	PART:7 :F6

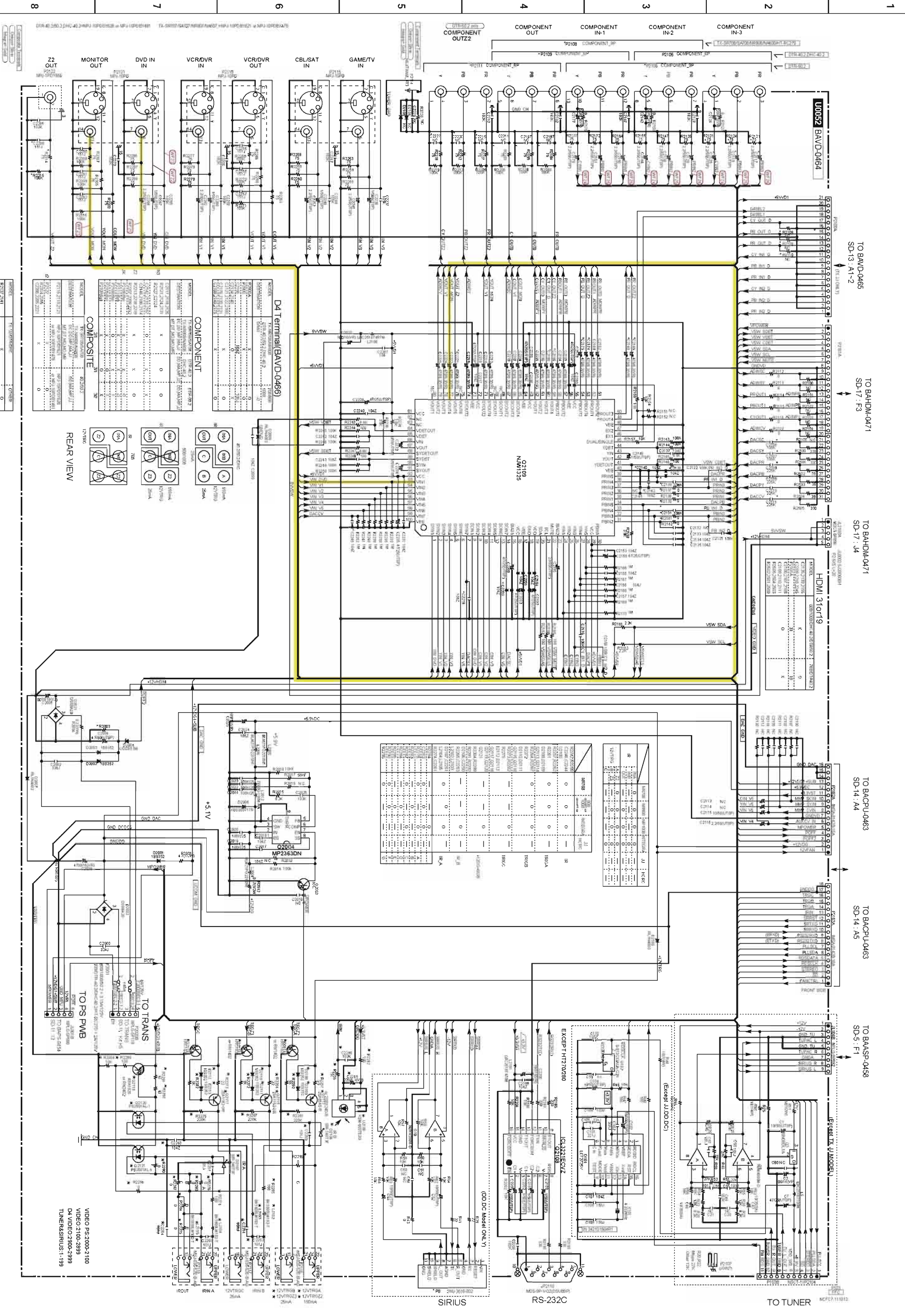

TO BAVD-0466
SD-13: A1-2

TO BAHDM-0471
SD-17: F3

TO BAHDM-0471
SD-17: J4

TO BACP-0463
SD-14: A4

TO BACP-0463
SD-14: A5

TO BAASP-0458
SD-5: F1

D4 Terminal (BAVD-0466)

MODEL	TO COMPONENT	TO COMPOSITE
VIDEO PS-2000-4100	X	0
VIDEO-2100-2899	X	0
DA VIDEO-2900-2999	X	0
TUNERSIRIUS-1-199	X	0

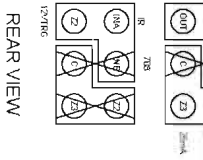

VIDEO PS-2000-4100
VIDEO-2100-2899
DA VIDEO-2900-2999
TUNERSIRIUS-1-199

SCHEMATIC DIAGRAMS - 13

D TERMINALS SECTION

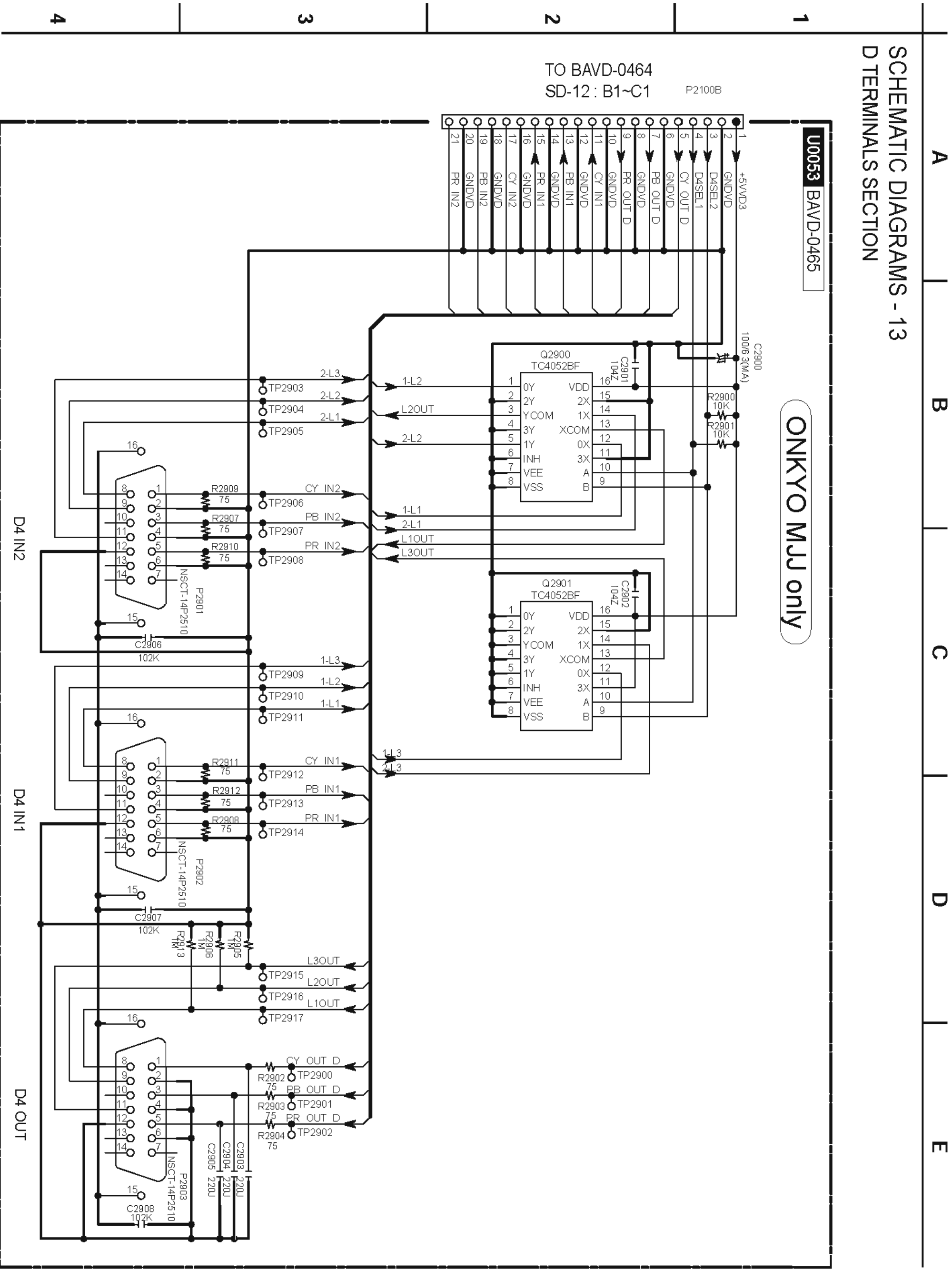

SCHEMATIC DIAGRAMS - 14
MAIN MICROPROCESSOR SECTION

A B C D E F G H I J K

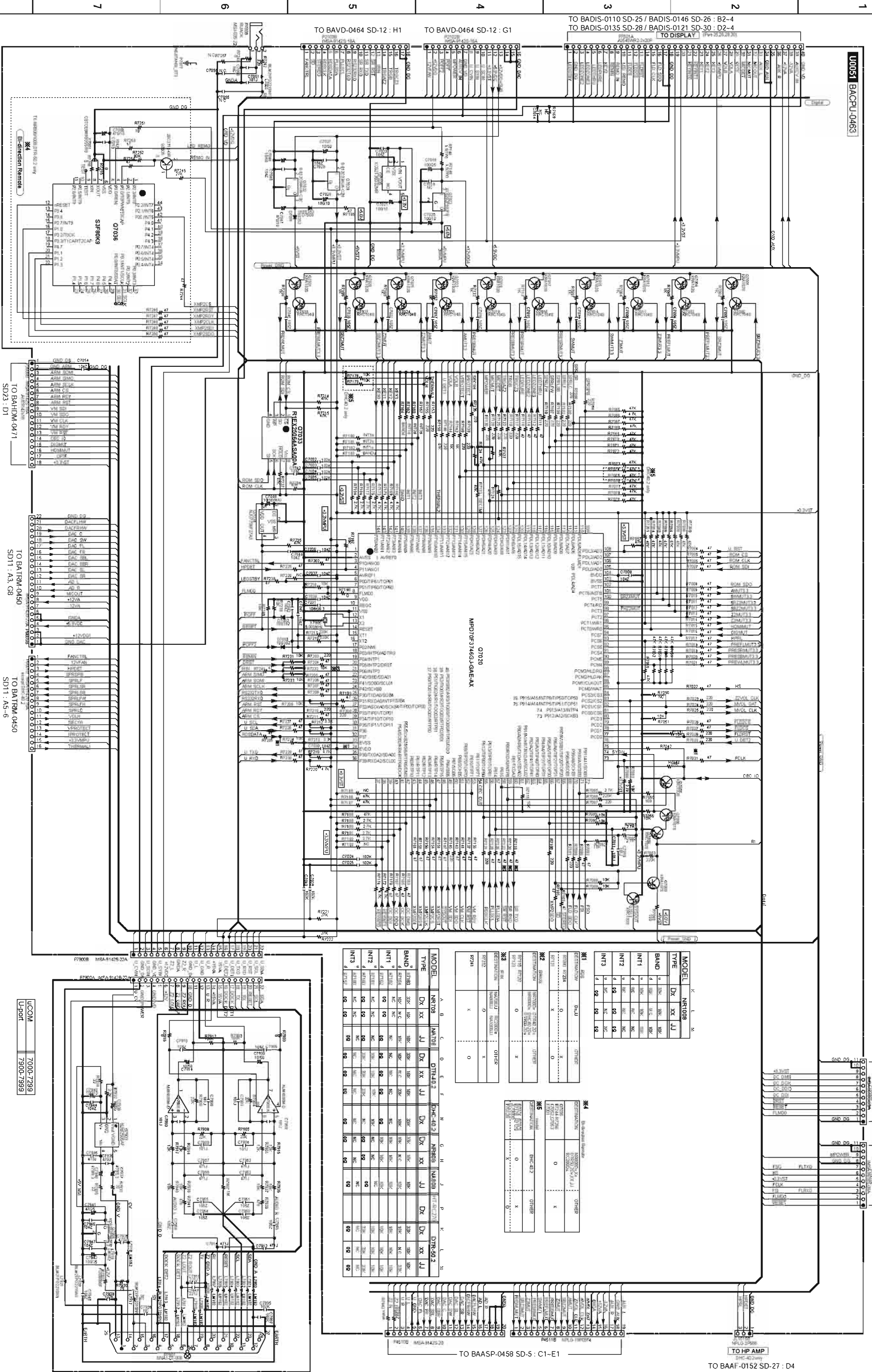

MODEL	NR108	X	L	M
TYPE	DX	XX	JJ	
BAND	4	5	6	7
INT1	4	5	6	7
INT2	4	5	6	7
INT3	4	5	6	7

MODEL	NR108	A	B	C	D	E	F	G	H	I	J	K	L	M
TYPE	DX	XX	JJ	DX	XX	JJ	DX	XX	JJ	DX	XX	JJ	DX	XX
BAND	4	5	6	7	8	9	10	11	12	13	14	15	16	
INT1	4	5	6	7	8	9	10	11	12	13	14	15	16	
INT2	4	5	6	7	8	9	10	11	12	13	14	15	16	
INT3	4	5	6	7	8	9	10	11	12	13	14	15	16	

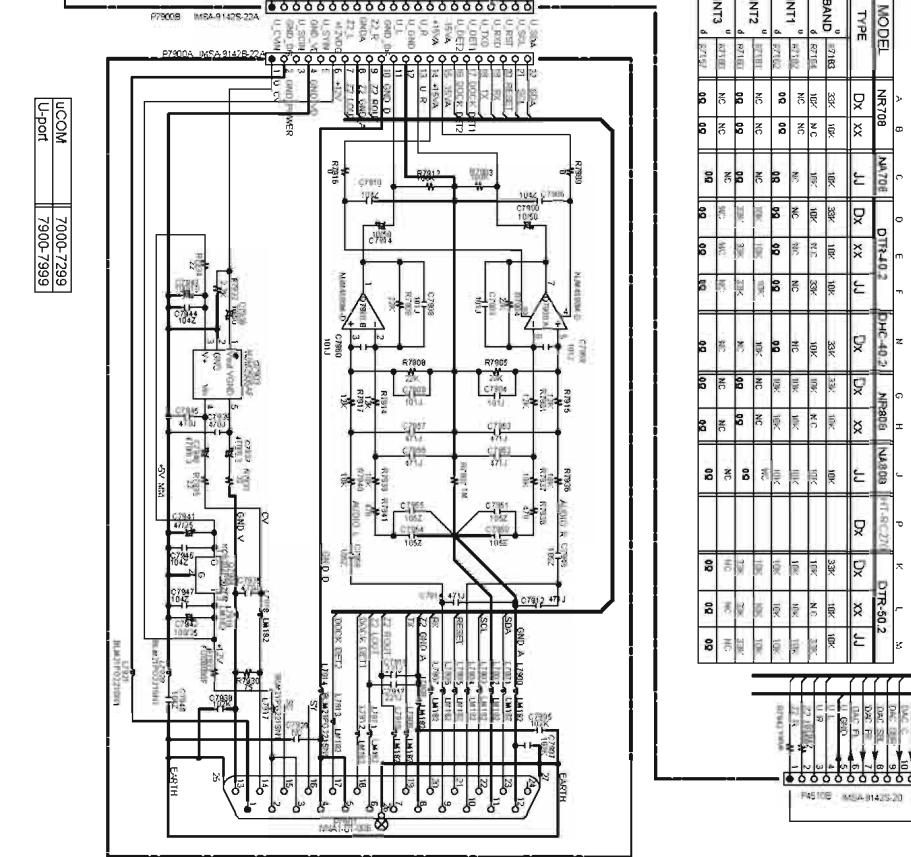

TO BAHDM-0471 SD23 : D1
TO BATHM-0450 SD11 : A3, G8
TO BATHM-0450 SD11 : A5-6
TO BAA5P-0458 SD-5 : C1-E1
TO BAAF-0152 SD-27 : D4

TO BAHOM-04/71
SD-23 : B1

TO BAHOM-04/71
SD-23 : C1

TO BAHOM-04/50
SD-11 : A2

NO	REVISION	DATE	BY	CHKD
1	ISSUED	15/01/2008	U0050	
2	REVISION	15/01/2008	U0050	
3	REVISION	15/01/2008	U0050	
4	REVISION	15/01/2008	U0050	
5	REVISION	15/01/2008	U0050	
6	REVISION	15/01/2008	U0050	
7	REVISION	15/01/2008	U0050	
8	REVISION	15/01/2008	U0050	
9	REVISION	15/01/2008	U0050	
10	REVISION	15/01/2008	U0050	

U0050 BADC-0462

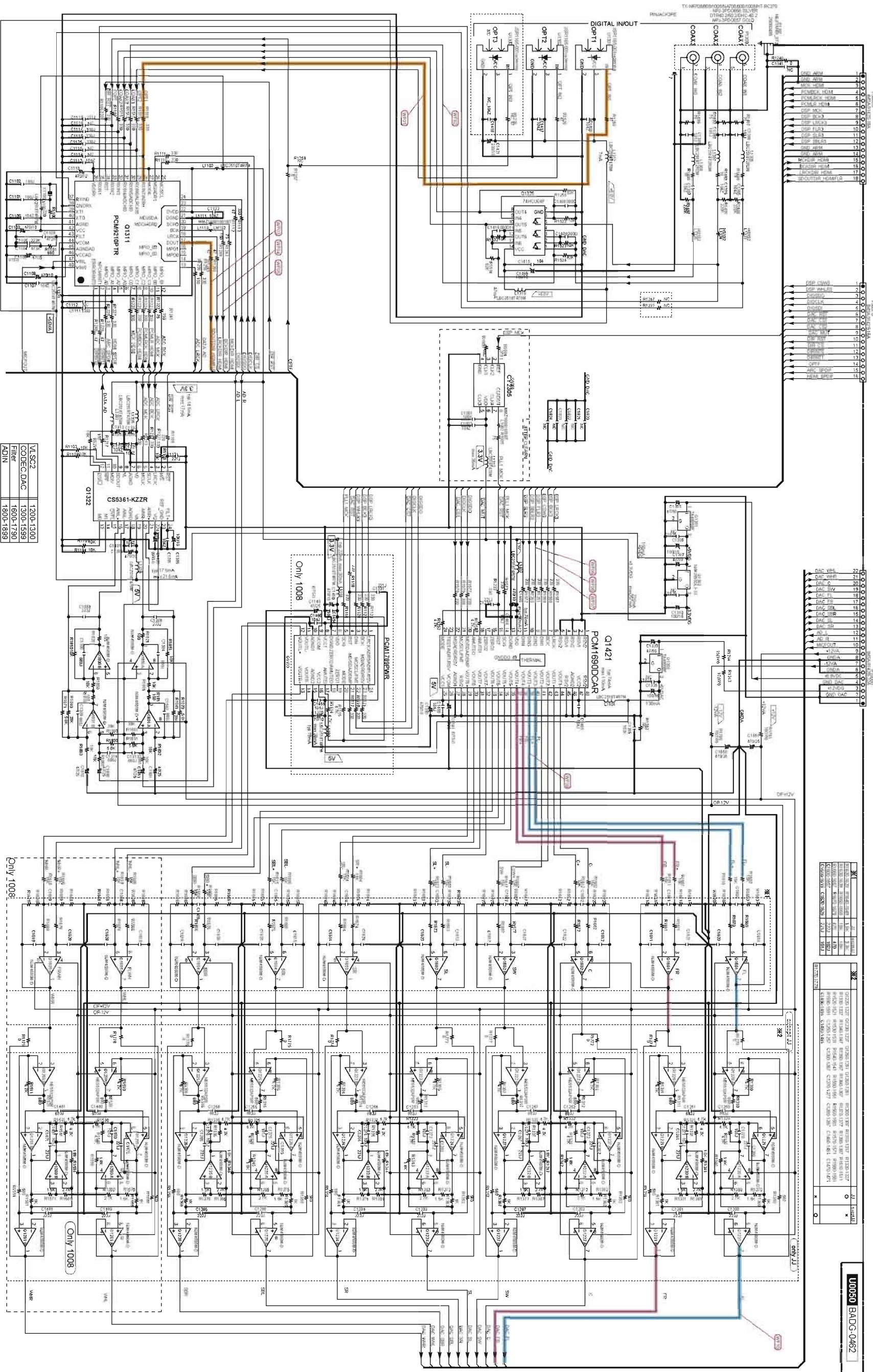

SCHEMATIC DIAGRAMS - 16
HDMI INPUT/OUTPUT SECTION

U007 BAHDM-0471

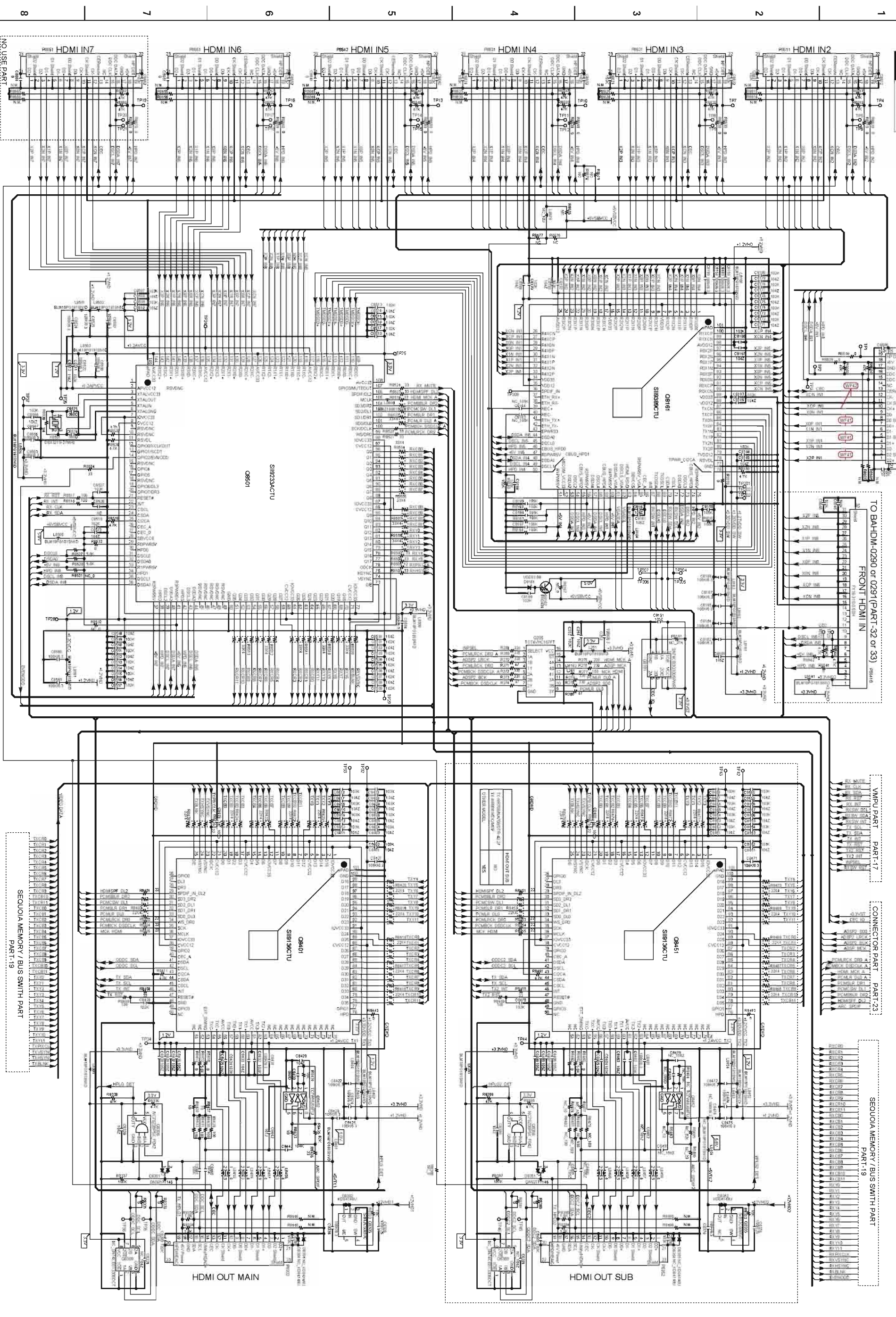

U007 BAHDM-0471

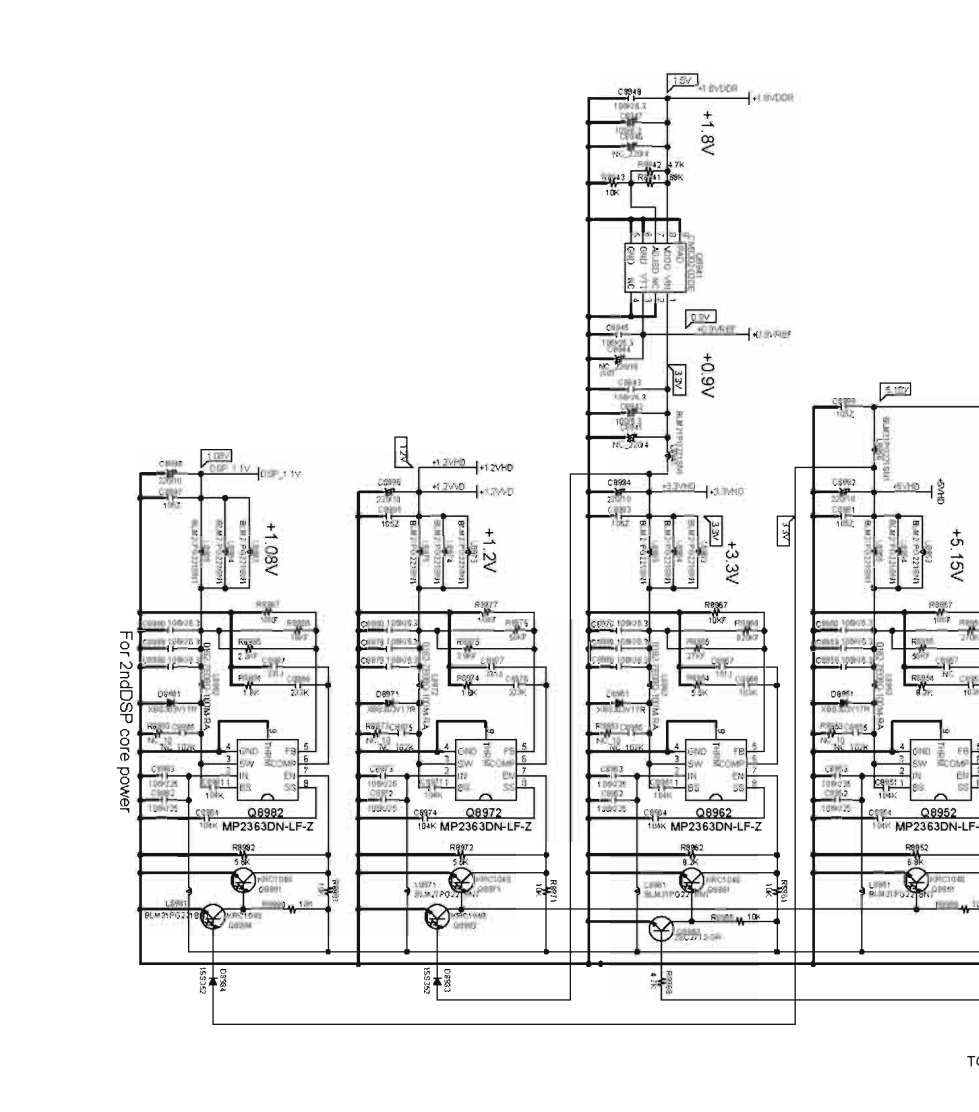
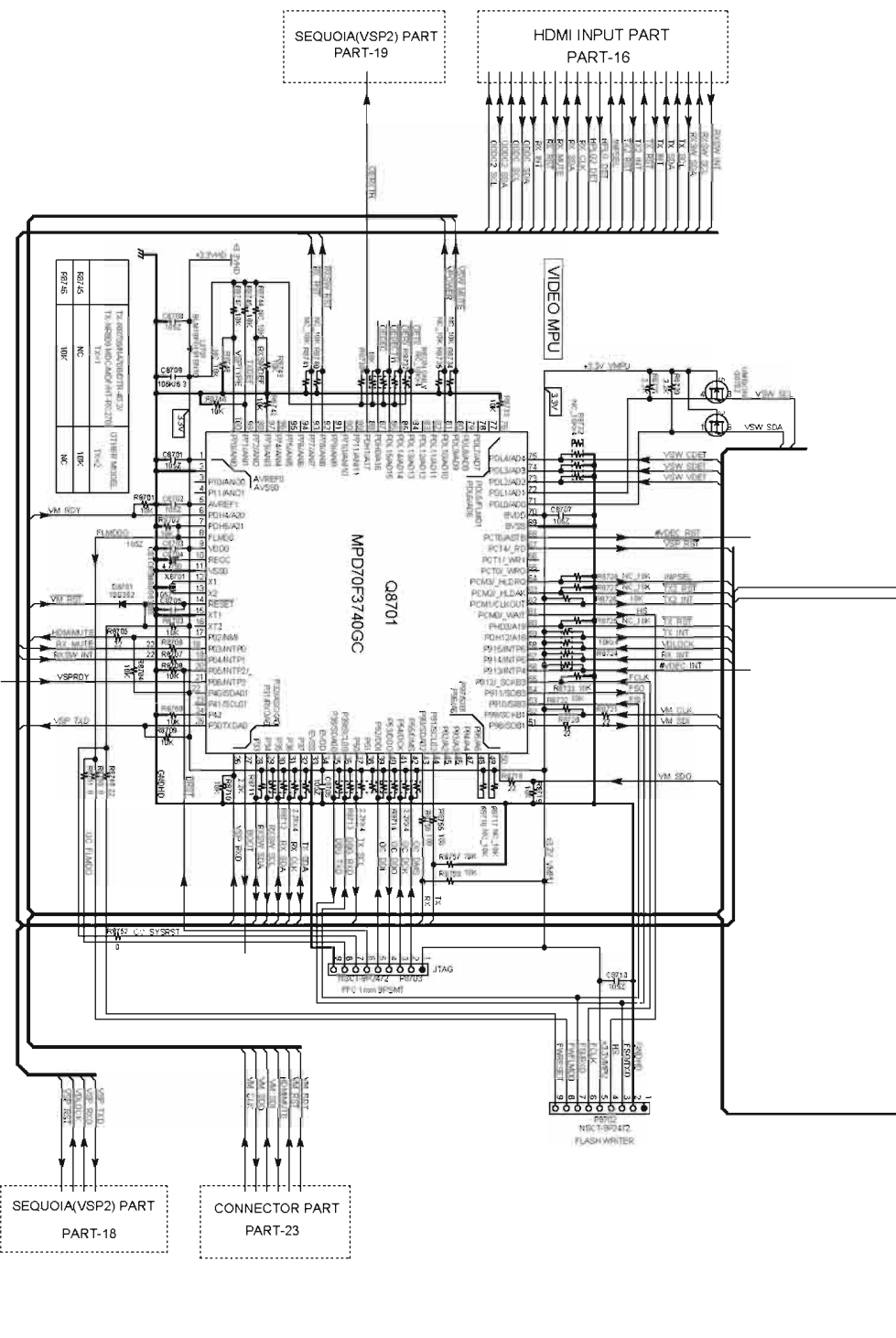
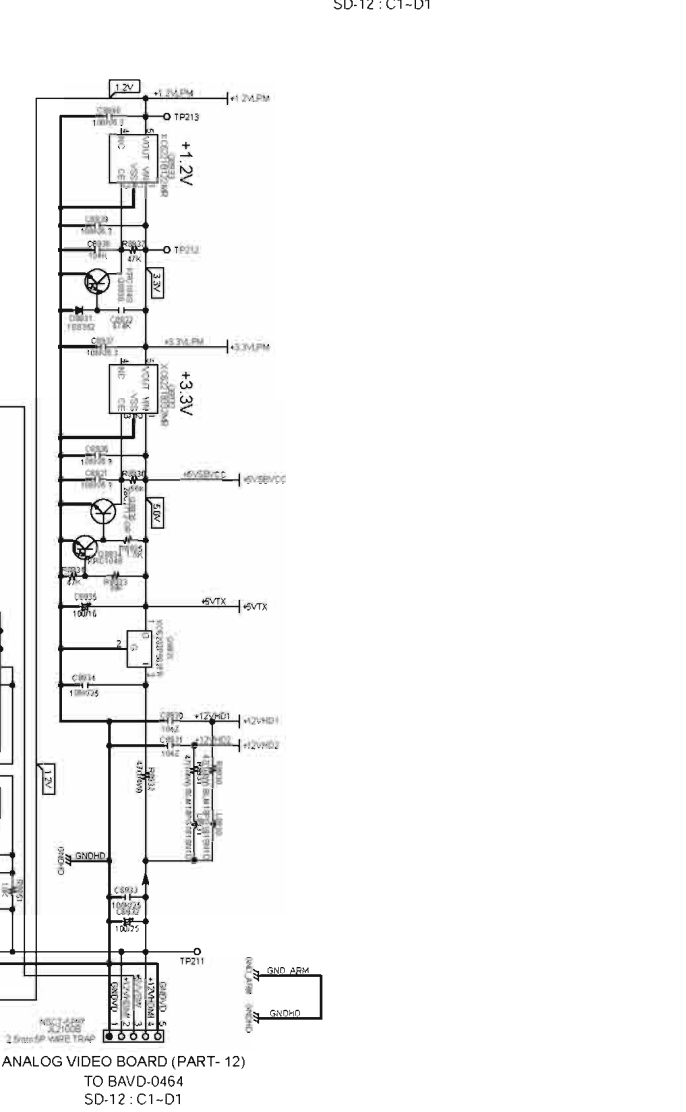
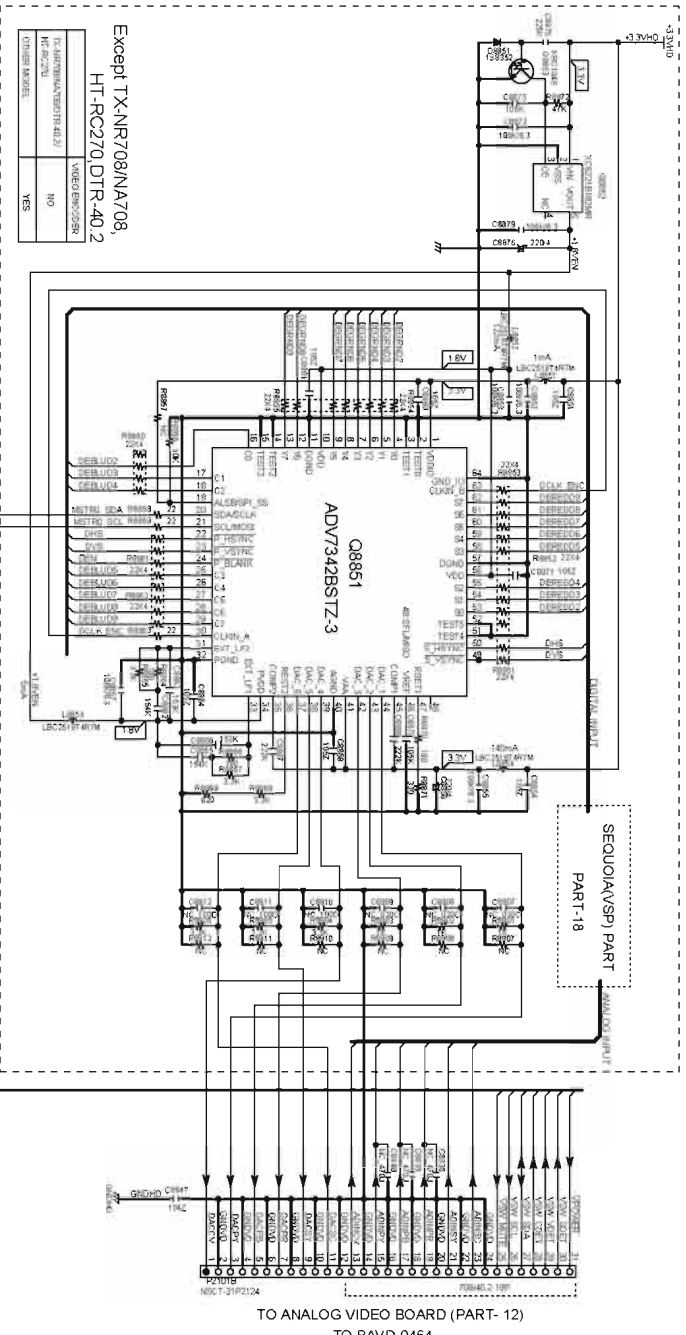

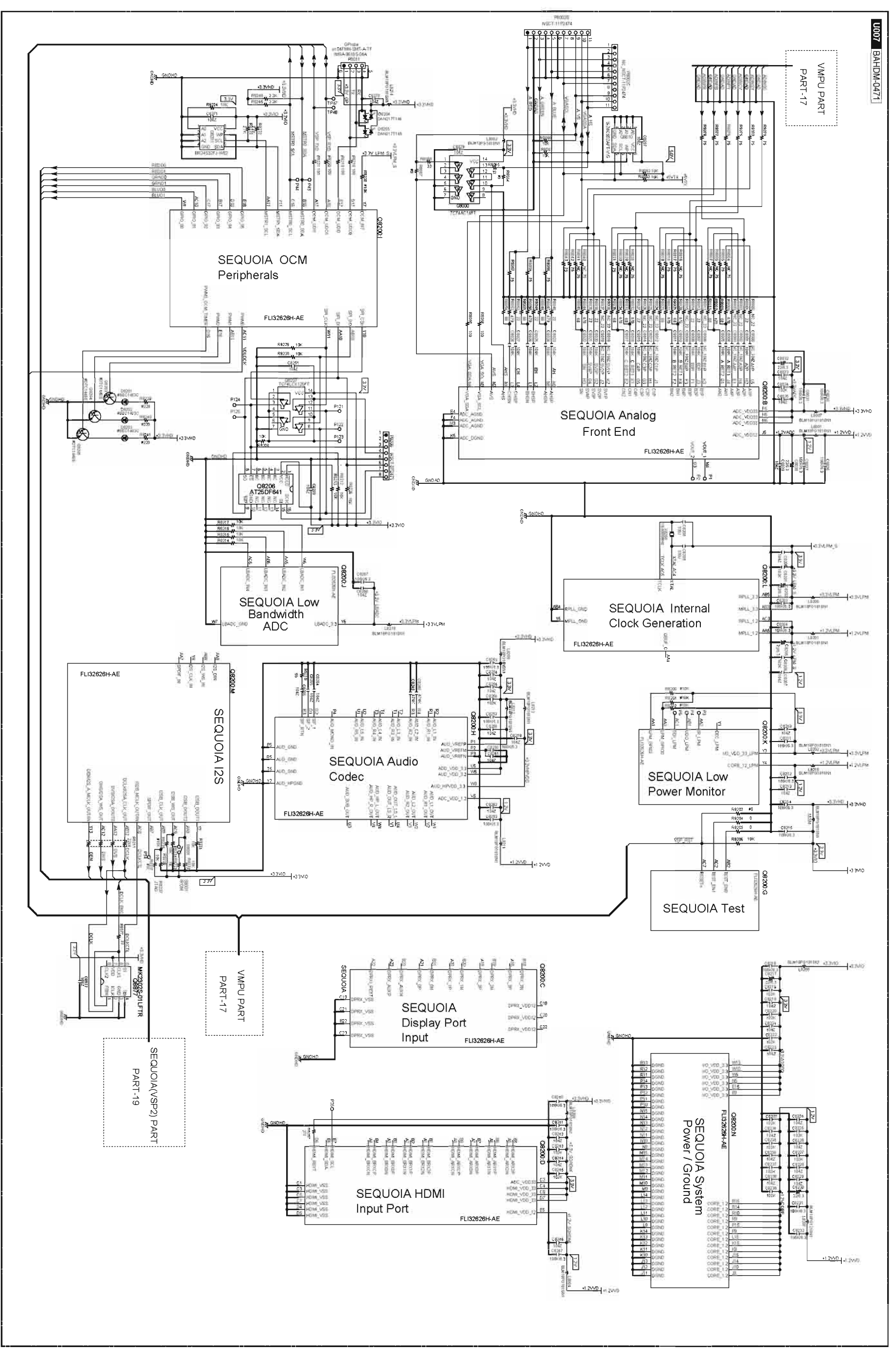

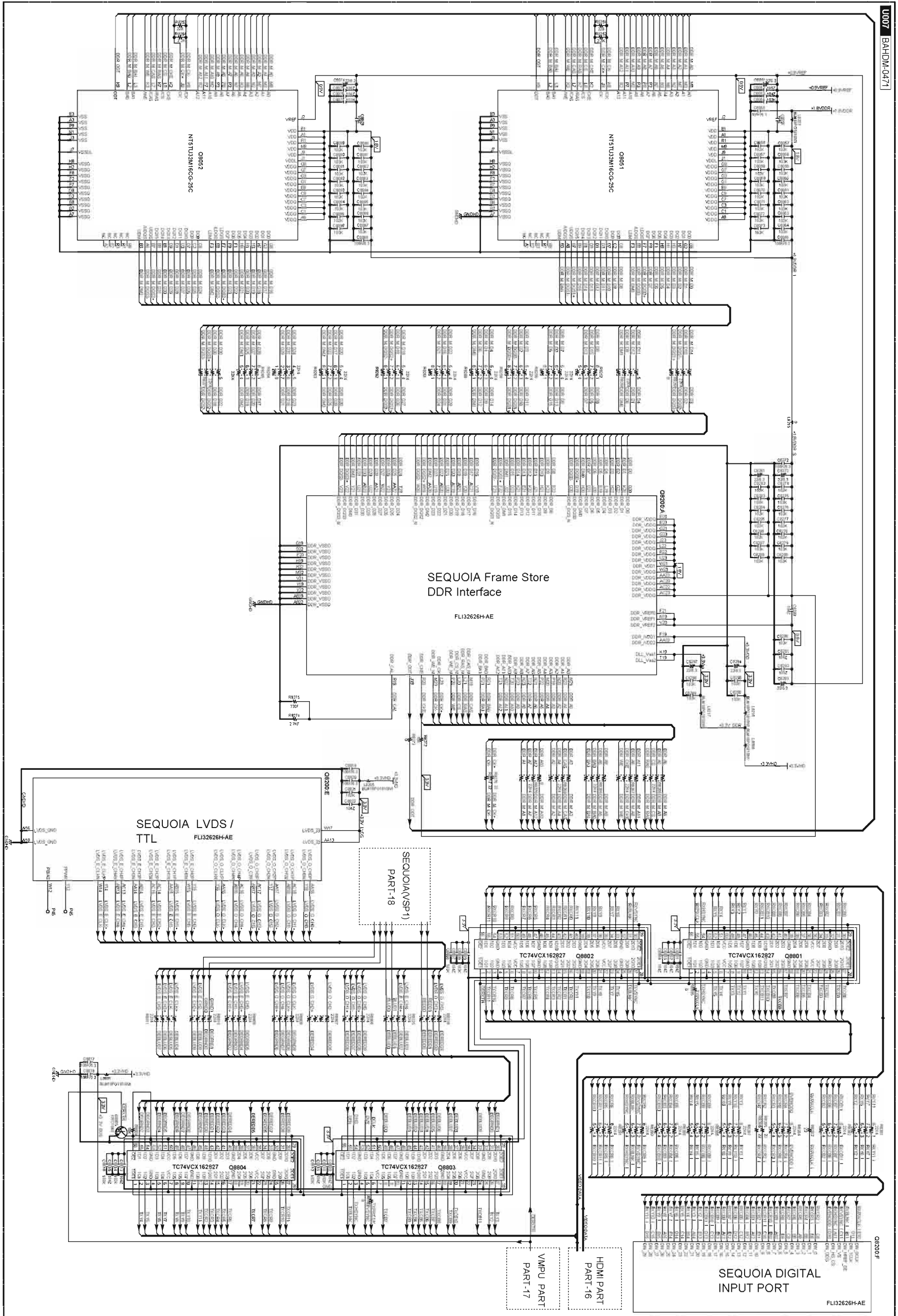

SCHEMATIC DIAGRAMS - 20
DSP/AUDIO/GPIO SECTION

A B C D E F G H

U007 BAHDM-0471

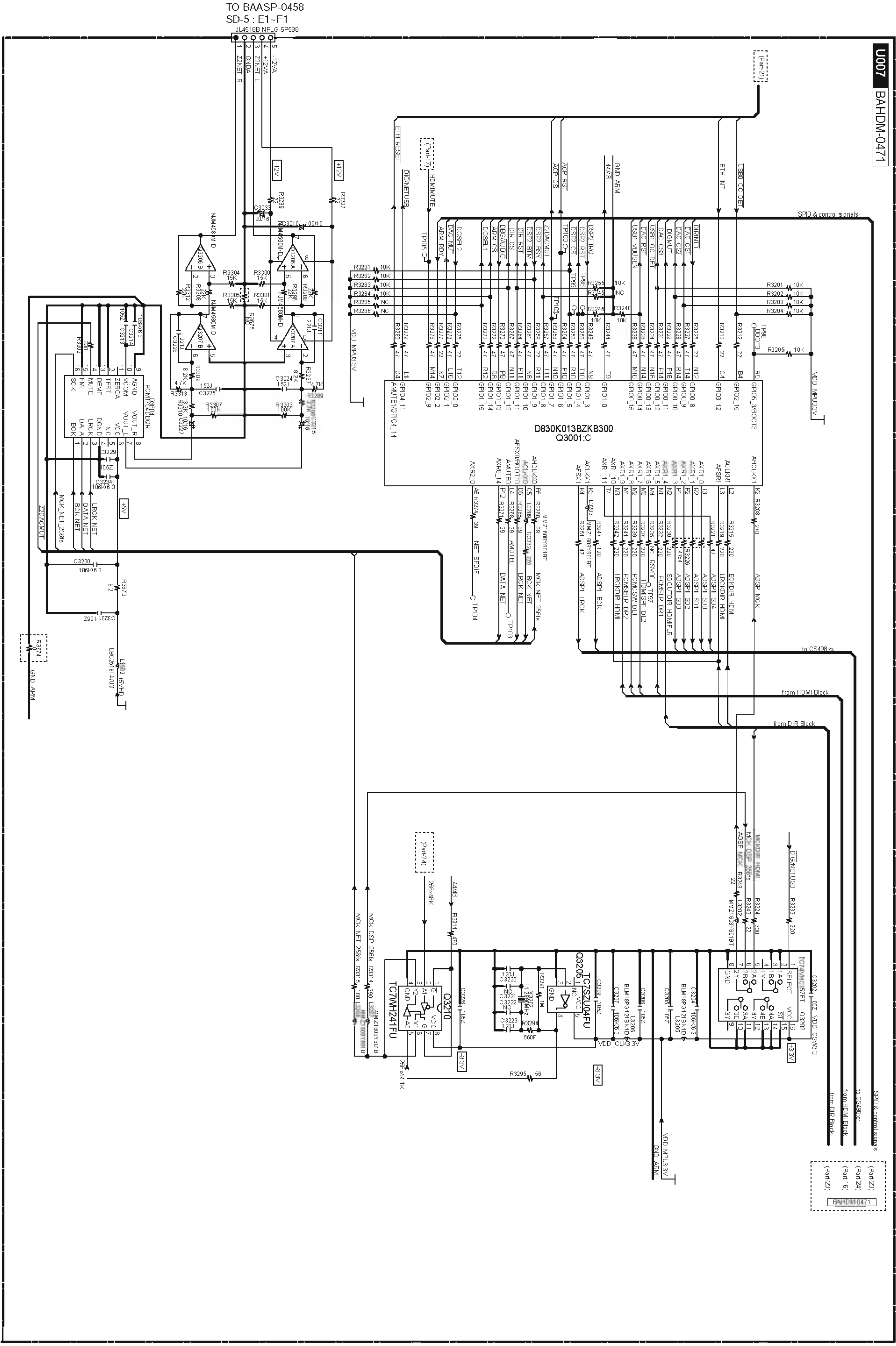

TO BAASP-0458
SD-5: E1-F1
JL4518B NPL G-5P588

5

4

3

2

1

SCHEMATIC DIAGRAMS - 21
NET/USB POWER SECTION

U007 BAHDM-0471

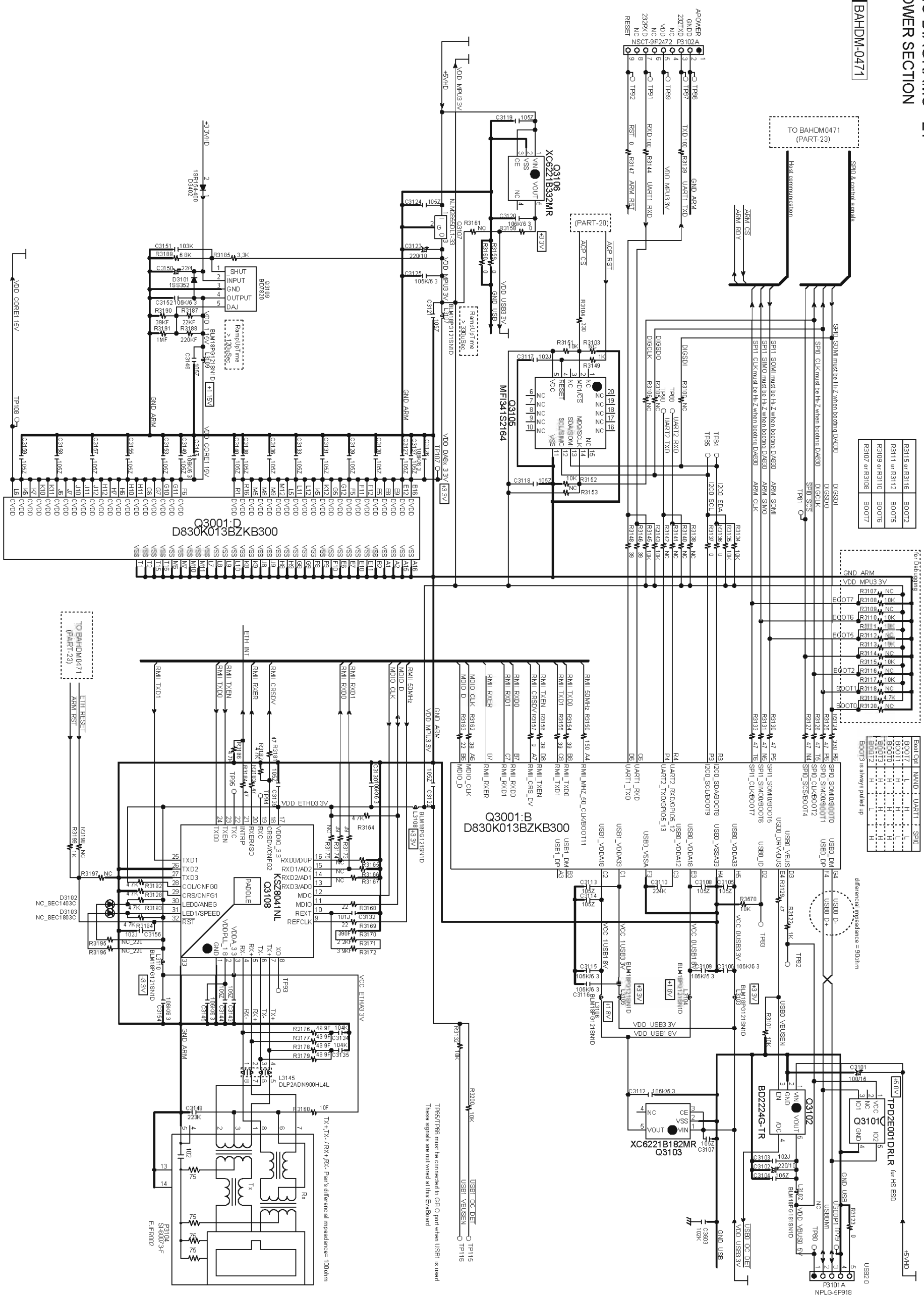

R3115 or R3116	BOOT2
R3111 or R3112	BOOT5
R3109 or R3110	BOOT6
R3107 or R3108	BOOT7

BOOT0	NAND1	UART1	SPD0
BOOT1	L	L	L
BOOT2	L	L	L
BOOT3	L	L	L
BOOT4	L	L	L
BOOT5	L	L	L
BOOT6	L	L	L
BOOT7	L	L	L
BOOT8	L	L	L
BOOT9	L	L	L
BOOT10	L	L	L
BOOT11	L	L	L
BOOT12	L	L	L
BOOT13	L	L	L
BOOT14	L	L	L
BOOT15	L	L	L
BOOT16	L	L	L
BOOT17	L	L	L
BOOT18	L	L	L
BOOT19	L	L	L
BOOT20	L	L	L
BOOT21	L	L	L
BOOT22	L	L	L
BOOT23	L	L	L
BOOT24	L	L	L
BOOT25	L	L	L
BOOT26	L	L	L
BOOT27	L	L	L
BOOT28	L	L	L
BOOT29	L	L	L
BOOT30	L	L	L
BOOT31	L	L	L
BOOT32	L	L	L
BOOT33	L	L	L
BOOT34	L	L	L
BOOT35	L	L	L
BOOT36	L	L	L
BOOT37	L	L	L
BOOT38	L	L	L
BOOT39	L	L	L
BOOT40	L	L	L
BOOT41	L	L	L
BOOT42	L	L	L
BOOT43	L	L	L
BOOT44	L	L	L
BOOT45	L	L	L
BOOT46	L	L	L
BOOT47	L	L	L
BOOT48	L	L	L
BOOT49	L	L	L
BOOT50	L	L	L
BOOT51	L	L	L
BOOT52	L	L	L
BOOT53	L	L	L
BOOT54	L	L	L
BOOT55	L	L	L
BOOT56	L	L	L
BOOT57	L	L	L
BOOT58	L	L	L
BOOT59	L	L	L
BOOT60	L	L	L
BOOT61	L	L	L
BOOT62	L	L	L
BOOT63	L	L	L
BOOT64	L	L	L
BOOT65	L	L	L
BOOT66	L	L	L
BOOT67	L	L	L
BOOT68	L	L	L
BOOT69	L	L	L
BOOT70	L	L	L
BOOT71	L	L	L
BOOT72	L	L	L
BOOT73	L	L	L
BOOT74	L	L	L
BOOT75	L	L	L
BOOT76	L	L	L
BOOT77	L	L	L
BOOT78	L	L	L
BOOT79	L	L	L
BOOT80	L	L	L
BOOT81	L	L	L
BOOT82	L	L	L
BOOT83	L	L	L
BOOT84	L	L	L
BOOT85	L	L	L
BOOT86	L	L	L
BOOT87	L	L	L
BOOT88	L	L	L
BOOT89	L	L	L
BOOT90	L	L	L
BOOT91	L	L	L
BOOT92	L	L	L
BOOT93	L	L	L
BOOT94	L	L	L
BOOT95	L	L	L
BOOT96	L	L	L
BOOT97	L	L	L
BOOT98	L	L	L
BOOT99	L	L	L
BOOT100	L	L	L

TO BAETC-0468
SD-32 : B4
TO BAETC-0469
SD-32 : E4

SCHEMATIC DIAGRAMS - 22
1ST DSP MEMORY SECTION

A B C D E F G H

U007 BAHDM-0471

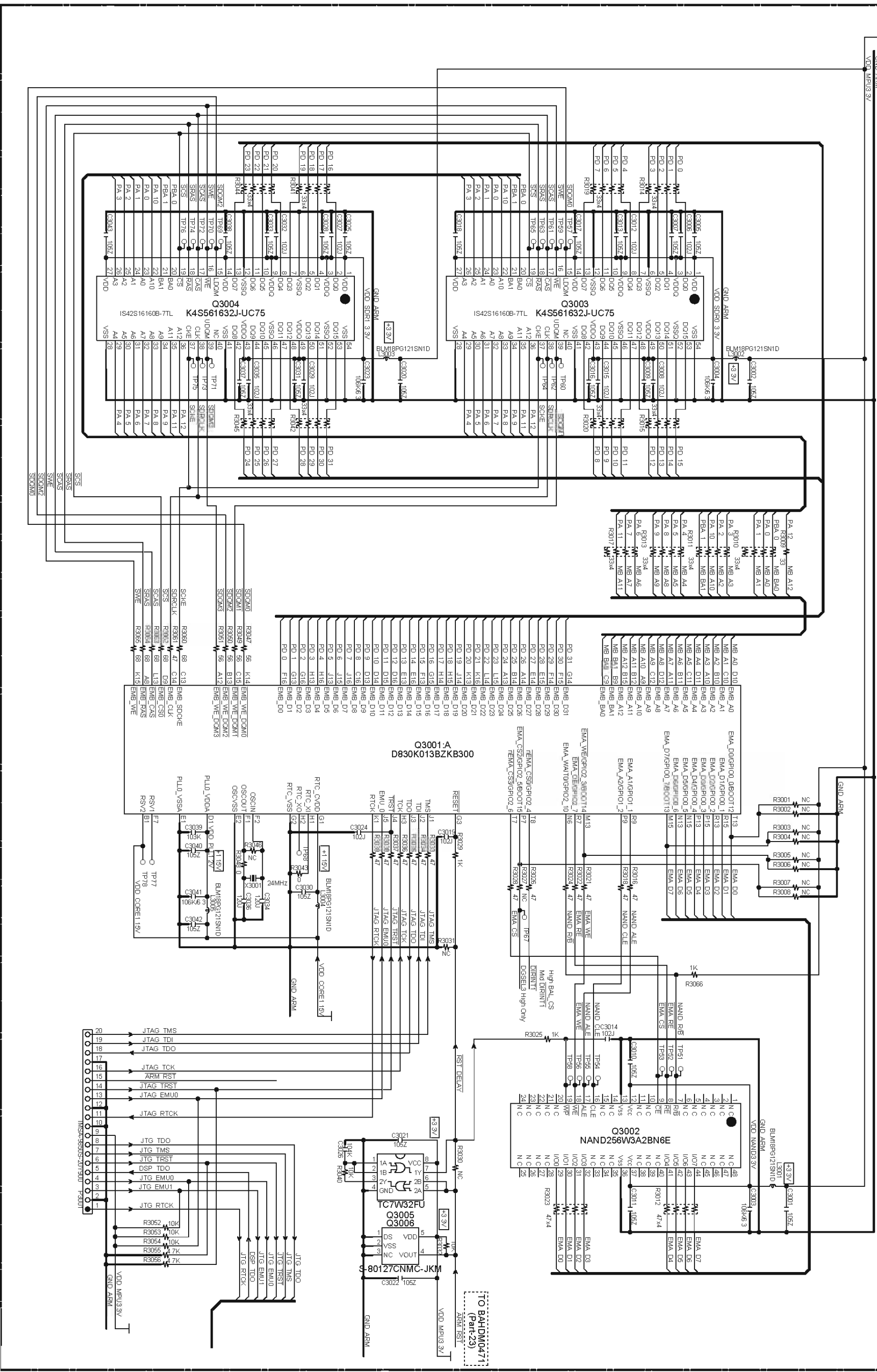

5

4

3

2

1

SCHEMATIC DIAGRAMS - 23
DSP CONNECT SECTION

A | B | C | D | E

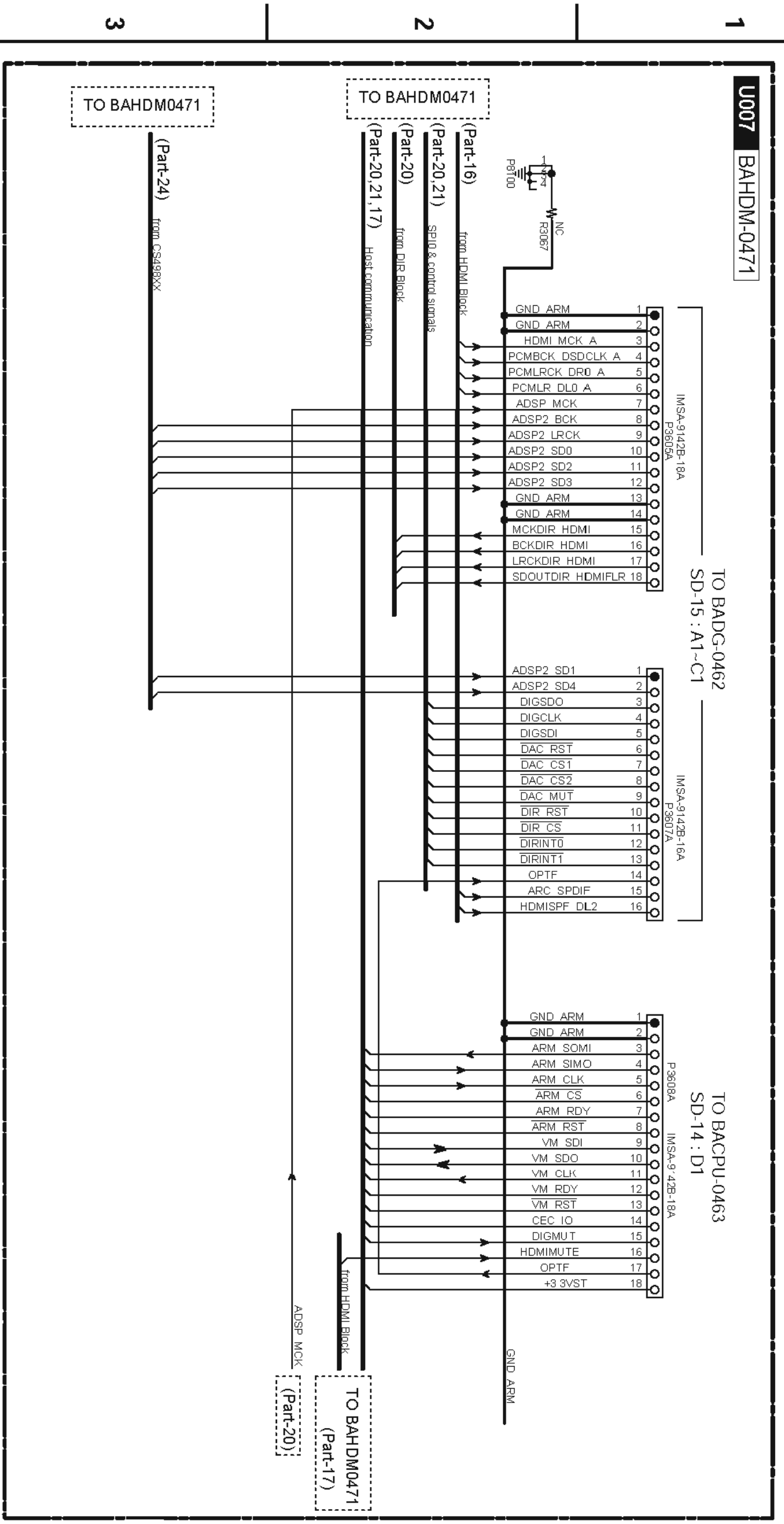

SCHEMATIC DIAGRAMS - 24
2ND DSP SECTION

A B C D E F G H

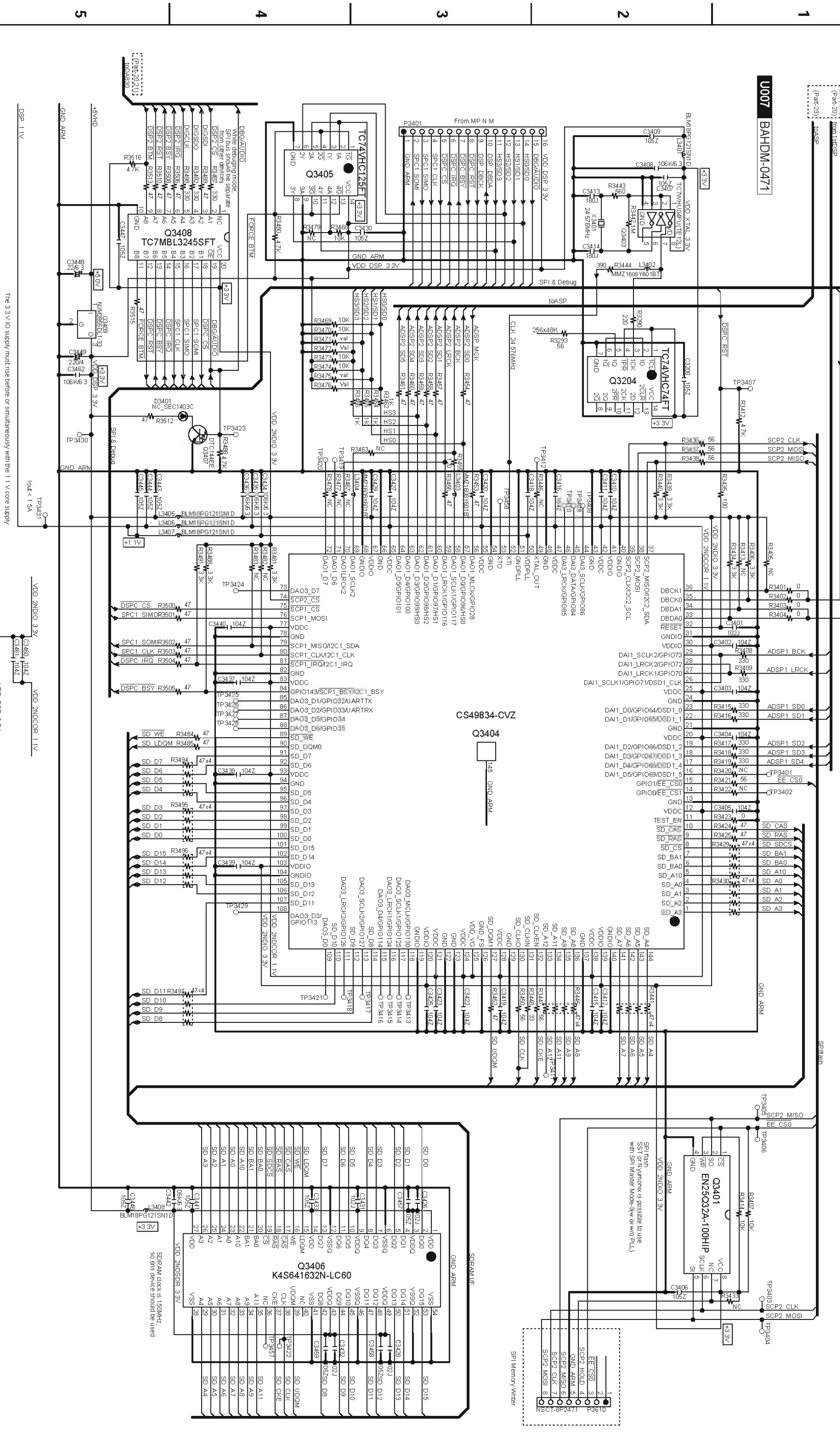

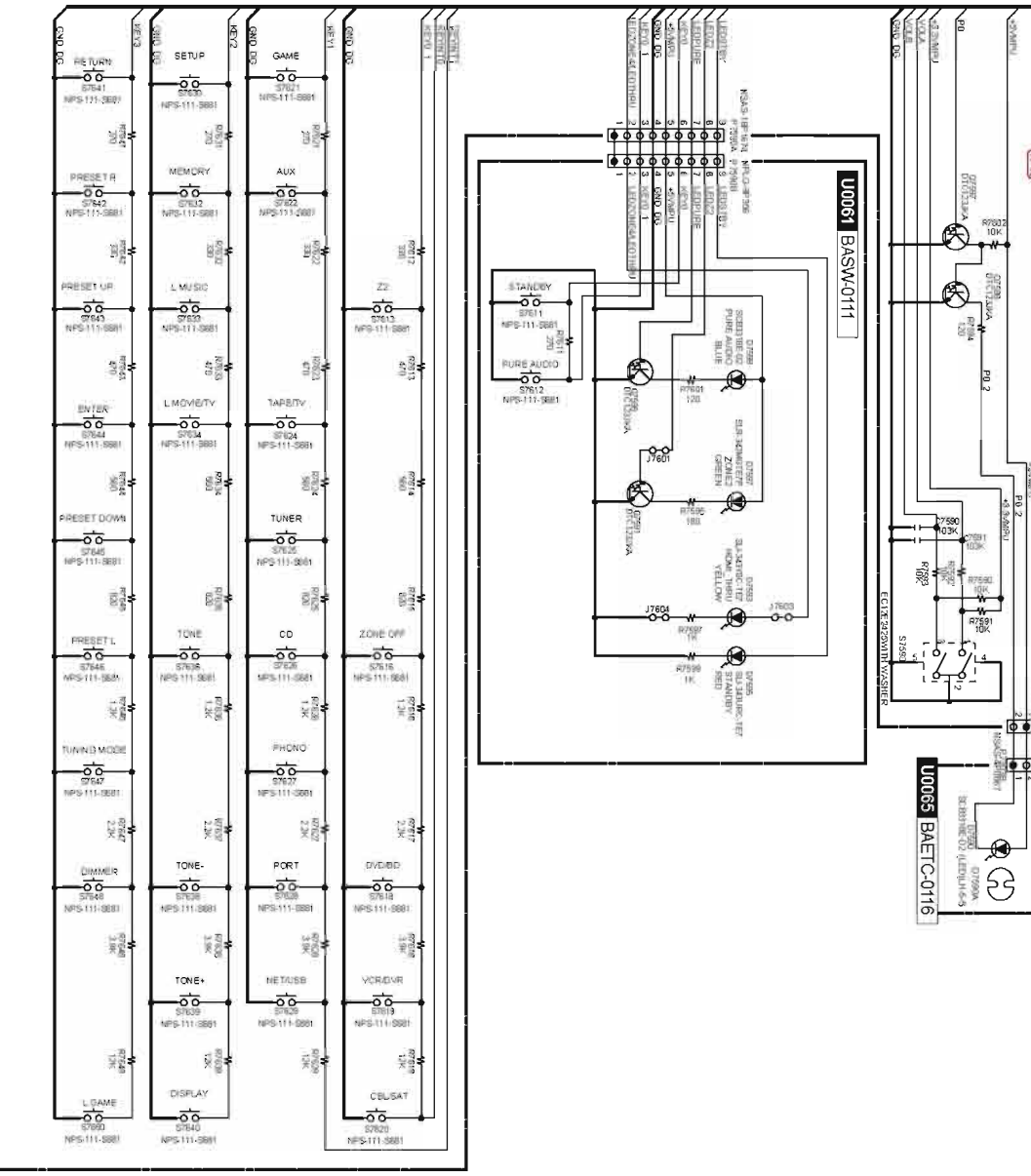
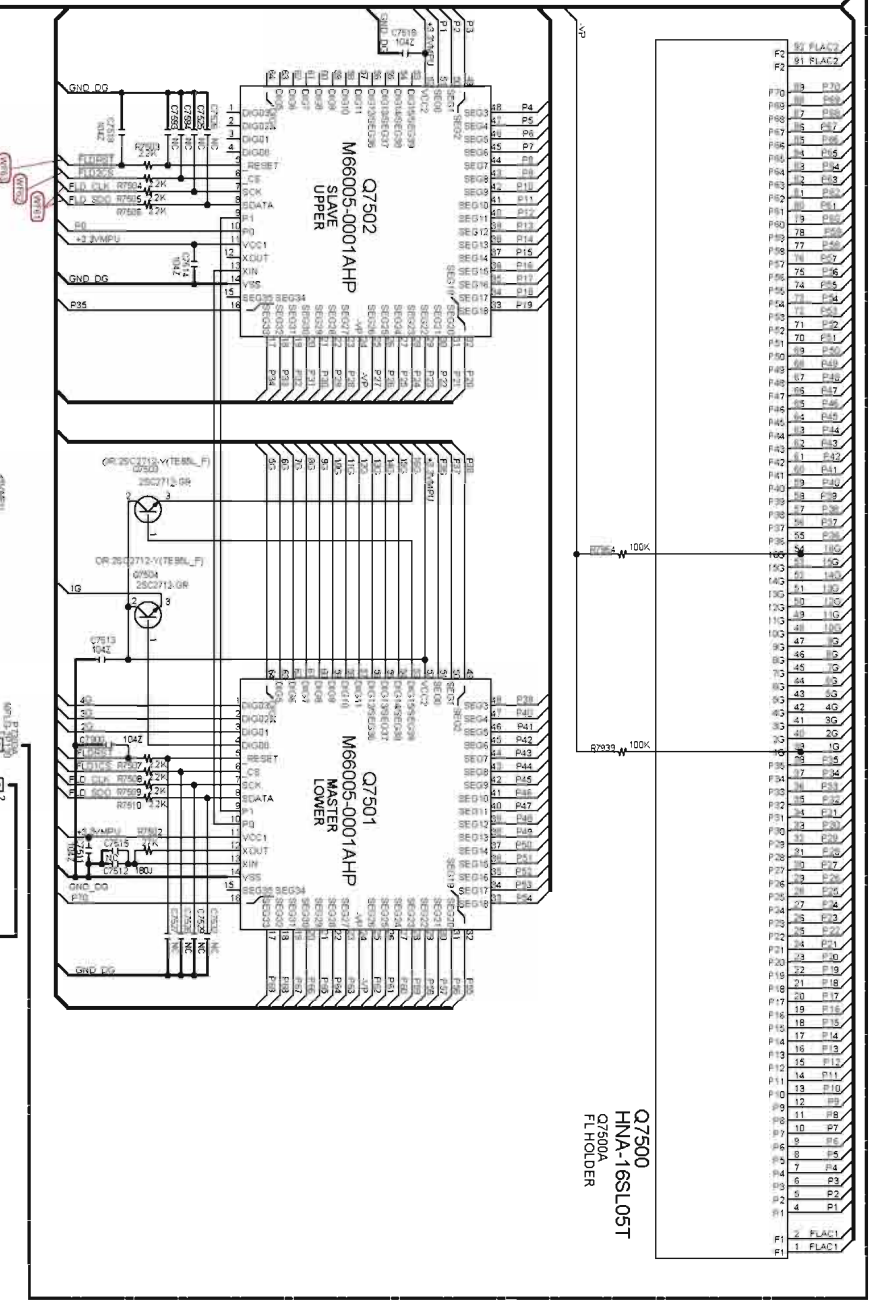
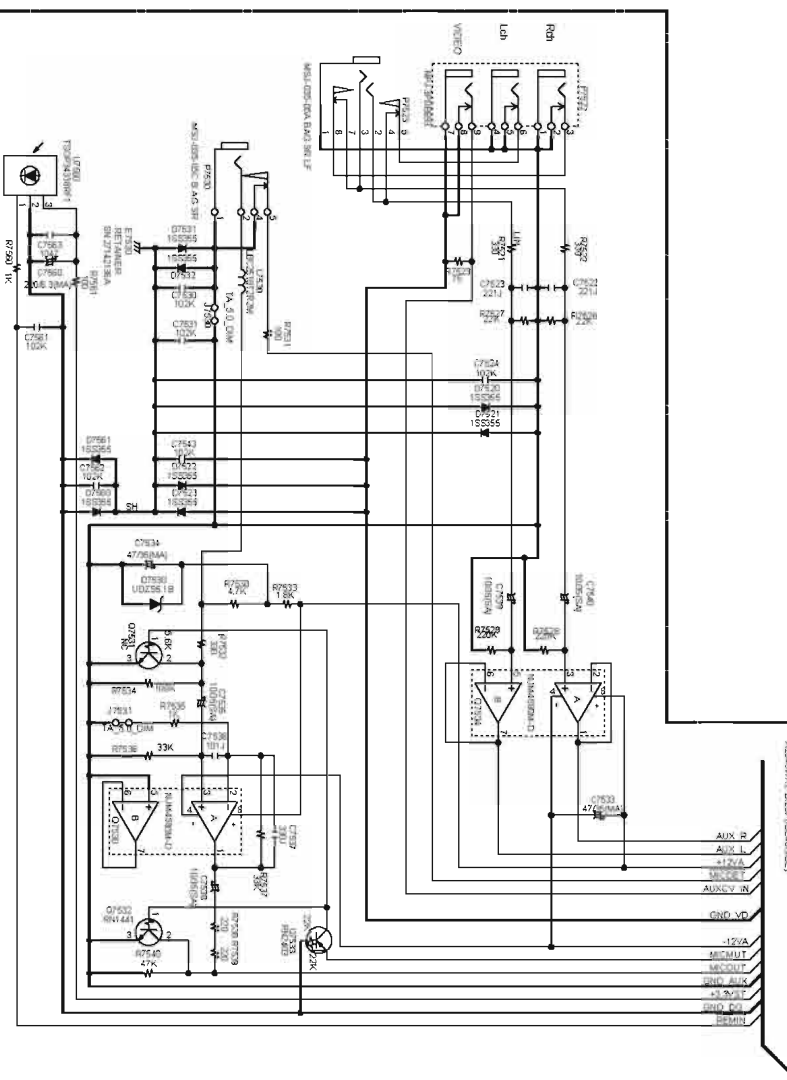
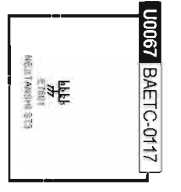
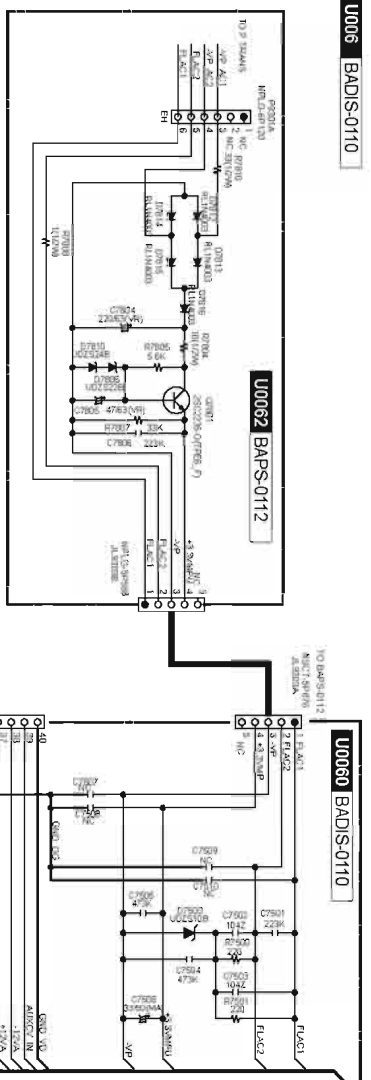

U006 BADIS-0148(1/2)

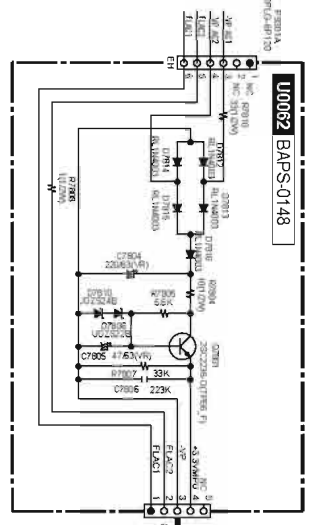

U0060 BADIS-0146

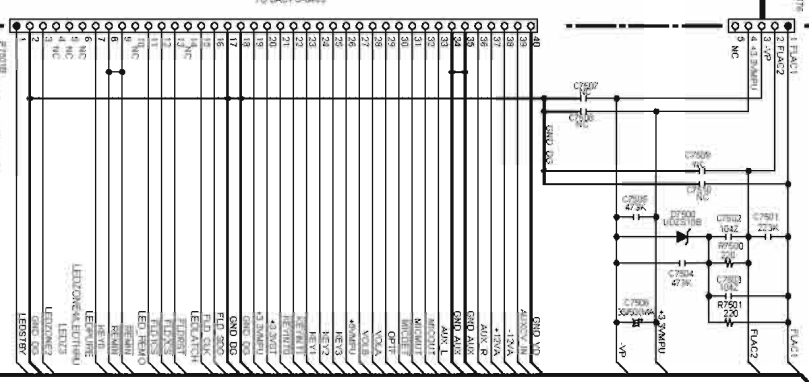

U0007 BAET C-0155

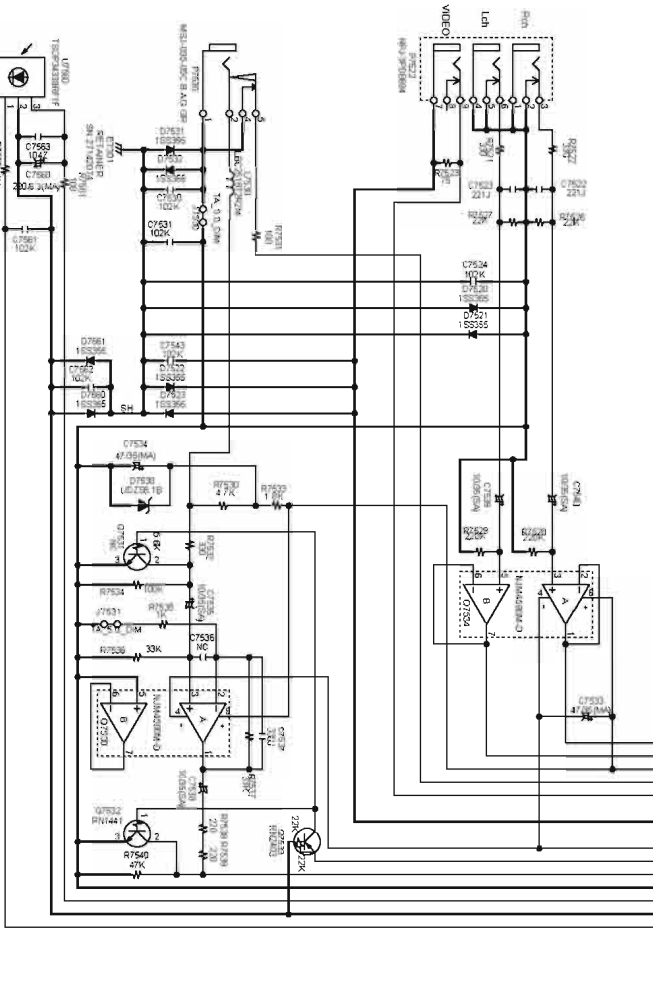
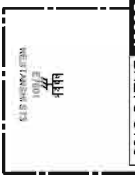

Q7500
HNA-16SL05T
Q7500A
FL HOLDER

U0001 BASW-0147

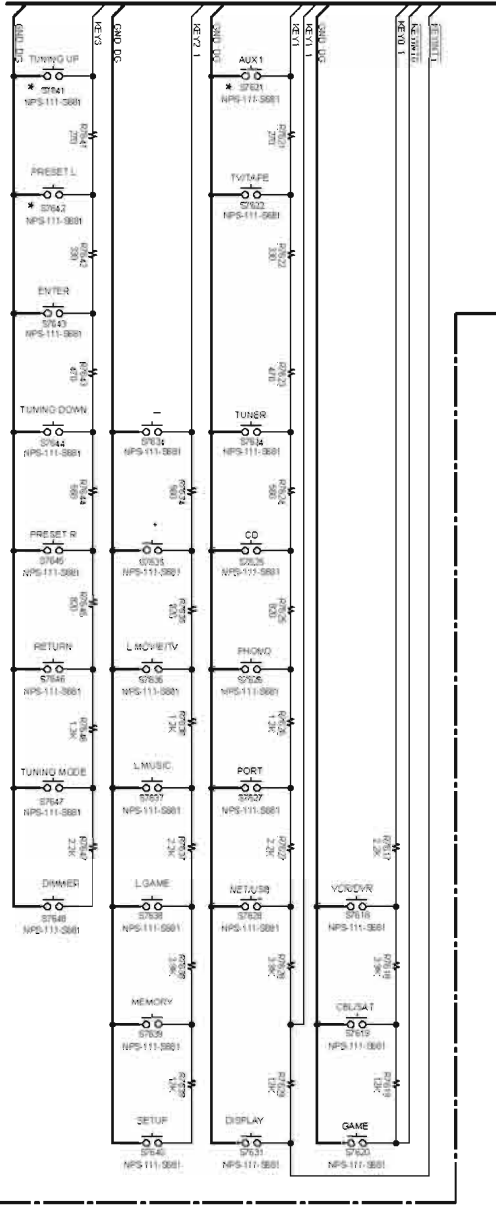
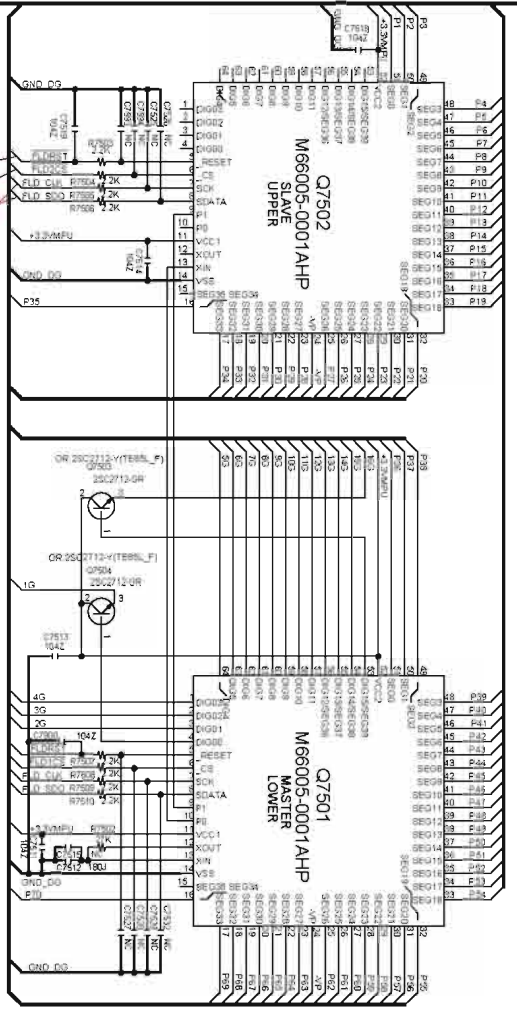
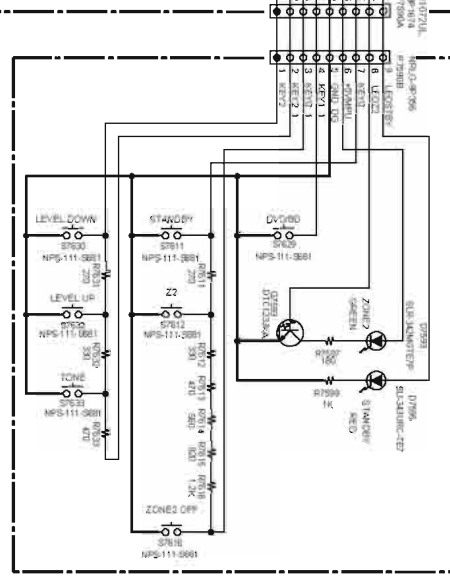

SCHEMATIC DIAGRAMS - 27 HEAD PHONE AMP SECTION

A | B | C | D | E

U006 BADIS-0146

U0065 BAAF-0152

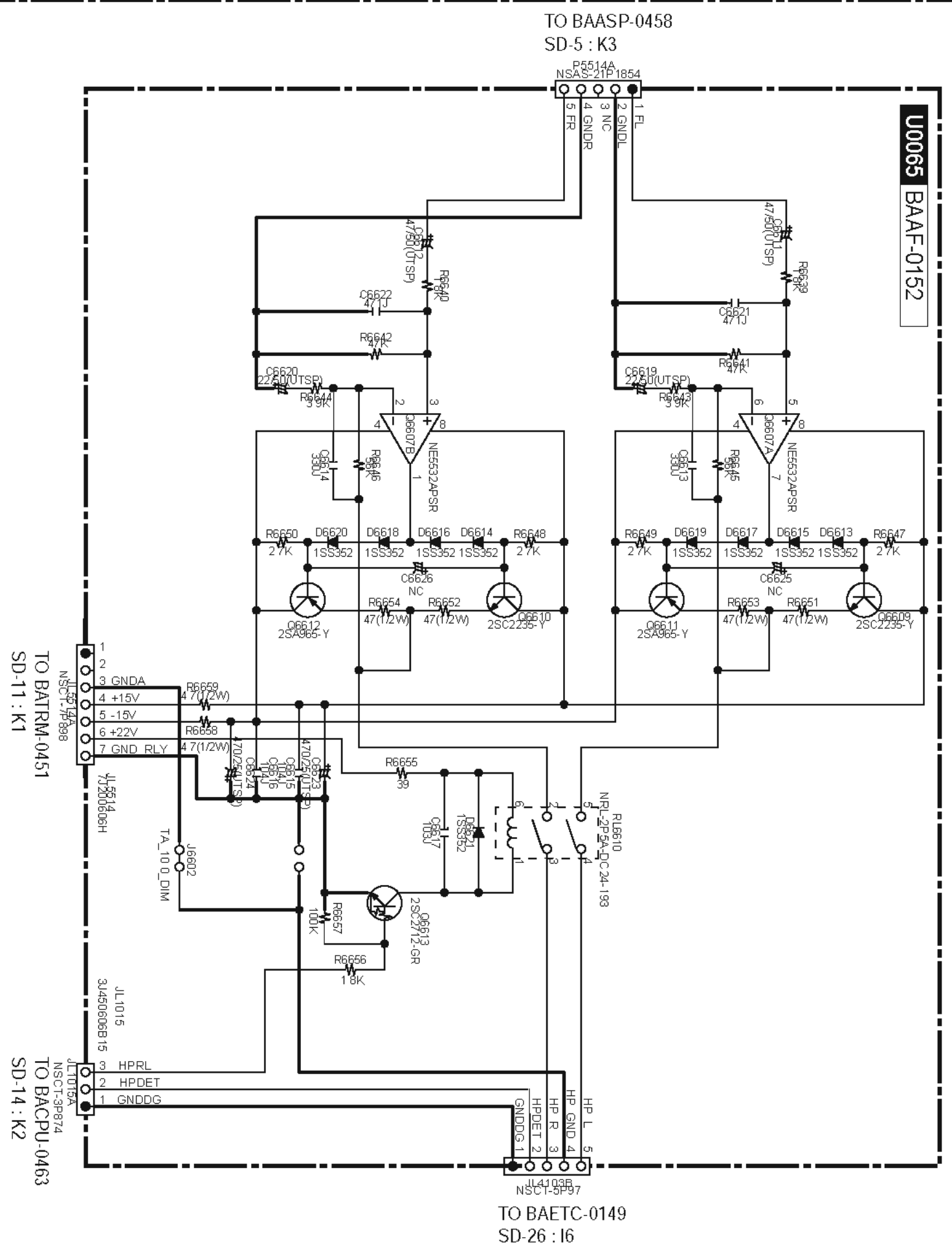

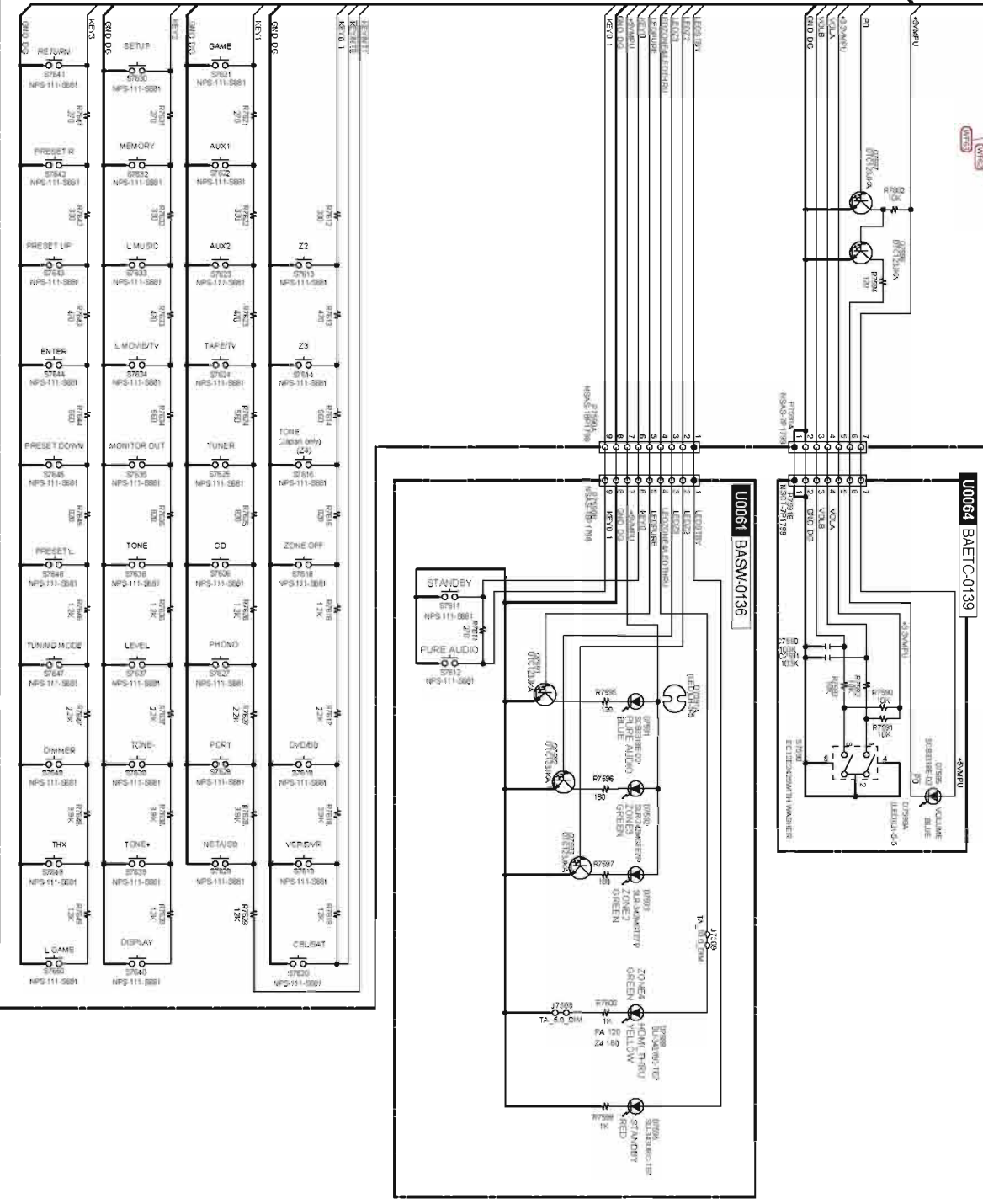
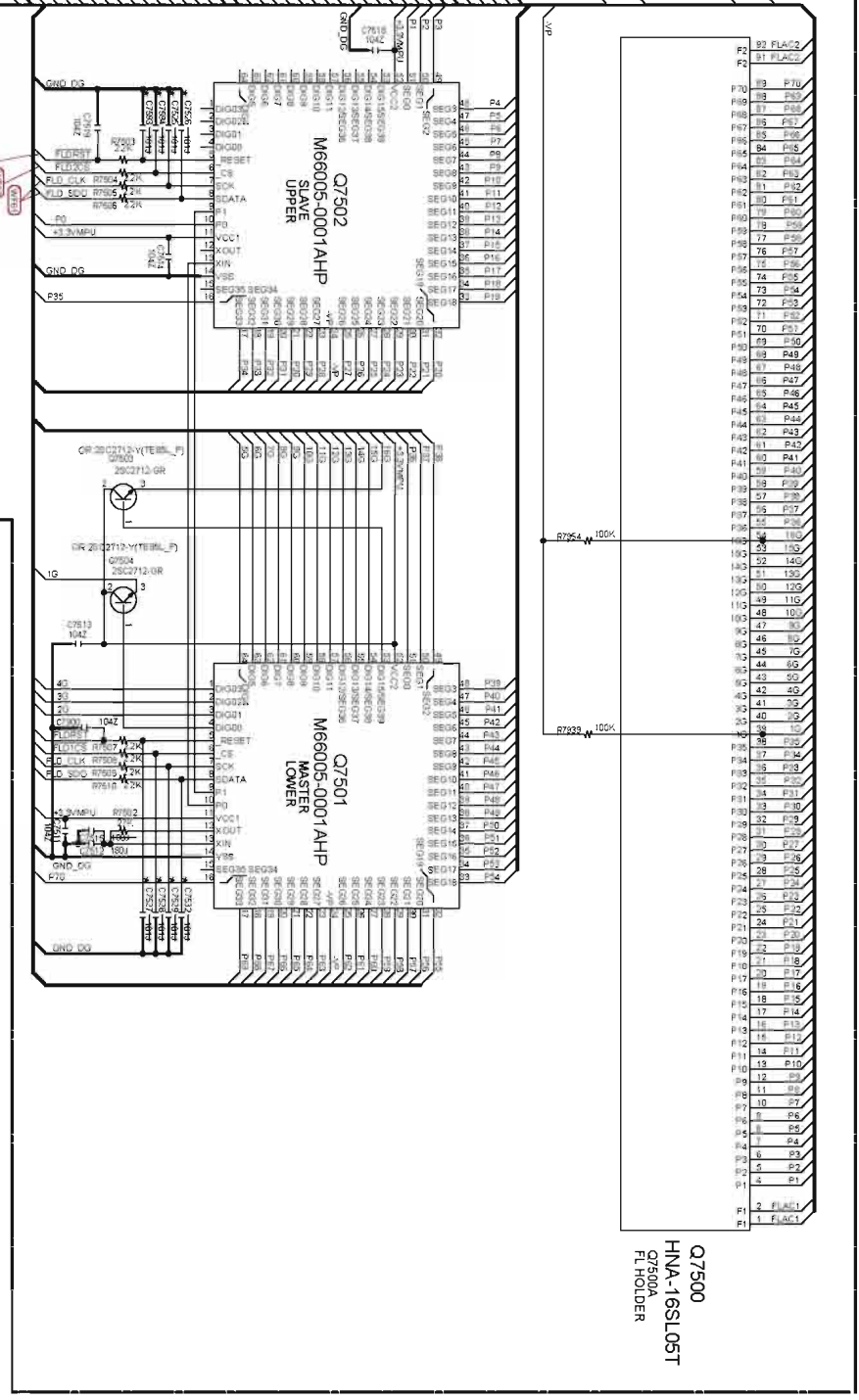
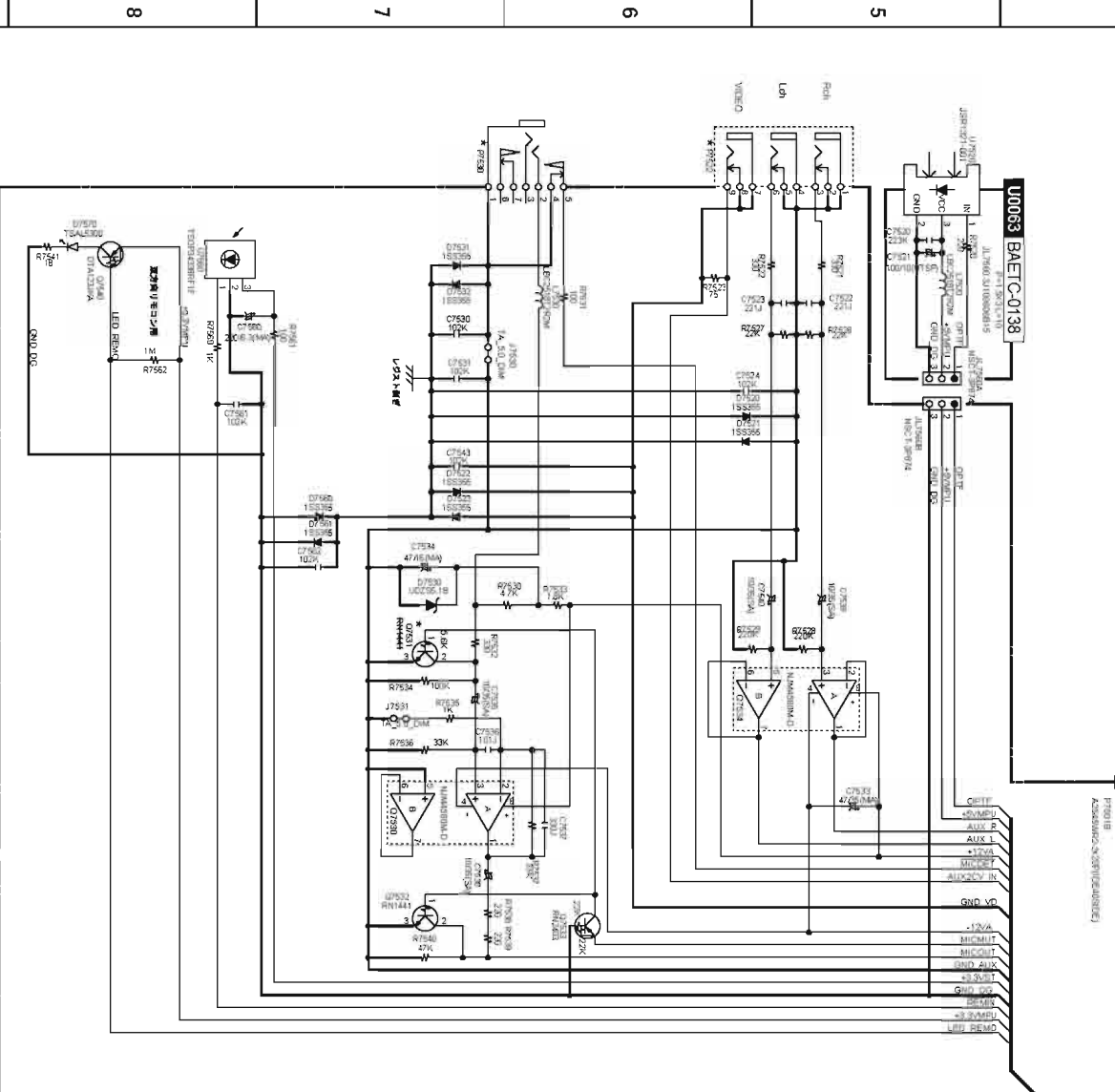
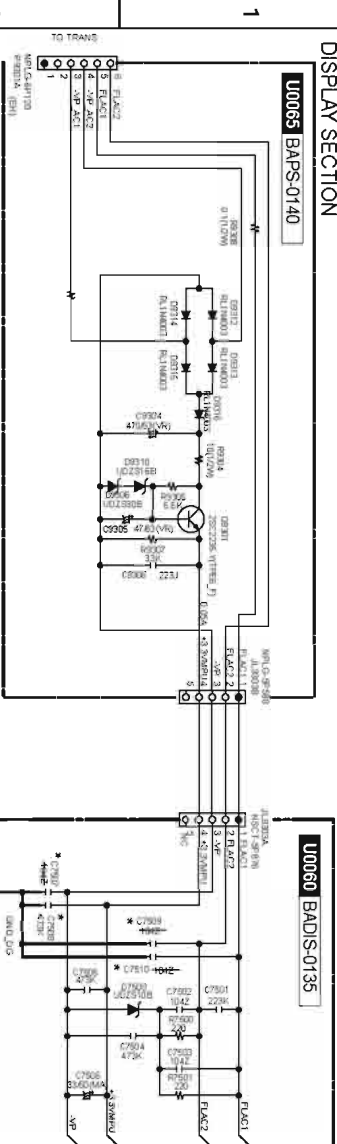

Q7500
HNA-16SL05T
Q7500A
FL HOLDER

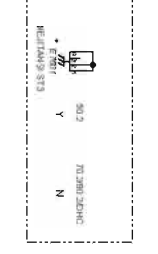
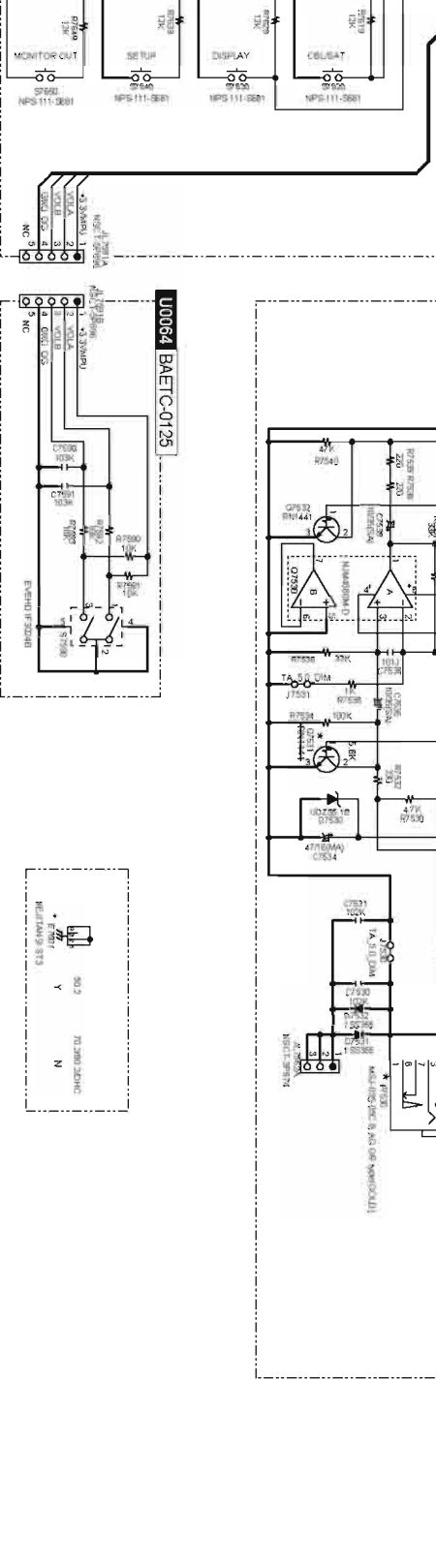
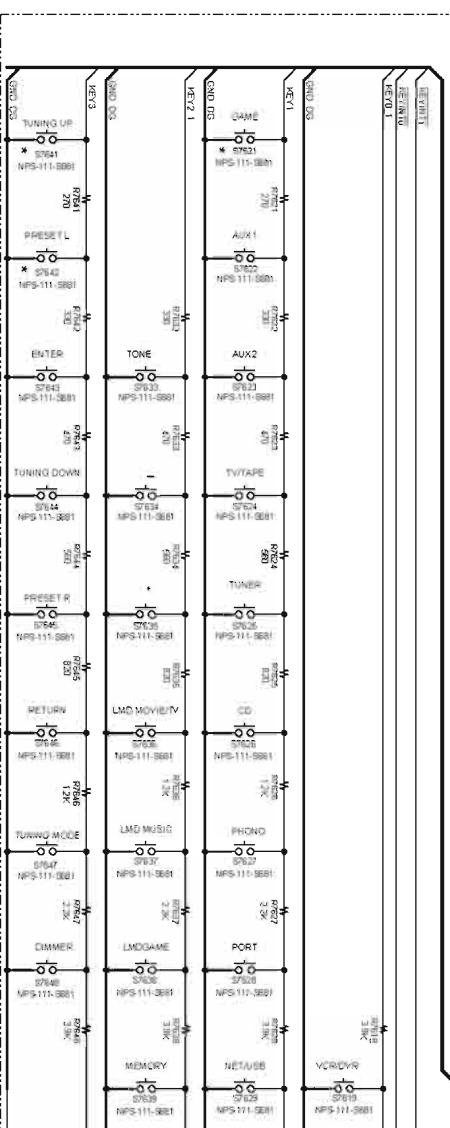
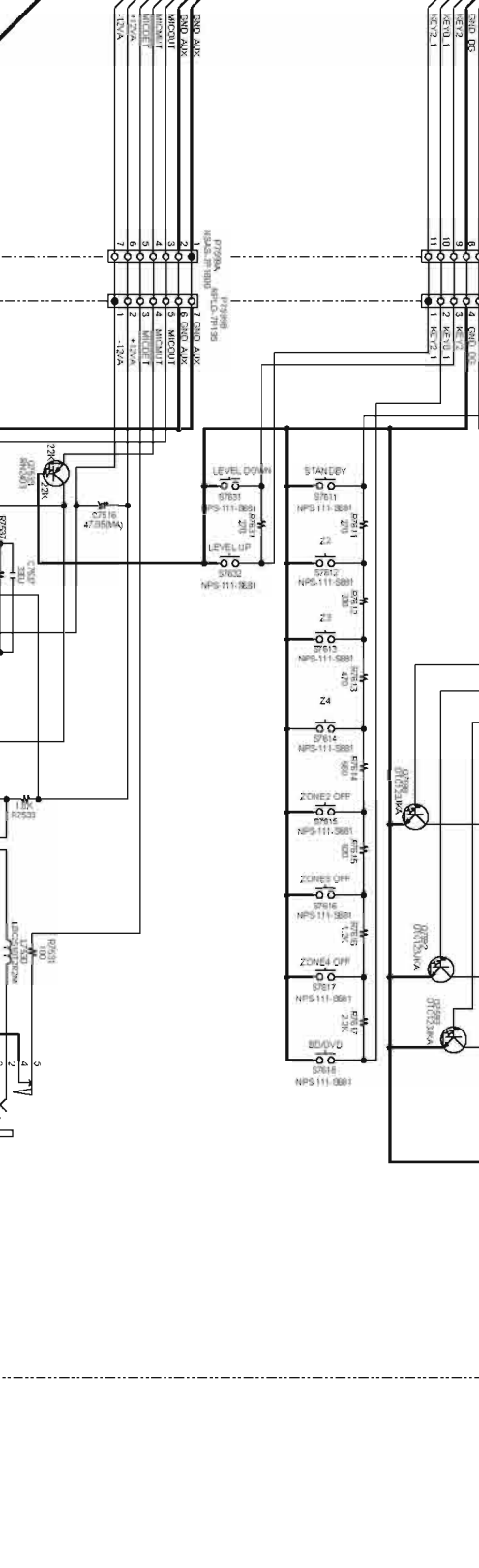
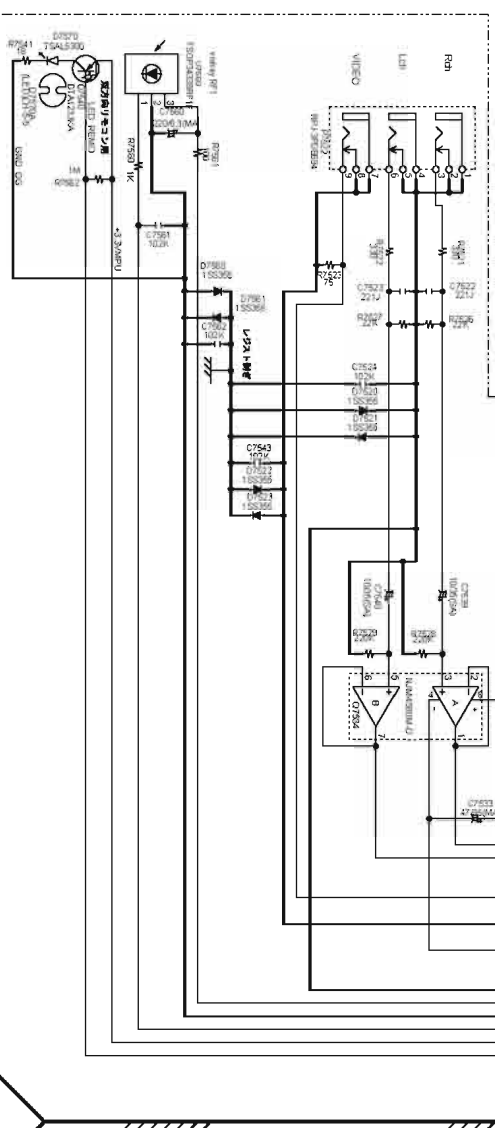
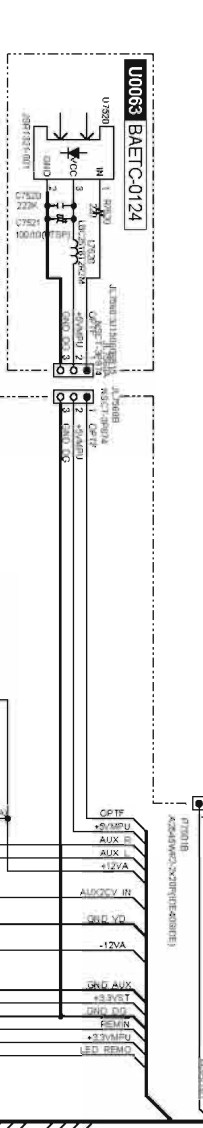
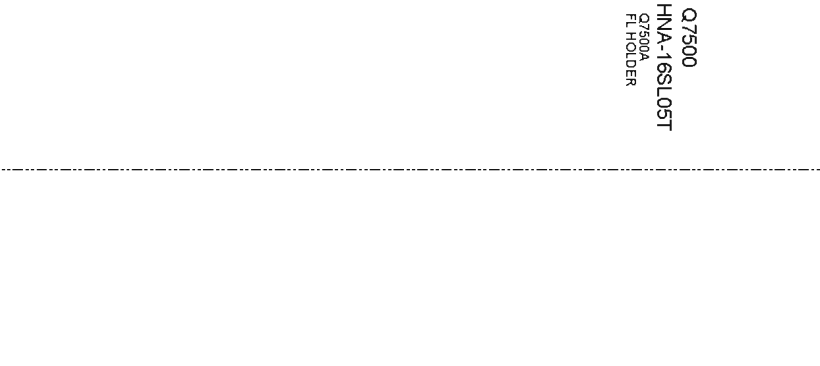
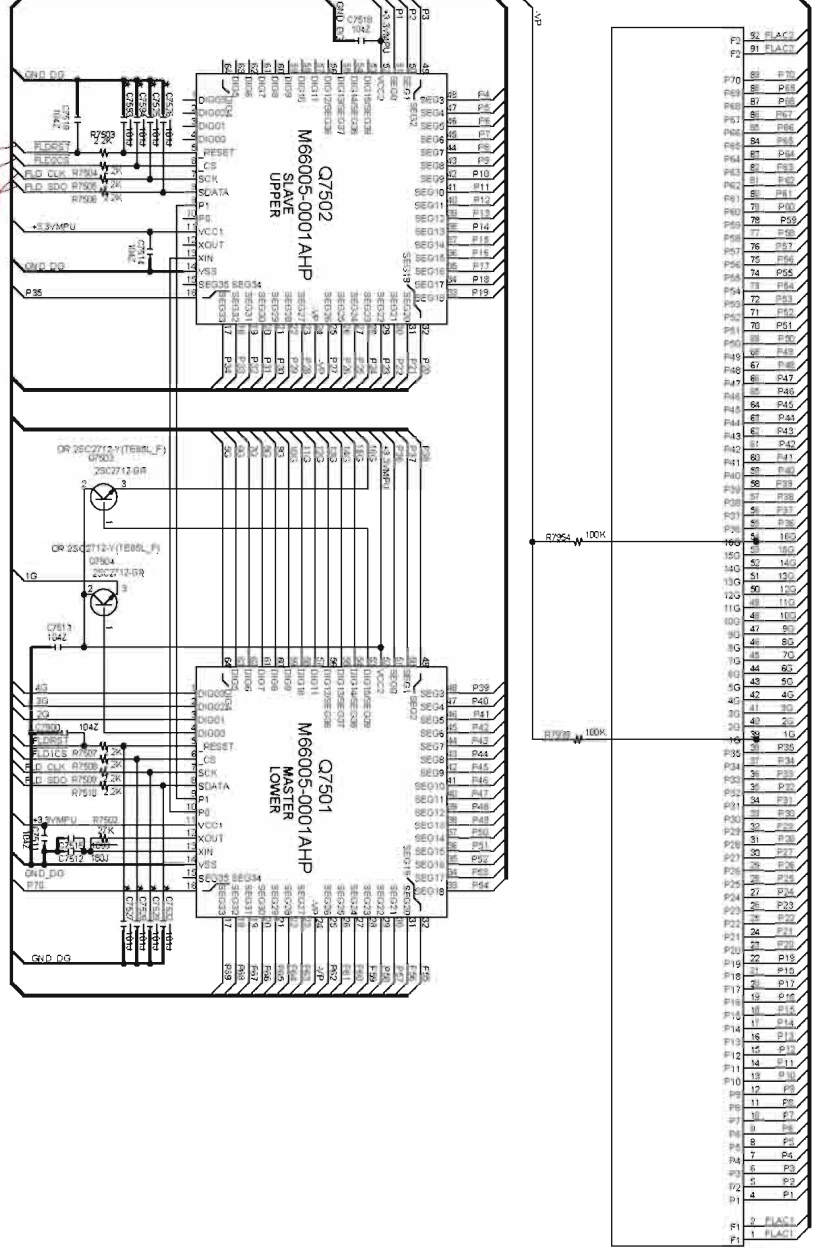
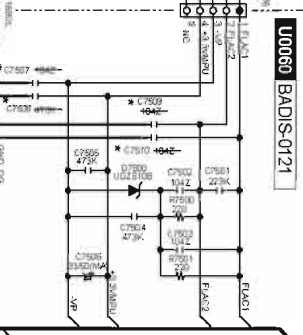
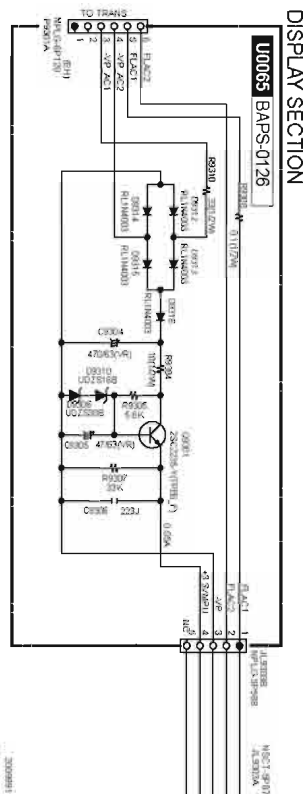

SCHEMATIC DIAGRAMS - 32
FRONT HDMI SECTION

A B C D E

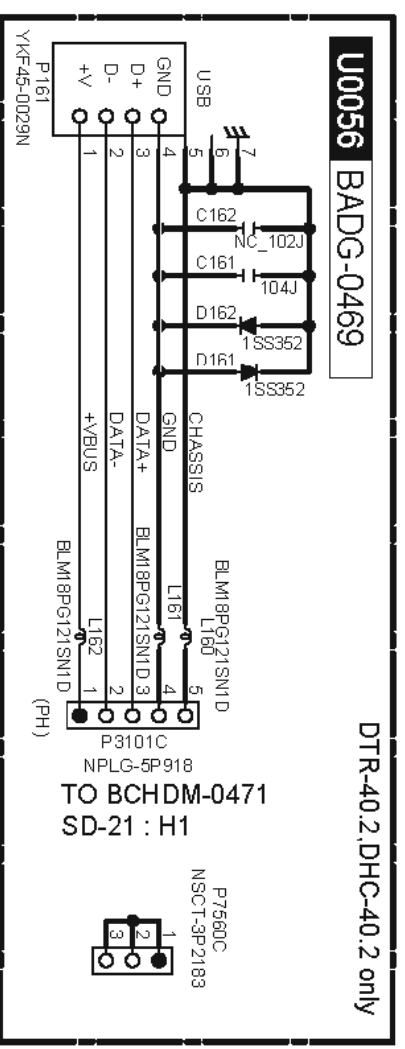
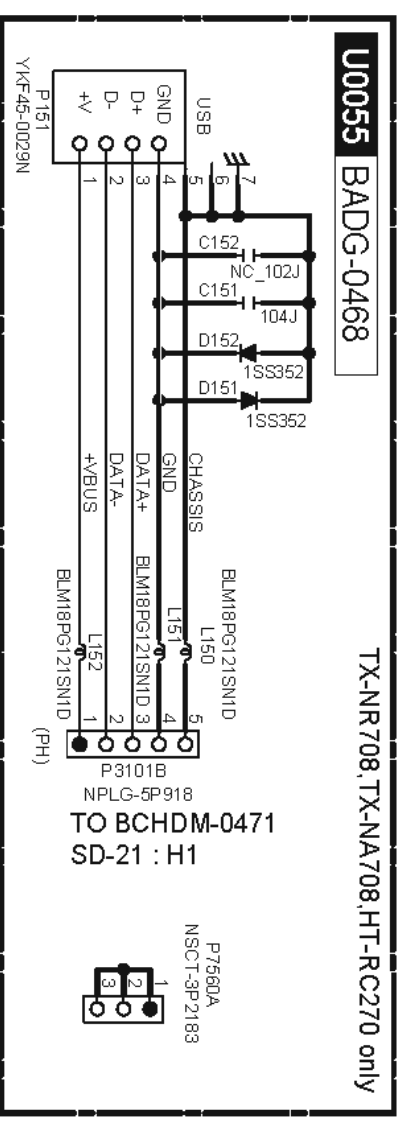
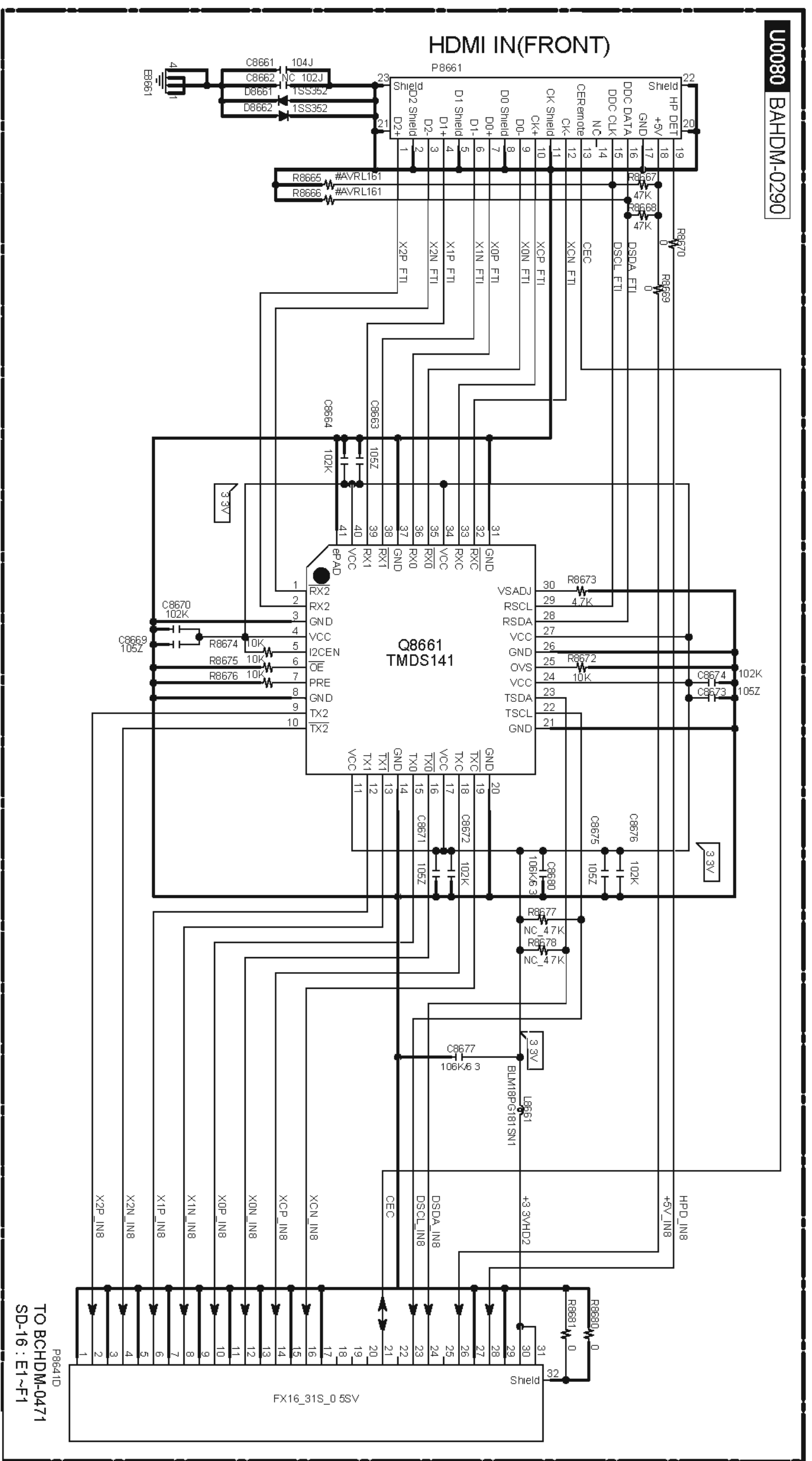

SCHEMATIC DIAGRAMS - 33
FRONT HDMI / USB SECTION

U0081 BAHDM-0291

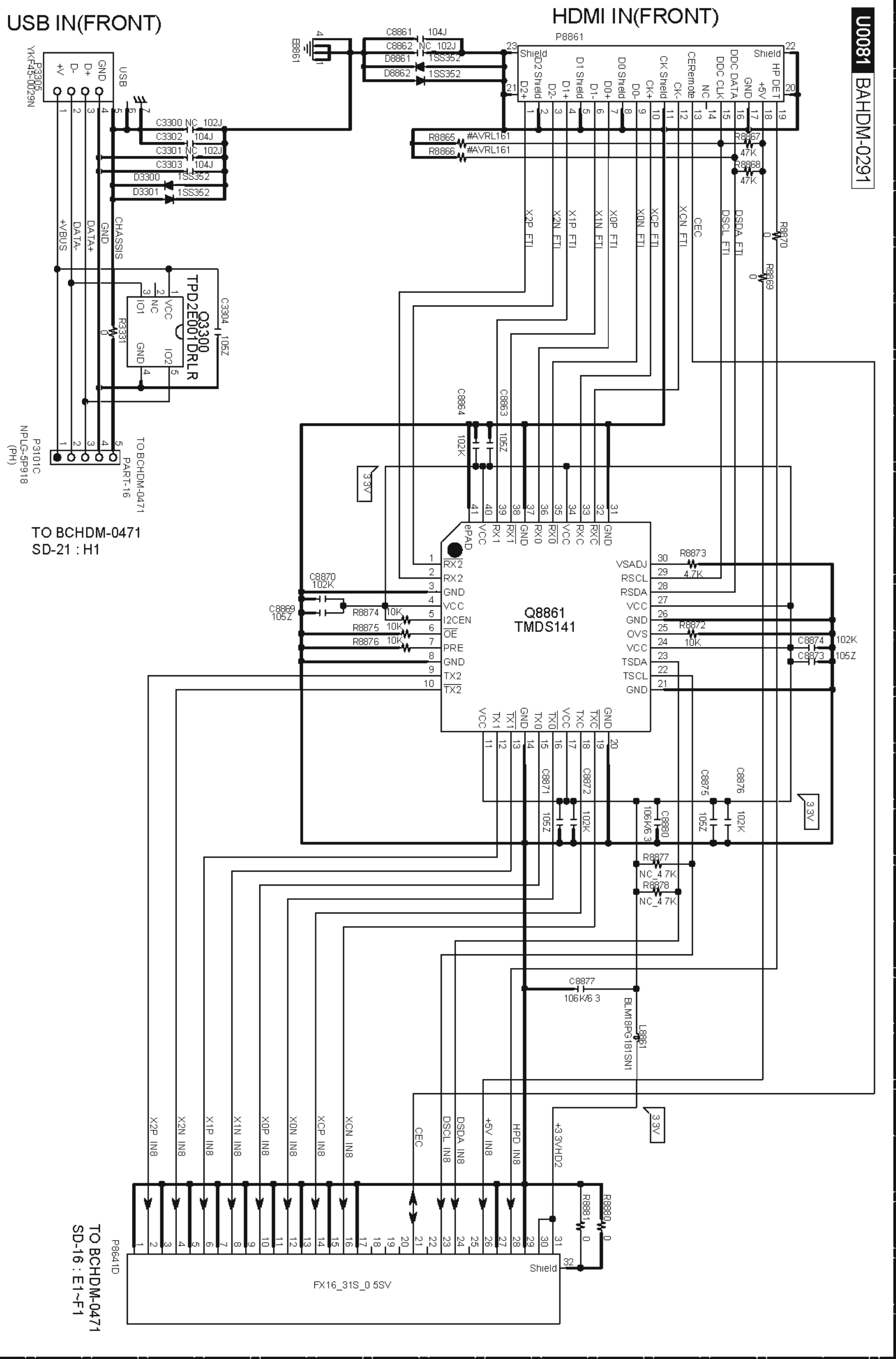

**SCHEMATIC DIAGRAMS-34
WAVEFORM SECTION**

A | B | C | D | E | F | G | H

Digital Audio Waveform Part (SD-15)

NOTE:
1. (WF01) is short for (Waveform01)
2. Refer to SCHEMATIC DIAGRAM-3/ PART5 for the location of each waveform in the circuit.
3. 'XY' in "PART5:XY" indicates each measurement point location, X=A to E/H/K, Y=1 to 4/5/8.

LR CLOCK (SAL_LRCK, CX_LRCK)
Fs=48KHz : DVD, Clock width=20.8us
Fs=44.1KHz : CD, Clock width=22.7us
BIT CLOCK (SAL_SCLK, CX_SCLK)
64Fs=3072KHz : DVD, Clock width=325ns
64Fs=2822.4KHz : CD, Clock width=354ns

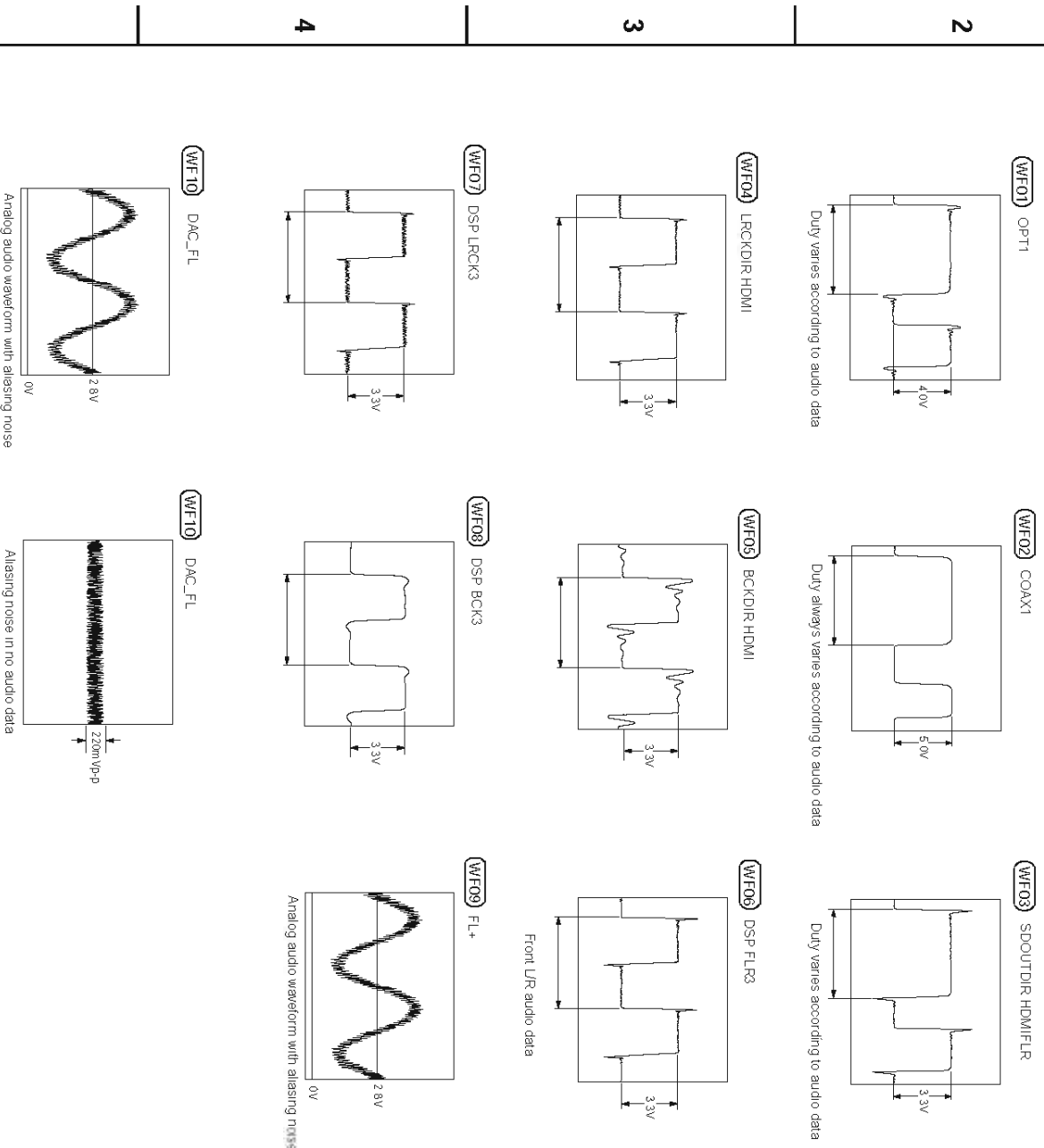

Video source color and pattern

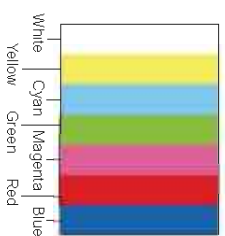

NOTE:
1. (WF21) is short for (Waveform21)
2. Refer to SCHEMATIC DIAGRAM-4/PART6 for the location of each waveform on circuit.
3. 'XY' in "PART6:XY" indicates each socket's location, X=A to E/H/K, Y=1 to 4/5/8.
4. In the case that video outputs are not connected to video devices, video signal output levels are doubled.

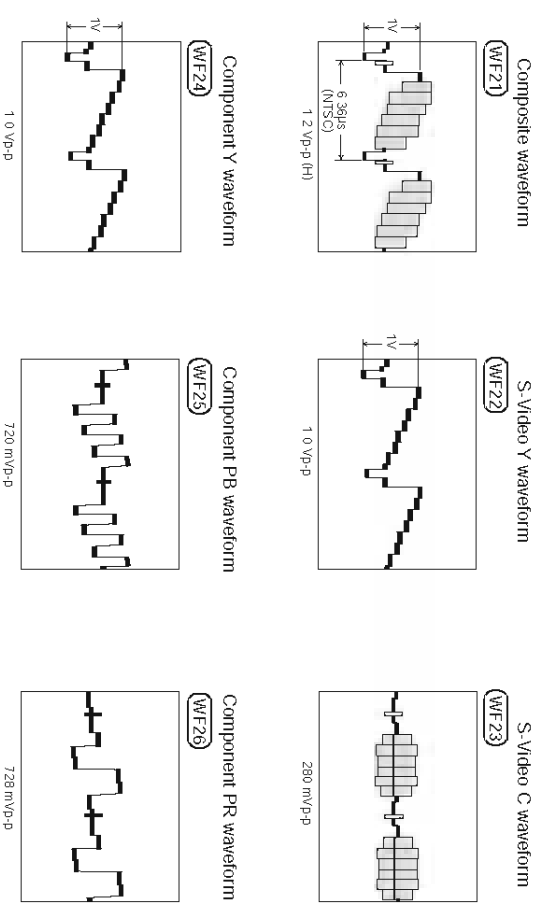

Video Waveform Part (SD12)

HDMI Waveform Part (SD16)

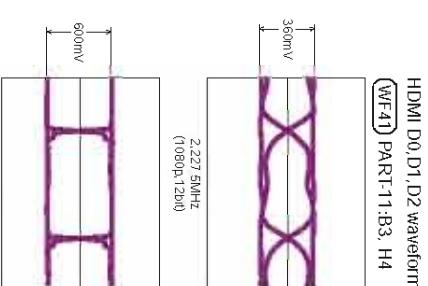

D0, D1, D2 Eye-pattern waveform, frequency and level vary according to video resolution, aspect and profile. Waveforms above are examples.

FL Driver IC Control Waveform Part (SD25, 26, 28, 30)

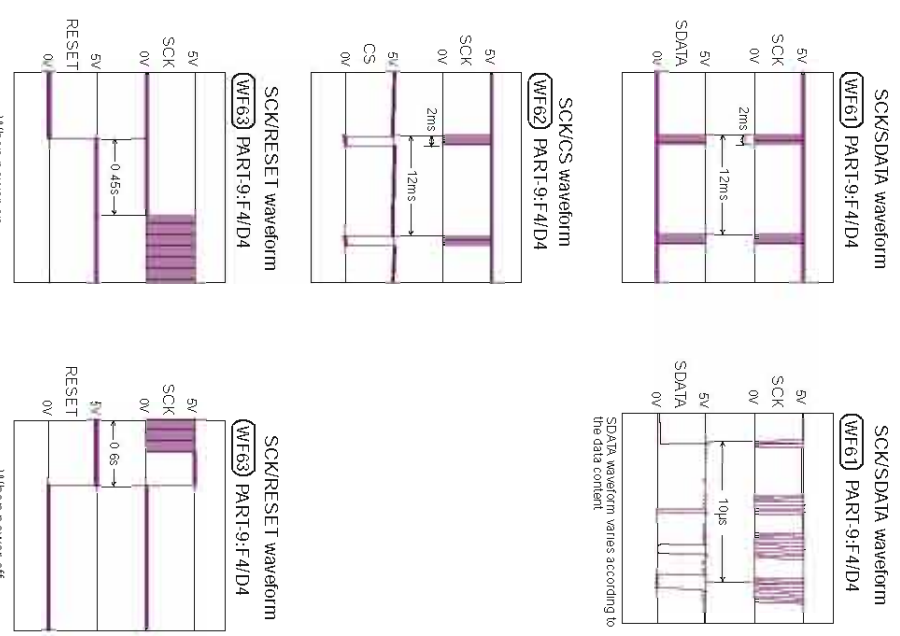

5

PRINTED CIRCUIT BOARD VIEW-1-1

U001
POWER AMP BOARD
BAAMP-0444

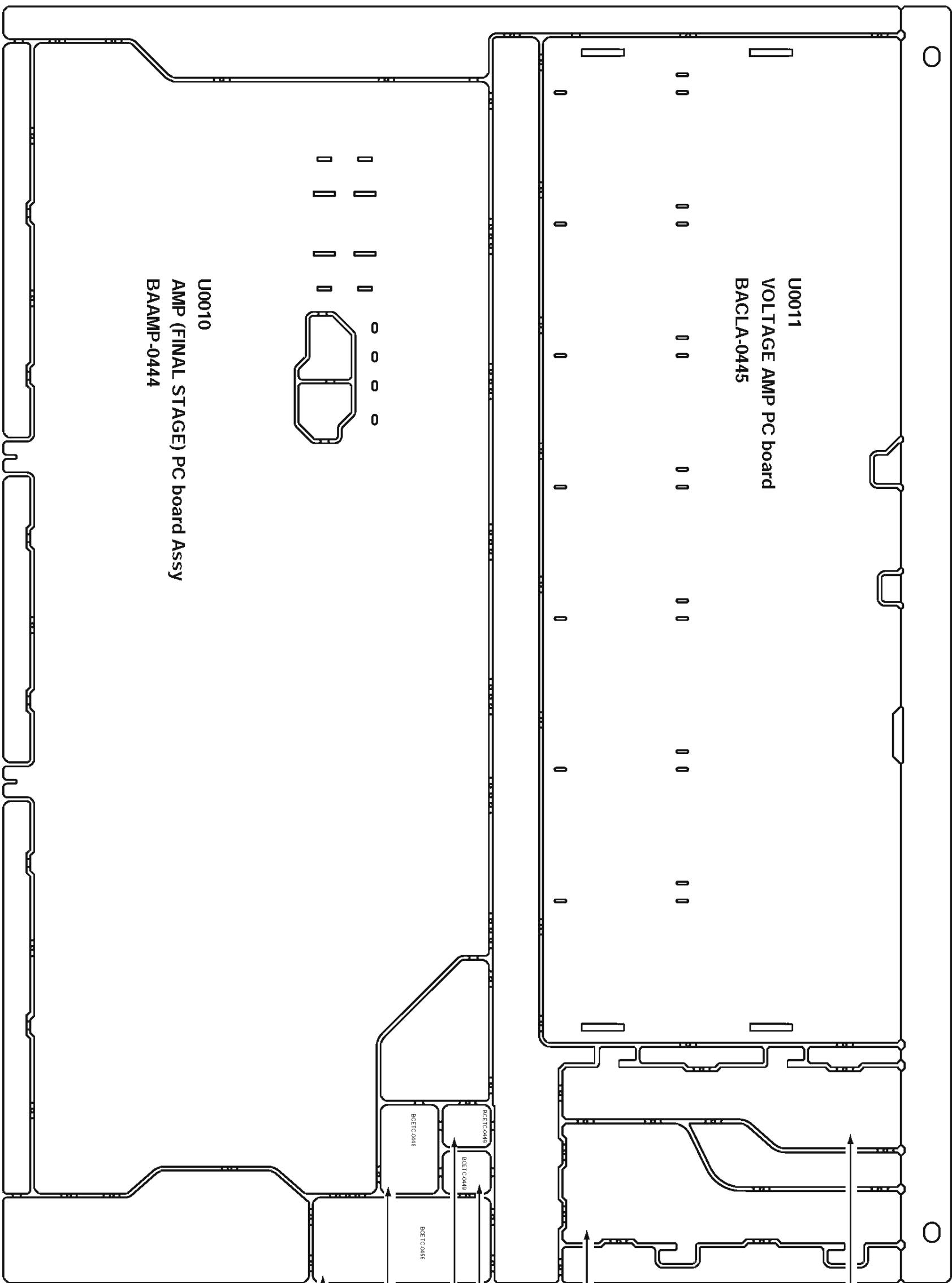

U0016
HOLD FRONT
HDMI CABLE PC board
BAETC-0455

U0014
Thermal PC board
BAETC-0448

U0015
Thermal PCB
hold PC board
BAETC-0449

U0012
AMP HOLD PC
board
BAETC-0446

U0013
AMP HOLD PC board
BAETC-0447

U001
Power AMP. board
BAAMP-0444

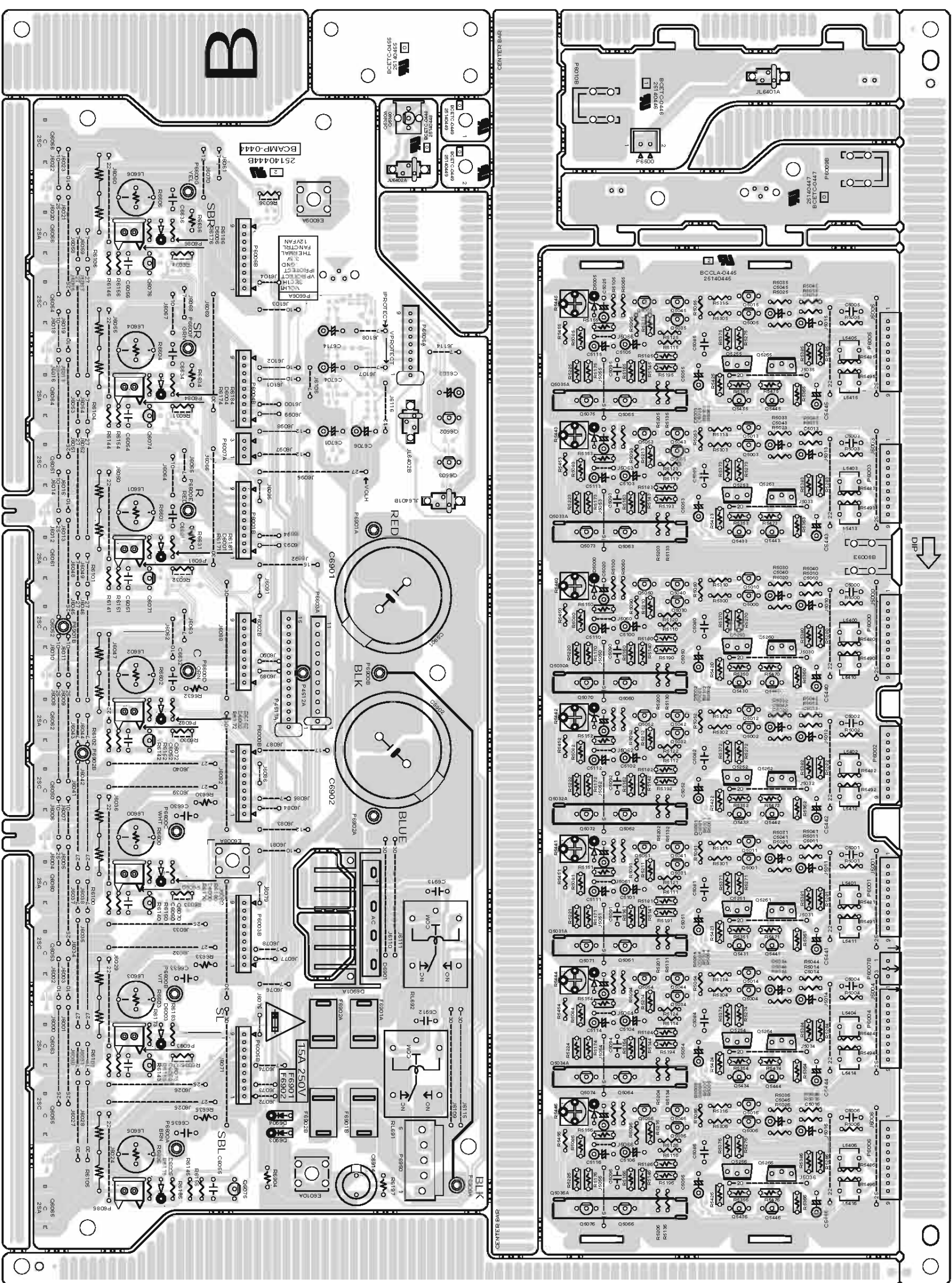

A side view from B side

A B C D E F G H
PRINTED CIRCUIT BOARD VIEW-1-3

U001
Power AMP. board
BAAMP-0444

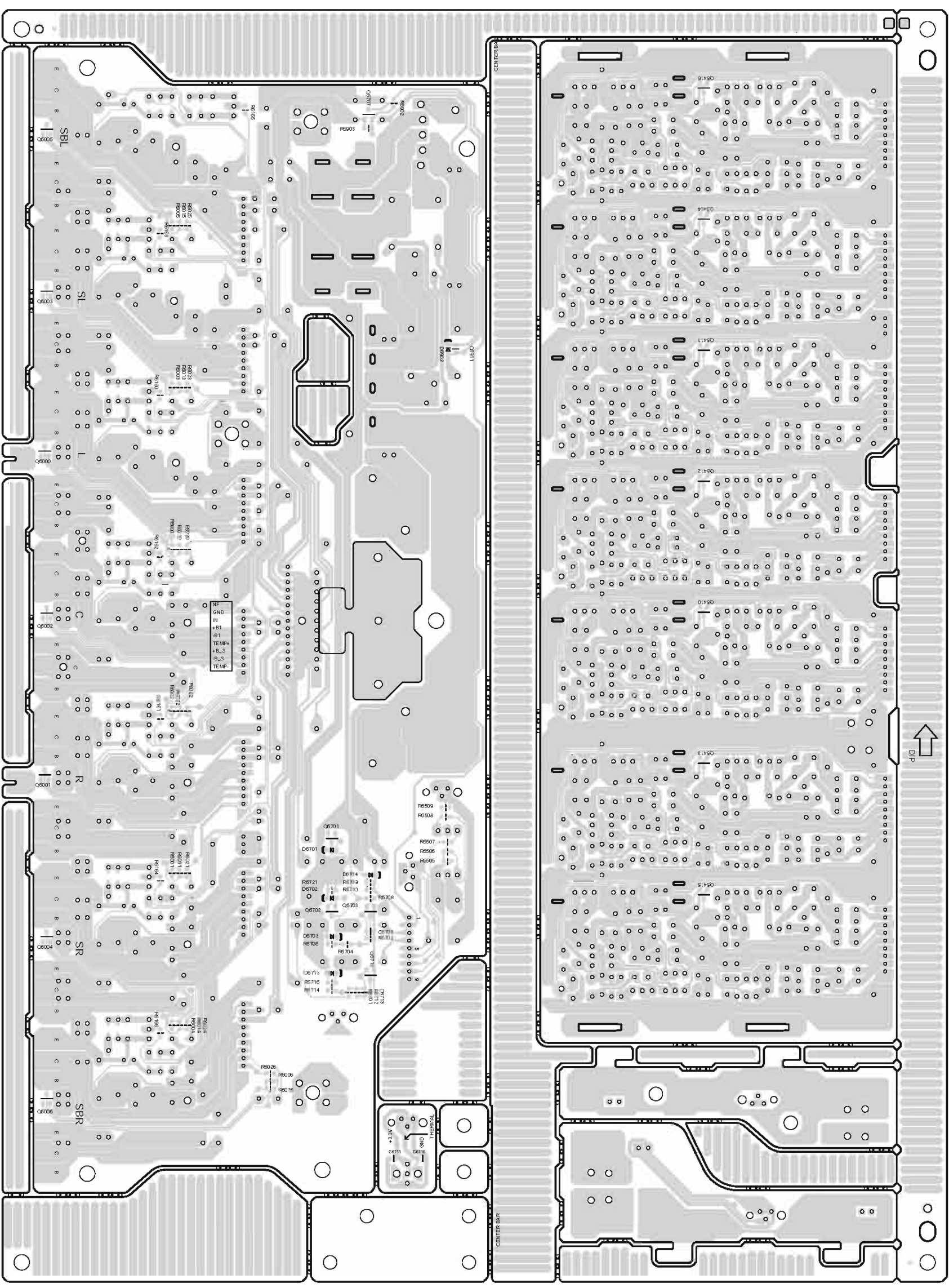

B side view from A side

PRINTED CIRCUIT BOARD VIEW-1-1

U001

Power AMP board
BAAMP-0474

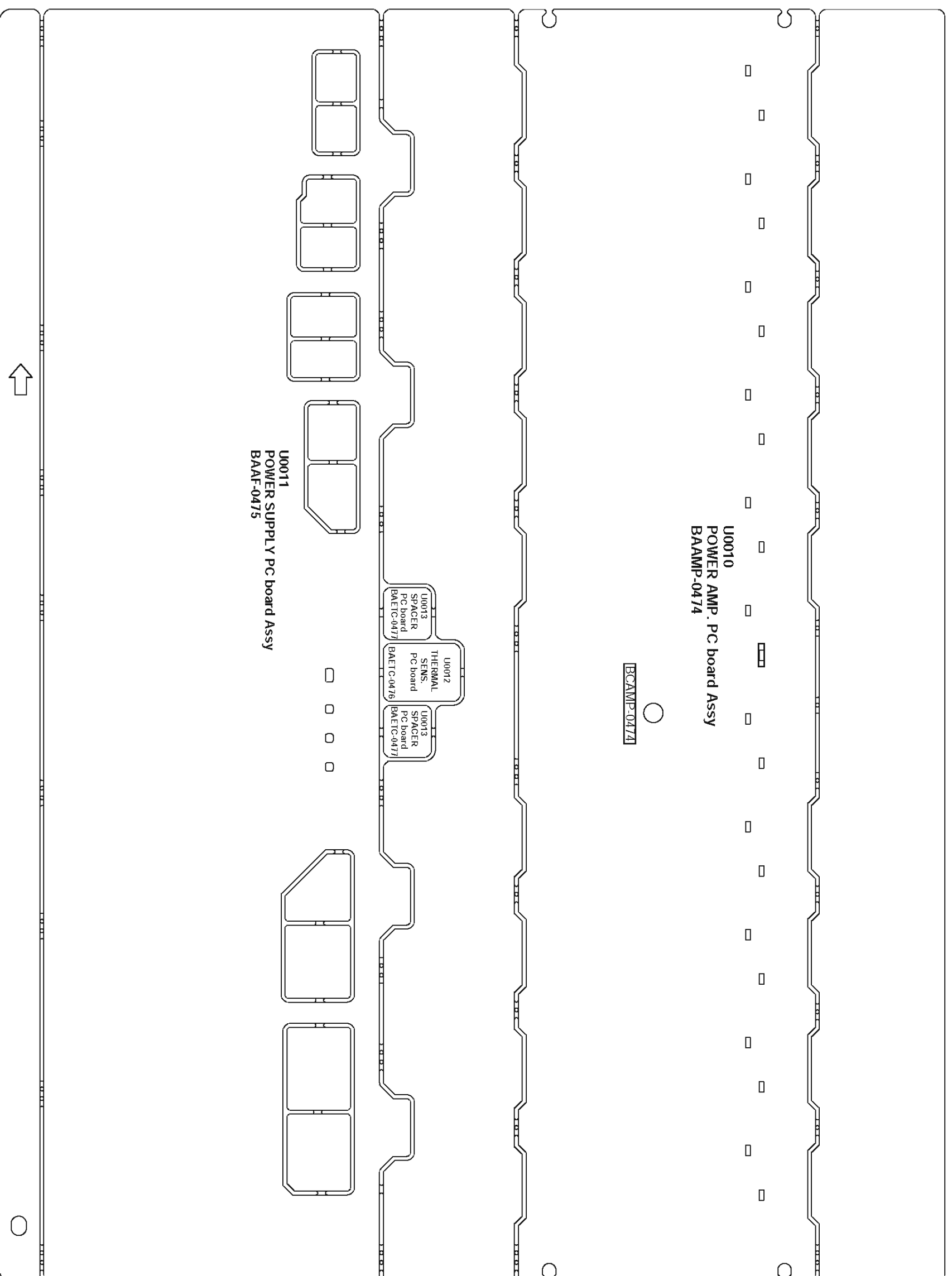

U0010
POWER AMP . PC board Assy
BAAMP-0474

BCAMP-0474

U0012
THERMAL
SENS.
PC board
BAETC-0476

U0013
SPACER
PC board
BAETC-0477

U0011
POWER SUPPLY PC board Assy
BAAF-0475



A B C D E F G H

PRINTED CIRCUIT BOARD VIEW-1-2

U001

Power AMP board
BAAMP-0474

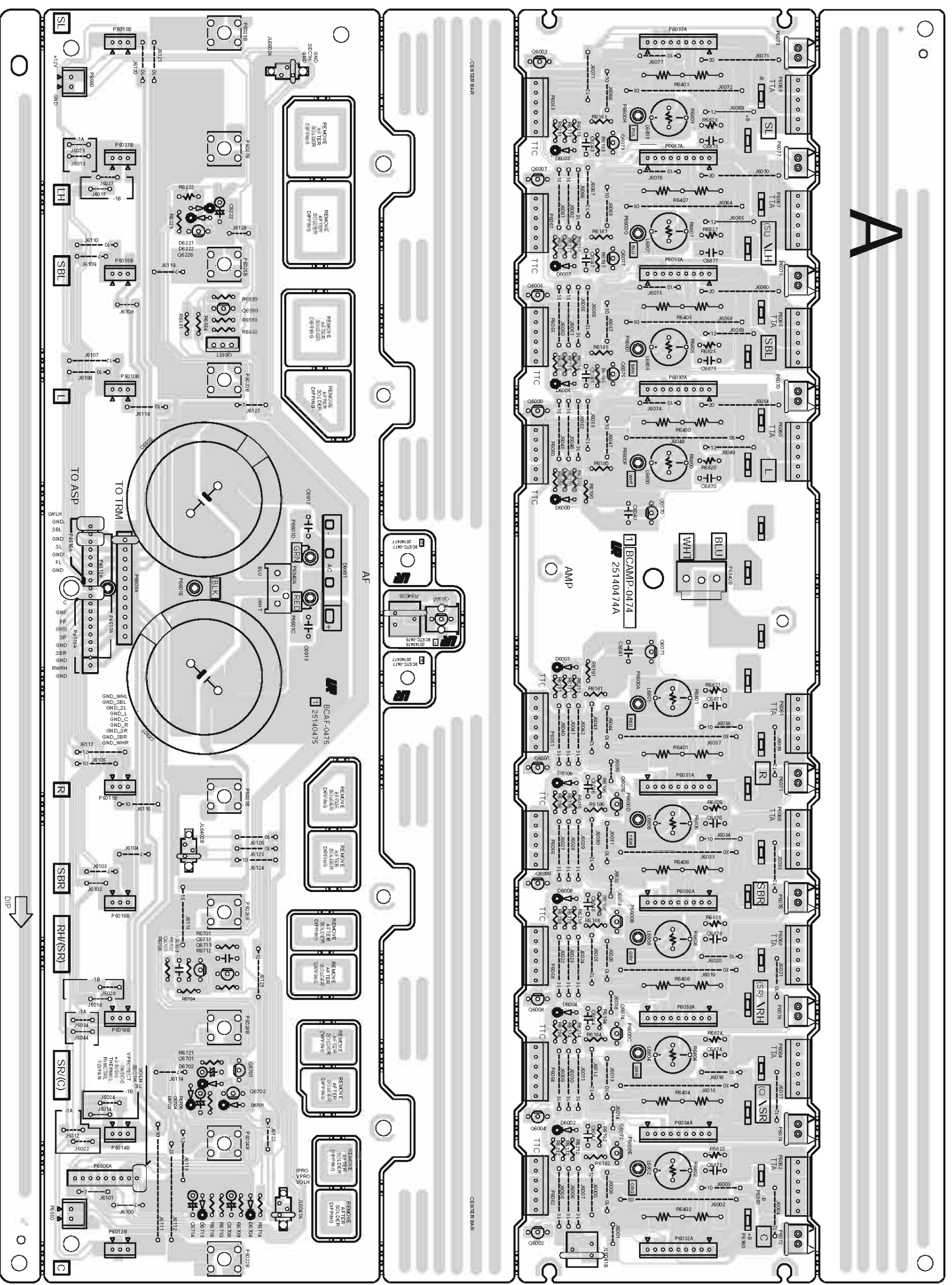

Soldering side view

PRINTED CIRCUIT BOARD VIEW-2-1

U002

Driver AMP board
BACLA-0480

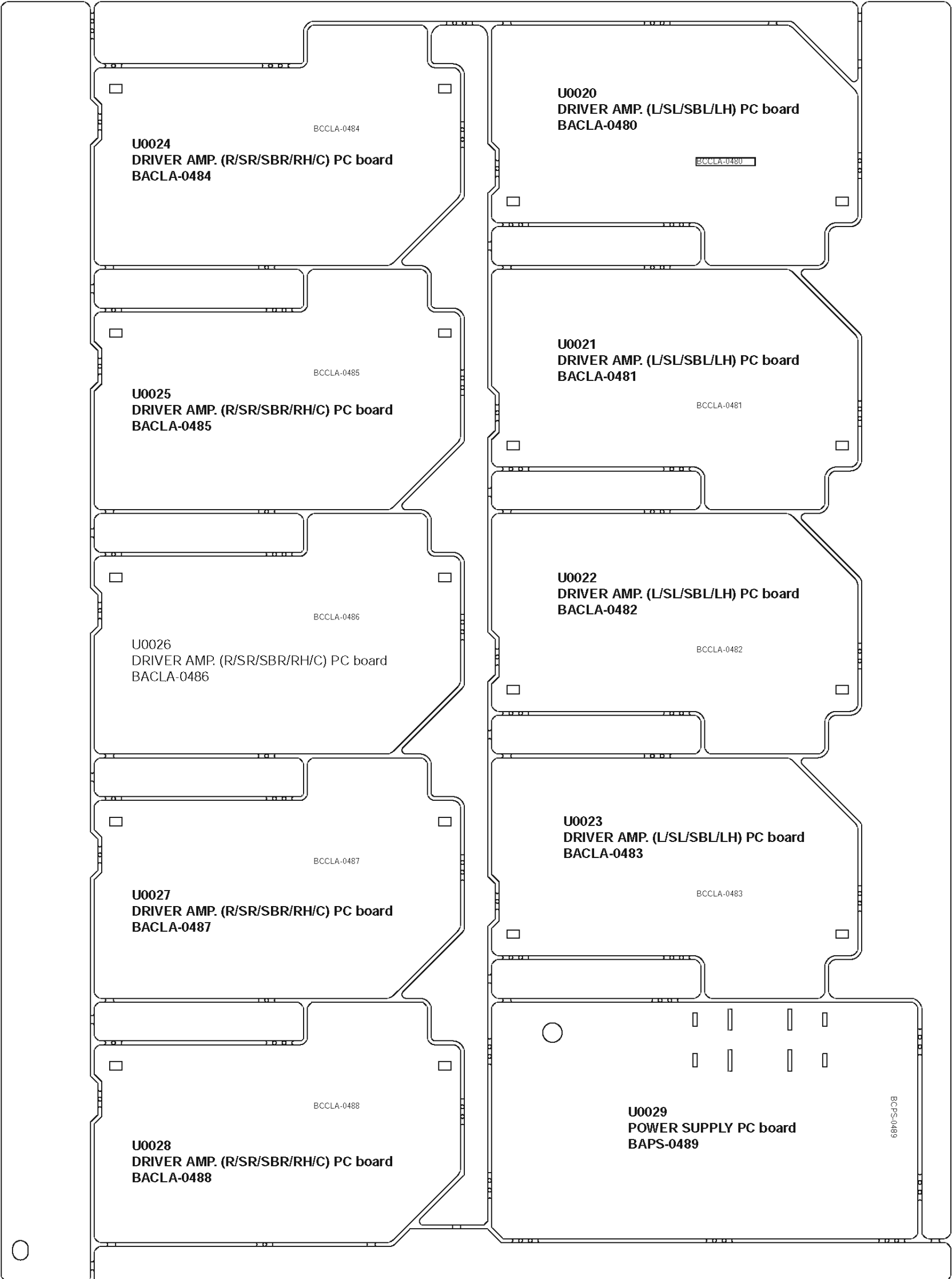

PRINTED CIRCUIT BOARD VIEW-2-2

U002

Driver AMP board
BACLA-0480

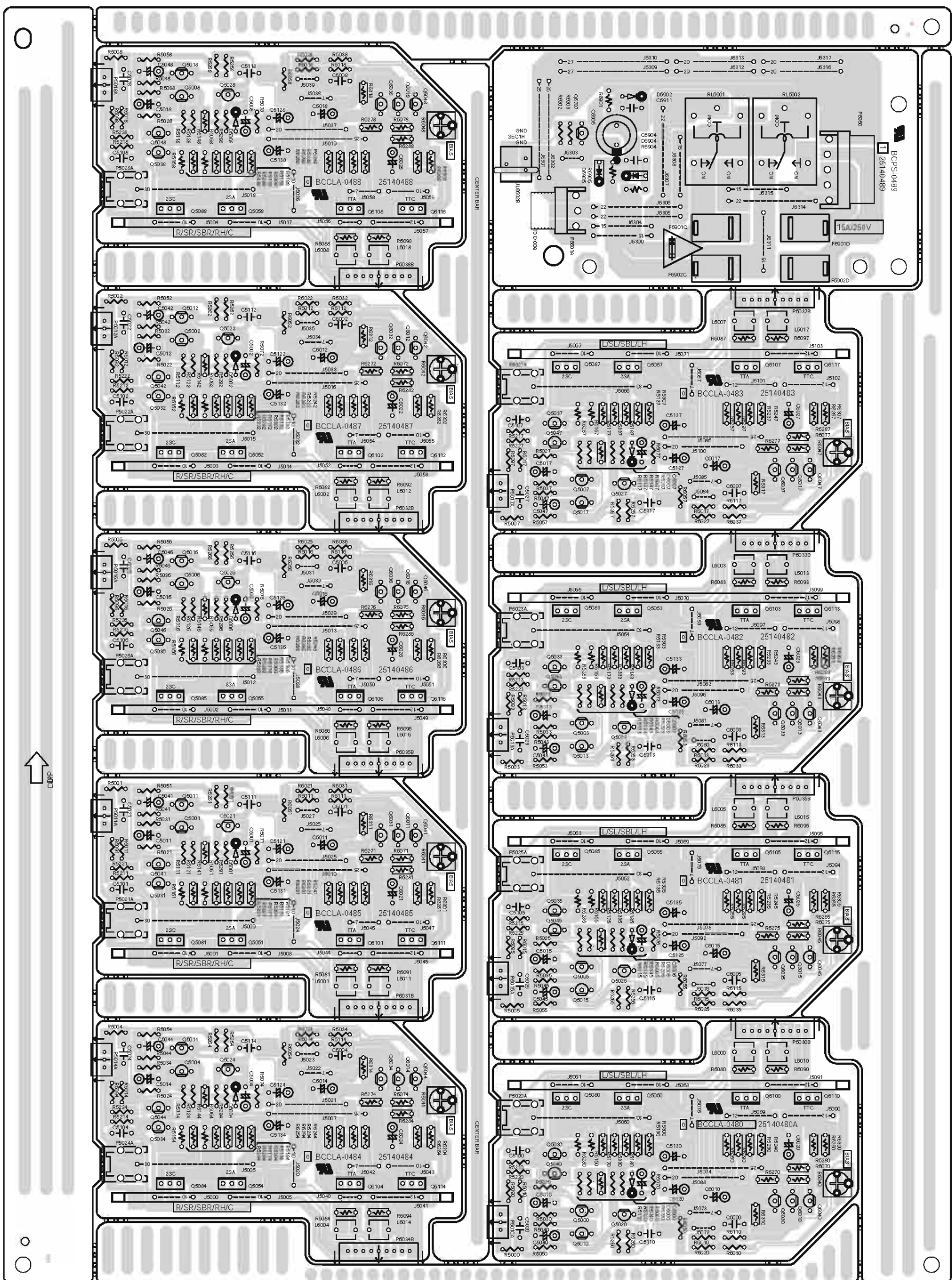

PRINTED CIRCUIT BOARD VIEW-3-1

U003
Speaker Terminal board
BATRM-0450

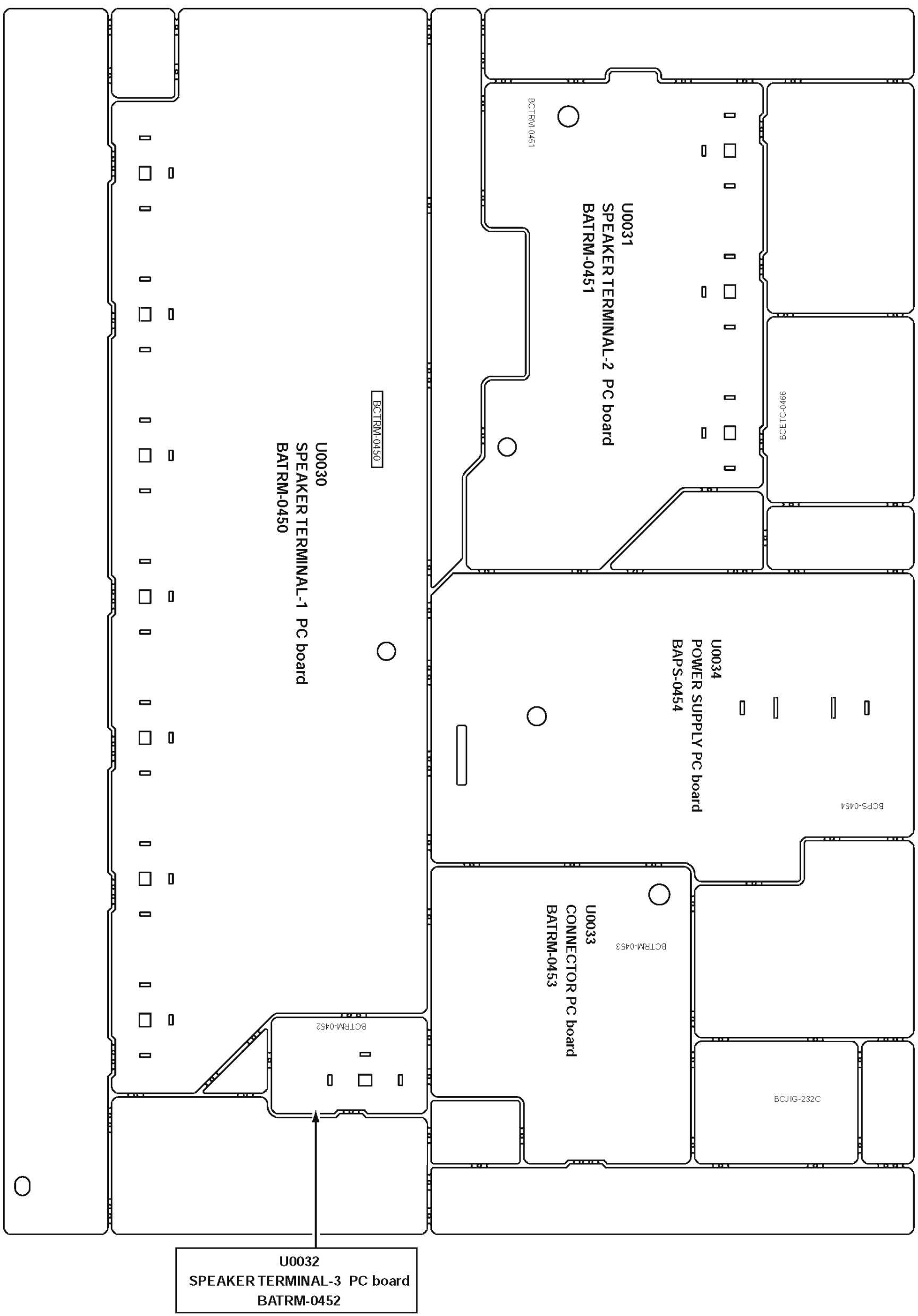

A B C D E F G H

PRINTED CIRCUIT BOARD VIEW-3-2

U003
Speaker Terminal board
BATRM-0450

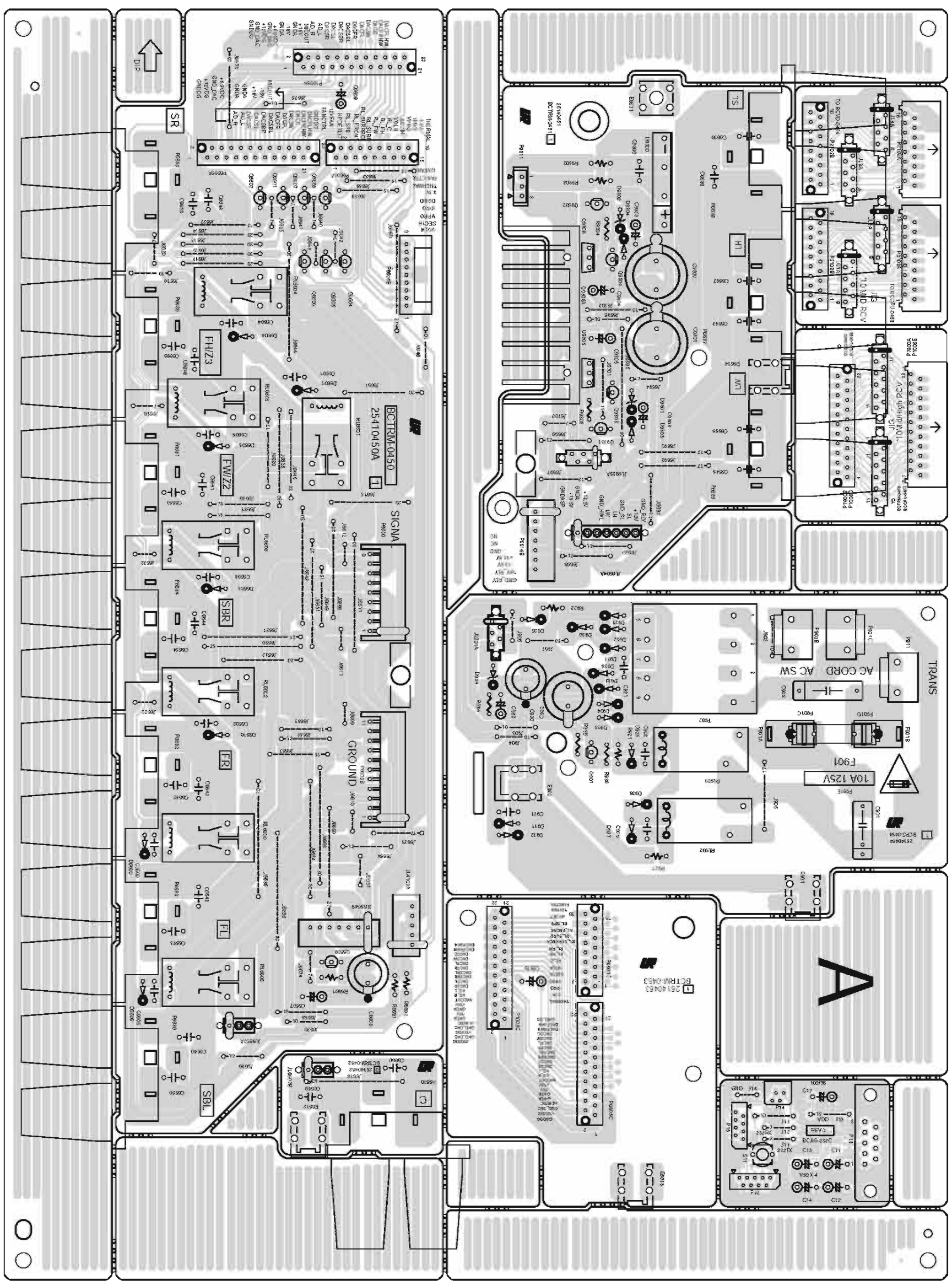

B side view from A side

5

4

3

2

1

A
PRINTED CIRCUIT BOARD VIEW-3.3

U003
Speaker Terminal board
BATRM-0450

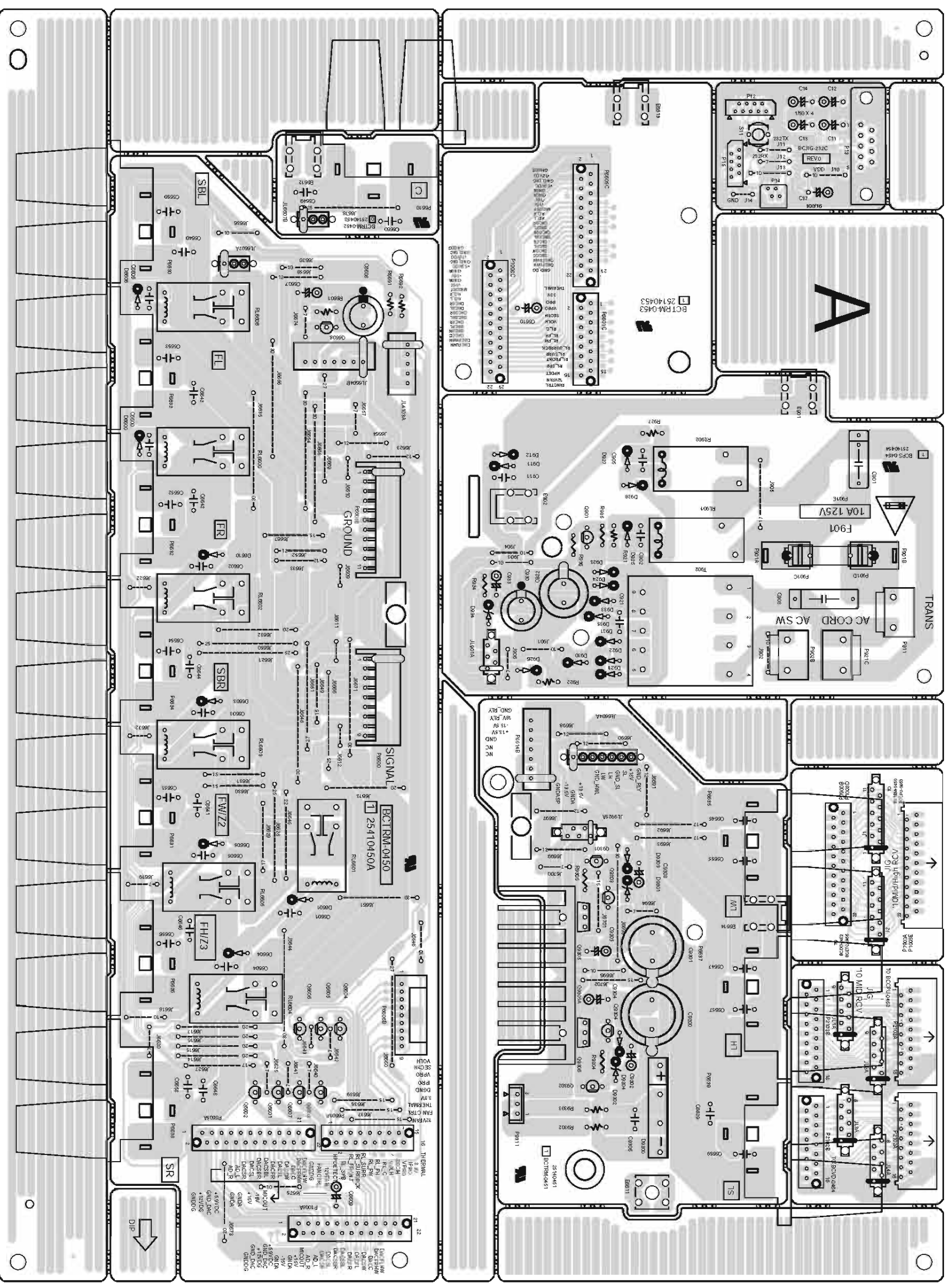

A side view from B side

PRINTED CIRCUIT BOARD VIEW-4-1

U004

AMP (Audio IN/OUT)
PC board
BAASP-0458

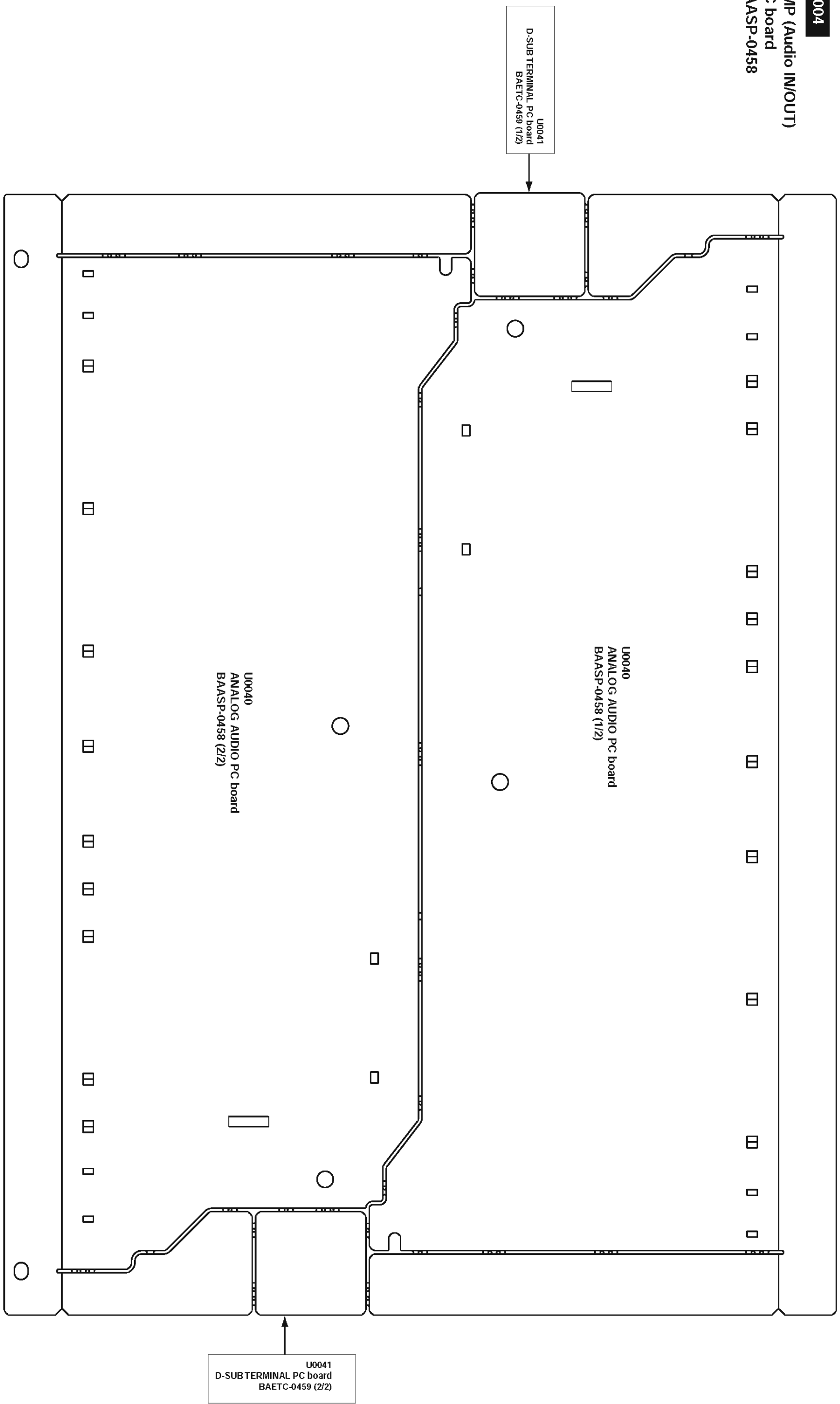

U0041
D-SUB TERMINAL PC board
BAETC-0459 (1/2)

U0040
ANALOG AUDIO PC board
BAASP-0458 (1/2)

U0040
ANALOG AUDIO PC board
BAASP-0458 (2/2)

U0041
D-SUB TERMINAL PC board
BAETC-0459 (2/2)

PRINTED CIRCUIT BOARD VIEW-4.2

U004

1 AMP (Audio IN/OUT)
PC board
BAASP-0458

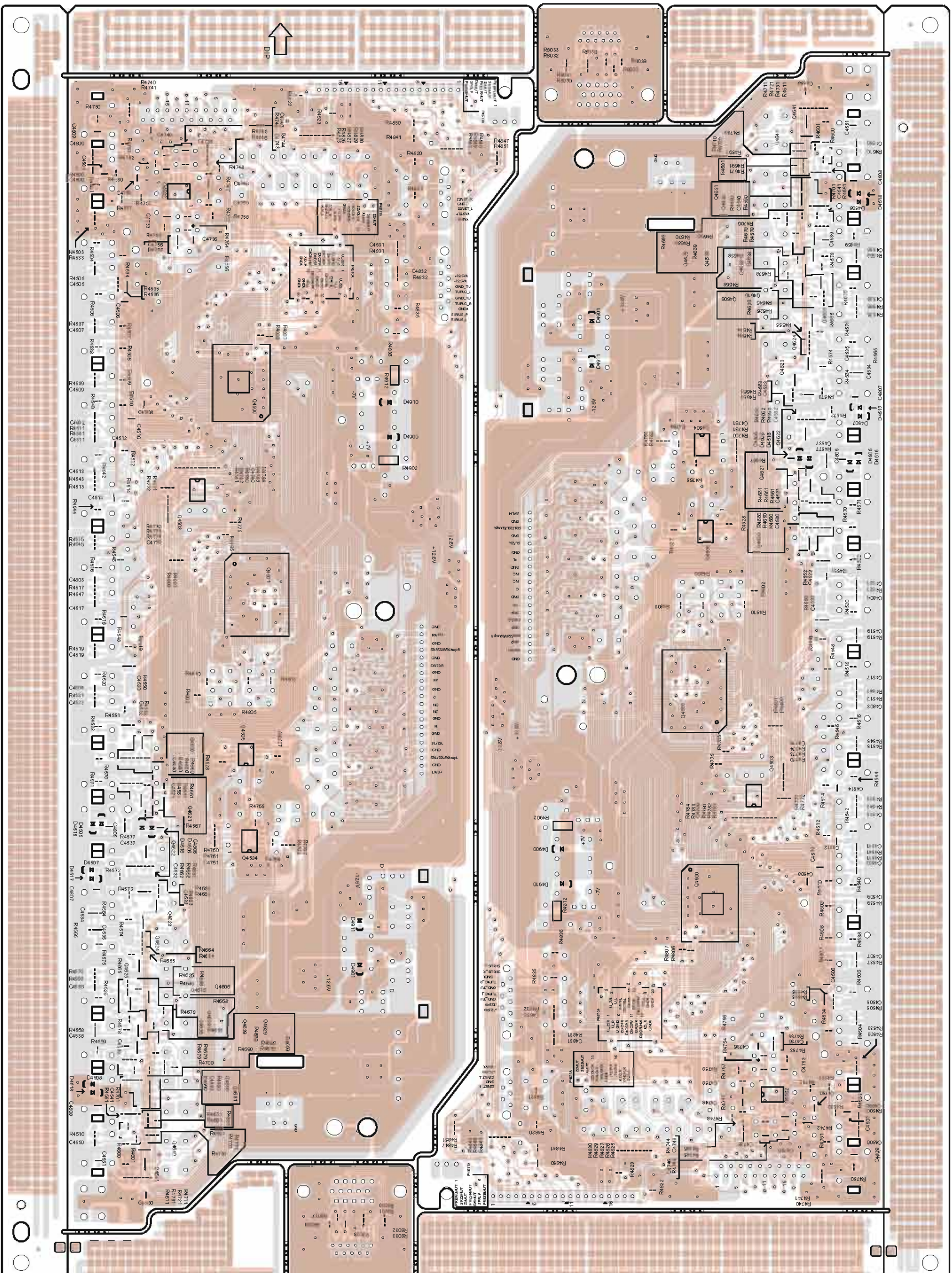

B side view from A side

PRINTED CIRCUIT BOARD VIEW-4.3

A B C D E F G H

U004

AMP (Audio IN/OUT)
PC board
BAASP-0458

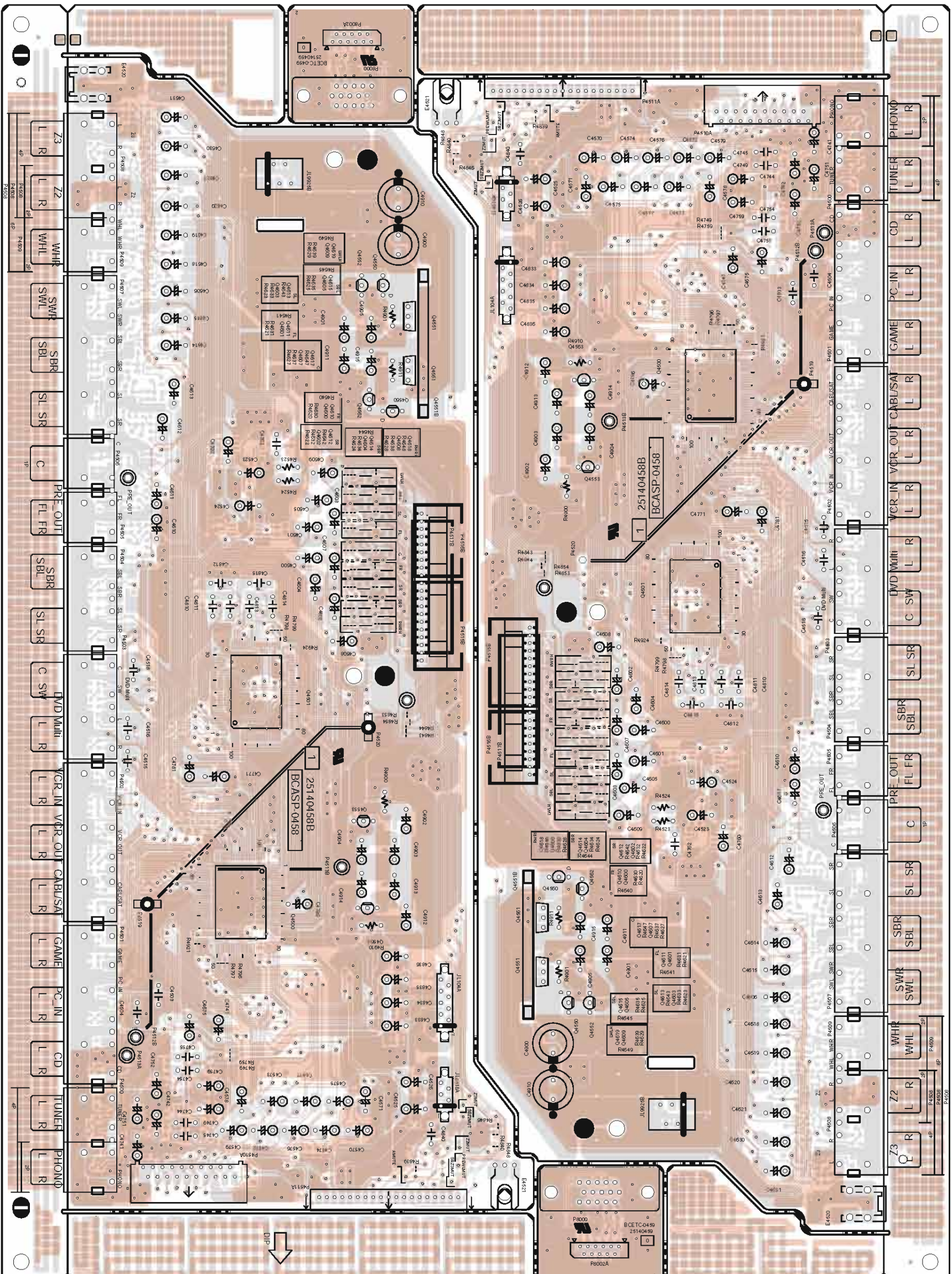

A side view from B side

A side pattern
B side pattern

5

4

3

2

1

PRINTED CIRCUIT BOARD VIEW-5-1

U005 Digital (Main CPU/DAC) Board
BADG-0462

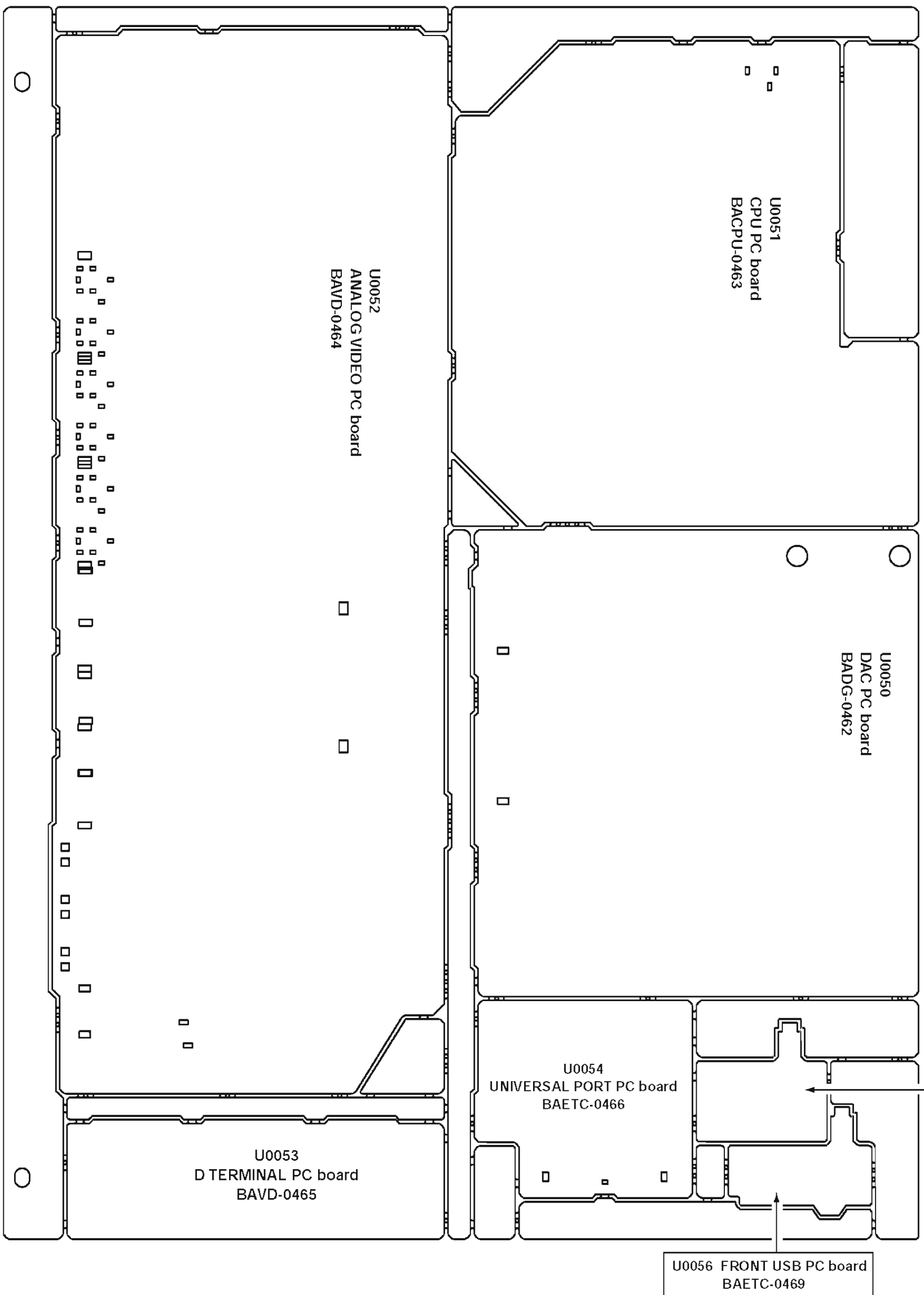

U0051
CPU PC board
BACPU-0463

U0052
ANALOG VIDEO PC board
BAVD-0464

U0050
DAC PC board
BADG-0462

U0054
UNIVERSAL PORT PC board
BAETC-0466

U0053
D TERMINAL PC board
BAVD-0465

U0055 FRONT USB PC board
BAETC-0468

U0056 FRONT USB PC board
BAETC-0469

A B C D E F G H

PRINTED CIRCUIT BOARD VIEW-5-2

U005 Digital (Main CPU/DAC) Board
BADG-0462

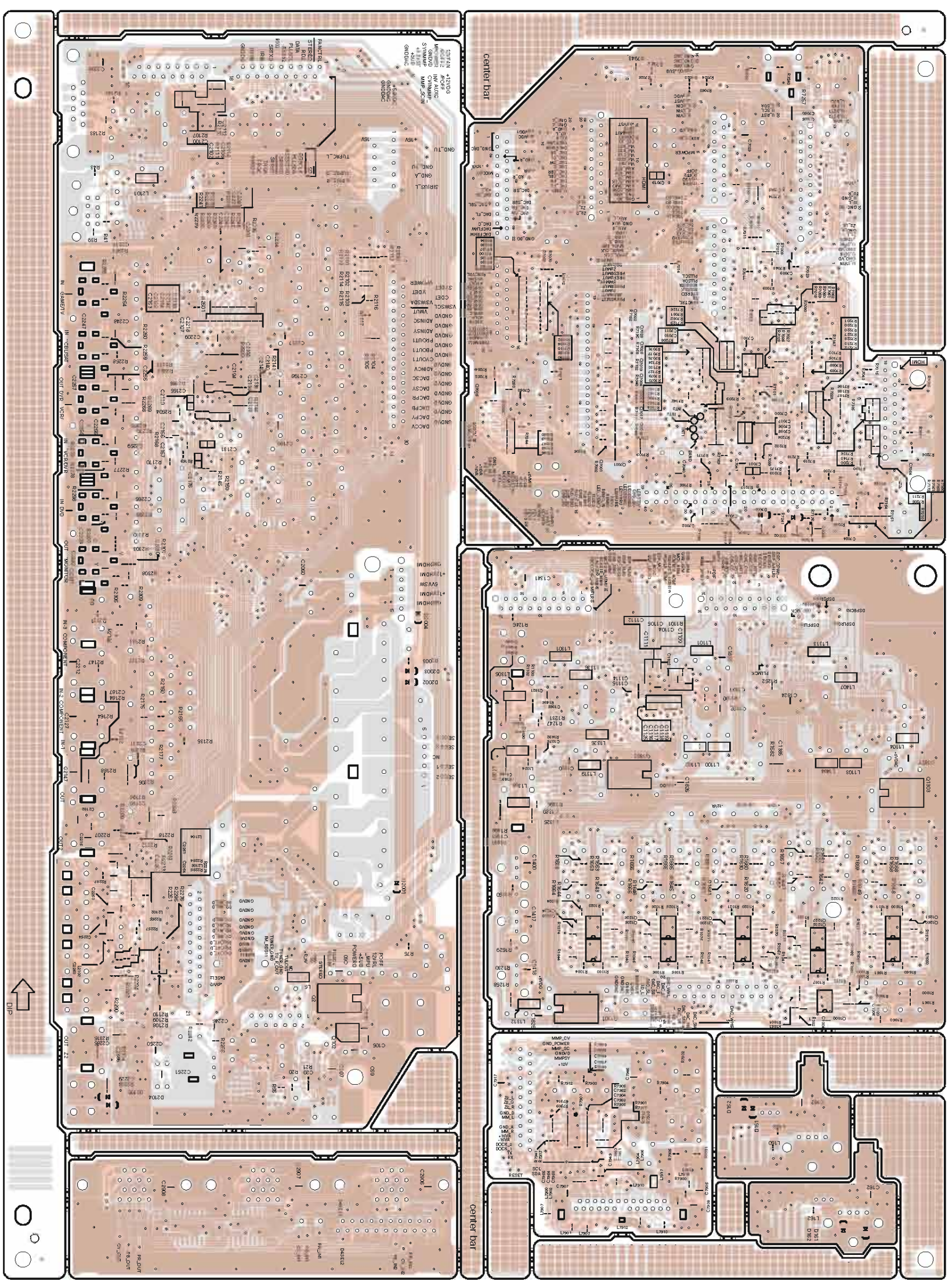

B side view from A side

— A side pattern
— B side pattern

U005

Digital (Main CPU/DAC) Board
BADG-0462

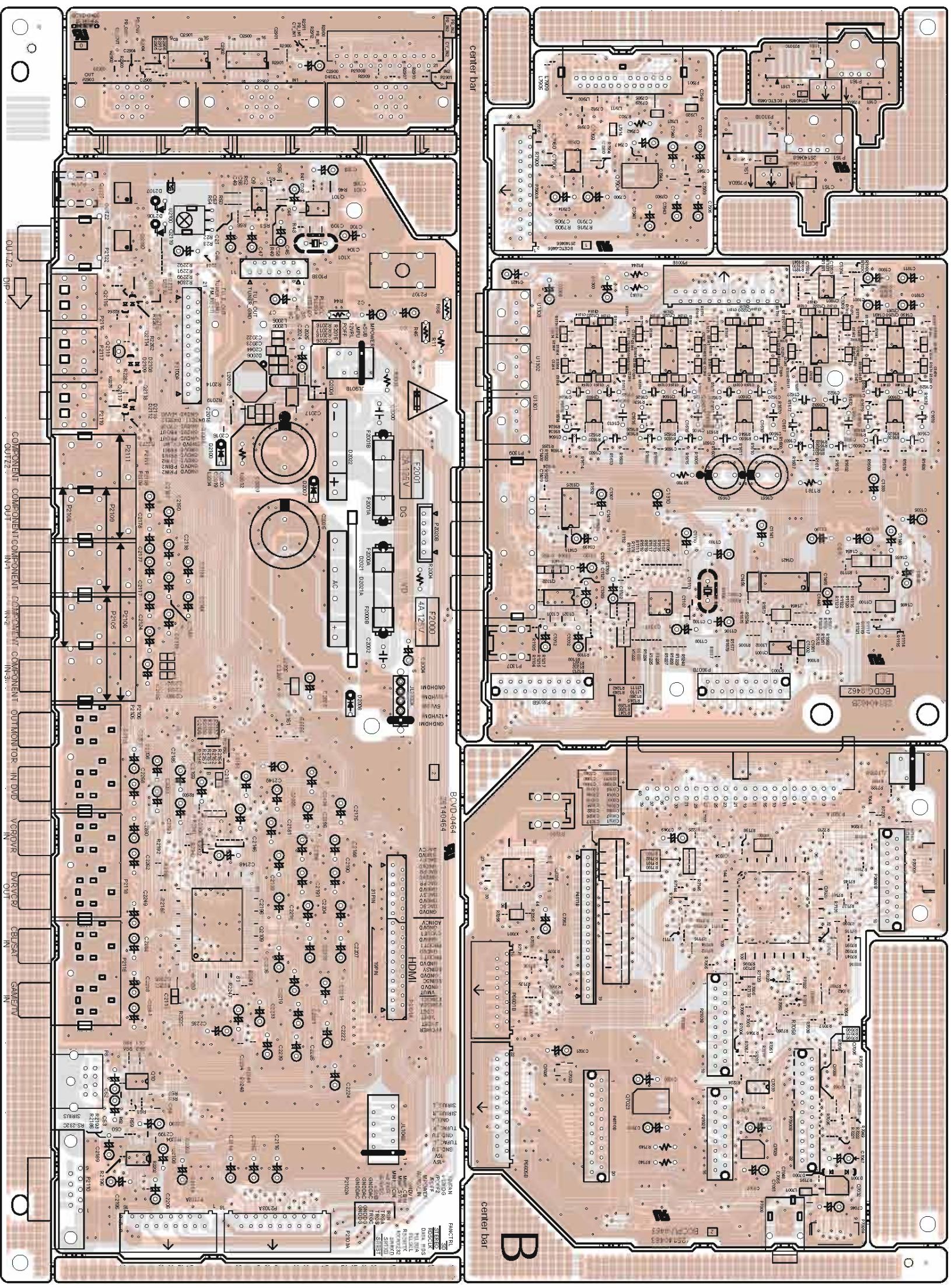

A side view from B side

A side pattern
B side pattern

PRINTED CIRCUIT BOARD VIEW-6-1

U006 DISPLAY PC BOARD
BADIS-0110

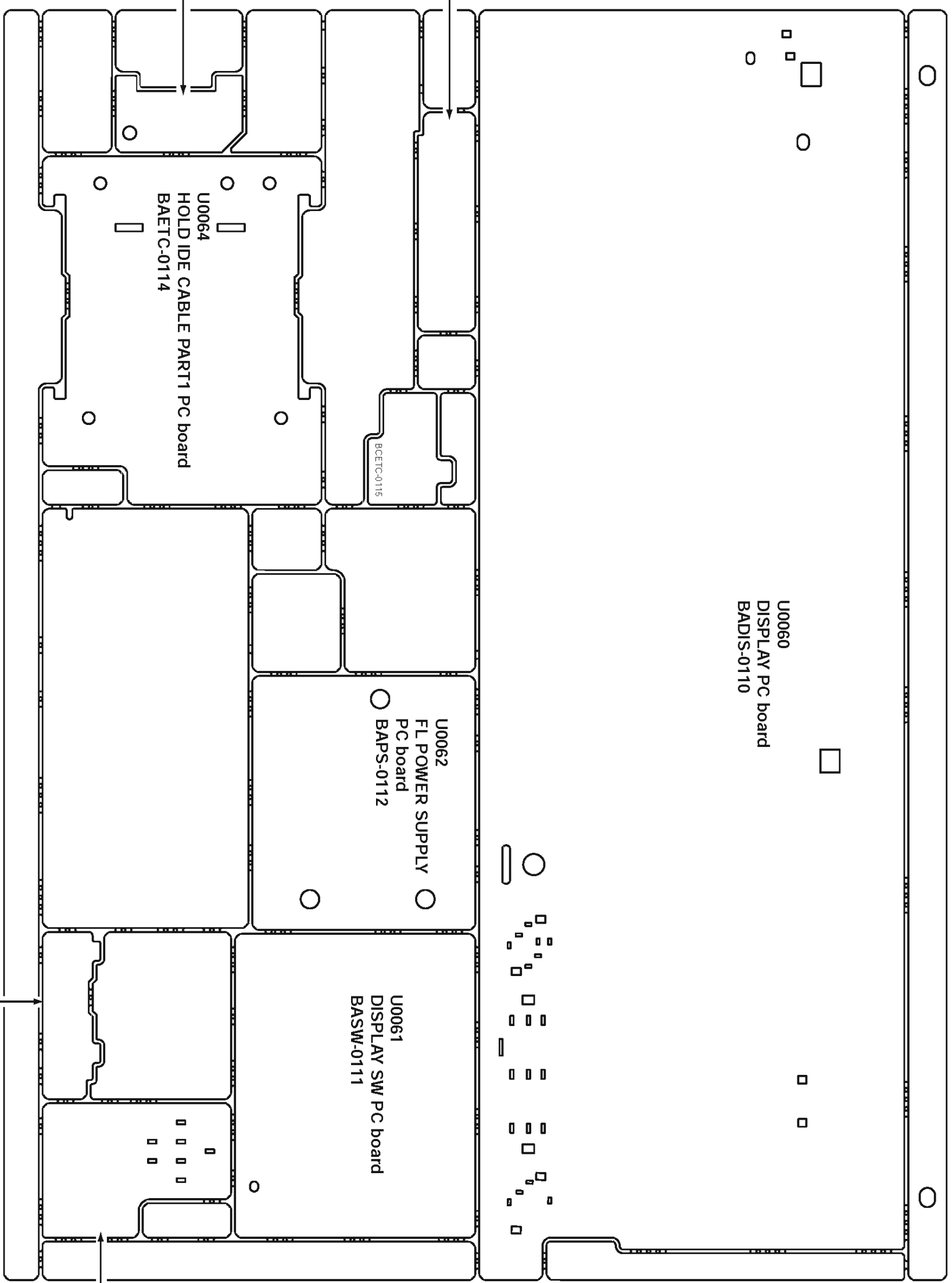

U0065
VOLUME LED PC board
BAETC-0116

U0067
HOLD FRONT HDMI TERMINAL
PC board
BAETC-0118

U0064
HOLD IDE CABLE PART1 PC board
BAETC-0114

BCETC-0115

U0062
FL POWER SUPPLY
PC board
BAPS-0112

U0061
DISPLAY SW PC board
BASW-0111

U0060
DISPLAY PC board
BADIS-0110

U0066 HOLD IDE CABLE PART2 PC board
BAETC-0117

U0063
HEADPHONE TERMINAL PC board
BAETC-0113

PRINTED CIRCUIT BOARD VIEW-6-2

U006 DISPLAY PC BOARD
BADIS-0110

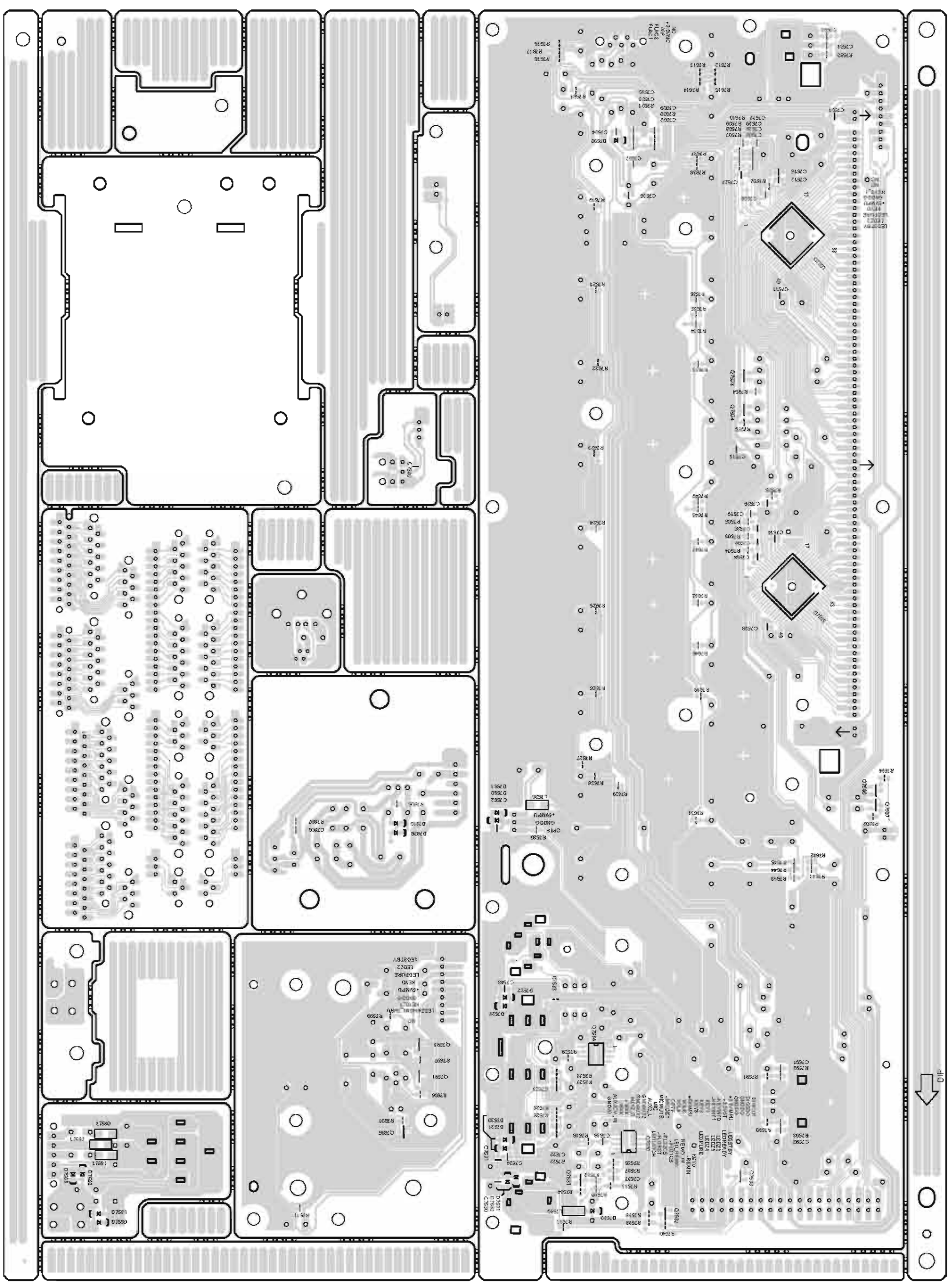

A side view

A B C D E F G H
PRINTED CIRCUIT BOARD VIEW-6-3

U006 DISPLAY PC BOARD
BADIS-0110

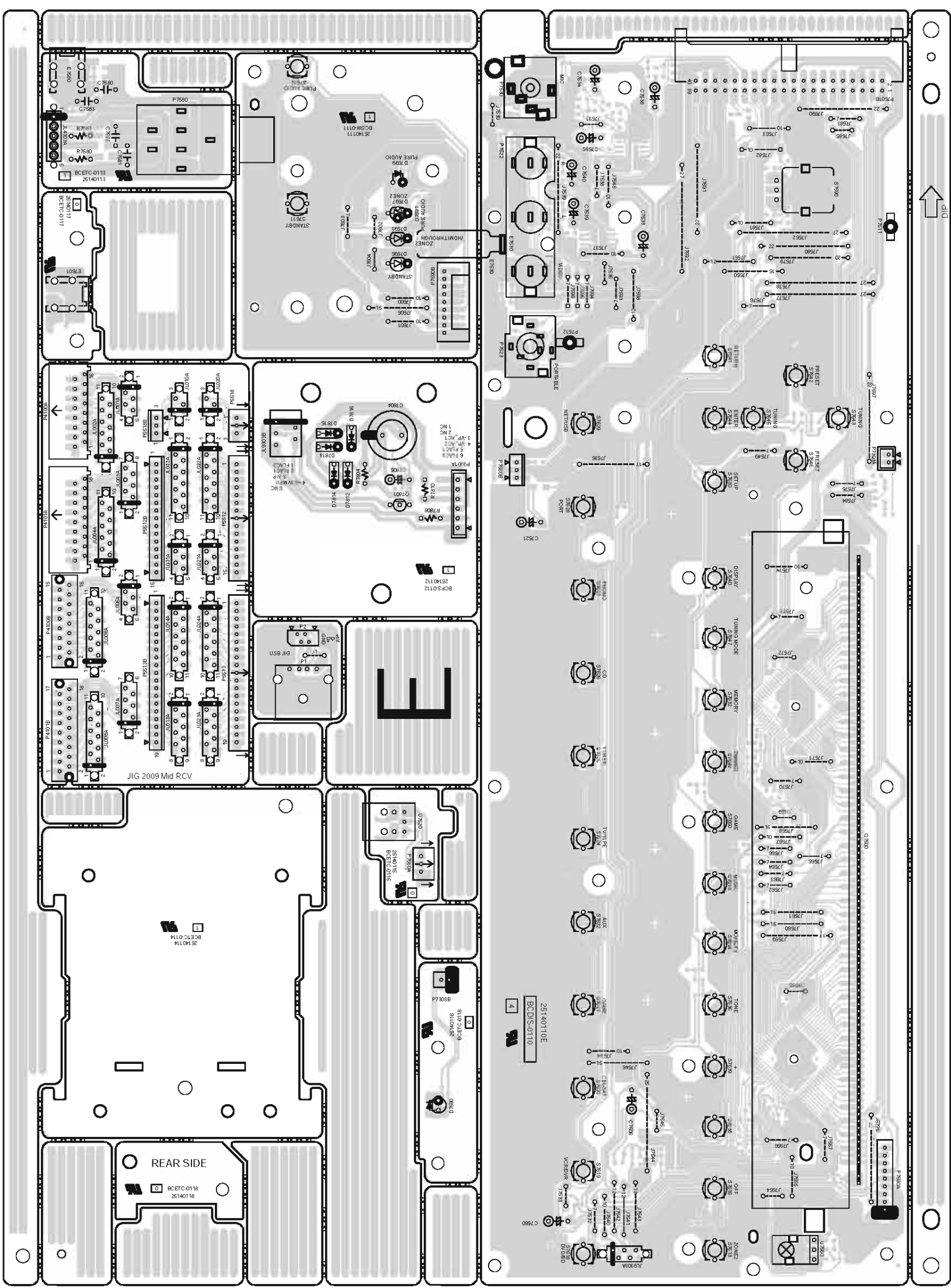

B side view

PRINTED CIRCUIT BOARD VIEW-6-1

U006

DISPLAY PC BOARD
BADIS-0121

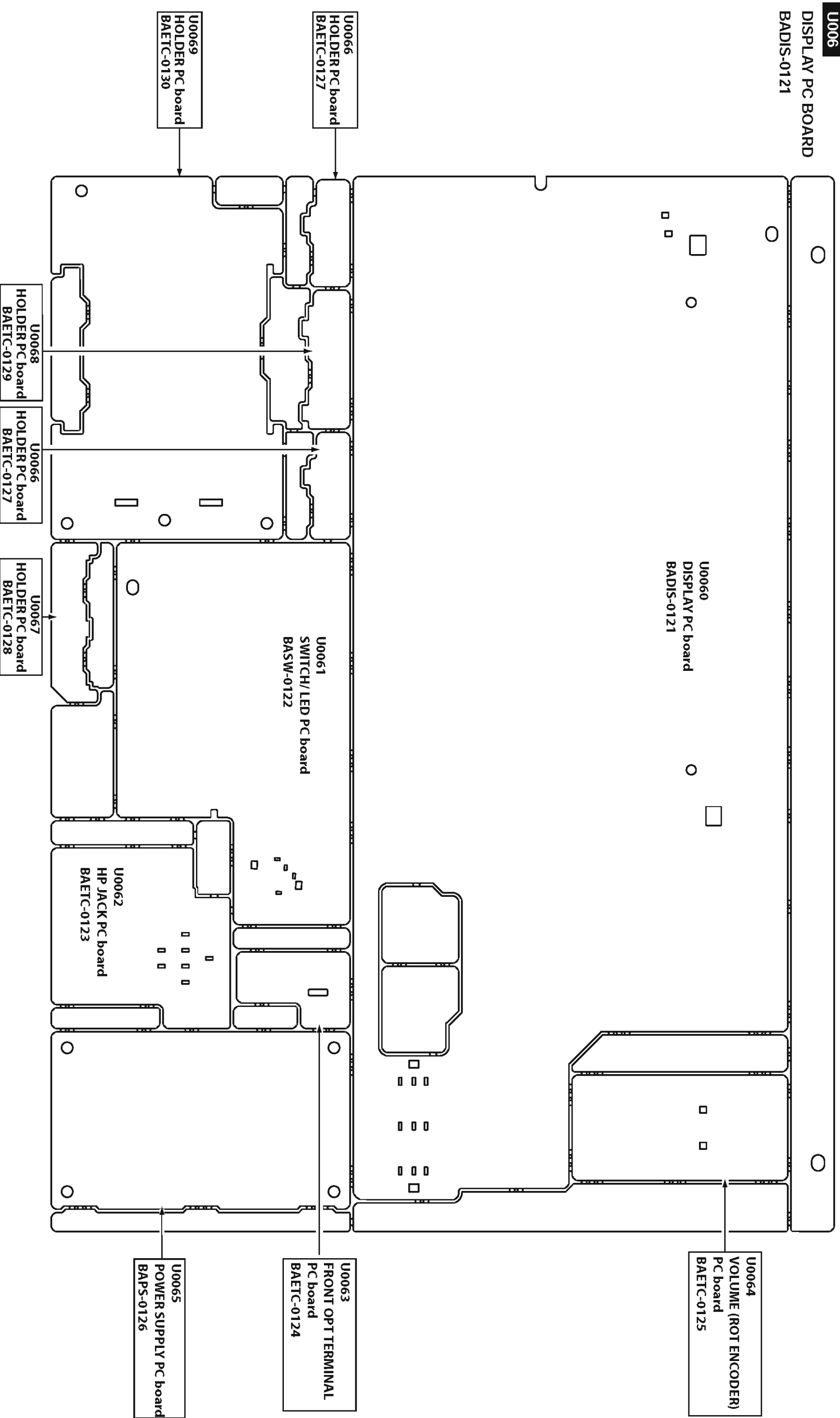

U0064
VOLUME (ROT ENCODER)
PC board
BAETC-0125

U0063
FRONT OPT TERMINAL
PC board
BAETC-0124

U0065
POWER SUPPLY PC board
BAPS-0126

U0060
DISPLAY PC board
BADIS-0121

U0061
SWITCH/LED PC board
BASW-0122

U0062
HP JACK PC board
BAETC-0123

U0068
HOLDER PC board
BAETC-0129

U0066
HOLDER PC board
BAETC-0127

U0067
HOLDER PC board
BAETC-0128

U0066
HOLDER PC board
BAETC-0127

U0069
HOLDER PC board
BAETC-0130

A B C D E F G H

PRINTED CIRCUIT BOARD VIEW-6-2

U006

DISPLAY PC BOARD
BADIS-0121

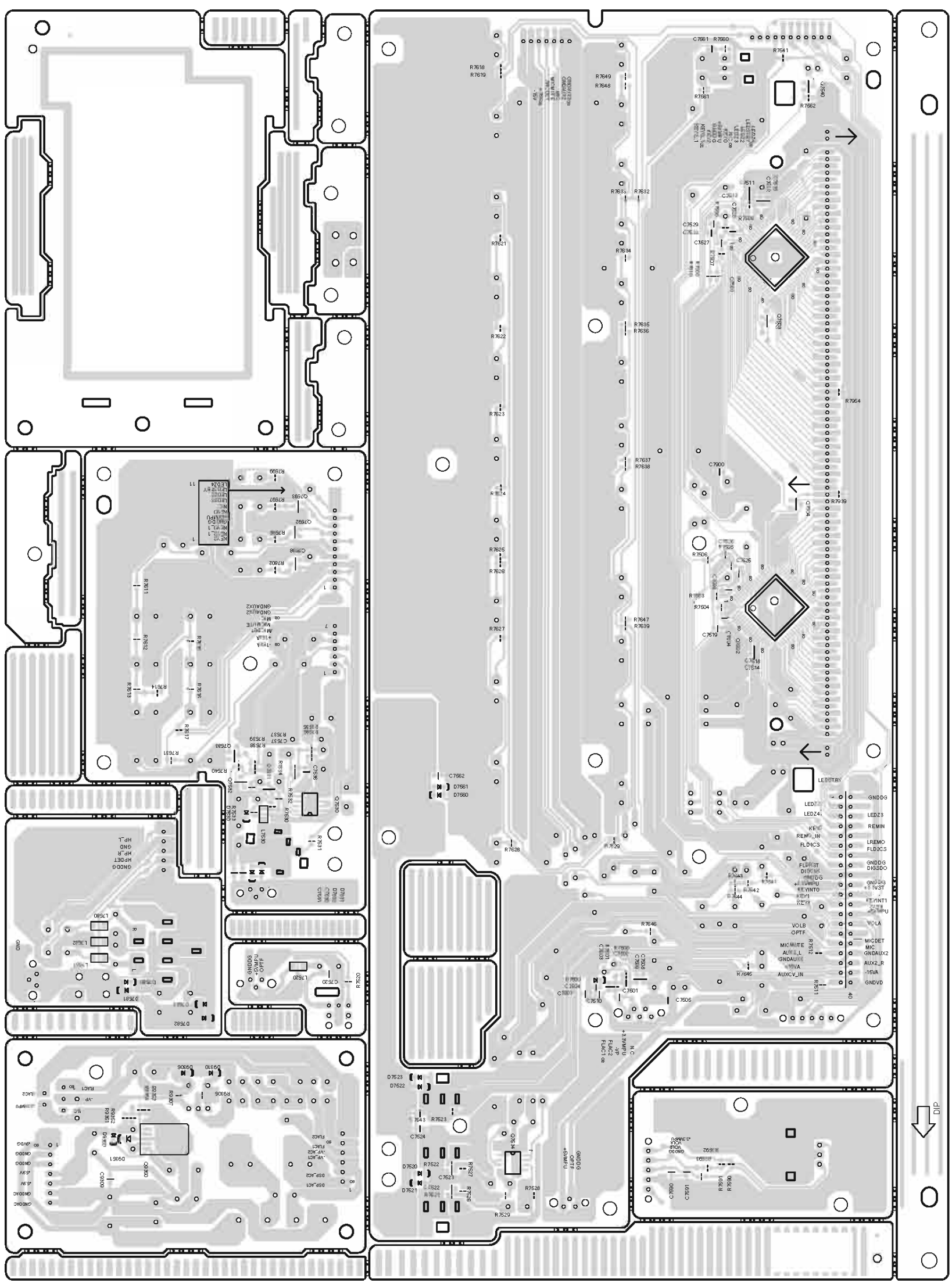

B side view from A side

A B C D E F G H

PRINTED CIRCUIT BOARD VIEW-6-3

U006

DISPLAY PC BOARD

BADIS-0121

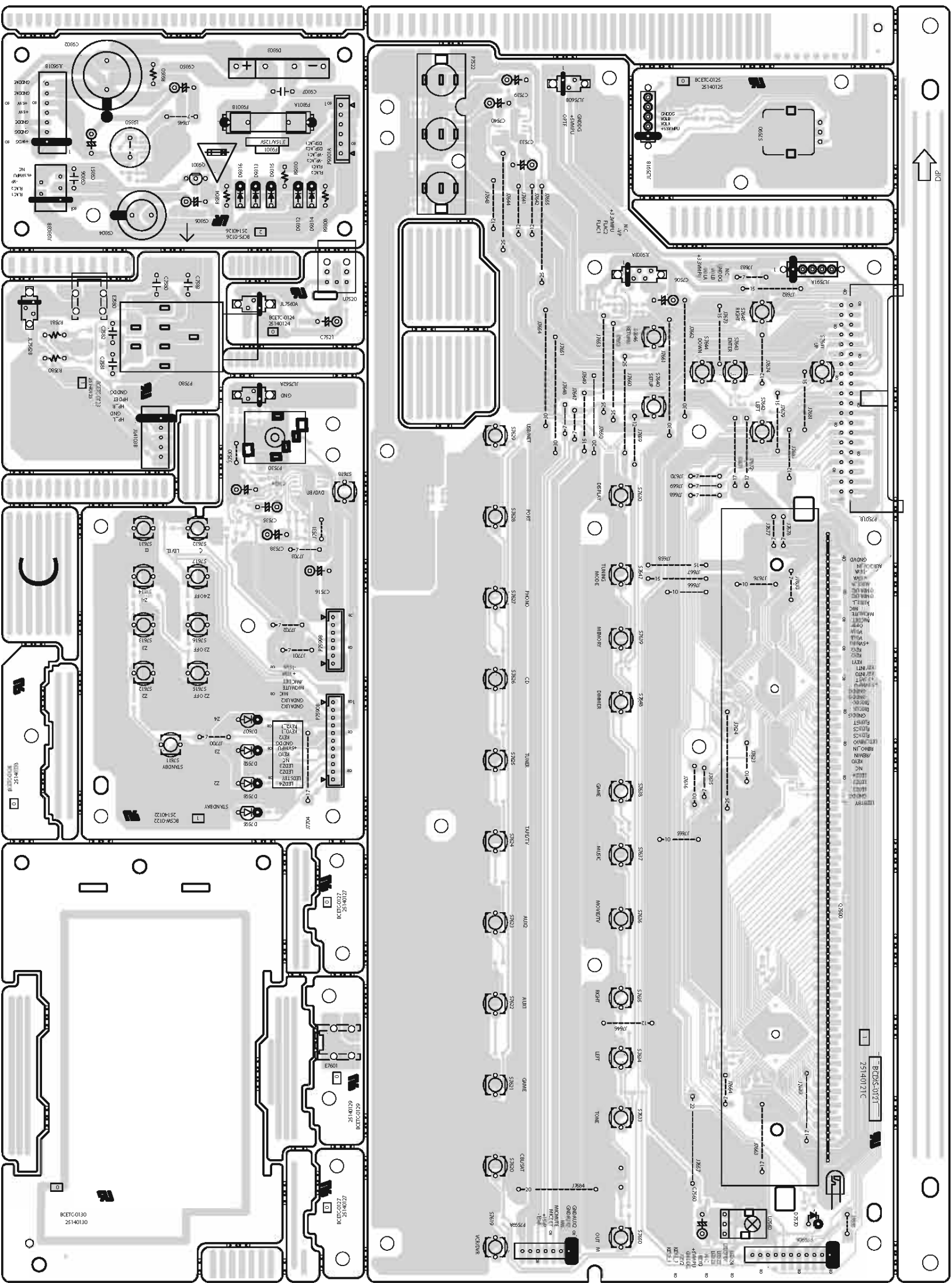

A side view from B side

PRINTED CIRCUIT BOARD VIEW-6-1

U006
DISPLAY PC BOARD
BADIS-0135

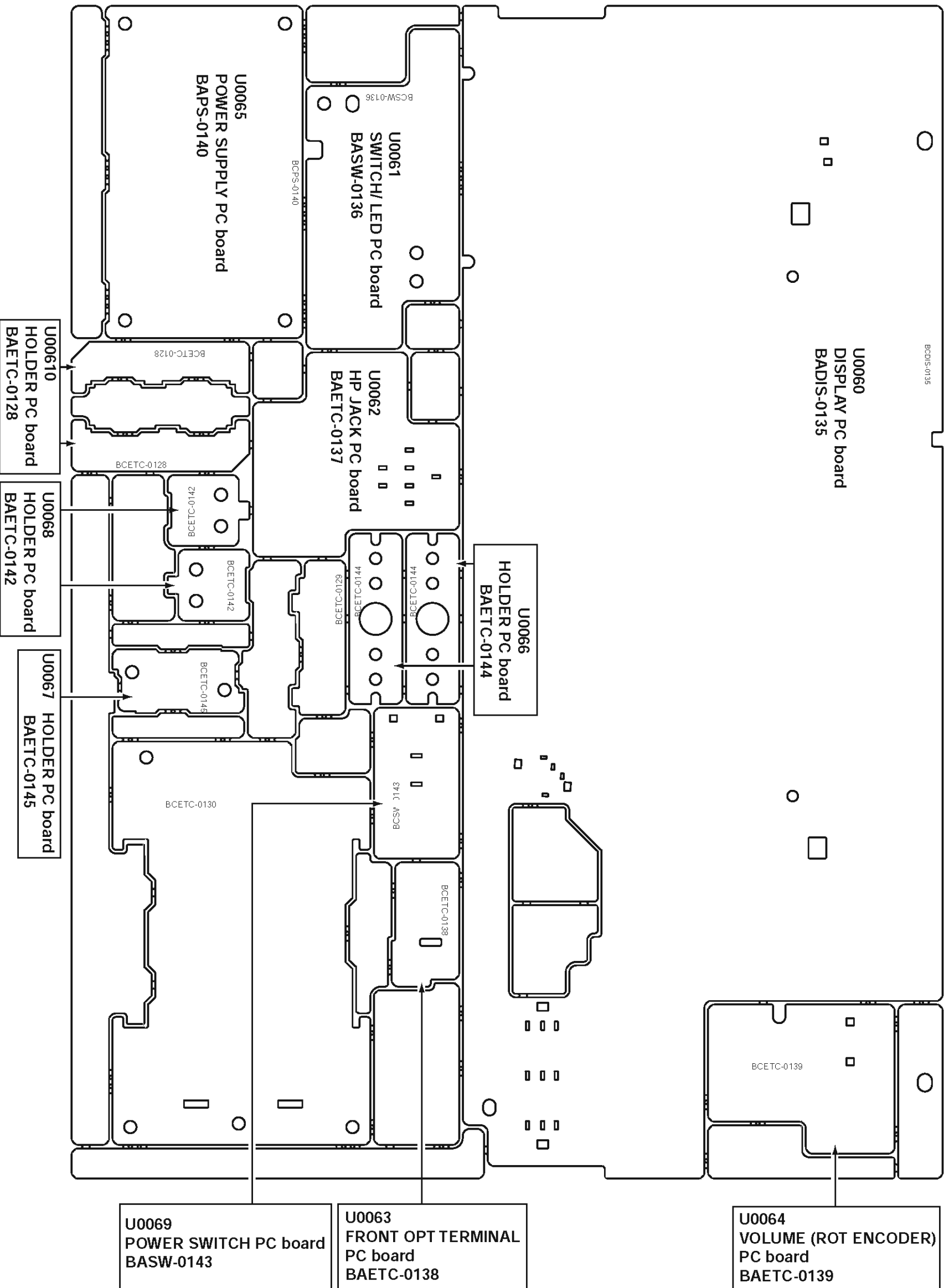

5

4

3

2

1

A

B

C

D

E

F

G

H

A | B | C | D | E | F | G | H

PRINTED CIRCUIT BOARD VIEW-6-2

U006

DISPLAY PC BOARD
BADIS-0135

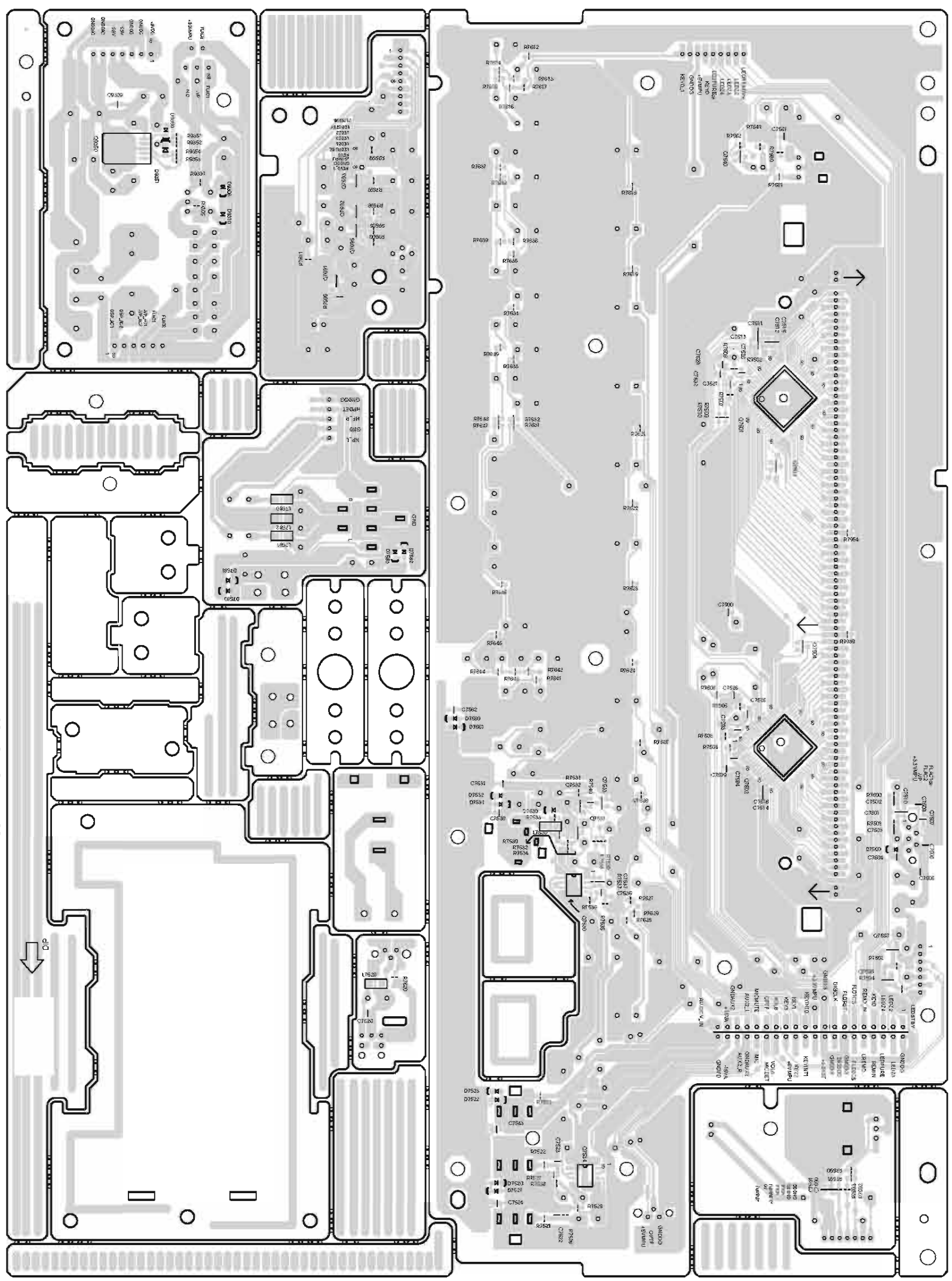

B side view from A side

5

4

3

2

1

PRINTED CIRCUIT BOARD VIEW-6-3

U006

DISPLAY PC BOARD
BADIS-0135

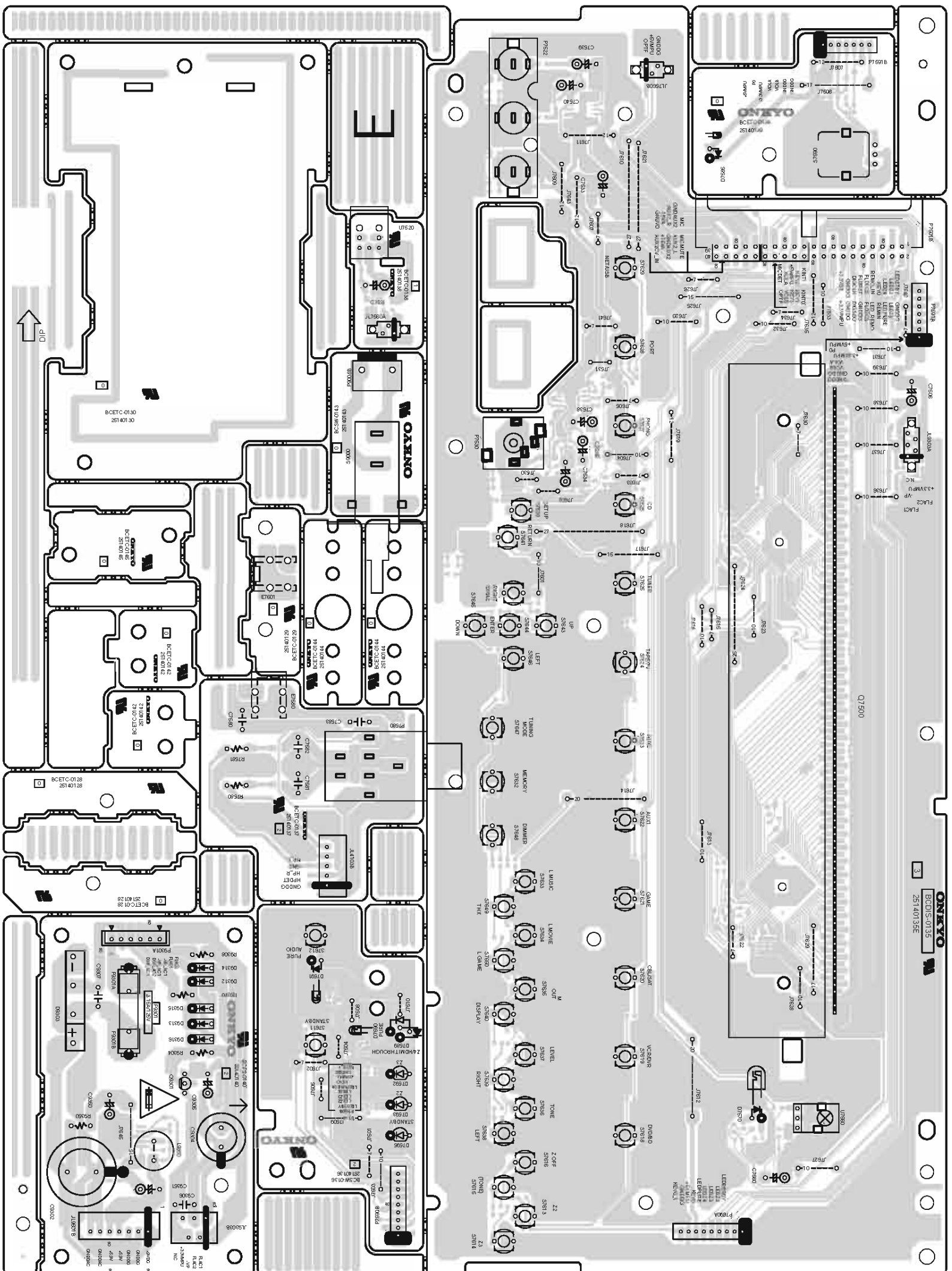

A side view from B side

PRINTED CIRCUIT BOARD VIEW-6-1

U006
DISPLAY BOARD
BADIS-0146

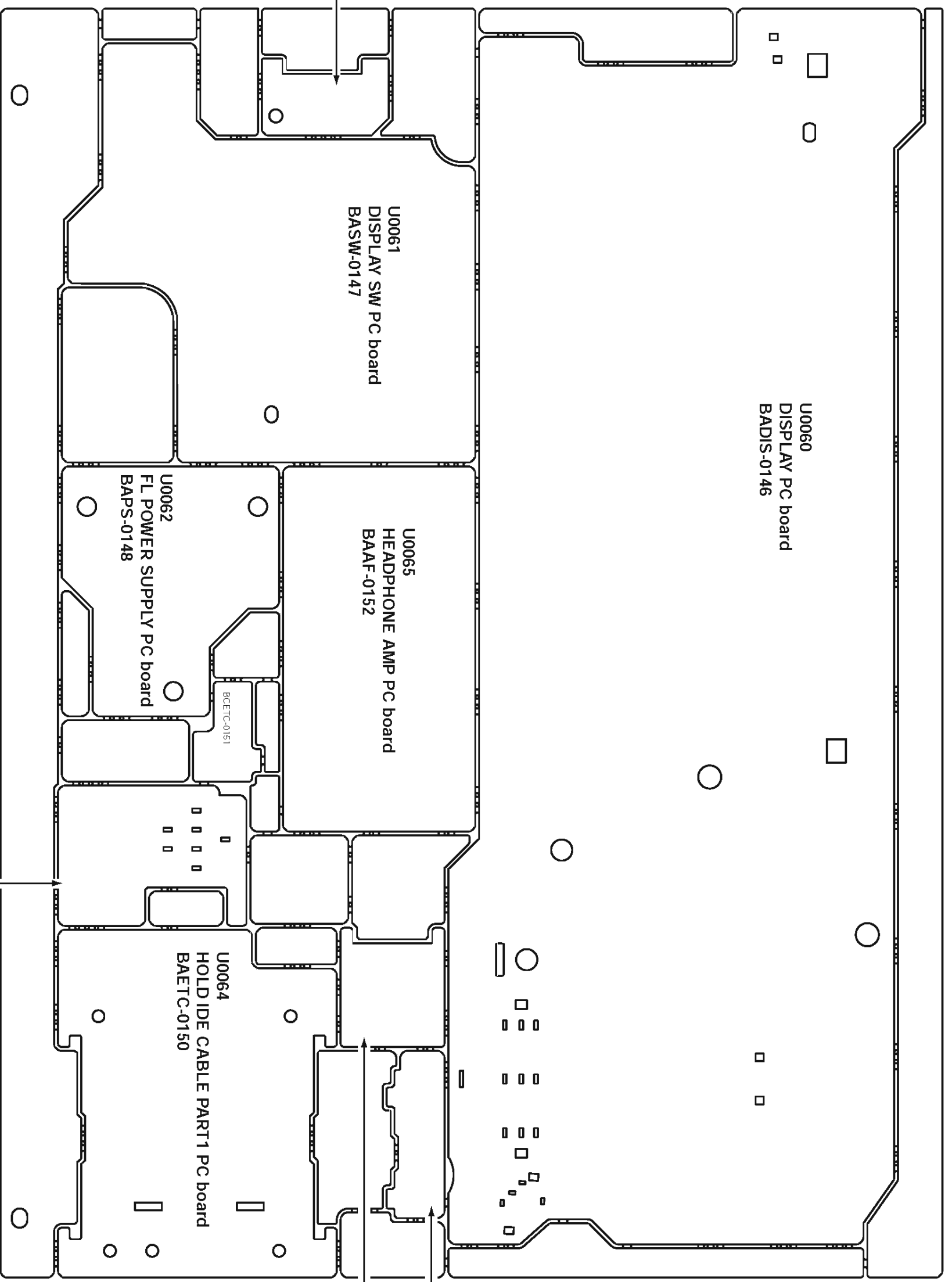

U0060
DISPLAY PC board
BADIS-0146

U0061
DISPLAY SW PC board
BASW-0147

U0065
HEADPHONE AMP PC board
BAAF-0152

U0062
FL POWER SUPPLY PC board
BAPS-0148

U0064
HOLD IDE CABLE PART1 PC board
BAETC-0150

U0063
HEADPHONE TERMINAL PC board
BAETC-0149

U0066
HOLD FRONT HDMI
TERMINAL PC board
BAETC-0154

U0067
HOLD IDE CABLE PART2
PC board
BAETC-0155

U0068
HOLD HEADPHONE
TERMINAL
PC board
BAETC-0156

A B C D E F G H

PRINTED CIRCUIT BOARD VIEW-6.2

U006
DISPLAY BOARD
BADIS-0146

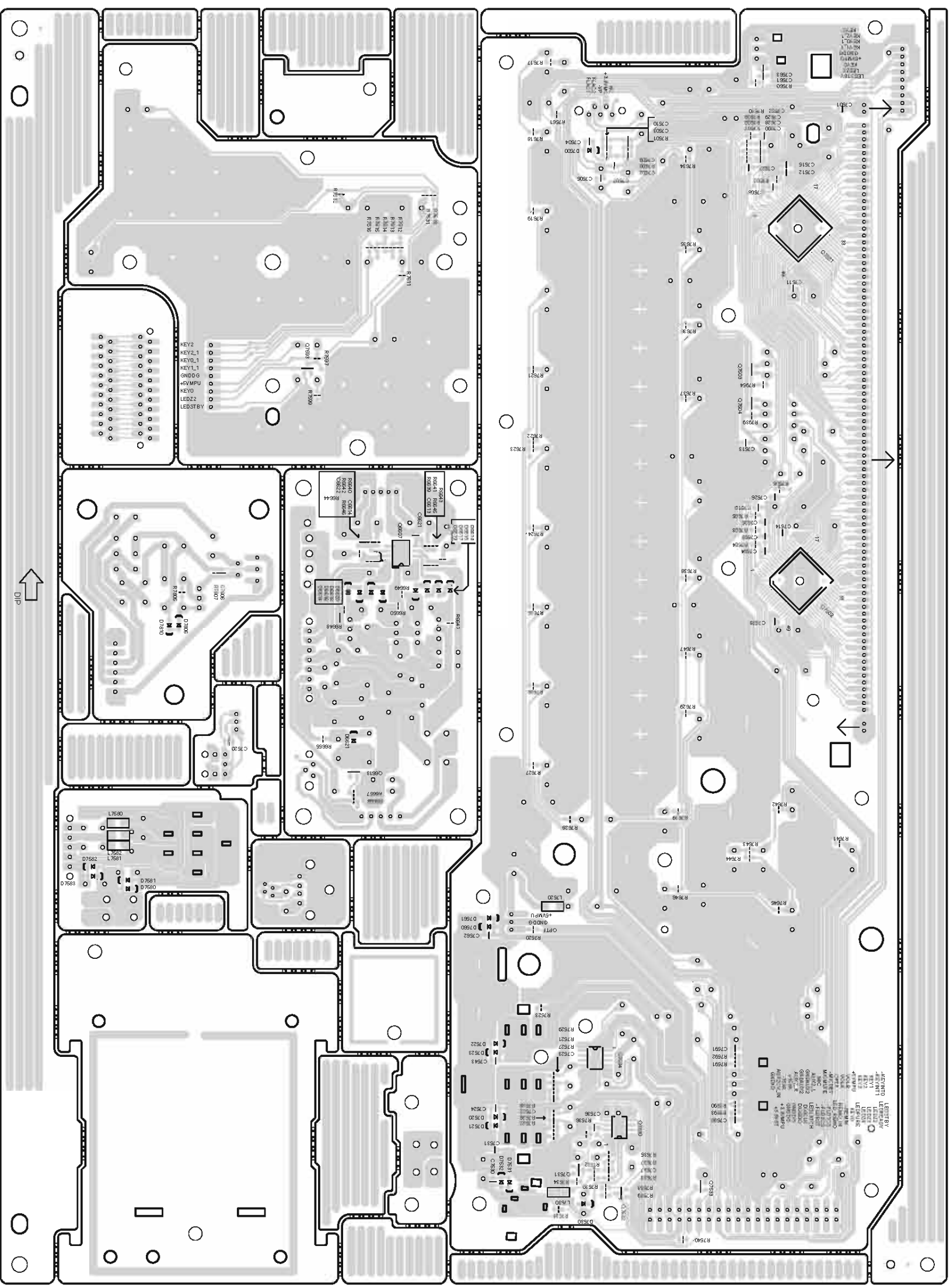

B side view from A side



A B C D E F G H

PRINTED CIRCUIT BOARD VIEW-6-3

U006
DISPLAY BOARD
BADIS-0146

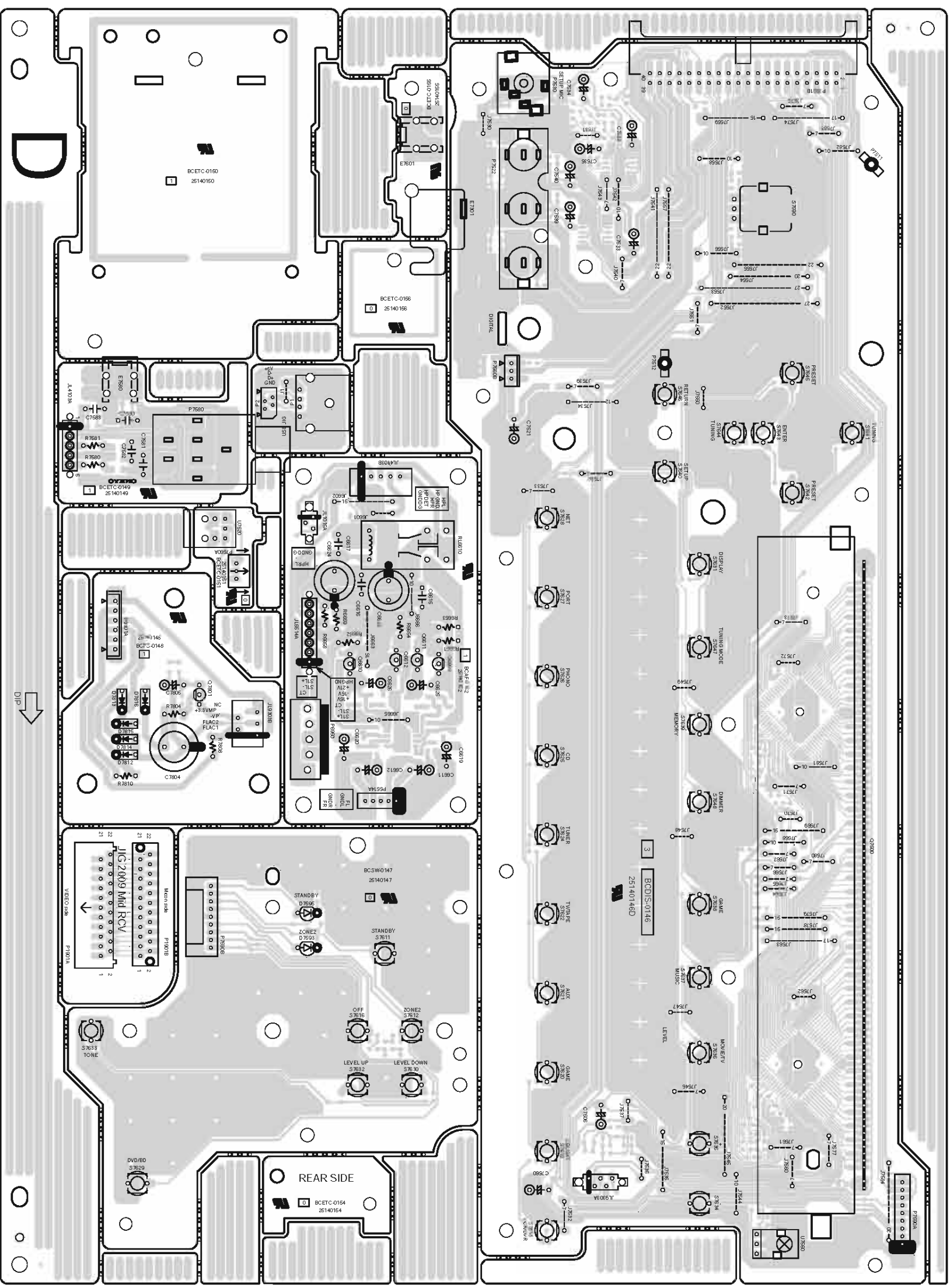

A side view from B side



D

5

4

3

2

1

PRINTED CIRCUIT BOARD VIEW-7-1

U007 HDMI board BAHDM-0471

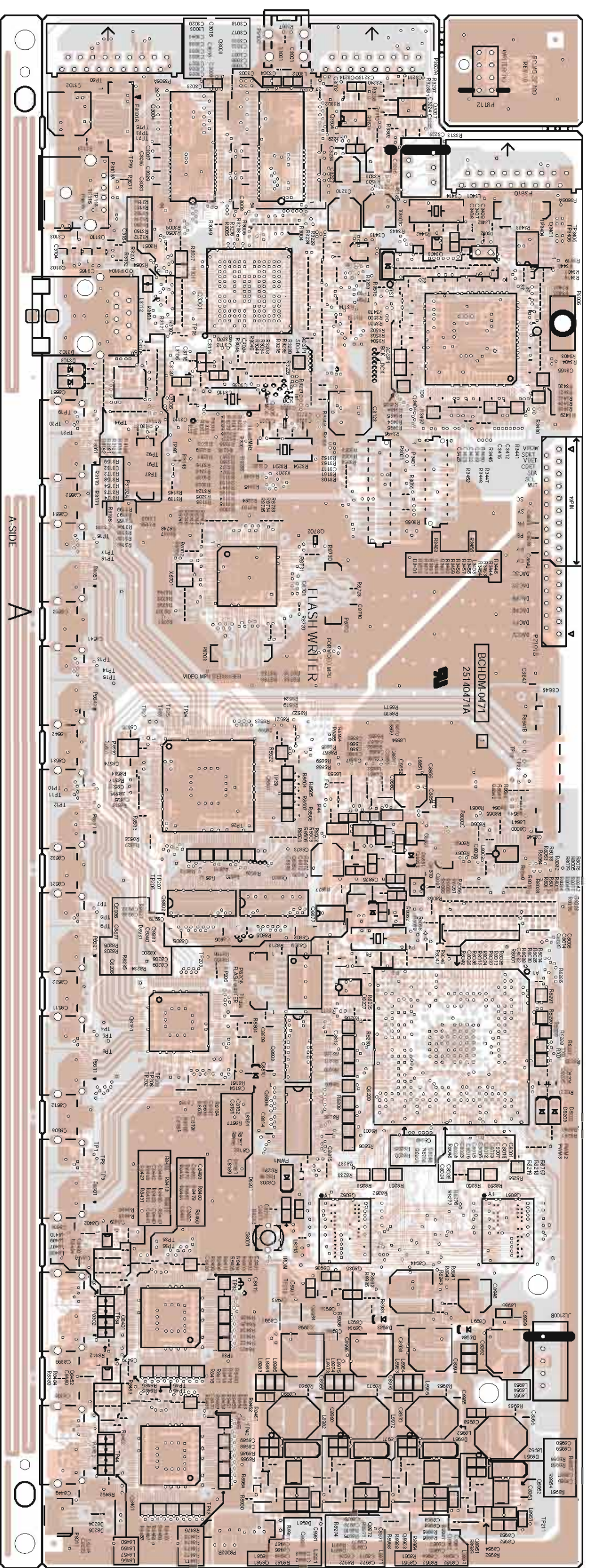

A side view

█ A side pattern
 B side pattern

A B C D E F G H
PRINTED CIRCUIT BOARD VIEW-7.2

U007 HDMI board BAHDM-0471

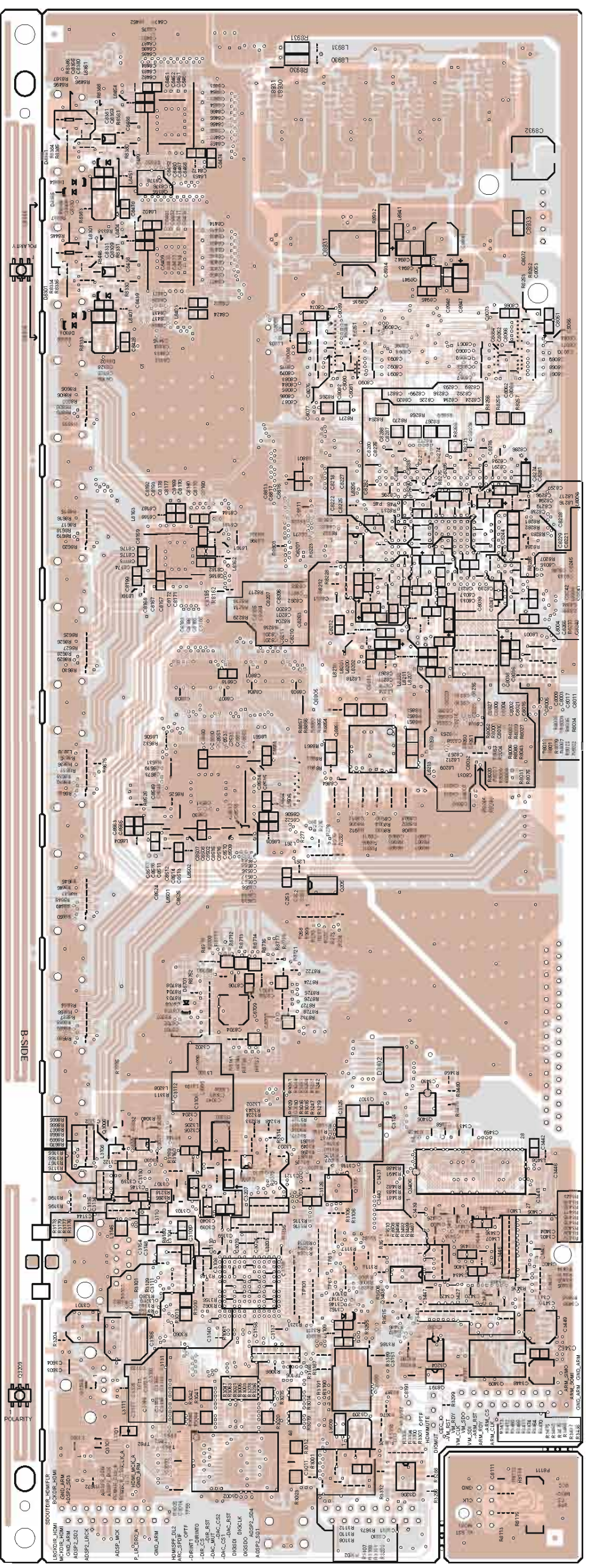

B side view

A side pattern
B side pattern

A B C D E F G H
PRINTED CIRCUIT BOARD VIEW-7.2

U007 HDMI board BAHDM-0471

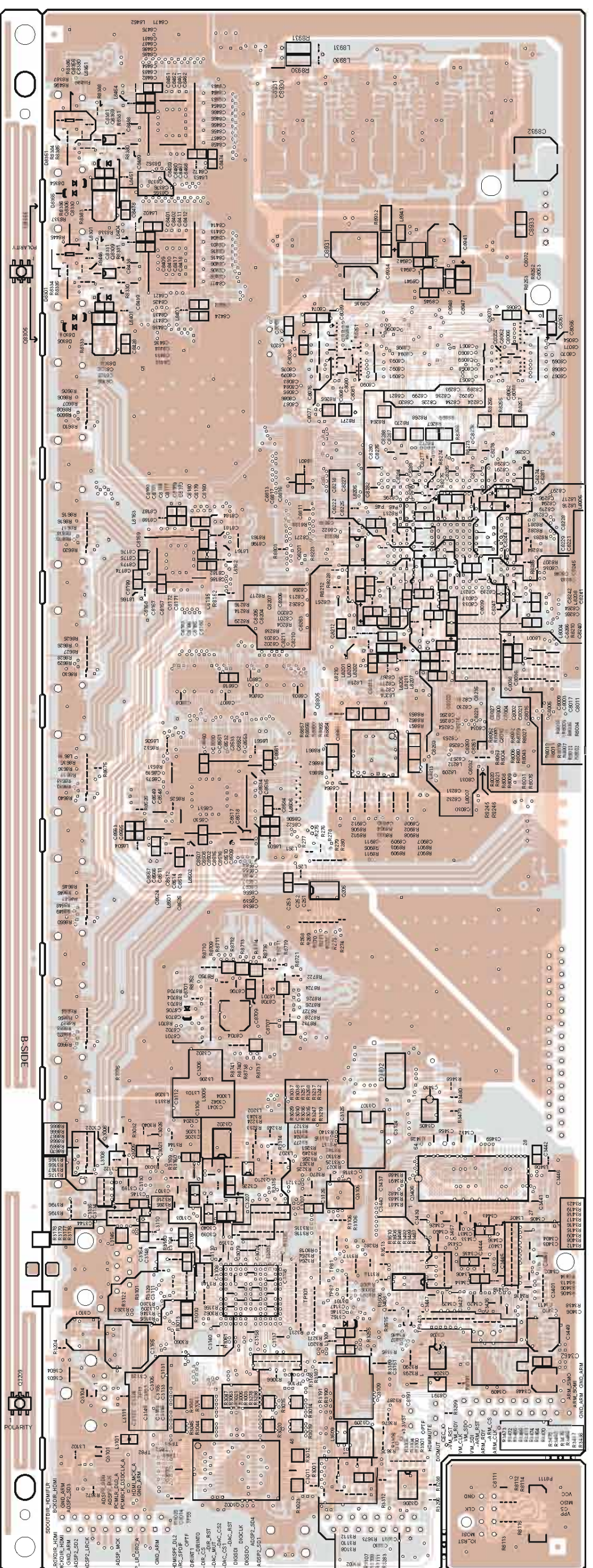

B side view

A side pattern
B side pattern

PRINTED CIRCUIT BOARD VIEW-8-1

U008

FRONT HDMI
TERMINAL BOARD
BAHDM-0290

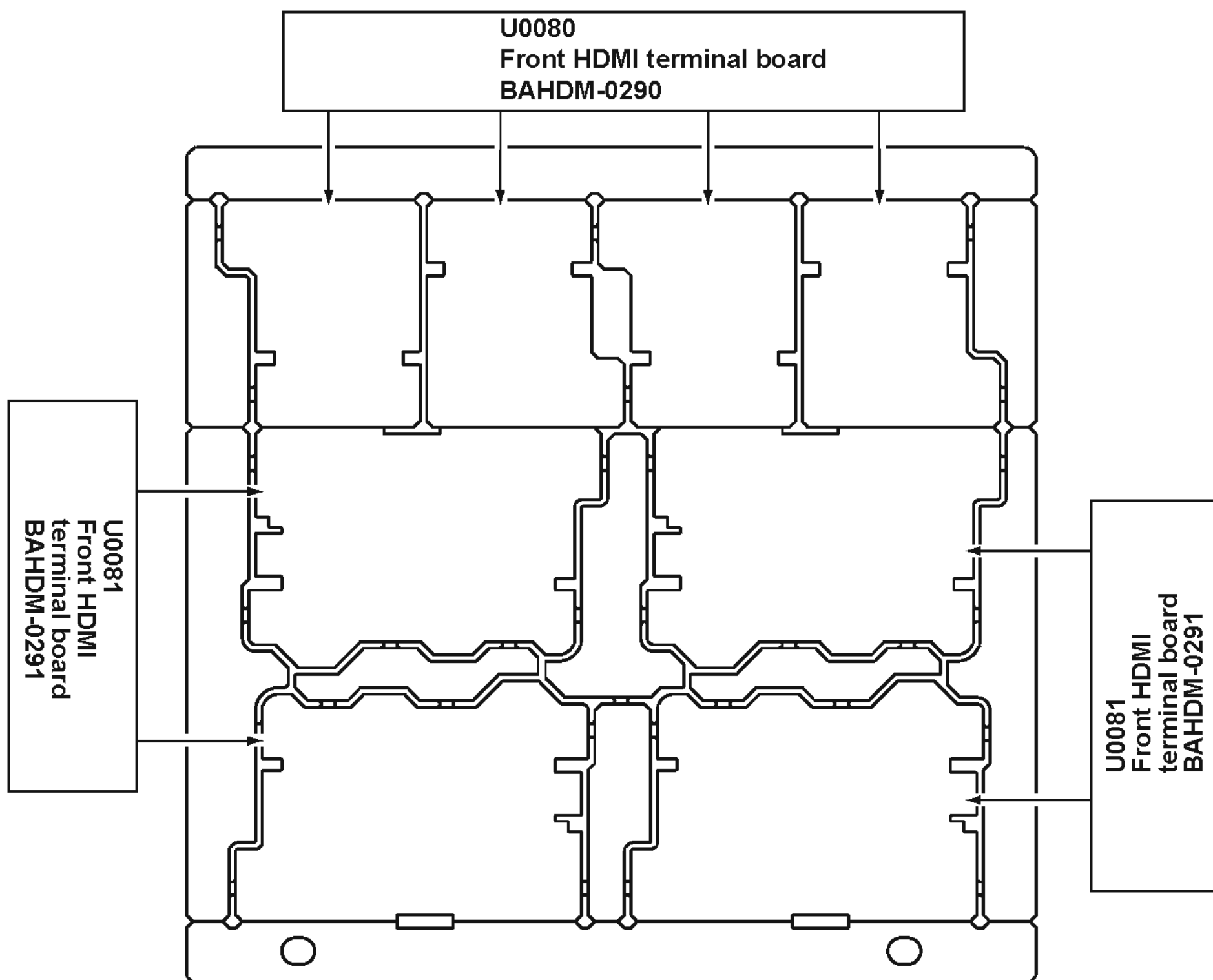

A

B

C

D

PRINTED CIRCUIT BOARD VIEW-8-2

U008

FRONT HDMI
TERMINAL BOARD
BAHDM-0290

1

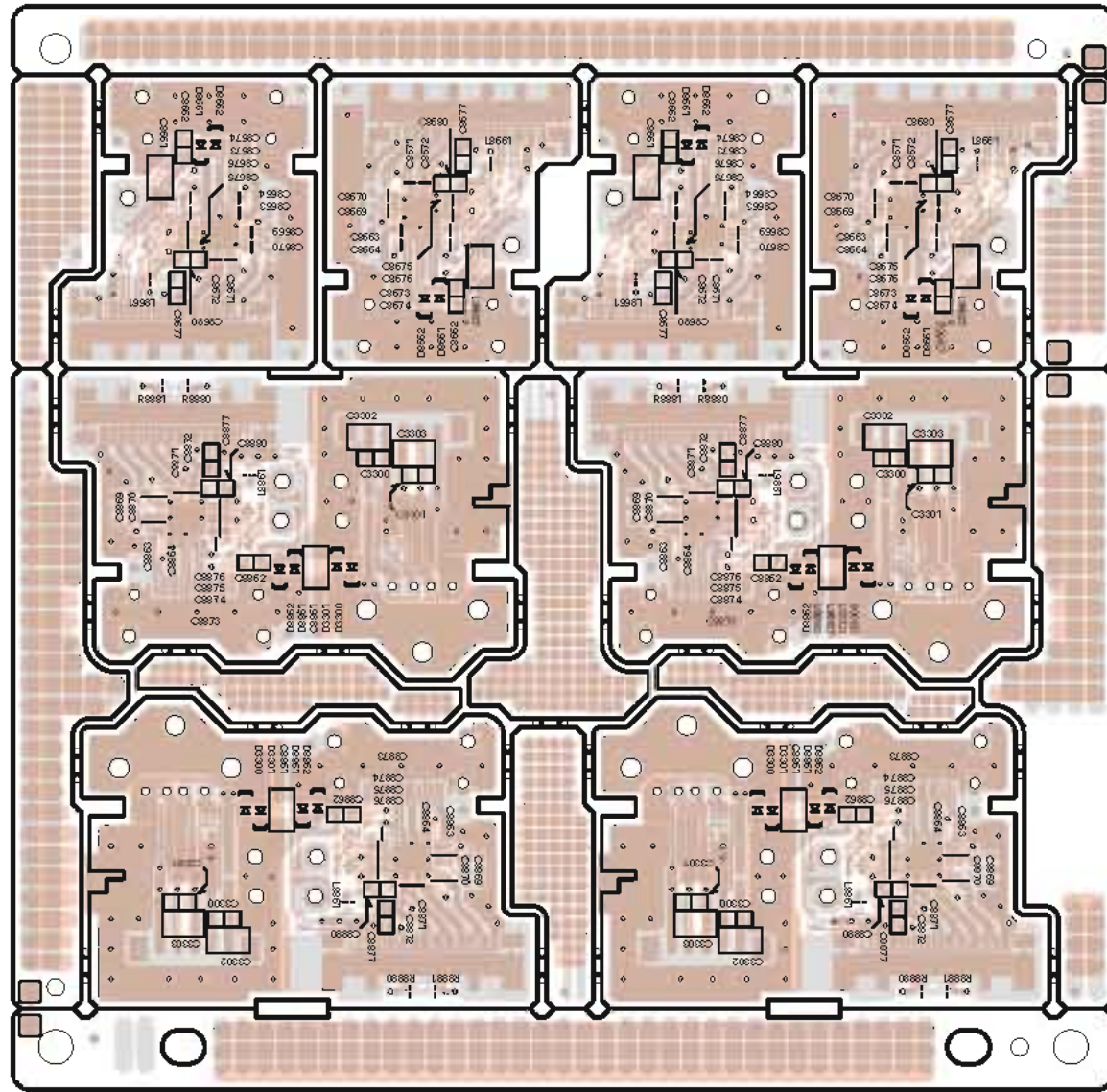

B side view

2

3

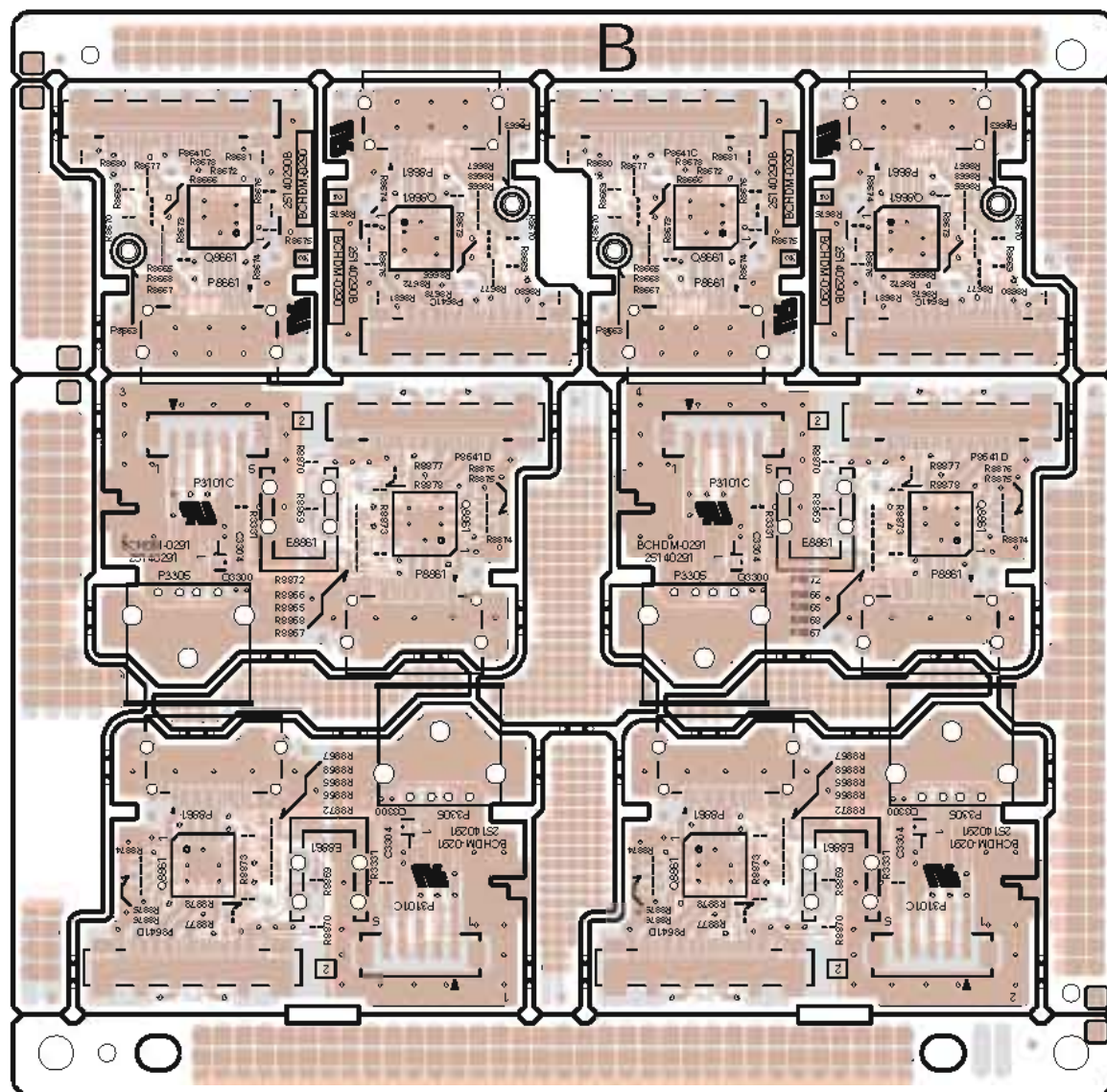

A side view

4

5

<Note>

Parts marked by "NSP" are generally unavailable because they are not in our Master Spare Parts List

NOTE : THE COMPONENTS IDENTIFIED BY THE MARK
 ! ARE CRITICAL FOR RISK OF FIRE AND
 ELECTRIC SHOCK. REPLACE ONLY WITH PART
 NUMBER SPECIFIED.

TX-NR708

<Notes>

- (B) : Black model
- (S) : Silver model
- (G) : Golden model
- <MDC> : 120V, Canadian model
- <MDF> : 120V, Taiwanese model
- <MMA> : 230V, Australian model
- <MMP> : 230V, CE (European) country model
- <MMQ> : 220/230-240V, Hong kong model
- <MMR> : 220/230-240V, Chinese model
- <MLJ> : 100V, Japanese model

EXPLODED VIEW PARTS LIST

TX-NR708

REF. NO.	PART NAME	DESCRIPTION	QTY	PART NO. (SN)	REMARKS
Q6050	TR	ZSC5242-O	1	2202843	
Q6050 or	TR	ZSC5242-R	(1)	2202842	
Q6050A	ISO SHEET	(NR708_3 SCH)	1	223056	
Q6050B	ISO SHEET	(NR708_3 SCH)	1	223056	
Q6051	TR	ZSC5242-O	1	2202843	
Q6051 or	TR	ZSC5242-R	(1)	2202842	
Q6052	TR	ZSC5242-O	1	2202843	
Q6052 or	TR	ZSC5242-R	(1)	2202842	
Q6053	TR	ZSC5242-O	1	2202843	
Q6053 or	TR	ZSC5242-R	(1)	2202842	
Q6054	TR	ZSC5242-O	1	2202843	
Q6054 or	TR	ZSC5242-R	(1)	2202842	
Q6055	TR	ZSC5242-O	1	2202843	
Q6055 or	TR	ZSC5242-R	(1)	2202842	
Q6056	TR	ZSC5242-O	1	2202843	
Q6056 or	TR	ZSC5242-R	(1)	2202842	
Q6060	TR	ZSA1962-O	1	2202833	
Q6060 or	TR	ZSA1962-R	(1)	2202832	
Q6061	TR	ZSA1962-O	1	2202833	
Q6061 or	TR	ZSA1962-R	(1)	2202832	
Q6062	TR	ZSA1962-O	1	2202833	
Q6062 or	TR	ZSA1962-R	(1)	2202832	
Q6063	TR	ZSA1962-O	1	2202833	
Q6063 or	TR	ZSA1962-R	(1)	2202832	
Q6064	TR	ZSA1962-O	1	2202833	
Q6064 or	TR	ZSA1962-R	(1)	2202832	
Q6065	TR	ZSA1962-O	1	2202833	

Q6065 or	TR	2SA1962-R	(1)	2202832
Q6066	TR	2SA1962-O	1	2202833
Q6066 or	TR	2SA1962-R	(1)	2202832
CHASSIS (SCREW)				
A001	HEAT SINK	---	1	27160648
A007	SCREW	3MSMSW SW+14R(CU)	14	801634
A009	SCREW	3ITB+8B(3CM)SR	1	801637
A011	RETAINER	(HT-K)	1	27142114A
A013	RETAINER	(HT-L)	1	27142182
A015	SCREW	3ITB+8B(3CM)SR	4	801637
A017	SCREW	3ITB+8B(3CM)SR	2	801637
A019	BRACKET	(FAN-S)	1	27131047
A021	SCREW	3ITB+8B(3CM)SR	2	801637
A023	BUSHING	(FAN-S)	2	28170090
A025	CUSHION	---	2	28141783
A027	CUSHION	110*10*10EPT	1	28141813
A029	SCREW	3ITB+8B(3CM)SR	3	801637
A031	SCREW	3ITB+8B(3CM)SR	3	801637
A032	SCREW	3ITB+8B(3CM)SR	2	801637
A035	CUSHION	---	5	28141783
A037	B CUSHION	W15*3 TAPE	1	28141585
A039	WIRE TIE	B SK-1	5	260208
A081	CHASSIS	TX-NR708	1	27100549
A095	BOTTOMLEG	TX-SR506	4	27175441A
A097	SCREW	3ITB+10B(3B)C	4	838430108GR
A101	WASHER	W3*8R(3CM)	4	87613008GR
A113	HOLDER	KGLS-4S	1	27190009
A117	HOLDER	HOLDER KGLS-8S	3	27190480
A119	HOLDER	HOLDER KGLS-8S	3	27190480
A121	HOLDER	KGFS-14RF	3	27190802
A123	HOLDER	KGFS-14RF	5	27190802
A125	HOLDER	KGFS-14RF	1	27190802
A127	HOLDER	HOLDER KGLS-18S	2	27190470
A129	HOLDER	HOLDER KGLS-18S	2	27190470
A131	HOLDER	KGLS-14S	1	27190164
A133	HOLDER	KGLS-10RT	1	27190428A
A135	HOLDER	KGLS-12RT	1	27190266
A137	HOLDER	KGLS-22RT	2	27190772
A141	SCREW	3ITB+8B(3CM)SR	1	801637
A143	SCREW	3ITB+8B(3CM)SR	2	801637
A144	CUSHION	115*30*10	1	28141802
A145	SPACER	10 5xq8xq 3 277P	1	27170438
A179	SCREW	4ITC+8C(3B)C	4	830440089GR
A181	SCREW	3ITB+8B(3B)C	5	838430088GR
A183	SCREW	3ITB+8B(3CM)SR	4	801637
A185	CLAMP	WS-2NS	1	27300833
A191	CUSHION	T10*30*10EPT	1	28141822

A193	SPACER	---	1	27270439	
A195	ISO PLT	(HS-R)	1	28175340	
A197	RIVET	P-RIVET NRP-345	4	880009	
A237A	LABEL	(E-CON)	(1)	29364978	
A239	CUSHION	(BUTYL)	1	28141748	<B / S>
A241	CUSHION	(BUTYL)	1	28141748	
A245	TAPE	TAPE(CLOTH-80)	1	29110082	
A247	LABEL	(P1)	1	29363379-1	
A249	WIRE TIE	B SK-1	8	260208	
A251	REAR PANEL	708MP	1	27124128	N <B MMA, MNF, MMQ / S MMF>
A251	REAR PANEL	708MR	1	27124129	N <B MMF>
A251	REAR PANEL	708U	1	27124130	N <B MU>
A251	REAR PANEL	708DC	1	27124127A	N <B MDC, MDF>
A253	BUSHING	S-RELIEF #2271	1	27300750	<B MDC, MDF>
A255	SCREW	31TB+8B(3B C)	12	838430088GR	
A257	SCREW	31TB+8B(3B C)	10	838430088GR	
A259	SCREW	31TB+8B(3B C)	7	838430088GR	<B MDC, MDF, MMA, MNF, MMQ, MMF / S MMF>
A259	SCREW	31TB+8B(3B C)	6	838430088GR	<B MU>
A261	SCREW	31TB+8B(3B C)	5	838430088GR	
A263	SCREW	31TB+8B(3B C)	2	838430088GR	<B MDC, MDF, MMA, MNF, MMQ, MMF / S MMF>
A264	SCREW	31TB+8B(3B C)	1	838430088GR	
A265	SCREW	31TB+8B(3B C)	3	838430088GR	
A267	SCREW	3P+6FN(3B C)	7	82143006GR	<B MU>
A269	SCREW	3P+6FN(3B C)	2	82143006GR	
A271	SCREW	3P+6FN(3B C)	1	82143006GR	<B MDC, MDF>
A273	SCREW	31TF+10B(3B C)	2	835430108GR	<B MU, MMA, MNF, MMQ, MMF / S MMF>
A279	SCREW	31TB+8B(3CM)SR	1	801637	
A281	WASHER	W3+10F(3B C)	1	87643010GR	
A283	LABEL	(SP1)	1	29300790	
A285	LABEL	(SP2)	1	29300791	
A289	CUSHION	---	2	28141799	
CABINET					
A301	F BRACKET	(B)	1	27111578A	
A301	F BRACKET	(S)	1	27111579A	N <S>
A303	KNOB	(STNBY)	1	28326663A	
A305	KNOB	(CUR)	1	28326664A	
A307	KNOB	(SEL)	1	28326665	
A309	B PLATE	(B)	1	2813428	
A309	B PLATE	(S)	1	2813429	<S>
A309	B PLATE	---	1	2813430	<B MU>
A313	FACEIT	(VOL)	1	28200039	
A315	SCREW	31TB+8B(3CM)SR	1	801637	
A317	SCREW	2.01TB+8B(3B C)	27	838426088GR	
A321	RETAINER	(USB)TX	1	27142199	
A323	HOLDER	K.GFS-10RF	1	27190813	
A325	HOLDER	K.GLS-4S	3	27190009	
A327	B CUSHION	W15*3 TAPE	1	28141585	

A351	F PANEL	708(B)DC	1	27213361	N <B MDC, MDF>
A351	F PANEL	708(B)MMP	1	27213362	N <B MIMA, MIMP, MIMQ, MIMR>
A351	F PANEL	708(S)MMP	1	27213363	N <S MMMP>
A351	F PANEL	708(B)UJ	1	27213365	N <B MUJ>
A353	CLEAR PLT	(AS)708D	1	28192298	<B MDC, MDF>
A353	CLEAR PLT	(AS)708P	1	28192299	N <B MIMA, MIMP, MIMQ, MIMR / SMMMP>
A353	CLEAR PLT	(AS)708J	1	28192300	N <B MUJ>
A355	BADGE	BADGE	1	28135244	
A355	BADGE	...	1	28135298	<S>
A371	KNOB	(VOL)ASB	1	28326690	
A371	KNOB	(VOL)AS(S)	1	28326691	<S>
A371	KNOB	(VOL)AS(B)	1	28326817	<B MDC>
A373	CUSHION	10.9"Pha48	1	28141824	<S>
A391	SCREW	3TTB+8B(3BC)	3	838430088GR	
A393	SCREW	3TTB+8B(3CM)SR	5	801637	
A395	SCREW	3TTB+8B(3CM)SR	1	801637	
A397	SCREW	3TTB+8B(3CM)SR	1	801637	
A701	COVER	(B) (B end)	1	28184972	
A701	COVER	(S) (B end)	1	28184973	<S>
A701	COVER	(B) (Not B end)	1	28184972Z	
A701	COVER	(S) (Not B end)	1	28184973Z	<S>
A702	TAPE	TAPE(CLOTH-8U)	1	29110082	
A703	LABEL	(CAUTION)	1	29363797	<S>
A703	LABEL	(CAUTION)	1	29364123	
A705	LABEL	HOOKUP-ONKYO	1	29363194	<B MDC>
A707	LABEL	(TMN)708	2	29391175	N <B MDF>
A709	LABEL	(CCC)	1	29364396	<B MMR>
A711	LABEL	(APV)	1	29390190	<B MMR>
A715	SCREW	3TTB+8B(3CM)SR	6	801637	<S>
A715	SCREW	3TTB+8B(3BC)	6	838430088GR	
TRANS COL					
T901	P TRANS	NPT-1594D	1	2301990	N <B MDC, MDF>
T901	P TRANS	NPT-1594M	1	2301991	N <B MIMA, MIMP, MIMQ, MIMR / SMMMP>
T901	P TRANS	NPT-1594J	1	2301992	N <B MUJ>
SW TRAI					
F2000	FUSE	4A-U/L/T-233	1	252325GR	
F2000 or	FUSE	4A-T/U-L-ST2	(1)	252257GR	
F2001	FUSE	2A-U/L/T-233	1	252320GR	
F2001 or	FUSE	2A-T/U-L-ST2	(1)	252253GR	
F6901	FUSE	15A-T/U-L-250V	1	252303GR	
F6901 or	FUSE	15A-U/L/T-314	(1)	252197GR	
F6902	FUSE	15A-T/U-L-250V	1	252303GR	
F6902 or	FUSE	15A-U/L/T-314	(1)	252197GR	
P901	FUSE	5A-SE-EAK FUSE	1	252078GR	<B MIMA, MIMP, MIMQ, MIMR / SMMMP>
P901	FUSE	10A-U/L-ST6N1	1	252382GR	<B MDC, MDF, MUJ>
P901 or	FUSE	5A-SE-TL250V	(1)	252278GR	<B MIMA, MIMP, MIMQ, MIMR / SMMMP>
P901E	LABEL	TSAL250V	1	29361938	<B MIMA, MIMP, MIMQ, MIMR / SMMMP>

P103	FFC	NCFC7-111012	1	2047111012	<B MDC, MDF, MMA, MMP, MMQ, MMR / S MMP>
P2100	FFC	NCFC7-210512	1	2047210512	<B MJU>
P2101	FFC	NCFC7-191012	1	2047191012	
P3101	SOCKET AS	NSAS-10P1813	1	2009991173UL	
P640	FAN	DD5X-12TL	1	24502317	
P6600A	P RIVET	JB-407A-C	22	880052	<B MDF, MMA, MMP, MMQ, MMR / S MMP>
P7501	SOCKET AS	NSAS-80P1804	1	2009991167UL	
P8002	FFC	NCFC3-110512	1	2045110512	
P8641	FFC	NCFC3-31008	1	204531008	
P900	AC INLET	R301X2P5a	1	25053358	<B MMA, MMP, MMQ, MMR / S MMP>
P900	AC INLET	R301X2P5a	1	25053359	<B MJU>
P9008	SOCKET AS	NSAS-3P1760	1	2009991127UL	
P9008	FASTON AS	FASTON/FASTON	1	IF9999026A	<B MJU, MMA, MMP, MMQ, MMR / S MMP>
P921	AC CORD	AS-CEE-3	1	253298VOL	<B MMP / S MMP>
P921	AC CORD	AS-CCC	1	253358VOL	<B MMR>
P921	AC CORD	AS-UJC-2	1	2533684YUN	<B MDC>
P921	AC CORD	AS-JA	1	25338KAW	<B MJU>
P921	AC CORD	AS-SAA	1	253391VOL	<B MMA>
P921	AC CORD	AS-BS	1	253425YUN	<B MMQ>
P921	AC CORD	AS-CNS	1	253429VOL	<B MDF>
P921 or P921B	AC CORD	AS-UJC-2	(1)	253368BLTK	<B MDC>
	POLY BAG	w250brd350	1	29100250A	<B MJU>
TUNER UNIT					
U001	U0010-U0016	BAAMP-0444-1A *	1	1B248544-1A	<B MDC, MDF>
U0010	AMP (FINAL STAGE) PC BOARD AS	BAAMP-0444-1B	1	1B2485444-1B	<B MJU, MMA, MMP, MMQ, MMR / S MMP>
U0011	VOLTAGE AMP PC BOARD AS	BACLA-0445-1A	1	1B2485445-1A	<B MDC, MDF>
U0012	AMP HOLD PC BOARD AS	BAETC-0446-1A	1	1B2485446-1A	<B MDC, MDF>
U0013	AMP HOLD PC BOARD AS	BAETC-0447-1A	1	1B2485447-1A	<B MDC, MDF>
U0014	THERMAL PCB BOARD AS	BAETC-0448-1A	1	1B2485448-1A	<B MDC, MDF>
U0015	THERMAL PCB HOLD PC BOARD AS	BAETC-0449-1A	1	1B2485449-1A	<B MDC, MDF>
U0016	HOLD FRONT HDMI CABLE PCB BOARD AS	BAETC-0455-1A	1	1B2485455-1A	<B MDC, MDF>
U001	U0010-U0016	BAAMP-0444-1B *	1	1B248544-1B	<B MJU, MMA, MMP, MMQ, MMR / S MMP>
U0010	AMP (FINAL STAGE) PC BOARD AS	BAAMP-0444-1B	1	1B2485444-1B	<B MJU, MMA, MMP, MMQ, MMR / S MMP>
U0011	VOLTAGE AMP PC BOARD AS	BACLA-0445-1B	1	1B2485445-1B	<B MJU, MMA, MMP, MMQ, MMR / S MMP>
U0012	AMP HOLD PC BOARD AS	BAETC-0446-1B	1	1B2485446-1B	<B MJU, MMA, MMP, MMQ, MMR / S MMP>
U0013	AMP HOLD PC BOARD AS	BAETC-0447-1B	1	1B2485447-1B	<B MJU, MMA, MMP, MMQ, MMR / S MMP>
U0014	THERMAL PCB BOARD AS	BAETC-0448-1B	1	1B2485448-1B	<B MJU, MMA, MMP, MMQ, MMR / S MMP>
U0015	THERMAL PCB HOLD PC BOARD AS	BAETC-0449-1B	1	1B2485449-1B	<B MJU, MMA, MMP, MMQ, MMR / S MMP>
U0016	HOLD FRONT HDMI CABLE PCB BOARD AS	BAETC-0455-1B	1	1B2485455-1B	<B MJU, MMA, MMP, MMQ, MMR / S MMP>
U003	U0030-U0033	BATRM-0450-1A *	1	1B248550-1A	<B MDC, MDF, MJU>
U0030	SPEAKER TERMINAL_1 PC BOARD AS	BATRM-0450-1A	1	1B2485450-1A	<B MDC, MDF, MJU>
U0031	SPEAKER TERMINAL_2 PC BOARD AS	BATRM-0451-1A	1	1B2485451-1A	<B MDC, MDF, MJU>
U0032	SPEAKER TERMINAL_3 PC BOARD AS	BATRM-0452-1A	1	1B2485452-1A	<B MDC, MDF, MJU>
U0034	POWER SUPPLY PC BOARD AS	BAPS-0454-1A	1	1B2485454-1A	<B MDC, MDF, MJU>
U003	U0030-U0033	BATRM-0450-1B *	1	1B248550-1B	<B MMA, MMP, MMQ, MMR / S MMP>
U0030	SPEAKER TERMINAL_1 PC BOARD AS	BATRM-0450-1B	1	1B2485450-1B	<B MMA, MMP, MMQ, MMR / S MMP>
U0031	SPEAKER TERMINAL_2 PC BOARD AS	BATRM-0451-1B	1	1B2485451-1B	<B MMA, MMP, MMQ, MMR / S MMP>

REF. NO.	PART NAME	DESCRIPTION	QTY	PART NO. (SN)	REMARKS
U0032	SPEAKER TERMINAL_3 PC BOARD AS	B ATRM-0452-1B	1	1B 2485452-1B	N <B MMA, MMP, MMQ, MMR / S MMP>
U0034	POWER SUPPLY PC BOARD AS	BAPS-0454-1B	1	1B 2485454-1B	N <B MMA, MMP, MMQ, MMR / S MMP>
U0040	U0040-U0041	B AASP-0458-1A *	1	1B 248558-1A	N <B MDC, MDF, MMA, MMP, MMQ, MMR / S MMP>
U0040	ANALOG AUDIO PC BOARD AS	B AASP-0458-1A	1	1B 2485458-1A	N <B MDC, MDF, MMA, MMP, MMQ, MMR / S MMP>
U0041	D-SUB TERMINAL PC BOARD AS	BAETC-0459-1A	1	1B 2485459-1A	N <B MDC, MDF, MMA, MMP, MMQ, MMR / S MMP>
U0040	U0040-U0041	B AASP-0458-1B *	1	1B 248558-1B	N <B MLI>
U0040	ANALOG AUDIO PC BOARD AS	B AASP-0458-1B	1	1B 2485458-1B	N <B MLI>
U0041	D-SUB TERMINAL PC BOARD AS	BAETC-0459-1B	1	1B 2485459-1B	N <B MLI>
U005	U0050-U0054	B ADG-0462-1A *	1	1B 248562-1A	N <B MDC, MDF>
U0050	DAC PC BOARD AS	B ADG-0462-1A	1	1B 2485462-1A	N <B MDC, MDF>
U0051	CPU PC BOARD AS	B ACPU-0463-1A	1	1B 2485463-1A	N <B MDC, MDF>
U0052	ANALOG VIDEO PC BOARD AS	B AVD-0464-1A	1	1B 2485464-1A	N <B MDC, MDF>
U0054	UNIVERSAL PORT PC BOARD AS	BAETC-0466-1A	1	1B 2485466-1A	N <B MDC, MDF>
U0055	FRONT USB PC BOARD AS	B ADG-0468-1A	1	1B 2485468-1A	N <B MDC, MDF>
U005	U0050-U0054	B ADG-0462-1B *	1	1B 248562-1B	N <B MMA, MMP, MMQ, MMR / S MMP>
U0050	DAC PC BOARD AS	B ADG-0462-1B	1	1B 2485462-1B	N <B MMA, MMP, MMQ, MMR / S MMP>
U0051	CPU PC BOARD AS	B ACPU-0463-1B	1	1B 2485463-1B	N <B MMA, MMP, MMQ, MMR / S MMP>
U0052	ANALOG VIDEO PC BOARD AS	B AVD-0464-1B	1	1B 2485464-1B	N <B MMA, MMP, MMQ, MMR / S MMP>
U0054	UNIVERSAL PORT PC BOARD AS	BAETC-0466-1B	1	1B 2485466-1B	N <B MMA, MMP, MMQ, MMR / S MMP>
U0055	FRONT USB PC BOARD AS	B ADG-0468-1B	1	1B 2485468-1B	N <B MMA, MMP, MMQ, MMR / S MMP>
U005	U0050-U0055	B ADG-0462-1C *	1	1B 248562-1C	N <B MLI>
U0050	DAC PC BOARD AS	B ADG-0462-1C	1	1B 2485462-1C	N <B MLI>
U0051	CPU PC BOARD AS	B ACPU-0463-1C	1	1B 2485463-1C	N <B MLI>
U0052	ANALOG VIDEO PC BOARD AS	B AVD-0464-1C	1	1B 2485464-1C	N <B MLI>
U0053	D TERMINAL PC BOARD AS	B AVD-0465-1C	1	1B 2485465-1C	N <B MLI>
U0054	UNIVERSAL PORT PC BOARD AS	BAETC-0466-1C	1	1B 2485466-1C	N <B MLI>
U0055	FRONT USB PC BOARD AS	B ADG-0468-1C	1	1B 2485468-1C	N <B MLI>
U006	U0060-U0067	B ADIS-0110-1F *	1	1B 234510-1F	N
U0060	DISPLAY PC BOARD AS	B ADIS-0110-1F	1	1B 234510-1F	N
U0061	DISPLAY SW PC BOARD AS	B ASW-0111-1F	1	1B 234511-1F	N
U0062	FL POWER SUPPLY PC BOARD AS	B APS-0112-1F	1	1B 234512-1F	N
U0063	HEADPHONE TERMINAL PC BOARD AS	BAETC-0113-1F	1	1B 234513-1F	N
U0064	HOLD IDE CABLE PARTI PC BOARD AS	BAETC-0114-1F	1	1B 234514-1F	N
U0065	VOLUME LED PC BOARD AS	BAETC-0116-1F	1	1B 234516-1F	N
U0066	HOLD IDE CABLE PART2 PC BOARD AS	BAETC-0117-1F	1	1B 234517-1F	N
U0067	HOLD FRONT HDMI TERMINAL PC BOARD AS	BAETC-0118-1F	1	1B 234518-1F	N
U007	HDMI PC BOARD AS	BAHDM-0471-1A	1	1B 248571-1A	N
U0080	FRONT HDMI TERMINAL PC BOARD AS	BAHDM-0290-1A	1	1B 234590-1A	N
U011	TUNER UNIT	FAEH06-ED1EX	1	240165	<B MMA, MMP, MMQ, MMR / S MMP>
U011	TUNER UNIT	FAEH06-A01US	1	240166	<B MDC, MDF>

PACKING PROCEDURES PARTS LIST

PACKING

TX-NR708

A771	LABEL	(WIN7)	1	29391024	
A751	PAD	ASTXSRT707	1	290924624	
A755	SHEET	(PAD)	1	290960654	
A781	SHEET	1300*650	1	29095966	
A789	TAPE	(SER:OHAND)NITTO NO.29	1	29110149	
A791	POLY BAG	w250x4350	1	291000504	<B MDC, MDF>
A793	TAPE	(SER:OHAND)NITTO NO.29	1	29110149	<B MDC, MDF>
A793	PP TAPE	W/50 SBT-70	1	29110200	
A801	CARTON	TXNR708MDC	1	290551388	N <B MDC, MDF>
A801	CARTON	TXNR708M	1	290551398	N <B MMA, MNP, MMQ, MNR / S MNP>
A801	CARTON	TXNA708MJJ	1	290551408	N <B MJJ>
A809	LABEL	(CHINA)	1	29390952	<B MNR>
A811A	UPCLABEL	TXNR708BMD	1	29391193	N <B MDC>
A811A	EAN LABEL	TXNR708BMD	1	29391200	N <B MDF>
A811A	EAN LABEL	TXNR708BMMR	1	29391201	N <B MNR>
A811A	EAN LABEL	TXNR708BMMMA	1	29391202	N <B MMA>
A811A	EAN LABEL	TXNR708BMMQ	1	29391203	N <B MMQ>
A811A	EAN LABEL	TXNR708BMMMP	1	293911984	N <B MNP>
A811A	EAN LABEL	TXNR708BMMMP	1	293911994	N <S MNP>
A815A	JAN LABEL	TXNA708B MJJ	1	29391206	N <B MJJ>
NECESSARY					
A1000	INS MANUAL	EM(TX-NR708)	1	29400317	N <B MDC, MDF, MMA, MNP, MMQ, MNR / S MNP>
A1001	INS MANUAL	U2FE(TX-NR708)	1	29400318	N <B MDC, MNP / S MNP>
A1002	INS MANUAL	U2HD(TX-NR708)	1	29400319	N <B MNP / S MNP>
A1003	INS MANUAL	U2MS(TX-NR708)	1	29400320	N <B MNP / S MNP>
A1004	INS MANUAL	C&T(TX-NR708)	1	29400321	N <B MDF, MMQ>
A1005	INS MANUAL	C&T(TX-NR708)	1	29400322	<B MNR>
A1006	INS MANUAL	J&T(TX-NA708)	1	29400323	N <B MJJ>
A1007	INS MANUAL	AT(TX-NR708)	1	29400324	N <B MMQ>
A1009	INS MANUAL	EQSS(TX-NR708)	1	29400326	N <B MDC, MDF, MMA, MNP, MMQ, MNR / S MNP>
A1010	INS MANUAL	C&QSS(TX-NR708)	1	29400327	<B MNR>
A1011	INS MANUAL	J&QSS(TX-NA708)	1	29400328	N <B MJJ>
A1020	INS MANUAL	U2EFT(SIRUS_2010M4)	1	29400327	<B MDC>
A1100	INS MANUAL	US(2010-Prepro)	1	29400269	<B MDC, MDF, MMA, MNP, MMQ, MNR / S MNP>
A1101	HANDB LL	(UP-A1)US	1	29380155A	<B MDC>
A1101	HANDB LL	(UP-A1)EU	1	29380156A	<B MNP / S MNP>
A1102	HANDB LL	(SIRUS)	1	29380149	<B MDC>
A1103	INST SHEET	CH(CHUSI,MDP)	1	29355781	<B MDF>
A1104	INST SHEET	U1(2010 RHD)	1	29355782	
A1108	INS MANUAL	U2EAD(east_fm_708-5008)	1	29400365	<B MNP / S MNP>
A1109	INS MANUAL	U2AEM(SV_Lice_708-5008)	1	29400366	
A1110	INS MANUAL	U2EAF(Te(InteraRadio_ONK)	1	29400367	<B MDC>
A1112	INS MANUAL	ATQC (ImoportantSheet)	1	29344373A	<B MMQ>
A1113	INST SHEET	U1(2010M/H_A.P.D)	1	29355790	
A1114	INST SHEET	EMFW_Update_2010M_ONK	1	29355794	<B MDC, MDF, MMA, MNP, MMQ, MNR / S MNP>
A1115	INST SHEET	U2FE(TW_Update_2010M_ONK)	1	29355795	<B MDC, MNP / S MNP>
A1116	INST SHEET	U4(FW_Update_2010M_ONK)	1	29355796	<B MNP / S MNP>

A1117	INST SHEET	ChFW_Update_2010M_ONK	1	2935797	<B MDP,MMO>
A1118	INST SHEET	C&FW_Update_2010M_ONK	1	2935798	<B MMNR>
A1119	INST SHEET	J&FW_Update_2010M_ONK	1	2935799	<B MLI>
A851	POLY BAG	D250x300xW300(0.04)	1	291002564	
A855	TAPE	(SER OHANNITTONO.29	1	29110149	
A861	LABEL	(SPCABLE)2009	1	29300881	
A863	INST SHEET	WEEE	1	2935793	<B MMF /S MDP>
A865	INST SHEET	CHINA ROHS	1	29356164	<B MMNR>
A867	DIRECTORY		1	2938032C	<B MLI>
A869	QUST SHEET	JJ	1	29370045D	<B MLI>
A881	WRNTY CARD	(ONKY O)	1	29365135	<B MDC>
A881	WRNTY CARD	AS	1	29365082F	<B MLI>
A881	WRNTY CARD	(ONKY O-CH)	1	29365098B	<B MMNR>
A881	WRNTY CARD	MGQ	1	29365099A	<B MMO>
A990	REMO CON	R-C-768M	1	24140768	N <EXCEPT MLI>
A990	REMO CON	R-C-769M	1	24140769	<B MLI>
A991	BATTERY	R6/AA(UM-3)	2	3010194	
A991 or	BATTERY	R6/AA(UM-3)	(2)	3010054	
A992	MIC	MIC-7000	1	245044	
A993	ANT COLL	NMA-3057	1	232140	
A994	FM ANT AS	Type W	1	292191	
A995	CAP	(AUX)(B)	1	28330196	N <B MMF>
A995	CAP	(AUX)(S)	1	28330197	N <S MMF>

PC BOARD PARTS LIST

TX-NR708

U001	U0010~U0016	BAAMP-0444-1A "	1	1B248544-1A	N <B MDC, MDP>
U0010	AMP (FINAL STAGE) PC BOARD AS	BAAMP-0444-1A	1	1B2485444-1A	N <B MDC, MDP>
U0011	VOL TA GE AMP PC BOARD AS	BACLA-0445-1A	1	1B2485445-1A	N <B MDC, MDP>
U0012	AMP HOLD PC BOARD AS	BAETC-0446-1A	1	1B2485446-1A	N <B MDC, MDP>
U0013	AMP HOLD PC BOARD AS	BAETC-0447-1A	1	1B2485447-1A	N <B MDC, MDP>
U0014	THERMAL PCB BOARD AS	BAETC-0448-1A	1	1B2485448-1A	N <B MDC, MDP>
U0015	THERMAL PCB HOLD PC BOARD AS	BAETC-0449-1A	1	1B2485449-1A	N <B MDC, MDP>
U0016	HOLD FRONT HDMI CABLE PC BOARD AS	BAETC-0455-1A	1	1B2485455-1A	N <B MDC, MDP>
U001	U0010~U0016	BAAMP-0444-1B "	1	1B248544-1B	<B MLI, MVA, MMF, MMO, MMNR /S MMF>
U0010	AMP (FINAL STAGE) PC BOARD AS	BAAMP-0444-1B	1	1B2485444-1B	<B MLI, MVA, MMF, MMO, MMNR /S MMF>
U0011	VOL TA GE AMP PC BOARD AS	BACLA-0445-1B	1	1B2485445-1B	N <B MLI, MVA, MMF, MMO, MMNR /S MMF>
U0012	AMP HOLD PC BOARD AS	BAETC-0446-1B	1	1B2485446-1B	N <B MLI, MVA, MMF, MMO, MMNR /S MMF>
U0013	AMP HOLD PC BOARD AS	BAETC-0447-1B	1	1B2485447-1B	N <B MLI, MVA, MMF, MMO, MMNR /S MMF>
U0014	THERMAL PCB BOARD AS	BAETC-0448-1B	1	1B2485448-1B	N <B MLI, MVA, MMF, MMO, MMNR /S MMF>
U0015	THERMAL PCB HOLD PC BOARD AS	BAETC-0449-1B	1	1B2485449-1B	N <B MLI, MVA, MMF, MMO, MMNR /S MMF>
U0016	HOLD FRONT HDMI CABLE PC BOARD AS	BAETC-0455-1B	1	1B2485455-1B	N <B MLI, MVA, MMF, MMO, MMNR /S MMF>

CIRCUIT NO.	PART NAME	DESCRIPTION	QTY	PART NO. (SN)	REMARKS
JERAM CONDUCTOR					

D5000	ZENER D	MTZJ5 6B	1	224470562T
D5001	ZENER D	MTZJ5 6B	1	224470562T
D5002	ZENER D	MTZJ5 6B	1	224470562T
D5003	ZENER D	MTZJ5 6B	1	224470562T
D5004	ZENER D	MTZJ5 6B	1	224470562T
D5005	ZENER D	MTZJ5 6B	1	224470562T
D5006	ZENER D	MTZJ5 6B	1	224470562T
D6000	DIODE	ISS133	1	223163T
D6001	DIODE	ISS133	1	223163T
D6002	DIODE	ISS133	1	223163T
D6003	DIODE	ISS133	1	223163T
D6004	DIODE	ISS133	1	223163T
D6005	DIODE	ISS133	1	223163T
D6006	DIODE	ISS133	1	223163T
D6701	C-DIODE	ISS352	1	223234R2
D6701 or	C-DIODE	ISS355	(1)	223269R2
D6701 or	C-DIODE	KDS4148U	(1)	223283R2
D6701 or	C-DIODE	MA2J110GL	(1)	223302R2
D6702	C-DIODE	ISS352	1	223234R2
D6702 or	C-DIODE	ISS355	(1)	223269R2
D6702 or	C-DIODE	KDS4148U	(1)	223283R2
D6702 or	C-DIODE	MA2J110GL	(1)	223302R2
D6703	ZENER D	UDZS3 6B	1	224550360R2
D6704	ZENER D	UDZS3 6B	1	224550360R2
D6713	DIODE	D10XB 60H	1	22380337
D6901A	HEAT SINK	RAD-257	1	27160651
D6901C	SCREW	3P+10FN(3BC)	1	82143010GR
D6902	C-DIODE	ISS352	1	223234R2
D6902 or	C-DIODE	ISS355	(1)	223269R2
D6902 or	C-DIODE	KDS4148U	(1)	223283R2
D6902 or	C-DIODE	MA2J110GL	(1)	223302R2
D6903	DIODE	RLJN4003	1	22380260T
D6904	DIODE	RLJN4003	1	22380260T
Q5000	TR	ZSC2240-BL(TPE2 F)	1	2211406T
Q5001	TR	ZSC2240-BL(TPE2 F)	1	2211406T
Q5002	TR	ZSC2240-BL(TPE2 F)	1	2211406T
Q5003	TR	ZSC2240-BL(TPE2 F)	1	2211406T
Q5004	TR	ZSC2240-BL(TPE2 F)	1	2211406T
Q5005	TR	ZSC2240-BL(TPE2 F)	1	2211406T
Q5006	TR	ZSC2240-BL(TPE2 F)	1	2211406T
Q5010	TR	ZSC2240-BL(TPE2 F)	1	2211406T
Q5011	TR	ZSC2240-BL(TPE2 F)	1	2211406T
Q5012	TR	ZSC2240-BL(TPE2 F)	1	2211406T
Q5013	TR	ZSC2240-BL(TPE2 F)	1	2211406T
Q5014	TR	ZSC2240-BL(TPE2 F)	1	2211406T
Q5015	TR	ZSC2240-BL(TPE2 F)	1	2211406T

Q5016	TR		2SC2240-BL(TPE2_F)	1	2211406T
Q5030	TR		2SA049-Y(TPE6_F)	1	2211354T
Q5030A	RETAINER		(CLA2)	1	27142140
Q5031	TR		2SA049-Y(TPE6_F)	1	2211354T
Q5031A	RETAINER		(CLA2)	1	27142140
Q5032	TR		2SA049-Y(TPE6_F)	1	2211354T
Q5032A	RETAINER		(CLA2)	1	27142140
Q5033	TR		2SA049-Y(TPE6_F)	1	2211354T
Q5033A	RETAINER		(CLA2)	1	27142140
Q5034	TR		2SA049-Y(TPE6_F)	1	2211354T
Q5034A	RETAINER		(CLA2)	1	27142140
Q5035	TR		2SA049-Y(TPE6_F)	1	2211354T
Q5035A	RETAINER		(CLA2)	1	27142140
Q5036	TR		2SA049-Y(TPE6_F)	1	2211354T
Q5036A	RETAINER		(CLA2)	1	27142140
Q5040	TR		2SA049-Y(TPE6_F)	1	2211354T
Q5041	TR		2SA049-Y(TPE6_F)	1	2211354T
Q5042	TR		2SA049-Y(TPE6_F)	1	2211354T
Q5043	TR		2SA049-Y(TPE6_F)	1	2211354T
Q5044	TR		2SA049-Y(TPE6_F)	1	2211354T
Q5045	TR		2SA049-Y(TPE6_F)	1	2211354T
Q5046	TR		2SA049-Y(TPE6_F)	1	2211354T
Q5050	TR		2SC2240-BL(TPE2_F)	1	2211406T
Q5051	TR		2SC2240-BL(TPE2_F)	1	2211406T
Q5052	TR		2SC2240-BL(TPE2_F)	1	2211406T
Q5053	TR		2SC2240-BL(TPE2_F)	1	2211406T
Q5054	TR		2SC2240-BL(TPE2_F)	1	2211406T
Q5055	TR		2SC2240-BL(TPE2_F)	1	2211406T
Q5056	TR		2SC2240-BL(TPE2_F)	1	2211406T
Q5060	TR		2SA049-Y(TPE6_F)	1	2211354T
Q5061	TR		2SA049-Y(TPE6_F)	1	2211354T
Q5062	TR		2SA049-Y(TPE6_F)	1	2211354T
Q5063	TR		2SA049-Y(TPE6_F)	1	2211354T
Q5064	TR		2SA049-Y(TPE6_F)	1	2211354T
Q5065	TR		2SA049-Y(TPE6_F)	1	2211354T
Q5066	TR		2SA049-Y(TPE6_F)	1	2211354T
Q5070	TR		2SC2229-Y(TPE6_F)	1	2211634T
Q5071	TR		2SC2229-Y(TPE6_F)	1	2211634T
Q5072	TR		2SC2229-Y(TPE6_F)	1	2211634T
Q5073	TR		2SC2229-Y(TPE6_F)	1	2211634T
Q5074	TR		2SC2229-Y(TPE6_F)	1	2211634T
Q5075	TR		2SC2229-Y(TPE6_F)	1	2211634T
Q5076	TR		2SC2229-Y(TPE6_F)	1	2211634T
Q5250	TR		2SA1930(ONK_Q)	1	2203000
Q5251	TR		2SA1930(ONK_Q)	1	2203000
Q5252	TR		2SA1930(ONK_Q)	1	2203000
Q5253	TR		2SA1930(ONK_Q)	1	2203000

Q5254	TR				2SA1930(ONK_Q)	1	2203000
Q5255	TR				2SA1930(ONK_Q)	1	2203000
Q5256	TR				2SA1930(ONK_Q)	1	2203000
Q5260	TR				2SC5171(ONK_Q)	1	2203010
Q5261	TR				2SC5171(ONK_Q)	1	2203010
Q5262	TR				2SC5171(ONK_Q)	1	2203010
Q5263	TR				2SC5171(ONK_Q)	1	2203010
Q5264	TR				2SC5171(ONK_Q)	1	2203010
Q5265	TR				2SC5171(ONK_Q)	1	2203010
Q5266	TR				2SC5171(ONK_Q)	1	2203010
Q5410	TR				2SC2412K-R	1	2214653R2
Q5411	TR				2SC2412K-R	1	2214653R2
Q5412	TR				2SC2412K-R	1	2214653R2
Q5413	TR				2SC2412K-R	1	2214653R2
Q5414	TR				2SC2412K-R	1	2214653R2
Q5415	TR				2SC2412K-R	1	2214653R2
Q5416	TR				2SC2412K-R	1	2214653R2
Q5430	TR				2SC2229-Y(TPE6_F)	1	2211634T
Q5430 or	TR				2SC2229-Q(TPE6_F)	(1)	2211633T
Q5431	TR				2SC2229-Y(TPE6_F)	1	2211634T
Q5431 or	TR				2SC2229-Q(TPE6_F)	(1)	2211633T
Q5432	TR				2SC2229-Y(TPE6_F)	1	2211634T
Q5432 or	TR				2SC2229-Q(TPE6_F)	(1)	2211633T
Q5433	TR				2SC2229-Y(TPE6_F)	1	2211634T
Q5433 or	TR				2SC2229-Q(TPE6_F)	(1)	2211633T
Q5434	TR				2SC2229-Y(TPE6_F)	1	2211634T
Q5434 or	TR				2SC2229-Q(TPE6_F)	(1)	2211633T
Q5435	TR				2SC2229-Y(TPE6_F)	1	2211634T
Q5435 or	TR				2SC2229-Q(TPE6_F)	(1)	2211633T
Q5436	TR				2SC2229-Y(TPE6_F)	1	2211634T
Q5436 or	TR				2SC2229-Q(TPE6_F)	(1)	2211633T
Q5440	TR				2SA049-Q(TPE6_F)	1	2211353T
Q5440 or	TR				2SA049-Y(TPE6_F)	(1)	2211354T
Q5441	TR				2SA049-Q(TPE6_F)	1	2211353T
Q5441 or	TR				2SA049-Y(TPE6_F)	(1)	2211354T
Q5442	TR				2SA049-Q(TPE6_F)	1	2211353T
Q5442 or	TR				2SA049-Y(TPE6_F)	(1)	2211354T
Q5443	TR				2SA049-Q(TPE6_F)	1	2211353T
Q5443 or	TR				2SA049-Y(TPE6_F)	(1)	2211354T
Q5444	TR				2SA049-Q(TPE6_F)	1	2211353T
Q5444 or	TR				2SA049-Y(TPE6_F)	(1)	2211354T
Q5445	TR				2SA049-Q(TPE6_F)	1	2211353T
Q5445 or	TR				2SA049-Y(TPE6_F)	(1)	2211354T
Q5446	TR				2SA049-Q(TPE6_F)	1	2211353T
Q5446 or	TR				2SA049-Y(TPE6_F)	(1)	2211354T
Q6000	TR				2SC2412K-R	1	2214653R2
Q6001	TR				2SC2412K-R	1	2214653R2

Q6002	TR		2SC2412K-R	1	2214653R2
Q6003	TR		2SC2412K-R	1	2214653R2
Q6004	TR		2SC2412K-R	1	2214653R2
Q6005	TR		2SC2412K-R	1	2214653R2
Q6006	TR		2SC2412K-R	1	2214653R2
Q6070	TR		2SC2229-Y(TPE6_F)	1	2211634T
Q6071	TR		2SC2229-Y(TPE6_F)	1	2211634T
Q6072	TR		2SC2229-Y(TPE6_F)	1	2211634T
Q6073	TR		2SC2229-Y(TPE6_F)	1	2211634T
Q6074	TR		2SC2229-Y(TPE6_F)	1	2211634T
Q6075	TR		2SC2229-Y(TPE6_F)	1	2211634T
Q6076	TR		2SC2229-Y(TPE6_F)	1	2211634T
Q6380	IC		LM6102Z	1	22242212
Q6380A	RETAINER		(PTH)	1	22141884-1
Q6502	TR		2SA090-Y	1	2211504T
Q6503	TR		2SC1815-GR	1	2211255T
Q6701	TR		2SC2712-GR	1	2213145R2
Q6702	TR		2SC2712-GR	1	2213145R2
Q6703	TR		2SA1163-BL(TE85L_F)	1	2216756R2
Q6707	TR		2SC2712-GR	1	2213145R2
Q6713	TR		2SA1163-BL(TE85L_F)	1	2216756R2
TRANS COIL					
L5400	FR CORE	*		1	5597-45502
L5401	FR CORE	*		1	5597-45502
L5402	FR CORE	*		1	5597-45502
L5403	FR CORE	*		1	5597-45502
L5404	FR CORE	*		1	5597-45502
L5405	FR CORE	*		1	5597-45502
L5406	FR CORE	*		1	5597-45502
L5410	FR CORE	*		1	5597-45502
L5411	FR CORE	*		1	5597-45502
L5412	FR CORE	*		1	5597-45502
L5413	FR CORE	*		1	5597-45502
L5414	FR CORE	*		1	5597-45502
L5415	FR CORE	*		1	5597-45502
L5416	FR CORE	*		1	5597-45502
L6600	S-COIL		SC-0-8X5 5X18 5T	1	231431S
L6601	S-COIL		SC-0-8X5 5X18 5T	1	231431S
L6602	S-COIL		SC-0-8X5 5X18 5T	1	231431S
L6603	S-COIL		SC-0-8X5 5X18 5T	1	231431S
L6604	S-COIL		SC-0-8X5 5X18 5T	1	231431S
L6605	S-COIL		SC-0-8X5 5X18 5T	1	231431S
L6606	S-COIL		SC-0-8X5 5X18 5T	1	231431S
CAPACITOR					
C3000	UPZ C		2AUPZTF101JE	1	376331014T
C5001	UPZ C		2AUPZTF101JE	1	376331014T
C5002	UPZ C		2AUPZTF101JE	1	376331014T

C5003	UPZ C	2AUPZ.TF101JE	1	376331014T
C5004	UPZ C	2AUPZ.TF101JE	1	376331014T
C5005	UPZ C	2AUPZ.TF101JE	1	376331014T
C5006	UPZ C	2AUPZ.TF101JE	1	376331014T
C5010	UTSP C	CE04W50V 47M(UTSP)	1	397584707T
C5011	UTSP C	CE04W50V 47M(UTSP)	1	397584707T
C5012	UTSP C	CE04W50V 47M(UTSP)	1	397584707T
C5013	UTSP C	CE04W50V 47M(UTSP)	1	397584707T
C5014	UTSP C	CE04W50V 47M(UTSP)	1	397584707T
C5015	UTSP C	CE04W50V 47M(UTSP)	1	397584707T
C5016	UTSP C	CE04W50V 47M(UTSP)	1	397584707T
C5020	UTSP C	CE04W50V 47M(UTSP)	1	397581007T
C5021	UTSP C	CE04W50V 47M(UTSP)	1	397581007T
C5022	UTSP C	CE04W50V 47M(UTSP)	1	397581007T
C5023	UTSP C	CE04W50V 47M(UTSP)	1	397581007T
C5024	UTSP C	CE04W50V 47M(UTSP)	1	397581007T
C5025	UTSP C	CE04W50V 47M(UTSP)	1	397581007T
C5026	UTSP C	CE04W50V 47M(UTSP)	1	397581007T
C5040	UTSP C	CE04W10V 470M(UTSP)	1	397534717T
C5041	UTSP C	CE04W10V 470M(UTSP)	1	397534717T
C5042	UTSP C	CE04W10V 470M(UTSP)	1	397534717T
C5043	UTSP C	CE04W10V 470M(UTSP)	1	397534717T
C5044	UTSP C	CE04W10V 470M(UTSP)	1	397534717T
C5045	UTSP C	CE04W10V 470M(UTSP)	1	397534717T
C5046	UTSP C	CE04W10V 470M(UTSP)	1	397534717T
C5050	UTSP C	CE04W50V 47M(UTSP)	1	397584707T
C5051	UTSP C	CE04W50V 47M(UTSP)	1	397584707T
C5052	UTSP C	CE04W50V 47M(UTSP)	1	397584707T
C5053	UTSP C	CE04W50V 47M(UTSP)	1	397584707T
C5054	UTSP C	CE04W50V 47M(UTSP)	1	397584707T
C5055	UTSP C	CE04W50V 47M(UTSP)	1	397584707T
C5056	UTSP C	CE04W50V 47M(UTSP)	1	397584707T
C5080	CERA C	CC4SLS50V 490C	1	345020401T
C5081	CERA C	CC4SLS50V 490C	1	345020401T
C5082	CERA C	CC4SLS50V 490C	1	345020401T
C5083	CERA C	CC4SLS50V 490C	1	345020401T
C5084	CERA C	CC4SLS50V 490C	1	345020401T
C5085	CERA C	CC4SLS50V 490C	1	345020401T
C5086	CERA C	CC4SLS50V 490C	1	345020401T
C5090	UPZ C	2AUPZ.TF101JE	1	376331014T
C5091	UPZ C	2AUPZ.TF101JE	1	376331014T
C5092	UPZ C	2AUPZ.TF101JE	1	376331014T
C5093	UPZ C	2AUPZ.TF101JE	1	376331014T
C5094	UPZ C	2AUPZ.TF101JE	1	376331014T
C5095	UPZ C	2AUPZ.TF101JE	1	376331014T
C5096	UPZ C	2AUPZ.TF101JE	1	376331014T
C5100	VR C	CE04W100V 22M(VR)	1	394692207T

C5101	VR C	CE04W100V-22M(VR)	1	394692207T
C5102	VR C	CE04W100V-22M(VR)	1	394692207T
C5103	VR C	CE04W100V-22M(VR)	1	394692207T
C5104	VR C	CE04W100V-22M(VR)	1	394692207T
C5105	VR C	CE04W100V-22M(VR)	1	394692207T
C5106	VR C	CE04W100V-22M(VR)	1	394692207T
C5110	VR C	CE04W100V-22M(VR)	1	394692207T
C5111	VR C	CE04W100V-22M(VR)	1	394692207T
C5112	VR C	CE04W100V-22M(VR)	1	394692207T
C5113	VR C	CE04W100V-22M(VR)	1	394692207T
C5114	VR C	CE04W100V-22M(VR)	1	394692207T
C5115	VR C	CE04W100V-22M(VR)	1	394692207T
C5116	VR C	CE04W100V-22M(VR)	1	394692207T
C5440	UTSP C	CE04W50V-22M(UTSP)	1	397582207T
C5441	UTSP C	CE04W50V-22M(UTSP)	1	397582207T
C5442	UTSP C	CE04W50V-22M(UTSP)	1	397582207T
C5443	UTSP C	CE04W50V-22M(UTSP)	1	397582207T
C5444	UTSP C	CE04W50V-22M(UTSP)	1	397582207T
C5445	UTSP C	CE04W50V-22M(UTSP)	1	397582207T
C5446	UTSP C	CE04W50V-22M(UTSP)	1	397582207T
C6050	TF C	EQQ-V50V-104J	1	374721044T
C6051	TF C	EQQ-V50V-104J	1	374721044T
C6052	TF C	EQQ-V50V-104J	1	374721044T
C6053	TF C	EQQ-V50V-104J	1	374721044T
C6054	TF C	EQQ-V50V-104J	1	374721044T
C6055	TF C	EQQ-V50V-104J	1	374721044T
C6056	TF C	EQQ-V50V-104J	1	374721044T
C6502	UTSP C	CE04W25V-22M(UTSP)	1	397552217T
C6630	TF C	EQQ-V50V-473J	1	374724734T
C6631	TF C	EQQ-V50V-473J	1	374724734T
C6632	TF C	EQQ-V50V-473J	1	374724734T
C6633	TF C	EQQ-V50V-473J	1	374724734T
C6634	TF C	EQQ-V50V-473J	1	374724734T
C6635	TF C	EQQ-V50V-473J	1	374724734T
C6636	TF C	EQQ-V50V-473J	1	374724734T
C6701	UTSP C	CE04W100V-22M(UTSP)	1	397532217T
C6703	C-CERA C	CK725F1E-104Z1	1	332161040R1
C6704	UTSP C	CE04W50V-11M(UTSP)	1	397580107T
C6706	UTSP C	CE04W25V-47M(UTSP)	1	397554707T
C6710	C-CERA C	CK725F1A-105Z1	1	332181050R1
C6713	C-CERA C	CK725F1E-104Z1	1	332161040R1
C6714	UTSP C	CE04W50V-2-2M(UTSP)	1	397580227T
C6901	ELECT C	CE69W69V-12000M	1	3504472
C6902	ELECT C	CE69W69V-12000M	1	3504472
C6911	C-CERA C	CC725CH1H-102J1	1	342101024R1
C6912	TF C	EQQ-V100V-334J	1	374733344T
C6913	TF C	EQQ-V100V-334J	1	374733344T

CDR14	UTSP C	CDPW50Y-20M(UTSP)		
REBETOR1				
R5000	CARB ONR	R16L-15K	1	417341524T
R5001	CARB ONR	R16L-15K	1	417341524T
R5002	CARB ONR	R16L-15K	1	417341524T
R5003	CARB ONR	R16L-15K	1	417341524T
R5004	CARB ONR	R16L-15K	1	417341524T
R5005	CARB ONR	R16L-15K	1	417341524T
R5006	CARB ONR	R16L-15K	1	417341524T
R5010	CARB ONR	R16L-33K	1	417343334T
R5011	CARB ONR	R16L-33K	1	417343334T
R5012	CARB ONR	R16L-33K	1	417343334T
R5013	CARB ONR	R16L-33K	1	417343334T
R5014	CARB ONR	R16L-33K	1	417343334T
R5015	CARB ONR	R16L-33K	1	417343334T
R5016	CARB ONR	R16L-33K	1	417343334T
R5020	CARB ONR	R16L-330	1	417343314T
R5021	CARB ONR	R16L-330	1	417343314T
R5022	CARB ONR	R16L-330	1	417343314T
R5023	CARB ONR	R16L-330	1	417343314T
R5024	CARB ONR	R16L-330	1	417343314T
R5025	CARB ONR	R16L-330	1	417343314T
R5026	CARB ONR	R16L-330	1	417343314T
R5030	CARB ONR	R16L-33K	1	417343334T
R5031	CARB ONR	R16L-33K	1	417343334T
R5032	CARB ONR	R16L-33K	1	417343334T
R5033	CARB ONR	R16L-33K	1	417343334T
R5034	CARB ONR	R16L-33K	1	417343334T
R5035	CARB ONR	R16L-33K	1	417343334T
R5036	CARB ONR	R16L-33K	1	417343334T
R5040	CARB ONR	R16L-1K	1	417341024T
R5041	CARB ONR	R16L-1K	1	417341024T
R5042	CARB ONR	R16L-1K	1	417341024T
R5043	CARB ONR	R16L-1K	1	417341024T
R5044	CARB ONR	R16L-1K	1	417341024T
R5045	CARB ONR	R16L-1K	1	417341024T
R5046	CARB ONR	R16L-1K	1	417341024T
R5050	CARB ONR	R16L-5-6K	1	417345624T
R5051	CARB ONR	R16L-5-6K	1	417345624T
R5052	CARB ONR	R16L-5-6K	1	417345624T
R5053	CARB ONR	R16L-5-6K	1	417345624T
R5054	CARB ONR	R16L-5-6K	1	417345624T
R5055	CARB ONR	R16L-5-6K	1	417345624T
R5056	CARB ONR	R16L-5-6K	1	417345624T
R5060	CARB ONR	R16L-2-7K	1	417342724T
R5061	CARB ONR	R16L-2-7K	1	417342724T
R5062	CARB ONR	R16L-2-7K	1	417342724T

R5063	CARB ONR	R16I-2-7K	1	417342724T
R5064	CARB ONR	R16I-2-7K	1	417342724T
R5065	CARB ONR	R16I-2-7K	1	417342724T
R5066	CARB ONR	R16I-2-7K	1	417342724T
R5080	NF CARBONR	R25I-1-0K	1	415471024T
R5081	NF CARBONR	R25I-1-0K	1	415471024T
R5082	NF CARBONR	R25I-1-0K	1	415471024T
R5083	NF CARBONR	R25I-1-0K	1	415471024T
R5084	NF CARBONR	R25I-1-0K	1	415471024T
R5085	NF CARBONR	R25I-1-0K	1	415471024T
R5086	NF CARBONR	R25I-1-0K	1	415471024T
R5090	CARB ONR	R16I-1-00K	1	417341044T
R5091	CARB ONR	R16I-1-00K	1	417341044T
R5092	CARB ONR	R16I-1-00K	1	417341044T
R5093	CARB ONR	R16I-1-00K	1	417341044T
R5094	CARB ONR	R16I-1-00K	1	417341044T
R5095	CARB ONR	R16I-1-00K	1	417341044T
R5096	CARB ONR	R16I-1-00K	1	417341044T
R5100	CARB ONR	R16I-1-00K	1	417341044T
R5101	CARB ONR	R16I-1-00K	1	417341044T
R5102	CARB ONR	R16I-1-00K	1	417341044T
R5103	CARB ONR	R16I-1-00K	1	417341044T
R5104	CARB ONR	R16I-1-00K	1	417341044T
R5105	CARB ONR	R16I-1-00K	1	417341044T
R5106	CARB ONR	R16I-1-00K	1	417341044T
R5110	CARB ONR	R16I-2-2K	1	417342224T
R5111	CARB ONR	R16I-2-2K	1	417342224T
R5112	CARB ONR	R16I-2-2K	1	417342224T
R5113	CARB ONR	R16I-2-2K	1	417342224T
R5114	CARB ONR	R16I-2-2K	1	417342224T
R5115	CARB ONR	R16I-2-2K	1	417342224T
R5116	CARB ONR	R16I-2-2K	1	417342224T
R5120	CARB ONR	R16I-2-2K	1	417342224T
R5121	CARB ONR	R16I-2-2K	1	417342224T
R5122	CARB ONR	R16I-2-2K	1	417342224T
R5123	CARB ONR	R16I-2-2K	1	417342224T
R5124	CARB ONR	R16I-2-2K	1	417342224T
R5125	CARB ONR	R16I-2-2K	1	417342224T
R5126	CARB ONR	R16I-2-2K	1	417342224T
R5130	CARB ONR	R16I-1-8K	1	417341834T
R5131	CARB ONR	R16I-1-8K	1	417341834T
R5132	CARB ONR	R16I-1-8K	1	417341834T
R5133	CARB ONR	R16I-1-8K	1	417341834T
R5134	CARB ONR	R16I-1-8K	1	417341834T
R5135	CARB ONR	R16I-1-8K	1	417341834T
R5136	CARB ONR	R16I-1-8K	1	417341834T
R5140	NF CARBONR	R25I-8-20	1	415478214T

R5141	NF CARBONR	R251-820	1	415478214T
R5142	NF CARBONR	R251-820	1	415478214T
R5143	NF CARBONR	R251-820	1	415478214T
R5144	NF CARBONR	R251-820	1	415478214T
R5145	NF CARBONR	R251-820	1	415478214T
R5146	NF CARBONR	R251-820	1	415478214T
R5150	NF CARBONR	R251-10K	1	415471024T
R5151	NF CARBONR	R251-10K	1	415471024T
R5152	NF CARBONR	R251-10K	1	415471024T
R5153	NF CARBONR	R251-10K	1	415471024T
R5154	NF CARBONR	R251-10K	1	415471024T
R5155	NF CARBONR	R251-10K	1	415471024T
R5156	NF CARBONR	R251-10K	1	415471024T
R5160	NF CARBONR	R251-120	1	415471214T
R5161	NF CARBONR	R251-120	1	415471214T
R5162	NF CARBONR	R251-120	1	415471214T
R5163	NF CARBONR	R251-120	1	415471214T
R5164	NF CARBONR	R251-120	1	415471214T
R5165	NF CARBONR	R251-120	1	415471214T
R5166	NF CARBONR	R251-120	1	415471214T
R5170	NF CARBONR	R251-820	1	415478214T
R5171	NF CARBONR	R251-820	1	415478214T
R5172	NF CARBONR	R251-820	1	415478214T
R5173	NF CARBONR	R251-820	1	415478214T
R5174	NF CARBONR	R251-820	1	415478214T
R5175	NF CARBONR	R251-820	1	415478214T
R5176	NF CARBONR	R251-820	1	415478214T
R5180	NF CARBONR	R251-10	1	415471004T
R5181	NF CARBONR	R251-10	1	415471004T
R5182	NF CARBONR	R251-10	1	415471004T
R5183	NF CARBONR	R251-10	1	415471004T
R5184	NF CARBONR	R251-10	1	415471004T
R5185	NF CARBONR	R251-10	1	415471004T
R5186	NF CARBONR	R251-10	1	415471004T
R5190	NF CARBONR	R251-10	1	415471004T
R5191	NF CARBONR	R251-10	1	415471004T
R5192	NF CARBONR	R251-10	1	415471004T
R5193	NF CARBONR	R251-10	1	415471004T
R5194	NF CARBONR	R251-10	1	415471004T
R5195	NF CARBONR	R251-10	1	415471004T
R5196	NF CARBONR	R251-10	1	415471004T
R5200	CARBONR	R161-18K	1	417341834T
R5201	CARBONR	R161-18K	1	417341834T
R5202	CARBONR	R161-18K	1	417341834T
R5203	CARBONR	R161-18K	1	417341834T
R5204	CARBONR	R161-18K	1	417341834T
R5205	CARBONR	R161-18K	1	417341834T

R5206	CARB ONR	R16L-18K	1	417341834T
R5210	NF CARB ONR	R25I-820	1	415478214T
R5211	NF CARB ONR	R25I-820	1	415478214T
R5212	NF CARB ONR	R25I-820	1	415478214T
R5213	NF CARB ONR	R25I-820	1	415478214T
R5214	NF CARB ONR	R25I-820	1	415478214T
R5215	NF CARB ONR	R25I-820	1	415478214T
R5216	NF CARB ONR	R25I-820	1	415478214T
R5220	NF CARB ONR	R25I-120	1	415471214T
R5221	NF CARB ONR	R25I-120	1	415471214T
R5222	NF CARB ONR	R25I-120	1	415471214T
R5223	NF CARB ONR	R25I-120	1	415471214T
R5224	NF CARB ONR	R25I-120	1	415471214T
R5225	NF CARB ONR	R25I-120	1	415471214T
R5226	NF CARB ONR	R25I-120	1	415471214T
R5270	NF CARB ONR	R25I-120	1	415471214T
R5271	NF CARB ONR	R25I-120	1	415471214T
R5272	NF CARB ONR	R25I-120	1	415471214T
R5273	NF CARB ONR	R25I-120	1	415471214T
R5274	NF CARB ONR	R25I-120	1	415471214T
R5275	NF CARB ONR	R25I-120	1	415471214T
R5276	NF CARB ONR	R25I-120	1	415471214T
R5280	NF CARB ONR	R25I-120	1	415471214T
R5281	NF CARB ONR	R25I-120	1	415471214T
R5282	NF CARB ONR	R25I-120	1	415471214T
R5283	NF CARB ONR	R25I-120	1	415471214T
R5284	NF CARB ONR	R25I-120	1	415471214T
R5285	NF CARB ONR	R25I-120	1	415471214T
R5286	NF CARB ONR	R25I-120	1	415471214T
R5300	CARB ONR	R16L-330	1	417343314T
R5301	CARB ONR	R16L-330	1	417343314T
R5302	CARB ONR	R16L-330	1	417343314T
R5303	CARB ONR	R16L-330	1	417343314T
R5304	CARB ONR	R16L-330	1	417343314T
R5305	CARB ONR	R16L-330	1	417343314T
R5306	CARB ONR	R16L-330	1	417343314T
R5310	CARB ONR	R16L-330	1	417343314T
R5311	CARB ONR	R16L-330	1	417343314T
R5312	CARB ONR	R16L-330	1	417343314T
R5313	CARB ONR	R16L-330	1	417343314T
R5314	CARB ONR	R16L-330	1	417343314T
R5315	CARB ONR	R16L-330	1	417343314T
R5316	CARB ONR	R16L-330	1	417343314T
R5350	NF CARB ONR	R25I-18	1	415471804T
R5351	NF CARB ONR	R25I-18	1	415471804T
R5352	NF CARB ONR	R25I-18	1	415471804T
R5353	NF CARB ONR	R25I-18	1	415471804T

R5354	NF CARBONR	R25I-18	1	415471804T
R5355	NF CARBONR	R25I-18	1	415471804T
R5356	NF CARBONR	R25I-18	1	415471804T
R5360	NF CARBONR	R25I-18	1	415471804T
R5361	NF CARBONR	R25I-18	1	415471804T
R5362	NF CARBONR	R25I-18	1	415471804T
R5363	NF CARBONR	R25I-18	1	415471804T
R5364	NF CARBONR	R25I-18	1	415471804T
R5365	NF CARBONR	R25I-18	1	415471804T
R5366	NF CARBONR	R25I-18	1	415471804T
R5370	NF CARBONR	R25I-22	1	415470224T
R5371	NF CARBONR	R25I-22	1	415470224T
R5372	NF CARBONR	R25I-22	1	415470224T
R5373	NF CARBONR	R25I-22	1	415470224T
R5374	NF CARBONR	R25I-22	1	415470224T
R5375	NF CARBONR	R25I-22	1	415470224T
R5376	NF CARBONR	R25I-22	1	415470224T
R5380	NF CARBONR	R25I-22	1	415470224T
R5381	NF CARBONR	R25I-22	1	415470224T
R5382	NF CARBONR	R25I-22	1	415470224T
R5383	NF CARBONR	R25I-22	1	415470224T
R5384	NF CARBONR	R25I-22	1	415470224T
R5385	NF CARBONR	R25I-22	1	415470224T
R5386	NF CARBONR	R25I-22	1	415470224T
R5420	NF CARBONR	R25I-10	1	415471004T
R5421	NF CARBONR	R25I-10	1	415471004T
R5422	NF CARBONR	R25I-10	1	415471004T
R5423	NF CARBONR	R25I-10	1	415471004T
R5424	NF CARBONR	R25I-10	1	415471004T
R5425	NF CARBONR	R25I-10	1	415471004T
R5426	NF CARBONR	R25I-10	1	415471004T
R5440	TRDMR	N06HR2KBB	1	5211402T
R5441	TRDMR	N06HR2KBB	1	5211402T
R5442	TRDMR	N06HR2KBB	1	5211402T
R5443	TRDMR	N06HR2KBB	1	5211402T
R5444	TRDMR	N06HR2KBB	1	5211402T
R5445	TRDMR	N06HR2KBB	1	5211402T
R5446	TRDMR	N06HR2KBB	1	5211402T
R5450	CARBONR	R16I-3 3K	1	417343324T
R5451	CARBONR	R16I-3 3K	1	417343324T
R5452	CARBONR	R16I-3 3K	1	417343324T
R5453	CARBONR	R16I-3 3K	1	417343324T
R5454	CARBONR	R16I-3 3K	1	417343324T
R5455	CARBONR	R16I-3 3K	1	417343324T
R5456	CARBONR	R16I-3 3K	1	417343324T
R5470	NF CARBONR	R25I-82	1	415478204T
R5471	NF CARBONR	R25I-82	1	415478204T

R5472	NF CARBONR	R251-82	1	415478204T
R5473	NF CARBONR	R251-82	1	415478204T
R5474	NF CARBONR	R251-82	1	415478204T
R5475	NF CARBONR	R251-82	1	415478204T
R5476	NF CARBONR	R251-82	1	415478204T
R5480	CARBONR	R161-10	1	417341004T
R5481	CARBONR	R161-10	1	417341004T
R5482	CARBONR	R161-10	1	417341004T
R5483	CARBONR	R161-10	1	417341004T
R5484	CARBONR	R161-10	1	417341004T
R5485	CARBONR	R161-10	1	417341004T
R5486	CARBONR	R161-10	1	417341004T
R5490	CARBONR	R161-10	1	417341004T
R5491	CARBONR	R161-10	1	417341004T
R5492	CARBONR	R161-10	1	417341004T
R5493	CARBONR	R161-10	1	417341004T
R5494	CARBONR	R161-10	1	417341004T
R5495	CARBONR	R161-10	1	417341004T
R5496	CARBONR	R161-10	1	417341004T
R6000	C-CARBONR	R161-10	1	435034724R1
R6001	C-CARBONR	R161-10	1	435034724R1
R6002	C-CARBONR	R161-10	1	435034724R1
R6003	C-CARBONR	R161-10	1	435034724R1
R6004	C-CARBONR	R161-10	1	435034724R1
R6005	C-CARBONR	R161-10	1	435034724R1
R6006	C-CARBONR	R161-10	1	435034724R1
R6010	C-CARBONR	R161-10	1	43503324R1
R6011	C-CARBONR	R161-10	1	43503324R1
R6012	C-CARBONR	R161-10	1	43503324R1
R6013	C-CARBONR	R161-10	1	43503324R1
R6014	C-CARBONR	R161-10	1	43503324R1
R6015	C-CARBONR	R161-10	1	43503324R1
R6016	C-CARBONR	R161-10	1	43503324R1
R6020	C-CARBONR	R161-10	1	43503004R1
R6021	C-CARBONR	R161-10	1	43503004R1
R6022	C-CARBONR	R161-10	1	43503004R1
R6023	C-CARBONR	R161-10	1	43503004R1
R6024	C-CARBONR	R161-10	1	43503004R1
R6025	C-CARBONR	R161-10	1	43503004R1
R6026	C-CARBONR	R161-10	1	43503004R1
R6100	METAL PR	MPP5W+5W OR22	1	4000233
R6100 or	METAL PR	FF-5EGBR22	(1)	4000244
R6101	METAL PR	MPP5W+5W OR22	1	4000233
R6101 or	METAL PR	FF-5EGBR22	(1)	4000244
R6102	METAL PR	MPP5W+5W OR22	1	4000233
R6102 or	METAL PR	FF-5EGBR22	(1)	4000244
R6103	METAL PR	MPP5W+5W OR22	1	4000233

R6103 or	METAL P R	RF-SEGJR22	(1)	4000244	N
R6104	METAL PR	MPFSW+SW OR22	1	4000233	N
R6104 or	METAL P R	RF-SEGJR22	(1)	4000244	N
R6105	METAL PR	MPFSW+SW OR22	1	4000233	N
R6105 or	METAL P R	RF-SEGJR22	(1)	4000244	N
R6106	METAL PR	MPFSW+SW OR22	1	4000233	N
R6106 or	METAL P R	RF-SEGJR22	(1)	4000244	N
R6140	CARBON R	R161-56K	1	417345634T	
R6141	CARBON R	R161-56K	1	417345634T	
R6142	CARBON R	R161-56K	1	417345634T	
R6143	CARBON R	R161-56K	1	417345634T	
R6144	CARBON R	R161-56K	1	417345634T	
R6145	CARBON R	R161-56K	1	417345634T	
R6146	CARBON R	R161-56K	1	417345634T	
R6150	CARBON R	R161-10K	1	417341034T	
R6151	CARBON R	R161-10K	1	417341034T	
R6152	CARBON R	R161-10K	1	417341034T	
R6153	CARBON R	R161-10K	1	417341034T	
R6154	CARBON R	R161-10K	1	417341034T	
R6155	CARBON R	R161-10K	1	417341034T	
R6156	CARBON R	R161-10K	1	417341034T	
R6160	C-CARBON R	RN72K1J-333JE	1	43503334R1	
R6161	C-CARBON R	RN72K1J-333JE	1	43503334R1	
R6162	C-CARBON R	RN72K1J-333JE	1	43503334R1	
R6163	C-CARBON R	RN72K1J-333JE	1	43503334R1	
R6164	C-CARBON R	RN72K1J-333JE	1	43503334R1	
R6165	C-CARBON R	RN72K1J-333JE	1	43503334R1	
R6166	C-CARBON R	RN72K1J-333JE	1	43503334R1	
R6170	CARBON R	R161-47K	1	417344734T	
R6171	CARBON R	R161-47K	1	417344734T	
R6172	CARBON R	R161-47K	1	417344734T	
R6173	CARBON R	R161-47K	1	417344734T	
R6174	CARBON R	R161-47K	1	417344734T	
R6175	CARBON R	R161-47K	1	417344734T	
R6176	CARBON R	R161-47K	1	417344734T	
R6180	CARBON R	R161-47K	1	417344734T	
R6181	CARBON R	R161-47K	1	417344734T	
R6182	CARBON R	R161-47K	1	417344734T	
R6183	CARBON R	R161-47K	1	417344734T	
R6184	CARBON R	R161-47K	1	417344734T	
R6185	CARBON R	R161-47K	1	417344734T	
R6186	CARBON R	R161-47K	1	417344734T	
R6197	METAL O R	R51/2WB1-39	1	443523904T	
R6505	C-CARBON R	RN72K1J-223JE	1	435032234R1	
R6506	C-CARBON R	RN72K1J-122JE	1	435031224R1	
R6507	C-CARBON R	RN72K1J-473JE	1	43504734R1	
R6508	C-CARBON R	RN72K1J-182JE	1	435031824R1	

R6599	C-CARB ONR	RN7ZK UJ-331E	1	43503314R1
R6600	METAL O R	RS1/2WB J-10	1	443521004T
R6601	METAL O R	RS1/2WB J-10	1	443521004T
R6602	METAL O R	RS1/2WB J-10	1	443521004T
R6603	METAL O R	RS1/2WB J-10	1	443521004T
R6604	METAL O R	RS1/2WB J-10	1	443521004T
R6605	METAL O R	RS1/2WB J-10	1	443521004T
R6606	METAL O R	RS1/2WB J-10	1	443521004T
R6630	METAL R	RND1WCI-8.2	1	453630824T
R6631	METAL R	RND1WCI-8.2	1	453630824T
R6632	METAL R	RND1WCI-8.2	1	453630824T
R6633	METAL R	RND1WCI-8.2	1	453630824T
R6634	METAL R	RND1WCI-8.2	1	453630824T
R6635	METAL R	RND1WCI-8.2	1	453630824T
R6636	METAL R	RND1WCI-8.2	1	453630824T
R6701	C-CARB ONR	RN7ZK UJ-223E	1	435032234R1
R6702	C-CARB ONR	RN7ZK UJ-103E	1	435031034R1
R6704	C-CARB ONR	RN7ZK UJ-473E	1	435034734R1
R6706	C-CARB ONR	RN7ZK UJ-224E	1	435032244R1
R6708	C-CARB ONR	RN7ZK UJ-333E	1	435033334R1
R6709	C-CARB ONR	RN7ZK UJ-392E	1	43503924R1
R6710	C-CARB ONR	RN7ZK UJ-123E	1	435031234R1
R6712	C-CARB ONR	RN7ZK UJ-103E	1	435031034R1
R6714	C-CARB ONR	RN7ZK UJ-533E	1	435035334R1
R6716	C-CARB ONR	RN7ZK UJ-563E	1	43503634R1
R6902	C-CARB ONR	RN7ZK UJ-102E	1	435031024R1
R6903	C-CARB ONR	RN7ZK UJ-473E	1	435034734R1
R6904	METAL R	RND1/2WCI-0-22	1	45353224T
E6008A	TRM	NTM-1P23Q(M1700)	1	25060301
E6008B	TRM	NTM-1P23Q(M1969)	1	25060302
E6009A	TRM	NTM-1P23Q(M1700)	1	25060301
E6010A	TRM	NTM-1P23Q(M1700)	1	25060301
F6901A	FUSE HOLDER	SN5051	1	250113
F6901B	FUSE HOLDER	SN5051	1	250113
F6902A	FUSE HOLDER	SN5051	1	250113
F6902B	FUSE HOLDER	SN5051	1	250113
IL6401A	WIRE HOL	NSCT-3P874	1	25051087
IL6401B	WIRE HOL	NSCT-3P874	1	25051087
IL6402A	WIRE HOL	NSCT-3P874	1	25051087
IL6402B	WIRE HOL	NSCT-3P874	1	25051087
P4512A	CRIMP AS	CRIMP SR805_1	1	20799169UL
P4517A	SOCKET AS	NSAS-30P1827	1	200991179UL
P6000	SOCKET	NSCT-9P2189	1	25052292
P6000B	PLUG	NPLG-9P0964	1	25056014
P6001	SOCKET	NSCT-9P2189	1	25052292
P6001B	PLUG	NPLG-9P0964	1	25056014

P6002	SOCKET	NSCT-9P2189	1	25052292					
P6002B	PLUG	NPLG-9P0964	1	25056014					
P6003	SOCKET	NSCT-9P2189	1	25052292					
P6003B	PLUG	NPLG-9P0964	1	25056014					
P6004	SOCKET	NSCT-9P2189	1	25052292					
P6004B	PLUG	NPLG-9P0964	1	25056014					
P6005	SOCKET	NSCT-9P2189	1	25052292					
P6005B	PLUG	NPLG-9P0964	1	25056014					
P6006	SOCKET	NSCT-9P2189	1	25052292					
P6006B	PLUG	NPLG-9P0964	1	25056014					
P6007A	PLUG	NPLG-3P0958	1	25056008					
P6007B	SOCKET	NSCT-3P2183	1	25052286					
P6009B	TRM	NTM-1P23(M1969)	1	25060302					
P6010B	TRM	NTM-1P23(M1969)	1	25060302					
P6011A	RETAINER	(BUS-D)	1	27142115A					
P6080	PLUG	NPLG-2P29	1	25055038					
P6081	PLUG	NPLG-2P29	1	25055038					
P6082	PLUG	NPLG-2P29	1	25055038					
P6083	PLUG	NPLG-2P29	1	25055038					
P6084	PLUG	NPLG-2P29	1	25055038					
P6085	PLUG	NPLG-2P29	1	25055038					
P6086	PLUG	NPLG-2P29	1	25055038					
P6500	PLUG	NPLG-2P83	1	25055099					
P6600	SOCKET AS	NSAS-14P1821	1	20099911760L					
P6603A	SOCKET AS	NSAS-22P1828	1	20099911800L					
P6606A	SOCKET AS	NSAS-18P1857	1	200999118150L					
P6900	CRIMP AS	CRIMP AS	1	20699251700L					
P6901	CRIMP AS	CRIMP AS	1	20699251190L					
P6902	CRIMP AS	CRIMP AS	1	20699251880L					
P6950	PLUG	NPLG-5P152	1	25055168					
RL691	RELAY	NRL-1P10A-DC12-197	1	25065708					
RL691 or	RELAY	NRL-1P10A-DC12-198	(1)	25065709					
RL692	RELAY	NRL-1P10A-DC12-197	1	25065708					
RL692 or	RELAY	NRL-1P10A-DC12-198	(1)	25065709					

PC BOARD PARTS LIST

TX-NR708

U003	U0030~U0033	BATRM-0450-1A *	1	1B248560-1A	N <B MDC, MDE, MJU>
U0030	SPEAKER TERMINAL_L_1 PC BOARD AS	BATRM-0450-1A	1	1B2485450-1A	N <B MDC, MDE, MJU>
U0031	SPEAKER TERMINAL_L_2 PC BOARD AS	BATRM-0451-1A	1	1B2485451-1A	N <B MDC, MDE, MJU>
U0032	SPEAKER TERMINAL_L_3 PC BOARD AS	BATRM-0452-1A	1	1B2485452-1A	N <B MDC, MDE, MJU>
U0033	POWER SUPPLY PC BOARD AS	BAPS-0454-1A	1	1B2485454-1A	N <B MDC, MDE, MJU>
U003	U0030~U0033	BATRM-0450-1B *	1	1B248560-1B	N <B MMA, MME, MMQ, MMW / S.MMEP>
U0030	SPEAKER TERMINAL_L_1 PC BOARD AS	BATRM-0450-1B	1	1B2485450-1B	N <B MMA, MME, MMQ, MMW / S.MMEP>
U0031	SPEAKER TERMINAL_L_2 PC BOARD AS	BATRM-0451-1B	1	1B2485451-1B	N <B MMA, MME, MMQ, MMW / S.MMEP>

CIRCUIT NO.	PART NAME	DESCRIPTION	QTY	PART NO. (SN)	REMARKS
U0032	SPEAKER TERMINAL_3 PC BOARD AS	BATRM-0452-1B	1	1B2485452-1B	N <B MINA, MINP, MINQ, MINR / S MINP>
U0033	POWER SUPPLY PC BOARD AS	BAPS-0454-1B	1	1B2485454-1B	N <B MINA, MINP, MINQ, MINR / S MINP>
BEAM CONDUCTOR					
D6600	DIODE	ISS133	1	223163T	
D6603	DIODE	ISS133	1	223163T	
D6604	DIODE	ISS133	1	223163T	
D6605	DIODE	ISS133	1	223163T	
D6606	DIODE	ISS133	1	223163T	
D6610	DIODE	ISS133	1	223163T	
D911	DIODE	ISS133	1	223163T	
D912	DIODE	ISS133	1	223163T	
D921	DIODE	ISS133	1	223163T	
D922	DIODE	ISS133	1	223163T	
D923	DIODE	ISS133	1	223163T	
D924	DIODE	ISS133	1	223163T	
D925	DIODE	ISS133	1	223163T	
D926	DIODE	ISS133	1	223163T	
D930	DIODE	ISS133	1	223163T	
D9300	DIODE	D3SBA20	1	22380271F	
D9300 or	DIODE	RBV402	(1)	22380022F	
D9301	ZENER D	MTZJ15B	1	224471502T	
D9302	ZENER D	MTZJ15B	1	224471502T	
D9303	DIODE	ISS133	1	223163T	
D9304	DIODE	ISS133	1	223163T	
D931	DIODE	ISS133	1	223163T	
D933	DIODE	ISS133	1	223163T	
D934	ZENER D	MTZJ3 6B	1	224470362T	
D935	DIODE	ISS133	1	223163T	
Q6601 or	TR	KRC105M	1	2215830T	
Q6601 or	TR	DTC123IS	(1)	2213640T	
Q6602	TR	KRC105M	1	2215830T	
Q6602 or	TR	DTC123IS	(1)	2213640T	
Q6603	TR	KRC105M	1	2215830T	
Q6603 or	TR	DTC123IS	(1)	2213640T	
Q6604	TR	KRC105M	1	2215830T	
Q6604 or	TR	DTC123IS	(1)	2213640T	
Q6605	TR	KRC105M	1	2215830T	
Q6605 or	TR	DTC123IS	(1)	2213640T	
Q6606	TR	KRC105M	1	2215830T	
Q6606 or	TR	DTC123IS	(1)	2213640T	
Q6608	TR	ZSC2235-Y(TPE 6 F)	1	2211654T	
Q901	TR	ZSC1815-GR	1	2211255T	
Q901 or	TR	ZSC1815-Y	(1)	2211254T	
Q9301	TR	ZSK365-GR	1	2212445T	
Q9302	TR	ZSK365-GR	1	2212445T	

Q9303	TR		2SC1815-GR	1	2211255T	
Q9303 or	TR		2SC1815-Y	(1)	2211254T	
Q9304	TR		2SA1015-GR	1	2211455T	
Q9304 or	TR		2SA1015-Y	(1)	2211454T	
Q9305	TR		2SA1488-Y	1	2203394	
Q9305 or	TR		2SB1565-E	(1)	2202715	
Q9305A	HEAT SINK		(RAD-25)	1	27160647	N
Q9305B	SCREW		3F+10FN(3BC)	2	82143010GR	
Q9306	TR		2SC3851-Y	1	2203384	
Q9306 or	TR		2SD2394-E	(1)	2202705	
[TRANS CON.]						
T901	P TRANS		NPT-1520Q	1	2301812A	<B MDC, MDR, MJ>
T902	P TRANS		NPT-1520Q-Q	1	2301813A	<B MMA, MNP, MMQ, MMR / S.MMP>
[CAPACITOR]						
C6600	TF C		ECQ-V50V-103J	1	374721034T	
C6602	TF C		ECQ-V50V-103J	1	374721034T	
C6603	TF C		ECQ-V50V-103J	1	374721034T	
C6604	TF C		ECQ-V50V-103J	1	374721034T	
C6605	TF C		ECQ-V50V-103J	1	374721034T	
C6606	TF C		ECQ-V50V-103J	1	374721034T	
C6607	UTSP C		CE04W/50V-10M(UTSP)	1	397581007T	
C6608	VR C		CE04W/35V-470M(VR)	1	394664717T	
C6609	UTSP C		CE04W/50V-10M(UTSP)	1	397581007T	
C6639	MKT C		B 32529C0472J289	1	376494724T	
C6640	MKT C		B 32529C0472J289	1	376494724T	
C6641	MKT C		B 32529C0472J289	1	376494724T	
C6642	MKT C		B 32529C0472J289	1	376494724T	
C6643	MKT C		B 32529C0472J289	1	376494724T	
C6644	MKT C		B 32529C0472J289	1	376494724T	
C6645	MKT C		B 32529C0472J289	1	376494724T	
C6646	MKT C		B 32529C0472J289	1	376494724T	
C6647	MKT C		B 32529C0472J289	1	376494724T	
C6648	MKT C		B 32529C0472J289	1	376494724T	
C6649	MKT C		B 32529C0472J289	1	376494724T	
C6650	MKT C		B 32529C0102J289	1	376491024T	
C6651	MKT C		B 32529C0102J289	1	376491024T	
C6652	MKT C		B 32529C0102J289	1	376491024T	
C6653	MKT C		B 32529C0102J289	1	376491024T	
C6654	MKT C		B 32529C0102J289	1	376491024T	
C6655	MKT C		B 32529C0102J289	1	376491024T	
C6656	MKT C		B 32529C0102J289	1	376491024T	
C6657	MKT C		B 32529C0102J289	1	376491024T	
C6658	MKT C		B 32529C0102J289	1	376491024T	
C6659	MKT C		B 32529C0102J289	1	376491024T	
C6660	MKT C		B 32529C0102J289	1	376491024T	
C901	IS C		ECQJ2A103MLC	1	3800039S	
C901 or	IS C		RE275V-103M	(1)	3500196S	

Part No	IS C	LE103-C3 5	(1)	3800042S	
C901	IS C				
C902	TF C	EQ-Q-V50V-104J	1	374721044T	
C903	PLA C	MAKP R46 104M	1	3800041S	
C911	MAKT C	B 32520C0102D289	1	376491024T	
C921	TF C	EQ-Q-V50V-223I	1	374722234T	
C922	VR C	CE04W25V-2200M(VR)	1	394652227S	
C930	UTSP C	CE04W16V-470M(UTSP)	1	397544717T	
C9300	VR C	CE04W35V-2200M(VR)	1	394662227S	
C9301	VR C	CE04W35V-2200M(VR)	1	394662227S	
C9302	UTSP C	CE04W25V-100M(UTSP)	1	397551017T	
C9303	UTSP C	CE04W25V-100M(UTSP)	1	397551017T	
C9304	UTSP C	CE04W25V-100M(UTSP)	1	397551017T	
C9305	UTSP C	CE04W25V-100M(UTSP)	1	397551017T	
C9306	TF C	EQ-Q-V50V-334J	1	374723344T	
C933	UTSP C	CE04W50V-47M(UTSP)	1	397580477T	
RESISTOR					
R6601	METAL O R	R.SI/2WB1-220	1	44352214T	
R6691	METAL O R	R.SI/2WB1-390	1	443523914T	
R6692	METAL O R	R.SI/2WB1-390	1	443523914T	
R921	METAL O R	R.SI/2WB1-47	1	443524704T	
R922	METAL O R	R.SI/2WB1-68	1	443526804T	
R9302	METAL R	RND1/2WC1-1	1	453530104T	
R9303	METAL R	RND1/2WC1-1	1	453530104T	
R9304	CARBON R	R.161-330	1	417343314T	
R9305	CARBON R	R.161-330	1	417343314T	
R934	CARBON R	R.161-33K	1	417343344T	
R935	CARBON R	R.161-100K	1	417341044T	
R936	CARBON R	R.161-1K	1	417341024T	
SW I TCH					
E6611	TRM	NTM-1P23Q(M700)	1	25060301	
E6612	TRM-423(SCREW)	NEJTANSI ST3	1	25060495	
E901	TRM-423(SCREW)	NEJTANSI ST3	1	25060495	
E902	TRM	NTM-1P23Q(M199)	1	25060302	
F901A	FUSE HOLDER	SNS051	1	250113	<B MDC, MDF, MDI>
F901B	FUSE HOLDER	SNS051	1	250113	<B MDC, MDF, MDI>
F901C	FUSE HOL	NSCT-1P2031	1	25052133T	<B NMA, MNP, MMQ, MMK / SMMMP>
F901D	FUSE HOL	NSCT-1P2031	1	25052133T	<B NMA, MNP, MMQ, MMK / SMMMP>
IL4103A	SOCKET	NSCT-5P97	1	25050269	
IL6604A	WIRE HOL	NSCT-7P898	1	25051111	
IL6604B	SOCKET	NSCT-7P99	1	25050271	
IL6607A	WIRE HOL	NSCT-3P894	1	25051107	
IL6607B	WIRE HOL	NSCT-3P894	1	25051107	
IL901A	WIRE HOL	NSCT-5P876	1	25051089	
IL9925A	WIRE HOL	NSCT-5P876	1	25051089	
P1008A	SOCKET	IMSA-9142S-22A	1	25053233	
P6600	PLUG	NPLG-9P491	1	25055516	
P6601A	SOCKET	IMSA-9142S-16A	1	25053230	

P6603B	FLUG		NPLG-11P493	1	25055518	
P6605A	SOCKET		INSA-9142S-2ZA	1	25053233	
P6606B	FLUG		NPLG-9P356	1	25055373	
P6610	TRM		NTM-2PDMCR400	1	25060472	
P6630	TRM		NTM-2PDMCR400	1	25060472	
P6631	TRM		NTM-2PDMCR400	1	25060472	
P6632	TRM		NTM-2PDMCR400	1	25060472	
P6633	TRM		NTM-2PDMCR400	1	25060472	
P6634	TRM		NTM-2PDMCR400	1	25060472	
P6635	TRM		NTM-2PDMCR400	1	25060472	
P6636	TRM		NTM-2PDMCR400	1	25060472	
P6637	TRM		NTM-2PDMCR400	1	25060472	
P6638	TRM		NTM-2PDMCR400	1	25060472	
P6639	TRM		NTM-2PDMCR400	1	25060472	
P902B	FLUG		NPLG-2P631	1	25055675	
P902B or	FLUG		1-1123724-2	(1)	2506402	
P911	FLUG		NPLG-2P631	1	25055675	
P911 or	FLUG		1-1123724-2	(1)	2506402	
P921C	FLUG		NPLG-2P631	1	25055675	
P921C or	FLUG		1-1123724-2	(1)	2506402	
P9311	FLUG		NPLG-3P117	1	25051133	
RL6600	RELAY		NRL-2P5A-DC24-193	1	25065703	
RL6602	RELAY		NRL-2P5A-DC24-193	1	25065703	
RL6603	RELAY		NRL-2P5A-DC24-193	1	25065703	
RL6604	RELAY		NRL-2P5A-DC24-193	1	25065703	
RL6605	RELAY		NRL-2P5A-DC24-193	1	25065703	
RL6606	RELAY		NRL-2P5A-DC24-193	1	25065703	
RL901	RELAY		NRL-1P10A-DC9-186	1	25065883	

TX-NR708

PC BOARD PARTS LIST

U004	U0040~U0041	ANALOG AUDIO PC BOARD AS	BAASP-0458-1A *	1	1B2486458-1A	N <B MDC, MDF, MMA, MMP, MMQ, MMR / S MMP>
U0040		ANALOG AUDIO PC BOARD AS	BAASP-0458-1A	1	1B2486458-1A	N <B MDC, MDF, MMA, MMP, MMQ, MMR / S MMP>
U0041		D-SUB TERMINAL PC BOARD AS	BAETC-0459-1A	1	1B2486459-1A	N <B MDC, MDF, MMA, MMP, MMQ, MMR / S MMP>
U004	U0040~U0041		BAASP-0458-1B *	1	1B2486458-1B	N <B MUJ>
U0040		ANALOG AUDIO PC BOARD AS	BAASP-0458-1B	1	1B2486458-1B	N <B MUJ>
U0041		D-SUB TERMINAL PC BOARD AS	BAETC-0459-1B	1	1B2486459-1B	N <B MUJ>

CIRCUIT NO.	PART NAME	DESCRIPTION	QTY	PART NO. (SN)	REMARKS
PC BOARD PARTS LIST					
D4505	C-DIODE	KDS4148U	1	223234R2	
D4505 or	C-DIODE	ISS352	(1)	223234R2	
D4505 or	C-DIODE	MAA211110GL	(1)	223302R2	
D4506	C-DIODE	KDS4148U	1	223234R2	
D4506 or	C-DIODE	ISS352	(1)	223234R2	

D4506 or	C-DIODE	MA2J1110GL	(1)	22330R2	
D4507	C-DIODE	KD S4148U	1	22328R2	<B MDC, MDE, MMA, MNP, MMQ, MNR / S MNP>
D4507 or	C-DIODE	ISS352	(1)	22324R2	<B MDC, MDE, MMA, MNP, MMQ, MNR / S MNP>
D4507 or	C-DIODE	MA2J1110GL	(1)	22330R2	
D4508	C-DIODE	KD S4148U	1	22328R2	<B MDC, MDE, MMA, MNP, MMQ, MNR / S MNP>
D4508 or	C-DIODE	ISS352	(1)	22324R2	<B MDC, MDE, MMA, MNP, MMQ, MNR / S MNP>
D4508 or	C-DIODE	MA2J1110GL	(1)	22330R2	<B MDC, MDE, MMA, MNP, MMQ, MNR / S MNP>
D4515	C-DIODE	KD S4148U	1	22328R2	
D4515 or	C-DIODE	ISS352	(1)	22324R2	
D4515 or	C-DIODE	MA2J1110GL	(1)	22330R2	
D4516	C-DIODE	KD S4148U	1	22328R2	
D4516 or	C-DIODE	ISS352	(1)	22324R2	
D4516 or	C-DIODE	MA2J1110GL	(1)	22330R2	
D4517	C-DIODE	KD S4148U	1	22328R2	
D4517 or	C-DIODE	ISS352	(1)	22324R2	
D4517 or	C-DIODE	MA2J1110GL	(1)	22330R2	
D4518	C-DIODE	KD S4148U	1	22328R2	<B MDC, MDE, MMA, MNP, MMQ, MNR / S MNP>
D4518 or	C-DIODE	ISS352	(1)	22324R2	<B MDC, MDE, MMA, MNP, MMQ, MNR / S MNP>
D4518 or	C-DIODE	MA2J1110GL	(1)	22330R2	<B MDC, MDE, MMA, MNP, MMQ, MNR / S MNP>
D4900	ZENER D	UDZ57 5B	1	22450750R2	
D4901	ZENER D	UDZ51 3B	1	22451300R2	
D4910	ZENER D	UDZ57 5B	1	22450750R2	
D4911	ZENER D	UDZ51 3B	1	22451300R2	
Q4500	IC	R2A15220FP	1	22242600R3	
Q4502	IC	NUM4580M-E	1	22241448R2	
Q4503	IC	NUM4580M-E	1	22241448R2	
Q4504	IC	NUM4580M-E	1	22241448R2	
Q4550	TR	ZSK365-GR	1	2212445T	
Q4551	TR	ZSA1486-Y	1	2203394	
Q4552	TR	ZSC1815-GR	1	2211255T	
Q4553	TR	ZSC2235-Y(TPE_6_F)	1	2211644T	
Q4560	TR	ZSK365-GR	1	2212445T	
Q4561	TR	ZSC3851-Y	1	2203384	
Q4562	TR	ZSA1015-GR	1	2211455T	
Q4563	TR	ZSA065-Y(TPE_6_F)	1	2211644T	
Q4600	TR	RN1441	1	2215410R2	
Q4601	TR	RN1441	1	2215410R2	
Q4602	TR	RN1441	1	2215410R2	
Q4603	TR	RN1441	1	2215410R2	
Q4604	TR	RN1441	1	2215410R2	
Q4605	TR	RN1441	1	2215410R2	
Q4606	TR	RN1441	1	2215410R2	
Q4607	TR	RN1441	1	2215410R2	
Q4616	TR	RN1441	1	2215410R2	
Q4617	TR	RN1441	1	2215410R2	
Q4620	TR	RN1441	1	2215410R2	
Q4621	TR	RN1441	1	2215410R2	

Q4622	TR		RN1441	1	2215410R2	
Q4623	TR		RN1441	1	2215410R2	
Q4624	TR		RN1441	1	2215410R2	
Q4625	TR		RN1441	1	2215410R2	
Q4630	TR		RN1441	1	2215410R2	
Q4631	TR		RN1441	1	2215410R2	
(CHASSIS SCREW)						
P4520	HOLDER		HOLDER(CLAMP)	1	27190540-1	
(CAPACITOR)						
C4500	C-CERA C		CC725CH1H-221J1	1	342102214R1	<B M0J>
C4501	C-CERA C		CC725CH1H-221J1	1	342102214R1	<B M0J>
C4503	UPZ C		2AUPZTF21JE	1	376332214T	
C4504	UPZ C		2AUPZTF21JE	1	376332214T	
C4505	C-CERA C		CC725CH1H-221J1	1	342102214R1	
C4506	C-CERA C		CC725CH1H-221J1	1	342102214R1	
C4507	C-CERA C		CC725CH1H-221J1	1	342102214R1	
C4508	C-CERA C		CC725CH1H-221J1	1	342102214R1	
C4509	C-CERA C		CC725CH1H-221J1	1	342102214R1	
C4510	C-CERA C		CC725CH1H-221J1	1	342102214R1	
C4511	C-CERA C		CC725CH1H-221J1	1	342102214R1	
C4512	C-CERA C		CC725CH1H-221J1	1	342102214R1	
C4513	C-CERA C		CC725CH1H-221J1	1	342102214R1	
C4514	C-CERA C		CC725CH1H-221J1	1	342102214R1	
C4515	UPZ C		2AUPZTF21JE	1	376332214T	
C4516	UPZ C		2AUPZTF21JE	1	376332214T	
C4517	C-CERA C		CC725CH1H-221J1	1	342102214R1	
C4518	UPZ C		2AUPZTF21JE	1	376332214T	
C4519	C-CERA C		CC725CH1H-221J1	1	342102214R1	
C4520	C-CERA C		CC725CH1H-221J1	1	342102214R1	
C4521	C-CERA C		CC725CH1H-221J1	1	342102214R1	
C4522	C-CERA C		CC725CH1H-221J1	1	342102214R1	
C4523	UTSP C		CE04W25V-220M(UTSP)	1	397552217T	
C4524	UTSP C		CE04W25V-220M(UTSP)	1	397552217T	
C4525	UTSP C		CE04W50V-47M(UTSP)	1	397584707T	
C4526	UTSP C		CE04W50V-47M(UTSP)	1	397584707T	
C4530	C-CERA C		CC725CH1H-221J1	1	342102214R1	
C4531	C-CERA C		CC725CH1H-221J1	1	342102214R1	
C4532	C-CERA C		CC725CH1H-221J1	1	342102214R1	
C4533	C-CERA C		CC725CH1H-221J1	1	342102214R1	
C4534	C-CERA C		CC725CH1H-221J1	1	342102214R1	
C4535	C-CERA C		CC725CH1H-221J1	1	342102214R1	
C4536	C-CERA C		CC725CH1H-221J1	1	342102214R1	
C4537	C-CERA C		CC725CH1H-221J1	1	342102214R1	
C4540	C-CERA C		CC725CH1H-221J1	1	342102214R1	<B MDC, MDF, MMA, MMP, MMQ, MMR / S MNP>
C4541	C-CERA C		CC725CH1H-221J1	1	342102214R1	<B MDC, MDF, MMA, MMP, MMQ, MMR / S MNP>
C4570	UTSP C		CE04W50V-47M(UTSP)	1	397584707T	
C4571	UTSP C		CE04W50V-47M(UTSP)	1	397584707T	

C4572	UTSP C	CE04W50V 47M(UTSP)	1	397584707T
C4573	UTSP C	CE04W50V 47M(UTSP)	1	397584707T
C4574	UTSP C	CE04W50V 47M(UTSP)	1	397584707T
C4575	UTSP C	CE04W50V 47M(UTSP)	1	397584707T
C4576	UTSP C	CE04W50V 47M(UTSP)	1	397584707T
C4577	UTSP C	CE04W50V 47M(UTSP)	1	397584707T
C4600	UTSP C	CE04W50V 47M(UTSP)	1	397584707T
C4601	UTSP C	CE04W50V 47M(UTSP)	1	397584707T
C4602	UTSP C	CE04W50V 47M(UTSP)	1	397584707T
C4603	UTSP C	CE04W50V 47M(UTSP)	1	397584707T
C4604	UTSP C	CE04W50V 47M(UTSP)	1	397584707T
C4605	UTSP C	CE04W50V 47M(UTSP)	1	397584707T
C4606	UTSP C	CE04W50V 47M(UTSP)	1	397584707T
C4607	UTSP C	CE04W50V 47M(UTSP)	1	397584707T
C4610	UTSP C	CE04W50V 47M(UTSP)	1	397584707T
C4611	UTSP C	CE04W50V 47M(UTSP)	1	397584707T
C4612	UTSP C	CE04W50V 47M(UTSP)	1	397584707T
C4613	UTSP C	CE04W50V 47M(UTSP)	1	397584707T
C4614	UTSP C	CE04W50V 47M(UTSP)	1	397584707T
C4615	UTSP C	CE04W50V 47M(UTSP)	1	397584707T
C4620	UTSP C	CE04W50V 47M(UTSP)	1	397584707T
C4621	UTSP C	CE04W50V 47M(UTSP)	1	397584707T
C4675	UTSP C	CE04W10V 220M(UTSP)	1	397532217T
C4726	C-OERA C	C6725CH1H-471J1	1	342104714R1
C4736	C-OERA C	C6725CH1H-471J1	1	342104714R1
C4740	C-OERA C	C6725CH1H-102J1	1	342101024R1
C4741	UTSP C	CE04W25V 47M(UTSP)	1	397554707T
C4742	UTSP C	CE04W10V 220M(UTSP)	1	397532217T
C4743	C-OERA C	C6725B1H-152K1	1	332101525R1
C4744	TF C	EQ-V50V-123T	1	374721234T
C4745	MKT C	B 32529C0332289	1	376493324T
C4746	C-OERA C	C6725CH1H-151J1	1	342101514R1
C4747	UTSP C	CE04W10V 220M(UTSP)	1	397532217T
C4748	C-OERA C	C6725CH1H-101J1	1	342101014R1
C4749	UTSP C	CE04W50V 10M(UTSP)	1	397581007T
C4750	C-OERA C	C6725CH1H-102J1	1	342101024R1
C4751	UTSP C	CE04W25V 47M(UTSP)	1	397554707T
C4752	UTSP C	CE04W10V 220M(UTSP)	1	397532217T
C4753	C-OERA C	C6725B1H-152K1	1	332101525R1
C4754	TF C	EQ-V50V-123T	1	374721234T
C4755	MKT C	B 32529C0332289	1	376493324T
C4756	C-OERA C	C6725CH1H-151J1	1	342101514R1
C4758	C-OERA C	C6725CH1H-101J1	1	342101014R1
C4759	UTSP C	CE04W50V 10M(UTSP)	1	397581007T
C4760	UTSP C	CE04W25V 47M(UTSP)	1	397554707T
C4761	C-OERA C	C6725CH1H-221J1	1	342102214R1
C4762	TF C	EQ-V50V-103T	1	374721034T

C4770	C-CERA C		CC725CH1H-10211	1	342101024R1	
C4771	UTSP C		CE04W10V-220M(UTSP)	1	397552217T	
C4780	C-CERA C		CC725CH1H-10211	1	342101014R1	
C4781	UTSP C		CE04W10V-220M(UTSP)	1	397552217T	
C4796	UTSP C		CE04W25V-47M(UTSP)	1	397554707T	
C4800	C-CERA C		CC725CH1H-10211	1	342101024R1	
C4802	C-CERA C		CC725CH1H-10211	1	342101024R1	
C4803	C-CERA C		CC725CH1H-10211	1	342101024R1	
C4804	C-CERA C		CC725CH1H-10211	1	342101024R1	
C4805	C-CERA C		CC725CH1H-10211	1	342101024R1	
C4806	C-CERA C		CC725CH1H-10211	1	342101024R1	
C4807	C-CERA C		CC725CH1H-10211	1	342101024R1	
C4808	C-CERA C		CC725CH1H-10211	1	342101024R1	
C4809	C-CERA C		CC725CH1H-10211	1	342101024R1	
C4833	UTSP C		CE04W50V-10M(UTSP)	1	397581007T	<B MDC, MDE, MMA, MMP, MMQ, MMR / S.MMP>
C4834	UTSP C		CE04W50V-10M(UTSP)	1	397581007T	<B MDC, MDE, MMA, MMP, MMQ, MMR / S.MMP>
C4835	UTSP C		CE04W50V-10M(UTSP)	1	397581007T	<B MDC, MDE, MMA, MMP, MMQ, MMR / S.MMP>
C4836	UTSP C		CE04W50V-10M(UTSP)	1	397581007T	<B MDC, MDE, MMA, MMP, MMQ, MMR / S.MMP>
C4840	TF C		EQO-V50V-104J	1	374721044T	
C4900	VR C		CE04W35V-470M(VR)	1	394664717T	
C4901	UTSP C		CE04W50V-22M(UTSP)	1	397582207T	
C4902	UTSP C		CE04W25V-220M(UTSP)	1	397552217T	
C4903	UTSP C		CE04W25V-220M(UTSP)	1	397552217T	
C4904	UTSP C		CE04W25V-220M(UTSP)	1	397552217T	
C4905	UTSP C		CE04W25V-220M(UTSP)	1	397552217T	
C4910	VR C		CE04W35V-470M(VR)	1	394664717T	
C4911	UTSP C		CE04W50V-22M(UTSP)	1	397582207T	
C4912	UTSP C		CE04W25V-220M(UTSP)	1	397552217T	
C4913	UTSP C		CE04W25V-220M(UTSP)	1	397552217T	
C4914	UTSP C		CE04W10V-470M(UTSP)	1	39754717T	
C4915	UTSP C		CE04W25V-220M(UTSP)	1	397552217T	
RESISTOR						
R4500	C-CARB ONR		RN7XK1J-331E	1	43503314R1	<B MDD>
R4501	C-CARB ONR		RN7XK1J-331E	1	43503314R1	<B MDD>
R4503	C-CARB ONR		RN7XK1J-331E	1	43503314R1	
R4504	C-CARB ONR		RN7XK1J-331E	1	43503314R1	
R4505	C-CARB ONR		RN7XK1J-331E	1	43503314R1	
R4506	C-CARB ONR		RN7XK1J-331E	1	43503314R1	
R4507	C-CARB ONR		RN7XK1J-331E	1	43503314R1	
R4508	C-CARB ONR		RN7XK1J-331E	1	43503314R1	
R4509	C-CARB ONR		RN7XK1J-331E	1	43503314R1	
R4510	C-CARB ONR		RN7XK1J-331E	1	43503314R1	
R4511	C-CARB ONR		RN7XK1J-331E	1	43503314R1	
R4512	C-CARB ONR		RN7XK1J-331E	1	43503314R1	
R4513	C-CARB ONR		RN7XK1J-331E	1	43503314R1	
R4514	C-CARB ONR		RN7XK1J-331E	1	43503314R1	
R4515	C-CARB ONR		RN7XK1J-331E	1	43503314R1	

R4516	C-CARB ONR	RN7ZK U-331E	1	43503314R1	
R4517	C-CARB ONR	RN7ZK U-331E	1	43503314R1	
R4518	C-CARB ONR	RN7ZK U-331E	1	43503314R1	
R4519	C-CARB ONR	RN7ZK U-331E	1	43503314R1	
R4520	C-CARB ONR	RN7ZK U-331E	1	43503314R1	
R4521	C-CARB ONR	RN7ZK U-331E	1	43503314R1	
R4522	C-CARB ONR	RN7ZK U-331E	1	43503314R1	
R4523	METAL O R	R S1/2WB1-22	1	443522204T	
R4524	METAL O R	R S1/2WB1-22	1	443522204T	
R4526	C-CARB ONR	RN7ZK U-101E	1	435031014R1	
R4530	C-CARB ONR	RN7ZK U-244E	1	435032244R1	<B MUD>
R4531	C-CARB ONR	RN7ZK U-244E	1	435032244R1	<B MUD>
R4533	C-CARB ONR	RN7ZK U-244E	1	435032244R1	
R4534	C-CARB ONR	RN7ZK U-244E	1	435032244R1	
R4535	C-CARB ONR	RN7ZK U-244E	1	435032244R1	
R4536	C-CARB ONR	RN7ZK U-244E	1	435032244R1	
R4537	C-CARB ONR	RN7ZK U-244E	1	435032244R1	
R4538	C-CARB ONR	RN7ZK U-244E	1	435032244R1	
R4539	C-CARB ONR	RN7ZK U-244E	1	435032244R1	
R4540	C-CARB ONR	RN7ZK U-244E	1	435032244R1	
R4541	C-CARB ONR	RN7ZK U-244E	1	435032244R1	
R4542	C-CARB ONR	RN7ZK U-244E	1	435032244R1	
R4543	C-CARB ONR	RN7ZK U-244E	1	435032244R1	
R4544	C-CARB ONR	RN7ZK U-244E	1	435032244R1	
R4545	C-CARB ONR	RN7ZK U-244E	1	435032244R1	
R4546	C-CARB ONR	RN7ZK U-244E	1	435032244R1	
R4547	C-CARB ONR	RN7ZK U-244E	1	435032244R1	
R4548	C-CARB ONR	RN7ZK U-244E	1	435032244R1	
R4549	C-CARB ONR	RN7ZK U-244E	1	435032244R1	
R4550	C-CARB ONR	RN7ZK U-244E	1	435032244R1	
R4551	C-CARB ONR	RN7ZK U-244E	1	435032244R1	
R4552	C-CARB ONR	RN7ZK U-244E	1	435032244R1	
R4560	C-CARB ONR	RN7ZK U-244E	1	435032244R1	
R4561	C-CARB ONR	RN7ZK U-244E	1	435032244R1	
R4562	C-CARB ONR	RN7ZK U-244E	1	435032244R1	
R4563	C-CARB ONR	RN7ZK U-244E	1	435032244R1	
R4564	C-CARB ONR	RN7ZK U-244E	1	435032244R1	
R4565	C-CARB ONR	RN7ZK U-244E	1	435032244R1	
R4566	C-CARB ONR	RN7ZK U-223E	1	435032234R1	
R4567	C-CARB ONR	RN7ZK U-244E	1	435032244R1	
R4570	C-CARB ONR	RN7ZK U-101E	1	435031014R1	
R4571	C-CARB ONR	RN7ZK U-101E	1	435031014R1	
R4572	C-CARB ONR	RN7ZK U-101E	1	435031014R1	
R4573	C-CARB ONR	RN7ZK U-101E	1	435031014R1	
R4574	C-CARB ONR	RN7ZK U-101E	1	435031014R1	
R4575	C-CARB ONR	RN7ZK U-101E	1	435031014R1	
R4576	C-CARB ONR	RN7ZK U-101E	1	435031014R1	

R4577	C-CARB ONR	RN7ZK U-10JE	1	435031014R1	
R4580	C-CARB ONR	RN7ZK U-24JE	1	435032244R1	<B MDC, MDF, MMA, MMP, MMQ, MMR /S MMP>
R4581	C-CARB ONR	RN7ZK U-24JE	1	435032244R1	<B MDC, MDF, MMA, MMP, MMQ, MMR /S MMP>
R4590	C-CARB ONR	RN7ZK U-10JE	1	435031014R1	<B MDC, MDF, MMA, MMP, MMQ, MMR /S MMP>
R4591	C-CARB ONR	RN7ZK U-10JE	1	435031014R1	<B MDC, MDF, MMA, MMP, MMQ, MMR /S MMP>
R4620	C-CARB ONR	RN7ZK U-24JE	1	435032244R1	
R4621	C-CARB ONR	RN7ZK U-24JE	1	435032244R1	
R4622	C-CARB ONR	RN7ZK U-24JE	1	435032244R1	
R4623	C-CARB ONR	RN7ZK U-24JE	1	435032244R1	
R4624	C-CARB ONR	RN7ZK U-24JE	1	435032244R1	
R4625	C-CARB ONR	RN7ZK U-24JE	1	435032244R1	
R4626	C-CARB ONR	RN7ZK U-22JE	1	435032234R1	
R4627	C-CARB ONR	RN7ZK U-24JE	1	435032244R1	
R4630	C-CARB ONR	RN7ZK U-12JE	1	435031214R1	
R4631	C-CARB ONR	RN7ZK U-12JE	1	435031214R1	
R4632	C-CARB ONR	RN7ZK U-12JE	1	435031214R1	
R4633	C-CARB ONR	RN7ZK U-12JE	1	435031214R1	
R4634	C-CARB ONR	RN7ZK U-12JE	1	435031214R1	
R4635	C-CARB ONR	RN7ZK U-12JE	1	435031214R1	
R4636	C-CARB ONR	RN7ZK U-12JE	1	435031214R1	
R4637	C-CARB ONR	RN7ZK U-12JE	1	435031214R1	
R4640	C-CARB ONR	RN7ZK U-10JE	1	435031014R1	
R4641	C-CARB ONR	RN7ZK U-10JE	1	435031014R1	
R4642	C-CARB ONR	RN7ZK U-10JE	1	435031014R1	
R4643	C-CARB ONR	RN7ZK U-10JE	1	435031014R1	
R4644	C-CARB ONR	RN7ZK U-10JE	1	435031014R1	
R4645	C-CARB ONR	RN7ZK U-10JE	1	435031014R1	
R4646	C-CARB ONR	RN7ZK U-10JE	1	435031014R1	
R4647	C-CARB ONR	RN7ZK U-10JE	1	435031014R1	
R4650	C-CARB ONR	RN7ZK U-24JE	1	435032244R1	
R4651	C-CARB ONR	RN7ZK U-24JE	1	435032244R1	
R4652	C-CARB ONR	RN7ZK U-24JE	1	435032244R1	
R4653	C-CARB ONR	RN7ZK U-24JE	1	435032244R1	
R4654	C-CARB ONR	RN7ZK U-24JE	1	435032244R1	
R4655	C-CARB ONR	RN7ZK U-24JE	1	435032244R1	
R4660	C-CARB ONR	RN7ZK U-39JE	1	43503914R1	
R4661	C-CARB ONR	RN7ZK U-39JE	1	43503914R1	
R4662	C-CARB ONR	RN7ZK U-39JE	1	43503914R1	
R4663	C-CARB ONR	RN7ZK U-39JE	1	43503914R1	
R4664	C-CARB ONR	RN7ZK U-39JE	1	43503914R1	
R4665	C-CARB ONR	RN7ZK U-39JE	1	43503914R1	
R4670	C-CARB ONR	RN7ZK U-24JE	1	435032244R1	
R4671	C-CARB ONR	RN7ZK U-24JE	1	435032244R1	
R4680	C-CARB ONR	RN7ZK U-102JE	1	435031024R1	
R4681	C-CARB ONR	RN7ZK U-102JE	1	435031024R1	
R4690	C-CARB ONR	RN7ZK U-222JE	1	435032244R1	
R4691	C-CARB ONR	RN7ZK U-222JE	1	435032244R1	

R4700	C-CARB ON R	RN7ZK U-101E	1	435031014R1	<B MDC, MDF, MMA, MMP, MMQ, MMR / S MNP>
R4701	C-CARB ON R	RN7ZK U-101E	1	435031014R1	<B MDC, MDF, MMA, MMP, MMQ, MMR / S MNP>
R4740	C-CARB ON R	RN7ZK U-331E	1	435033314R1	
R4741	C-CARB ON R	RN7ZK U-563E	1	435035634R1	
R4742	C-CARB ON R	RN7ZK U-474E	1	435034744R1	
R4743	C-CARB ON R	RN7ZK U-561E	1	435035614R1	
R4744	C-CARB ON R	RN7ZK U-274E	1	435032744R1	
R4745	C-CARB ON R	RN7ZK U-223E	1	435032234R1	
R4746	C-CARB ON R	RN7ZK U-122E	1	435031224R1	
R4747	C-CARB ON R	RN7ZK U-101E	1	435031014R1	
R4748	C-CARB ON R	RN7ZK U-224E	1	435032244R1	
R4749	C-CARB ON R	RN7ZK U-220E	1	435032204R1	
R4750	C-CARB ON R	RN7ZK U-531E	1	43503314R1	
R4751	C-CARB ON R	RN7ZK U-563E	1	435035634R1	
R4752	C-CARB ON R	RN7ZK U-474E	1	435034744R1	
R4753	C-CARB ON R	RN7ZK U-561E	1	435035614R1	
R4754	C-CARB ON R	RN7ZK U-274E	1	435032744R1	
R4755	C-CARB ON R	RN7ZK U-223E	1	435032234R1	
R4756	C-CARB ON R	RN7ZK U-122E	1	435031224R1	
R4757	C-CARB ON R	RN7ZK U-101E	1	435031014R1	
R4758	C-CARB ON R	RN7ZK U-224E	1	435032244R1	
R4759	C-CARB ON R	RN7ZK U-220E	1	435032204R1	
R4760	C-CARB ON R	RN7ZK U-221E	1	435032214R1	
R4761	C-CARB ON R	RN7ZK U-473E	1	435034734R1	
R4762	C-CARB ON R	RN7ZK U-681E	1	435036814R1	
R4763	C-CARB ON R	RN7ZK U-392E	1	43503924R1	
R4764	C-CARB ON R	RN7ZK U-682E	1	435036824R1	
R4765	C-CARB ON R	RN7ZK U-152E	1	435031524R1	
R4770	C-CARB ON R	RN7ZK U-223E	1	435032234R1	
R4771	C-CARB ON R	RN7ZK U-222E	1	435032224R1	
R4772	C-CARB ON R	RN7ZK U-681E	1	435036814R1	
R4773	C-CARB ON R	RN7ZK U-123E	1	435031234R1	
R4774	C-CARB ON R	RN7ZK U-103E	1	435031034R1	
R4775	C-CARB ON R	RN7ZK U-220E	1	435032204R1	
R4780	C-CARB ON R	RN7ZK U-223E	1	435032234R1	
R4781	C-CARB ON R	RN7ZK U-222E	1	435032224R1	
R4782	C-CARB ON R	RN7ZK U-681E	1	435036814R1	
R4783	C-CARB ON R	RN7ZK U-123E	1	435031234R1	
R4784	C-CARB ON R	RN7ZK U-103E	1	435031034R1	
R4785	C-CARB ON R	RN7ZK U-220E	1	435032204R1	
R4796	C-CARB ON R	RN7ZK U-101E	1	435031014R1	
R4797	C-CARB ON R	RN7ZK U-101E	1	435031014R1	
R4800	C-CARB ON R	RN7ZK U-122E	1	435031224R1	
R4801	C-CARB ON R	RN7ZK U-122E	1	435031224R1	
R4806	C-CARB ON R	RN7ZK U-000E	1	435030004R1	
R4807	C-CARB ON R	RN7ZK U-000E	1	435030004R1	
R4820	C-CARB ON R	RN7ZK U-104E	1	435031044R1	

R4821	C-CARB ONR	RN7ZK U-104JE	1	435031044R1	
R4822	C-CARB ONR	RN7ZK U-104JE	1	435031044R1	
R4823	C-CARB ONR	RN7ZK U-104JE	1	435031044R1	
R4825	C-CARB ONR	RN7ZK U-224JE	1	435032244R1	
R4826	C-CARB ONR	RN7ZK U-224JE	1	435032244R1	
R4827	C-CARB ONR	RN7ZK U-224JE	1	435032244R1	
R4829	C-CARB ONR	RN7ZK U-224JE	1	435032244R1	
R4830	C-CARB ONR	RN7ZK U-224JE	1	435032244R1	
R4831	C-CARB ONR	RN7ZK U-224JE	1	435032244R1	
R4832	C-CARB ONR	RN7ZK U-224JE	1	435032244R1	<B MDC, MDC, MMA, MNP, MMQ, MMR / S MNP>
R4833	C-CARB ONR	RN7ZK U-224JE	1	435032244R1	<B MDC, MDC, MMA, MNP, MMQ, MMR / S MNP>
R4836	C-CARB ONR	RN7ZK U-224JE	1	435032244R1	<B MDC, MDC, MMA, MNP, MMQ, MMR / S MNP>
R4839	C-CARB ONR	RN7ZK U-222JE	1	435032244R1	<B MDC, MDC, MMA, MNP, MMQ, MMR / S MNP>
R4840	C-CARB ONR	RN7ZK U-224JE	1	435032244R1	
R4841	C-CARB ONR	RN7ZK U-224JE	1	435032244R1	
R4842	C-CARB ONR	RN7ZK U-224JE	1	435032244R1	
R4843	C-CARB ONR	RN7ZK U-000JE	1	435030004R1	
R4845	C-CARB ONR	RN7ZK U-224JE	1	435032244R1	<B MDC, MDC, MMA, MNP, MMQ, MMR / S MNP>
R4846	C-CARB ONR	RN7ZK U-224JE	1	435032244R1	
R4847	C-CARB ONR	RN7ZK U-224JE	1	435032244R1	
R4850	C-CARB ONR	RN7ZK U-224JE	1	435032244R1	
R4851	C-CARB ONR	RN7ZK U-224JE	1	435032244R1	
R4853	C-CARB ONR	RN7ZK U-000JE	1	435030004R1	
R4854	C-CARB ONR	RN7ZK U-000JE	1	435030004R1	
R4900	METAL O R	RS12WB1-22	1	443622204T	
R4901	METAL O R	RS12WB1-330	1	443623314T	
R4902	C-CARB ONR	RN7ZK 2E-221JE	1	43522214R1	
R4910	METAL O R	RS1WB1-22	1	443622204T	
R4911	METAL O R	RS12WB1-330	1	443623314T	
R4912	C-CARB ONR	RN7ZK 2E-221JE	1	43522214R1	
R4921	C-CARB ONR	RN7ZK U-104JE	1	435031044R1	
R8030	C-CARB ONR	RN7ZK U-105JE	1	435031054R1	
R8031	C-CARB ONR	RN7ZK U-105JE	1	435031054R1	
R8032	C-CARB ONR	RN7ZK U-105JE	1	435031054R1	
R8033	C-CARB ONR	RN7ZK U-105JE	1	435031054R1	
NEW ITEM					
E4520	TRM-42(SCREW)	NEJITANSI ST3	1	25060495	
E4521	RETAINER	MET37-0002	1	27142009T	
IL104A	WIRE HOL	NSCT-9P880	1	25051093	<B MDC, MDC, MMA, MNP, MMQ, MMR / S MNP>
IL4518A	WIRE HOL	NSCT-5P876	1	25051089	
IL9925B	WIRE TRAP	NPLG-5P588	1	25055626	
P4500	PIN JACK	NPJ-4PDBL162	1	25045303	<B MDC>
P4500	PIN JACK	NPJ-2PDWR558	1	25045776	<B MDC, MDC, MMA, MNP, MMQ, MMR / S MNP>
P4501	PIN JACK	NPJ-6PDBL159	1	25045300	
P4502	PIN JACK	NPJ-6PDBL159	1	25045300	
P4503	PIN JACK	NPJ-4PDGRW661	1	25045890	
P4504	PIN JACK	NPJ-4PDELNT662	1	25045891	

P4505	PIN JACK	NPJ-2PDWR558	1	25045776	N
P4506	PIN JACK	NPJ-1PDG713	1	25045950	N
P4507	PIN JACK	NPJ-6FDLENTP701	1	25045935	<B MDC, MDF, MMA, MMP, MMQ, MMR / S MMP>
P4508	PIN JACK	NPJ-2PDWR558	1	25045776	
P4510A	FLUG	IMSA-9142B-20A	1	25056000	
P4511A	SOCKET	NSCT-19P2199	1	25052302	
P4512B	CRIMP AS	CRIMP SR805_2	1	20799170UL	
P4513	CRIMP AS	CRIMP AS	1	2069925120UL	
P4517B	FLUG	S16B-PH-K-S	1	25056667	N
P4519	HOLDER	HOLDER(CLAMP)	1	27150540-1	
P8000	SOCKET	MDS-15P-V02(D9UB15)	1	25053362	
P8002	SOCKET	NSCT-11P2402	1	25052505	
Q4551A	SCREW	3P+10FN(3B,C)	1	82143010GR	
Q4551B	HEAT SINK	RAD-177	1	22160517	
Q4561A	SCREW	3P+10FN(3B,C)	1	82143010GR	

PC BOARD PARTS LIST

U005	U0050~U0054	BADG-0462-1A *	1	1B248562-1A	N <B MDC, MDF>
U0050	DAC PC BOARD AS	BADG-0462-1A	1	1B2485462-1A	N <B MDC, MDF>
U0051	CPU PC BOARD AS	BACPU-0463-1A	1	1B2485463-1A	N <B MDC, MDF>
U0052	ANALOG VIDEO PC BOARD AS	BAVD-0464-1A	1	1B2485464-1A	N <B MDC, MDF>
U0053	UNIVERSAL PORT PC BOARD AS	BAETC-0466-1A	1	1B2485466-1A	N <B MDC, MDF>
U0054	FRONT USB PC BOARD AS	BADG-0468-1A	1	1B2485468-1A	N <B MDC, MDF>
U005	U0050~U0054	BADG-0462-1B *	1	1B248562-1B	N <B MMA, MMP, MMQ, MMR / S MMP>
U0050	DAC PC BOARD AS	BADG-0462-1B	1	1B2485462-1B	N <B MMA, MMP, MMQ, MMR / S MMP>
U0051	CPU PC BOARD AS	BACPU-0463-1B	1	1B2485463-1B	N <B MMA, MMP, MMQ, MMR / S MMP>
U0052	ANALOG VIDEO PC BOARD AS	BAVD-0464-1B	1	1B2485464-1B	N <B MMA, MMP, MMQ, MMR / S MMP>
U0053	UNIVERSAL PORT PC BOARD AS	BAETC-0466-1B	1	1B2485466-1B	N <B MMA, MMP, MMQ, MMR / S MMP>
U0054	FRONT USB PC BOARD AS	BADG-0468-1B	1	1B2485468-1B	N <B MMA, MMP, MMQ, MMR / S MMP>
U005	U0050~U0054	BADG-0462-1C *	1	1B248562-1C	N <B MUJ>
U0050	DAC PC BOARD AS	BADG-0462-1C	1	1B2485462-1C	N <B MUJ>
U0051	CPU PC BOARD AS	BACPU-0463-1C	1	1B2485463-1C	N <B MUJ>
U0052	ANALOG VIDEO PC BOARD AS	BAVD-0464-1C	1	1B2485464-1C	N <B MUJ>
U0053	D TERMINAL PC BOARD AS	BAVD-0465-1C	1	1B2485465-1C	N <B MUJ>
U0054	UNIVERSAL PORT PC BOARD AS	BAETC-0466-1C	1	1B2485466-1C	N <B MUJ>
U0055	FRONT USB PC BOARD AS	BADG-0468-1C	1	1B2485468-1C	<B MUJ>

CIRCUIT NO.	PART NAME	DESCRIPTION	QTY	PART NO. (SN)	REMARKS
D151	C-DIODE	KD S4148U	1	22328R2	
D151 or	C-DIODE	ISS352	(1)	22324R2	
D151 or	C-DIODE	MAA21111	(1)	22327R2	
D152	C-DIODE	KD S4148U	1	22328R2	
D152 or	C-DIODE	ISS352	(1)	22324R2	

TX-NR708

D152 or	C-DIODE	MA2111	(1)	223279R2	
D2001	C-DIODE	KD S4148U	1	223283R2	<B MDC, MDF, B MNMA, MNP, MNQ, MNR / S MNP>
D2001 or	C-DIODE	ISS352	(1)	22324R2	<B MDC, MDF, B MNMA, MNP, MNQ, MNR / S MNP>
D2001 or	C-DIODE	MA2111	(1)	223279R2	<B MDC, MDF, B MNMA, MNP, MNQ, MNR / S MNP>
D2002	C-DIODE	KD S4148U	1	223283R2	<B MDC, MDF, B MNMA, MNP, MNQ, MNR / S MNP>
D2002 or	C-DIODE	ISS352	(1)	22324R2	<B MDC, MDF, B MNMA, MNP, MNQ, MNR / S MNP>
D2002 or	C-DIODE	MA2111	(1)	223279R2	<B MDC, MDF, B MNMA, MNP, MNQ, MNR / S MNP>
D2003	C-DIODE	KD S4148U	1	223283R2	<B MDC, MDF, B MNMA, MNP, MNQ, MNR / S MNP>
D2003 or	C-DIODE	ISS352	(1)	22324R2	<B MDC, MDF, B MNMA, MNP, MNQ, MNR / S MNP>
D2003 or	C-DIODE	MA2111	(1)	223279R2	<B MDC, MDF, B MNMA, MNP, MNQ, MNR / S MNP>
D2004	ZENER D	UDZ55 6B	1	224550560R2	
D2004 or	ZENER D	MA28056-M	(1)	224750562R2	
D2006	DIODE	2B S303V17R	1	22380365R2	
D2007	DIODE	RL1N4003	1	22380260T	
D2008	DIODE	RL1N4003	1	22380260T	
D2021	DIODE	D5SBA20	1	22380130	
D2022	DIODE	D5SBA20	1	22380271F	
D2022 or	DIODE	BBV402	(1)	22380022F	
D2100	DIODE	RL1N4003	1	22380260T	<B MDC, MDF, B MNMA, MNP, MNQ, MNR / S MNP>
D2107	SPCF D	SIR-34ST3F	1	225456	<B MDC, MDF, B MNMA, MNP, MNQ, MNR / S MNP>
D2108	C-DIODE	KD S4148U	1	223283R2	<B MDC, MDF, B MNMA, MNP, MNQ, MNR / S MNP>
D2108 or	C-DIODE	ISS352	(1)	22324R2	<B MDC, MDF, B MNMA, MNP, MNQ, MNR / S MNP>
D2108 or	C-DIODE	MA2111	(1)	223279R2	<B MDC, MDF, B MNMA, MNP, MNQ, MNR / S MNP>
D2109	C-DIODE	KD S4148U	1	223283R2	<B MDC, MDF, B MNMA, MNP, MNQ, MNR / S MNP>
D2109 or	C-DIODE	ISS352	(1)	22324R2	<B MDC, MDF, B MNMA, MNP, MNQ, MNR / S MNP>
D2109 or	C-DIODE	MA2111	(1)	223279R2	<B MDC, MDF, B MNMA, MNP, MNQ, MNR / S MNP>
D2110	C-DIODE	KD S4148U	1	223283R2	<B MDC, MDF, B MNMA, MNP, MNQ, MNR / S MNP>
D2110 or	C-DIODE	ISS352	(1)	22324R2	<B MDC, MDF, B MNMA, MNP, MNQ, MNR / S MNP>
D2110 or	C-DIODE	MA2111	(1)	223279R2	<B MDC, MDF, B MNMA, MNP, MNQ, MNR / S MNP>
D2111	C-DIODE	KD S4148U	1	223283R2	<B MDC, MDF, B MNMA, MNP, MNQ, MNR / S MNP>
D2111 or	C-DIODE	ISS352	(1)	22324R2	<B MDC, MDF, B MNMA, MNP, MNQ, MNR / S MNP>
D2111 or	C-DIODE	MA2111	(1)	223279R2	<B MDC, MDF, B MNMA, MNP, MNQ, MNR / S MNP>
D2111 or	C-DIODE	MA2111	(1)	223279R2	<B MDC, MDF, B MNMA, MNP, MNQ, MNR / S MNP>
D2100	C-DIODE	KD S4148U	1	223283R2	<B MDC, MDF, B MNMA, MNP, MNQ, MNR / S MNP>
D2100 or	C-DIODE	ISS352	(1)	22324R2	<B MDC, MDF, B MNMA, MNP, MNQ, MNR / S MNP>
D2100 or	C-DIODE	MA2111	(1)	223279R2	<B MDC, MDF, B MNMA, MNP, MNQ, MNR / S MNP>
D2101	C-DIODE	KD S4148U	1	223283R2	<B MDC, MDF, B MNMA, MNP, MNQ, MNR / S MNP>
D2101 or	C-DIODE	ISS352	(1)	22324R2	<B MDC, MDF, B MNMA, MNP, MNQ, MNR / S MNP>
D2101 or	C-DIODE	MA2111	(1)	223279R2	<B MDC, MDF, B MNMA, MNP, MNQ, MNR / S MNP>
D2102	C-DIODE	KD S4148U	1	223283R2	<B MDC, MDF, B MNMA, MNP, MNQ, MNR / S MNP>
D2102 or	C-DIODE	ISS352	(1)	22324R2	<B MDC, MDF, B MNMA, MNP, MNQ, MNR / S MNP>
D2102 or	C-DIODE	MA2111	(1)	223279R2	<B MDC, MDF, B MNMA, MNP, MNQ, MNR / S MNP>
D2103	C-DIODE	KD S4148U	1	223283R2	<B MDC, MDF, B MNMA, MNP, MNQ, MNR / S MNP>
D2103 or	C-DIODE	ISS352	(1)	22324R2	<B MDC, MDF, B MNMA, MNP, MNQ, MNR / S MNP>
D2103 or	C-DIODE	MA2111	(1)	223279R2	<B MDC, MDF, B MNMA, MNP, MNQ, MNR / S MNP>
Q10	IC	N1M4580M-E	1	22241448R2	<B MDC, MDF>
Q1001	IC	C1230SSXC-1T	1	22242573R2	
Q1001 or	IC	C1230SSXC-1T	(1)	22242638R2	

Q101	IC		LC72725KV-TLM-E	1	2224258R.2	<B MIMA, MMF, MMQ, MMR / S.MMP>
Q102	IC		S-812C33AUA-CAN	1	2224222R.2	<B MIMA, MMF, MMQ, MMR / S.MMP>
Q1220	IC		NE5532APSR	1	2224228R.2	<B MII>
Q1221	IC		NJM4580M-E	1	22241448R.2	<B MII>
Q1222	IC		NE5532A.PSR	1	2224228R.2	<B MII>
Q1223	IC		NE5532A.PSR	1	2224228R.2	<B MII>
Q1224	IC		NJM4580M-E	1	22241448R.2	<B MII>
Q1225	IC		NE5532A.PSR	1	2224228R.2	<B MII>
Q1226	IC		NJM4580M-E	1	22241448R.2	<B MII>
Q1227	IC		NJM4580M-E	1	22241448R.2	<B MII>
Q1230	IC		NJM4580M-E	1	22241448R.2	<B MII>
Q1231	IC		NJM4580M-E	1	22241448R.2	<B MII>
Q1232	IC		NJM4580M-E	1	22241448R.2	<B MII>
Q1233	IC		NJM4580M-E	1	22241448R.2	<B MII>
Q1234	IC		NJM4580M-E	1	22241448R.2	<B MII>
Q1235	IC		NJM4580M-E	1	22241448R.2	<B MII>
Q1236	IC		NJM4580M-E	1	22241448R.2	<B MII>
Q1237	IC		NJM4580M-E	1	22241448R.2	<B MII>
Q1301	IC		TA4805BF(TEL,NO)	1	22278005DBR2TO	<B MII>
Q1302	IC		NJM2855DL1-33	1	22278033QR.2IR	N
Q1303	IC		TA4805BF(TEL,NO)	1	22278005DBR2TO	<B MII>
Q1311	IC		PCM9210P.TR	1	22242629R.2	<B MII>
Q1322	IC		CS5361-KZZR	1	22242646R.2	N
Q1325	IC		74HCU04F	1	222740046R.2	<B MII>
Q1421	IC		PCM1690DCAR	1	22242599R.2	<B MII>
Q1601	IC		NJM4580M-E	1	22241448R.2	<B MII>
Q1602	IC		NJM4580M-E	1	22241448R.2	<B MII>
Q1603	IC		NJM4580M-E	1	22241448R.2	<B MII>
Q1604	IC		NJM4580M-E	1	22241448R.2	<B MII>
Q1800	IC		NJM4580M-E	1	22241448R.2	<B MII>
Q1801	IC		NJM4580M-E	1	22241448R.2	<B MII>
Q2	IC		78M09HFQJNM78M09DLIA)	1	222780095R.2IR	<B MII>
Q2004	IC		MP2363DNLF-Z	1	22242627R.2	<B MII>
Q2108	IC		ICL322IEGVZ	1	22242668R.2	<B MII>
Q2109	IC		NIW1325	1	22242596R.3	<B MII>
Q2113	TR		2S854S-R	1	2217394T	<B MII>
Q2114	TR		KRC102S	1	2216190R.2	<B MII>
Q2114 or	TR		RN1402	(1)	2214470R.2	<B MII>
Q2900	IC		TC4052B REL,N,F)	1	222840521R.2TO	<B MII>
Q2901	IC		TC4052B REL,N,F)	1	222840521R.2TO	<B MII>
Q7000	TR		KRC104S	1	2216210R.2	<B MII>
Q7000 or	TR		RN1404	(1)	2214490R.2	<B MII>
Q7001 or	TR		RN1402	(1)	2216220R.2	<B MII>
Q7003	TR		KRC104S	1	2216210R.2	<B MII>
Q7003 or	TR		RN1404	(1)	2214490R.2	<B MII>
Q7004	TR		KRA102S	1	2216220R.2	<B MII>

Q7004 or	TR		RN2402	(1)	2214530R.2
Q7005	TR		KRC102S	1	2216190R.2
Q7005 or	TR		RN1402	(1)	2214470R.2
Q7006	TR		KRA107S	1	2216350R.2
Q7006 or	TR		RN2407(CE8SL_F)	(1)	2216360R.2
Q7008	TR		KRC102S	1	2216190R.2
Q7008 or	TR		RN1402	(1)	2214470R.2
Q7009	TR		KRA107S	1	2216350R.2
Q7009 or	TR		RN2407(CE8SL_F)	(1)	2216360R.2
Q7011	TR		KRC104S	1	2216210R.2
Q7011 or	TR		RN1404	(1)	2214490R.2
Q7012	TR		KRA102S	1	2216220R.2
Q7012 or	TR		RN2402	(1)	2214530R.2
Q7013	TR		KRC102S	1	2216190R.2
Q7013 or	TR		RN1402	(1)	2214470R.2
Q7014	TR		KRC104S	1	2216210R.2
Q7014 or	TR		RN1404	(1)	2214490R.2
Q7015	TR		KRA102S	1	2216220R.2
Q7015 or	TR		RN2402	(1)	2214530R.2
Q7016	TR		KRC104S	1	2216210R.2
Q7016 or	TR		RN1404	(1)	2214490R.2
Q7017	TR		KRA102S	1	2216220R.2
Q7017 or	TR		RN2402	(1)	2214530R.2
Q7018	TR		KRC104S	1	2216210R.2
Q7018 or	TR		RN1404	(1)	2214490R.2
Q7019	TR		KRA102S	1	2216220R.2
Q7019 or	TR		RN2402	(1)	2214530R.2
Q7020	IC		M6P70F3746G1-GAE-AX	1	222W0079R3
Q7021	TR		KRC104S	1	2216210R.2
Q7021 or	TR		RN1404	(1)	2214490R.2
Q7022	TR		KRA102S	1	2216220R.2
Q7022 or	TR		RN2402	(1)	2214530R.2
Q7023	IC		XG620P502R	1	2224231R.2
Q7024	TR		KRC104S	1	2216210R.2
Q7024 or	TR		RN1404	(1)	2214490R.2
Q7025	TR		KRA102S	1	2216220R.2
Q7025 or	TR		RN2402	(1)	2214530R.2
Q7026	IC		XG621B332MR	1	2224277R.2
Q7027	TR		KRC104S	1	2216210R.2
Q7027 or	TR		RN1404	(1)	2214490R.2
Q7028	TR		KRA102S	1	2216220R.2
Q7028 or	TR		RN2402	(1)	2214530R.2
Q7029	IC		S-812C33AUA-C2N	1	2224222R.2
Q7030	TR		KRC104S	1	2216210R.2
Q7030 or	TR		RN1404	(1)	2214490R.2
Q7031	TR		KRA102S	1	2216220R.2
Q7031 or	TR		RN2402	(1)	2214530R.2

Q7032	IC		S-812C56AUA-C3K	1	22242207R.2	
Q7033	IC		RIEX250644SA00A	1	22242581R.2	
Q7034	IC		NIU07706F27A3	1	22242614R.2	
Q7900	IC		NUM4580M4D	1	22241448R.2	
Q7903	IC		NUM2505AF	1	22242490R.2	
Q7903 or	IC		BH7673G-TR	(1)	22242661R.2	
Q7904	IC		XC6202P502FR	1	22242331R.2	
Q9	IC		NUM4580M4D	1	22241448R.2	<B MDC, MDF, B MMMA, MMMP, MMNQ, MMNR / S MMNP>
TRANS COIL						
L1002	CORE		NAM21608Y601BT	1	2350004R.1	
L1100	CHOKE COIL		LB02518T4R7M	1	231364M047R.2	
L1101	CHOKE COIL		LB02518T4R7M	1	231364M047R.2	
L1102	CHOKE COIL		LB02518T4R7M	1	231364M047R.2	
L1110	EMIFIL		BK1608LM182-T	1	230958R.1	
L1111	CORE		NAM21608Y601BT	1	2350004R.1	
L1301	CHOKE COIL		LB02518T470M	1	231364M0470R.2	
L1305	CHOKE COIL		LB02518T2R2M	1	231364M022R.2	
L1307	CHOKE COIL		LB02518T2R2M	1	231364M022R.2	
L1308	CHOKE COIL		LB02518T2R2M	1	231364M022R.2	
L1312	CHOKE COIL		LB02518T470M	1	231364M0470R.2	
L1313	CHOKE COIL		LB02518T470M	1	231364M0470R.2	
L1319	CHOKE COIL		LB02518T470M	1	231364M0470R.2	
L1323	EMIFIL		BK1608HS102-T	1	230958R.2	
L1324	EMIFIL		BK1608HS102-T	1	230958R.2	
L1325	EMIFIL		BK1608HS102-T	1	230958R.2	
L1326	CHOKE COIL		LB02518T470M	1	231364M0470R.2	
L1336	CHOKE COIL		LB02518T470M	1	231364M0470R.2	
L1404	CHOKE COIL		LB02518T4R7M	1	231364M047R.2	
L1407	CHOKE COIL		LB02518T4R7M	1	231364M047R.2	
L150	CORE		BLM18PG121SNID	1	2350006R.1	
L151	CORE		BLM18PG121SNID	1	2350006R.1	
L152	CORE		BLM18PG121SNID	1	2350006R.1	
L2004	CHOKE COIL		BLM21PG221SNI	1	230949R.2	
L2005	CHOKE COIL		BLM21PG221SNI	1	230949R.2	
L2006	CHOKE COIL		BLM21PG221SNI	1	230949R.2	
L2012	CHOKE COIL		0182-7E08Q-100M4RA	1	231396M100R.2	
L2101	CHOKE COIL		LB02518T470M	1	231364M0470R.2	
L2104	EMIFIL		BK1608LM182-T	1	230958R.1	<B MDC, MDF, B MMMA, MMMP, MMNQ, MMNR / S MMNP>
L2105	EMIFIL		BK1608LM182-T	1	230958R.1	<B MDC, MDF, B MMMA, MMMP, MMNQ, MMNR / S MMNP>
L2106	CHOKE COIL		LB02518T4R7M	1	231364M047R.2	
L5	CHOKE COIL		LB02518T100M	1	231364M100R.2	<B MDC, MDF, B MMMA, MMMP, MMNQ, MMNR / S MMNP>
L7001	CHOKE COIL		BLM21PG221SNI	1	230949R.2	
L7900	EMIFIL		BK1608LM182-T	1	230958R.1	
L7901	EMIFIL		BK1608LM182-T	1	230958R.1	
L7902	EMIFIL		BK1608LM182-T	1	230958R.1	
L7903	EMIFIL		BK1608LM182-T	1	230958R.1	
L7904	EMIFIL		BK1608LM182-T	1	230958R.1	

L7905	EMF.L	BK1608LM182-T	1	230958R.1	
L7906	EMF.L	BK1608LM182-T	1	230958R.1	
L7907	EMF.L	BK1608LM182-T	1	230958R.1	
L7908	EMF.L	BK1608LM182-T	1	230958R.1	
L7909	EMF.L	BK1608LM182-T	1	230958R.1	
L7910	EMF.L	BK1608LM182-T	1	230958R.1	
L7911	EMF.L	BK1608LM182-T	1	230958R.1	
L7912	EMF.L	BK1608LM182-T	1	230958R.1	
L7913	EMF.L	BK1608LM182-T	1	230958R.1	
L7914	CHOKE COIL	BLM21PG211SN1	1	230949R.2	
L7917	CHOKE COIL	BLM21PG211SN1	1	230949R.2	
L7918	EMF.L	BK1608LM182-T	1	230958R.1	
L7919	EMF.L	BK1608LM182-T	1	230958R.1	
L7920	CHOKE COIL	BLM21PG211SN1	1	230949R.2	
L7921	CHOKE COIL	BLM21PG211SN1	1	230949R.2	
X101	CRYSTAL	HC-49S 4 33MHz	1	3010469T	
X1100	CRYSTAL	HC-49US24 57.6MHz	1	3010490T	
X7000	CERA LOCK	CSTCR 5M00053-B0	1	3010356R.2	
CAPACITORS					
C1	UTSP C	CE04W50V-10M(UTSP)	1	397581007T	<B MDC, MDP, B MMA, MMP, MMQ, MMR / S MNP>
C1001	C-CERA C	CK725B0J-106K	1	332091065R.2	
C1002	C-CERA C	CK725F1E-104Z1	1	332161040R.1	
C101	C-CERA C	CC725CH1H-221J1	1	342102214R.1	<B MMA, MNP, MMQ, MMR / S MNP>
C102	C-CERA C	CC725CH1H-331J1	1	342103314R.1	<B MMA, MNP, MMQ, MMR / S MNP>
C103	UTSP C	CE04W50V-10M(UTSP)	1	397581007T	<B MMA, MNP, MMQ, MMR / S MNP>
C104	UTSP C	CE04W50V-10M(UTSP)	1	397581007T	<B MMA, MNP, MMQ, MMR / S MNP>
C105	C-CERA C	CK725B1H-103K1	1	332101035R.1	<B MMA, MNP, MMQ, MMR / S MNP>
C106	C-CERA C	CC725CH1H-331J1	1	342103314R.1	<B MMA, MNP, MMQ, MMR / S MNP>
C107	C-CERA C	CK725F1E-104Z1	1	332161040R.1	<B MMA, MNP, MMQ, MMR / S MNP>
C108	C-CERA C	CC725CH1H-150J1	1	342101504R.1	<B MMA, MNP, MMQ, MMR / S MNP>
C109	C-CERA C	CC725CH1H-150J1	1	342101504R.1	<B MMA, MNP, MMQ, MMR / S MNP>
C110	C-CERA C	CK725F1A-105Z1	1	332181050R.1	<B MMA, MNP, MMQ, MMR / S MNP>
C1100	C-CERA C	CK725F1E-104Z1	1	332161040R.1	
C1101	C-CERA C	CC725CH1H-180J1	1	342101804R.1	
C1102	C-CERA C	CC725CH1H-180J1	1	342101804R.1	
C1103	UTSP C	CE04W10V-470M(UTSP)	1	397534717T	
C1104	C-CERA C	CK725B1H-473K1	1	332104735R.1	
C1105	C-CERA C	CK725B1H-223K1	1	332102235R.1	
C1106	UTSI C	CE04W25V-47M(UTSD)	1	398054707A.T	
C1107	C-CERA C	CK725F1E-104Z1	1	332161040R.1	
C1108	UTSP C	CE04W10V-470M(UTSP)	1	397534717T	
C1109	C-CERA C	CK725B1H-473K1	1	332104735R.1	
C1110	UTSP C	CE04W10V-470M(UTSP)	1	397534717T	
C1111	C-CERA C	CC725CH1H-330J1	1	342103304R.1	
C1113	C-CERA C	CK725F1E-104Z1	1	332161040R.1	
C1116	C-CERA C	CC725CH1H-330J1	1	342103304R.1	
C1117	C-CERA C	CC725CH1H-330J1	1	342103304R.1	

C1119	C-OERA C	CG725CHIH-221J1	1	342102214R1	<B MUI>
C1120	UTSP C	CE04W25V 47M(UTSD)	1	398054707AT	<B MUI>
C1121	C-OERA C	CG725CHIH-221J1	1	342102214R1	<B MUI>
C1122	C-OERA C	CK725FIE-104Z1	1	332161040R1	<B MUI>
C1125	C-OERA C	CG725CHIH-330J1	1	342103304R1	<B MUI>
C1141	UTSP C	CE04W25V 47M(UTSD)	1	398054707AT	<B MUI>
C1230	C-OERA C	CG725CHIH-221J1	1	342102214R1	<B MUI>
C1250	C-FLLM C	ECHU16V-682J	1	373046824R2	<B MUI>
C1251	C-FLLM C	ECHU16V-682J	1	373046824R2	<B MUI>
C1252	C-FLLM C	ECHU16V-682J	1	373046824R2	<B MUI>
C1253	C-FLLM C	ECHU16V-682J	1	373046824R2	<B MUI>
C1254	C-FLLM C	ECHU16V-682J	1	373046824R2	<B MUI>
C1255	C-FLLM C	ECHU16V-682J	1	373046824R2	<B MUI>
C1256	C-FLLM C	ECHU16V-682J	1	373046824R2	<B MUI>
C1257	C-FLLM C	ECHU16V-682J	1	373046824R2	<B MUI>
C1260	C-FLLM C	ECHU50V-221J	1	373022214R2	<B MUI>
C1261	C-FLLM C	ECHU50V-221J	1	373022214R2	<B MUI>
C1262	C-FLLM C	ECHU50V-221J	1	373022214R2	<B MUI>
C1263	C-FLLM C	ECHU50V-221J	1	373022214R2	<B MUI>
C1264	C-FLLM C	ECHU50V-221J	1	373022214R2	<B MUI>
C1265	C-FLLM C	ECHU50V-221J	1	373022214R2	<B MUI>
C1266	C-FLLM C	ECHU50V-221J	1	373022214R2	<B MUI>
C1267	C-FLLM C	ECHU50V-221J	1	373022214R2	<B MUI>
C1270	C-FLLM C	ECHU50V-101J	1	373021014R2	<B MUI>
C1271	C-FLLM C	ECHU50V-101J	1	373021014R2	<B MUI>
C1272	C-FLLM C	ECHU50V-101J	1	373021014R2	<B MUI>
C1273	C-FLLM C	ECHU50V-101J	1	373021014R2	<B MUI>
C1274	C-FLLM C	ECHU50V-101J	1	373021014R2	<B MUI>
C1275	C-FLLM C	ECHU50V-101J	1	373021014R2	<B MUI>
C1276	C-FLLM C	ECHU50V-101J	1	373021014R2	<B MUI>
C1277	C-FLLM C	ECHU50V-101J	1	373021014R2	<B MUI>
C1280	C-FLLM C	ECHU50V-222J	1	373022224R2	<B MUI>
C1281	C-FLLM C	ECHU50V-222J	1	373022224R2	<B MUI>
C1282	C-FLLM C	ECHU50V-222J	1	373022224R2	<B MUI>
C1283	C-FLLM C	ECHU50V-222J	1	373022224R2	<B MUI>
C1284	C-FLLM C	ECHU50V-222J	1	373022224R2	<B MUI>
C1285	C-FLLM C	ECHU50V-222J	1	373022224R2	<B MUI>
C1286	C-FLLM C	ECHU50V-222J	1	373022224R2	<B MUI>
C1287	C-FLLM C	ECHU50V-222J	1	373022224R2	<B MUI>
C1303	UTSP C	CE04W50V 47M(UTSP)	1	397584707T	<B MUI>
C1304	C-OERA C	CG725CHIH-680J1	1	342106804R1	<B MUI>
C1305	VR C	CE04W16V-100M(VR)	1	394641017T	<B MUI>
C1306	C-OERA C	CG725CHIH-680J1	1	342106804R1	<B MUI>
C1307	UTSP C	CE04W50V 47M(UTSP)	1	397584707T	<B MUI>
C1308	C-FLLM C	ECHU50V-222J	1	373022224R2	<B MUI>
C1309	C-OERA C	CG725CHIH-680J1	1	342106804R1	<B MUI>
C1310	VR C	CE04W16V-100M(VR)	1	394641017T	<B MUI>

C1312	UTSP C	CE04W10V-470M(UTSP)	1	397534717T	<B MLI>
C1313	C-CERA C	CC725CH1H-68011	1	342106804R1	<B MLI>
C1314	C-CERA C	CC725CH1H-68011	1	342106804R1	<B MLI>
C1321	C-CERA C	CK725F1E-104Z1	1	332161040R1	<B MLI>
C1331	C-CERA C	CK725F1E-104Z1	1	332161040R1	<B MLI>
C1332	UTSP C	CE04W10V-470M(UTSP)	1	397534717T	<B MLI>
C1333	UTSP C	CE04W50V-47M(UTSP)	1	397584707T	<B MLI>
C1335	VR C	CE04W16V-100M(VR)	1	394641017T	<B MLI>
C1365	C-CERA C	CK725F1E-104Z1	1	332161040R1	<B MLI>
C1366	C-CERA C	CC725CH1H-10111	1	342101014R1	<B MLI>
C1368	C-CERA C	CC725CH1H-10111	1	342101014R1	<B MLI>
C1375	C-CERA C	CK725F1E-104Z1	1	332161040R1	<B MLI>
C1380	C-CERA C	CK725F1E-104Z1	1	332161040R1	<B MLI>
C1381	C-CERA C	CC725CH1H-10111	1	342101014R1	<B MLI>
C1385	C-CERA C	CK725B1H-102K1	1	332101025R1	<B MLI>
C1389	UTSP C	CE04W10V-470M(UTSP)	1	397534717T	<B MLI>
C1390	UTSP C	CE04W10V-470M(UTSP)	1	397534717T	<B MLI>
C1391	C-CERA C	CK725F1E-104Z1	1	332161040R1	<B MLI>
C1399	VR C	CE04W16V-100M(VR)	1	394641017T	<B MLI>
C1400	C-CERA C	CK725F1E-104Z1	1	332161040R1	<B MLI>
C1401	C-CERA C	CK725F1E-104Z1	1	332161040R1	<B MLI>
C1408	C-CERA C	CC725CH1H-080D1	1	342100802R1	<B MLI>
C1409	C-CERA C	CC725CH1H-080D1	1	342100802R1	<B MLI>
C1415	C-CERA C	CK725F1E-104Z1	1	332161040R1	<B MLI>
C1417	C-CERA C	CK725F1E-104Z1	1	332161040R1	<B MLI>
C1419	C-CERA C	CC725CH1H-080D1	1	342100802R1	<B MLI>
C1421	UTSP C	CE04W10V-220M(UTSP)	1	397532117T	<B MLI>
C1440	UTSP C	CE04W10V-470M(UTSP)	1	397534717T	<B MLI>
C1456	C-FILM C	ECHU16V-104J	1	373041044R2	<B MLI>
C1464	C-FILM C	ECHU16V-104J	1	373041044R2	<B MLI>
C1465	C-FILM C	ECHU16V-104J	1	373041044R2	<B MLI>
C1499	UTSP C	CE04W10V-100M(UTSP)	1	397531017T	<B MLI>
C151	C-FILM C	ECHU16V-104J	1	373041044R2	<B MLI>
C1582	C-CERA C	CC725CH1H-68011	1	342106804R1	<B MLI>
C1583	C-FILM C	ECHU50V-22J	1	37302224R2	<B MLI>
C1600	MKT C	B 32529C0102J289	1	376491024T	<B MLI>
C1600	MKT C	B 32529C022J289	1	37649224T	<B MLI>
C1601	MKT C	B 32529C0102J289	1	376491024T	<B MLI>
C1601	MKT C	B 32529C022J289	1	37649224T	<B MLI>
C1602	MKT C	B 32529C0102J289	1	376491024T	<B MLI>
C1602	MKT C	B 32529C022J289	1	37649224T	<B MLI>
C1603	MKT C	B 32529C0102J289	1	376491024T	<B MLI>
C1603	MKT C	B 32529C022J289	1	37649224T	<B MLI>
C1604	MKT C	B 32529C0102J289	1	376491024T	<B MLI>
C1604	MKT C	B 32529C022J289	1	37649224T	<B MLI>
C1605	MKT C	B 32529C0102J289	1	376491024T	<B MLI>
C1605	MKT C	B 32529C022J289	1	37649224T	<B MLI>

C1606	MKT C		B 32529C0102J289	1	376491024T	<B MDC, MDF, B MNMA, MNP, MNQ, MNR / S MNP>
C1606	MKT C		B 32529C022J289	1	376492224T	<B MJI>
C1607	MKT C		B 32529C0102J289	1	376491024T	<B MDC, MDF, B MNMA, MNP, MNQ, MNR / S MNP>
C1607	MKT C		B 32529C022J289	1	376492224T	<B MJI>
C1610	UPZ C		2A UPZ TF10JE	1	376331014T	<B MDC, MDF, B MNMA, MNP, MNQ, MNR / S MNP>
C1610	UPZ C		2A UPZ TF21JE	1	376332214T	<B MJI>
C1611	UPZ C		2A UPZ TF10JE	1	376331014T	<B MDC, MDF, B MNMA, MNP, MNQ, MNR / S MNP>
C1611	UPZ C		2A UPZ TF21JE	1	376332214T	<B MJI>
C1612	UPZ C		2A UPZ TF10JE	1	376331014T	<B MDC, MDF, B MNMA, MNP, MNQ, MNR / S MNP>
C1612	UPZ C		2A UPZ TF21JE	1	376332214T	<B MJI>
C1613	UPZ C		2A UPZ TF10JE	1	376331014T	<B MDC, MDF, B MNMA, MNP, MNQ, MNR / S MNP>
C1613	UPZ C		2A UPZ TF21JE	1	376332214T	<B MJI>
C1614	UPZ C		2A UPZ TF10JE	1	376331014T	<B MDC, MDF, B MNMA, MNP, MNQ, MNR / S MNP>
C1614	UPZ C		2A UPZ TF21JE	1	376332214T	<B MJI>
C1615	UPZ C		2A UPZ TF10JE	1	376331014T	<B MDC, MDF, B MNMA, MNP, MNQ, MNR / S MNP>
C1615	UPZ C		2A UPZ TF21JE	1	376332214T	<B MJI>
C1616	UPZ C		2A UPZ TF10JE	1	376331014T	<B MDC, MDF, B MNMA, MNP, MNQ, MNR / S MNP>
C1616	UPZ C		2A UPZ TF21JE	1	376332214T	<B MJI>
C1617	UPZ C		2A UPZ TF10JE	1	376331014T	<B MDC, MDF, B MNMA, MNP, MNQ, MNR / S MNP>
C1617	UPZ C		2A UPZ TF21JE	1	376332214T	<B MJI>
C1620	UPZ C		2A UPZ TF10JE	1	376331014T	<B MDC, MDF, B MNMA, MNP, MNQ, MNR / S MNP>
C1620	UPZ C		2A UPZ TF21JE	1	376332214T	<B MJI>
C1621	UPZ C		2A UPZ TF10JE	1	376331014T	<B MDC, MDF, B MNMA, MNP, MNQ, MNR / S MNP>
C1621	UPZ C		2A UPZ TF21JE	1	376332214T	<B MJI>
C1622	UPZ C		2A UPZ TF10JE	1	376331014T	<B MDC, MDF, B MNMA, MNP, MNQ, MNR / S MNP>
C1622	UPZ C		2A UPZ TF21JE	1	376332214T	<B MJI>
C1623	UPZ C		2A UPZ TF10JE	1	376331014T	<B MDC, MDF, B MNMA, MNP, MNQ, MNR / S MNP>
C1623	UPZ C		2A UPZ TF21JE	1	376332214T	<B MJI>
C1624	UPZ C		2A UPZ TF10JE	1	376331014T	<B MDC, MDF, B MNMA, MNP, MNQ, MNR / S MNP>
C1624	UPZ C		2A UPZ TF21JE	1	376332214T	<B MJI>
C1625	UPZ C		2A UPZ TF10JE	1	376331014T	<B MDC, MDF, B MNMA, MNP, MNQ, MNR / S MNP>
C1625	UPZ C		2A UPZ TF21JE	1	376332214T	<B MJI>
C1626	UPZ C		2A UPZ TF10JE	1	376331014T	<B MDC, MDF, B MNMA, MNP, MNQ, MNR / S MNP>
C1626	UPZ C		2A UPZ TF21JE	1	376332214T	<B MJI>
C1627	UPZ C		2A UPZ TF10JE	1	376331014T	<B MDC, MDF, B MNMA, MNP, MNQ, MNR / S MNP>
C1627	UPZ C		2A UPZ TF21JE	1	376332214T	<B MJI>
C1650	UTSP C		CE04W 25V 470M(UTSP)	1	397554717T	<B MDC, MDF, B MNMA, MNP, MNQ, MNR / S MNP>
C1651	UTSP C		CE04W 25V 470M(UTSP)	1	397554717T	<B MJI>
C1800	UTSP C		CE04W 25V 47M(UTSP)	1	397554707T	<B MDC, MDF, B MNMA, MNP, MNQ, MNR / S MNP>
C1801	UTSP C		CE04W 25V 47M(UTSP)	1	397554707T	<B MJI>
C1810	UTSP C		CE04W 25V 47M(UTSP)	1	397554707T	<B MDC, MDF, B MNMA, MNP, MNQ, MNR / S MNP>
C1811	UTSP C		CE04W 25V 47M(UTSP)	1	397554707T	<B MJI>
C2	VR C		CE04W 16V 100M(VR)	1	394641017T	<B MDC, MDF, B MNMA, MNP, MNQ, MNR / S MNP>
C2000	TF C		ECQ-V50V-334J	1	374323344T	<B MJI>
C2002	TF C		ECQ-V50V-334J	1	374723344T	<B MJI>
C2004	UTSP C		CE04W 50V 47M(UTSP)	1	397580477T	<B MDC, MDF, B MNMA, MNP, MNQ, MNR / S MNP>
C2005	ELECT C		CE04W 18V 1000M(VZ)	1	3945H1037S	<B MJI>

C2017	C-CERA C	CK725F1E-104Z1	1	332161040R1	
C2018	C-CERA C	CK725F1E-104Z1	1	332161040R1	
C2019	C-CERA C	CK725B1E-106K	1	33221065R2	
C2020	C-CERA C	CK725B1E-106K	1	33221065R2	
C2022	C-CERA C	CK725B1E-106K	1	33221065R2	
C2023	C-CERA C	CK725B1E-106K	1	33221065R2	
C2024	C-CERA C	CK725F1A-105Z1	1	332181050R1	
C2025	VR C	CE04W16V-100M(VR)	1	394641017T	
C2026	C-CERA C	CK725B1H-103K1	1	332101035R1	
C2027	VR C	CE04W16V-100M(VR)	1	394641017T	
C2029	VR C	CE04W16V-470M(VR)	1	394644727S	
C2044	C-CERA C	CK725B1E-106K	1	33221065R2	
C2115	UTSP C	CE04W50V-10M(UTSP)	1	397581007T	
C2116	UTSP C	CE04W50V-2-2M(UTSP)	1	397580227T	
C2121	C-CERA C	CK725B01-106K	1	332091065R2	<B MUX>
C2122	C-CERA C	CK725B01-106K	1	332091065R2	<B MUX>
C2127	C-CERA C	CK725B1H-103K1	1	332101025R1	
C2128	UTSP C	CE04W50V-2-2M(UTSP)	1	397580227T	
C2130	C-CERA C	CK725B01-106K	1	332091065R2	<B MUX>
C2131	C-CERA C	CK725B01-106K	1	332091065R2	<B MUX>
C2137	C-CERA C	CK725F1E-104Z1	1	332161040R1	
C2138	UTSP C	CE04W50V-2-2M(UTSP)	1	397580227T	
C2144	UTSP C	CE04W50V-2-2M(UTSP)	1	397580227T	
C2147	C-CERA C	CK725B1H-103K1	1	332101025R1	
C2148	UTSP C	CE04W50V-1M(UTSP)	1	397580107T	
C2149	VR C	CE04W6-3V-470M(VR)	1	394624717T	<B MUX>
C2150	UTSP C	CE04W50V-2-2M(UTSP)	1	397580227T	
C2153	C-CERA C	CK725F1E-104Z1	1	332161040R1	
C2159	UTSP C	CE04W25V-47M(UTSP)	1	397554707T	
C2160	C-CERA C	CK725B01-106K	1	332091065R2	<B MUX>
C2161	UTSP C	CE04W50V-2-2M(UTSP)	1	397580227T	
C2162	VR C	CE04W6-3V-470M(VR)	1	394624717T	
C2169	VR C	CE04W6-3V-470M(VR)	1	394624717T	<B MUX>
C2175	VR C	CE04W6-3V-470M(VR)	1	394624717T	<B MUX>
C2176	C-CERA C	CK725B01-106K	1	332091065R2	
C2178	UTSP C	CE04W50V-2-2M(UTSP)	1	397580227T	
C2179	UTSP C	CE04W25V-47M(UTSP)	1	397554707T	
C2180	C-CERA C	CK725F1E-104Z1	1	332161040R1	
C2181	VR C	CE04W6-3V-470M(VR)	1	394624717T	
C2182	C-CERA C	CK725B1H-103K1	1	332101035R1	
C2184	VR C	CE04W6-3V-470M(VR)	1	394624717T	
C2185	UTSP C	CE04W50V-22M(UTSP)	1	397582207T	
C2188	VR C	CE04W6-3V-470M(VR)	1	394624717T	<B MUX>
C2189	UTSP C	CE04W50V-1M(UTSP)	1	397580107T	
C2190	VR C	CE04W6-3V-470M(VR)	1	394624717T	
C2191	VR C	CE04W6-3V-470M(VR)	1	394624717T	
C2193	UTSP C	CE04W25V-47M(UTSP)	1	397554707T	

C2194	C-CERA C	CK725F1E-104Z1	1	332161040R1	
C2195	UTSP C	CE04W50V-1M(UTSP)	1	397580107T	
C2196	UTSP C	CE04W25V-47M(UTSP)	1	397554707T	
C2198	C-CERA C	CK725F1E-104Z1	1	332161040R1	
C2199	C-CERA C	CK725F1E-104Z1	1	332161040R1	
C2200	VR C	CE04W16V-100M(VR)	1	394641017T	
C2201	C-CERA C	CK725F1E-104Z1	1	332161040R1	
C2202	UTSP C	CE04W50V-1M(UTSP)	1	397580107T	
C2203	UTSP C	CE04W25V-47M(UTSP)	1	397554707T	
C2204	VR C	CE04W6 3V-470M(VR)	1	394624717T	
C2205	C-CERA C	CK725B1H-102K1	1	332101025R1	
C2206	UTSP C	CE04W50V-1M(UTSP)	1	397580107T	
C2207	VR C	CE04W6 3V-470M(VR)	1	394624717T	
C2208	UTSP C	CE04W25V-47M(UTSP)	1	397554707T	
C2210	VR C	CE04W6 3V-470M(VR)	1	394624717T	
C2212	C-CERA C	CK725B1H-102K1	1	332101025R1	
C2213	VR C	CE04W6 3V-470M(VR)	1	394624717T	
C2214	VR C	CE04W6 3V-470M(VR)	1	394624717T	
C2216	UTSP C	CE04W25V-47M(UTSP)	1	397554707T	
C2217	C-CERA C	CK725F1E-104Z1	1	332161040R1	
C2219	VR C	CE04W6 3V-470M(VR)	1	394624717T	
C2222	VR C	CE04W6 3V-470M(VR)	1	394624717T	
C2224	VR C	CE04W6 3V-470M(VR)	1	394624717T	
C2226	VR C	CE04W6 3V-470M(VR)	1	394624717T	
C2231	C-CERA C	CK725F1E-104Z1	1	332161040R1	
C2233	UTSP C	CE04W50V-1M(UTSP)	1	397580107T	
C2234	UTSP C	CE04W50V-1M(UTSP)	1	397580107T	
C2235	UTSP C	CE04W25V-47M(UTSP)	1	397554707T	
C2237	C-CERA C	CK725B1A-105K1	1	332131055R1	
C2238	UTSP C	CE04W50V-1M(UTSP)	1	397580107T	
C2239	UTSP C	CE04W25V-47M(UTSP)	1	397554707T	
C2240	C-CERA C	CK725F1E-104Z1	1	332161040R1	
C2241	UTSP C	CE04W50V-2 2M(UTSP)	1	397580227T	
C2242	C-CERA C	CK725F1E-104Z1	1	332161040R1	
C2243	C-CERA C	CK725F1E-104Z1	1	332161040R1	
C2244	VR C	CE04W6 3V-220M(VR)	1	394622217T	<B MDC, MDF, B MMA, MNP, MMQ, MMR / S MNP>
C2246	C-CERA C	CK725B1H-102K1	1	332101025R1	<B MDC, MDF, B MMA, MNP, MMQ, MMR / S MNP>
C2247	C-CERA C	CK725B1H-102K1	1	332101025R1	
C2248	C-CERA C	CK725B1A-105K1	1	332131055R1	
C2249	UTSP C	CE04W50V-1M(UTSP)	1	397580107T	
C2251	C-CERA C	CK725CH1H-101J1	1	342101014R1	<B MDC, MDF, B MMA, MNP, MMQ, MMR / S MNP>
C2252	UTSP C	CE04W50V-2 2M(UTSP)	1	397580227T	
C2255	C-CERA C	CK725CH1H-151J1	1	342101514R1	
C2256	C-CERA C	CK725CH1H-151J1	1	342101514R1	
C2257	C-CERA C	CK725CH1H-151J1	1	342101514R1	
C2258	C-CERA C	CK725B1H-102K1	1	332101025R1	
C2259	C-CERA C	CK725B1A-105K1	1	332131055R1	

C2260	UTSP C	CE04W50V-1M(UTSP)	1	397580107T	<B MDD>
C2261	C-CERA C	CE04W50V-101J1	1	342101014R1	<B MDD>
C2262	UTSP C	CE04W50V-2-2M(UTSP)	1	397580227T	<B MDD>
C2263	C-CERA C	CE04W50V-104Z1	1	332161040R1	<B MDD>
C2265	C-CERA C	CE04W50V-105K1	1	332131055R1	<B MDD>
C2267	UTSP C	CE04W50V-1M(UTSP)	1	397580107T	<B MDD>
C2268	UTSP C	CE04W50V-2-2M(UTSP)	1	397580227T	<B MDD>
C2270	C-CERA C	CE04W50V-102K1	1	332101025R1	<B MDD>
C2280	C-CERA C	CE04W50V-105Z1	1	342101051R1	<B MDD>
C2281	C-CERA C	CE04W50V-105Z1	1	342101051R1	<B MDD>
C2282	C-CERA C	CE04W50V-105Z1	1	342101051R1	<B MDD>
C2287	C-CERA C	CE04W50V-104Z1	1	332161040R1	<B MDD>
C2900	ELECT C	CE04W50V-3V-100M	1	35721019T	<B MDD>
C2901	C-CERA C	CE04W50V-104Z1	1	332161040R1	<B MDD>
C2902	C-CERA C	CE04W50V-104Z1	1	332161040R1	<B MDD>
C2903	C-CERA C	CE04W50V-104Z1	1	342102204R1	<B MDD>
C2904	C-CERA C	CE04W50V-104Z1	1	342102204R1	<B MDD>
C2905	C-CERA C	CE04W50V-104Z1	1	342102204R1	<B MDD>
C2906	C-CERA C	CE04W50V-102K1	1	332101025R1	<B MDD>
C2907	C-CERA C	CE04W50V-102K1	1	332101025R1	<B MDD>
C2908	C-CERA C	CE04W50V-102K1	1	332101025R1	<B MDD>
C45	UTSP C	CE04W25V-220M(UTSP)	1	397552217T	<B MDD>
C46	UTSP C	CE04W25V-220M(UTSP)	1	397552217T	<B MDD>
C47	ELECT C	CE04W35V-10M(S)	1	353761009T	<B MDD>
C48	ELECT C	CE04W35V-10M(S)	1	353761009T	<B MDD>
C49	C-CERA C	CE04W50V-102K1	1	332101025R1	<B MDD>
C52	UTSP C	CE04W50V-10M(UTSP)	1	397581007T	<B MDD>
C53	UTSP C	CE04W50V-10M(UTSP)	1	397581007T	<B MDD>
C55	C-CERA C	CE04W50V-101J1	1	342101014R1	<B MDD>
C56	C-CERA C	CE04W50V-101J1	1	342101014R1	<B MDD>
C57	C-CERA C	CE04W50V-101J1	1	342101014R1	<B MDD>
C58	C-CERA C	CE04W50V-101J1	1	342101014R1	<B MDD>
C7	UTSP C	CE04W25V-47M(UTSP)	1	397554707T	<B MDD>
C7000	C-CERA C	CE04W50V-105Z1	1	332181050R1	<B MDD>
C7004	C-CERA C	CE04W50V-105Z1	1	332181050R1	<B MDD>
C7008	C-CERA C	CE04W50V-104Z1	1	332161040R1	<B MDD>
C7009	C-CERA C	CE04W50V-105Z1	1	332181050R1	<B MDD>
C7010	C-CERA C	CE04W50V-101J1	1	342101014R1	<B MDD>
C7011	C-CERA C	CE04W50V-101J1	1	342101014R1	<B MDD>
C7013	C-CERA C	CE04W50V-105Z1	1	332181050R1	<B MDD>
C7015	C-CERA C	CE04W50V-105Z1	1	332181050R1	<B MDD>
C7016	C-CERA C	CE04W50V-105Z1	1	332181050R1	<B MDD>
C7017	C-CERA C	CE04W50V-105Z1	1	332181050R1	<B MDD>
C7018	UTSP C	CE04W25V-100M(UTSP)	1	397551017T	<B MDD>
C7020	UTSP C	CE04W10V-100M(UTSP)	1	397531017T	<B MDD>
C7021	UTSP C	CE04W10V-100M(UTSP)	1	397531017T	<B MDD>
C7022	C-CERA C	CE04W50V-105Z1	1	332181050R1	<B MDD>

C7023	C-CERA C	CK725F1A-105Z1	1	332181050R1
C7024	C-CERA C	CK725B1H-102K1	1	332101025R1
C7025	C-CERA C	CK725B1H-102K1	1	332101025R1
C7026	C-CERA C	CK725F1A-105Z1	1	332181050R1
C7027	UTSP C	CE04W50V-10M(UTSP)	1	397581007T
C7028	UTSP C	CE04W10V-100M(UTSP)	1	397531017T
C7029	C-CERA C	CK725F1E-104Z1	1	332161040R1
C7030	C-CERA C	CK725F1E-104Z1	1	332161040R1
C7031	C-CERA C	CK725B0U-106K	1	332091065R2
C7032	C-CERA C	CK725B1H-102K1	1	332101025R1
C7033	C-CERA C	CK725B1H-102K1	1	332101025R1
C7034	C-CERA C	CK725B1H-102K1	1	332101025R1
C7035	C-CERA C	CK725B1H-102K1	1	332101025R1
C7036	C-CERA C	CK725F1E-104Z1	1	332161040R1
C7037	C-CERA C	CK725F1E-104Z1	1	332161040R1
C7038	C-CERA C	CK725F1E-104Z1	1	332161040R1
C7039	C-CERA C	CK725B1H-102K1	1	332101025R1
C7040	C-CERA C	CK725B1H-102K1	1	332101025R1
C7041	C-CERA C	CK725F1E-104Z1	1	332161040R1
C7042	C-CERA C	CK725F1E-104Z1	1	332161040R1
C7043	C-CERA C	CK725F1E-104Z1	1	332161040R1
C7044	C-CERA C	CK725F1E-104Z1	1	332161040R1
C7045	C-CERA C	CK725F1A-105Z1	1	332181050R1
C7046	UTSP C	CE04W50V-10M(UTSP)	1	397581007T
C7047	UTSP C	CE04W10V-470M(UTSP)	1	39754717T
C7048	C-CERA C	CK725F1E-104Z1	1	332161040R1
C7049	ELECT C	CE04W16V-10M	1	355741009T
C7051	C-CERA C	CK725CH1H-101J1	1	342101014R1
C7054	C-CERA C	CK725F1E-104Z1	1	332161040R1
C7900	UTSP C	CE04W50V-10M(UTSP)	1	397581007T
C7903	C-CERA C	CK725CH1H-101J1	1	342101014R1
C7904	C-CERA C	CK725CH1H-101J1	1	342101014R1
C7905	C-CERA C	CK725B1H-102K1	1	332101025R1
C7906	C-CERA C	CK725F1E-104Z1	1	332161040R1
C7907	C-CERA C	CK725B1H-102K1	1	332101025R1
C7908	C-CERA C	CK725CH1H-101J1	1	342101014R1
C7909	C-CERA C	CK725CH1H-101J1	1	342101014R1
C7910	C-CERA C	CK725F1E-104Z1	1	332161040R1
C7912	C-CERA C	CK725CH1H-471J1	1	342104714R1
C7914	UTSP C	CE04W50V-10M(UTSP)	1	397581007T
C7915	C-CERA C	CK725CH1H-471J1	1	342104714R1
C7916	C-CERA C	CK725CH1H-221J1	1	342102214R1
C7917	C-CERA C	CK725CH1H-221J1	1	342102214R1
C7935	C-CERA C	CK725CH1H-470J1	1	342104704R1
C7936	UTSP C	CE04W50V-10M(UTSP)	1	397581007T
C7937	VR C	CE04W6 3V-470M(VR)	1	394634717T
C7938	C-CERA C	CK725B1H-102K1	1	332101025R1

C7939	C-CERA C	CC725CH1H-47U1	1	342104704R1
C7940	VR C	CE04W/6 3V-470M(VFR)	1	304624717T
C7941	UTSP C	CE04W/25V-47M(UTSP)	1	307554707T
C7942	UTSP C	CE04W/25V-100M(UTSP)	1	307551017T
C7943	UTSP C	CE04W/10V-100M(UTSP)	1	307531017T
C7944	C-CERA C	CK725F1E-104Z1	1	332161040R1
C7945	C-CERA C	CC725CH1H-47U1	1	342104704R1
C7946	C-CERA C	CK725F1E-104Z1	1	332161040R1
C7947	C-CERA C	CK725F1E-104Z1	1	332161040R1
C7948	C-CERA C	CK725F1E-104Z1	1	332161040R1
C7949	C-CERA C	CK725F1A-105Z1	1	332181050R1
C7950	C-CERA C	CK725F1A-105Z1	1	332181050R1
C7951	C-CERA C	CK725F1A-105Z1	1	332181050R1
C7952	C-CERA C	CC725CH1H-47U1	1	342104714R1
C7953	C-CERA C	CC725CH1H-47U1	1	342104714R1
C7954	C-CERA C	CK725F1A-105Z1	1	332181050R1
C7955	C-CERA C	CK725F1A-105Z1	1	332181050R1
C7956	C-CERA C	CC725CH1H-47U1	1	342104714R1
C7957	C-CERA C	CC725CH1H-47U1	1	342104714R1
C7958	C-CERA C	CK725F1A-105Z1	1	332181050R1
C7959	C-CERA C	CC725CH1H-10U1	1	342101014R1
C7960	C-CERA C	CC725CH1H-10U1	1	342101014R1
RESISTOR				
R1104	C-CARB ONR	RN72K1J-271E	1	435032714R1
R1105	C-CARB ONR	RN72K1J-750E	1	435037504R1
R1106	METAL OR	R S1/2W/R1-10	1	443521004T
R1107	C-CARB ONR	RN72K1J-221E	1	435032214R1
R1108	C-CARB ONR	RN72K1J-681E	1	435036814R1
R1109	C-CARB ONR	RN72K1J-103E	1	435031034R1
R1110	C-CARB ONR	RN72K1J-103E	1	435031034R1
R1111	C-CARB ONR	RN72K1J-331E	1	435033314R1
R1112	C-CARB ONR	RN72K1J-470E	1	435034704R1
R1113	C-CARB ONR	RN72K1J-531E	1	43503314R1
R1114	C-CARB ONR	RN72K1J-531E	1	43503314R1
R1115	C-CARB ONR	RN72K1J-103E	1	435031034R1
R1116	C-CARB ONR	RN72K1J-151E	1	435031514R1
R1117	C-CARB ONR	RN72K1J-331E	1	435033314R1
R1118	C-CARB ONR	RN72K1J-750E	1	435037504R1
R1119	C-CARB ONR	RN72K1J-331E	1	435033314R1
R1120	C-CARB ONR	RN72K1J-331E	1	435033314R1
R1121	C-CARB ONR	RN72K1J-750E	1	435037504R1
R1122	C-CARB ONR	RN72K1J-331E	1	435033314R1
R1123	C-CARB ONR	RN72K1J-331E	1	435033314R1
R1124	C-CARB ONR	RN72K1J-331E	1	435033314R1

<B MDC, MDEF, B MINA, MAMP, MMDQ, MMDR / S MAMP>

R1225	C-CARBONR	RN7ZK11-331JE	1	435033314R1	<B MUI>
R1226	C-CARBONR	RN7ZK11-331JE	1	435033314R1	<B MUI>
R1227	C-CARBONR	RN7ZK11-331JE	1	435033314R1	<B MUI>
R1228	C-CARBONR	RN7ZK11-331JE	1	435033314R1	<B MUI>
R1229	C-CARBONR	RN7ZK11-470JE	1	43503704R1	<B MUI>
R1232	C-CARBONR	RN7ZK11-331JE	1	435033314R1	<B MUI>
R1233	C-CARBONR	RN7ZK11-331JE	1	435033314R1	<B MUI>
R1241	C-CARBONR	RN7ZK11-511JE	1	435031514R1	<B MUI>
R1242	C-CARBONR	RN7ZK11-750JE	1	435037504R1	<B MUI>
R1243	METAL O R	RS1WBL10	1	443621004T	<B MUI>
R1244	METAL O R	RS1WBL15	1	443621504T	<B MUI>
R1245	C-CARBONR	RN7ZK11-470JE	1	43503704R1	<B MUI>
R1246	C-CARBONR	RN7ZK11-000JE	1	435030004R1	<B MUI>
R1248	C-CARBONR	RN7ZK11-470JE	1	43503704R1	<B MUI>
R1249	C-CARBONR	RN7ZK11-151JE	1	435031514R1	<B MUI>
R1250	C-CARBONR	RN7ZK11-470JE	1	43503704R1	<B MUI>
R1251	C-CARBONR	RN7ZK11-331JE	1	435033314R1	<B MUI>
R1252	C-CARBONR	RN7ZK11-472JE	1	43503724R1	<B MUI>
R1253	C-CARBONR	RN7ZK11-331JE	1	435033314R1	<B MUI>
R1254	C-CARBONR	RN7ZK11-472JE	1	43503724R1	<B MUI>
R1255	C-CARBONR	RN7ZK11-823JE	1	435038234R1	<B MUI>
R1256	C-CARBONR	RN7ZK11-151JE	1	435031514R1	<B MUI>
R1257	C-CARBONR	RN7ZK11-000JE	1	435030004R1	<B MUI>
R1259	C-CARBONR	RN7ZK11-331JE	1	435033314R1	<B MUI>
R1260	C-CARBONR	RN7ZK11-470JE	1	43503704R1	<B MUI>
R1300	C-CARBONR	RN7ZK11-472JE	1	43503724R1	<B MUI>
R1301	C-CARBONR	RN7ZK11-472JE	1	43503724R1	<B MUI>
R1302	C-CARBONR	RN7ZK11-472JE	1	43503724R1	<B MUI>
R1303	C-CARBONR	RN7ZK11-472JE	1	43503724R1	<B MUI>
R1304	C-CARBONR	RN7ZK11-472JE	1	43503724R1	<B MUI>
R1305	C-CARBONR	RN7ZK11-472JE	1	43503724R1	<B MUI>
R1306	C-CARBONR	RN7ZK11-472JE	1	43503724R1	<B MUI>
R1307	C-CARBONR	RN7ZK11-472JE	1	43503724R1	<B MUI>
R1310	C-CARBONR	RN7ZK11-681JE	1	435036814R1	<B MUI>
R1311	C-CARBONR	RN7ZK11-681JE	1	435036814R1	<B MUI>
R1312	C-CARBONR	RN7ZK11-681JE	1	435036814R1	<B MUI>
R1313	C-CARBONR	RN7ZK11-681JE	1	435036814R1	<B MUI>
R1314	C-CARBONR	RN7ZK11-681JE	1	435036814R1	<B MUI>
R1315	C-CARBONR	RN7ZK11-681JE	1	435036814R1	<B MUI>
R1316	C-CARBONR	RN7ZK11-681JE	1	435036814R1	<B MUI>
R1317	C-CARBONR	RN7ZK11-681JE	1	435036814R1	<B MUI>
R1320	C-CARBONR	RN7ZK11-472JE	1	43503724R1	<B MUI>
R1321	C-CARBONR	RN7ZK11-472JE	1	43503724R1	<B MUI>
R1322	C-CARBONR	RN7ZK11-472JE	1	43503724R1	<B MUI>
R1323	C-CARBONR	RN7ZK11-472JE	1	43503724R1	<B MUI>
R1324	C-CARBONR	RN7ZK11-472JE	1	43503724R1	<B MUI>
R1325	C-CARBONR	RN7ZK11-472JE	1	43503724R1	<B MUI>

R1385	C-CARB ON R	RN7ZK U-272JE	1	435032724R1	<B MUI>
R1386	C-CARB ON R	RN7ZK U-272JE	1	435032724R1	<B MUI>
R1387	C-CARB ON R	RN7ZK U-272JE	1	435032724R1	<B MUI>
R1485	C-CARB ON R	RN7ZK U-100JE	1	435031004R1	
R1486	C-CARB ON R	RN7ZK U-100JE	1	435031004R1	
R1487	C-CARB ON R	RN7ZK U-750JE	1	435037504R1	
R1488	C-CARB ON R	RN7ZK U-24JE	1	435032244R1	
R1490	C-CARB ON R	RN7ZK U-750JE	1	435037504R1	
R1491	C-CARB ON R	RN7ZK U-24JE	1	435032244R1	
R1492	C-CARB ON R	RN7ZK U-100JE	1	435031004R1	
R1496	C-CARB ON R	RN7ZK U-750JE	1	435037504R1	
R1497	C-CARB ON R	RN7ZK U-24JE	1	435032244R1	
R1513	C-CARB ON R	RN7ZK U-331JE	1	435033314R1	
R1515	C-CARB ON R	RN7ZK U-331JE	1	435033314R1	
R1517	C-CARB ON R	RN7ZK U-331JE	1	435033314R1	
R1518	C-CARB ON R	RN7ZK U-331JE	1	435033314R1	
R1519	C-CARB ON R	RN7ZK U-331JE	1	435033314R1	
R1522	C-CARB ON R	RN7ZK U-103JE	1	435031034R1	
R1523	C-CARB ON R	RN7ZK U-103JE	1	435031034R1	
R1524	C-CARB ON R	RN7ZK U-823JE	1	435038234R1	
R1529	C-CARB ON R	RN7ZK U-470JE	1	435034704R1	
R1532	C-CARB ON R	RN7ZK U-103JE	1	435031034R1	
R1534	C-CARB ON R	RN7ZK U-823JE	1	435038234R1	
R1567	C-CARB ON R	RN7ZK U-331JE	1	435033314R1	
R1568	C-CARB ON R	RN7ZK U-221JE	1	435032214R1	
R1569	C-CARB ON R	RN7ZK U-331JE	1	435033314R1	
R1572	C-CARB ON R	RN7ZK U-331JE	1	435033314R1	
R1573	C-CARB ON R	RN7ZK U-331JE	1	435033314R1	
R1575	C-CARB ON R	RN7ZK U-331JE	1	435033314R1	
R1577	C-CARB ON R	RN7ZK U-331JE	1	435033314R1	
R1579	C-CARB ON R	RN7ZK U-331JE	1	435033314R1	
R1600	C-CARB ON R	RN7ZK U-153JE	1	435031534R1	
R1601	C-CARB ON R	RN7ZK U-153JE	1	435031534R1	
R1602	C-CARB ON R	RN7ZK U-153JE	1	435031534R1	
R1603	C-CARB ON R	RN7ZK U-153JE	1	435031534R1	
R1604	C-CARB ON R	RN7ZK U-153JE	1	435031534R1	
R1605	C-CARB ON R	RN7ZK U-153JE	1	435031534R1	
R1606	C-CARB ON R	RN7ZK U-153JE	1	435031534R1	
R1607	C-CARB ON R	RN7ZK U-153JE	1	435031534R1	
R1610	C-CARB ON R	RN7ZK U-153JE	1	435031534R1	
R1611	C-CARB ON R	RN7ZK U-153JE	1	435031534R1	
R1612	C-CARB ON R	RN7ZK U-153JE	1	435031534R1	
R1613	C-CARB ON R	RN7ZK U-153JE	1	435031534R1	
R1614	C-CARB ON R	RN7ZK U-153JE	1	435031534R1	
R1615	C-CARB ON R	RN7ZK U-153JE	1	435031534R1	
R1616	C-CARB ON R	RN7ZK U-153JE	1	435031534R1	
R1617	C-CARB ON R	RN7ZK U-153JE	1	435031534R1	

R1880	C-CARB ONR	RN7ZK UJ-393JE	1	43503934R1	
R1881	C-CARB ONR	RN7ZK UJ-393JE	1	43503934R1	<B MDC, MDF>
R20	C-CARB ONR	RN7ZK UJ-123JE	1	43503123R1	<B MMA, MNP, MMQ, MMFR / S.MMP>
R20	C-CARB ONR	RN7ZK UJ-272JE	1	43503272R1	
R2001	METAL R	RNUJ/2WCI-4.7	1	43530474T	
R2003	C-CARB ONR	RN7ZK UJ-682JE	1	43503682R1	
R2004	METAL R	RNU1WCI-0-22	1	43532294T	
R2012	METAL R	RNUJ/2WCI-0-47	1	43534794T	
R2015	C-CARB ONR	RN7ZK UJ-822JE	1	43503824R1	
R2017	C-CARB ONR	RN7ZK UJ-563FE	1	43503563R1	
R2018	C-CARB ONR	RN7ZK UJ-103FE	1	43503103R1	
R21	C-CARB ONR	RN7ZK UJ-822JE	1	43503824R1	<B MDC, MDF, B MMA, MNP, MMQ, MMFR / S.MMP>
R2112	C-CARB ONR	RN7ZK UJ-000JE	1	43503004R1	
R2113	C-CARB ONR	RN7ZK UJ-000JE	1	43503004R1	
R2114	C-CARB ONR	RN7ZK UJ-000JE	1	43503004R1	
R2115	C-CARB ONR	RN7ZK UJ-000JE	1	43503004R1	
R2116	C-CARB ONR	RN7ZK UJ-000JE	1	43503004R1	
R2117	C-CARB ONR	RN7ZK UJ-000JE	1	43503004R1	
R2135	C-CARB ONR	RN7ZK UJ-750JE	1	43503750R1	
R2137	C-CARB ONR	RN7ZK UJ-000JE	1	43503004R1	<B MDP>
R2138	C-CARB ONR	RN7ZK UJ-000JE	1	43503004R1	
R2139	C-CARB ONR	RN7ZK UJ-000JE	1	43503004R1	
R2141	C-CARB ONR	RN7ZK UJ-000JE	1	43503004R1	<B MDP>
R2142	C-CARB ONR	RN7ZK UJ-000JE	1	43503004R1	
R2143	C-CARB ONR	RN7ZK UJ-104JE	1	43503104R1	
R2144	C-CARB ONR	RN7ZK UJ-104JE	1	43503104R1	
R2145	C-CARB ONR	RN7ZK UJ-682JE	1	43503682R1	
R2146	C-CARB ONR	RN7ZK UJ-101JE	1	43503101R1	
R2147	C-CARB ONR	RN7ZK UJ-750JE	1	43503750R1	
R2150	C-CARB ONR	RN7ZK UJ-000JE	1	43503004R1	
R2154	C-CARB ONR	RN7ZK UJ-101JE	1	43503101R1	
R2155	C-CARB ONR	RN7ZK UJ-750JE	1	43503750R1	
R2156	C-CARB ONR	RN7ZK UJ-101JE	1	43503101R1	
R2157	C-CARB ONR	RN7ZK UJ-103JE	1	43503103R1	
R2159	C-CARB ONR	RN7ZK UJ-392JE	1	43503924R1	
R2161	C-CARB ONR	RN7ZK UJ-222JE	1	43503224R1	
R2162	C-CARB ONR	RN7ZK UJ-222JE	1	43503224R1	
R2164	C-CARB ONR	RN7ZK UJ-750JE	1	43503750R1	
R2166	C-CARB ONR	RN7ZK UJ-105JE	1	435031054R1	
R2167	C-CARB ONR	RN7ZK UJ-105JE	1	435031054R1	
R2168	C-CARB ONR	RN7ZK UJ-105JE	1	435031054R1	
R2169	C-CARB ONR	RN7ZK UJ-105JE	1	435031054R1	
R2170	C-CARB ONR	RN7ZK UJ-105JE	1	435031054R1	
R2172	C-CARB ONR	RN7ZK UJ-750JE	1	435037504R1	
R2175	C-CARB ONR	RN7ZK UJ-000JE	1	43503004R1	
R2177	C-CARB ONR	RN7ZK UJ-750JE	1	435037504R1	
R2183	C-CARB ONR	RN7ZK UJ-311JE	1	43503314R1	

R2184	C-CARB ONR	RN7ZK U-750E	1	435037504R1	
R2185	C-CARB ONR	RN7ZK U-101E	1	435031014R1	
R2186	C-CARB ONR	RN7ZK U-331E	1	435033314R1	
R2187	C-CARB ONR	RN7ZK U-331E	1	435033314R1	
R2188	C-CARB ONR	RN7ZK U-104E	1	435031044R1	
R2190	C-CARB ONR	RN7ZK U-101E	1	435031014R1	
R2192	C-CARB ONR	RN7ZK U-101E	1	435031014R1	
R2193	C-CARB ONR	RN7ZK U-531E	1	435033314R1	
R2195	C-CARB ONR	RN7ZK U-750E	1	435037504R1	
R2196	C-CARB ONR	RN7ZK U-103E	1	435031034R1	
R2198	C-CARB ONR	RN7ZK U-104E	1	435031044R1	
R22	C-CARB ONR	RN7ZK U-123E	1	435031234R1	<B MDC, MDF>
R22	C-CARB ONR	RN7ZK U-272E	1	435032724R1	<B MMA, MMP, MMQ, MMR / S.MMP>
R2202	C-CARB ONR	RN7ZK U-103E	1	435031034R1	
R2203	C-CARB ONR	RN7ZK U-750E	1	435037504R1	
R2204	C-CARB ONR	RN7ZK U-103E	1	435031034R1	
R2205	C-CARB ONR	RN7ZK U-104E	1	435031044R1	
R2233	C-CARB ONR	RN7ZK U-105E	1	435031054R1	
R2234	C-CARB ONR	RN7ZK U-392E	1	43503924R1	
R2235	C-CARB ONR	RN7ZK U-105E	1	435031054R1	
R2236	C-CARB ONR	RN7ZK U-392E	1	43503924R1	
R2238	C-CARB ONR	RN7ZK U-105E	1	435031054R1	
R2239	C-CARB ONR	RN7ZK U-105E	1	435031054R1	
R2240	C-CARB ONR	RN7ZK U-105E	1	435031054R1	
R2241	C-CARB ONR	RN7ZK U-105E	1	435031054R1	
R2242	C-CARB ONR	RN7ZK U-101E	1	435031014R1	<B MDC, MDF, B MMA, MMP, MMQ, MMR / S.MMP>
R2243	C-CARB ONR	RN7ZK U-682E	1	435036824R1	
R2244	C-CARB ONR	RN7ZK U-101E	1	435031014R1	
R2245	C-CARB ONR	RN7ZK U-104E	1	435031044R1	
R2246	C-CARB ONR	RN7ZK U-104E	1	435031044R1	
R2247	C-CARB ONR	RN7ZK U-682E	1	435036824R1	
R2248	C-CARB ONR	RN7ZK U-101E	1	435031014R1	
R2249	C-CARB ONR	RN7ZK U-104E	1	435031044R1	
R2250	C-CARB ONR	RN7ZK U-104E	1	435031044R1	
R2252	C-CARB ONR	RN7ZK U-105E	1	435031054R1	
R2253	C-CARB ONR	RN7ZK U-750E	1	435037504R1	
R2254	C-CARB ONR	RN7ZK U-750E	1	435037504R1	
R2255	C-CARB ONR	RN7ZK U-750E	1	435037504R1	
R2256	C-CARB ONR	RN7ZK U-102E	1	435031024R1	<B MDC, MDF, B MMA, MMP, MMQ, MMR / S.MMP>
R2257	C-CARB ONR	RN7ZK U-039E	1	435030394R1	<B MDC, MDF, B MMA, MMP, MMQ, MMR / S.MMP>
R2258	C-CARB ONR	RN7ZK U-750E	1	435037504R1	
R2259	C-CARB ONR	RN7ZK U-750E	1	435037504R1	
R2260	C-CARB ONR	RN7ZK U-750E	1	435037504R1	
R2261	C-CARB ONR	RN7ZK U-24E	1	43503244R1	<B MDC, MDF, B MMA, MMP, MMQ, MMR / S.MMP>
R2262	C-CARB ONR	RN7ZK U-102E	1	435031024R1	<B MDC, MDF, B MMA, MMP, MMQ, MMR / S.MMP>
R2263	C-CARB ONR	RN7ZK U-750E	1	435037504R1	
R2266	C-CARB ONR	RN7ZK U-750E	1	435037504R1	

R52	C-CARB ON R	RN72K U-273JE	1	435032734R1	<B MDC, MDF, B MMA, MMP, MMQ, MMR /S MMP>
R53	C-CARB ON R	RN72K U-183JE	1	435031834R1	<B MDC, MDF, B MMA, MMP, MMQ, MMR /S MMP>
R54	C-CARB ON R	RN72K U-183JE	1	435031834R1	<B MDC, MDF, B MMA, MMP, MMQ, MMR /S MMP>
R55	C-CARB ON R	RN72K U-183JE	1	435031834R1	<B MDC, MDF, B MMA, MMP, MMQ, MMR /S MMP>
R56	C-CARB ON R	RN72K U-183JE	1	435031834R1	<B MDC, MDF, B MMA, MMP, MMQ, MMR /S MMP>
R57	C-CARB ON R	RN72K U-103JE	1	435031034R1	<B MDC, MDF>
R58	C-CARB ON R	RN72K U-103JE	1	435031034R1	<B MDC, MDF>
R59	C-CARB ON R	RN72K U-103JE	1	435031034R1	<B MDC, MDF>
R60	C-CARB ON R	RN72K U-103JE	1	435031034R1	<B MDC, MDF>
R61	C-CARB ON R	RN72K U-103JE	1	435031034R1	<B MDC, MDF>
R62	C-CARB ON R	RN72K U-103JE	1	435031034R1	<B MDC, MDF>
R63	C-CARB ON R	RN72K U-103JE	1	435031034R1	<B MDC, MDF>
R64	C-CARB ON R	RN72K U-103JE	1	435031034R1	<B MDC, MDF>
R66	NF CARBON R	R25I-10	1	415471004T	<B MDC, MDF, B MMA, MMP, MMQ, MMR /S MMP>
R7002	C-CARB ON R	RN72K U-102JE	1	435031024R1	
R7004	C-CARB ON R	RN72K U-470JE	1	435034704R1	
R7005	C-CARB ON R	RN72K U-470JE	1	435034704R1	
R7006	C-CARB ON R	RN72K U-470JE	1	435034704R1	
R7007	C-CARB ON R	RN72K U-470JE	1	435034704R1	
R7008	C-CARB ON R	RN72K U-470JE	1	435034704R1	
R7009	C-CARB ON R	RN72K U-470JE	1	435034704R1	
R7010	C-CARB ON R	RN72K U-470JE	1	435034704R1	
R7011	C-CARB ON R	RN72K U-470JE	1	435034704R1	
R7012	C-CARB ON R	RN72K U-470JE	1	435034704R1	
R7013	C-CARB ON R	RN72K U-470JE	1	435034704R1	
R7014	C-CARB ON R	RN72K U-470JE	1	435034704R1	
R7015	C-CARB ON R	RN72K U-470JE	1	435034704R1	
R7016	C-CARB ON R	RN72K U-470JE	1	435034704R1	
R7017	C-CARB ON R	RN72K U-470JE	1	435034704R1	
R7018	C-CARB ON R	RN72K U-470JE	1	435034704R1	
R7019	C-CARB ON R	RN72K U-470JE	1	435034704R1	
R7020	C-CARB ON R	RN72K U-470JE	1	435034704R1	
R7021	C-CARB ON R	RN72K U-470JE	1	435034704R1	
R7022	C-CARB ON R	RN72K U-470JE	1	435034704R1	
R7023	C-CARB ON R	RN72K U-221JE	1	435032214R1	
R7024	C-CARB ON R	RN72K U-221JE	1	435032214R1	
R7025	C-CARB ON R	RN72K U-221JE	1	435032214R1	
R7026	C-CARB ON R	RN72K U-470JE	1	435034704R1	
R7027	C-CARB ON R	RN72K U-470JE	1	435034704R1	
R7028	C-CARB ON R	RN72K U-221JE	1	435032214R1	
R7029	C-CARB ON R	RN72K U-221JE	1	435032214R1	
R7031	C-CARB ON R	RN72K U-470JE	1	435034704R1	
R7038	C-CARB ON R	RN72K U-473JE	1	435034734R1	
R7039	C-CARB ON R	RN72K U-473JE	1	435034734R1	
R7040	C-CARB ON R	RN72K U-102JE	1	435031024R1	
R7041	C-CARB ON R	RN72K U-103JE	1	435031034R1	
R7042	C-CARB ON R	RN72K U-470JE	1	435034704R1	

R7043	C-CARB ONR	RN72K11-273JE	1	435032734R1
R7044	C-CARB ONR	RN72K11-473JE	1	435034734R1
R7046	C-CARB ONR	RN72K11-473JE	1	435034734R1
R7048	C-CARB ONR	RN72K11-473JE	1	435034734R1
R7049	C-CARB ONR	RN72K11-101JE	1	435031014R1
R7051	C-CARB ONR	RN72K11-103JE	1	435031034R1
R7053	C-CARB ONR	RN72K11-224JE	1	435032244R1
R7054	C-CARB ONR	RN72K11-473JE	1	435034734R1
R7055	C-CARB ONR	RN72K11-101JE	1	435031014R1
R7056	C-CARB ONR	RN72K11-103JE	1	435031034R1
R7057	C-CARB ONR	RN72K11-473JE	1	435034734R1
R7058	C-CARB ONR	RN72K11-473JE	1	435034734R1
R7059	C-CARB ONR	RN72K11-473JE	1	435034734R1
R7060	C-CARB ONR	RN72K11-473JE	1	435034734R1
R7061	C-CARB ONR	RN72K11-473JE	1	435034734R1
R7062	C-CARB ONR	RN72K11-473JE	1	435034734R1
R7063	C-CARB ONR	RN72K11-103JE	1	435031034R1
R7064	C-CARB ONR	RN72K11-102JE	1	435031024R1
R7065	C-CARB ONR	RN72K11-473JE	1	435034734R1
R7066	C-CARB ONR	RN72K11-472JE	1	435034724R1
R7067	C-CARB ONR	RN72K11-473JE	1	435034734R1
R7068	C-CARB ONR	RN72K11-473JE	1	435034734R1
R7069	C-CARB ONR	RN72K11-473JE	1	435034734R1
R7070	C-CARB ONR	RN72K11-473JE	1	435034734R1
R7071	C-CARB ONR	RN72K11-473JE	1	435034734R1
R7072	C-CARB ONR	RN72K11-473JE	1	435034734R1
R7073	C-CARB ONR	RN72K11-473JE	1	435034734R1
R7076	C-CARB ONR	RN72K11-473JE	1	435034734R1
R7077	C-CARB ONR	RN72K11-473JE	1	435034734R1
R7078	C-CARB ONR	RN72K11-473JE	1	435034734R1
R7079	C-CARB ONR	RN72K11-473JE	1	435034734R1
R7080	C-CARB ONR	RN72K11-272JE	1	435032724R1
R7081	C-CARB ONR	RN72K11-272JE	1	435032724R1
R7082	C-CARB ONR	RN72K11-272JE	1	435032724R1
R7083	C-CARB ONR	RN72K11-272JE	1	435032724R1
R7086	C-CARB ONR	RN72K11-224JE	1	435032244R1
R7087	C-CARB ONR	RN72K11-221JE	1	435032214R1
R7088	C-CARB ONR	RN72K11-103JE	1	435031034R1
R7089	C-CARB ONR	RN72K11-103JE	1	435031034R1
R7090	C-CARB ONR	RN72K11-103JE	1	435031034R1
R7091	C-CARB ONR	RN72K11-103JE	1	435031034R1
R7092	C-CARB ONR	RN72K11-103JE	1	435031034R1
R7093	C-CARB ONR	RN72K11-470JE	1	435034704R1
R7094	C-CARB ONR	RN72K11-221JE	1	435032214R1
R7096	C-CARB ONR	RN72K11-470JE	1	435034704R1
R7097	C-CARB ONR	RN72K11-102JE	1	435031024R1
R7098	C-CARB ONR	RN72K11-221JE	1	435032214R1

R7099	C-CARB ONR	RN72K U-221E	1	435032214R1	
R7100	C-CARB ONR	RN72K U-221E	1	435032214R1	
R7101	C-CARB ONR	RN72K U-221E	1	435032214R1	
R7102	C-CARB ONR	RN72K U-221E	1	435032214R1	
R7103	C-CARB ONR	RN72K U-470E	1	435034704R1	
R7104	C-CARB ONR	RN72K U-221E	1	435032214R1	
R7105	C-CARB ONR	RN72K U-470E	1	435034704R1	
R7107	C-CARB ONR	RN72K U-221E	1	435032214R1	
R7108	C-CARB ONR	RN72K U-221E	1	435032214R1	
R7110	C-CARB ONR	RN72K U-221E	1	435032214R1	
R7111	C-CARB ONR	RN72K U-470E	1	435034704R1	
R7113	C-CARB ONR	RN72K U-102E	1	435031024R1	
R7114	C-CARB ONR	RN72K U-470E	1	435034704R1	<B MDC, MDF, B MMA, MDP, MMQ, MMFR / S MMFP>
R7115	C-CARB ONR	RN72K U-103E	1	435031034R1	
R7116	C-CARB ONR	RN72K U-470E	1	435034704R1	
R7117	C-CARB ONR	RN72K U-221E	1	435032214R1	<B MDC, MDF>
R7118	C-CARB ONR	RN72K U-470E	1	435034704R1	
R7119	C-CARB ONR	RN72K U-221E	1	435032214R1	
R7120	C-CARB ONR	RN72K U-470E	1	435034704R1	<B MDC, MDF>
R7122	C-CARB ONR	RN72K U-221E	1	435032214R1	
R7123	C-CARB ONR	RN72K U-470E	1	435034704R1	<B MDC, MDF>
R7124	C-CARB ONR	RN72K U-473E	1	435034734R1	
R7125	C-CARB ONR	RN72K U-221E	1	435032214R1	
R7126	C-CARB ONR	RN72K U-470E	1	435034704R1	
R7127	C-CARB ONR	RN72K U-473E	1	435034734R1	
R7128	C-CARB ONR	RN72K U-221E	1	435032214R1	
R7129	C-CARB ONR	RN72K U-470E	1	435034704R1	
R7130	C-CARB ONR	RN72K U-221E	1	435032214R1	
R7131	C-CARB ONR	RN72K U-221E	1	435032214R1	
R7132	C-CARB ONR	RN72K U-102E	1	435031024R1	<B MMA, MDP, MMQ, MMFR / S MMFP>
R7133	C-CARB ONR	RN72K U-473E	1	435034734R1	
R7134	C-CARB ONR	RN72K U-473E	1	435034734R1	
R7135	C-CARB ONR	RN72K U-221E	1	435032214R1	
R7136	C-CARB ONR	RN72K U-470E	1	435034704R1	
R7137	C-CARB ONR	RN72K U-470E	1	435034704R1	
R7138	C-CARB ONR	RN72K U-221E	1	435032214R1	
R7140	C-CARB ONR	RN72K U-221E	1	435032214R1	
R7141	C-CARB ONR	RN72K U-470E	1	435034704R1	
R7142	C-CARB ONR	RN72K U-102E	1	435031024R1	
R7143	C-CARB ONR	RN72K U-470E	1	435034704R1	
R7144	C-CARB ONR	RN72K U-102E	1	435031024R1	
R7145	C-CARB ONR	RN72K U-221E	1	435032214R1	
R7146	C-CARB ONR	RN72K U-221E	1	435032214R1	
R7147	C-CARB ONR	RN72K U-470E	1	435034704R1	
R7148	METAL R	RND1WCI-1.5	1	435030154T	
R7149	METAL R	RND1WCI-1.5	1	435030154T	
R7150	C-CARB ONR	RN72K U-473E	1	435034734R1	

R7151	C-CARB ON R	RN72K U-470E	1	435034704R1	
R7152	C-CARB ON R	RN72K U-102E	1	435031024R1	
R7153	C-CARB ON R	RN72K U-221E	1	435032214R1	
R7154	C-CARB ON R	RN72K U-470E	1	435034704R1	
R7155	C-CARB ON R	RN72K U-221E	1	435032214R1	
R7156	C-CARB ON R	RN72K U-470E	1	435034704R1	
R7157	C-CARB ON R	RN72K U-000E	1	435030004R1	
R7158	C-CARB ON R	RN72K U-470E	1	435034704R1	
R7160	C-CARB ON R	RN72K U-000E	1	435030004R1	
R7161	C-CARB ON R	RN72K U-470E	1	435034704R1	
R7162	C-CARB ON R	RN72K U-000E	1	435030004R1	
R7163	C-CARB ON R	RN72K U-470E	1	435034704R1	
R7164	C-CARB ON R	RN72K U-103E	1	435031034R1	
R7165	C-CARB ON R	RN72K U-470E	1	435034704R1	
R7166	C-CARB ON R	RN72K U-472E	1	435034724R1	
R7167	C-CARB ON R	RN72K U-470E	1	435034704R1	
R7168	C-CARB ON R	RN72K U-102E	1	435031024R1	
R7169	C-CARB ON R	RN72K U-472E	1	435034724R1	
R7170	C-CARB ON R	RN72K U-470E	1	435034704R1	
R7171	C-CARB ON R	RN72K U-472E	1	435034724R1	
R7172	C-CARB ON R	RN72K U-472E	1	435034724R1	
R7173	C-CARB ON R	RN72K U-472E	1	435034724R1	
R7174	C-CARB ON R	RN72K U-472E	1	435034724R1	
R7176	C-CARB ON R	RN72K U-272E	1	435032724R1	
R7177	C-CARB ON R	RN72K U-103E	1	435031034R1	
R7183	C-CARB ON R	RN72K U-533E	1	435033334R1	
R7184	C-CARB ON R	RN72K U-272E	1	435032724R1	
R7186	C-CARB ON R	RN72K U-473E	1	435034734R1	
R7187	C-CARB ON R	RN72K U-473E	1	435034734R1	
R7188	C-CARB ON R	RN72K U-473E	1	435034734R1	
R7189	C-CARB ON R	RN72K U-272E	1	435032724R1	
R7190	C-CARB ON R	RN72K U-272E	1	435032724R1	
R7191	C-CARB ON R	RN72K U-272E	1	435032724R1	
R7192	C-CARB ON R	RN72K U-272E	1	435032724R1	
R7194	C-CARB ON R	RN72K U-272E	1	435032724R1	
R7195	C-CARB ON R	RN72K U-470E	1	435034704R1	
R7196	C-CARB ON R	RN72K U-102E	1	435031024R1	
R7197	C-CARB ON R	RN72K U-103E	1	435031034R1	
R7198	C-CARB ON R	RN72K U-000E	1	435030004R1	
R7199	C-CARB ON R	RN72K U-470E	1	435034704R1	
R7200	C-CARB ON R	RN72K U-221E	1	435032214R1	
R7201	C-CARB ON R	RN72K U-470E	1	435034704R1	
R7202	C-CARB ON R	RN72K U-470E	1	435034704R1	
R7203	C-CARB ON R	RN72K U-221E	1	435032214R1	
R7204	C-CARB ON R	RN72K U-470E	1	435034704R1	
R7205	C-CARB ON R	RN72K U-470E	1	435034704R1	

<B MDC, MDP, B MDP>

<B MMA, MNG, MMAQ, MMAR / SMMAP, B MDP>
<B MDC, MDP>

<B MMA, MNG, MMAQ, MMAR / SMMAP>

R7206	C-CARB ONR	RN72K U-470E	1	435034704R1	
R7207	C-CARB ONR	RN72K U-470E	1	435034704R1	
R7208	C-CARB ONR	RN72K U-470E	1	435034704R1	
R7209	C-CARB ONR	RN72K U-103E	1	435031034R1	
R7210	C-CARB ONR	RN72K U-221E	1	435032214R1	
R7211	C-CARB ONR	RN72K U-470E	1	435034704R1	
R7212	C-CARB ONR	RN72K U-532E	1	435033324R1	
R7213	C-CARB ONR	RN72K U-532E	1	435033324R1	
R7214	C-CARB ONR	RN72K U-473E	1	435034734R1	
R7215	C-CARB ONR	RN72K U-473E	1	435034734R1	
R7216	C-CARB ONR	RN72K U-103E	1	435031034R1	
R7217	C-CARB ONR	RN72K U-244E	1	435032244R1	
R7218	C-CARB ONR	RN72K U-244E	1	435032244R1	
R7219	C-CARB ONR	RN72K U-472E	1	435034724R1	
R7220	C-CARB ONR	RN72K U-472E	1	435034724R1	
R7221	C-CARB ONR	RN72K U-273E	1	435032734R1	
R7222	C-CARB ONR	RN72K U-273E	1	435032734R1	
R7224	C-CARB ONR	RN72K U-473E	1	435034734R1	
R7225	C-CARB ONR	RN72K U-470E	1	435034704R1	
R7227	C-CARB ONR	RN72K U-470E	1	435034704R1	
R7228	C-CARB ONR	RN72K U-470E	1	435034704R1	
R7229	C-CARB ONR	RN72K U-470E	1	435034704R1	
R7230	C-CARB ONR	RN72K U-470E	1	435034704R1	
R7231	C-CARB ONR	RN72K U-103E	1	435031034R1	
R7232	C-CARB ONR	RN72K U-103E	1	435031034R1	
R7233	C-CARB ONR	RN72K U-103E	1	435031034R1	
R7234	C-CARB ONR	RN72K U-103E	1	435031034R1	
R7235	C-CARB ONR	RN72K U-473E	1	435034734R1	
R7236	C-CARB ONR	RN72K U-102E	1	435031024R1	
R7237	C-CARB ONR	RN72K U-473E	1	435034734R1	
R7238	C-CARB ONR	RN72K U-470E	1	435034704R1	
R7239	C-CARB ONR	RN72K U-103E	1	435031034R1	
R7240	C-CARB ONR	RN72K U-103E	1	435031034R1	
R7241	C-CARB ONR	RN72K U-470E	1	435034704R1	
R7242	C-CARB ONR	RN72K U-221E	1	435032214R1	
R7243	C-CARB ONR	RN72K U-000E	1	435030004R1	
R7260	C-CARB ONR	RN72K U-473E	1	435034734R1	
R7261	C-CARB ONR	RN72K U-473E	1	435034734R1	
R7900	C-CARB ONR	RN72K U-000E	1	435030004R1	
R7901	C-CARB ONR	RN72K U-123E	1	435031234R1	
R7903	C-CARB ONR	RN72K U-104E	1	435031044R1	
R7904	C-CARB ONR	RN72K U-223E	1	435032234R1	
R7905	C-CARB ONR	RN72K U-223E	1	435032234R1	
R7907	C-CARB ONR	RN72K U-105E	1	435031054R1	
R7908	C-CARB ONR	RN72K U-223E	1	435032234R1	
R7909	C-CARB ONR	RN72K U-223E	1	435032234R1	
R7912	C-CARB ONR	RN72K U-104E	1	435031044R1	

<B MDC, MDF, B MINA, MMP, MMQ, MMRF / S MINP>

<B MDC, MDF, B MINP>

<B MDC>

R7914	C-CARB ONR	RN7ZK-U-123E	1	435031234R1	
R7915	C-CARB ONR	RN7ZK-U-123E	1	435031234R1	
R7916	C-CARB ONR	RN7ZK-U-000E	1	435030004R1	
R7917	C-CARB ONR	RN7ZK-U-123E	1	435031234R1	
R7930	C-CARB ONR	RN7ZK-U-750E	1	435037504R1	
R7931	C-CARB ONR	RN7ZK-U-220E	1	435032204R1	
R7932	C-CARB ONR	RN7ZK-U-222E	1	435032224R1	
R7933	THEMISTOR	FUSB090E	1	4000252T	
R7934	C-CARB ONR	RN7ZK-U-220E	1	435032204R1	
R7935	C-CARB ONR	RN7ZK-U-220E	1	435032204R1	
R7936	C-CARB ONR	RN7ZK-U-103E	1	435031034R1	
R7937	C-CARB ONR	RN7ZK-U-103E	1	435031034R1	
R7938	C-CARB ONR	RN7ZK-U-471E	1	435034714R1	
R7939	C-CARB ONR	RN7ZK-U-103E	1	435031034R1	
R7940	C-CARB ONR	RN7ZK-U-103E	1	435031034R1	
R7941	C-CARB ONR	RN7ZK-U-471E	1	435034714R1	
R7942	C-CARB ONR	RN7ZK-U-000E	1	435030004R1	
R7943	C-CARB ONR	RN7ZK-U-000E	1	435030004R1	
NEW ITEM					
D2021A	HEAT SINK	(S3)	1	27160357	
D2021B	SCREW	3P+10FN(3BC)	1	82143010GR	
F2000A	FUSE HOL	NSCT-1P2031	1	25052133T	
F2000B	FUSE HOL	NSCT-1P2031	1	25052133T	
F2001A	FUSE HOL	NSCT-1P2031	1	25052133T	
F2001B	FUSE HOL	NSCT-1P2031	1	25052133T	
IL104B	WIRE TRAP	NPLG-9P592	1	25055630	<B MDC, MDE, B MINA, MNP, MMQ, MMNR / S MINP>
IL2100A	WIRE HOL	NSCT-5P896	1	25051109	
IL901B	WIRE TRAP	NPLG-5P588	1	25055626	
P1008B	PLUG	MSA-9142B-22A	1	25056601	
P103B	SOCKET	NSCT-11P2104	1	25052207	<B MDC, MDE, B MINA, MNP, MMQ, MMNR / S MINP>
P1307	TRM-42(SCREW)	NEJITANSI ST3	1	25060495	
P1309	PIN JACK	NPJ-3PD0656	1	25045884	
P1309 or	PIN JACK	NPJ-3PD0465	(1)	25045666	
P151	SOCKET	YCF45-0029N	1	25053242	
P2020B	PLUG	NPLG-5P119	1	25055135	
P2100A	SOCKET	NSCT-21P2114	1	25052217	<B MLI>
P2100B	SOCKET	NSCT-21P2151	1	25052254	<B MLI>
P2101A	SOCKET	NSCT-19P2112	1	25052215	
P2102A	PLUG	MSA-9142B-16A	1	25056598	
P2102B	SOCKET	MSA-9142S-16A	1	25053230	
P2103A	PLUG	MSA-9142B-18A	1	25056599	
P2103B	SOCKET	MSA-9142S-18A	1	25053231	
P2107	RETAINER	(JOINT)	1	27142069	
P2108	PIN JACK	NPJ-9PDGLRGLR563	1	25045781	
P2108 or	PIN JACK	NPJ-9PDGLR519	(1)	25045731	
P2110	SOCKET	MDS-09P-V-01(DSUB 9P)	1	25053363	
P2114	TRM-42(SCREW)	NEJITANSI ST3	1	25060495	

P2115	PIN JACK	NPJ-10PDB Y621	1	25045842		
P2115 or	PIN JACK	NPJ-10PDB Y478	(1)	25045861		
P2118	PIN JACK	NPJ-10PDB Y621	1	25045842		
P2118 or	PIN JACK	NPJ-10PDB Y478	(1)	25045861		
P2119	ST JACK	MSJ-035-52E-B-A-G-PB-T	1	25045947		
P2119 or	ST JACK	HSJ1002-01-6020	(1)	25045647		
P2121	PIN JACK	NPJ-10PDB Y621	1	25045842		
P2121 or	PIN JACK	NPJ-10PDB Y478	(1)	25045861		
P2901	SOCKET	NSCT-14P2510	1	25052613		<B MDD>
P2902	SOCKET	NSCT-14P2510	1	25052613		<B MDD>
P2903	SOCKET	NSCT-14P2510	1	25052613		<B MDD>
P3101B	FLUG	NPUG-5P918	1	25055965R2		<B MDD>
P3605B	SOCKET	MSA-9142S-18A	1	25053231		
P3607B	SOCKET	MSA-9142S-16A	1	25053230		
P3608B	SOCKET	MSA-9142S-18A	1	25053231		
P4510B	SOCKET	MSA-9142S-20A	1	25053232		
P4511B	FLUG	NPUG-19P0974	1	25056024		
P6601B	FLUG	MSA-9142B-16A	1	25056598		
P6605B	FLUG	MSA-9142B-22A	1	25056601		
P7001A	SOCKET	MSA-9618S-09A	1	2505334R2		
P7008	ST JACK	MSJ-035-22	1	25045887		
P7077	TRM-42X(SCREW)	NEJITANSI ST3	1	25060495		
P7501A	FLUG	A2545WR2-2x20R(IDE40SIDE)	1	25056643		
P7560A	SOCKET	NSCT-3P2183	1	25052286		
P7900A	FLUG	MSA-9142B-22A	1	25056601		
P7900B	SOCKET	MSA-9142S-22A	1	25053233		
P7901	SOCKET	NNA1-01-006	1	25053357		
P8	SOCKET	ZMJ-3516-002	1	25053355		<B MDD, MDD>
U11301	FHT CP	JSR1165-001recording	1	24120143		
U1302	FHT CP	JSR1165-001recording	1	24120143		
U2100	REMO SENS	KSM-603TESB	1	24120019		<B MDD, MDD, B MMA, MMP, MMQ, MMR / S MMP>

PC BOARD PARTS LIST

U006	U0060~U0067	BADIS-0110-1F*	1	1B234510-1F		N
U0060	DISPLAY PC BOARD AS	BADIS-0110-1F	1	1B234510-1F		N
U0061	DISPLAY SW PC BOARD AS	BASW-0111-1F	1	1B234511-1F		
U0062	FL POWER SUPPLY PC BOARD AS	BAPS-0112-1F	1	1B234512-1F		
U0063	HEADPHONE TERMINAL PC BOARD AS	BAETC-0113-1F	1	1B234513-1F		
U0064	HOLD IDE CABLE PART1 PC BOARD AS	BAETC-0114-1F	1	1B234514-1F		
U0065	VOLUME LED PC BOARD AS	BAETC-0116-1F	1	1B234516-1F		
U0066	HOLD IDE CABLE PART2 PC BOARD AS	BAETC-0117-1F	1	1B234517-1F		
U0067	HOLD FRONT HDMI TERMINAL PC BOARD AS	BAETC-0118-1F	1	1B234518-1F		

TX-NR708

CIRCUIT NO.	PART NAME	DESCRIPTION	QTY	PART NO. (SN)	REMARKS
D7500	ZENER D	UDZ510B	1	224551000R2	
D7520	C-DIODE	ISS355	1	223269R2	
D7520 or	C-DIODE	ISS352	(1)	223234R2	
D7520 or	C-DIODE	MA2111	(1)	223279R2	
D7520 or	C-DIODE	KD S4148U	(1)	223283R2	
D7521	C-DIODE	ISS355	1	223269R2	
D7521 or	C-DIODE	ISS352	(1)	223234R2	
D7521 or	C-DIODE	MA2111	(1)	223279R2	
D7521 or	C-DIODE	KD S4148U	(1)	223283R2	
D7522	C-DIODE	ISS355	1	223269R2	
D7522 or	C-DIODE	ISS352	(1)	223234R2	
D7522 or	C-DIODE	MA2111	(1)	223279R2	
D7522 or	C-DIODE	KD S4148U	(1)	223283R2	
D7523	C-DIODE	ISS355	1	223269R2	
D7523 or	C-DIODE	ISS352	(1)	223234R2	
D7523 or	C-DIODE	MA2111	(1)	223279R2	
D7523 or	C-DIODE	KD S4148U	(1)	223283R2	
D7530	ZENER D	UDZ55 1B	1	224550510R2	
D7531	C-DIODE	ISS355	1	223269R2	
D7531 or	C-DIODE	ISS352	(1)	223234R2	
D7531 or	C-DIODE	MA2111	(1)	223279R2	
D7531 or	C-DIODE	KD S4148U	(1)	223283R2	
D7532	C-DIODE	ISS355	1	223269R2	
D7532 or	C-DIODE	ISS352	(1)	223234R2	
D7532 or	C-DIODE	MA2111	(1)	223279R2	
D7532 or	C-DIODE	KD S4148U	(1)	223283R2	
D7560	C-DIODE	ISS355	1	223269R2	
D7560 or	C-DIODE	ISS352	(1)	223234R2	
D7560 or	C-DIODE	MA2111	(1)	223279R2	
D7560 or	C-DIODE	KD S4148U	(1)	223283R2	
D7561	C-DIODE	ISS355	1	223269R2	
D7561 or	C-DIODE	ISS352	(1)	223234R2	
D7561 or	C-DIODE	MA2111	(1)	223279R2	
D7561 or	C-DIODE	KD S4148U	(1)	223283R2	
D7580	C-DIODE	ISS355	1	223269R2	
D7580 or	C-DIODE	ISS352	(1)	223234R2	
D7580 or	C-DIODE	MA2111	(1)	223279R2	
D7580 or	C-DIODE	KD S4148U	(1)	223283R2	
D7581	C-DIODE	ISS355	1	223269R2	
D7581 or	C-DIODE	ISS352	(1)	223234R2	
D7581 or	C-DIODE	MA2111	(1)	223279R2	
D7581 or	C-DIODE	KD S4148U	(1)	223283R2	
D7582	C-DIODE	ISS355	1	223269R2	
D7582 or	C-DIODE	ISS352	(1)	223234R2	
D7582 or	C-DIODE	MA2111	(1)	223279R2	

D7582 or	C-DIODE	KD-SM48U	(1)	22328R2	
D7583	C-DIODE	ISS355	1	22326R2	
D7583 or	C-DIODE	ISS352	(1)	22324R2	
D7583 or	C-DIODE	MA2111	(1)	22327R2	
D7583 or	C-DIODE	KD-SM48U	(1)	22328R2	
D7590	LED	SCB-3318E-D2	1	225487	
D7590A	HOLDER	(LED)LH-5-5	1	27191312	
D7593	LED	SLI-34378C-TE7	1	225490T	
D7595	LED	SLI-343URC-TE7	1	225449T	
D7597	LED	SLR-342MGTE7P	1	225455T	
D7599	LED	SCB-3318E-D2	1	225487	
D7599A	HOLDER	(LED)LH-5-5	1	27191312	
D7806	ZENER D	UDZS22B	1	22455220R2	
D7810	ZENER D	UDZS24B	1	22455240R2	
D7812	DIODE	RL1N4003	1	22380260T	
D7813	DIODE	RL1N4003	1	22380260T	
D7814	DIODE	RL1N4003	1	22380260T	
D7815	DIODE	RL1N4003	1	22380260T	
D7816	DIODE	RL1N4003	1	22380260T	
Q7500	FL TUBE	HNA-16SL05T	1	212271A	N
Q7500A	HOLDER	(FL)	1	27191303	
Q7501	IC	M66005-0001AHP	1	22242208R3	
Q7502	IC	M66005-0001AHP	1	22242208R3	
Q7503	TR	2SC2712-GR	1	2213145R2	
Q7504	TR	2SC2712-GR	1	2213145R2	
Q7530	IC	NIM4580M-D	1	22241448R2	
Q7532	TR	RN1441	1	2215410R2	
Q7533	TR	RN2403	1	2214540R2	
Q7533 or	TR	KRA103S	(1)	2216230R2	
Q7534	IC	NIM4580M-D	1	22241448R2	
Q7591	TR	DTIC123KA	1	2216690R2	
Q7595	TR	DTIC123KA	1	2216690R2	
Q7597	TR	DTIC123KA	1	2216690R2	
Q7598	TR	DTIC123KA	1	2216690R2	
Q7801	TR	2SC2235-Q(TPE 6_F)	1	2211653T	
Q7801 or	TR	2SC2235-Y(TPE 6_F)	(1)	2211654T	
TRANS COIL					
L7530	CHOKE COIL	LB02518TR2M	1	221364M022R2	
L7580	CHOKE COIL	LB02518TR2M	1	221364M022R2	
L7581	CHOKE COIL	LB02518TR2M	1	221364M022R2	
L7582	CHOKE COIL	LB02518TR2M	1	221364M022R2	
CAPA GTROR					
C7501	C-CERA C	CK725B1H-223K1	1	332102235R1	
C7502	C-CERA C	CK725F1E-104Z1	1	332161040R1	
C7503	C-CERA C	CK725F1E-104Z1	1	332161040R1	
C7504	C-CERA C	CK725B1H-473K1	1	332104735R1	
C7505	C-CERA C	CK725B1H-473K1	1	332104735R1	

C7506	ELECT C	CE04W50V-33M	1	355783309T
C7511	C-CERA C	CK725F1E-104Z1	1	332161040R1
C7512	C-CERA C	CK725CH1H-180U1	1	342101804R1
C7513	C-CERA C	CK725F1E-104Z1	1	332161040R1
C7514	C-CERA C	CK725F1E-104Z1	1	332161040R1
C7518	C-CERA C	CK725F1E-104Z1	1	332161040R1
C7519	C-CERA C	CK725F1E-104Z1	1	332161040R1
C7522	C-CERA C	CK725CH1H-221U1	1	342102214R1
C7523	C-CERA C	CK725CH1H-221U1	1	342102214R1
C7524	C-CERA C	CK725B1H-102K1	1	332101025R1
C7530	C-CERA C	CK725B1H-102K1	1	332101025R1
C7531	C-CERA C	CK725B1H-102K1	1	332101025R1
C7533	ELECT C	CE04W35V-47M	1	355764709T
C7534	ELECT C	CE04W35V-47M	1	355764709T
C7535	ELECT C	CE04W35V-10M(S)	1	353761009T
C7537	C-CERA C	CK725CH1H-330U1	1	342103304R1
C7538	ELECT C	CE04W35V-10M(S)	1	353761009T
C7539	ELECT C	CE04W35V-10M(S)	1	353761009T
C7540	ELECT C	CE04W35V-10M(S)	1	353761009T
C7543	C-CERA C	CK725B1H-102K1	1	332101025R1
C7560	ELECT C	CE04W6 3V-220M	1	35572219T
C7561	C-CERA C	CK725B1H-102K1	1	332101025R1
C7562	C-CERA C	CK725B1H-102K1	1	332101025R1
C7563	C-CERA C	CK725F1E-104Z1	1	332161040R1
C7580	MKT C	B 32529C0102J289	1	376491024T
C7581	MKT C	B 32529C0102J289	1	376491024T
C7582	MKT C	B 32529C0102J289	1	376491024T
C7583	MKT C	B 32529C0102J289	1	376491024T
C7590	C-CERA C	CK725B1H-103K1	1	332101035R1
C7591	C-CERA C	CK725B1H-103K1	1	332101035R1
C7804	VR C	CE04W63V-220M(VR)	1	394672217T
C7805	VR C	CE04W63V-47M(VR)	1	394674707T
C7806	C-CERA C	CK725B1H-223K1	1	332102235R1
C7900	C-CERA C	CK725F1E-104Z1	1	332161040R1
REVISION				
R7500	C-CARB ONR	RN72K1U-221E	1	435032214R1
R7501	C-CARB ONR	RN72K1U-221E	1	435032214R1
R7502	C-CARB ONR	RN72K1U-221E	1	435032214R1
R7503	C-CARB ONR	RN72K1U-222E	1	43503224R1
R7504	C-CARB ONR	RN72K1U-222E	1	43503224R1
R7505	C-CARB ONR	RN72K1U-222E	1	43503224R1
R7506	C-CARB ONR	RN72K1U-222E	1	43503224R1
R7507	C-CARB ONR	RN72K1U-222E	1	43503224R1
R7508	C-CARB ONR	RN72K1U-222E	1	43503224R1
R7509	C-CARB ONR	RN72K1U-222E	1	43503224R1
R7510	C-CARB ONR	RN72K1U-222E	1	43503224R1
R7521	C-CARB ONR	RN72K1U-331E	1	43503314R1

R7522	C-CARB ONR	RN72K U-331E	1	43503314R1
R7523	C-CARB ONR	RN72K U-750E	1	435037504R1
R7526	C-CARB ONR	RN72K U-223E	1	435032234R1
R7527	C-CARB ONR	RN72K U-223E	1	435032234R1
R7528	C-CARB ONR	RN72K U-224E	1	435032244R1
R7529	C-CARB ONR	RN72K U-224E	1	435032244R1
R7530	C-CARB ONR	RN72K U-472E	1	435034724R1
R7531	C-CARB ONR	RN72K U-101E	1	435031014R1
R7532	C-CARB ONR	RN72K U-331E	1	435033314R1
R7533	C-CARB ONR	RN72K U-182E	1	435031824R1
R7534	C-CARB ONR	RN72K U-104E	1	435031044R1
R7535	C-CARB ONR	RN72K U-102E	1	435031024R1
R7536	C-CARB ONR	RN72K U-533E	1	43503334R1
R7537	C-CARB ONR	RN72K U-333E	1	43503334R1
R7538	C-CARB ONR	RN72K U-221E	1	435032214R1
R7539	C-CARB ONR	RN72K U-221E	1	435032214R1
R7540	C-CARB ONR	RN72K U-473E	1	435034734R1
R7560	C-CARB ONR	RN72K U-102E	1	435031024R1
R7561	C-CARB ONR	RN72K U-101E	1	435031014R1
R7580	METAL O R	RS1WB L-33	1	443623304T
R7581	METAL O R	RS1WB L-33	1	443623304T
R7590	C-CARB ONR	RN72K U-103E	1	435031034R1
R7591	C-CARB ONR	RN72K U-103E	1	435031034R1
R7592	C-CARB ONR	RN72K U-103E	1	435031034R1
R7593	C-CARB ONR	RN72K U-103E	1	435031034R1
R7594	C-CARB ONR	RN72K U-121E	1	435031214R1
R7595	C-CARB ONR	RN72K U-181E	1	435031814R1
R7597	C-CARB ONR	RN72K U-102E	1	435031024R1
R7599	C-CARB ONR	RN72K U-102E	1	435031024R1
R7601	C-CARB ONR	RN72K U-121E	1	435031214R1
R7611	C-CARB ONR	RN72K U-271E	1	435032714R1
R7612	C-CARB ONR	RN72K U-331E	1	435033314R1
R7613	C-CARB ONR	RN72K U-471E	1	435034714R1
R7614	C-CARB ONR	RN72K U-561E	1	435035614R1
R7615	C-CARB ONR	RN72K U-821E	1	435038214R1
R7616	C-CARB ONR	RN72K U-122E	1	435031224R1
R7617	C-CARB ONR	RN72K U-222E	1	435032224R1
R7618	C-CARB ONR	RN72K U-392E	1	43503924R1
R7619	C-CARB ONR	RN72K U-123E	1	435031234R1
R7621	C-CARB ONR	RN72K U-271E	1	435032714R1
R7622	C-CARB ONR	RN72K U-331E	1	435033314R1
R7623	C-CARB ONR	RN72K U-471E	1	435034714R1
R7624	C-CARB ONR	RN72K U-561E	1	435035614R1
R7625	C-CARB ONR	RN72K U-821E	1	435038214R1
R7626	C-CARB ONR	RN72K U-122E	1	435031224R1
R7627	C-CARB ONR	RN72K U-222E	1	435032224R1
R7628	C-CARB ONR	RN72K U-392E	1	43503924R1

R7629	C-CARB ONR	RN7ZK-U-123JE	1	435031234R1
R7631	C-CARB ONR	RN7ZK-U-271JE	1	435032714R1
R7632	C-CARB ONR	RN7ZK-U-331JE	1	435033314R1
R7633	C-CARB ONR	RN7ZK-U-471JE	1	435034714R1
R7634	C-CARB ONR	RN7ZK-U-561JE	1	435035614R1
R7635	C-CARB ONR	RN7ZK-U-821JE	1	435038214R1
R7636	C-CARB ONR	RN7ZK-U-122JE	1	435031224R1
R7637	C-CARB ONR	RN7ZK-U-222JE	1	43503224R1
R7638	C-CARB ONR	RN7ZK-U-392JE	1	43503924R1
R7639	C-CARB ONR	RN7ZK-U-123JE	1	435031234R1
R7641	C-CARB ONR	RN7ZK-U-271JE	1	435032714R1
R7642	C-CARB ONR	RN7ZK-U-331JE	1	435033314R1
R7643	C-CARB ONR	RN7ZK-U-471JE	1	435034714R1
R7644	C-CARB ONR	RN7ZK-U-561JE	1	435035614R1
R7645	C-CARB ONR	RN7ZK-U-821JE	1	435038214R1
R7646	C-CARB ONR	RN7ZK-U-122JE	1	435031224R1
R7647	C-CARB ONR	RN7ZK-U-222JE	1	43503224R1
R7648	C-CARB ONR	RN7ZK-U-392JE	1	43503924R1
R7649	C-CARB ONR	RN7ZK-U-123JE	1	435031234R1
R7802	C-CARB ONR	RN7ZK-U-103JE	1	435031034R1
R7804	METAL O R	RSI/2WB-10	1	443521004T
R7805	C-CARB ONR	RN7ZK-U-562JE	1	435035624R1
R7807	C-CARB ONR	RN7ZK-U-333JE	1	43503334R1
R7808	METAL R	RNO1/2WGC-1	1	43530104T
R7810	METAL O R	RSI/2WB-33	1	443523304T
R7939	C-CARB ONR	RN7ZK-U-104JE	1	435031044R1
R7954	C-CARB ONR	RN7ZK-U-104JE	1	435031044R1
NEW TEAM				
E7530	RETAINER	(EARTH)	1	27142136B
E7580	TRM-423(SCREW)	NEJTANSI ST3	1	25060495
E7601	TRM-423(SCREW)	NEJTANSI ST3	1	25060495
JL4103A	WIRE HOL	NSCT-5P896	1	25051109
JL9303A	WIRE HOL	NSCT-5P876	1	25051089
JL9303B	WIRE TRAP	NPLG-5P588	1	25055626
P7303A	PLUG	NPLG-2P130	1	25055146
P7303B	SOCKET AS	NSAS-4P0867	1	2000E390415
P7501B	PLUG	A2545WR2-2x20X(IDE+OSIDE)	1	25056643
P7511	HOLDER	HOLDER(CLAMP)	1	27100540-1
P7512	HOLDER	HOLDER(CLAMP)	1	27100540-1
P7522	PIN JACK	NPJ-3PDB 693	1	25045925
P7523	ST JACK	MSJ-035-05A BAG SR LF	1	25045927
P7530	ST JACK	MSJ-035-05C B AG SR Rye	1	25045879
P7560B	PLUG	NPLG-3P0958	1	25056008
P7580	ST JACK	MSJ-064-05A SR	1	25045783
P7590A	SOCKET AS	NSAS-18P1674	1	20009910720L
P7590B	PLUG	NPLG-9P356	1	25055373
P9301A	PLUG	NPLG-6P120	1	25055136

Part Number	Description	Quantity	Part Number	Description	Quantity	Part Number	Description	Quantity
S7590	R-ENCODE	1	EC12E2425WITH WASHER		1	2506565SW		
S7611	PUSH SW	1	NPS-111-S681		1	25035718T		
S7611 or	PUSH SW	(1)	NPS-111-S677		(1)	25035714T		
S7612	PUSH SW	1	NPS-111-S681		1	25035718T		
S7612 or	PUSH SW	(1)	NPS-111-S677		(1)	25035714T		
S7613	PUSH SW	1	NPS-111-S681		1	25035718T		
S7613 or	PUSH SW	(1)	NPS-111-S677		(1)	25035714T		
S7616	PUSH SW	1	NPS-111-S681		1	25035718T		
S7616 or	PUSH SW	(1)	NPS-111-S677		(1)	25035714T		
S7618	PUSH SW	1	NPS-111-S681		1	25035718T		
S7618 or	PUSH SW	(1)	NPS-111-S677		(1)	25035714T		
S7619	PUSH SW	1	NPS-111-S681		1	25035718T		
S7619 or	PUSH SW	(1)	NPS-111-S677		(1)	25035714T		
S7620	PUSH SW	1	NPS-111-S681		1	25035718T		
S7620 or	PUSH SW	(1)	NPS-111-S677		(1)	25035714T		
S7621	PUSH SW	1	NPS-111-S681		1	25035718T		
S7621 or	PUSH SW	(1)	NPS-111-S677		(1)	25035714T		
S7622	PUSH SW	1	NPS-111-S681		1	25035718T		
S7622 or	PUSH SW	(1)	NPS-111-S677		(1)	25035714T		
S7624	PUSH SW	1	NPS-111-S681		1	25035718T		
S7624 or	PUSH SW	(1)	NPS-111-S677		(1)	25035714T		
S7625	PUSH SW	1	NPS-111-S681		1	25035718T		
S7625 or	PUSH SW	(1)	NPS-111-S677		(1)	25035714T		
S7626	PUSH SW	1	NPS-111-S681		1	25035718T		
S7626 or	PUSH SW	(1)	NPS-111-S677		(1)	25035714T		
S7627	PUSH SW	1	NPS-111-S681		1	25035718T		
S7627 or	PUSH SW	(1)	NPS-111-S677		(1)	25035714T		
S7628	PUSH SW	1	NPS-111-S681		1	25035718T		
S7628 or	PUSH SW	(1)	NPS-111-S677		(1)	25035714T		
S7629	PUSH SW	1	NPS-111-S681		1	25035718T		
S7629 or	PUSH SW	(1)	NPS-111-S677		(1)	25035714T		
S7630	PUSH SW	1	NPS-111-S681		1	25035718T		
S7630 or	PUSH SW	(1)	NPS-111-S677		(1)	25035714T		
S7632	PUSH SW	1	NPS-111-S681		1	25035718T		
S7632 or	PUSH SW	(1)	NPS-111-S677		(1)	25035714T		
S7633	PUSH SW	1	NPS-111-S681		1	25035718T		
S7633 or	PUSH SW	(1)	NPS-111-S677		(1)	25035714T		
S7634	PUSH SW	1	NPS-111-S681		1	25035718T		
S7634 or	PUSH SW	(1)	NPS-111-S677		(1)	25035714T		
S7636	PUSH SW	1	NPS-111-S681		1	25035718T		
S7636 or	PUSH SW	(1)	NPS-111-S677		(1)	25035714T		
S7638	PUSH SW	1	NPS-111-S681		1	25035718T		
S7638 or	PUSH SW	(1)	NPS-111-S677		(1)	25035714T		
S7639	PUSH SW	1	NPS-111-S681		1	25035718T		
S7639 or	PUSH SW	(1)	NPS-111-S677		(1)	25035714T		
S7640	PUSH SW	1	NPS-111-S681		1	25035718T		
S7640 or	PUSH SW	(1)	NPS-111-S677		(1)	25035714T		

S7641	PUSH SW	NPS-111-S681	1	25035718T	
S7641 or	PUSH SW	NPS-111-S677	(1)	25035714T	
S7642	PUSH SW	NPS-111-S681	1	25035718T	
S7642 or	PUSH SW	NPS-111-S677	(1)	25035714T	
S7643	PUSH SW	NPS-111-S681	1	25035718T	
S7643 or	PUSH SW	NPS-111-S677	(1)	25035714T	
S7644	PUSH SW	NPS-111-S681	1	25035718T	
S7644 or	PUSH SW	NPS-111-S677	(1)	25035714T	
S7645	PUSH SW	NPS-111-S681	1	25035718T	
S7645 or	PUSH SW	NPS-111-S677	(1)	25035714T	
S7646	PUSH SW	NPS-111-S681	1	25035718T	
S7646 or	PUSH SW	NPS-111-S677	(1)	25035714T	
S7647	PUSH SW	NPS-111-S681	1	25035718T	
S7647 or	PUSH SW	NPS-111-S677	(1)	25035714T	
S7648	PUSH SW	NPS-111-S681	1	25035718T	
S7648 or	PUSH SW	NPS-111-S677	(1)	25035714T	
S7650	PUSH SW	NPS-111-S681	1	25035718T	
S7650 or	PUSH SW	NPS-111-S677	(1)	25035714T	
[TUNER UNIT]					
U7500	REMO SENS	TSOP94338R1F	1	24130017	

TX-NR708

PC BOARD PARTS LIST

CIRCUIT NO.	PART NAME	DESCRIPTION	QTY	PART NO. (SN)	REMARKS
U007	HDMI PC BOARD AS	BAHDM-0471-1A	1	1B248671-1A	N
[MAIN CONDUCTOR]					
D3101	C-DIODE	KD S4148U	1	22328R2	
D3101 or	C-DIODE	ISS352	(1)	223234R2	
D3101 or	C-DIODE	MA21111	(1)	223279R2	
D3402	C-DIODE	ISR154-400	1	22380284R2	
D8161	ZENER D	UDZ53 6B	1	224550360R2	
D8204	DIODE	DAN217T146	1	22328R2	
D8205	DIODE	DAN217T146	1	22328R2	
D8301	DIODE	DAN217T146	1	22328R2	
D8302	C-DIODE	KD S4148U	1	22328R2	
D8302 or	C-DIODE	ISS352	(1)	223234R2	
D8302 or	C-DIODE	MA21111	(1)	223279R2	
D8701	C-DIODE	KD S4148U	1	22328R2	
D8701 or	C-DIODE	ISS352	(1)	223234R2	
D8701 or	C-DIODE	MA21111	(1)	223279R2	
D8931	C-DIODE	KD S4148U	1	22328R2	
D8931 or	C-DIODE	ISS352	(1)	223234R2	
D8931 or	C-DIODE	MA21111	(1)	223279R2	
D8951	DIODE	2B S303V17R	1	22380265R2	

D8961	DIODE		XB S303V17R	1	22380365R2	
D8971	DIODE		XB S303V17R	1	22380365R2	
D8981	DIODE		XB S303V17R	1	22380365R2	
D8983	C-DIODE		KD S4148U	1	223283R2	
D8983 or	C-DIODE		ISS352	(1)	223234R2	
D8983 or	C-DIODE		MA2J111	(1)	223279R2	
D8984	C-DIODE		KD S4148U	1	223283R2	
D8984 or	C-DIODE		ISS352	(1)	223234R2	
D8984 or	C-DIODE		MA2J111	(1)	223279R2	
Q205	IC		TC7AVHC15FT	1	22274157ER2TO	
Q3001	IC		D830K013BZKB300Z	1	22242662R3	N
Q3002	IC		NANVD256W3A2BN6E	1	222W0092R3	
Q3003	IC		IS42S16160C-7TL	1	22242592R3	
Q3003 or	IC		K4SS61632JUC75	(1)	22242544R3	
Q3004	IC		IS42S16160C-7TL	1	22242592R3	
Q3004 or	IC		K4SS61632JUC75	(1)	22242544R3	
Q3005	IC		TC7W32FU	1	22241162R2	
Q3006	IC		S-801270NMG-KM-T2	1	22241642R2	
Q3101	IC		TPD2E001DRLR	1	22242589R2	
Q3102	IC		BD2224G-TR	1	22242672R2	N
Q3103	IC		XC6221B182MR	1	22242632R2	N
Q3103 or	IC		BH18LBJ1W-G-TR	(1)	2224262R2	
Q3105	IC		MFB341S2164	1	22242594R2	
Q3106	IC		XC6221B332MR	1	22242633R2	
Q3106 or	IC		BH33FBJ1W-G-TR	(1)	22242655R2	
Q3107	IC		NIM2855DL1-33	1	22278033OR2IR	N
Q3108	IC		KS2804INL	1	22242591R2	
Q3109	IC		BD7820	1	22242300R2	
Q3302	IC		TC7AVHC15FT	1	22274157ER2TO	
Q3304	IC		TC7AVHC74FT (EKJ)	1	22274074ER2TO	
Q3304 or	IC		TC7AVHC74FT	(1)	22274074ER2TO	
Q3305	IC		TC7SZU04FU	1	22242512R2TO	
Q3306	IC		NIM4580M-D	1	22241448R2	
Q3307	IC		NIM4580M-D	1	22241448R2	
Q3310	IC		TC7WH241FU(TEL,F)	1	22242076R2TO	
Q3401	IC		EN2SQ32A-100HIP	1	222W0112R2	N
Q3403	IC		TC7WH004FU(TEL2L)	1	22242231R2	
Q3404	IC		CS90834A-CQZ	1	22242639R3	
Q3405	IC		TC7AVHC125FT	1	22274125ER2TO	
Q3406	IC		KAS641632N-LC60	1	22242603R2	
Q3407	TR		DTC144EE	1	2216390R2	
Q3407 or	TR		KRC404E	(1)	2216450R2	
Q3408	IC		TC7MBL3245SFT	1	22242539R2TO	
Q3409	IC		NIM2855DL1-33	1	22278033OR2IR	N
Q3604	IC		PCM1754DBOR	1	22242598R2	
Q8000	IC		TC74AC14FT	1	22242217R2	
Q8051	IC		N75JTJ32M160G-25G	1	22242635R3	

Q8852	IC		NT5TU32M16CG-25C	1	22242635R3
Q8161	IC		S19389C TU	1	22242628R3
Q8162	TR		RN2401(TE8SL_F)	1	2214520R2
Q8191	IC		SN74CB30305PWR	1	22242558R2
Q8200	IC		FL132626H-AE	1	22242634R3
Q8201	IC		BR24S32F1WE2	1	22242569R2
Q8201 or	IC		24LC32A-1VSN	(1)	22242521R2
Q8201 or	IC		M24C32-WMANTP	(1)	22242644R2
Q8206	IC		AT25DF641-SSH-T	1	22242611R2
Q8207	IC		TC74L CX125FTEL_K)	1	22274125B R2TO
Q8305	IC		S-812C50BU-C-CSET2G	1	22242407R2
Q8306	IC		NC7S208P5X-F042	1	22242482R2
Q8306 or	IC		TC7S208FU(TE8SL_F)	(1)	22242071R 2TO
Q8401	IC		SI9136C TU	1	22242630R3
Q8402	IC		TC7WHU04FU(TE12L)	1	22242231R2
Q8501	IC		SI9233A CTU	1	22242582R3
Q8610	IC		S-24CS02AFT-V-G	1	22242608R2
Q8610 or	IC		BR24L02FV-AW	(1)	22242069R2
Q8701	IC		MPD70F3740G-C-DEC-AX	1	22242009R3
Q8702	TR	ARRAY	UM6K1N	1	226066R2
Q8801	IC		TC74V CX162827	1	22242395R2
Q8802	IC		TC74V CX162827	1	22242395R2
Q8803	IC		TC74V CX162827	1	22242395R2
Q8804	IC		TC74V CX162827	1	22242395R2
Q8805	TR		KRC104S	1	2216210R2
Q8805 or	TR		RN1404	(1)	2214490R2
Q8931	IC		XC6202P502R	1	22242331R2
Q8932	IC		XC6221B332MR	1	22242633R2
Q8932 or	IC		BH33FB1W-G-TR	(1)	22242585R2
Q8933	IC		XC6221B122MR	1	22242631R2
Q8934	TR		KRC104S	1	2216210R2
Q8934 or	TR		RN1404	(1)	2214490R2
Q8935	TR		Z5C2712-GR	1	2213145R2
Q8936	TR		KRC104S	1	2216210R2
Q8936 or	TR		RN1404	(1)	2214490R2
Q8941	IC		CM3202-02DE	1	22242641R2
Q8951	TR		KRC104S	1	2216210R2
Q8951 or	TR		RN1404	(1)	2214490R2
Q8952	IC		MP2363DNLF-Z	1	22242627R2
Q8961	TR		KRC104S	1	2216210R2
Q8961 or	TR		RN1404	(1)	2214490R2
Q8962	IC		MP2363DNLF-Z	1	22242627R2
Q8963	TR		Z5C2712-GR	1	2213145R2
Q8971	TR		KRC104S	1	2216210R2
Q8971 or	TR		RN1404	(1)	2214490R2
Q8972	IC		MP2363DNLF-Z	1	22242627R2
Q8981	TR		KRC104S	1	2216210R2

Q8981 or	TR		RN1404	(1)	2214490R.2
Q8982	IC		MP2363DNLF-Z	1	22242627R.2
Q8983	TR		KRC104S	1	2216210R.2
Q8983 or	TR		RN1404	(1)	2214490R.2
Q8984	TR		KRC104S	1	2216210R.2
Q8984 or	TR		RN1404	(1)	2214490R.2
TRANS COIL					
L231	CORE		BLM18PG181SNID	1	2350005R.1
L261	EMIFIL		BK1608LM182-T	1	230058R.1
L3001	CORE		BLM18PG121SNID	1	2350006R.1
L3002	CORE		BLM18PG121SNID	1	2350006R.1
L3003	CORE		BLM18PG121SNID	1	2350006R.1
L3004	CORE		BLM18PG121SNID	1	2350006R.1
L3005	CORE		BLM18PG121SNID	1	2350006R.1
L3102	CORE		BLM18PG181SNID	1	2350005R.1
L3103	CORE		BLM18PG121SNID	1	2350006R.1
L3104	CORE		BLM18PG121SNID	1	2350006R.1
L3105	CORE		BLM18PG121SNID	1	2350006R.1
L3106	CORE		BLM18PG121SNID	1	2350006R.1
L3107	CORE		BLM18PG121SNID	1	2350006R.1
L3108	CORE		BLM18PG121SNID	1	2350006R.1
L3109	CORE		BLM18PG121SNID	1	2350006R.1
L3110	CORE		BLM18PG121SNID	1	2350006R.1
L3145	CORE		DLP2ADNP00HL4L	1	230990R.2
L3202	CORE		MMZ1608Y601B-T	1	2350004R.1
L3203	CORE		MMZ1608Y601B-T	1	2350004R.1
L3205	CORE		BLM18PG121SNID	1	2350006R.1
L3206	CORE		BLM18PG121SNID	1	2350006R.1
L3207	CORE		MMZ1608Y601B-T	1	2350004R.1
L3208	CORE		MMZ1608Y601B-T	1	2350004R.1
L3209	CORE		MMZ1608Y601B-T	1	2350004R.1
L3401	CORE		BLM18PG121SNID	1	2350006R.1
L3402	CORE		MMZ1608Y601B-T	1	2350004R.1
L3403	CORE		MMZ1608Y601B-T	1	2350004R.1
L3404	CORE		MMZ1608Y601B-T	1	2350004R.1
L3405	CORE		BLM18PG121SNID	1	2350006R.1
L3406	CORE		BLM18PG121SNID	1	2350006R.1
L3407	CORE		BLM18PG121SNID	1	2350006R.1
L3408	CORE		BLM18PG121SNID	1	2350006R.1
L3509	CHOKE COIL		LB02518T470M	1	231364M470R.2
L8001	CORE		BLM18PG181SNID	1	2350005R.1
L8002	CORE		BLM18PG181SNID	1	2350005R.1
L8004	CORE		BLM18PG181SNID	1	2350005R.1
L8006	CORE		BLM18PG181SNID	1	2350005R.1
L8007	CORE		BLM18PG181SNID	1	2350005R.1
L8161	CORE		BLM18PG181SNID	1	2350005R.1
L8162	CORE		BLM18PG181SNID	1	2350005R.1

L8163	CORE		BLM18PG181SNID	1	2350005R1	
L8164	CORE		BLM18PG181SNID	1	2350005R1	
L8166	CORE		BLM18PG181SNID	1	2350005R1	
L8200	CORE		BLM18PG181SNID	1	2350005R1	
L8201	CORE		BLM18PG181SNID	1	2350005R1	
L8202	CORE		BLM18PG181SNID	1	2350005R1	
L8203	CORE		BLM18PG181SNID	1	2350005R1	
L8204	CORE		BLM18PG181SNID	1	2350005R1	
L8205	CORE		BLM18PG181SNID	1	2350005R1	
L8206	CORE		BLM18PG181SNID	1	2350005R1	
L8207	CORE		BLM18PG121SNID	1	2350006R1	
L8208	CORE		BLM18PG181SNID	1	2350005R1	
L8209	CORE		BLM18PG181SNID	1	2350005R1	
L8210	CORE		BLM18PG181SNID	1	2350005R1	
L8211	CORE		BLM18PG181SNID	1	2350005R1	
L8212	CORE		BLM18PG181SNID	1	2350005R1	
L8213	CORE		BLM18PG181SNID	1	2350005R1	
L8214	CORE		BLM18PG181SNID	1	2350005R1	
L8215	C-CARB ONR		RN72K11-000JE	1	435030004R1	
L8216	CORE		BLM18PG181SNID	1	2350005R1	
L8217	CORE		BLM18PG181SNID	1	2350005R1	
L8218	CORE		BLM18PG181SNID	1	2350005R1	
L8301	CORE		BLM18PG181SNID	1	2350005R1	
L8401	CORE		BLM18PG181SNID	1	2350005R1	
L8402	CORE		BLM18PG181SNID	1	2350005R1	
L8403	CORE		BLM18PG181SNID	1	2350005R1	
L8404	CORE		BLM18PG181SNID	1	2350005R1	
L8406	C-R NET		NMR12E0APJ000	1	43464900002R2	
L8407	C-R NET		NMR12E0APJ000	1	43464900002R2	
L8409	C-R NET		NMR12E0APJ000	1	43464900002R2	
L8410	C-R NET		NMR12E0APJ000	1	43464900002R2	
L8501	CORE		BLM18PG181SNID	1	2350005R1	
L8502	CORE		BLM18PG181SNID	1	2350005R1	
L8503	CORE		BLM18PG181SNID	1	2350005R1	
L8504	CORE		BLM18PG181SNID	1	2350005R1	
L8505	CORE		BLM18PG181SNID	1	2350005R1	
L8506	CORE		BLM18PG181SNID	1	2350005R1	
L8561	CORE		BLM18PG181SNID	1	2350005R1	
L8608	CORE		NMR21608Y601B-T	1	2350004R1	
L8641	CORE		BLM18PG181SNID	1	2350005R1	
L8701	CORE		BLM18PG181SNID	1	2350005R1	
L8801	CORE		BLM18PG181SNID	1	2350005R1	
L8930	CORE		BLM18PG181SNID	1	2350005R1	
L8931	CORE		BLM18PG181SNID	1	2350005R1	
L8941	CHOKE COIL		BLM21PG221SN1	1	230949R2	
L8951	CHOKE COIL		BLM21PG221SN1	1	230949R2	
L8952	CHOKE COIL		0182-7E08Q-100M4R4	1	231396M100R2	

L8953	CHOKE COIL	BLM21PG221SN1	1	230049R2
L8954	CHOKE COIL	BLM21PG221SN1	1	230049R2
L8955	CHOKE COIL	BLM21PG221SN1	1	230049R2
L8956	CHOKE COIL	BLM21PG221SN1	1	230049R2
L8961	CHOKE COIL	BLM21PG221SN1	1	230049R2
L8962	CHOKE COIL	0182-7E08Q-100M-FA	1	231396M100R2
L8963	CHOKE COIL	BLM21PG221SN1	1	230049R2
L8964	CHOKE COIL	BLM21PG221SN1	1	230049R2
L8965	CHOKE COIL	BLM21PG221SN1	1	230049R2
L8971	CHOKE COIL	BLM21PG221SN1	1	230049R2
L8972	CHOKE COIL	0182-7E08Q-100M-FA	1	231396M100R2
L8973	CHOKE COIL	BLM21PG221SN1	1	230049R2
L8974	CHOKE COIL	BLM21PG221SN1	1	230049R2
L8975	CHOKE COIL	BLM21PG221SN1	1	230049R2
L8981	CHOKE COIL	BLM21PG221SN1	1	230049R2
L8982	CHOKE COIL	0182-7E08Q-100M-FA	1	231396M100R2
L8983	CHOKE COIL	BLM21PG221SN1	1	230049R2
L8984	CHOKE COIL	BLM21PG221SN1	1	230049R2
L8985	CHOKE COIL	BLM21PG221SN1	1	230049R2
X3001	CRYSTAL	HC-49SMDD24 000MHz	1	3010479R2
X3202	CRYSTAL	HC-49SMDD 11 289.6MHz	1	3010480R2
X3401	CRYSTAL	HC-49SMDD24 576MHz+-50ppm	1	3010494R2
X8200	CRYSTAL	HC-49U SSMDD19 6608MHz	1	3010489R2
X8301	CRYSTAL	DSX321G-27MHz	1	3010487R2
X3701	CERA LOCK	CTCR3M00053-B0	1	3010356R2
CALIFORNIA				
C251	C-CERA C	CK725F1E-104Z1	1	332161040R1
C252	C-CERA C	CK725B1H-102K1	1	332101025R1
C253	C-CERA C	CK725B0J-106K	1	332091065R2
C3001	C-CERA C	CK725F1A-105Z1	1	332181050R1
C3002	C-CERA C	CK725F1A-105Z1	1	332181050R1
C3003	C-CERA C	CK725B0J-106K	1	332091065R2
C3004	C-CERA C	CK725B0J-106K	1	332091065R2
C3005	C-CERA C	CK725F1A-105Z1	1	332181050R1
C3006	C-CERA C	CG725CH1H-102J1	1	342101024R1
C3007	C-CERA C	CK725F1A-105Z1	1	332181050R1
C3008	C-CERA C	CG725CH1H-102J1	1	342101024R1
C3009	C-CERA C	CK725F1A-105Z1	1	332181050R1
C3010	C-CERA C	CK725F1A-105Z1	1	332181050R1
C3011	C-CERA C	CK725F1A-105Z1	1	332181050R1
C3012	C-CERA C	CG725CH1H-102J1	1	342101024R1
C3013	C-CERA C	CK725F1A-105Z1	1	332181050R1
C3014	C-CERA C	CG725CH1H-102J1	1	342101024R1
C3015	C-CERA C	CG725CH1H-102J1	1	342101024R1
C3016	C-CERA C	CK725F1A-105Z1	1	332181050R1
C3017	C-CERA C	CK725F1A-105Z1	1	332181050R1
C3018	C-CERA C	CK725F1A-105Z1	1	332181050R1

C3019	C-CERA C	C6725CH1H-10211	1	342101024R1
C3020	C-CERA C	CK725F1A-10521	1	332181050R1
C3021	C-CERA C	CK725F1A-10521	1	332181050R1
C3022	C-CERA C	CK725F1A-10521	1	332181050R1
C3023	C-CERA C	CK725B01-106K	1	332091065R2
C3024	C-CERA C	C6725CH1H-10211	1	342101024R1
C3025	C-CERA C	CK725F1A-10521	1	332181050R1
C3026	C-CERA C	CK725B1C-104K1	1	332121045R1
C3027	C-CERA C	C6725CH1H-10211	1	342101024R1
C3028	C-CERA C	CK725F1A-10521	1	332181050R1
C3029	C-CERA C	C6725CH1H-10211	1	342101024R1
C3030	C-CERA C	CK725F1A-10521	1	332181050R1
C3031	C-CERA C	CK725F1A-10521	1	332181050R1
C3032	C-CERA C	C6725CH1H-10211	1	342101024R1
C3033	C-CERA C	CK725F1A-10521	1	332181050R1
C3034	C-CERA C	C6725CH1H-12011	1	342101204R1
C3035	C-CERA C	C6725CH1H-10211	1	342101024R1
C3036	C-CERA C	C6725CH1H-12011	1	342101204R1
C3037	C-CERA C	CK725F1A-10521	1	332181050R1
C3038	C-CERA C	CK725F1A-10521	1	332181050R1
C3039	C-CERA C	CK725B1H-103K1	1	332101035R1
C3040	C-CERA C	CK725F1A-10521	1	332181050R1
C3041	C-CERA C	CK725B01-106K	1	332091065R2
C3042	C-CERA C	CK725F1A-10521	1	332181050R1
C3043	C-CERA C	CK725F1A-10521	1	332181050R1
C3101	CHIP ELECT C	CEWX16V-100M	1	398141017R2
C3102	CHIP ELECT C	CEWX10V-220M	1	398132217R2
C3104	C-CERA C	CK725F1A-10521	1	332181050R1
C3105	C-CERA C	CK725F1A-10521	1	332181050R1
C3106	C-CERA C	CK725B01-106K	1	332091065R2
C3107	C-CERA C	CK725F1A-10521	1	332181050R1
C3108	C-CERA C	CK725F1A-10521	1	332181050R1
C3109	C-CERA C	CK725B01-106K	1	332091065R2
C3110	C-CERA C	CK725B1A-24K1	1	33213245R1
C3112	C-CERA C	CK725B01-106K	1	332091065R2
C3113	C-CERA C	CK725F1A-10521	1	332181050R1
C3114	C-CERA C	CK725F1A-10521	1	332181050R1
C3115	C-CERA C	CK725B01-106K	1	332091065R2
C3116	C-CERA C	CK725B01-106K	1	332091065R2
C3117	C-CERA C	C6725CH1H-10211	1	342101024R1
C3118	C-CERA C	CK725F1A-10521	1	332181050R1
C3119	C-CERA C	CK725F1A-10521	1	332181050R1
C3120	C-CERA C	CK725B01-106K	1	332091065R2
C3121	C-CERA C	CK725F1A-10521	1	332181050R1
C3122	C-CERA C	CK725F1A-10521	1	332181050R1
C3123	CHIP ELECT C	CEWX10V-220M	1	398132217R2
C3124	C-CERA C	CK725F1A-10521	1	332181050R1

C3125	C-CERA C	CK725B01-106K	1	332091065R2
C3126	C-CERA C	CK725B01-106K	1	332091065R2
C3127	C-CERA C	CK725F1A-105Z1	1	332181050R1
C3128	C-CERA C	CK725F1A-105Z1	1	332181050R1
C3129	C-CERA C	CK725F1A-105Z1	1	332181050R1
C3130	C-CERA C	CK725B01-106K	1	332091065R2
C3131	C-CERA C	CK725F1A-105Z1	1	332181050R1
C3132	C-CERA C	CK725CH1H-101J1	1	342101014R1
C3133	C-CERA C	CK725F1A-105Z1	1	332181050R1
C3134	C-CERA C	CK725B1C-104K1	1	332121045R1
C3135	C-CERA C	CK725B1C-104K1	1	332121045R1
C3136	C-CERA C	CK725F1A-105Z1	1	332181050R1
C3137	C-CERA C	CK725F1A-105Z1	1	332181050R1
C3138	C-CERA C	CK725F1A-105Z1	1	332181050R1
C3139	C-CERA C	CK725F1A-105Z1	1	332181050R1
C3140	C-CERA C	CK725F1A-105Z1	1	332181050R1
C3141	C-CERA C	CK725F1A-105Z1	1	332181050R1
C3142	C-CERA C	CK725F1A-105Z1	1	332181050R1
C3143	C-CERA C	CK725F1A-105Z1	1	332181050R1
C3144	C-CERA C	CK725F1A-105Z1	1	332181050R1
C3145	C-CERA C	CK725B01-106K	1	332091065R2
C3146	C-CERA C	CK725F1A-105Z1	1	332181050R1
C3147	C-CERA C	CK725B01-106K	1	332091065R2
C3148	C-CERA C	CK725B1H-223K1	1	332102235R1
C3149	C-CERA C	CK725F1A-105Z1	1	332181050R1
C3150	CHIP ELECT C	CEWX4V-22M	1	398102207R2
C3151	C-CERA C	CK725B1H-103K1	1	332101035R1
C3152	C-CERA C	CK725B01-106K	1	332091065R2
C3153	C-CERA C	CK725F1A-105Z1	1	332181050R1
C3154	C-CERA C	CK725B01-106K	1	332091065R2
C3155	C-CERA C	CK725F1A-105Z1	1	332181050R1
C3156	C-CERA C	CK725CH1H-102J1	1	342101024R1
C3157	C-CERA C	CK725F1A-105Z1	1	332181050R1
C3158	C-CERA C	CK725F1A-105Z1	1	332181050R1
C3159	C-CERA C	CK725F1A-105Z1	1	332181050R1
C3202	C-CERA C	CK725F1A-105Z1	1	332181050R1
C3204	C-CERA C	CK725B01-106K	1	332091065R2
C3205	C-CERA C	CK725F1A-105Z1	1	332181050R1
C3206	C-CERA C	CK725F1A-105Z1	1	332181050R1
C3207	C-CERA C	CK725B01-106K	1	332091065R2
C3208	C-CERA C	CK725F1A-105Z1	1	332181050R1
C3209	C-CERA C	CK725F1A-105Z1	1	332181050R1
C3210	CHIP ELECT C	CEWX16V-100M	1	398141017R2
C3211	C-CERA C	CK725CH1H-221J1	1	342102214R1
C3213	C-CERA C	CK725F1A-105Z1	1	332181050R1
C3214	C-CERA C	CK725B01-106K	1	332091065R2
C3215	CHIP ELECT C	CEWX16V-10M	1	398141007R2
C3220	C-CERA C	CK725CH1H-120J1	1	342101204R1
C3223	C-CERA C	CK725CH1H-120J1	1	342101204R1

C3324	C-CERA C	CK725CH1H-15211	1	342101524R1
C3325	C-CERA C	CK725CH1H-15211	1	342101524R1
C3326	C-CERA C	CK725F1A-10521	1	332181050R1
C3327	CHIP ELECT C	CEWXY16V-100M	1	398141007R2
C3328	C-CERA C	CK725CH1H-22111	1	342102214R1
C3329	C-CERA C	CK725F1A-10521	1	332181050R1
C3330	C-CERA C	CK725B0U-106K	1	332091065R2
C3331	C-CERA C	CK725F1A-10521	1	332181050R1
C3333	CHIP ELECT C	CEWXY16V-100M	1	398141017R2
C3334	C-CERA C	CK725B0U-106K	1	332091065R2
C3401	C-CERA C	CK725CH1H-10211	1	342101024R1
C3402	C-CERA C	CK725F1E-10421	1	332161040R1
C3403	C-CERA C	CK725F1E-10421	1	332161040R1
C3404	C-CERA C	CK725F1E-10421	1	332161040R1
C3405	C-CERA C	CK725F1E-10421	1	332161040R1
C3406	C-CERA C	CK725F1A-10521	1	332181050R1
C3407	C-CERA C	CK725F1A-10521	1	332181050R1
C3408	C-CERA C	CK725B0U-106K	1	332091065R2
C3409	C-CERA C	CK725F1A-10521	1	332181050R1
C3410	C-CERA C	CK725F1E-10421	1	332161040R1
C3411	C-CERA C	CK725F1E-10421	1	332161040R1
C3412	C-CERA C	CK725F1E-10421	1	332161040R1
C3413	C-CERA C	CK725CH1H-18011	1	342101804R1
C3414	C-CERA C	CK725CH1H-18011	1	342101804R1
C3415	C-CERA C	CK725F1E-10421	1	332161040R1
C3416	C-CERA C	CK725F1E-10421	1	332161040R1
C3418	C-CERA C	CK725F1E-10421	1	332161040R1
C3419	C-CERA C	CK725F1E-10421	1	332161040R1
C3420	C-CERA C	CK725F1E-10421	1	332161040R1
C3422	C-CERA C	CK725F1E-10421	1	332161040R1
C3423	C-CERA C	CK725F1E-10421	1	332161040R1
C3425	C-CERA C	CK725F1E-10421	1	332161040R1
C3426	C-CERA C	CK725CH1H-10211	1	342101024R1
C3427	C-CERA C	CK725F1E-10421	1	332161040R1
C3428	C-CERA C	CK725CH1H-10211	1	342101024R1
C3429	C-CERA C	CK725F1E-10421	1	332161040R1
C3430	C-CERA C	CK725F1A-10521	1	332181050R1
C3431	C-CERA C	CK725CH1H-10211	1	342101024R1
C3432	C-CERA C	CK725CH1H-10211	1	342101024R1
C3433	C-CERA C	CK725F1A-10521	1	332181050R1
C3434	C-CERA C	CK725B0U-106K	1	332091065R2
C3435	C-CERA C	CK725B0U-106K	1	332091065R2
C3436	C-CERA C	CK725B0U-106K	1	332091065R2
C3437	C-CERA C	CK725F1E-10421	1	332161040R1
C3438	C-CERA C	CK725F1E-10421	1	332161040R1
C3439	C-CERA C	CK725F1E-10421	1	332161040R1
C3440	C-CERA C	CK725F1E-10421	1	332161040R1

C3441	C-CERA C	CK725F1A-105Z1	1	332181050R1	
C3442	C-CERA C	CK725B01-106K	1	332091065R2	
C3443	C-CERA C	CK725F1A-105Z1	1	332181050R1	
C3444	C-CERA C	CK725F1A-105Z1	1	332181050R1	
C3445	C-CERA C	CK725F1A-105Z1	1	332181050R1	
C3446	C-CERA C	CK725F1A-105Z1	1	332181050R1	
C3447	C-CERA C	CK725F1A-105Z1	1	332181050R1	
C3448	CHIP ELECT C	CEWX63V-22M	1	398122207R2	
C3449	CHIP ELECT C	CEWX4V-220M	1	3981G2217R2	
C3457	C-CERA C	CK725F1A-105Z1	1	332181050R1	
C3458	C-CERA C	CK725F1A-105Z1	1	332181050R1	
C3459	C-CERA C	CK725F1A-105Z1	1	332181050R1	
C3460	C-CERA C	CK725F1E-104Z1	1	332161040R1	
C3461	C-CERA C	CK725F1E-104Z1	1	332161040R1	
C3462	C-CERA C	CK725B01-106K	1	332091065R2	
C3466	C-CERA C	CK725F1E-104Z1	1	332161040R1	
C3603	C-CERA C	CK725B1H-102K1	1	332101025R1	
C8001	C-CERA C	CK725B1C-104K1	1	332121045R1	
C8004	C-CERA C	CK725B1C-104K1	1	332121045R1	
C8005	C-CERA C	CK725B1C-104K1	1	332121045R1	
C8007	C-CERA C	CK725B1C-104K1	1	332121045R1	
C8008	C-CERA C	CK725B1C-104K1	1	332121045R1	
C8010	C-CERA C	CK725B1C-104K1	1	332121045R1	
C8011	C-CERA C	CK725B1C-104K1	1	332121045R1	
C8015	C-CERA C	CK725B1C-104K1	1	332121045R1	
C8016	C-CERA C	CK725B1C-104K1	1	332121045R1	
C8017	C-CERA C	CK725B1C-104K1	1	332121045R1	
C8020	C-CERA C	CK725B1C-104K1	1	332121045R1	
C8021	C-CERA C	CK725B1C-104K1	1	332121045R1	
C8022	C-CERA C	CK725B1C-104K1	1	332121045R1	
C8023	C-CERA C	CK725B1C-104K1	1	332121045R1	
C8024	C-CERA C	CK725B1C-104K1	1	332121045R1	
C8025	C-CERA C	CK725B1C-104K1	1	332121045R1	
C8026	C-CERA C	CK725B1C-104K1	1	332121045R1	
C8027	C-CERA C	CK725B1C-104K1	1	332121045R1	
C8028	C-CERA C	CK725B1C-104K1	1	332121045R1	
C8029	C-CERA C	CK725F1E-104Z1	1	332161040R1	
C8030	C-CERA C	CK725B01-106K	1	332091065R2	
C8031	C-CERA C	CK725B01-106K	1	332091065R2	
C8032	CHIP TANTAL	TEESVA01226M8R	1	398422207R2	
C8032 or	CHIP TANTAL	P93-6 3V-22M	(1)	395522207R2	
C8032 or	CHIP TANTAL	TSCS01226M4AR	(1)	396522207R2	
C8033	C-CERA C	CK725F1E-104Z1	1	332161040R1	
C8034	C-CERA C	CK725B1H-102K1	1	332101025R1	
C8035	C-CERA C	CK725F1E-104Z1	1	332161040R1	
C8036	C-CERA C	CK725B01-106K	1	332091065R2	
C8037	C-CERA C	CK725B01-106K	1	332091065R2	

N

C8038	CHIP TANTAL	TEESVA0226M8R	1	398422207R2	N
C8038 or	CHIP TANTAL	F93-6 3V-22M	(1)	395522207R2	
C8038 or	CHIP TANTAL	TCSCS0U226M4AR	(1)	396522207R2	
C8039	C-CERA C	CK725F1E-104Z1	1	332161040R1	
C8051	CHIP TANTAL	TEESVA0226M8R	1	398422207R2	N
C8051 or	CHIP TANTAL	F93-6 3V-22M	(1)	395522207R2	
C8051 or	CHIP TANTAL	TCSCS0U226M4AR	(1)	396522207R2	
C8052	C-CERA C	CK725F1A-105Z1	1	332181050R1	
C8053	C-CERA C	CK725F1E-104Z1	1	332161040R1	
C8054	C-CERA C	CK725B1H-103K1	1	332101025R1	
C8055	C-CERA C	CK725B0U-106K	1	332091065R2	
C8056	C-CERA C	CK725F1E-104Z1	1	332161040R1	
C8057	C-CERA C	CK725B1H-103K1	1	332101025R1	
C8058	C-CERA C	CK725B1H-103K1	1	332101035R1	
C8059	C-CERA C	CK725B1H-102K1	1	332101025R1	
C8060	C-CERA C	CK725B1H-103K1	1	332101035R1	
C8061	C-CERA C	CK725B1H-102K1	1	332101025R1	
C8062	C-CERA C	CK725B1H-103K1	1	332101035R1	
C8063	C-CERA C	CK725B1H-102K1	1	332101025R1	
C8064	C-CERA C	CK725B1H-103K1	1	332101035R1	
C8065	C-CERA C	CK725B0U-106K	1	332091065R2	
C8066	C-CERA C	CK725B1H-102K1	1	332101025R1	
C8067	C-CERA C	CK725B1H-103K1	1	332101035R1	
C8068	C-CERA C	CK725B1H-102K1	1	332101025R1	
C8069	C-CERA C	CK725B1H-103K1	1	332101035R1	
C8070	C-CERA C	CK725B1H-102K1	1	332101025R1	
C8071	C-CERA C	CK725B1H-103K1	1	332101035R1	
C8072	C-CERA C	CK725B1H-102K1	1	332101025R1	
C8073	C-CERA C	CK725B1H-103K1	1	332101035R1	
C8074	CHIP TANTAL	TEESVA0226M8R	1	398422207R2	N
C8074 or	CHIP TANTAL	F93-6 3V-22M	(1)	395522207R2	
C8074 or	CHIP TANTAL	TCSCS0U226M4AR	(1)	396522207R2	
C8075	C-CERA C	CK725F1A-105Z1	1	332181050R1	
C8076	C-CERA C	CK725F1E-104Z1	1	332161040R1	
C8077	C-CERA C	CK725B1H-102K1	1	332101025R1	
C8079	C-CERA C	CK725F1E-104Z1	1	332161040R1	
C8080	C-CERA C	CK725B1H-102K1	1	332101025R1	
C8081	C-CERA C	CK725B1H-103K1	1	332101035R1	
C8082	C-CERA C	CK725B1H-102K1	1	332101025R1	
C8083	C-CERA C	CK725B1H-103K1	1	332101035R1	
C8084	C-CERA C	CK725B1H-102K1	1	332101025R1	
C8085	C-CERA C	CK725B1H-103K1	1	332101035R1	
C8086	C-CERA C	CK725B1H-102K1	1	332101025R1	
C8087	C-CERA C	CK725B1H-103K1	1	332101035R1	
C8088	C-CERA C	CK725B0U-106K	1	332091065R2	
C8089	C-CERA C	CK725B1H-102K1	1	332101025R1	
C8090	C-CERA C	CK725B1H-103K1	1	332101035R1	

C8191	C-CERA C	CK725B1H-102K1	1	332101025R1
C8192	C-CERA C	CK725B1H-103K1	1	332101035R1
C8193	C-CERA C	CK725B1H-102K1	1	332101025R1
C8194	C-CERA C	CK725B1H-103K1	1	332101035R1
C8195	C-CERA C	CK725B1H-102K1	1	332101025R1
C8196	C-CERA C	CK725B1H-103K1	1	332101035R1
C8197	C-CERA C	CK725B1H-102K1	1	332101025R1
C8198	C-CERA C	CK725B1H-103K1	1	332101035R1
C8199	C-CERA C	CK725B1H-102K1	1	332101025R1
C8200	C-CERA C	CK725B1H-103K1	1	332101035R1
C8167	C-CERA C	CK725F1E-104Z1	1	332161040R1
C8168	C-CERA C	CK725F1E-104Z1	1	332161040R1
C8169	C-CERA C	CK725F1E-104Z1	1	332161040R1
C8170	C-CERA C	CK725B1H-102K1	1	332101025R1
C8171	C-CERA C	CK725F1E-104Z1	1	332161040R1
C8172	C-CERA C	CK725B1H-102K1	1	332101025R1
C8173	C-CERA C	CK725F1E-104Z1	1	332161040R1
C8174	C-CERA C	CK725B1H-102K1	1	332101025R1
C8175	C-CERA C	CK725F1E-104Z1	1	332161040R1
C8176	C-CERA C	CK725B1H-102K1	1	332101025R1
C8177	C-CERA C	CK725F1E-104Z1	1	332161040R1
C8178	C-CERA C	CK725B1H-102K1	1	332101025R1
C8179	C-CERA C	CK725F1E-104Z1	1	332161040R1
C8180	C-CERA C	CK725B1H-102K1	1	332101025R1
C8181	C-CERA C	CK725F1A-105Z1	1	332181050R1
C8182	C-CERA C	CK725B0U-106K	1	332091065R2
C8183	C-CERA C	CK725B1H-102K1	1	332101025R1
C8184	C-CERA C	CK725B0U-106K	1	332091065R2
C8185	C-CERA C	CK725B0U-106K	1	332091065R2
C8186	C-CERA C	CK725F1E-104Z1	1	332161040R1
C8187	C-CERA C	CK725B0U-106K	1	332091065R2
C8188	C-CERA C	CK725B0U-106K	1	332091065R2
C8189	C-CERA C	CK725B1H-102K1	1	332101025R1
C8190	C-CERA C	CK725F1A-105Z1	1	332181050R1
C8191	C-CERA C	CK725B1H-102K1	1	332101025R1
C8192	C-CERA C	CK725B1H-102K1	1	332101025R1
C8193	C-CERA C	CK725F1E-104Z1	1	332161040R1
C8194	C-CERA C	CK725B1A-105K1	1	332131055R1
C8195	C-CERA C	CK725B1A-105K1	1	332131055R1
C8196	C-CERA C	CK725B1A-105K1	1	332131055R1
C8197	C-CERA C	CK725B1A-105K1	1	332131055R1
C8198	C-CERA C	CK725B1A-105K1	1	332131055R1
C8199	C-CERA C	CK725B0U-106K	1	332091065R2
C8200	C-CERA C	CK725F1E-104Z1	1	332161040R1

C8201	C-CERA C	CK725B1H-102K1	1	332101025R1	
C8202	CHIP TANTAL	TEESVA01226M8R	1	398422207R2	N
C8202 or	CHIP TANTAL	F93-6 3V-22M	(1)	395522207R2	
C8202 or	CHIP TANTAL	TCSCS01226M4AR	(1)	396522207R2	
C8203	C-CERA C	CK725B01-106K	1	332091065R2	
C8204	C-CERA C	CK725B01-106K	1	332091065R2	
C8205	CHIP TANTAL	TEESVA01226M8R	1	398422207R2	N
C8205 or	CHIP TANTAL	F93-6 3V-22M	(1)	395522207R2	
C8205 or	CHIP TANTAL	TCSCS01226M4AR	(1)	396522207R2	
C8206	C-CERA C	CK725B1H-102K1	1	332101025R1	
C8207	C-CERA C	CK725F1E-104Z1	1	332161040R1	
C8208	C-CERA C	C0725CH1H-330U1	1	342103304R1	
C8209	C-CERA C	C0725CH1H-330U1	1	342103304R1	
C8210	C-CERA C	CK725F1E-104Z1	1	332161040R1	
C8211	C-CERA C	CK725B01-106K	1	332091065R2	
C8212	C-CERA C	CK725B01-106K	1	332091065R2	
C8213	C-CERA C	CK725F1E-104Z1	1	332161040R1	
C8214	C-CERA C	CK725B01-106K	1	332091065R2	
C8215	C-CERA C	CK725B01-106K	1	332091065R2	
C8216	C-CERA C	CK725B01-106K	1	332091065R2	
C8217	CHIP TANTAL	TEESVA01226M8R	1	398422207R2	N
C8217 or	CHIP TANTAL	F93-6 3V-22M	(1)	395522207R2	
C8217 or	CHIP TANTAL	TCSCS01226M4AR	(1)	396522207R2	
C8218	C-CERA C	CK725B1H-102K1	1	332101025R1	
C8219	C-CERA C	CK725F1E-104Z1	1	332161040R1	
C8220	C-CERA C	CK725B1H-102K1	1	332101025R1	
C8221	C-CERA C	CK725F1E-104Z1	1	332161040R1	
C8222	C-CERA C	CK725B1H-102K1	1	332101025R1	
C8223	C-CERA C	CK725F1E-104Z1	1	332161040R1	
C8224	C-CERA C	CK725F1E-104Z1	1	332161040R1	
C8225	C-CERA C	CK725B1H-102K1	1	332101025R1	
C8226	C-CERA C	CK725F1E-104Z1	1	332161040R1	
C8227	C-CERA C	CK725B1H-102K1	1	332101025R1	
C8228	C-CERA C	CK725F1E-104Z1	1	332161040R1	
C8229	C-CERA C	CK725F1E-104Z1	1	332161040R1	
C8230	CHIP TANTAL	TEESVA01226M8R	1	398422207R2	N
C8230 or	CHIP TANTAL	F93-6 3V-22M	(1)	395522207R2	
C8230 or	CHIP TANTAL	TCSCS01226M4AR	(1)	396522207R2	
C8231	C-CERA C	CK725B01-106K	1	332091065R2	
C8232	C-CERA C	CK725B01-106K	1	332091065R2	
C8233	C-CERA C	CK725B1H-102K1	1	332101025R1	
C8234	C-CERA C	CK725F1E-104Z1	1	332161040R1	
C8235	C-CERA C	CK725B1H-102K1	1	332101025R1	
C8236	C-CERA C	CK725F1E-104Z1	1	332161040R1	
C8237	C-CERA C	CK725B1H-102K1	1	332101025R1	
C8238	C-CERA C	CK725F1E-104Z1	1	332161040R1	
C8239	C-CERA C	CK725B1H-102K1	1	332101025R1	

C8240	C-CERA C	CK725B01-106K	1	332091065R2	
C8241	C-CERA C	CK725B01-106K	1	332091065R2	
C8242	C-CERA C	CK725F1E-104Z1	1	332161040R1	
C8243	C-CERA C	CK725B1H-102K1	1	332101025R1	
C8244	C-CERA C	CK725F1E-104Z1	1	332161040R1	
C8245	C-CERA C	CK725B1H-102K1	1	332101025R1	
C8246	C-CERA C	CK725F1E-104Z1	1	332161040R1	
C8247	C-CERA C	CK725B01-106K	1	332091065R2	
C8248	C-CERA C	CK725B1A-474K1	1	332134745R1	
C8249	C-CERA C	CK725B1A-474K1	1	332134745R1	
C8251	C-CERA C	CK725F1E-104Z1	1	332161040R1	
C8253	C-CERA C	CK725B01-106K	1	332091065R2	
C8254	C-CERA C	CK725F1E-104Z1	1	332161040R1	
C8255	C-CERA C	CK725F1E-104Z1	1	332161040R1	
C8256	C-CERA C	CK725B1H-102K1	1	332101025R1	
C8257	C-CERA C	CK725B01-106K	1	332091065R2	
C8258	C-CERA C	CK725F1E-104Z1	1	332161040R1	
C8259	C-CERA C	CK725F1E-104Z1	1	332161040R1	
C8260	C-CERA C	CK725B01-106K	1	332091065R2	
C8261	C-CERA C	CK725F1E-104Z1	1	332161040R1	
C8262	C-CERA C	CK725F1E-104Z1	1	332161040R1	
C8263	C-CERA C	CK725B01-106K	1	332091065R2	
C8264	C-CERA C	CK725F1E-104Z1	1	332161040R1	
C8265	C-CERA C	CK725F1E-104Z1	1	332161040R1	
C8266	C-CERA C	CK725B01-106K	1	332091065R2	
C8267	C-CERA C	CK725F1E-104Z1	1	332161040R1	
C8268	C-CERA C	CK725F1E-104Z1	1	332161040R1	
C8269	C-CERA C	CK725F1E-104Z1	1	332161040R1	
C8270	C-CERA C	CK725F1E-104Z1	1	332161040R1	
C8271	C-CERA C	CK725F1E-104Z1	1	332161040R1	
C8272	C-CERA C	CK725B01-106K	1	332091065R2	
C8273	CHIP TANTAL	TEESVA01220M6R	1	398422207R2	
C8273 or	CHIP TANTAL	F93-6 3V-22M	(1)	395522207R2	
C8273 or	CHIP TANTAL	TCSCS01220M4AR	(1)	396522207R2	
C8274	C-CERA C	CK725B1H-102K1	1	332101025R1	
C8275	C-CERA C	CK725B1H-103K1	1	332101035R1	
C8276	C-CERA C	CK725B1H-102K1	1	332101025R1	
C8277	C-CERA C	CK725B1H-103K1	1	332101035R1	
C8278	C-CERA C	CK725B1H-102K1	1	332101025R1	
C8279	C-CERA C	CK725B1H-103K1	1	332101035R1	
C8280	C-CERA C	CK725B1H-102K1	1	332101025R1	
C8281	CHIP TANTAL	TEESVA01220M6R	1	398422207R2	
C8281 or	CHIP TANTAL	F93-6 3V-22M	(1)	395522207R2	
C8281 or	CHIP TANTAL	TCSCS01220M4AR	(1)	396522207R2	
C8282	C-CERA C	CK725B1H-102K1	1	332101025R1	
C8283	C-CERA C	CK725B1H-103K1	1	332101035R1	
C8284	C-CERA C	CK725B1H-102K1	1	332101025R1	

N

N

C8285	C-CERA C	CK725B IH-103K1	1	332101035R1	
C8286	C-CERA C	CK725B IH-103K1	1	332101025R1	
C8287	C-CERA C	CK725B IH-103K1	1	332101035R1	
C8288	C-CERA C	CK725B IH-103K1	1	332101025R1	
C8289	C-CERA C	CK725FIE-104Z1	1	332161040R1	
C8290	C-CERA C	CK725B IH-103K1	1	332101025R1	
C8291	C-CERA C	CK725FIE-104Z1	1	332161040R1	
C8292	C-CERA C	CK725FIA-105Z1	1	332181050R1	
C8293	CHIP TANTAL	TEESVA0226M6R	1	398422207R2	N
C8293 or	CHIP TANTAL	F93-6 3V-22M	(1)	395522207R2	
C8293 or	CHIP TANTAL	TCSCS01226M6AR	(1)	396522207R2	
C8294	CHIP TANTAL	TEESVA0226M6R	1	398422207R2	N
C8294 or	CHIP TANTAL	F93-6 3V-22M	(1)	395522207R2	
C8294 or	CHIP TANTAL	TCSCS01226M6AR	(1)	396522207R2	
C8295	C-CERA C	CK725B IH-103K1	1	332101035R1	
C8296	C-CERA C	CK725B IH-103K1	1	332101035R1	
C8297	CHIP TANTAL	TEESVA0226M6R	1	398422207R2	N
C8297 or	CHIP TANTAL	F93-6 3V-22M	(1)	395522207R2	
C8297 or	CHIP TANTAL	TCSCS01226M6AR	(1)	396522207R2	
C8298	C-CERA C	CK725B IH-103K1	1	332101035R1	
C8299	C-CERA C	CK725B IH-103K1	1	332101035R1	
C8326	C-CERA C	CK725B IE-106K	1	33221065R2	
C8328	C-CERA C	CK725B01-106K	1	332091065R2	
C8330	C-CERA C	CK725FIE-104Z1	1	332161040R1	
C8348	C-CERA C	CK725B IH-103K1	1	332101025R1	
C8399	C-CERA C	CK725B IH-103K1	1	332101025R1	
C8401	C-CERA C	CK725FIE-104Z1	1	332161040R1	
C8402	C-CERA C	CK725B IH-103K1	1	332101035R1	
C8403	C-CERA C	CK725FIE-104Z1	1	332161040R1	
C8404	C-CERA C	CK725B IH-103K1	1	332101035R1	
C8405	C-CERA C	CK725FIE-104Z1	1	332161040R1	
C8406	C-CERA C	CK725B IH-103K1	1	332101035R1	
C8407	C-CERA C	CK725FIE-104Z1	1	332161040R1	
C8408	C-CERA C	CK725B IH-103K1	1	332101035R1	
C8409	C-CERA C	CK725FIE-104Z1	1	332161040R1	
C8410	C-CERA C	CK725B IH-103K1	1	332101035R1	
C8411	C-CERA C	CK725FIE-104Z1	1	332161040R1	
C8412	C-CERA C	CK725B IH-103K1	1	332101035R1	
C8413	C-CERA C	CK725FIE-104Z1	1	332161040R1	
C8414	C-CERA C	CK725B IH-103K1	1	332101035R1	
C8415	C-CERA C	CK725FIE-104Z1	1	332161040R1	
C8416	C-CERA C	CK725B IH-103K1	1	332101035R1	
C8417	C-CERA C	CK725FIE-104Z1	1	332161040R1	
C8418	C-CERA C	CK725B IH-103K1	1	332101035R1	
C8420	C-CERA C	CK725B IH-103K1	1	332101025R1	
C8421	C-CERA C	CK725B01-106K	1	332091065R2	
C8422	C-CERA C	CK725B01-106K	1	332091065R2	

C8424	C-CERA C	CK725B01-106K	1	332091065R2
C8425	C-CERA C	CK725B01-106K	1	332091065R2
C8428	C-CERA C	CK725B01-106K	1	332091065R2
C8429	C-CERA C	CK725F1E-104Z1	1	332161040R1
C8430	C-CERA C	CK725CH1H-080D1	1	34210080R1
C8431	C-CERA C	CK725B01-106K	1	332091065R2
C8432	C-CERA C	CK725B1H-103K1	1	332101035R1
C8433	C-CERA C	CK725F1E-104Z1	1	332161040R1
C8434	C-CERA C	CK725B1H-103K1	1	332101035R1
C8435	C-CERA C	CK725F1E-104Z1	1	332161040R1
C8436	C-CERA C	CK725F1A-105Z1	1	332181050R1
C8437	C-CERA C	CK725F1A-105Z1	1	332181050R1
C8438	C-CERA C	CK725F1A-105Z1	1	332181050R1
C8439	C-CERA C	CK725F1A-105Z1	1	332181050R1
C8440	C-CERA C	CK725B1A-105K1	1	332131055R1
C8441	C-CERA C	CK725B1A-105K1	1	332131055R1
C8442	C-CERA C	CK725CH1H-101J1	1	342101014R1
C8443	C-CERA C	CK725B1C-104K1	1	332121045R1
C8502	C-CERA C	CK725B01-106K	1	332091065R2
C8506	C-CERA C	CK725B01-106K	1	332091065R2
C8507	C-CERA C	CK725B1H-102K1	1	332101025R1
C8508	C-CERA C	CK725F1A-105Z1	1	332181050R1
C8509	C-CERA C	CK725B1H-102K1	1	332101025R1
C8510	C-CERA C	CK725F1A-105Z1	1	332181050R1
C8511	C-CERA C	CK725B1H-102K1	1	332101025R1
C8512	C-CERA C	CK725F1E-104Z1	1	332161040R1
C8513	C-CERA C	CK725B1H-102K1	1	332101025R1
C8514	C-CERA C	CK725F1E-104Z1	1	332161040R1
C8515	C-CERA C	CK725B1H-102K1	1	332101025R1
C8516	C-CERA C	CK725F1E-104Z1	1	332161040R1
C8517	C-CERA C	CK725B1H-102K1	1	332101025R1
C8518	C-CERA C	CK725F1E-104Z1	1	332161040R1
C8519	C-CERA C	CK725B1H-102K1	1	332101025R1
C8522	C-CERA C	CK725B01-106K	1	332091065R2
C8524	C-CERA C	CK725B01-106K	1	332091065R2
C8525	C-CERA C	CK725B01-106K	1	332091065R2
C8527	C-CERA C	CK725B1H-102K1	1	332101025R1
C8530	C-CERA C	CK725F1E-104Z1	1	332161040R1
C8531	C-CERA C	CK725B1H-102K1	1	332101025R1
C8532	C-CERA C	CK725F1E-104Z1	1	332161040R1
C8533	C-CERA C	CK725B1H-102K1	1	332101025R1
C8534	C-CERA C	CK725F1E-104Z1	1	332161040R1
C8535	C-CERA C	CK725B1H-102K1	1	332101025R1
C8536	C-CERA C	CK725F1E-104Z1	1	332161040R1
C8537	C-CERA C	CK725B1H-102K1	1	332101025R1
C8538	C-CERA C	CK725F1E-104Z1	1	332161040R1
C8539	C-CERA C	CK725B1H-102K1	1	332101025R1

C8548	C-CERA C	CK725F1E-104Z1	1	332161040R1
C8549	C-CERA C	CK725B1H-102K1	1	332101025R1
C8550	C-CERA C	CK725F1E-104Z1	1	332161040R1
C8551	C-CERA C	CK725B1H-102K1	1	332101025R1
C8552	C-CERA C	CK725F1E-104Z1	1	332161040R1
C8553	C-CERA C	CK725B1H-102K1	1	332101025R1
C8554	C-CERA C	CK725F1E-104Z1	1	332161040R1
C8555	C-CERA C	CK725B1H-102K1	1	332101025R1
C8556	C-CERA C	CK725F1E-104Z1	1	332161040R1
C8557	C-CERA C	CK725B1H-102K1	1	332101025R1
C8560	C-CERA C	CK725B0U-106K	1	332091065R2
C8561	C-CERA C	CK725B0U-106K	1	332091065R2
C8563	C-CERA C	CK725B0U-106K	1	332091065R2
C8565	C-CERA C	CK725B0U-106K	1	332091065R2
C8566	C-CERA C	CK725B1H-102K1	1	332101025R1
C8567	C-CERA C	CK725F1E-104Z1	1	332161040R1
C8573	C-CERA C	CK725F1E-104Z1	1	332161040R1
C8574	C-CERA C	CK725CH1H-060D1	1	342100602R1
C8575	C-CERA C	CK725CH1H-060D1	1	342100602R1
C8584	C-CERA C	CK725B0U-106K	1	332091065R2
C8605	C-CERA C	CK725B1H-102K1	1	332101025R1
C8606	C-CERA C	CK725B1H-102K1	1	332101025R1
C8611	C-CERA C	CK725B1H-102K1	1	332101025R1
C8612	C-CERA C	CK725B1H-102K1	1	332101025R1
C8622	C-CERA C	CK725B1H-102K1	1	332101025R1
C8631	C-CERA C	CK725B1H-102K1	1	332101025R1
C8632	C-CERA C	CK725B1H-102K1	1	332101025R1
C8641	C-CARBONR	RN72K1U-000DE	1	435030004R1
C8642	C-CERA C	CK725B1H-102K1	1	332101025R1
C8645	C-CERA C	CK725B1H-102K1	1	332101025R1
C8646	C-CERA C	CK725B1H-102K1	1	332101025R1
C8647	C-CERA C	CK725F1E-104Z1	1	332161040R1
C8651	C-CARBONR	RN72K1U-000DE	1	435030004R1
C8652	C-CERA C	CK725B1H-102K1	1	332101025R1
C8701	C-CERA C	CK725F1A-105Z1	1	332181050R1
C8702	C-CERA C	CK725F1A-105Z1	1	332181050R1
C8703	C-CERA C	CK725F1A-105Z1	1	332181050R1
C8704	CHIP ELECT C	CEWX50V 4 7M	1	398180477R2
C8705	C-CERA C	CK725F1A-105Z1	1	332181050R1
C8706	C-CERA C	CK725F1A-105Z1	1	332181050R1
C8707	C-CERA C	CK725F1A-105Z1	1	332181050R1
C8708	C-CERA C	CK725F1A-105Z1	1	332181050R1
C8709	C-CERA C	CK725B0U-106K	1	332091065R2
C8710	C-CERA C	CK725F1A-105Z1	1	332181050R1
C8801	C-CERA C	CK725F1E-104Z1	1	332161040R1
C8802	C-CERA C	CK725F1E-104Z1	1	332161040R1

C8803	C-CERA C	CK725F1E-104Z1	1	332161040R1	
C8804	C-CERA C	CK725F1E-104Z1	1	332161040R1	
C8805	C-CERA C	CK725F1E-104Z1	1	332161040R1	
C8806	C-CERA C	CK725B1H-102K1	1	332101025R1	
C8807	C-CERA C	CK725F1E-104Z1	1	332161040R1	
C8808	C-CERA C	CK725B1H-102K1	1	332101025R1	
C8809	C-CERA C	CK725F1E-104Z1	1	332161040R1	
C8810	C-CERA C	CK725B1H-102K1	1	332101025R1	
C8811	C-CERA C	CK725F1E-104Z1	1	332161040R1	
C8812	C-CERA C	CK725B1H-102K1	1	332101025R1	
C8813	C-CERA C	CK725F1E-104Z1	1	332161040R1	
C8814	C-CERA C	CK725B1H-102K1	1	332101025R1	
C8815	C-CERA C	CK725F1E-104Z1	1	332161040R1	
C8816	C-CERA C	CK725B1H-102K1	1	332101025R1	
C8817	C-CERA C	CK725B01-106K	1	332091065R2	
C8818	C-CERA C	CK725B01-106K	1	332091065R2	
C8819	C-CERA C	CK725B01-106K	1	332091065R2	
C8820	C-CERA C	CK725B01-106K	1	332091065R2	
C8821	C-CERA C	CK725B1H-102K1	1	332101025R1	
C8822	C-CERA C	CK725F1E-104Z1	1	332161040R1	
C8921	C-CERA C	CK725B01-106K	1	332091065R2	
C8922	C-CERA C	CK725B1A-474K1	1	332134745R1	
C8930	C-CERA C	CK725F1E-104Z1	1	332161040R1	
C8931	C-CERA C	CK725F1E-104Z1	1	332161040R1	
C8932	CHIP ELECT C	CEWX25V-100M	1	398151017R2	
C8933	C-CERA C	CK725B1E-106K	1	332221065R2	
C8934	C-CERA C	CK725B1E-106K	1	332221065R2	
C8935	CHIP ELECT C	CEWX16V-100M	1	398141017R2	
C8936	C-CERA C	CK725B01-106K	1	332091065R2	
C8937	C-CERA C	CK725B01-106K	1	332091065R2	
C8938	C-CERA C	CK725B1C-104K1	1	332121045R1	
C8939	C-CERA C	CK725B01-106K	1	332091065R2	
C8940	C-CERA C	CK725B01-106K	1	332091065R2	
C8942	CHIP TANTAL	TEESVB20J107M8R	1	398421017R2	N
C8942 or	CHIP TANTAL	F93-6 3V-100M	(1)	395521017R2	
C8942 or	CHIP TANTAL	TSCS0U107MBAR	(1)	396521017R2	
C8943	C-CERA C	CK725B01-106K	1	332091065R2	
C8945	C-CERA C	CK725B01-106K	1	332091065R2	
C8947	CHIP TANTAL	TEESVB20J107M8R	1	398421017R2	N
C8947 or	CHIP TANTAL	F93-6 3V-100M	(1)	395521017R2	
C8947 or	CHIP TANTAL	TSCS0U107MBAR	(1)	396521017R2	
C8948	C-CERA C	CK725B01-106K	1	332091065R2	
C8951	C-CERA C	CK725B1C-104K1	1	332121045R1	
C8952	C-CERA C	CK725B1E-106K	1	332221065R2	
C8953	C-CERA C	CK725B1E-106K	1	332221065R2	
C8954	C-CERA C	CK725B1C-104K1	1	332121045R1	
C8956	C-CERA C	CK725B1H-103K1	1	332101035R1	

C8958	C-CERA C	CK725B01-106K	1	332091065R2
C8959	C-CERA C	CK725B01-106K	1	332091065R2
C8960	C-CERA C	CK725B01-106K	1	332091065R2
C8961	C-CERA C	CK725B1C-104K1	1	332121045R1
C8962	C-CERA C	CK725B1E-106K	1	332221065R2
C8963	C-CERA C	CK725B1E-106K	1	332221065R2
C8964	C-CERA C	CK725B1C-104K1	1	332121045R1
C8966	C-CERA C	CK725B1H-103K1	1	332101035R1
C8967	C-CERA C	CK725CH1H-151J1	1	342101514R1
C8968	C-CERA C	CK725B01-106K	1	332091065R2
C8969	C-CERA C	CK725B01-106K	1	332091065R2
C8970	C-CERA C	CK725B01-106K	1	332091065R2
C8971	C-CERA C	CK725B1C-104K1	1	332121045R1
C8972	C-CERA C	CK725B1E-106K	1	332221065R2
C8973	C-CERA C	CK725B1E-106K	1	332221065R2
C8974	C-CERA C	CK725B1C-104K1	1	332121045R1
C8976	C-CERA C	CK725B1H-223K1	1	332102235R1
C8977	C-CERA C	CK725CH1H-331J1	1	342103314R1
C8978	C-CERA C	CK725B01-106K	1	332091065R2
C8979	C-CERA C	CK725B01-106K	1	332091065R2
C8980	C-CERA C	CK725B01-106K	1	332091065R2
C8981	C-CERA C	CK725B1C-104K1	1	332121045R1
C8982	C-CERA C	CK725B1E-106K	1	332221065R2
C8983	C-CERA C	CK725B1E-106K	1	332221065R2
C8984	C-CERA C	CK725B1C-104K1	1	332121045R1
C8986	C-CERA C	CK725B1H-223K1	1	332102235R1
C8987	C-CERA C	CK725CH1H-331J1	1	342103314R1
C8988	C-CERA C	CK725B01-106K	1	332091065R2
C8989	C-CERA C	CK725B01-106K	1	332091065R2
C8990	C-CERA C	CK725B01-106K	1	332091065R2
C8991	C-CERA C	CK725F1A-105Z1	1	332181050R1
C8992	CHIP ELECT C	CEWX10V-220M	1	398132217R2
C8993	C-CERA C	CK725F1A-105Z1	1	332181050R1
C8994	CHIP ELECT C	CEWX10V-220M	1	398132217R2
C8995	C-CERA C	CK725F1A-105Z1	1	332181050R1
C8996	CHIP ELECT C	CEWX10V-220M	1	398132217R2
C8997	C-CERA C	CK725F1A-105Z1	1	332181050R1
C8998	CHIP ELECT C	CEWX10V-220M	1	398132217R2
C8999	C-CERA C	CK725F1A-105Z1	1	332181050R1
NEBITOKI				
R268	C-CARB ON R	RN72K1J-331JE	1	435033314R1
R269	C-CARB ON R	RN72K1J-331JE	1	435033314R1
R270	C-CARB ON R	RN72K1J-331JE	1	435033314R1
R271	C-CARB ON R	RN72K1J-470JE	1	435034704R1
R272	C-CARB ON R	RN72K1J-331JE	1	435033314R1
R273	C-CARB ON R	RN72K1J-331JE	1	435033314R1
R274	C-CARB ON R	RN72K1J-470JE	1	435034704R1

R275	C-CARB ONR		RN7ZK U-221E	1	435032214R1	
R276	C-CARB ONR		RN7ZK U-221E	1	435032214R1	
R277	C-CARB ONR		RN7ZK U-151E	1	435031514R1	
R278	C-CARB ONR		RN7ZK U-331E	1	43503314R1	
R279	C-CARB ONR		RN7ZK U-331E	1	43503314R1	
R280	C-CARB ONR		RN7ZK U-470E	1	435034704R1	
R3009	C-CARB ONR		RN7ZK U-330E	1	435033304R1	
R3010	C-R NET		RM7LJ330X04	1	43484733004R2	
R3011	C-R NET		RM7LJ330X04	1	43484733004R2	
R3012	C-R NET		RM7LJ470X04	1	43484747004R2	
R3013	C-R NET		RM7LJ330X04	1	43484733004R2	
R3014	C-R NET		RM7LJ330X04	1	43484733004R2	
R3015	C-R NET		RM7LJ330X04	1	43484733004R2	
R3016	C-CARB ONR		RN7ZK U-470E	1	435034704R1	
R3017	C-R NET		RM7LJ330X04	1	43484733004R2	
R3018	C-CARB ONR		RN7ZK U-470E	1	435034704R1	
R3019	C-R NET		RM7LJ330X04	1	43484733004R2	
R3020	C-R NET		RM7LJ330X04	1	43484733004R2	
R3021	C-CARB ONR		RN7ZK U-470E	1	435034704R1	
R3022	C-CARB ONR		RN7ZK U-470E	1	435034704R1	
R3023	C-R NET		RM7LJ470X04	1	43484747004R2	
R3024	C-CARB ONR		RN7ZK U-470E	1	435034704R1	
R3025	C-CARB ONR		RN7ZK U-102E	1	435031024R1	
R3026	C-CARB ONR		RN7ZK U-470E	1	435034704R1	
R3028	C-CARB ONR		RN7ZK U-470E	1	435034704R1	
R3029	C-CARB ONR		RN7ZK U-102E	1	435031024R1	
R3032	C-CARB ONR		RN7ZK U-103E	1	435031034R1	
R3033	C-CARB ONR		RN7ZK U-470E	1	435034704R1	
R3034	C-CARB ONR		RN7ZK U-470E	1	435034704R1	
R3035	C-CARB ONR		RN7ZK U-470E	1	435034704R1	
R3036	C-CARB ONR		RN7ZK U-470E	1	435034704R1	
R3037	C-CARB ONR		RN7ZK U-470E	1	435034704R1	
R3038	C-CARB ONR		RN7ZK U-470E	1	435034704R1	
R3039	C-CARB ONR		RN7ZK U-470E	1	435034704R1	
R3040	C-CARB ONR		RN7ZK U-103E	1	435031034R1	
R3041	C-R NET		RM7LJ330X04	1	43484733004R2	
R3042	C-R NET		RM7LJ330X04	1	43484733004R2	
R3043	C-CARB ONR		RN7ZK U-000E	1	435030004R1	
R3044	C-R NET		RM7LJ330X04	1	43484733004R2	
R3045	C-R NET		RM7LJ330X04	1	43484733004R2	
R3047	C-CARB ONR		RN7ZK U-560E	1	435035604R1	
R3048	C-CARB ONR		RN7ZK U-000E	1	435030004R1	
R3049	C-CARB ONR		RN7ZK U-560E	1	435035604R1	
R3050	C-CARB ONR		RN7ZK U-560E	1	435035604R1	
R3051	C-CARB ONR		RN7ZK U-560E	1	435035604R1	
R3052	C-CARB ONR		RN7ZK U-103E	1	435031034R1	
R3053	C-CARB ONR		RN7ZK U-103E	1	435031034R1	

R3054	C-CARB ONR	RN7ZK U-103E	1	435031034R1
R3055	C-CARB ONR	RN7ZK U-472E	1	435034724R1
R3056	C-CARB ONR	RN7ZK U-472E	1	435034724R1
R3060	C-CARB ONR	RN7ZK U-680E	1	435036804R1
R3061	C-CARB ONR	RN7ZK U-470E	1	435034704R1
R3062	C-CARB ONR	RN7ZK U-680E	1	435036804R1
R3063	C-CARB ONR	RN7ZK U-680E	1	435036804R1
R3064	C-CARB ONR	RN7ZK U-680E	1	435036804R1
R3065	C-CARB ONR	RN7ZK U-680E	1	435036804R1
R3066	C-CARB ONR	RN7ZK U-102E	1	435031024R1
R3101	C-CARB ONR	RN7ZK U-103E	1	435031034R1
R3104	C-CARB ONR	RN7ZK U-31E	1	43503314R1
R3108	C-CARB ONR	RN7ZK U-103E	1	435031034R1
R3110	C-CARB ONR	RN7ZK U-103E	1	435031034R1
R3111	C-CARB ONR	RN7ZK U-103E	1	435031034R1
R3113	C-CARB ONR	RN7ZK U-103E	1	435031034R1
R3115	C-CARB ONR	RN7ZK U-103E	1	435031034R1
R3117	C-CARB ONR	RN7ZK U-103E	1	435031034R1
R3119	C-CARB ONR	RN7ZK U-472E	1	435034724R1
R3122	C-CARB ONR	RN7ZK U-102E	1	435031024R1
R3123	C-CARB ONR	RN7ZK U-000E	1	435030004R1
R3124	C-CARB ONR	RN7ZK U-31E	1	43503314R1
R3125	C-CARB ONR	RN7ZK U-470E	1	435034704R1
R3126	C-CARB ONR	RN7ZK U-470E	1	435034704R1
R3127	C-CARB ONR	RN7ZK U-470E	1	435034704R1
R3128	C-CARB ONR	RN7ZK U-472E	1	435034724R1
R3129	C-CARB ONR	RN7ZK U-470E	1	435034704R1
R3130	C-CARB ONR	RN7ZK U-470E	1	435034704R1
R3131	C-CARB ONR	RN7ZK U-470E	1	435034704R1
R3132	C-CARB ONR	RN7ZK U-103E	1	435031034R1
R3133	C-CARB ONR	RN7ZK U-470E	1	435034704R1
R3134	C-CARB ONR	RN7ZK U-103E	1	435031034R1
R3135	C-CARB ONR	RN7ZK U-103E	1	435031034R1
R3136	C-CARB ONR	RN7ZK U-000E	1	435030004R1
R3137	C-CARB ONR	RN7ZK U-000E	1	435030004R1
R3139	C-CARB ONR	RN7ZK U-101E	1	435031014R1
R3143	C-CARB ONR	RN7ZK U-103E	1	435031034R1
R3144	C-CARB ONR	RN7ZK U-101E	1	435031014R1
R3145	C-CARB ONR	RN7ZK U-103E	1	435031034R1
R3146	C-CARB ONR	RN7ZK U-390E	1	435033904R1
R3147	C-CARB ONR	RN7ZK U-000E	1	435030004R1
R3148	C-CARB ONR	RN7ZK U-390E	1	435033904R1
R3149	C-CARB ONR	RN7ZK U-102E	1	435031024R1
R3150	C-CARB ONR	RN7ZK U-151E	1	435031514R1
R3151	C-CARB ONR	RN7ZK U-103E	1	435031034R1
R3152	C-CARB ONR	RN7ZK U-103E	1	435031034R1
R3154	C-CARB ONR	RN7ZK U-390E	1	435033904R1

R3155	C-CARB ONR	RN7ZK U-390UE	1	435033904R1
R3156	C-CARB ONR	RN7ZK U-390UE	1	435033904R1
R3157	C-CARB ONR	RN7ZK U-000UE	1	435030004R1
R3158	C-CARB ONR	RN7ZK U-000UE	1	435030004R1
R3159	C-CARB ONR	RN7ZK U-000UE	1	435030004R1
R3160	C-CARB ONR	RN7ZK U-000UE	1	435030004R1
R3162	C-CARB ONR	RN7ZK U-390UE	1	435033904R1
R3163	C-CARB ONR	RN7ZK U-220UE	1	435032204R1
R3164	C-CARB ONR	RN7ZK U-472UE	1	435034724R1
R3168	C-CARB ONR	RN7ZK U-220UE	1	435032204R1
R3169	C-CARB ONR	RN7ZK U-220UE	1	435032204R1
R3170	C-CARB ONR	RN7ZK U-391FE	1	435033912R1
R3171	C-CARB ONR	RN7ZK U-222FE	1	435032222R1
R3172	C-CARB ONR	RN7ZK U-392FE	1	435033922R1
R3173	C-CARB ONR	RN7ZK U-390UE	1	435033904R1
R3174	C-CARB ONR	RN7ZK U-390UE	1	435033904R1
R3176	C-CARB ONR	MCR03E2ZF49R0(49 9.1%)	1	4100037R2
R3177	C-CARB ONR	MCR03E2ZF49R0(49 9.1%)	1	4100037R2
R3178	C-CARB ONR	MCR03E2ZF49R0(49 9.1%)	1	4100037R2
R3179	C-CARB ONR	MCR03E2ZF49R0(49 9.1%)	1	4100037R2
R3180	C-CARB ONR	RN7ZK U-100FE	1	435031002R1
R3181	C-CARB ONR	RN7ZK U-470UE	1	435034704R1
R3182	C-CARB ONR	RN7ZK U-472UE	1	435034724R1
R3183	C-CARB ONR	RN7ZK U-470UE	1	435034704R1
R3184	C-CARB ONR	RN7ZK U-470UE	1	435034704R1
R3185	C-CARB ONR	RN7ZK U-332FE	1	435033322R1
R3186	C-CARB ONR	RN7ZK U-472UE	1	435034724R1
R3187	C-CARB ONR	RN7ZK U-223FE	1	435032232R1
R3188	C-CARB ONR	RN7ZK U-249FE	1	435032242R1
R3189	C-CARB ONR	RN7ZK U-682FE	1	435036822R1
R3190	C-CARB ONR	RN7ZK U-393FE	1	435033932R1
R3191	C-CARB ONR	RN7ZK U-105FE	1	435031052R1
R3192	C-CARB ONR	RN7ZK U-472UE	1	435034724R1
R3193	C-CARB ONR	RN7ZK U-472UE	1	435034724R1
R3194	C-CARB ONR	RN7ZK U-472UE	1	435034724R1
R3199	C-CARB ONR	RN7ZK U-102UE	1	435031024R1
R3200	C-CARB ONR	RN7ZK U-103UE	1	435031034R1
R3201	C-CARB ONR	RN7ZK U-103UE	1	435031034R1
R3202	C-CARB ONR	RN7ZK U-103UE	1	435031034R1
R3203	C-CARB ONR	RN7ZK U-103UE	1	435031034R1
R3204	C-CARB ONR	RN7ZK U-103UE	1	435031034R1
R3205	C-CARB ONR	RN7ZK U-103UE	1	435031034R1
R3208	C-CARB ONR	RN7ZK U-271UE	1	435032714R1
R3212	C-CARB ONR	RN7ZK U-220UE	1	435032204R1
R3215	C-CARB ONR	RN7ZK U-221UE	1	435032214R1
R3218	C-CARB ONR	RN7ZK U-220UE	1	435032204R1
R3219	C-CARB ONR	RN7ZK U-221UE	1	435032214R1

R3321	C-CARB ONR	RN72K U-470E	1	435034704R1
R3324	C-CARB ONR	RN72K U-531E	1	435033314R1
R3325	C-CARB ONR	RN72K U-220E	1	435032204R1
R3326	C-R NET	RN7L470X04	1	434847004R2
R3327	C-CARB ONR	RN72K U-470E	1	435034704R1
R3328	C-CARB ONR	RN72K U-470E	1	435034704R1
R3329	C-CARB ONR	RN72K U-470E	1	435034704R1
R3330	C-CARB ONR	RN72K U-221E	1	435032214R1
R3331	C-CARB ONR	RN72K U-470E	1	435034704R1
R3332	C-CARB ONR	RN72K U-221E	1	435032214R1
R3333	C-CARB ONR	RN72K U-221E	1	435032214R1
R3334	C-CARB ONR	RN72K U-470E	1	435034704R1
R3336	C-CARB ONR	RN72K U-470E	1	435034704R1
R3337	C-CARB ONR	RN72K U-221E	1	435032214R1
R3338	C-CARB ONR	RN72K U-470E	1	435034704R1
R3339	C-CARB ONR	RN72K U-221E	1	435032214R1
R3340	C-CARB ONR	RN72K U-103E	1	435031034R1
R3341	C-CARB ONR	RN72K U-221E	1	435032214R1
R3342	C-CARB ONR	RN72K U-221E	1	435032214R1
R3343	C-CARB ONR	RN72K U-220E	1	435032204R1
R3344	C-CARB ONR	RN72K U-470E	1	435034704R1
R3346	C-CARB ONR	RN72K U-103E	1	435031034R1
R3347	C-CARB ONR	RN72K U-121E	1	435031214R1
R3348	C-CARB ONR	RN72K U-220E	1	435032204R1
R3349	C-CARB ONR	RN72K U-470E	1	435034704R1
R3350	C-CARB ONR	RN72K U-470E	1	435034704R1
R3351	C-CARB ONR	RN72K U-470E	1	435034704R1
R3353	C-CARB ONR	RN72K U-470E	1	435034704R1
R3354	C-CARB ONR	RN72K U-470E	1	435034704R1
R3355	C-CARB ONR	RN72K U-103E	1	435031034R1
R3356	C-CARB ONR	RN72K U-470E	1	435034704R1
R3357	C-CARB ONR	RN72K U-470E	1	435034704R1
R3359	C-CARB ONR	RN72K U-220E	1	435032204R1
R3360	C-CARB ONR	RN72K U-390E	1	43503904R1
R3361	C-CARB ONR	RN72K U-470E	1	435034704R1
R3362	C-CARB ONR	RN72K U-221E	1	435032214R1
R3364	C-CARB ONR	RN72K U-470E	1	435034704R1
R3365	C-CARB ONR	RN72K U-390E	1	43503904R1
R3367	C-CARB ONR	RN72K U-470E	1	435034704R1
R3368	C-CARB ONR	RN72K U-390E	1	43503904R1
R3370	C-CARB ONR	RN72K U-470E	1	435034704R1
R3371	C-CARB ONR	RN72K U-390E	1	43503904R1
R3372	C-CARB ONR	RN72K U-470E	1	435034704R1
R3373	C-CARB ONR	RN72K U-470E	1	435034704R1
R3374	C-CARB ONR	RN72K U-390E	1	43503904R1
R3375	C-CARB ONR	RN72K U-220E	1	435032204R1
R3376	C-CARB ONR	RN72K U-470E	1	435034704R1

R3277	C-CARB ONR	RN7ZK U-220JE	1	435032204R1
R3278	C-CARB ONR	RN7ZK U-470JE	1	435034704R1
R3279	C-CARB ONR	RN7ZK U-470JE	1	435034704R1
R3280	C-CARB ONR	RN7ZK U-470JE	1	435034704R1
R3281	C-CARB ONR	RN7ZK U-103JE	1	435031034R1
R3282	C-CARB ONR	RN7ZK U-103JE	1	435031034R1
R3283	C-CARB ONR	RN7ZK U-103JE	1	435031034R1
R3284	C-CARB ONR	RN7ZK U-103JE	1	435031034R1
R3287	C-CARB ONR	RN7ZK U-220JE	1	435032204R1
R3288	C-CARB ONR	RN7ZK U-223JE	1	435032234R1
R3289	C-CARB ONR	RN7ZK U-472JE	1	435034724R1
R3290	C-CARB ONR	RN7ZK U-221JE	1	435032214R1
R3291	C-CARB ONR	RN7ZK U-105JE	1	435031054R1
R3293	C-CARB ONR	RN7ZK U-560JE	1	435035604R1
R3294	C-CARB ONR	RN7ZK U-561FE	1	435035612R1
R3295	C-CARB ONR	RN7ZK U-560JE	1	435035604R1
R3296	C-CARB ONR	RN7ZK U-223JE	1	435032234R1
R3297	C-CARB ONR	RN7ZK U-822JE	1	435038224R1
R3298	C-CARB ONR	RN7ZK U-532JE	1	435033324R1
R3299	C-CARB ONR	RN7ZK U-220JE	1	435032204R1
R3300	C-CARB ONR	RN7ZK U-153JE	1	435031534R1
R3301	C-CARB ONR	RN7ZK U-153JE	1	435031534R1
R3302	C-CARB ONR	RN7ZK U-531JE	1	435033314R1
R3303	C-CARB ONR	RN7ZK U-104JE	1	435031044R1
R3304	C-CARB ONR	RN7ZK U-153JE	1	435031534R1
R3305	C-CARB ONR	RN7ZK U-153JE	1	435031534R1
R3307	C-CARB ONR	RN7ZK U-104JE	1	435031044R1
R3308	C-CARB ONR	RN7ZK U-223JE	1	435032234R1
R3309	C-CARB ONR	RN7ZK U-822JE	1	435038224R1
R3310	C-CARB ONR	RN7ZK U-532JE	1	435033324R1
R3311	C-CARB ONR	RN7ZK U-471JE	1	435034714R1
R3312	C-CARB ONR	RN7ZK U-223JE	1	435032234R1
R3313	C-CARB ONR	RN7ZK U-472JE	1	435034724R1
R3314	C-CARB ONR	RN7ZK U-591JE	1	435035914R1
R3315	C-CARB ONR	RN7ZK U-750JE	1	435037504R1
R3401	C-CARB ONR	RN7ZK U-000JE	1	435030004R1
R3402	C-CARB ONR	RN7ZK U-000JE	1	435030004R1
R3403	C-CARB ONR	RN7ZK U-000JE	1	435030004R1
R3404	C-CARB ONR	RN7ZK U-000JE	1	435030004R1
R3406	C-CARB ONR	RN7ZK U-332JE	1	435033324R1
R3407	C-CARB ONR	RN7ZK U-103JE	1	435031034R1
R3408	C-CARB ONR	RN7ZK U-331JE	1	435033314R1
R3409	C-CARB ONR	RN7ZK U-331JE	1	435033314R1
R3412	C-CARB ONR	RN7ZK U-472JE	1	435034724R1
R3414	C-CARB ONR	RN7ZK U-103JE	1	435031034R1
R3415	C-CARB ONR	RN7ZK U-331JE	1	435033314R1
R3416	C-CARB ONR	RN7ZK U-331JE	1	435033314R1

R3417	C-CARB ONR	RN7ZK U-331E	1	43503314R1
R3418	C-CARB ONR	RN7ZK U-331E	1	43503314R1
R3419	C-CARB ONR	RN7ZK U-331E	1	43503314R1
R3421	C-CARB ONR	RN7ZK U-560E	1	43503604R1
R3423	C-CARB ONR	RN7ZK U-000E	1	43503004R1
R3424	C-CARB ONR	RN7ZK U-470E	1	43503470R1
R3425	C-CARB ONR	RN7ZK U-470E	1	43503470R1
R3429	C-R NET	RN7L470X04	1	4348474704R2
R3430	C-R NET	RN7L470X04	1	4348474704R2
R3434	C-CARB ONR	RN7ZK U-332E	1	43503324R1
R3435	C-CARB ONR	RN7ZK U-101E	1	435031014R1
R3436	C-CARB ONR	RN7ZK U-560E	1	43503604R1
R3437	C-CARB ONR	RN7ZK U-560E	1	43503604R1
R3438	C-CARB ONR	RN7ZK U-560E	1	43503604R1
R3439	C-CARB ONR	RN7ZK U-332E	1	43503324R1
R3440	C-CARB ONR	RN7ZK U-332E	1	43503324R1
R3441	C-R NET	RN7L470X04	1	4348474704R2
R3442	C-CARB ONR	RN7ZK U-105E	1	435031054R1
R3443	C-CARB ONR	RN7ZK U-561E	1	43503614R1
R3444	C-CARB ONR	RN7ZK U-391E	1	43503914R1
R3445	C-R NET	RN7L470X04	1	4348474704R2
R3447	C-CARB ONR	RN7ZK U-560E	1	43503604R1
R3448	C-CARB ONR	RN7ZK U-330E	1	43503304R1
R3450	C-CARB ONR	RN7ZK U-560E	1	43503604R1
R3453	C-CARB ONR	RN7ZK U-470E	1	43503470R1
R3454	C-CARB ONR	RN7ZK U-470E	1	43503470R1
R3455	C-CARB ONR	RN7ZK U-121E	1	435031214R1
R3456	C-CARB ONR	RN7ZK U-470E	1	43503470R1
R3457	C-CARB ONR	RN7ZK U-470E	1	43503470R1
R3458	C-CARB ONR	RN7ZK U-470E	1	43503470R1
R3459	C-CARB ONR	RN7ZK U-470E	1	43503470R1
R3460	C-CARB ONR	RN7ZK U-470E	1	43503470R1
R3461	C-CARB ONR	RN7ZK U-470E	1	43503470R1
R3462	C-CARB ONR	RN7ZK U-102E	1	435031024R1
R3464	C-CARB ONR	RN7ZK U-102E	1	435031024R1
R3465	C-CARB ONR	RN7ZK U-102E	1	435031024R1
R3466	C-CARB ONR	RN7ZK U-102E	1	435031024R1
R3468	C-CARB ONR	RN7ZK U-103E	1	435031034R1
R3469	C-CARB ONR	RN7ZK U-103E	1	435031034R1
R3470	C-CARB ONR	RN7ZK U-103E	1	435031034R1
R3473	C-CARB ONR	RN7ZK U-103E	1	435031034R1
R3474	C-CARB ONR	RN7ZK U-103E	1	435031034R1
R3480	C-CARB ONR	RN7ZK U-472E	1	435034724R1
R3481	C-CARB ONR	RN7ZK U-332E	1	43503324R1
R3484	C-CARB ONR	RN7ZK U-470E	1	43503470R1
R3485	C-CARB ONR	RN7ZK U-470E	1	43503470R1

R3486	C-CARB ONR	RN7ZK11-472JE	1	435034724R1
R3487	C-CARB ONR	RN7ZK11-531JE	1	435033314R1
R3488	C-CARB ONR	RN7ZK11-532JE	1	435033324R1
R3489	C-CARB ONR	RN7ZK11-470JE	1	435034704R1
R3491	C-CARB ONR	RN7ZK11-332JE	1	435033324R1
R3492	C-CARB ONR	RN7ZK11-531JE	1	435033314R1
R3494	C-R-NET	RM7LJ470X04	1	4348474704R2
R3495	C-R-NET	RM7LJ470X04	1	4348474704R2
R3496	C-R-NET	RM7LJ470X04	1	4348474704R2
R3497	C-R-NET	RM7LJ470X04	1	4348474704R2
R3498	C-CARB ONR	RN7ZK11-531JE	1	435033314R1
R3500	C-CARB ONR	RN7ZK11-470JE	1	435034704R1
R3501	C-CARB ONR	RN7ZK11-470JE	1	435034704R1
R3502	C-CARB ONR	RN7ZK11-470JE	1	435034704R1
R3503	C-CARB ONR	RN7ZK11-470JE	1	435034704R1
R3504	C-CARB ONR	RN7ZK11-470JE	1	435034704R1
R3505	C-CARB ONR	RN7ZK11-470JE	1	435034704R1
R3506	C-CARB ONR	RN7ZK11-470JE	1	435034704R1
R3508	C-CARB ONR	RN7ZK11-470JE	1	435034704R1
R3510	C-CARB ONR	RN7ZK11-470JE	1	435034704R1
R3512	C-CARB ONR	RN7ZK11-470JE	1	435034704R1
R3513	C-CARB ONR	RN7ZK11-470JE	1	435034704R1
R3515	C-CARB ONR	RN7ZK11-470JE	1	435034704R1
R3516	C-CARB ONR	RN7ZK11-472JE	1	435034724R1
R3670	C-CARB ONR	RN7ZK11-103JE	1	435031034R1
R3671	C-CARB ONR	RN7ZK11-000JE	1	435030004R1
R3673	C-CARB ONR	RN7ZK11-082JE	1	435030824R1
R3674	C-CARB ONR	RN7ZK11-000JE	1	435030004R1
R8001	C-CARB ONR	RN7ZK11-220JE	1	435032204R1
R8005	C-CARB ONR	RN7ZK11-750JE	1	435037504R1
R8008	C-CARB ONR	RN7ZK11-471JE	1	435034714R1
R8009	C-CARB ONR	RN7ZK11-680JE	1	435036804R1
R8010	C-CARB ONR	RN7ZK11-471JE	1	435034714R1
R8011	C-CARB ONR	RN7ZK11-680JE	1	435036804R1
R8013	C-CARB ONR	RN7ZK11-220JE	1	435032204R1
R8014	C-CARB ONR	RN7ZK11-220JE	1	435032204R1
R8017	C-CARB ONR	RN7ZK11-750JE	1	435037504R1
R8018	C-CARB ONR	RN7ZK11-750JE	1	435037504R1
R8020	C-CARB ONR	RN7ZK11-471JE	1	435034714R1
R8021	C-CARB ONR	RN7ZK11-680JE	1	435036804R1
R8022	C-CARB ONR	RN7ZK11-471JE	1	435034714R1
R8023	C-CARB ONR	RN7ZK11-680JE	1	435036804R1
R8027	C-CARB ONR	RN7ZK11-220JE	1	435032204R1
R8031	C-CARB ONR	RN7ZK11-750JE	1	435037504R1
R8032	C-CARB ONR	RN7ZK11-471JE	1	435034714R1
R8033	C-CARB ONR	RN7ZK11-680JE	1	435036804R1
R8034	C-CARB ONR	RN7ZK11-471JE	1	435034714R1

R8035	C-CARB ONR	RN7ZK U-680E	1	43503680R1
R8038	C-CARB ONR	RN7ZK U-220E	1	43503220R1
R8039	C-CARB ONR	RN7ZK U-220E	1	43503220R1
R8042	C-CARB ONR	RN7ZK U-750E	1	43503750R1
R8043	C-CARB ONR	RN7ZK U-750E	1	43503750R1
R8044	C-CARB ONR	RN7ZK U-471E	1	43503471R1
R8045	C-CARB ONR	RN7ZK U-680E	1	43503680R1
R8046	C-CARB ONR	RN7ZK U-220E	1	43503220R1
R8047	C-CARB ONR	RN7ZK U-471E	1	43503471R1
R8048	C-CARB ONR	RN7ZK U-680E	1	43503680R1
R8049	C-CARB ONR	RN7ZK U-220E	1	43503220R1
R8050	C-CARB ONR	RN7ZK U-471E	1	43503471R1
R8051	C-CARB ONR	RN7ZK U-680E	1	43503680R1
R8052	C-CARB ONR	RN7ZK U-220E	1	43503220R1
R8053	C-CARB ONR	RN7ZK U-471E	1	43503471R1
R8054	C-CARB ONR	RN7ZK U-680E	1	43503680R1
R8055	C-CARB ONR	RN7ZK U-750E	1	43503750R1
R8056	C-CARB ONR	RN7ZK U-750E	1	43503750R1
R8057	C-CARB ONR	RN7ZK U-750E	1	43503750R1
R8058	C-CARB ONR	RN7ZK U-101E	1	43503101R1
R8059	C-CARB ONR	RN7ZK U-101E	1	43503101R1
R8060	C-CARB ONR	RN7ZK U-103E	1	43503103R1
R8061	C-CARB ONR	RN7ZK U-103E	1	43503103R1
R8062	C-CARB ONR	RN7ZK U-103E	1	43503103R1
R8063	C-CARB ONR	RN7ZK U-103E	1	43503103R1
R8065	C-CARB ONR	RN7ZK U-330E	1	43503330R1
R8066	C-CARB ONR	RN7ZK U-330E	1	43503330R1
R8075	C-CARB ONR	RN7ZK U-750E	1	43503750R1
R8076	C-CARB ONR	RN7ZK U-750E	1	43503750R1
R8077	C-CARB ONR	RN7ZK U-750E	1	43503750R1
R8078	C-CARB ONR	RN7ZK U-750E	1	43503750R1
R8079	C-CARB ONR	RN7ZK U-750E	1	43503750R1
R8080	C-CARB ONR	RN7ZK U-750E	1	43503750R1
R8160	C-CARB ONR	RN7ZK U-472E	1	43503472R1
R8161	C-CARB ONR	RN7ZK U-104E	1	43503104R1
R8162	C-CARB ONR	RN7ZK U-104E	1	43503104R1
R8163	C-CARB ONR	RN7ZK U-104E	1	43503104R1
R8164	C-CARB ONR	RN7ZK U-104E	1	43503104R1
R8165	C-CARB ONR	RN7ZK U-104E	1	43503104R1
R8166	C-CARB ONR	RN7ZK U-000E	1	43503000R1
R8204	C-CARB ONR	RN7ZK U-000E	1	43503000R1
R8205	C-CARB ONR	RN7ZK U-000E	1	43503000R1
R8206	C-CARB ONR	RN7ZK U-103E	1	43503103R1
R8207	C-CARB ONR	RN7ZK U-271E	1	43503271R1
R8208	C-CARB ONR	RN7ZK U-103E	1	43503103R1
R8210	C-CARB ONR	RN7ZK U-560E	1	43503560R1
R8211	C-R NET	RN7LJ220X04	1	434847200R2

R8273	C-CARB ONR			RN7ZK11-000E	1	43503004R1
R8274	C-CARB ONR			RN7ZK11-272FE	1	43503272R1
R8275	C-CARB ONR			RN7ZK11-331FE	1	43503312R1
R8276	C-CARB ONR			RN7ZK11-220E	1	43503220R1
R8277	C-CARB ONR			RN7ZK11-220E	1	43503220R1
R8281	C-R-NET			RM7LJ220X04	1	4348472004R2
R8282	C-R-NET			RM7LJ220X04	1	4348472004R2
R8283	C-CARB ONR			RN7ZK11-220E	1	43503220R1
R8284	C-R-NET			RM7LJ220X04	1	4348472004R2
R8285	C-CARB ONR			RN7ZK11-220E	1	43503220R1
R8286	C-CARB ONR			RN7ZK11-220E	1	43503220R1
R8287	C-R-NET			RM7LJ220X04	1	4348472004R2
R8288	C-R-NET			RM7LJ220X04	1	4348472004R2
R8289	C-R-NET			RM7LJ220X04	1	4348472004R2
R8290	C-R-NET			RM7LJ220X04	1	4348472004R2
R8291	C-R-NET			RM7LJ220X04	1	4348472004R2
R8330	C-CARB ONR			RN7ZK11-000E	1	43503004R1
R8331	C-CARB ONR			RN7ZK11-000E	1	43503004R1
R8333	C-CARB ONR			RN7ZK11-103E	1	435031034R1
R8334	C-CARB ONR			RN7ZK11-182E	1	435031824R1
R8335	C-CARB ONR			RN7ZK11-182E	1	435031824R1
R8336	C-CARB ONR			RN7ZK11-472E	1	435034724R1
R8337	C-CARB ONR			RN7ZK11-104E	1	435031044R1
R8338	C-CARB ONR			RN7ZK11-473E	1	435034734R1
R8401	C-CARB ONR			RN7ZK11-220E	1	43503220R1
R8402	C-R-NET			RM7LJ220X04	1	4348472004R2
R8403	C-CARB ONR			RN7ZK11-220E	1	43503220R1
R8404	C-CARB ONR			RN7ZK11-220E	1	43503220R1
R8405	C-CARB ONR			RN7ZK11-220E	1	43503220R1
R8408	C-CARB ONR			RN7ZK11-220E	1	43503220R1
R8409	C-CARB ONR			RN7ZK11-101E	1	435031014R1
R8410	C-CARB ONR			RN7ZK11-000E	1	43503004R1
R8411	C-CARB ONR			RN7ZK11-472E	1	435034724R1
R8412	C-CARB ONR			RN7ZK11-562E	1	435035624R1
R8413	C-CARB ONR			RN7ZK11-000E	1	43503004R1
R8416	C-R-NET			RM7LJ220X04	1	4348472004R2
R8417	C-R-NET			RM7LJ220X04	1	4348472004R2
R8418	C-R-NET			RM7LJ220X04	1	4348472004R2
R8419	C-R-NET			RM7LJ220X04	1	4348472004R2
R8420	C-R-NET			RM7LJ220X04	1	4348472004R2
R8421	C-R-NET			RM7LJ220X04	1	4348472004R2
R8422	C-R-NET			RM7LJ220X04	1	4348472004R2
R8423	C-R-NET			RM7LJ220X04	1	4348472004R2
R8424	C-R-NET			RM7LJ220X04	1	4348472004R2
R8425	C-CARB ONR			RN7ZK11-220E	1	43503220R1
R8426	C-R-NET			RM7LJ220X04	1	4348472004R2
R8427	C-CARB ONR			RN7ZK11-100E	1	435031004R1

R8428	C-CARB ONR	RN7ZK11-100E	1	435031004R1
R8429	C-CARB ONR	RN7ZK11-101E	1	435031014R1
R8430	C-CARB ONR	RN7ZK11-101E	1	435031014R1
R8431	C-CARB ONR	RN7ZK11-101E	1	435031014R1
R8432	C-CARB ONR	RN7ZK11-101E	1	435031014R1
R8433	C-CARB ONR	RN7ZK11-100E	1	435031004R1
R8434	C-CARB ONR	RN7ZK11-103E	1	435031034R1
R8435	C-CARB ONR	RN7ZK11-823E	1	435038234R1
R8436	C-CARB ONR	RN7ZK11-330E	1	435033304R1
R8442	C-CARB ONR	RN7ZK11-000E	1	435030004R1
R8501	C-CARB ONR	RN7ZK11-330E	1	435033304R1
R8502	C-CARB ONR	RN7ZK11-330E	1	435033304R1
R8503	C-CARB ONR	RN7ZK11-330E	1	435033304R1
R8504	C-R NET	RM7LJ330X04	1	4348473304R2
R8505	C-R NET	RM7LJ330X04	1	4348473304R2
R8506	C-CARB ONR	RN7ZK11-120E	1	435031204R1
R8507	C-R NET	RM7LJ330X04	1	4348473304R2
R8508	C-R NET	RM7LJ330X04	1	4348473304R2
R8509	C-R NET	RM7LJ330X04	1	4348473304R2
R8510	C-R NET	RM7LJ330X04	1	4348473304R2
R8511	C-R NET	RM7LJ330X04	1	4348473304R2
R8512	C-R NET	RM7LJ330X04	1	4348473304R2
R8513	C-R NET	RM7LJ330X04	1	4348473304R2
R8516	C-CARB ONR	RN7ZK11-101E	1	435031014R1
R8517	C-CARB ONR	RN7ZK11-101E	1	435031014R1
R8518	C-CARB ONR	RN7ZK11-472E	1	435034724R1
R8519	C-CARB ONR	RN7ZK11-220E	1	435032204R1
R8520	C-CARB ONR	RN7ZK11-330E	1	435033304R1
R8521	C-CARB ONR	RN7ZK11-330E	1	435033304R1
R8522	C-R NET	RM7LJ330X04	1	4348473304R2
R8523	C-CARB ONR	RN7ZK11-330E	1	435033304R1
R8524	C-CARB ONR	RN7ZK11-330E	1	435033304R1
R8525	C-CARB ONR	RN7ZK11-472E	1	435034724R1
R8526	C-CARB ONR	RN7ZK11-472E	1	435034724R1
R8527	C-CARB ONR	RN7ZK11-562E	1	435035624R1
R8528	C-CARB ONR	RN7ZK11-562E	1	435035624R1
R8530	C-CARB ONR	RN7ZK11-105E	1	435031054R1
R8533	C-CARB ONR	RN7ZK11-000E	1	435030004R1
R8534	C-CARB ONR	RN7ZK11-330E	1	435033304R1
R8607	C-CARB ONR	RN7ZK11-473E	1	435034734R1
R8608	C-CARB ONR	RN7ZK11-473E	1	435034734R1
R8609	C-CARB ONR	RN7ZK11-000E	1	435030004R1
R8610	C-CARB ONR	RN7ZK11-000E	1	435030004R1
R8617	C-CARB ONR	RN7ZK11-473E	1	435034734R1
R8618	C-CARB ONR	RN7ZK11-473E	1	435034734R1
R8619	C-CARB ONR	RN7ZK11-000E	1	435030004R1
R8620	C-CARB ONR	RN7ZK11-000E	1	435030004R1

R8627	C-CARB ONR	RN7ZK U-473E	1	435034734R1
R8628	C-CARB ONR	RN7ZK U-473E	1	435034734R1
R8629	C-CARB ONR	RN7ZK U-000E	1	435030004R1
R8630	C-CARB ONR	RN7ZK U-000E	1	435030004R1
R8637	C-CARB ONR	RN7ZK U-473E	1	435034734R1
R8638	C-CARB ONR	RN7ZK U-473E	1	435034734R1
R8639	C-CARB ONR	RN7ZK U-000E	1	435030004R1
R8640	C-CARB ONR	RN7ZK U-000E	1	435030004R1
R8641	C-CARB ONR	RN7ZK U-000E	1	435030004R1
R8642	C-CARB ONR	RN7ZK U-000E	1	435030004R1
R8643	C-CARB ONR	RN7ZK U-472E	1	435034724R1
R8644	C-CARB ONR	RN7ZK U-472E	1	435034724R1
R8647	C-CARB ONR	RN7ZK U-473E	1	435034734R1
R8648	C-CARB ONR	RN7ZK U-473E	1	435034734R1
R8649	C-CARB ONR	RN7ZK U-000E	1	435030004R1
R8650	C-CARB ONR	RN7ZK U-000E	1	435030004R1
R8657	C-CARB ONR	RN7ZK U-473E	1	435034734R1
R8658	C-CARB ONR	RN7ZK U-473E	1	435034734R1
R8659	C-CARB ONR	RN7ZK U-000E	1	435030004R1
R8660	C-CARB ONR	RN7ZK U-000E	1	435030004R1
R8701	C-CARB ONR	RN7ZK U-103E	1	435031034R1
R8702	C-CARB ONR	RN7ZK U-103E	1	435031034R1
R8703	C-CARB ONR	RN7ZK U-103E	1	435031034R1
R8704	C-CARB ONR	RN7ZK U-103E	1	435031034R1
R8705	C-CARB ONR	RN7ZK U-220E	1	435032204R1
R8706	C-CARB ONR	RN7ZK U-220E	1	435032204R1
R8707	C-CARB ONR	RN7ZK U-220E	1	435032204R1
R8708	C-CARB ONR	RN7ZK U-103E	1	435031034R1
R8709	C-CARB ONR	RN7ZK U-103E	1	435031034R1
R8710	C-CARB ONR	RN7ZK U-103E	1	435031034R1
R8711	C-CARB ONR	RN7ZK U-222E	1	435032224R1
R8712	C-R-NET	RM7LJ222X04	1	43484722204R2
R8713	C-R-NET	RM7LJ222X04	1	43484722204R2
R8714	C-R-NET	RM7LJ222X04	1	43484722204R2
R8718	C-CARB ONR	RN7ZK U-220E	1	435032204R1
R8719	C-CARB ONR	RN7ZK U-103E	1	435031034R1
R8720	C-CARB ONR	RN7ZK U-220E	1	435032204R1
R8721	C-CARB ONR	RN7ZK U-220E	1	435032204R1
R8722	C-CARB ONR	RN7ZK U-103E	1	435031034R1
R8723	C-CARB ONR	RN7ZK U-103E	1	435031034R1
R8724	C-R-NET	RM7LJ103X04	1	43484710304R2
R8726	C-CARB ONR	RN7ZK U-103E	1	435031034R1
R8730	C-CARB ONR	RN7ZK U-222E	1	435032224R1
R8731	C-CARB ONR	RN7ZK U-222E	1	435032224R1
R8733	C-CARB ONR	RN7ZK U-103E	1	435031034R1
R8738	C-CARB ONR	RN7ZK U-103E	1	435031034R1
R8742	C-CARB ONR	RN7ZK U-103E	1	435031034R1

R8743	C-CARB ONR		RN7ZK U-103E	1	435031034R1	
R8746	C-CARB ONR		RN7ZK U-103E	1	435031034R1	
R8747	C-CARB ONR		RN7ZK U-103E	1	435031034R1	
R8749	C-CARB ONR		RN7ZK U-220E	1	435032204R1	
R8750	C-CARB ONR		RN7ZK U-000E	1	435030004R1	
R8751	C-CARB ONR		RN7ZK U-000E	1	435030004R1	
R8752	C-CARB ONR		RN7ZK U-000E	1	435030004R1	
R8753	C-CARB ONR		RN7ZK U-101E	1	435031014R1	
R8756	C-CARB ONR		RN7ZK U-101E	1	435031014R1	
R8757	C-CARB ONR		RN7ZK U-103E	1	435031034R1	
R8758	C-CARB ONR		RN7ZK U-103E	1	435031034R1	
R8760	C-CARB ONR		RN7ZK U-103E	1	435031034R1	
R8803	C-CARB ONR		RN7ZK U-000E	1	435030004R1	
R8804	C-CARB ONR		RN7ZK U-103E	1	435031034R1	
R8805	C-CARB ONR		RN7ZK U-000E	1	435030004R1	
R8806	C-R-NET		RM7LJ220X04	1	4346472204R2	
R8807	C-R-NET		RM7LJ220X04	1	4346472204R2	
R8808	C-R-NET		RM7LJ220X04	1	4346472204R2	
R8809	C-R-NET		RM7LJ220X04	1	4346472204R2	
R8810	C-R-NET		RM7LJ220X04	1	4346472204R2	
R8811	C-R-NET		RM7LJ220X04	1	4346472204R2	
R8930	C-CARB ONR		RN7ZK 2E-470E	1	435224704R1	
R8931	C-CARB ONR		RN7ZK 2E-470E	1	435224704R1	
R8932	C-CARB ONR		RN7ZK 2E-470E	1	435224704R1	
R8933	C-CARB ONR		RN7ZK U-593E	1	43503934R1	
R8934	C-CARB ONR		RN7ZK U-473E	1	435034734R1	
R8935	C-CARB ONR		RN7ZK U-152E	1	435031524R1	
R8936	C-CARB ONR		RN7ZK U-563E	1	435035634R1	
R8937	C-CARB ONR		RN7ZK U-473E	1	435034734R1	
R8941	C-CARB ONR		RN7ZK U-683E	1	435036834R1	
R8942	C-CARB ONR		RN7ZK U-472E	1	435034724R1	
R8943	C-CARB ONR		RN7ZK U-103E	1	435031034R1	
R8951	C-CARB ONR		RN7ZK U-103E	1	435031034R1	
R8952	C-CARB ONR		RN7ZK U-682E	1	435036824R1	
R8954	C-CARB ONR		RN7ZK U-822E	1	435038224R1	
R8955	C-CARB ONR		RN7ZK U-563E	1	435035632R1	
R8956	C-CARB ONR		RN7ZK U-24E	1	43503242R1	
R8957	C-CARB ONR		RN7ZK U-103E	1	435031032R1	
R8961	C-CARB ONR		RN7ZK U-103E	1	435031034R1	
R8962	C-CARB ONR		RN7ZK U-822E	1	435038224R1	
R8964	C-CARB ONR		RN7ZK U-562E	1	435035624R1	
R8965	C-CARB ONR		RN7ZK U-273E	1	435032732R1	
R8966	C-CARB ONR		RN7ZK U-824E	1	435038242R1	
R8967	C-CARB ONR		RN7ZK U-103E	1	435031032R1	
R8968	C-CARB ONR		RN7ZK U-472E	1	435034722R1	
R8971	C-CARB ONR		RN7ZK U-103E	1	435031034R1	
R8972	C-CARB ONR		RN7ZK U-562E	1	435035624R1	

R8974	C-CARB ONR	RN7ZK1J-182JE	1	435031824R1
R8975	C-CARB ONR	RN7ZK1J-392FE	1	43503922R1
R8976	C-CARB ONR	RN7ZK1J-563FE	1	43503632R1
R8977	C-CARB ONR	RN7ZK1J-103FE	1	435031032R1
R8981	C-CARB ONR	RN7ZK1J-103JE	1	435031034R1
R8982	C-CARB ONR	RN7ZK1J-562JE	1	43503624R1
R8984	C-CARB ONR	RN7ZK1J-182JE	1	435031824R1
R8985	C-CARB ONR	RN7ZK1J-222FE	1	43503222R1
R8986	C-CARB ONR	RN7ZK1J-183FE	1	435031832R1
R8987	C-CARB ONR	RN7ZK1J-103FE	1	435031032R1
R8988	C-CARB ONR	RN7ZK1J-103JE	1	435031034R1
R8989	C-CARB ONR	RN7ZK1J-103JE	1	435031034R1
R8990	C-CARB ONR	RN7ZK1J-103JE	1	435031034R1
NEW TRAIL				
JL2100B	SOCKET	NSCT-5P97	1	25050269
JL4518B	WIRE TRAP	NPLG-5P588	1	25055626
P2101B	SOCKET	NSCT-19P2112	1	25052215
P3001	SOCKET(B to B)	IMSA-9850S-20Y900	1	25052813R2
P3101A	PLUG	NPLG-5P918	1	25055965R2
P3102A	SOCKET	NSCT-9P2472	1	25052575R2
P3104	SOCKET	EJFR0002	1	25056668
P3104 or	SOCKET	SI-60073-F	(1)	25053307
P3401	SOCKET(B to B)	IMSA-9850S-16Y900	1	25052811R2
P3605A	PLUG	IMSA-9142B-18A	1	25056599
P3607A	PLUG	IMSA-9142B-16A	1	25056598
P3608A	PLUG	IMSA-9142B-18A	1	25056599
P3610	SOCKET	NSCT-8P2471	1	25052574R2
P8002B	SOCKET	NSCT-11P2474	1	25052577R2
P8011	SOCKET	IMSA-9618S-94A	1	25053329R2
P8011 or	SOCKET	04FMN-SMT-A-TF	(1)	25052821R2
P8100	TRM-423(SCREW)	NEJITANSI ST3	1	25060495
P8206	SOCKET	NSCT-8P2471	1	25052574R2
P8302	SOCKET	YK F45-7037V	1	25053253R3
P8302 or	SOCKET	HDM(47266-4101)	(1)	25053389R3
P8601	SOCKET	YK F45-7037V	1	25053253R3
P8601 or	SOCKET	HDM(47266-4101)	(1)	25053389R3
P8611	SOCKET	YK F45-7037V	1	25053253R3
P8611 or	SOCKET	HDM(47266-4101)	(1)	25053389R3
P8621	SOCKET	YK F45-7037V	1	25053253R3
P8621 or	SOCKET	HDM(47266-4101)	(1)	25053389R3
P8631	SOCKET	YK F45-7037V	1	25053253R3
P8631 or	SOCKET	HDM(47266-4101)	(1)	25053389R3
P8641B	SOCKET	FX16-31S-D SSH	1	25053365R2
P8642	SOCKET	YK F45-7037V	1	25053253R3
P8642 or	SOCKET	HDM(47266-4101)	(1)	25053389R3
P8651	SOCKET	YK F45-7037V	1	25053253R3
P8651 or	SOCKET	HDM(47266-4101)	(1)	25053389R3

P8702 SOCKET NSCT-9P2472 1 25052575R.2

PC BOARD PARTS LIST TX-NR708

U0080 FRONT HDMI TERMINAL PC BOARD AS BAHDM-0290-1A 1 1B234590-1A

CIRCUIT NO.	PART NAME	DESCRIPTION	QTY	PART NO. (SN)	REMARKS
[REAR CONDUCTOR]					
D8661	C-DIODE	KD54148U	1	22328R.2	
D8661 or	C-DIODE	1SS352	(1)	223234R.2	
D8662	C-DIODE	KD54148U	1	22328R.2	
D8662 or	C-DIODE	1SS352	(1)	223234R.2	
Q8661	IC	TMD5141RHARG4	1	22242586R.2	
[TRANS COIL]					
L8661	CORE	BLM18PG181SN1D	1	2250005R.1	
[CAPACITOR]					
C8661	C-FILM C	ECHU16V-104J	1	373041044R.2	
C8663	C-CERA C	CK725F1A-105Z1	1	332181050R.1	
C8664	C-CERA C	CK725B1H-102K1	1	332101025R.1	
C8669	C-CERA C	CK725F1A-105Z1	1	332181050R.1	
C8670	C-CERA C	CK725B1H-102K1	1	332101025R.1	
C8671	C-CERA C	CK725F1A-105Z1	1	332181050R.1	
C8672	C-CERA C	CK725B1H-102K1	1	332101025R.1	
C8673	C-CERA C	CK725F1A-105Z1	1	332181050R.1	
C8674	C-CERA C	CK725B1H-102K1	1	332101025R.1	
C8675	C-CERA C	CK725F1A-105Z1	1	332181050R.1	
C8676	C-CERA C	CK725B1H-102K1	1	332101025R.1	
C8677	C-CERA C	CK725B0J-106K	1	332091065R.2	
C8680	C-CERA C	CK725B0J-106K	1	332091065R.2	
[RESISTOR]					
R8667	C-CARB ONR	RN72K1J-473E	1	435034734R.1	
R8668	C-CARB ONR	RN72K1J-473E	1	435034734R.1	
R8669	C-CARB ONR	RN72K1J-000E	1	435030004R.1	
R8670	C-CARB ONR	RN72K1J-000E	1	435030004R.1	
R8672	C-CARB ONR	RN72K1J-103E	1	435031034R.1	
R8673	C-CARB ONR	RN72K1J-472E	1	435034724R.1	
R8674	C-CARB ONR	RN72K1J-103E	1	435031034R.1	
R8675	C-CARB ONR	RN72K1J-103E	1	435031034R.1	
R8676	C-CARB ONR	RN72K1J-103E	1	435031034R.1	
R8680	C-CARB ONR	RN72K1J-000E	1	435030004R.1	
R8681	C-CARB ONR	RN72K1J-000E	1	435030004R.1	
[SMT TRAIL]					
P8661C	SOCKET	F216-31S-0-SSV	1	25053354R.2	
P8661	SOCKET	VF45-703TV	1	25053353R.3	
P8663	CRIMP AS	CRIMP AS DX730	1	20639251000L	

ONKYO CORPORATION

Service Dept. Technical Support : 2-1, Nisshin-cho, Neyagawa-shi, OSAKA 572-8540, JAPAN
Tel: 072-831-8023 Fax: 072-831-8163

ONKYO U.S.A. CORPORATION

18 Park Way, Upper Saddle River, N.J. 07458, U.S.A.
Tel: 800-229-1687, 201-785-2600 Fax: 201-785-2650 <http://www.us.onkyo.com/>

ONKYO EUROPE ELECTRONICS GmbH

Liegnitzerstrasse 6, 82194 Groebenzell, GERMANY
Tel: +49-8142-4401-0 Fax: +49-8142-4401-555 <http://www.eu.onkyo.com/>

ONKYO EUROPE ELECTRONICS GmbH (UK BRANCH)

The Coach House 81A High Street, Marlow, Buckinghamshire, SL7 1AB, UK
Tel: +44-(0)1628-473-350 Fax: +44-(0)1628-401-700

ONKYO CHINA LIMITED

Unit 1&12, 9/F, Ever Gain Plaza Tower 1, 88, Container Port Road, Kwai Chung,
N.T., Hong Kong. Tel: 852-2429-3118 Fax: 852-2428-9039
<http://www.ch.onkyo.com/>

