

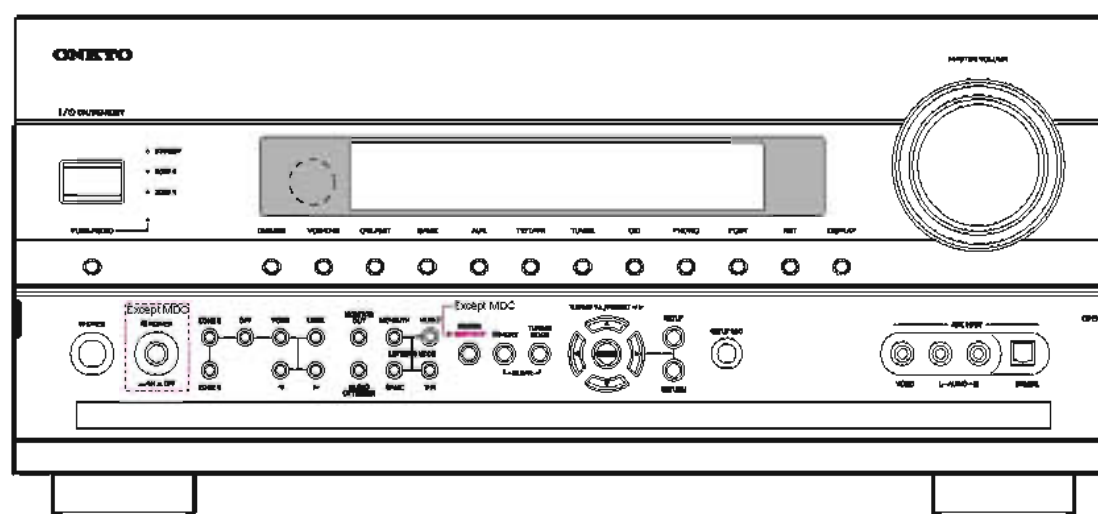

ONKYO SERVICE MANUAL**AV RECEIVER
MODEL TX-NR807 (B)/(S)****Black and Silver models**

BMDC	120V AC 60Hz
BMMP, SMMP	230-240V AC 50/60Hz
BMMO, SMMO	230-240V AC 50/60Hz
BMMA, SMMA	
BMMR	
BMMA, SMMA	
BMMB, SMMB	

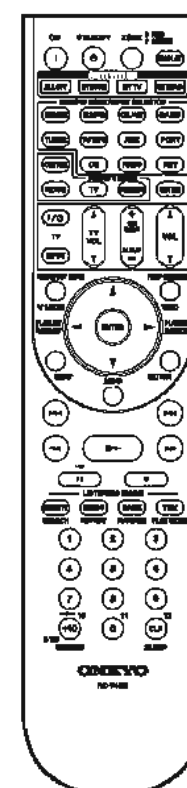

RC-745M

**SAFETY-RELATED COMPONENT
WARNING!!**

COMPONENTS IDENTIFIED BY MARK  ON THE SCHEMATIC DIAGRAM AND IN THE PARTS LIST ARE CRITICAL FOR RISK OF FIRE AND ELECTRIC SHOCK. REPLACE THESE COMPONENTS WITH ONKYO PARTS WHOSE PART NUMBERS APPEAR AS SHOWN IN THIS MANUAL.

MAKE LEAKAGE-CURRENT OR RESISTANCE MEASUREMENTS TO DETERMINE THAT EXPOSED PARTS ARE ACCEPTABLY INSULATED FROM THE SUPPLY CIRCUIT BEFORE RETURNING THE APPLIANCE TO THE CUSTOMER.

SERVICE PROCEDURE-1

1. Replacing the fuses

 This symbol located near the fuse indicates that the fuse used is slow operating type. For continued protection against fire hazard, replace with same type fuse. For fuse rating, refer to the marking adjacent to the symbol.

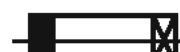
 Ce symbole indique que le fusible utilisé est à lent. Pour une protection permanente, n'utiliser que des fusibles de même type. Ce dernier est indiqué là où le présent symbole est apposé.

<Notes>

<DC> : TX-NR807 Canadian model	<MA> : TX-NR807 Australian model
<MO> : TX-NR807 Saudi Arabia model	<MQ> : TX-NR807 Asian model for 220V-240V
<DF> : TX-NR807 Taiwanese model	<MR> : TX-SA707 Chinese model
<MP> : TX-NR807 European model	<MB> : TX-NR807 Britain model

REF NO.	PART NAME	DESCRIPTION	PART NO.	REMARKS
F4000	FUSE	4A-UL/T-233	252325GR	!
F4000 or	FUSE	4A-T/UL-ST2	252257GR	!
F4001	FUSE	4A-UL/T-233	252325GR	!
F4001 or	FUSE	4A-T/UL-ST2	252257GR	!
F6901	FUSE	15A-TUL-250V	252303GR	!
F6902	FUSE	15A-TUL-250V	252303GR	!
F901	FUSE	10A-UL/T-233	252330GR	! <DC><DF>
F901 or	FUSE	10A-T/UL-ST2	252333GR	! <DC><DF>
D901	FUSE	5A-SE-EAK FUSE	252078GR	! <MP><MO><MQ><MA><MR>
F901 or	FUSE	5A-SE-TL250V	252278GR	! <MP><MO><MQ><MA><MR>

2. To initialize the unit

1. Press and hold down VCR/DVR button, then press ON/STANDBY button when the unit is powered on.
2. After " *Clear* " is displayed, the preset memory and each mode stored in the memory are initialized and will return to the factory settings, and turn to Standby mode.

3. Safety check out

(U.S.A. model only)

After correcting the original service problem, perform the following safety check before releasing the unit to the customer.

Leakage current Check

Measure the leakage current to a known earth ground (water pipe or conduct etc.) by connecting a leakage current tester between the earth ground and exposed metal parts of the unit (input/output ground terminals, screw heads or metal overlays etc.).

Plug the power supply cord directly into a 120Vac 60Hz wall socket and turn ON/STANDBY button on.

Any current measured must not exceed 0.5mA.

4. Memory Backup

This model uses a EE-PROM IC in order to retain radio presets and other settings. So, memory contents will be kept eternally with no care.

SERVICE PROCEDURE-2

5. Replacing Power Amplifier Parts

When a power amplifier of certain channel is broken and goes into Protect mode, the following parts in the channel must be replaced at the sametime, because these parts also get damage in most cases.

Front L ch	Front R ch	Center ch	Surround L ch	Surround R ch	Surround Back L ch	Surround Back R ch
Q6000,Q6010	Q6001,Q6011	Q6002,Q6012	Q6003,Q6013	Q6004,Q6014	Q6005,Q6015	Q6006,Q6016
Q6030,Q6040	Q6031,Q6041	Q6032,Q6042	Q6033,Q6043	Q6034,Q6044	Q6035,Q6045	Q6036,Q6046
Q6100,Q6110	Q6101,Q6111	Q6052,Q6062	Q6053,Q6063	Q6054,Q6064	Q6055,Q6065	Q6056,Q6066
Q6050,Q6060	Q6051,Q6061	Q6082,Q6092	Q6083,Q6093	Q6084,Q6094	Q6085,Q6095	Q6086,Q6096
Q6070	Q6071	Q6072	Q6073	Q6074	Q6075	Q5096
Q5000,Q5010	Q5001,Q5010	Q5002,Q5012	Q5003,Q5013	Q5004,Q5014	Q5005,Q5015	Q5006,Q5016
Q5030,Q5040	Q5031,Q5041	Q5032,Q5042	Q5033,Q5043	Q5034,Q5044	Q5035,Q5045	Q5036,Q5046
Q5050,Q5060	Q5051,Q5061	Q5052,Q5062	Q5053,Q5063	Q5054,Q5064	Q5055,Q5065	Q5056,Q5066
Q5070	Q5071	Q5072	Q8073	Q8074	Q8075	Q8076

BAAMP-0072 and BACLA-0087 are electrically and mechanically full-compatible with each other, but idling readjustment is necessary.

BAAMP-0072 and BACLA-0087 are also electrically and mechanically full-compatible with each other, but idling readjustment is necessary.

The parts listed above include the following driver-stage components in each pcb.

ADJUSTMENT PROCEDURE

ADJUSTMENT OF IDLING CURRENT

- 1) Setting R6040 to R6046 to minimum position before power ON.
- 2) Setting the voltage at P6080 to P6086 to 3mV by adjusting R6040 to R6046, under the condition of no input signal and no load, immediately after power ON.

L/C/R		SL/SR/SBL/ABR
Below 4mV	4mV	4mV
Between 4 ~ 6mV	Leave just as it is.	Leave just as it is.
Over 6mV	6mV	6mV

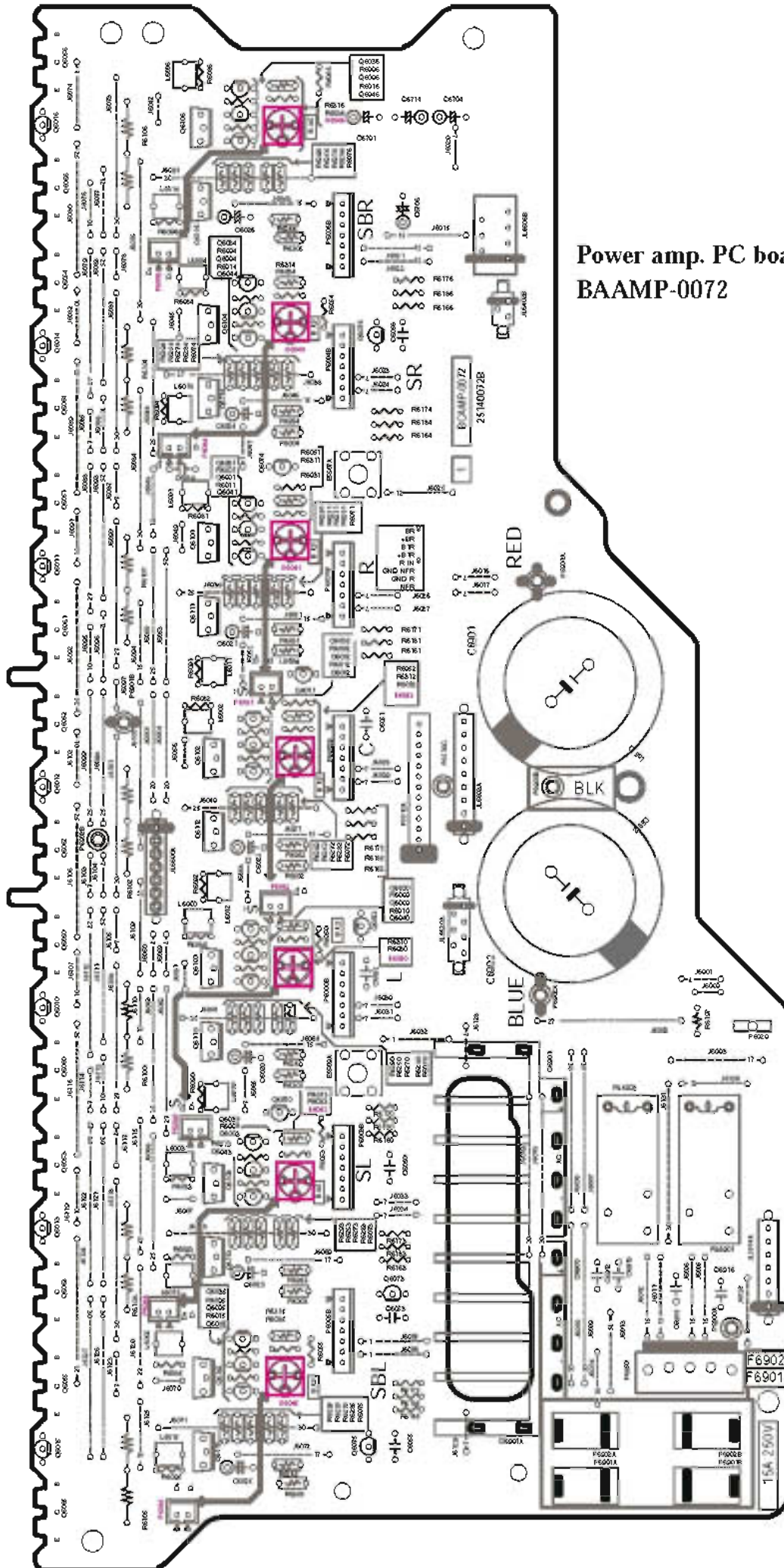

Power amp. PC board
BAAMP-0072

EXPLODED VIEWS-2

<Fig-1>

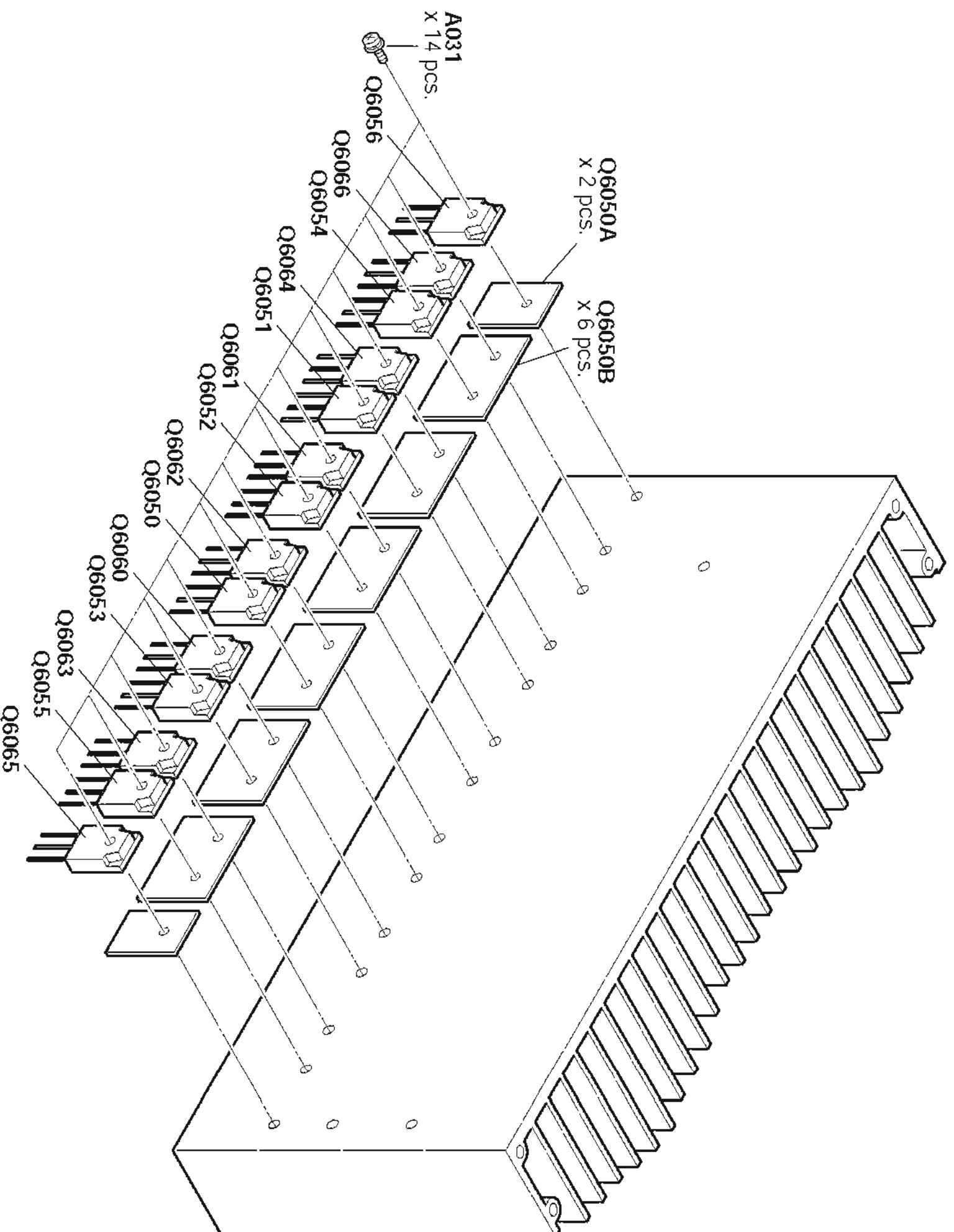

BLOCK DIAGRAM-1 AUDIO SECTION

(PART-1)

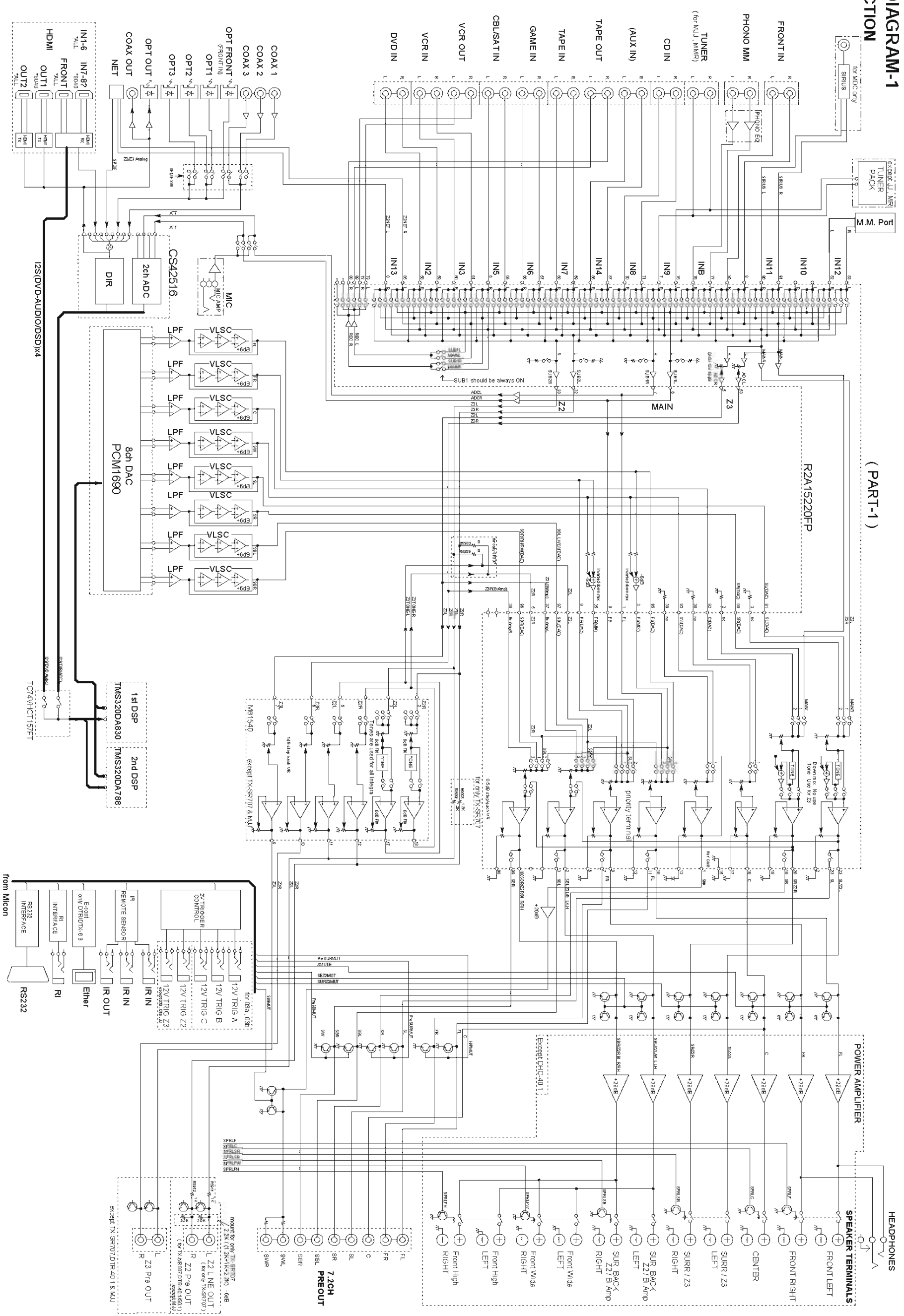

from Micron

RS232 INTERFACE

RS232 INTERFACE

BLOCK DIAGRAM-2 VIDEO SECTION

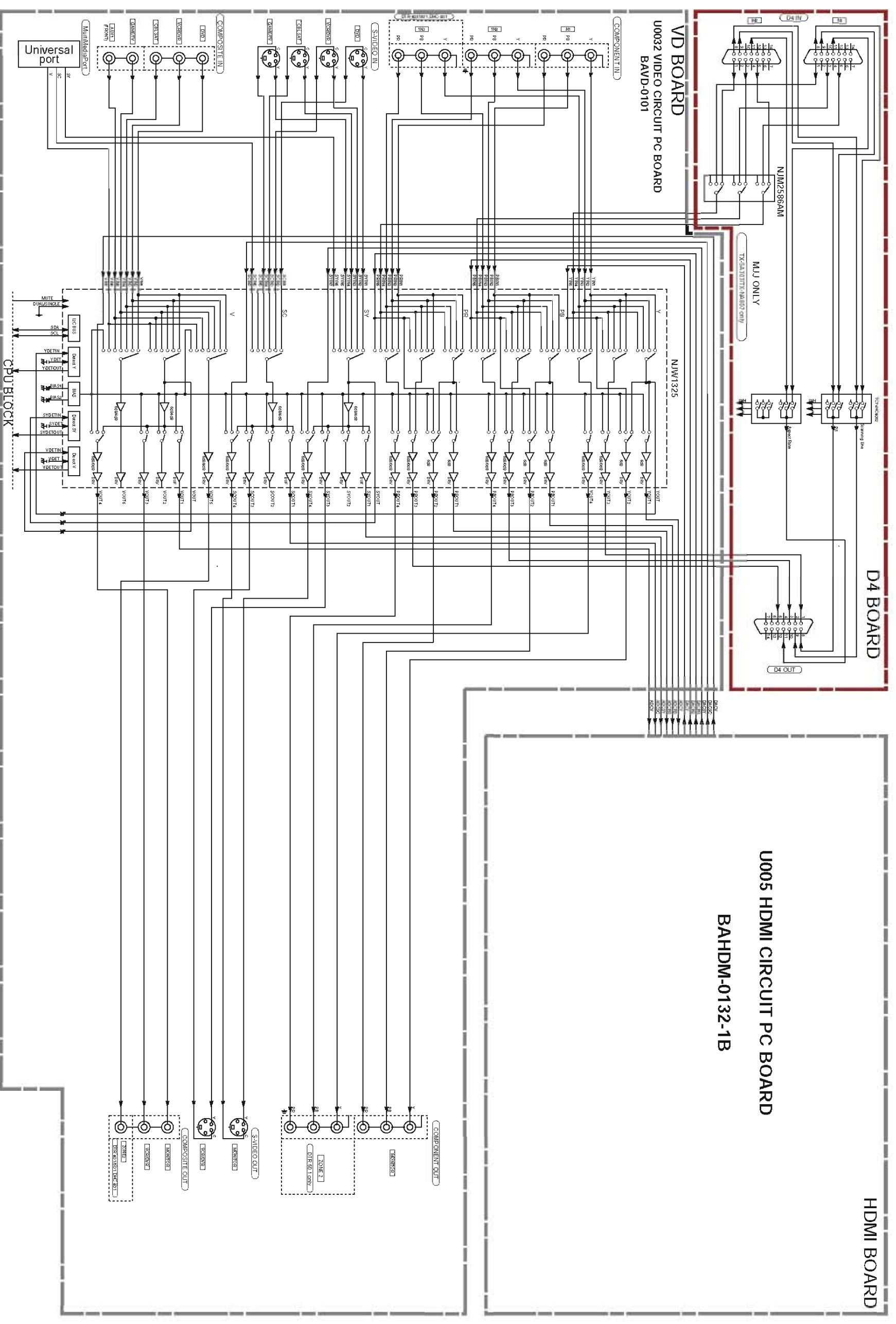

BLOCK DIAGRAM-3 (PART-3)

HDMI SECTION

U005

HDMI CIRCUIT PC BOARD

BAHDM-0132

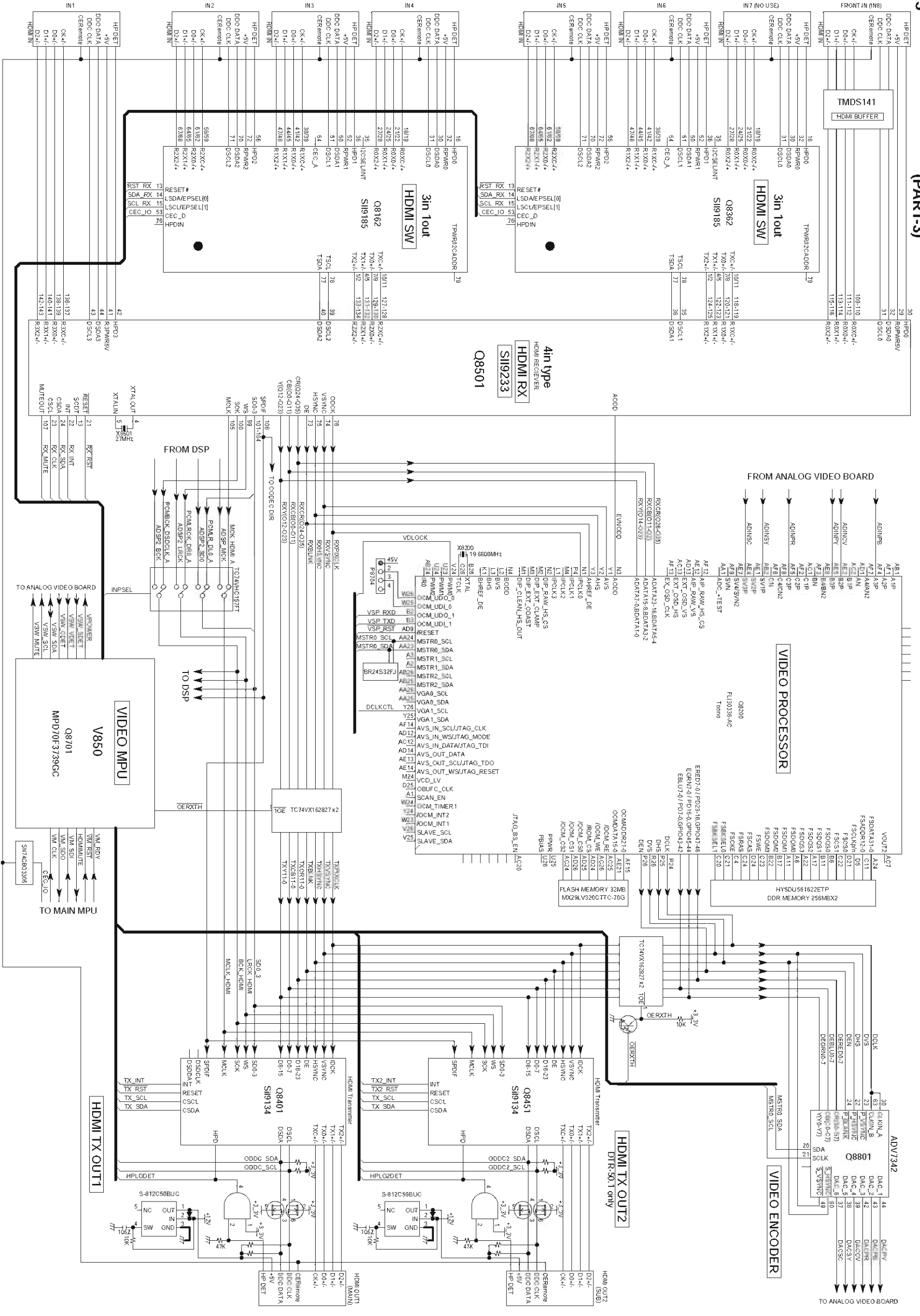

BLOCK DIAGRAM-4
DSP/ ETHER/ USB SECTION

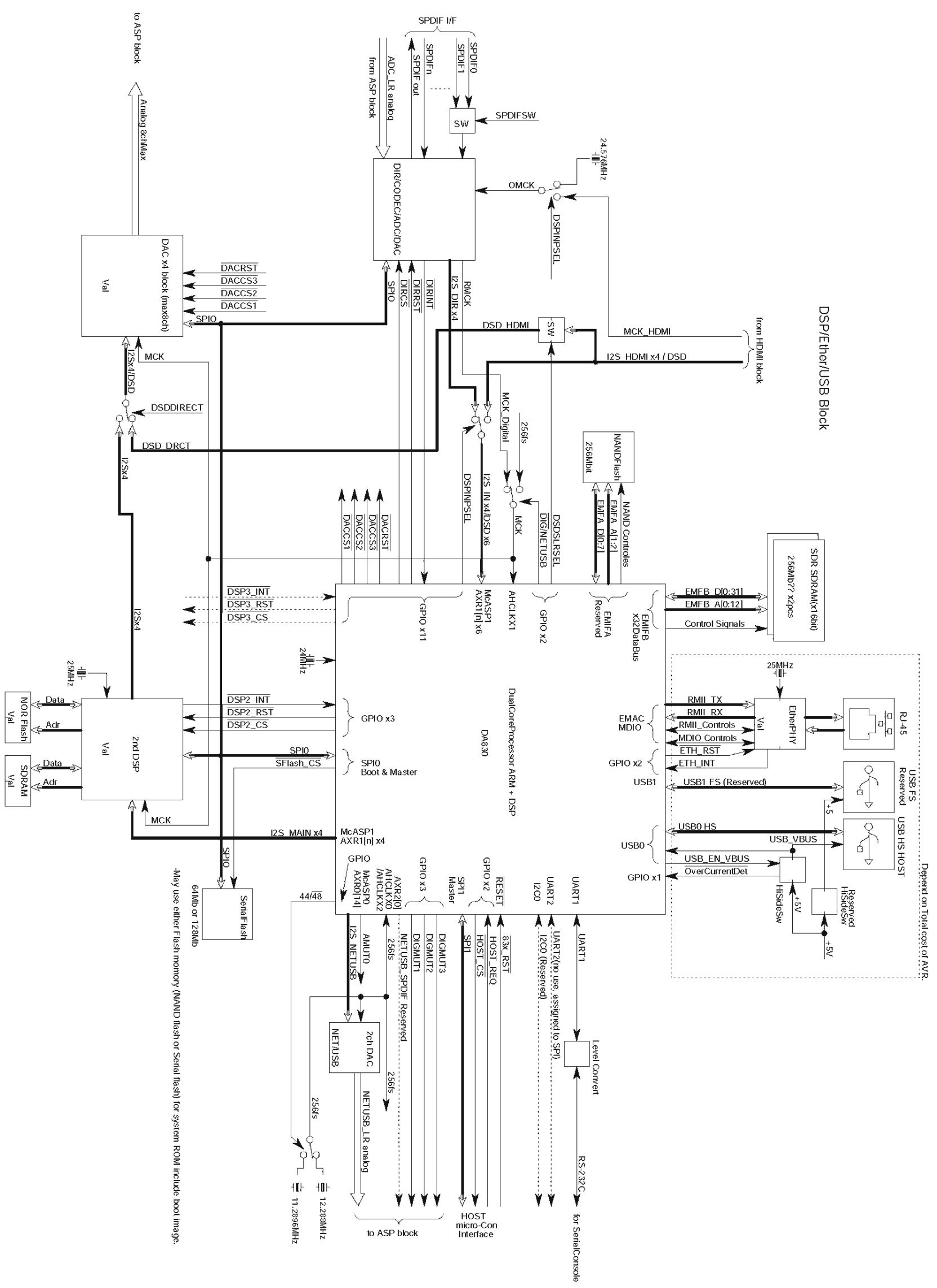

Depend on Total cost of AVR.
-May use either Flash memory (NAND flash or Serial flash) for system ROM include boot image.

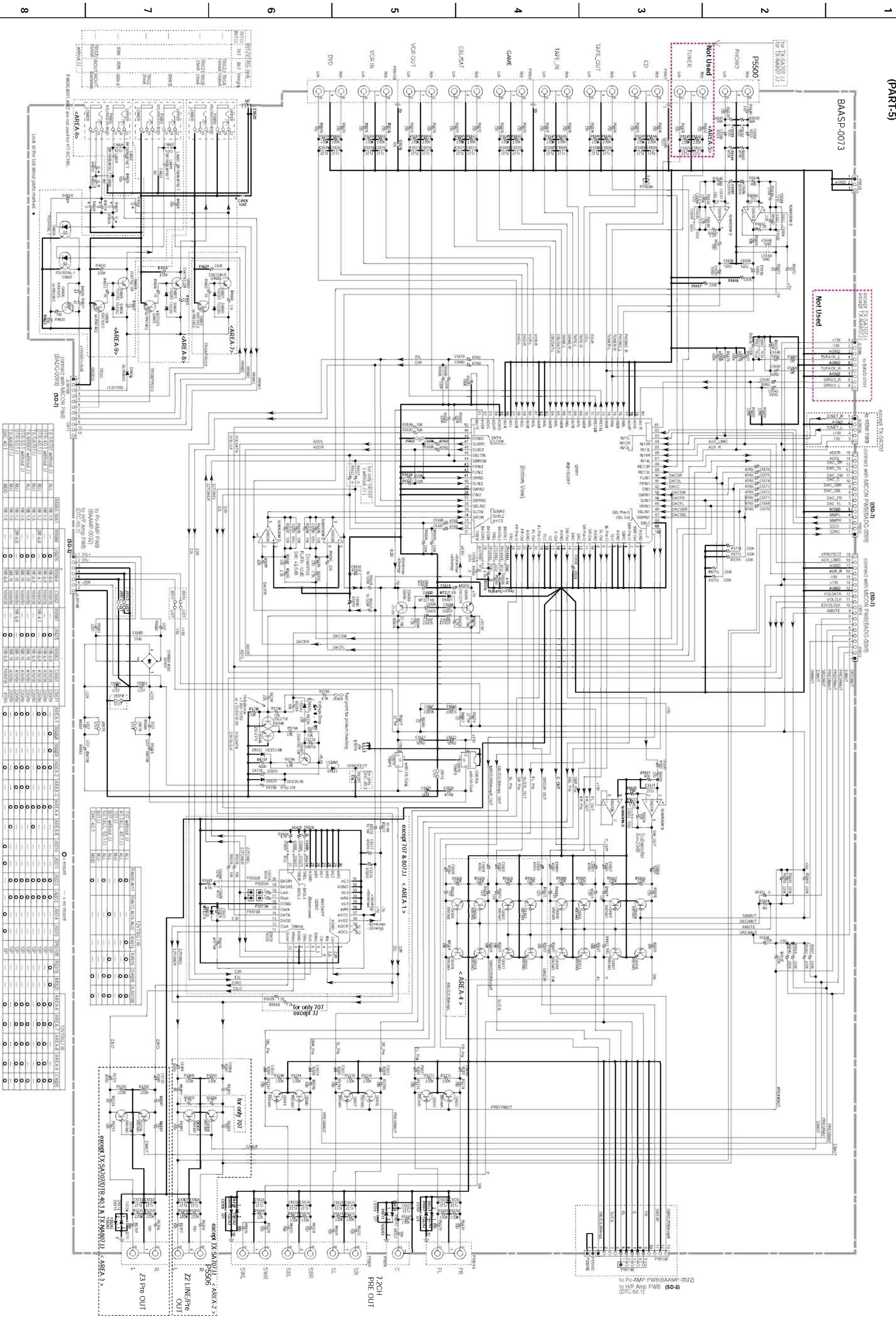

SCHEMATIC DIAGRAM-2

U0024

POWER AMP. INPUT CIRCUIT
(INPUT STAGE) PC BOARD
BACLA-0087-1G
(PART-6)

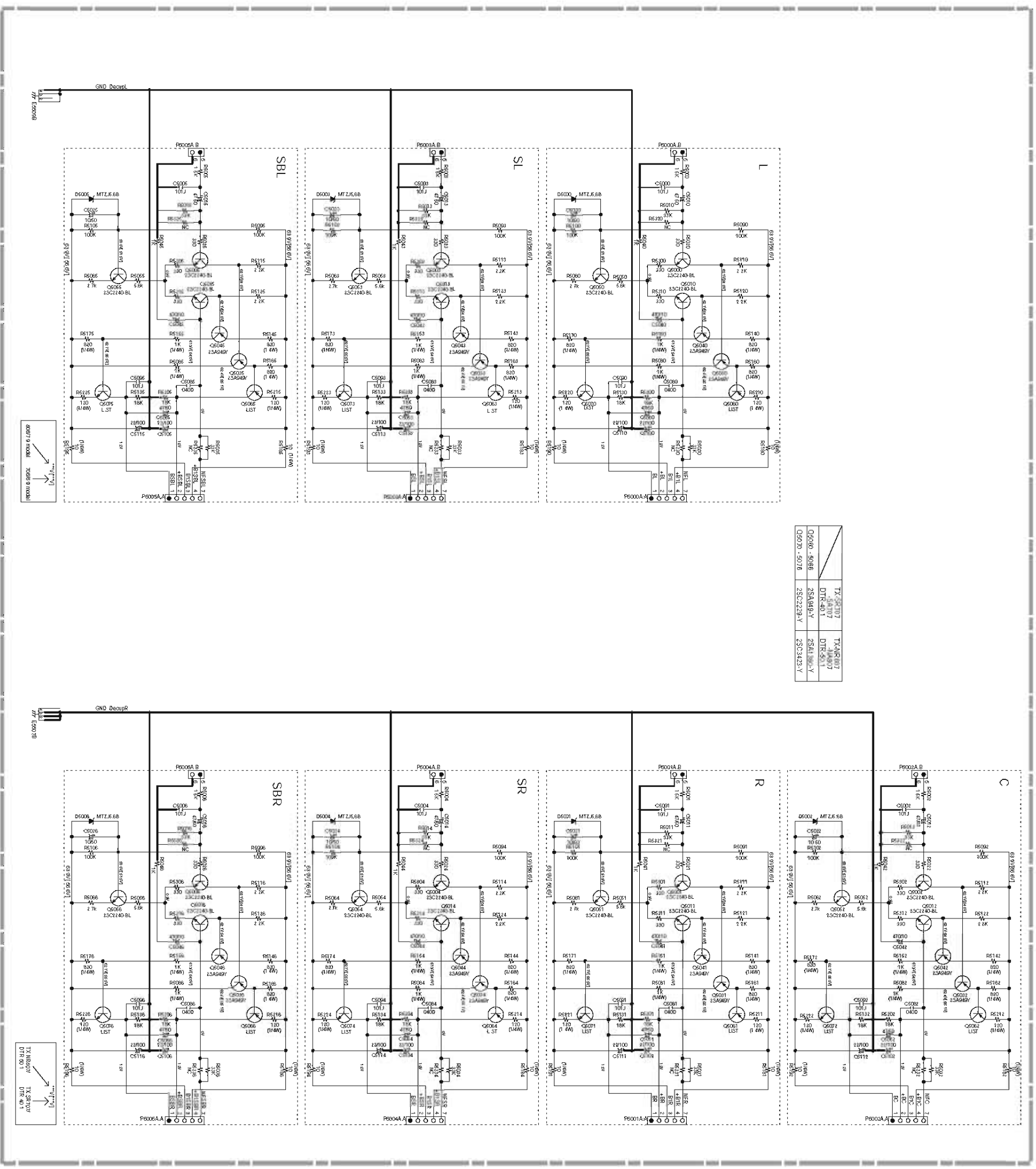

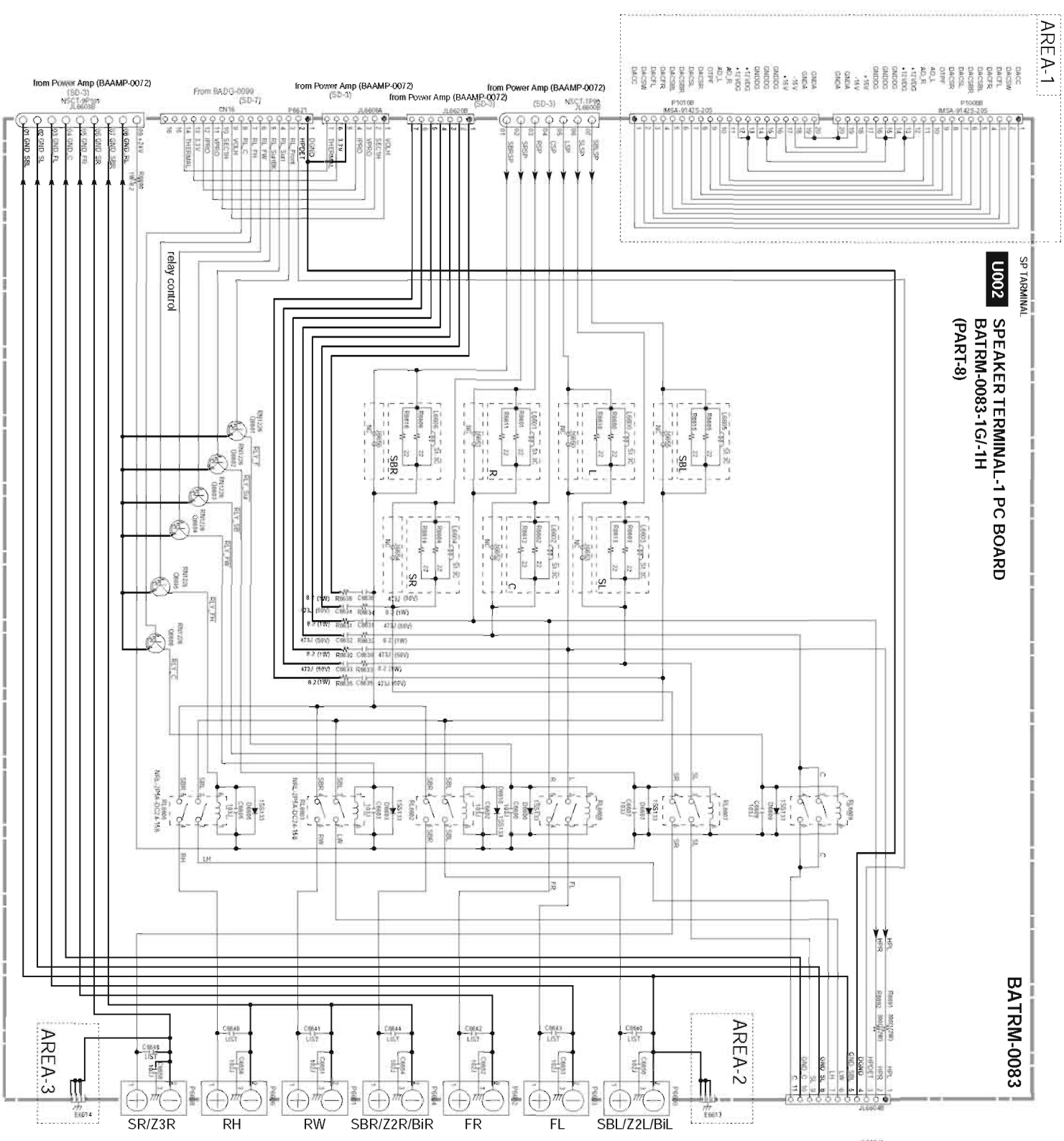

U002 SPEAKER TERMINAL-1 PC BOARD
BATRM-0083-1G-1H
(PART-8)

U0022 SPEAKER TERMINAL-2 PC BOARD
BATRM-0085-1G-1H

U0021 PRIMARY POWER SUPPLY
PC BOARD BAPS-0084-1G-1H

U0023 CENTER SPEAKER TERMINAL
PC BOARD BATRM-0086-1G-1H

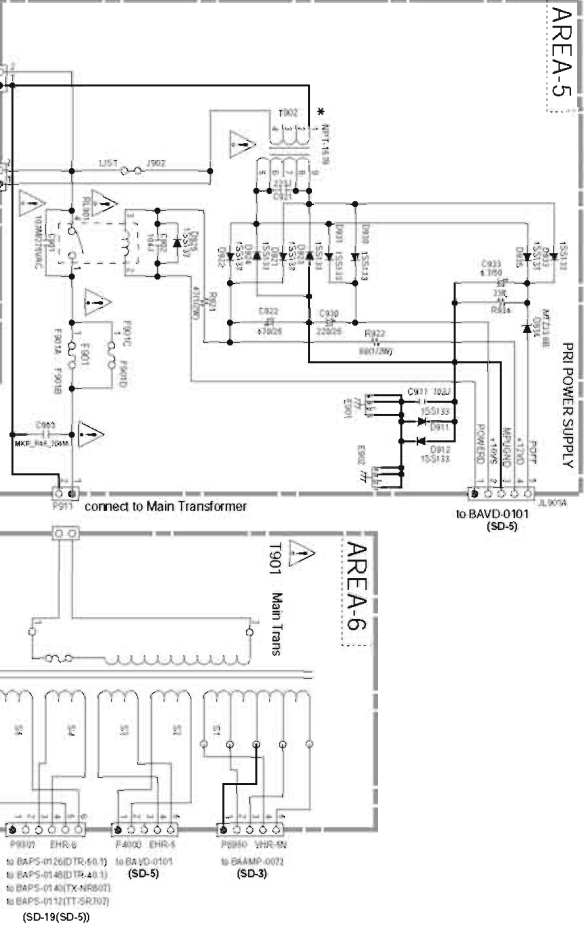

< CAUTION >

DHC-40.1 use only AREA-1, 2, 3, 4, 5 & 6.

- NOTE**
- THE COMPONENTS IDENTIFIED BY MARK **▲** ARE CRITICAL FOR SAFETY. REPLACE ONLY WITH PART NUMBER SPECIFIED.
 - VOLTAGE (MEASURED WITH VOLTMETER)
 - ELECTROLYTIC CAPACITORS (-E*) ARE IN P.P.W.V.
 - ALL CAPACITORS ARE IN P.P.F.W.V. UNLESS OTHERWISE NOTED.
 - EX) 030 ← 3pF → 33pF → 331 ← 330pF → 333 ← 0.033μF
 - ALL RESISTORS ARE IN OHMS UNLESS OTHERWISE NOTED.
 - THE THICK LINES ON PC BOARD ARE THE PRINTING SIDE OF THE PARTS.
 - EX) PRINTING SIDE
 - CIRCUIT IS SUBJECT TO CHANGE FOR IMPROVEMENT.

CR819 -- 8648	TYPE	T1	A1	T3	R5
D	MC	MC	MC	MC	MC
M	4771				4771

CODE	MODEL
D	TX-SR-107 D1B-401
A1	TX-S4203
T3	TX-AM807 D1B-401
R5	TX-AM807

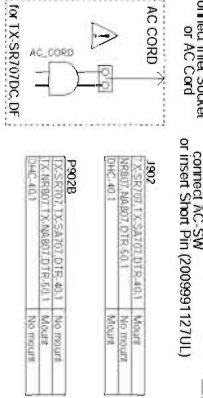

TYPE	T1	A1	T3	R5
D	10A-TXV	10A-TXV	10A-TXV	10A-TXV
J	153020	153020	153020	153020
M	153020			153020

CAUTION

FOR CONTINUED PROTECTION, ALWAYS FUSE HAZARD. REPLACE FUSES CONTING PROTECTION AGAINST FIRE TYPE. ALWAYS USE THE SAME TYPE AND RATING INDICATED.

ATTENTION

CAUTION: PREPARE PROTECTIVE MEASURES TO PREVENT ELECTRICAL SHOCK. DISCONNECT FROM AC MAINS IMMEDIATELY. CHECK FOR RESIDUAL VOLTAGE. PRINTING SIDE OF BOARD IS INDICATED BY THICK LINES ON BOARD. EST AVIS.

U0032 ANALOG VIDEO CIRCUIT PC BOARD BAVD-0101-1G/-1H
(PART-9)

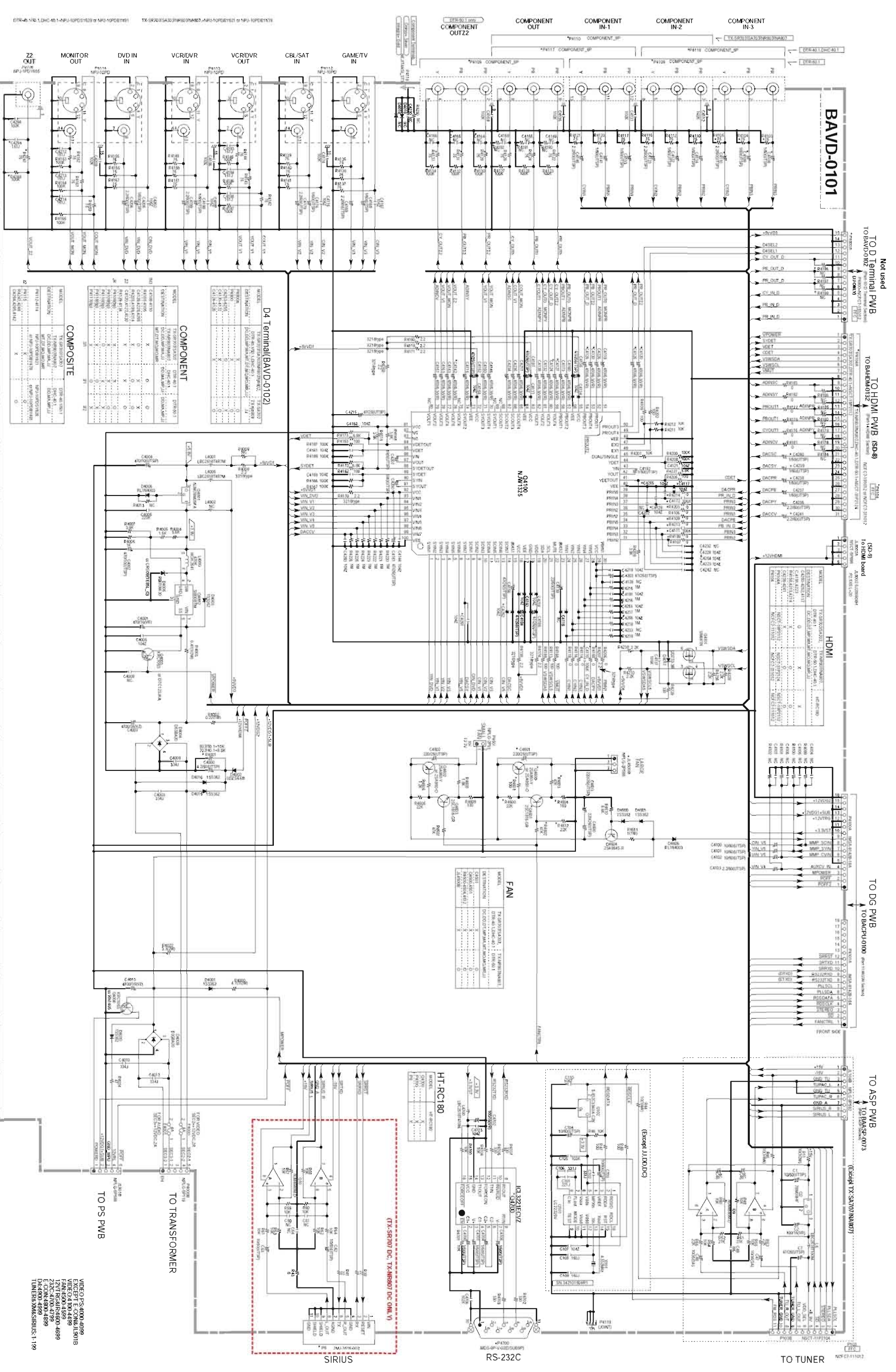

D4 Terminal (BAVD-0102)

MODEL	TX-NR807	TX-NR807-1H	TX-NR807-1G
1	0	0	0
2	0	0	0
3	0	0	0
4	0	0	0
5	0	0	0
6	0	0	0
7	0	0	0
8	0	0	0
9	0	0	0
10	0	0	0
11	0	0	0
12	0	0	0
13	0	0	0
14	0	0	0
15	0	0	0
16	0	0	0
17	0	0	0
18	0	0	0
19	0	0	0
20	0	0	0
21	0	0	0
22	0	0	0
23	0	0	0
24	0	0	0
25	0	0	0
26	0	0	0
27	0	0	0
28	0	0	0
29	0	0	0
30	0	0	0
31	0	0	0
32	0	0	0
33	0	0	0
34	0	0	0
35	0	0	0
36	0	0	0
37	0	0	0
38	0	0	0
39	0	0	0
40	0	0	0
41	0	0	0
42	0	0	0
43	0	0	0
44	0	0	0
45	0	0	0
46	0	0	0
47	0	0	0
48	0	0	0
49	0	0	0
50	0	0	0

COMPONENT

MODEL	TX-NR807	TX-NR807-1H	TX-NR807-1G
1	0	0	0
2	0	0	0
3	0	0	0
4	0	0	0
5	0	0	0
6	0	0	0
7	0	0	0
8	0	0	0
9	0	0	0
10	0	0	0
11	0	0	0
12	0	0	0
13	0	0	0
14	0	0	0
15	0	0	0
16	0	0	0
17	0	0	0
18	0	0	0
19	0	0	0
20	0	0	0
21	0	0	0
22	0	0	0
23	0	0	0
24	0	0	0
25	0	0	0
26	0	0	0
27	0	0	0
28	0	0	0
29	0	0	0
30	0	0	0
31	0	0	0
32	0	0	0
33	0	0	0
34	0	0	0
35	0	0	0
36	0	0	0
37	0	0	0
38	0	0	0
39	0	0	0
40	0	0	0
41	0	0	0
42	0	0	0
43	0	0	0
44	0	0	0
45	0	0	0
46	0	0	0
47	0	0	0
48	0	0	0
49	0	0	0
50	0	0	0

COMPOSITE

MODEL	TX-NR807	TX-NR807-1H	TX-NR807-1G
1	0	0	0
2	0	0	0
3	0	0	0
4	0	0	0
5	0	0	0
6	0	0	0
7	0	0	0
8	0	0	0
9	0	0	0
10	0	0	0
11	0	0	0
12	0	0	0
13	0	0	0
14	0	0	0
15	0	0	0
16	0	0	0
17	0	0	0
18	0	0	0
19	0	0	0
20	0	0	0
21	0	0	0
22	0	0	0
23	0	0	0
24	0	0	0
25	0	0	0
26	0	0	0
27	0	0	0
28	0	0	0
29	0	0	0
30	0	0	0
31	0	0	0
32	0	0	0
33	0	0	0
34	0	0	0
35	0	0	0
36	0	0	0
37	0	0	0
38	0	0	0
39	0	0	0
40	0	0	0
41	0	0	0
42	0	0	0
43	0	0	0
44	0	0	0
45	0	0	0
46	0	0	0
47	0	0	0
48	0	0	0
49	0	0	0
50	0	0	0

VIDEO PS-400-4898
VIDEO-COM-4891B
FAN-4200-4899
VIDEO-4-500-4899
232C-VIO-4199
E-COM-4890-4899
TRANS-4898
TRANS-SM-SIGNALS-1199

U0031 CPU CIRCUIT PC BOARD BACPu-0100-1G/1H (PART-11)

BACPu-0100

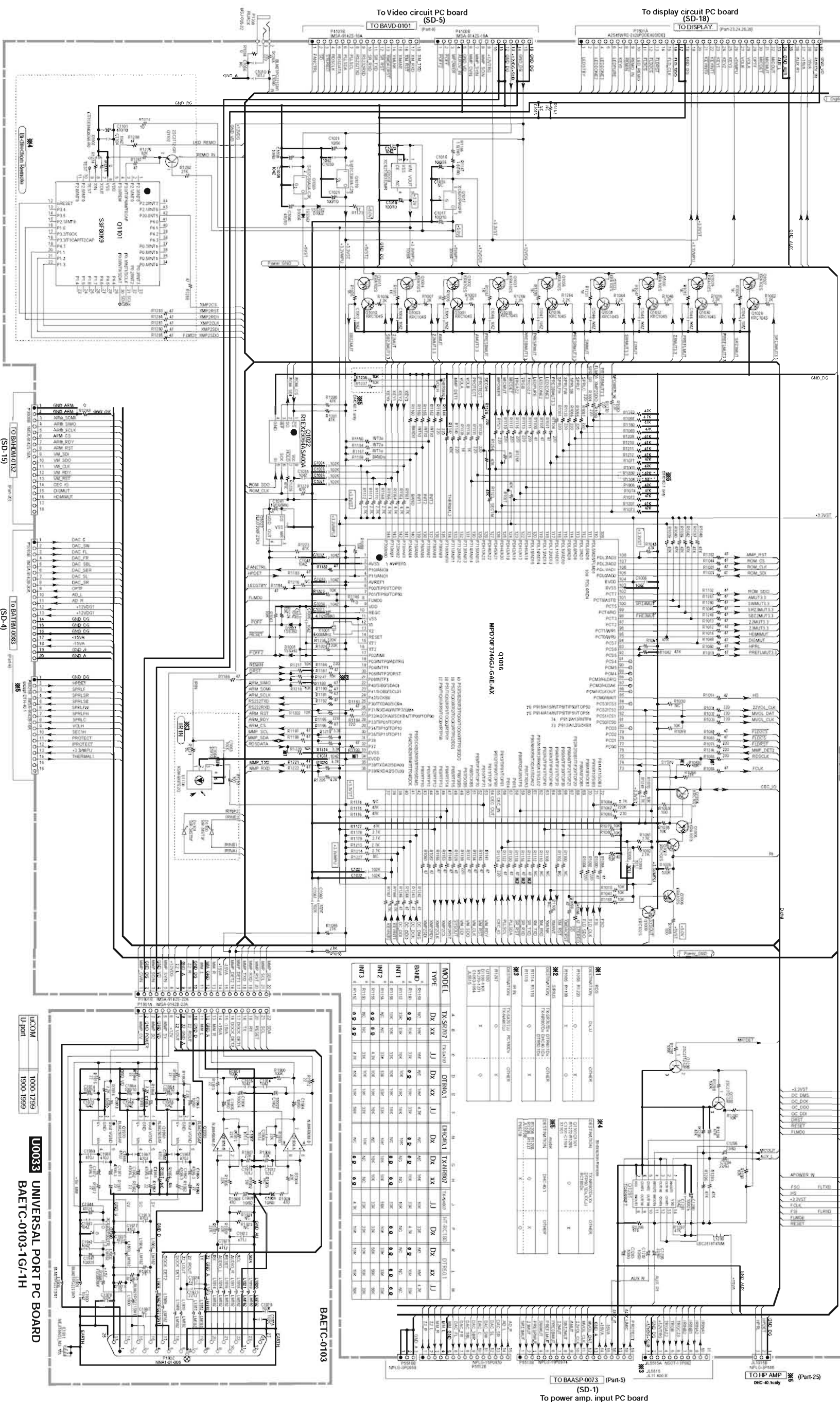

U005 HDMI CIRCUIT PC BOARD-1
 BAHDM-0132-1B
 HDMI IN/ HDMI RX/ HDMI TX SECTION
 (PART-13)

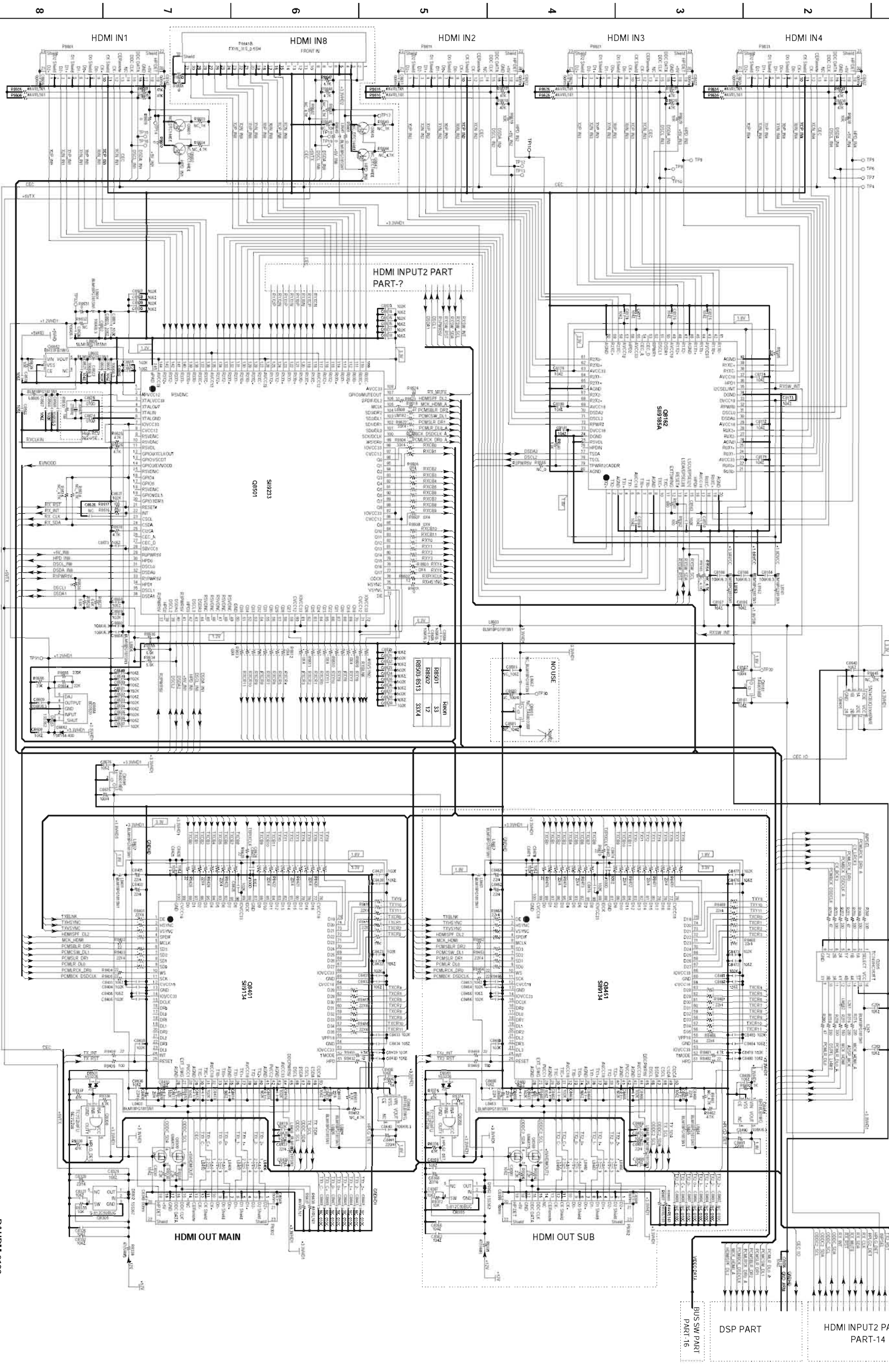

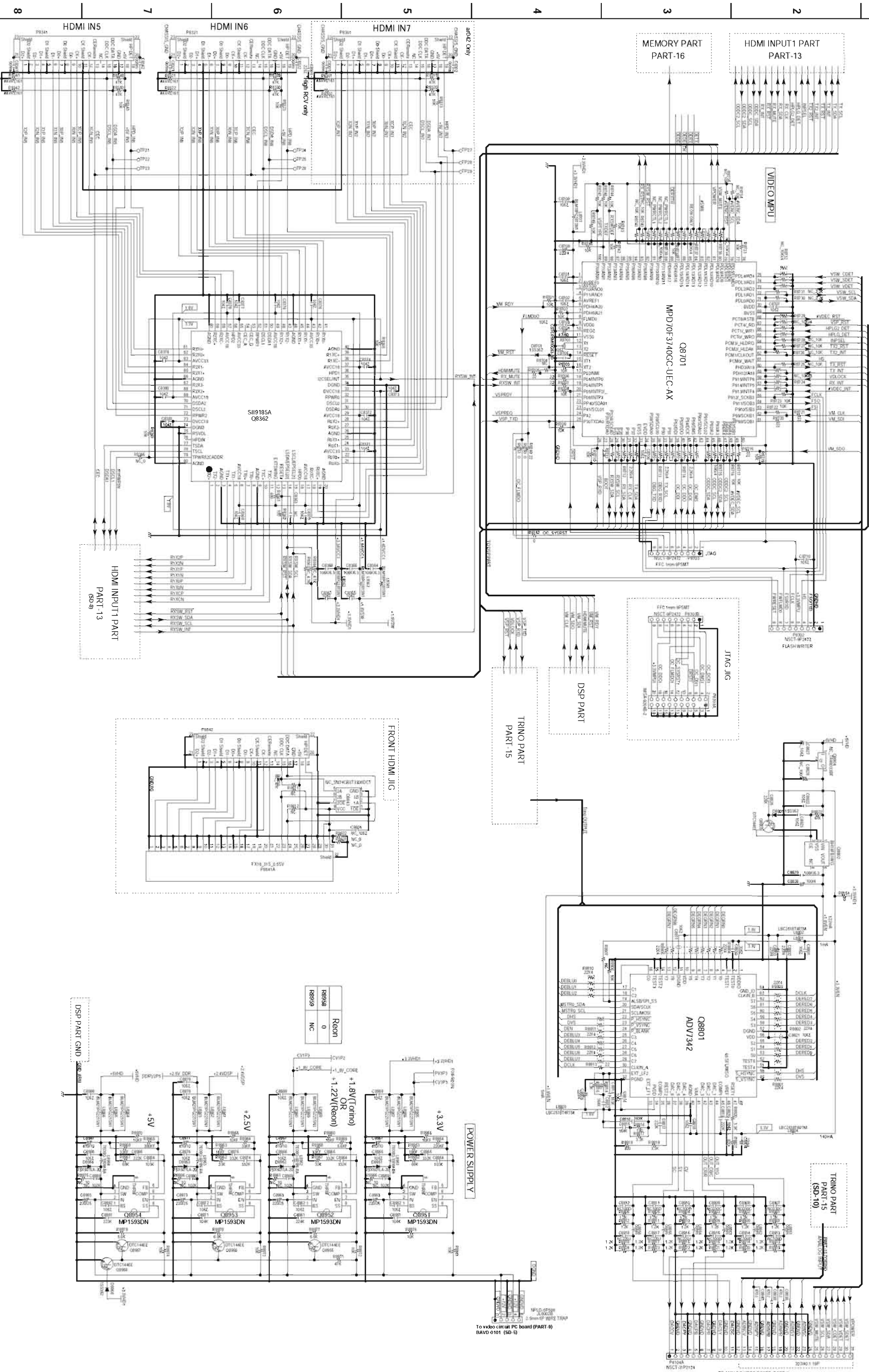

SCHEMATIC DIAGRAM-10

U005 HDMI CIRCUIT PC BOARD-3
BAHDM-0132-1B
(PART-15) TRINO SECTION

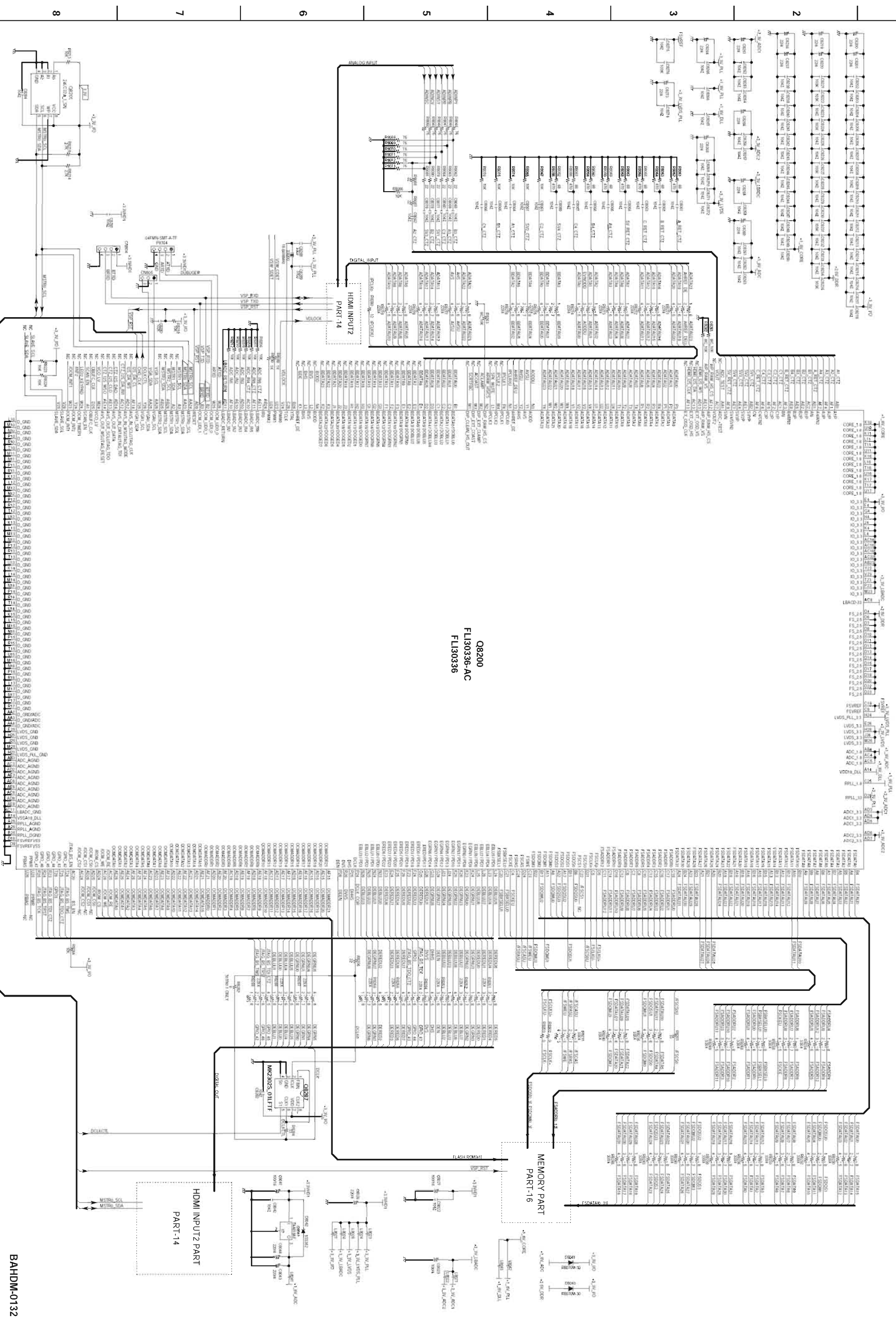

SCHEMATIC DIAGRAM-11

U005 HDMI CIRCUIT PC BOARD-4

BAHDM-0132-1B

(PART-16) TRINO BOARD MEMORY SECTION

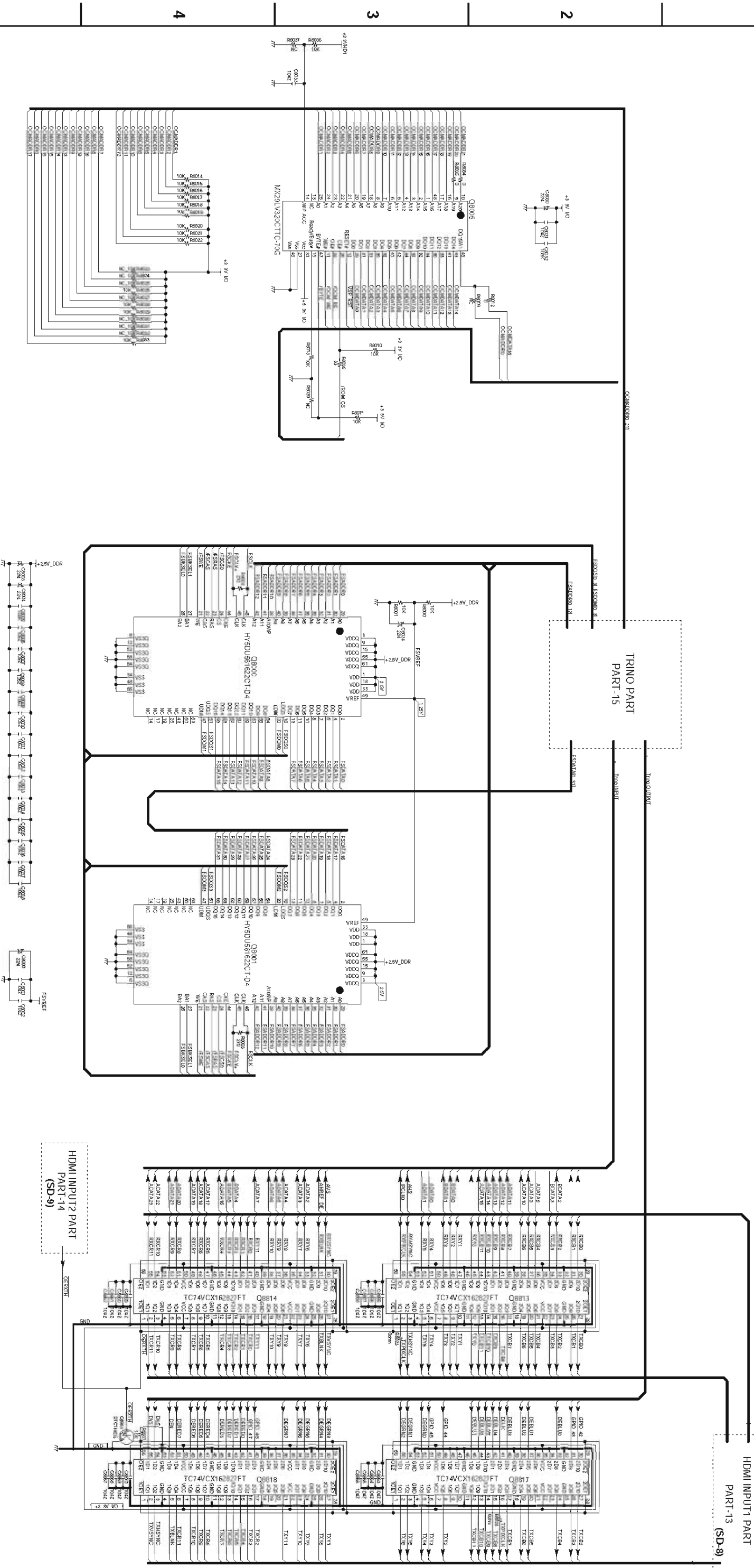

SCHEMATIC DIAGRAM-12

U005 HDMI CIRCUIT PC BOARD-5 BAHDM-0132-1B (PART-17) NET/ USB SECTION

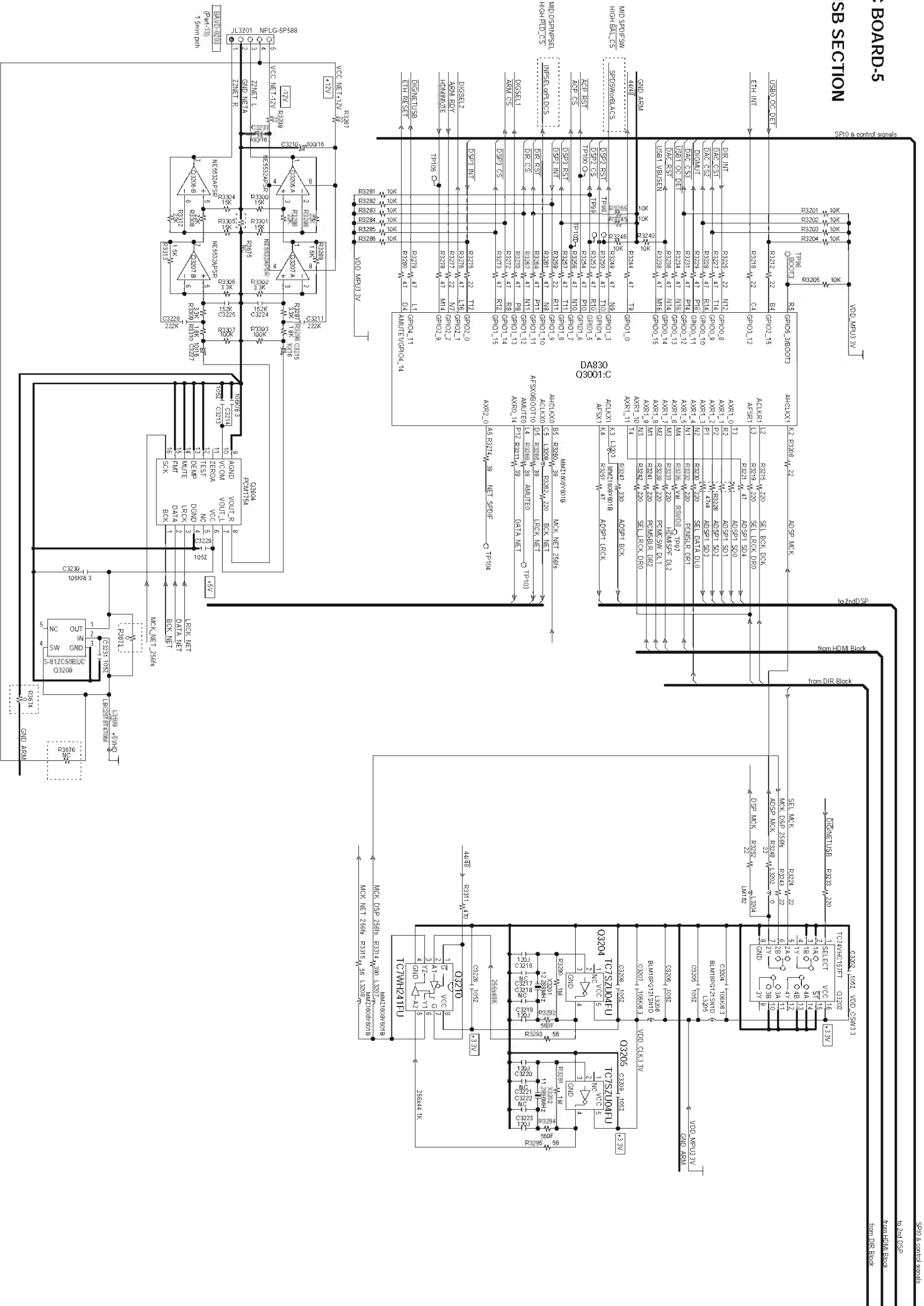

A B C D E F G H

5

4

3

2

1

SCHEMATIC DIAGRAM-13

U005

HDMI CIRCUIT PC BOARD-6

BAHDM-0132-1B

(PART-18)

NET/USB POWER SECTION

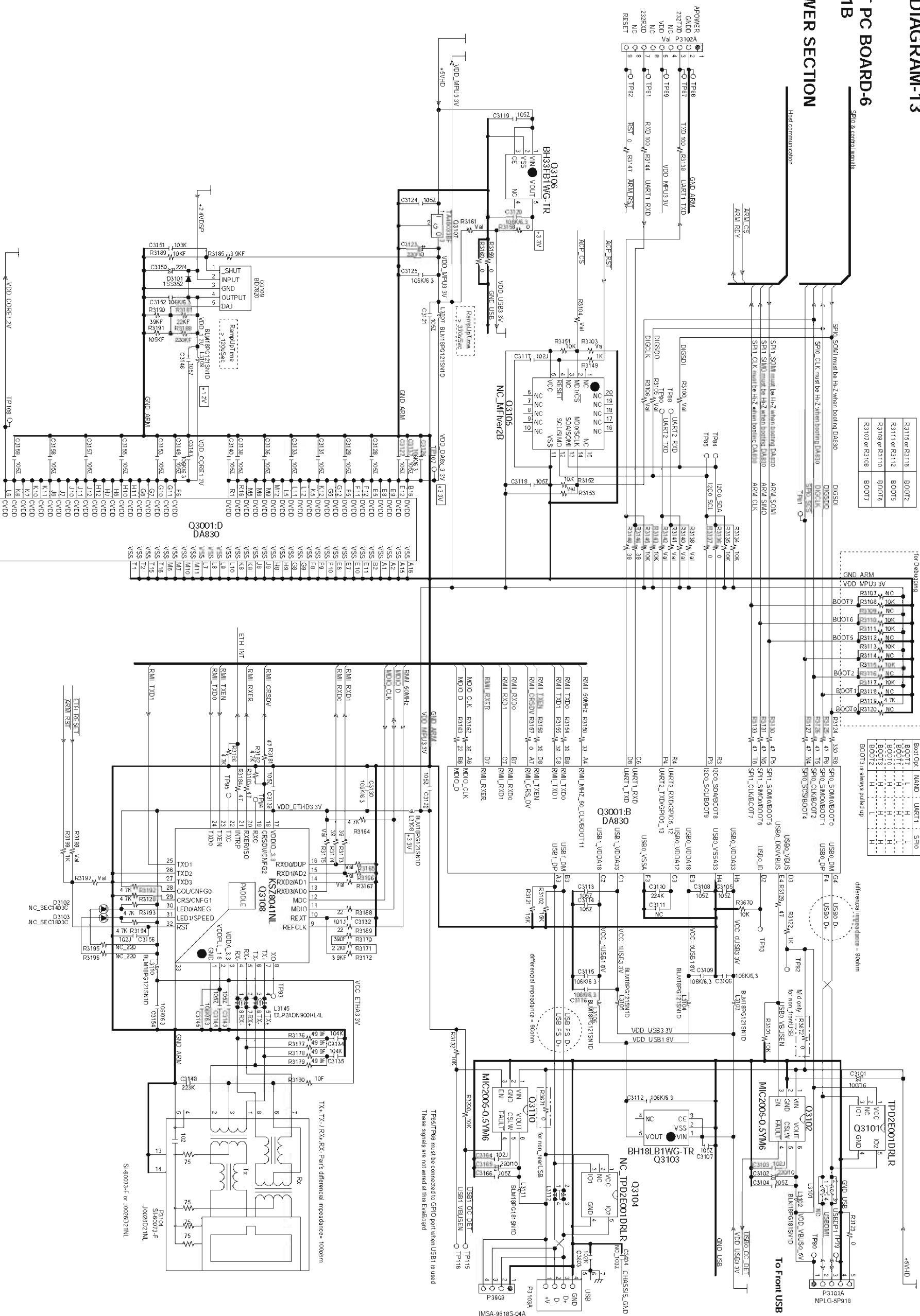

SCHEMATIC DIAGRAM-15

U005 HDMI CIRCUIT PC BOARD-8
 BAHDM-0132-1B
 (PART-20) DSP CONNECT SECTION

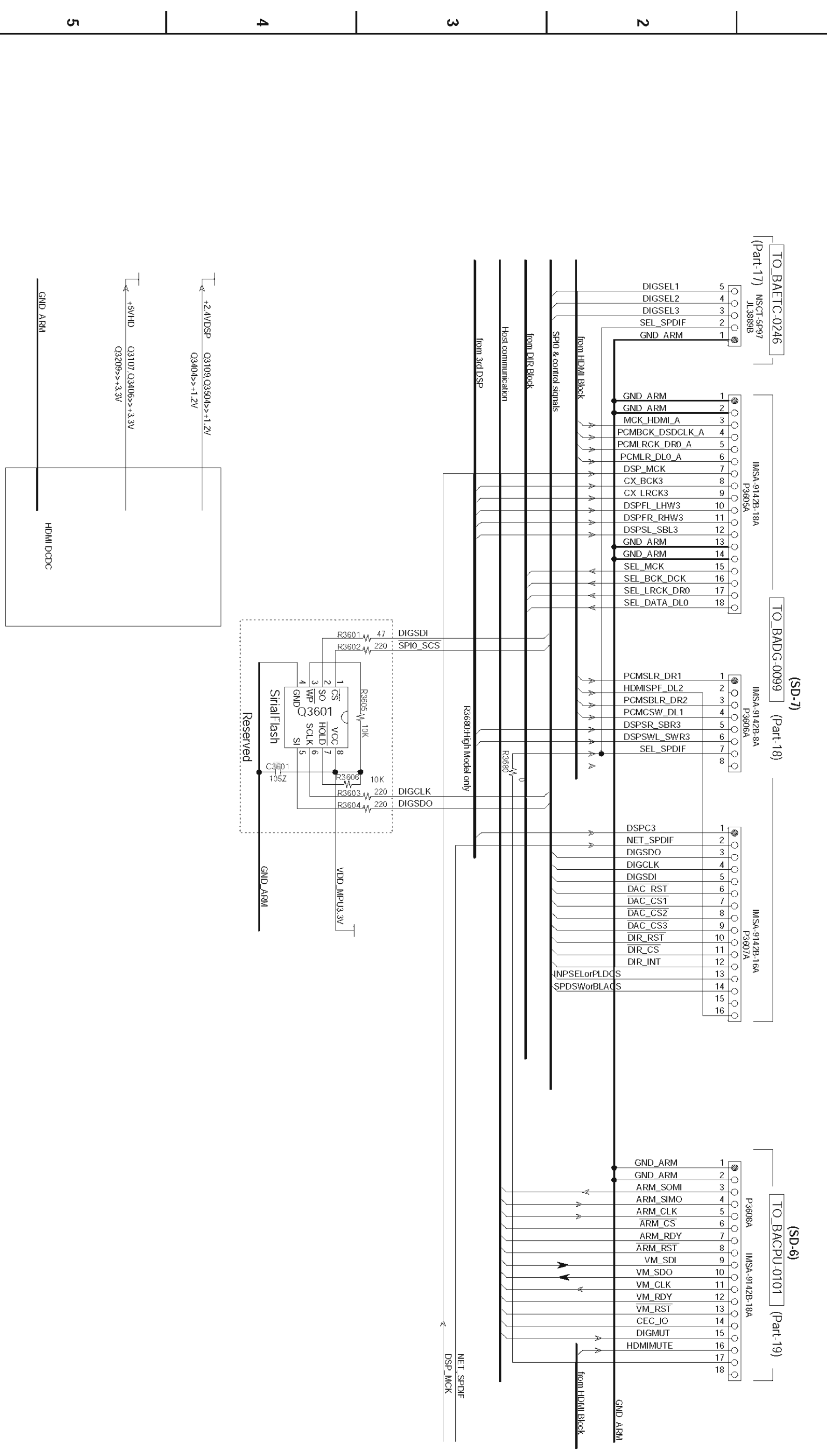

5

4

3

2

1

A | B | C | D | E | F | G | H

SCHEMATIC DIAGRAM-16 U005 HDMI CIRCUIT PC BOARD-9 BAHDM-0132-1B (PART-21) DSP 2ND SECTION

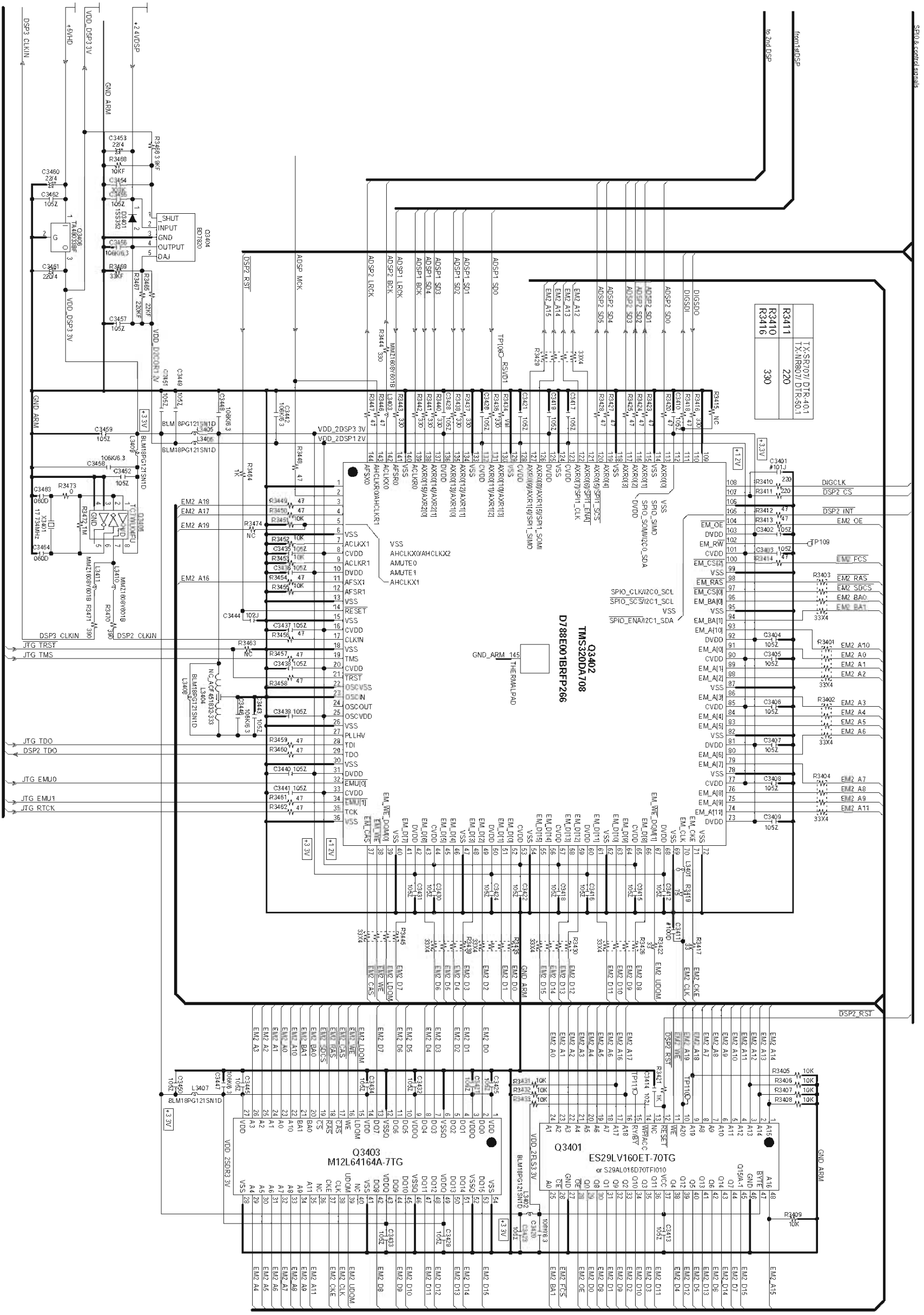

A B C D E F G H

SCHEMATIC DIAGRAM-17

U005 HDMI CIRCUIT PC BOARD-10
BAHDM-0132-1B
(PART-22) DSP 3RD SECTION

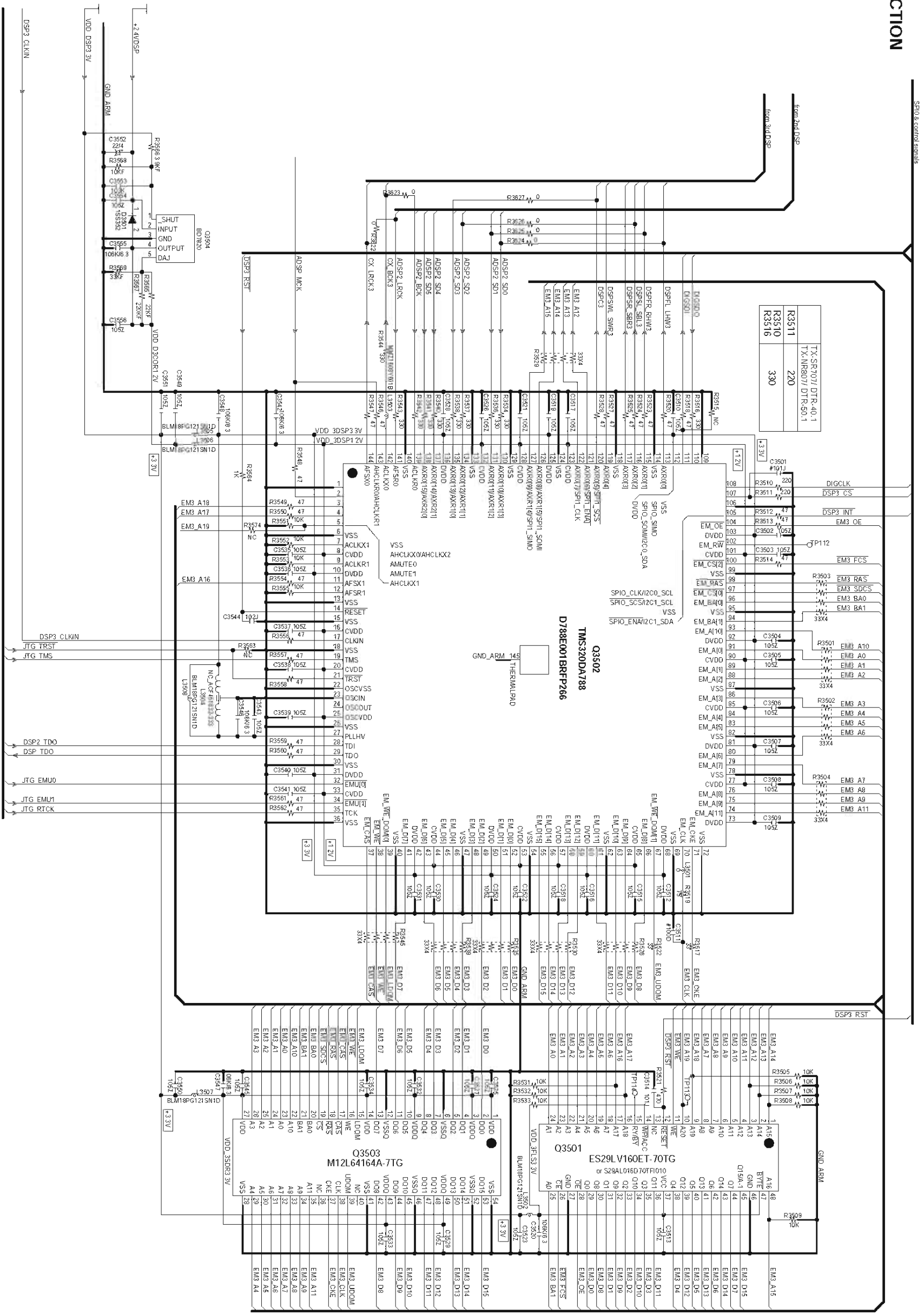

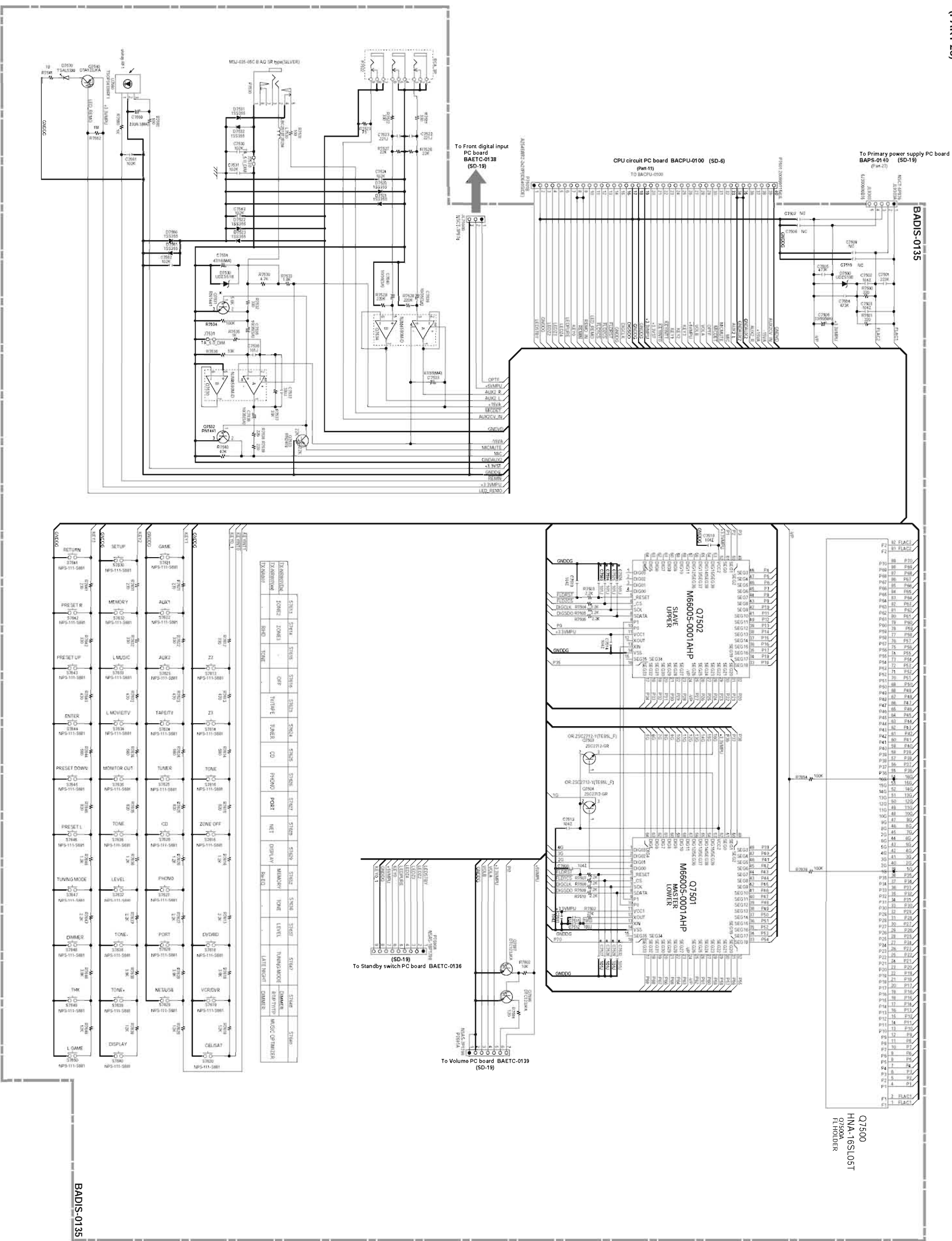

SCHEMATIC DIAGRAM-19
(PART-27)

A

B

C

D

E

F

G

H

U0041 STANDBY SWITCH PC BOARD BASW-0136-1A

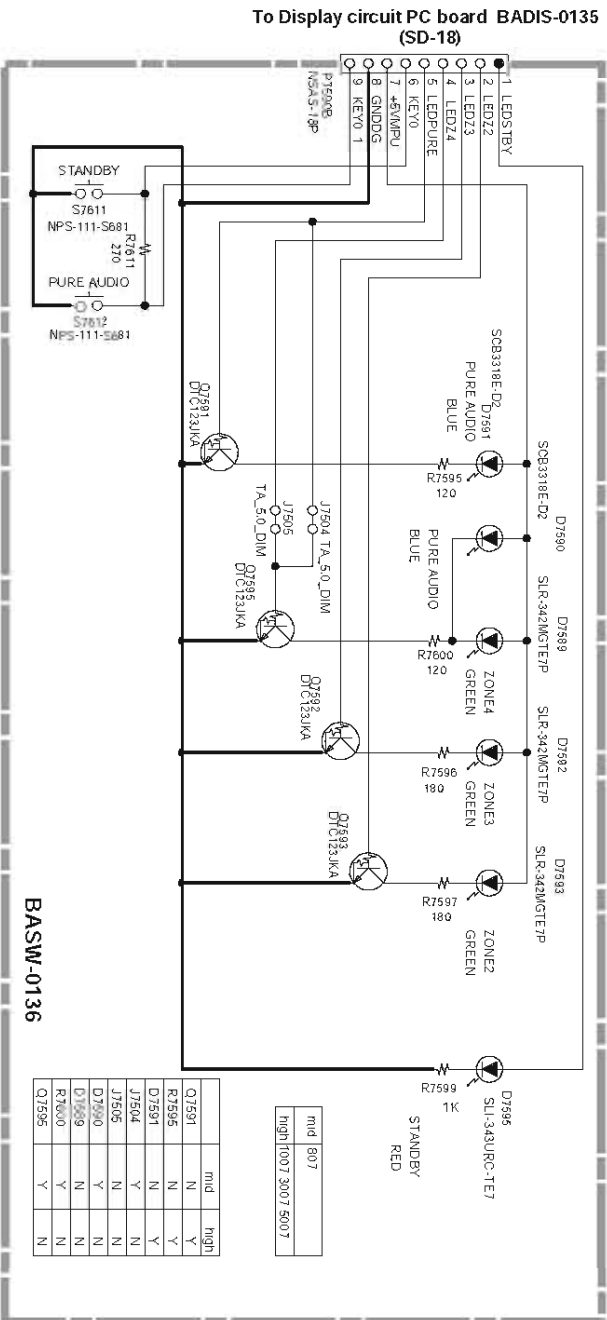

U0043 FRONT DIGITAL INPUT PC BOARD BAETC-0138-1A

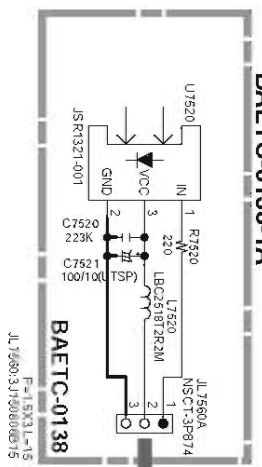

To Display circuit PC board BADIS-0135 (SD-18)

U0042 POWER SWITCH PC BOARD BASW-0143-1A

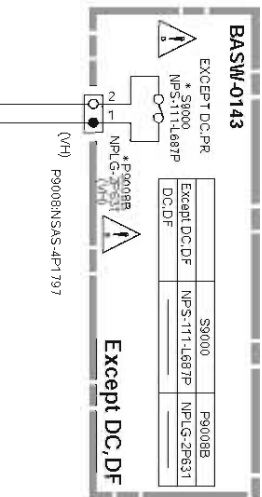

U0044 VOLUME LED PC BOARD BAETC-0139-1A

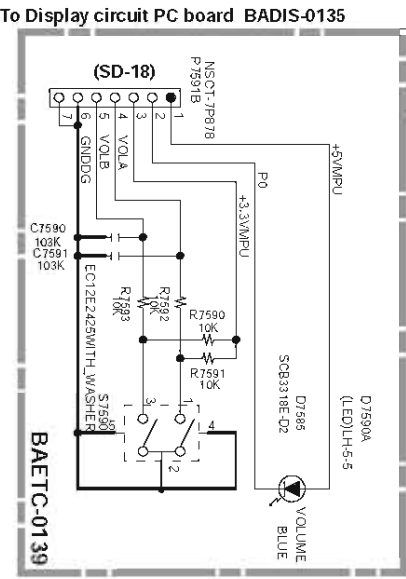

To Display circuit PC board BADIS-0135 (SD-18)

U00412 HEADPHONE TERMINAL PC BOARD BAETC-0137-1A

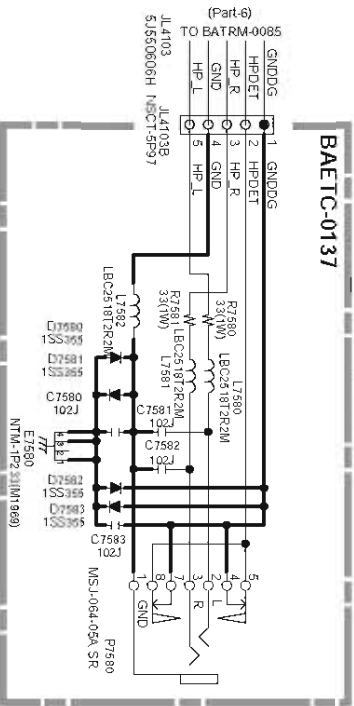

U0045 FUSE PC BOARD BAPS-0140-1A

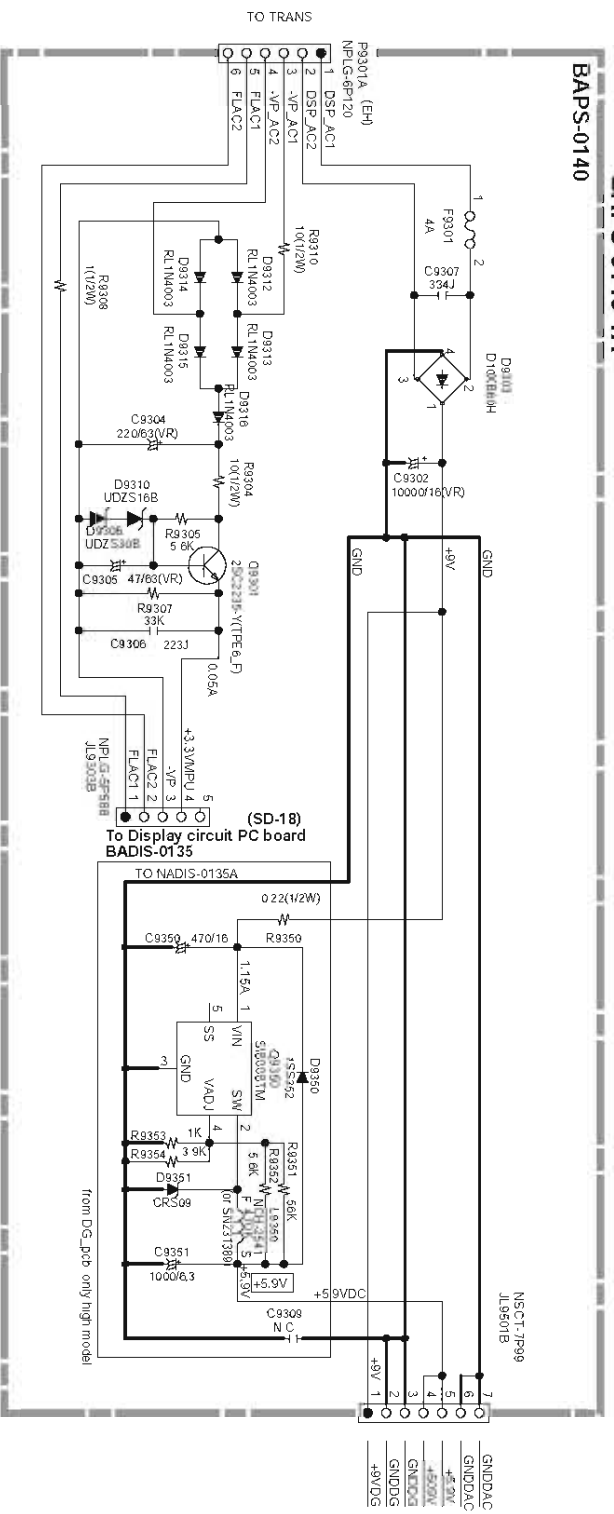

To Display circuit PC board BADIS-0135

To NADIS-0135A

To Display circuit PC board BADIS-0135 (SD-18)

To NADIS-0135A

To Display circuit PC board BADIS-0135 (SD-18)

To NADIS-0135A

To Display circuit PC board BADIS-0135 (SD-18)

To NADIS-0135A

To Display circuit PC board BADIS-0135 (SD-18)

To NADIS-0135A

To Display circuit PC board BADIS-0135 (SD-18)

To NADIS-0135A

To Display circuit PC board BADIS-0135 (SD-18)

To NADIS-0135A

To Display circuit PC board BADIS-0135 (SD-18)

To NADIS-0135A

To Display circuit PC board BADIS-0135 (SD-18)

To NADIS-0135A

To Display circuit PC board BADIS-0135 (SD-18)

To NADIS-0135A

To Display circuit PC board BADIS-0135 (SD-18)

To NADIS-0135A

To Display circuit PC board BADIS-0135 (SD-18)

To NADIS-0135A

5

4

3

2

1

PRINTED CIRCUIT BOARD VIEW-1

U001
AMPLIFIER CIRCUIT
PC BOARD
BAAMP-0072

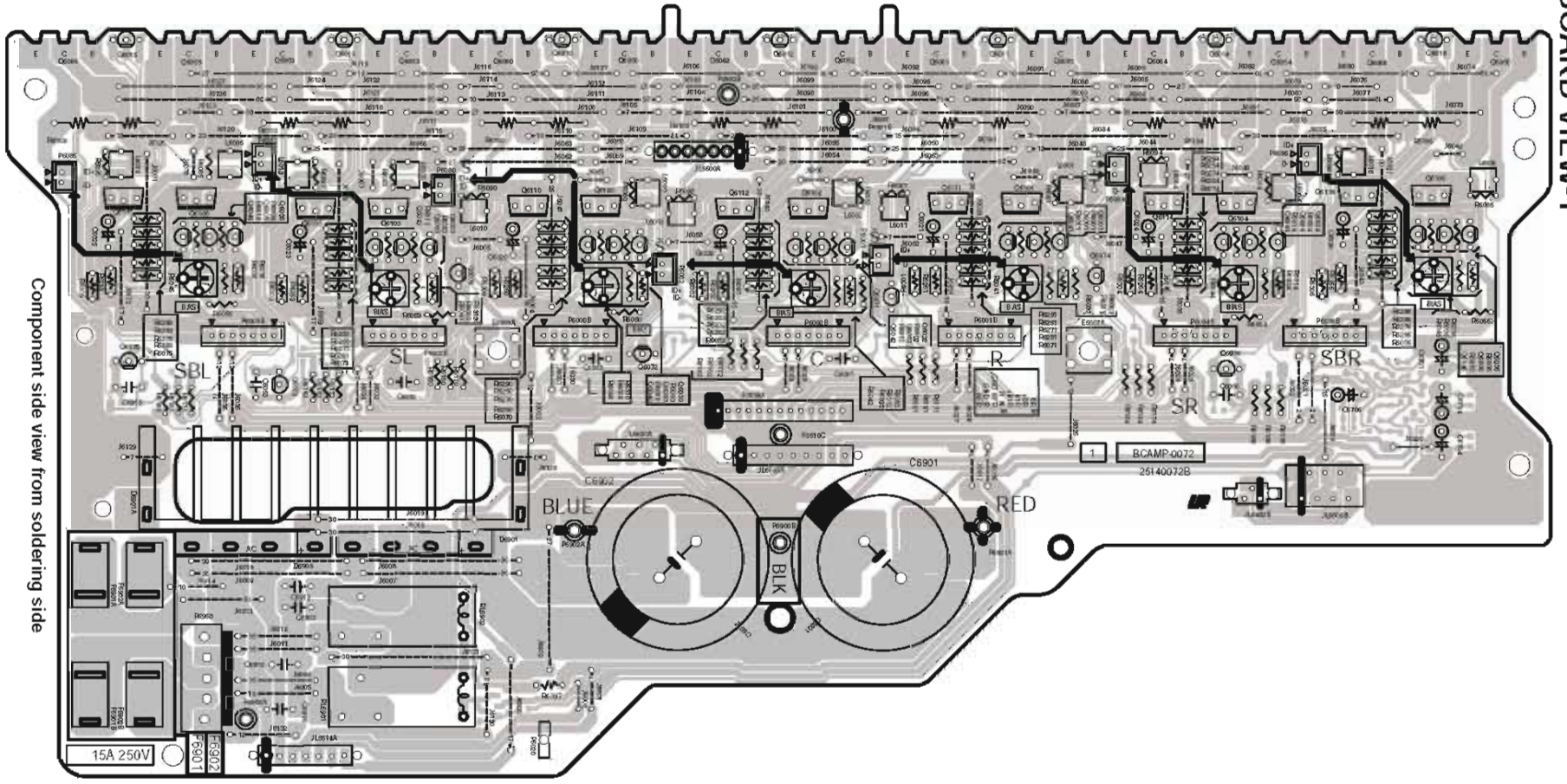

Component side view from soldering side

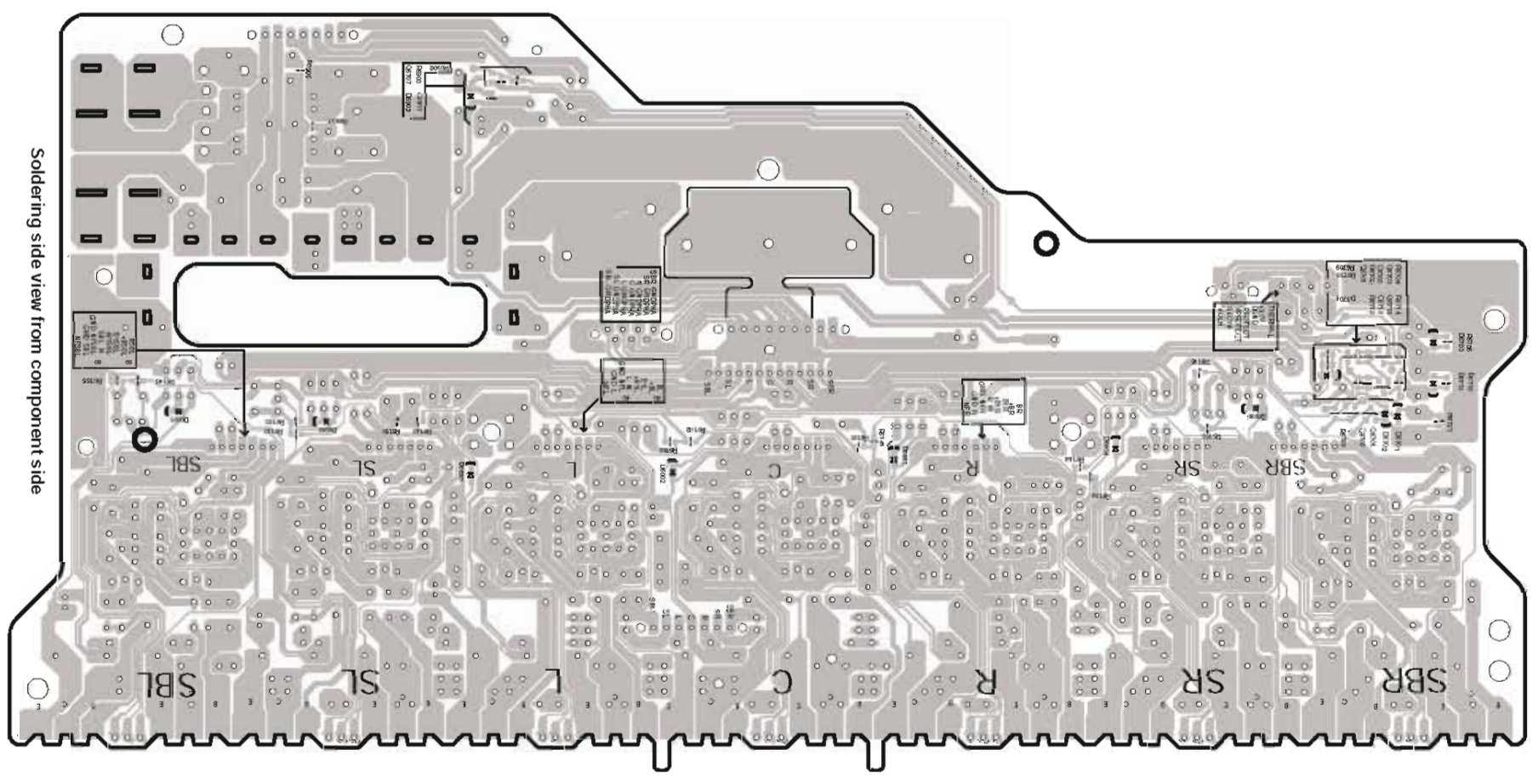

Soldering side view from component side

PRINTED CIRCUIT BOARD VIEW-2

U0011 AUDIO INPUT CIRCUIT PC BOARD
BAASP-0073

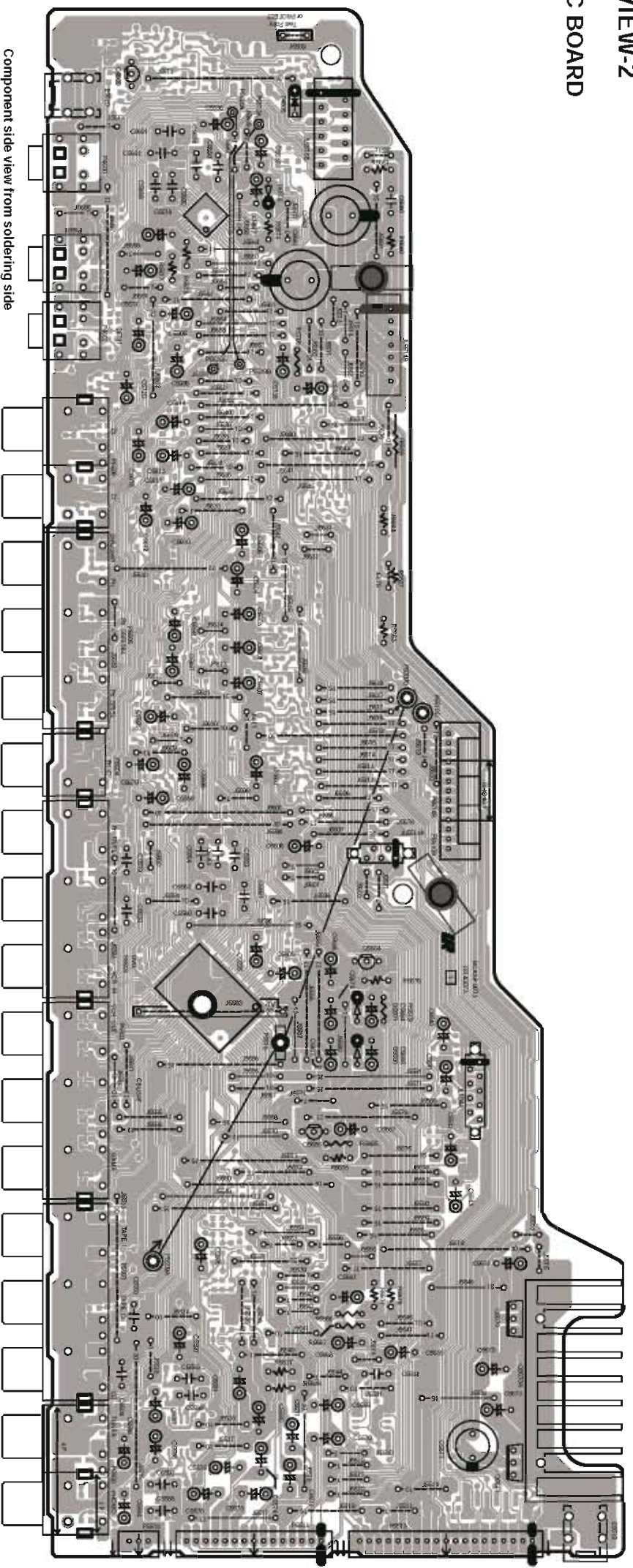

Component side view from soldering side

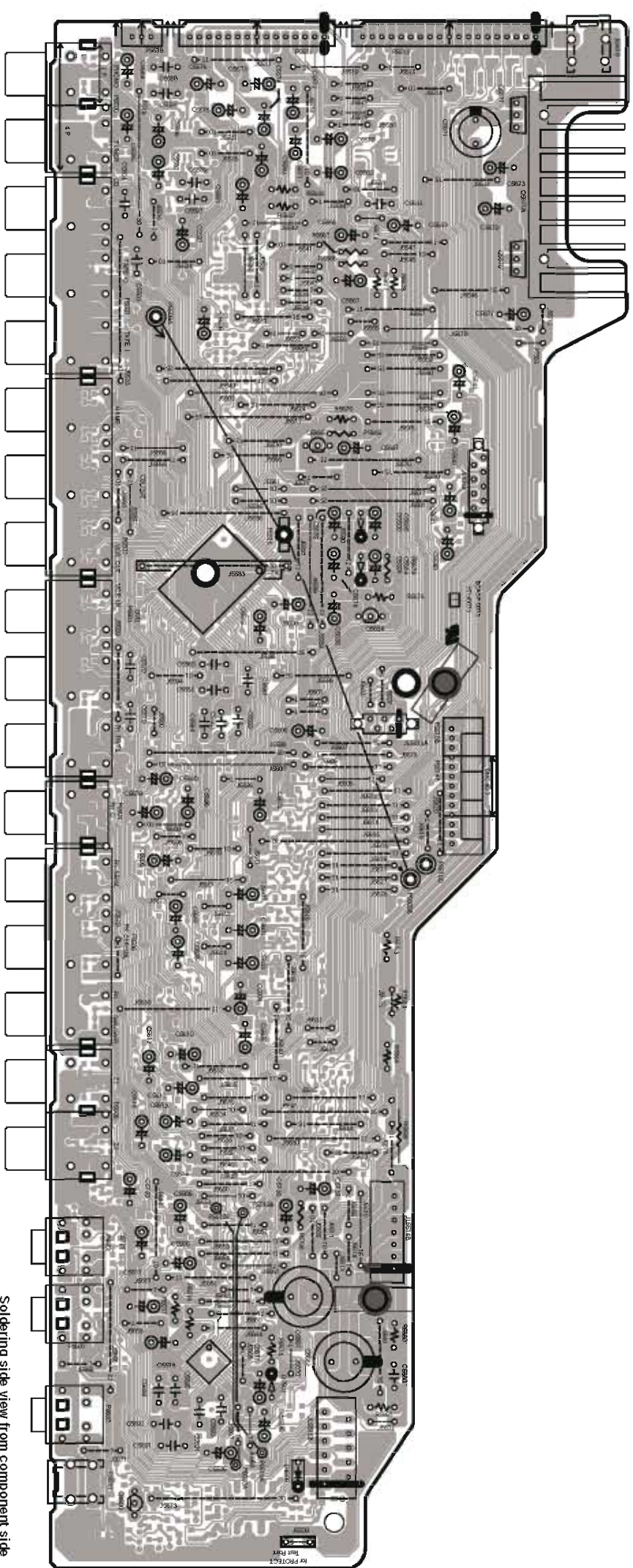

Soldering side view from component side

PRINTED CIRCUIT BOARD VIEW-3

U002 SPEAKER TERMINAL-1 PC BOARD
BATRM-0083

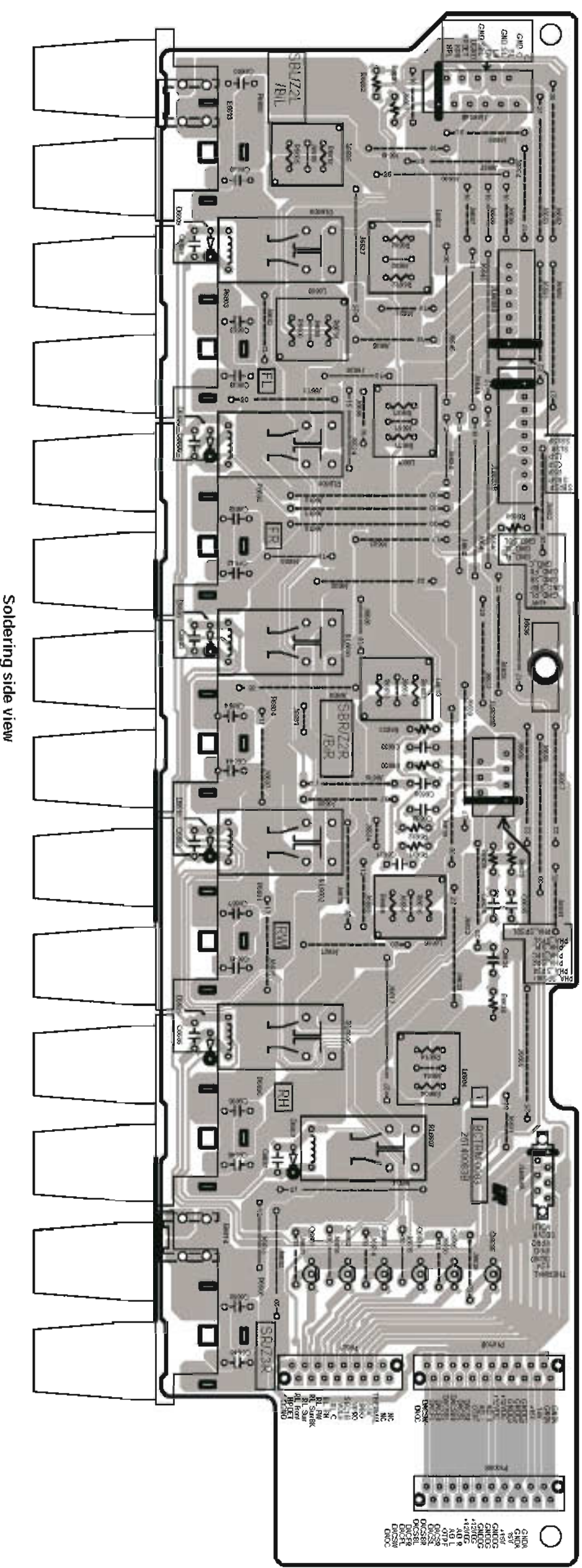

PRINTED CIRCUIT BOARD VIEW-4

U0024 POWER AMP. INPUT CIRCUIT PC BOARD
BACLA-0087

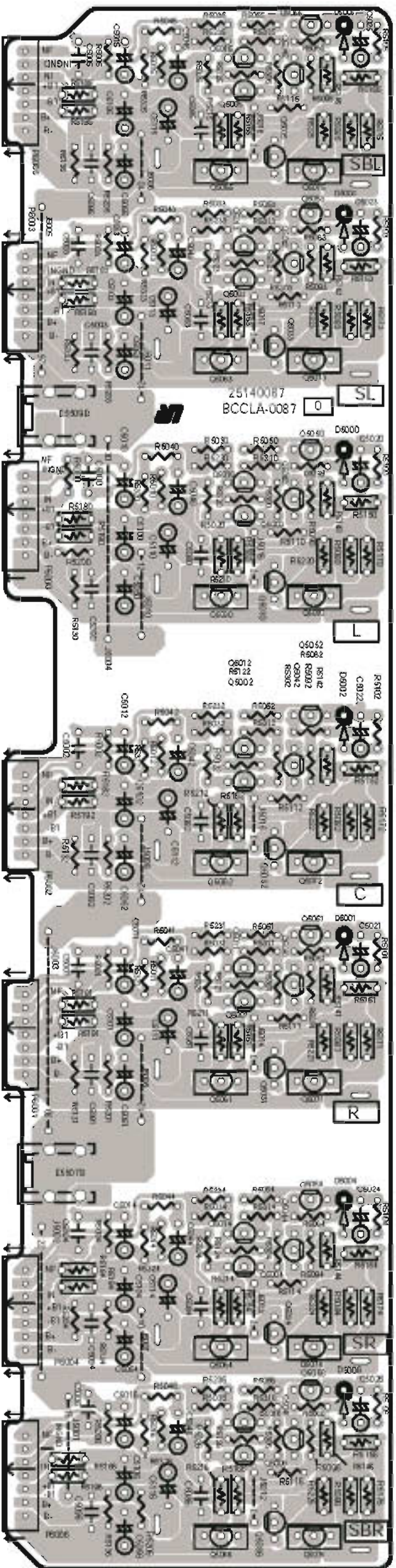

Soldering side view

U0012 THERMISTOR PC BOARD BAETC-0074

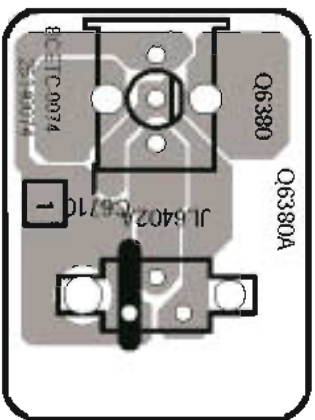

Soldering side view

U0015 AC INLET TERMINAL PC BOARD
BAETC-0089

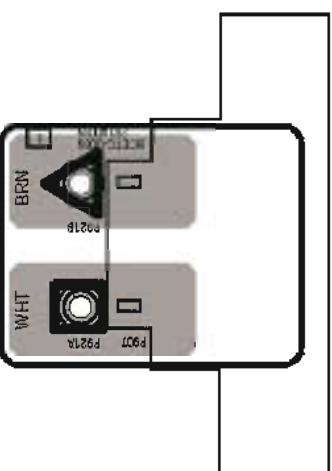

Soldering side view

PRINTED CIRCUIT BOARD VIEW-5

U0021 PRIMARY POWER SUPPLY PC BOARD
BAPS-0084

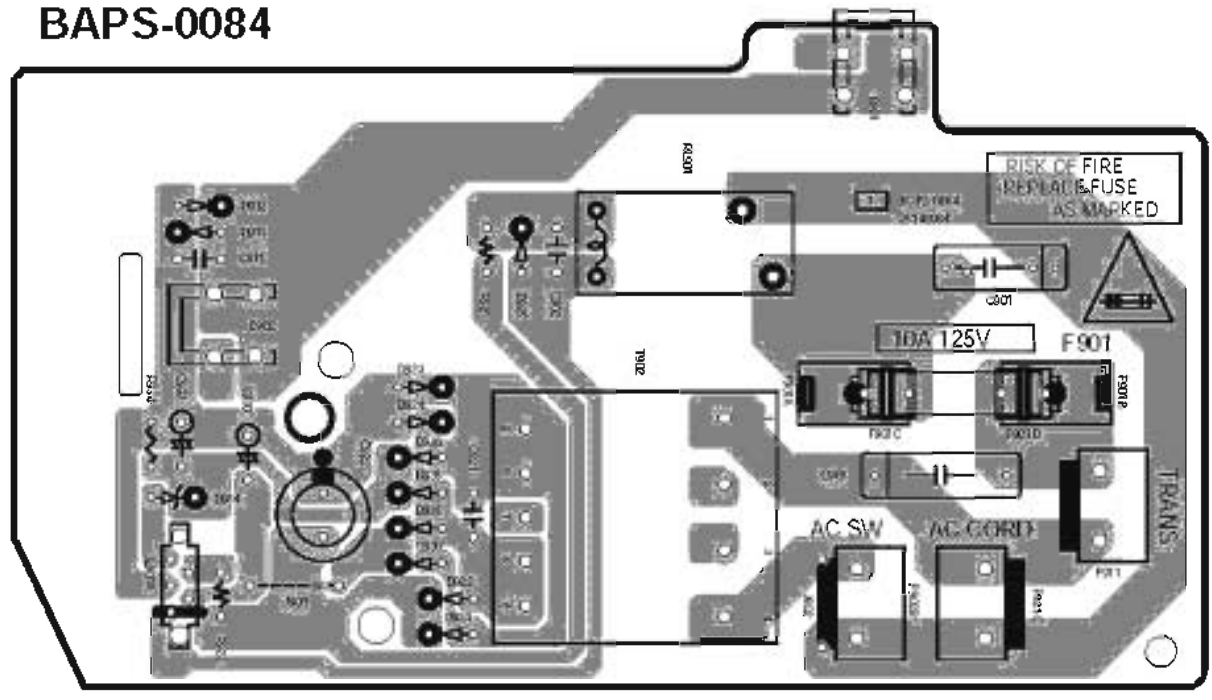

Soldering side view

U0022 SPEAKER TERMINAL-2 PC BOARD
BATRM-0085

Soldering side view

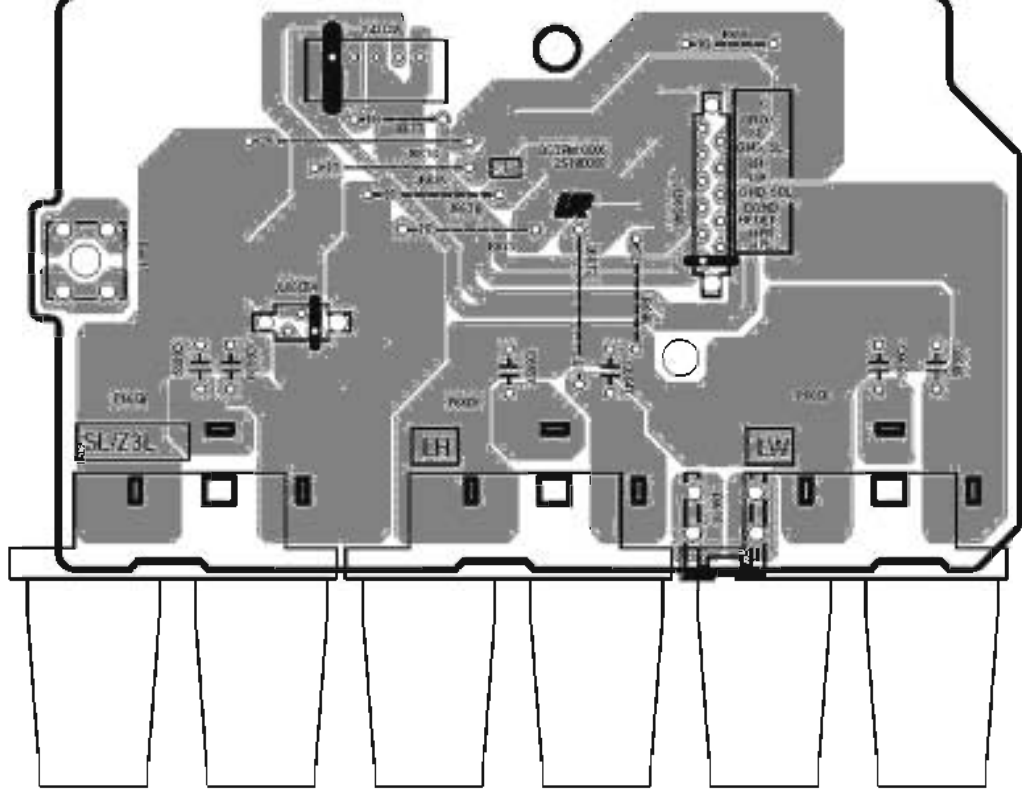

U008 CENTER SPEAKER TERMINAL PC BOARD
BATRM-0086

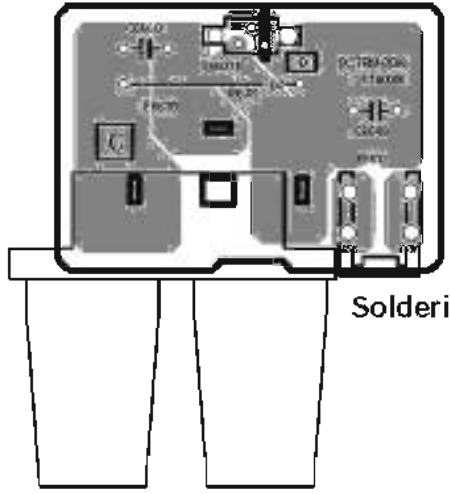

Soldering side view

PRINTED CIRCUIT BOARD VIEW-6

U003 DIGITAL INPUT CIRCUIT PC BOARD BADG-0099

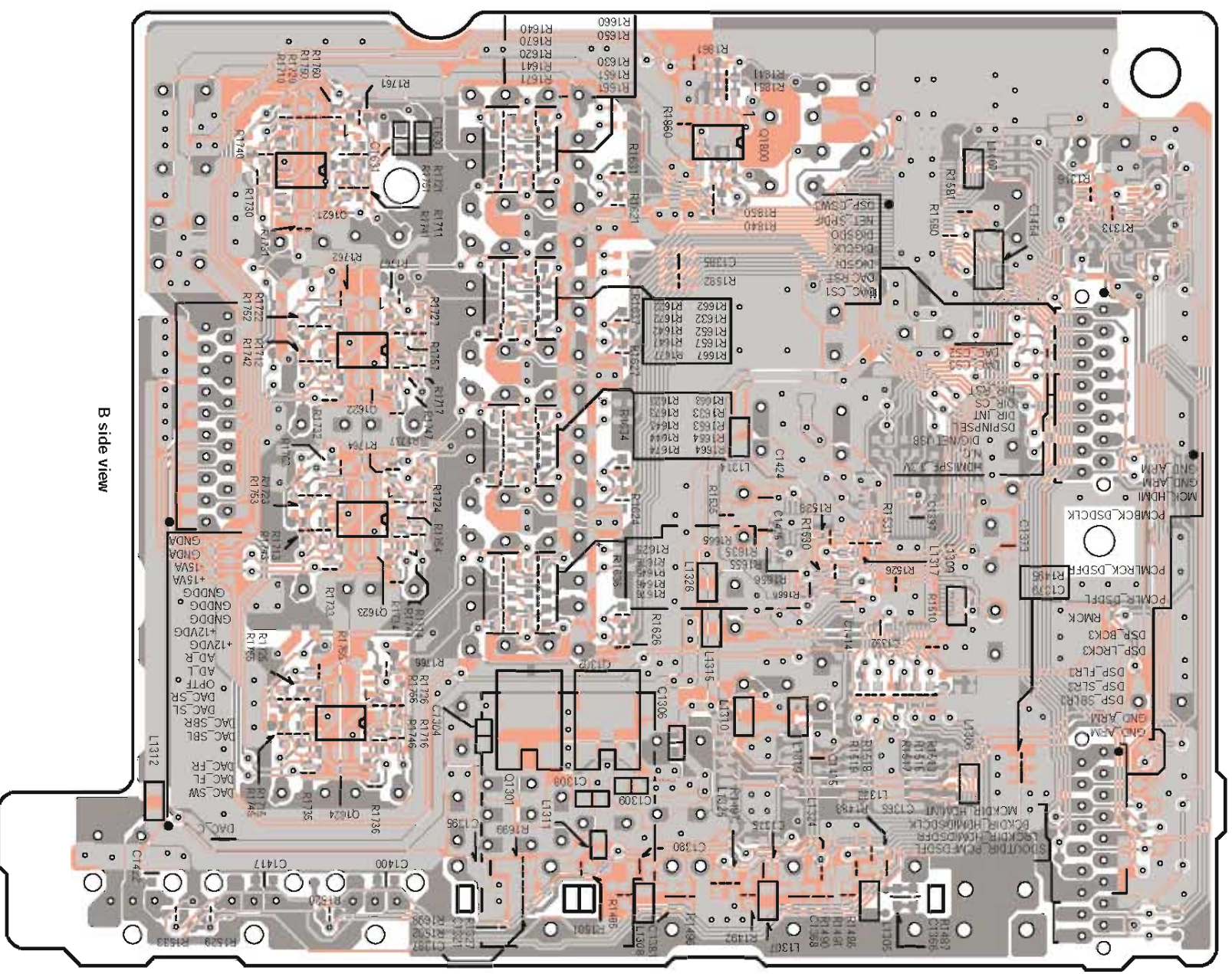

B side view

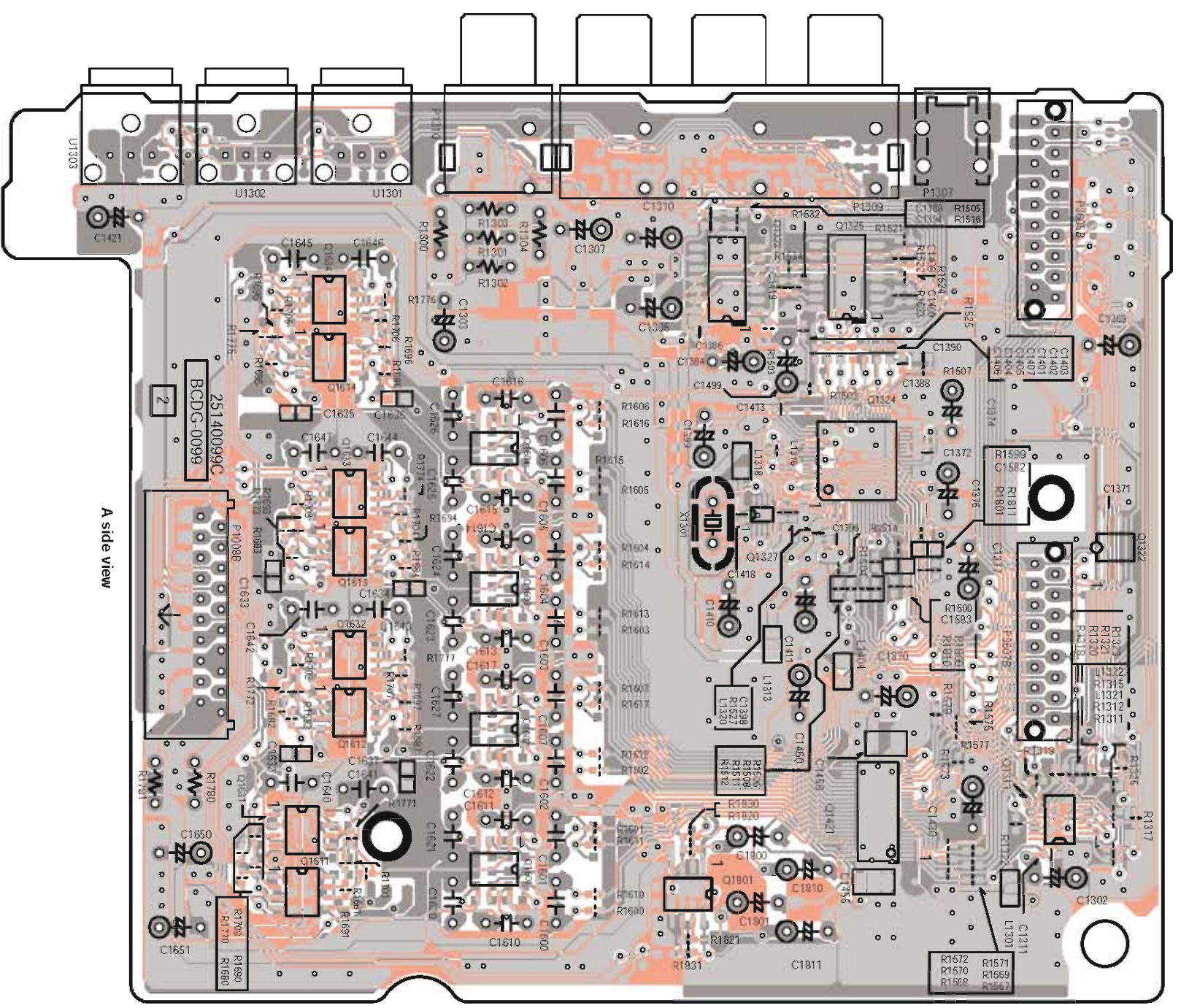

A side view

PRINTED CIRCUIT BOARD VIEW-7

U0031 CPU CIRCUIT PC BOARD BACPU-0100

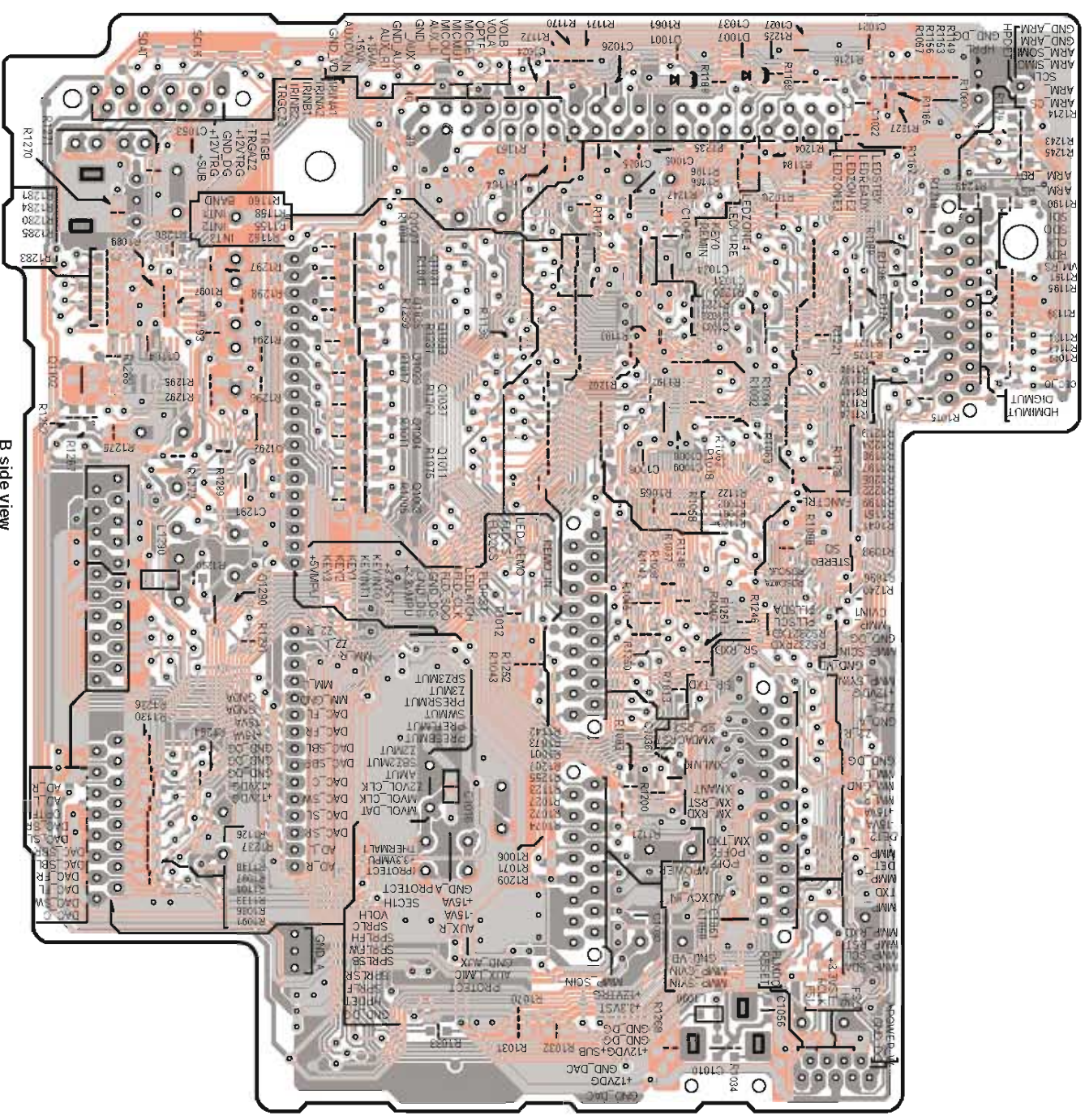

B side view

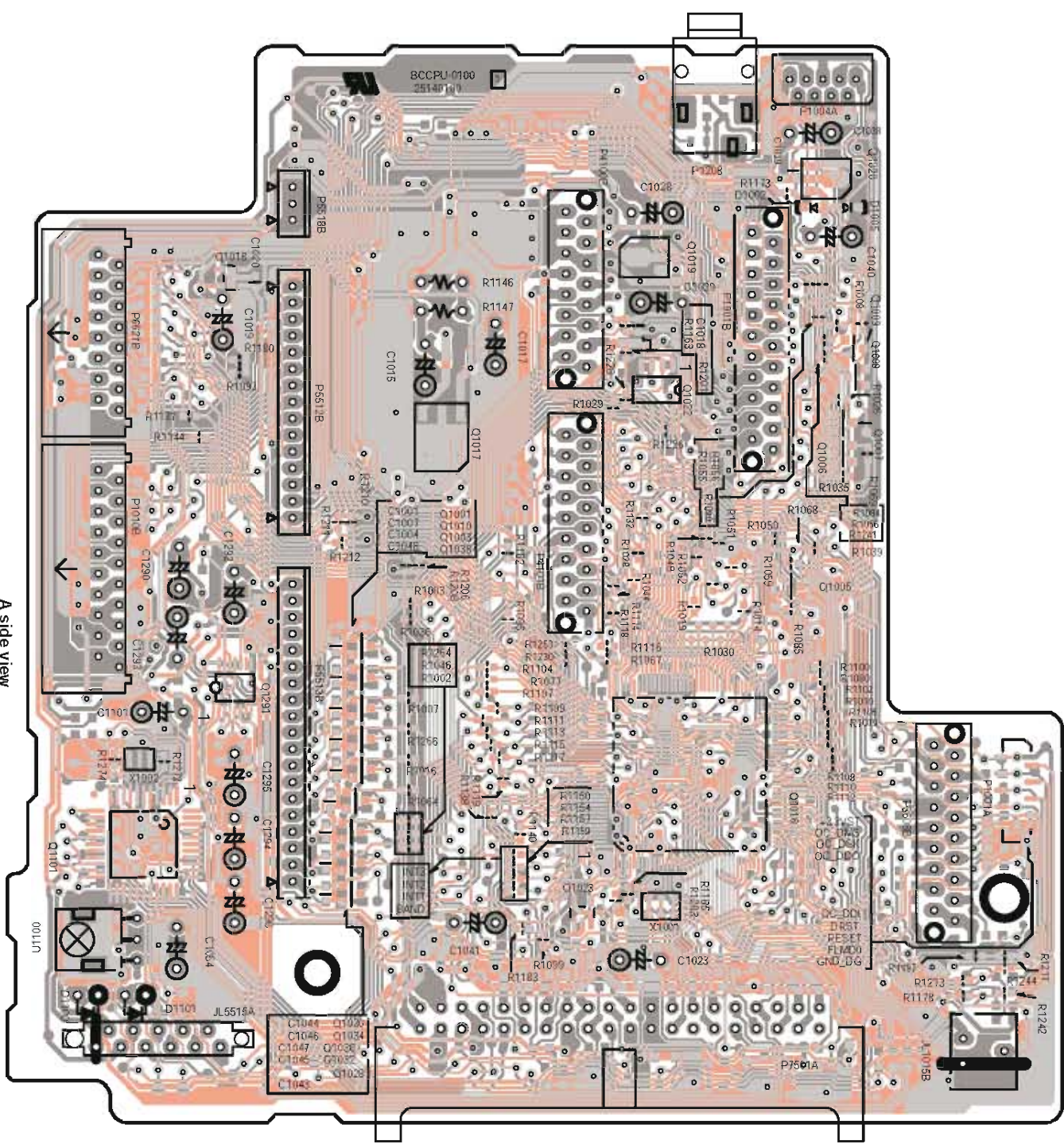

A side view

PRINTED CIRCUIT BOARD VIEW-8

U0032 VIDEO CIRCUIT PC BOARD

BAVD-0101

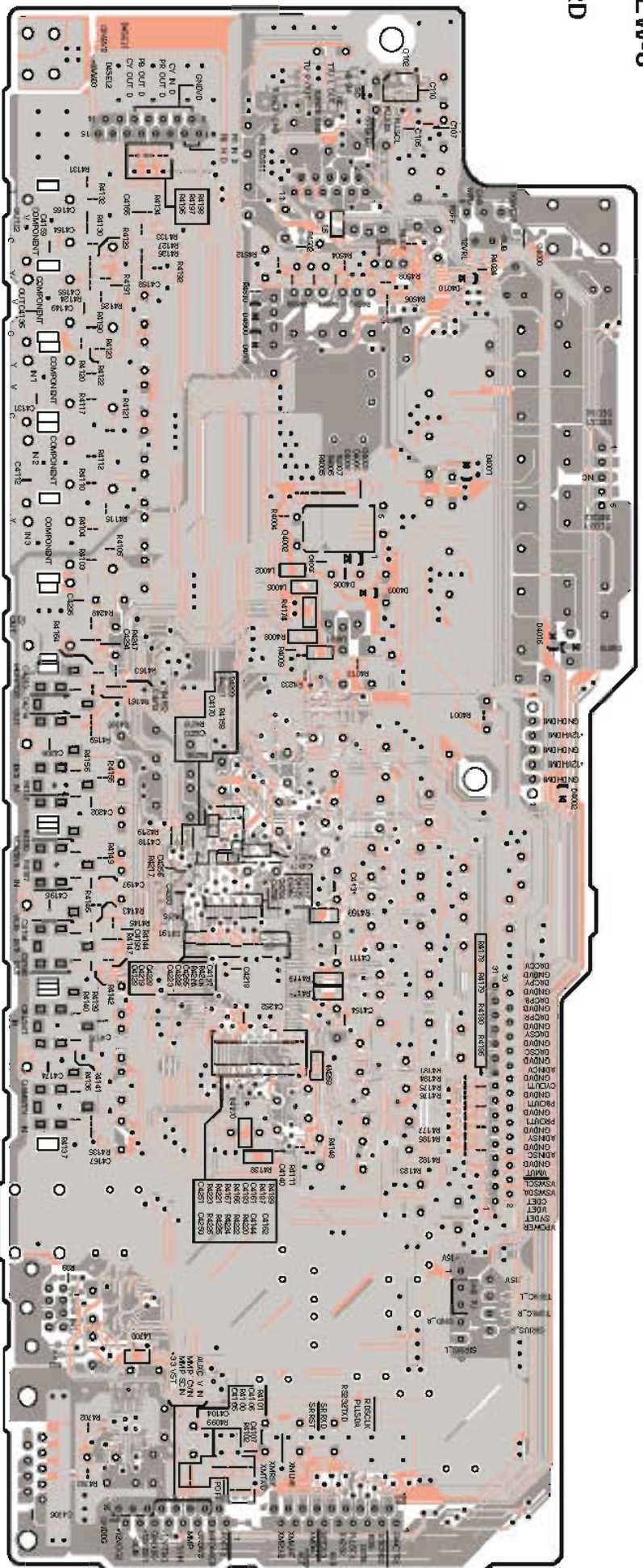

B side view

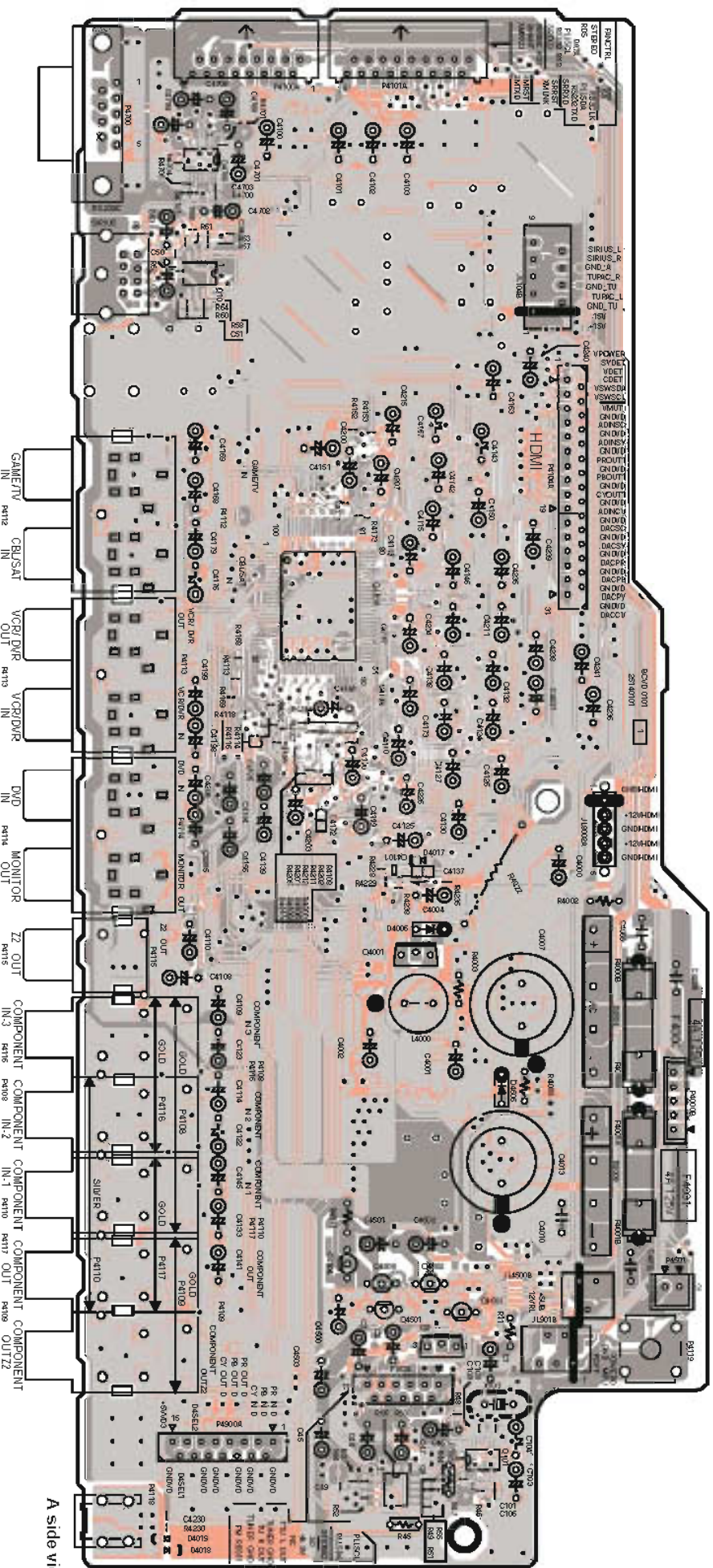

A side view

PRINTED CIRCUIT BOARD VIEW-9

U0033 UNIVERSAL PORT PC BOARD BAETC-0103

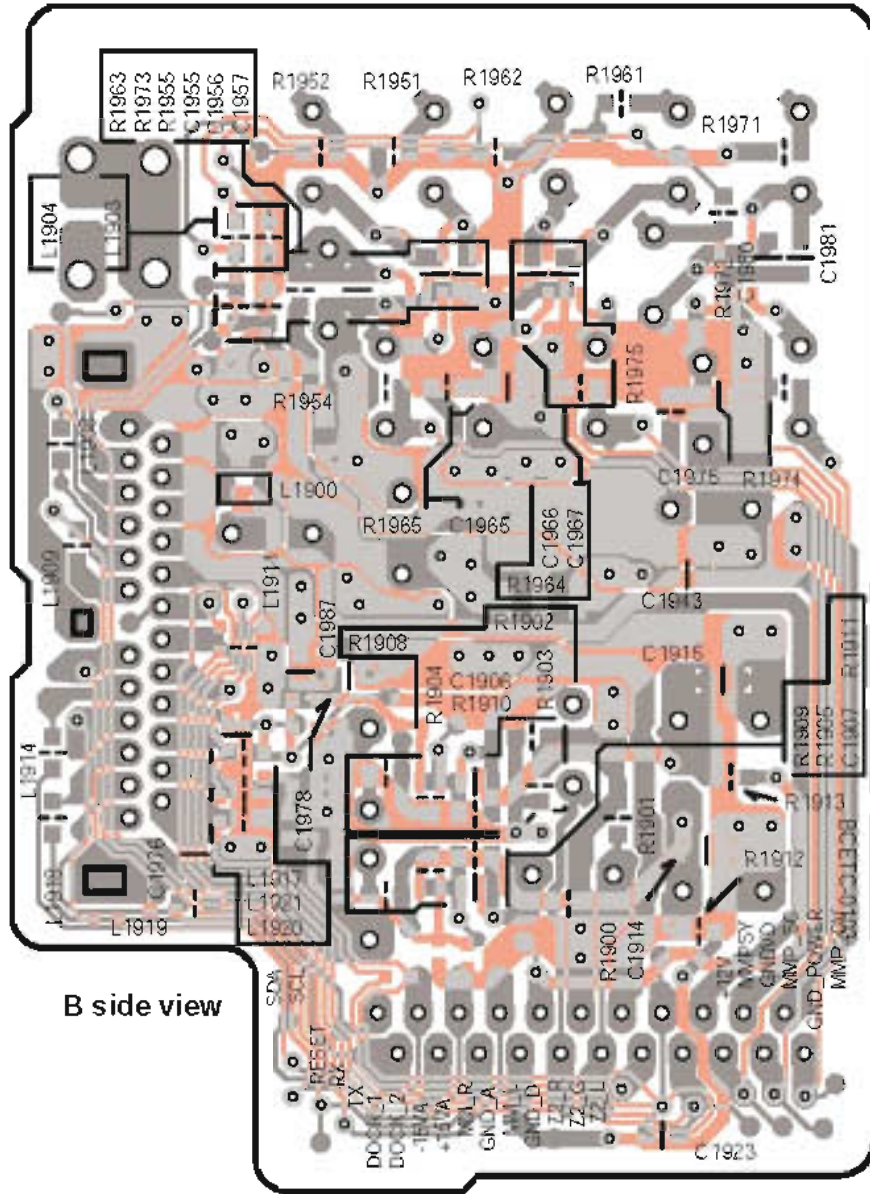

B side view

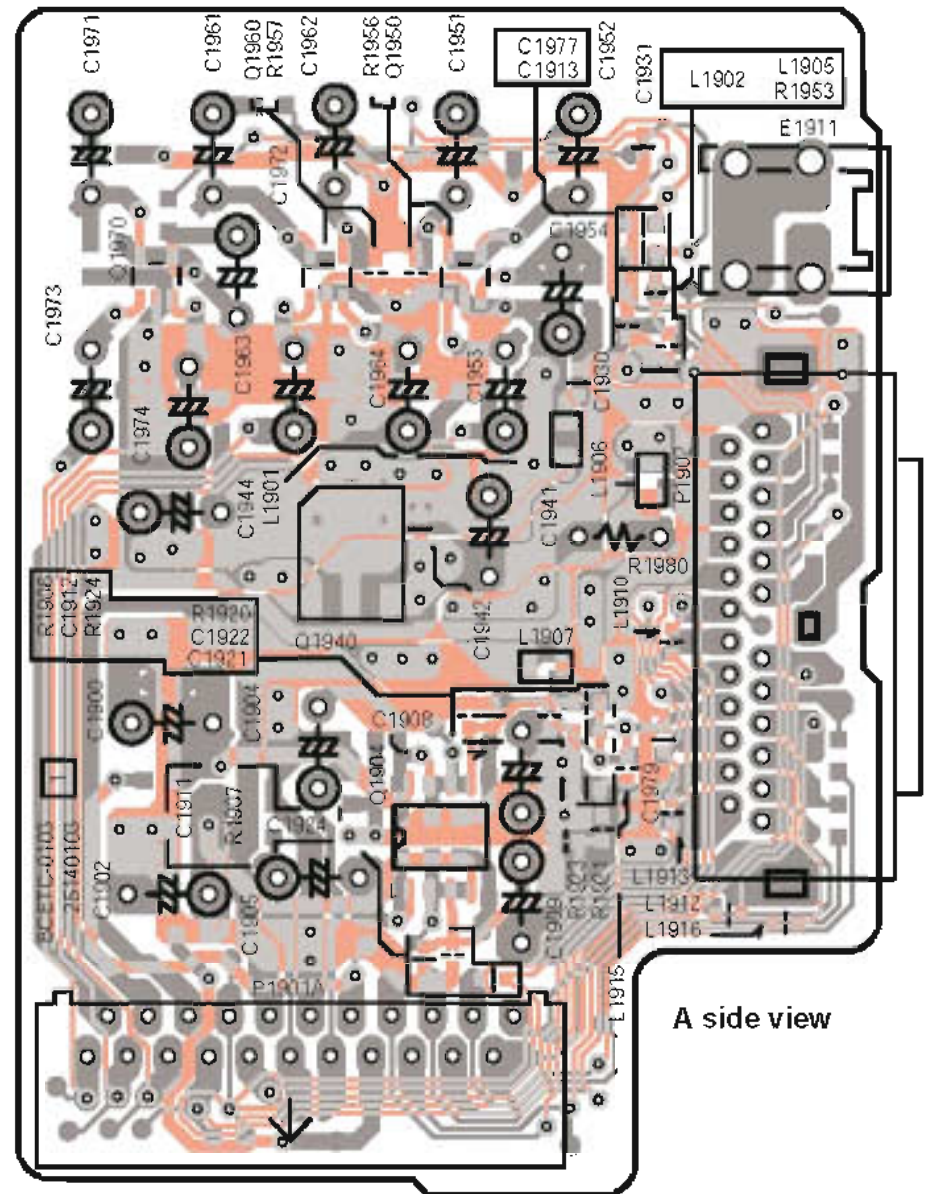

A side view

PRINTED CIRCUIT BOARD VIEW-10

U004

DISPLAY CIRCUIT BOARD
BADIS-0135

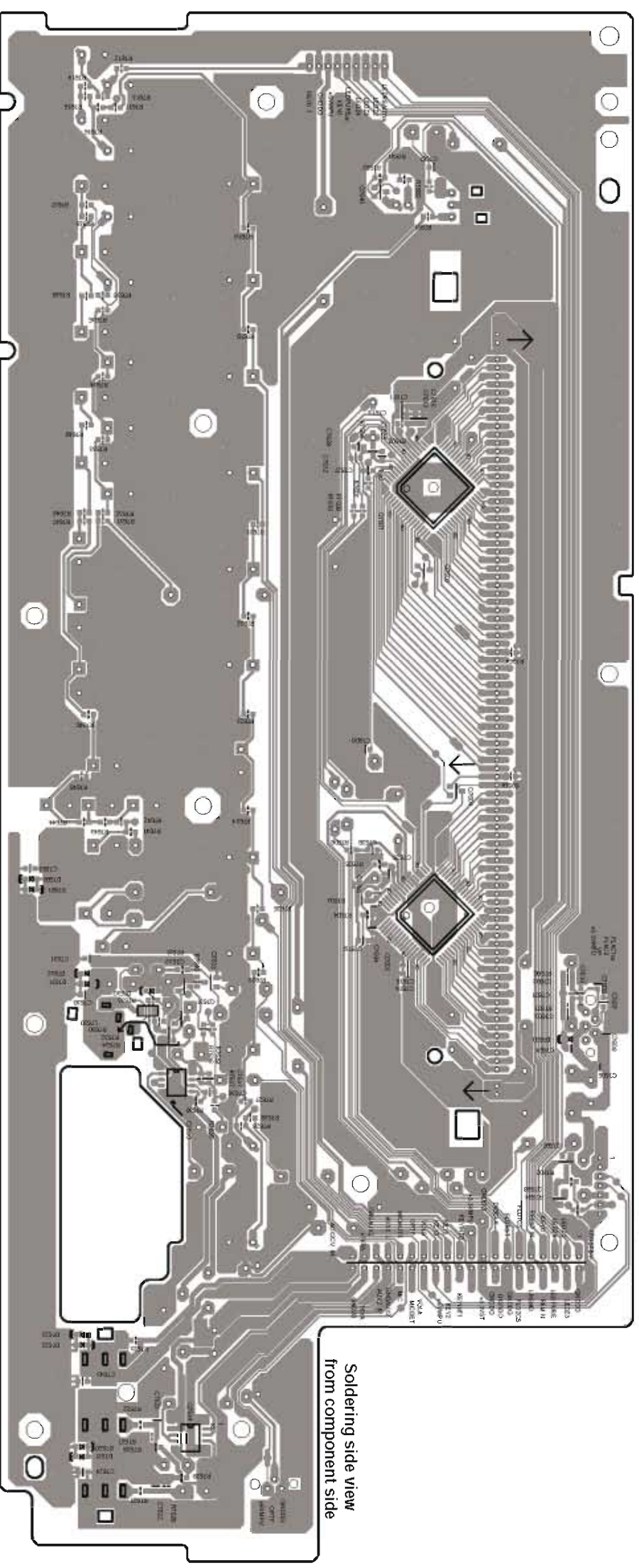
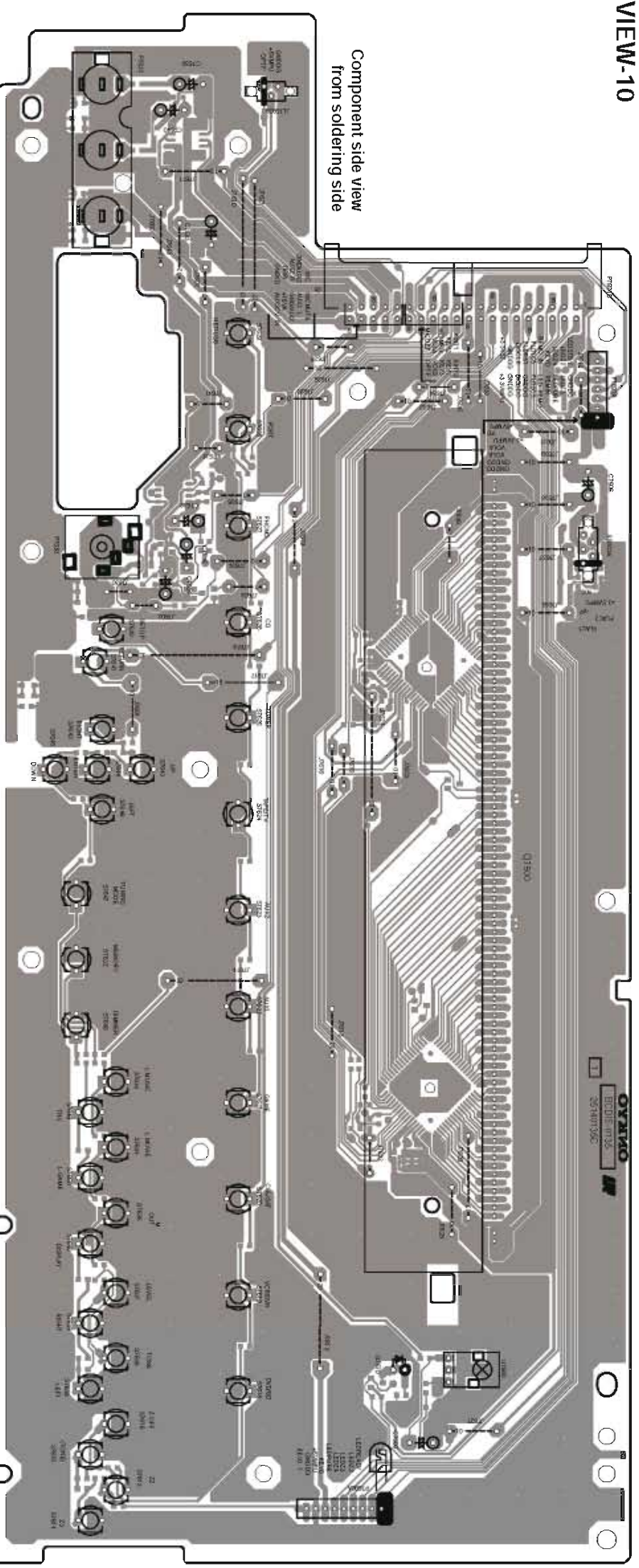

PRINTED CIRCUIT BOARD VIEW-11

U0041 STANDBY SWITCH PC BOARD BASW-0136

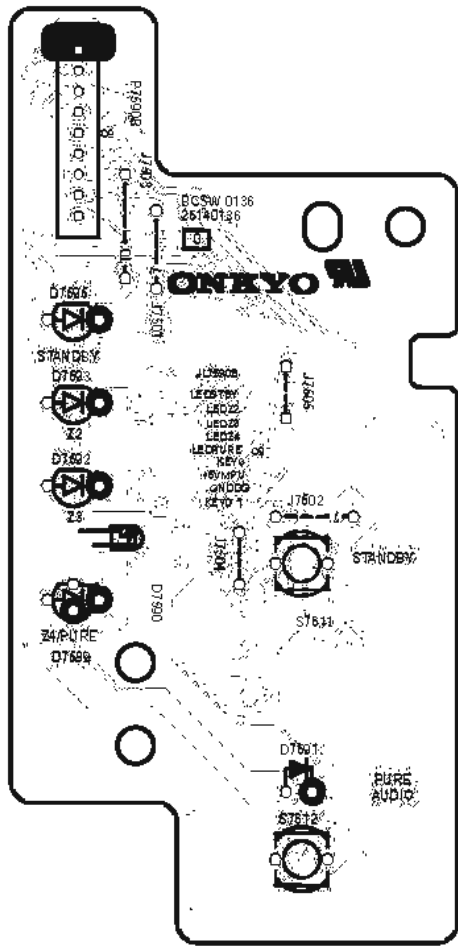

Component side view from soldering side

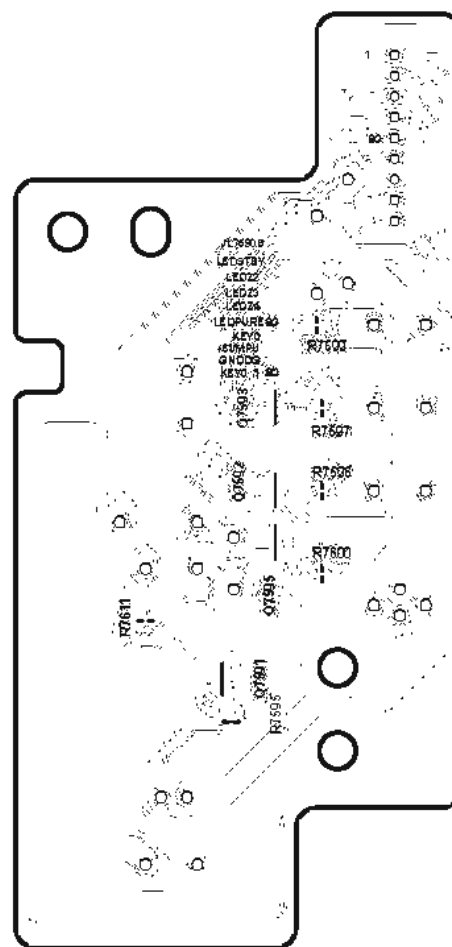

Soldering side view from component side

U0042 HEADPHONE TERMINAL PC BOARD BAETC-0137

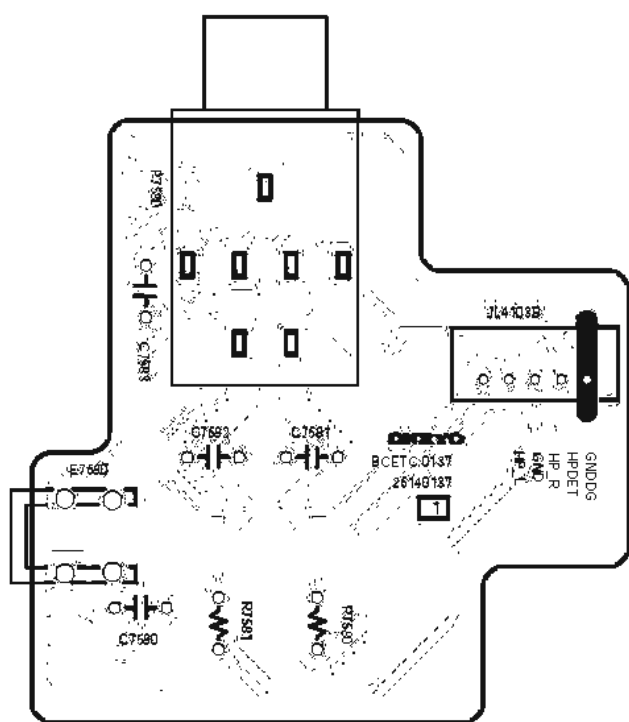

Component side view from soldering side

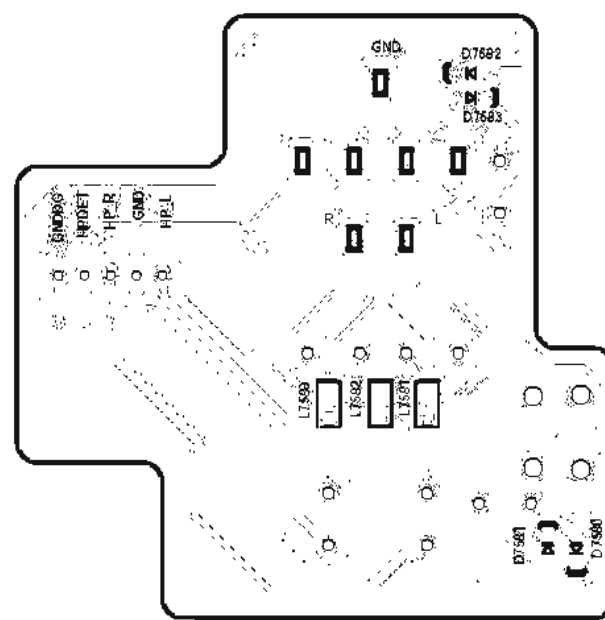

Soldering side view from component side

PRINTED CIRCUIT BOARD VIEW-12

U0045 FUSE PC BOARD BAPS-0140

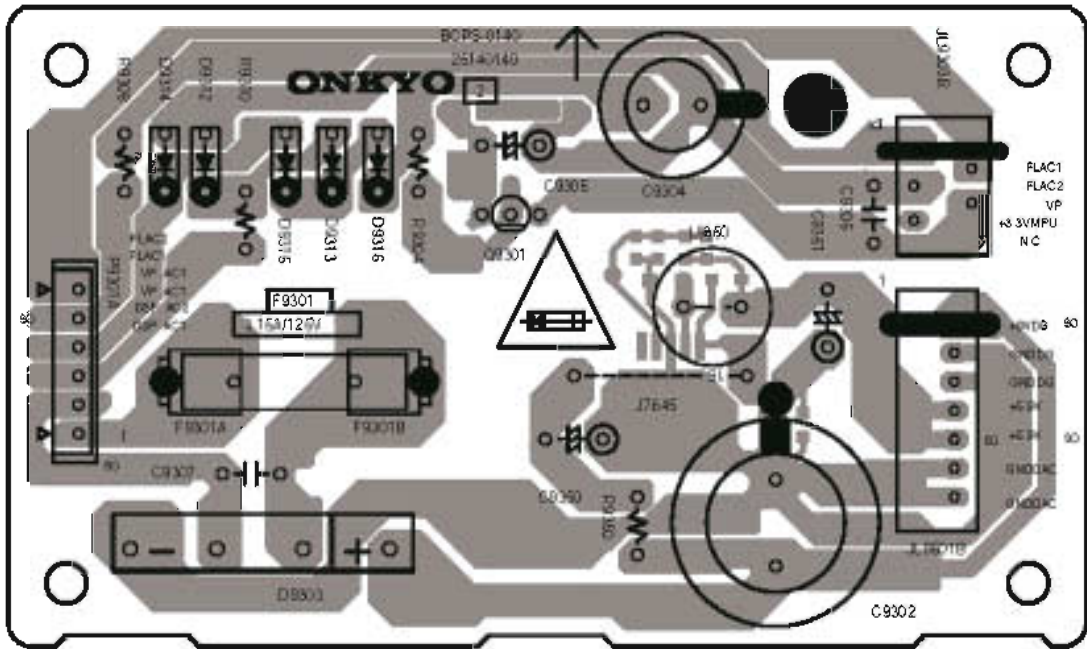

Component side view from soldering side

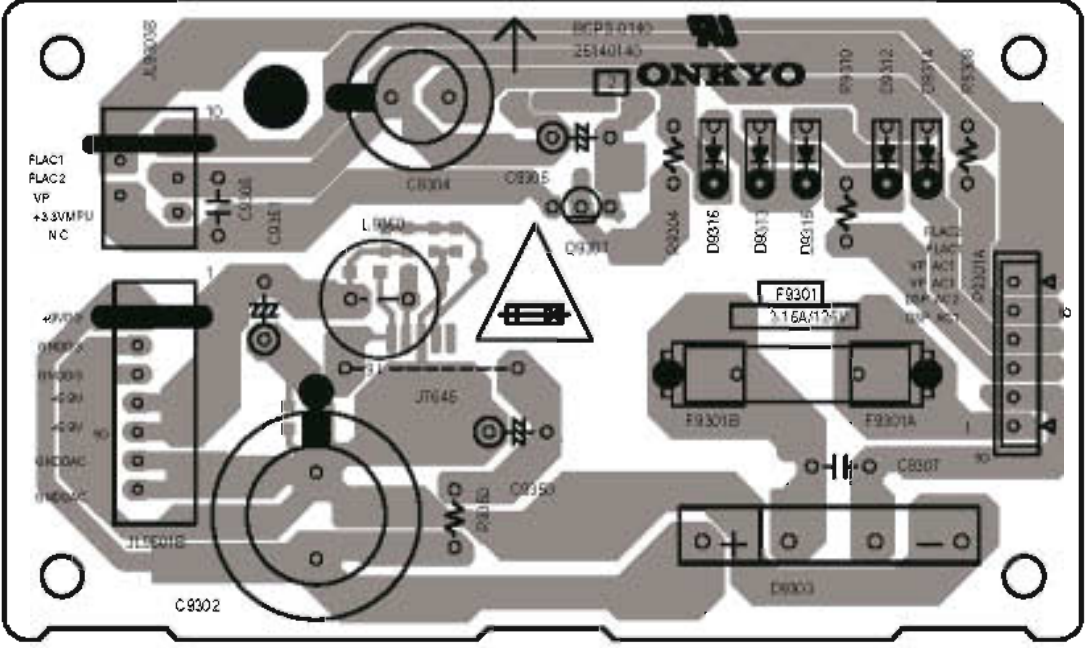

Soldering side view from component side

U0043 FRONT DIGITAL INPUT PC BOARD BAETC-0138

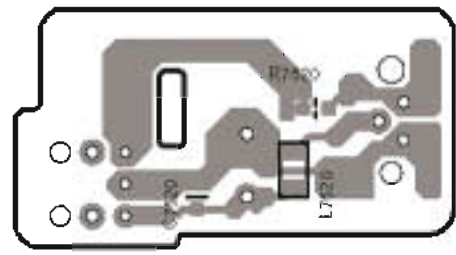

Component side view from soldering side

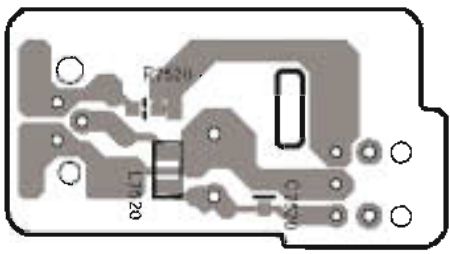

Soldering side view from component side

U0044 VOLUME LED PC BOARD BAETC-0139

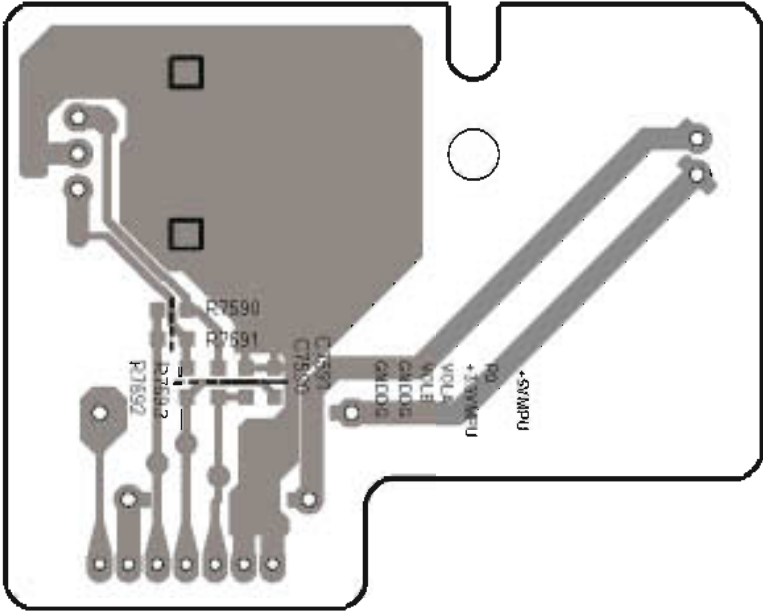

Component side view from soldering side

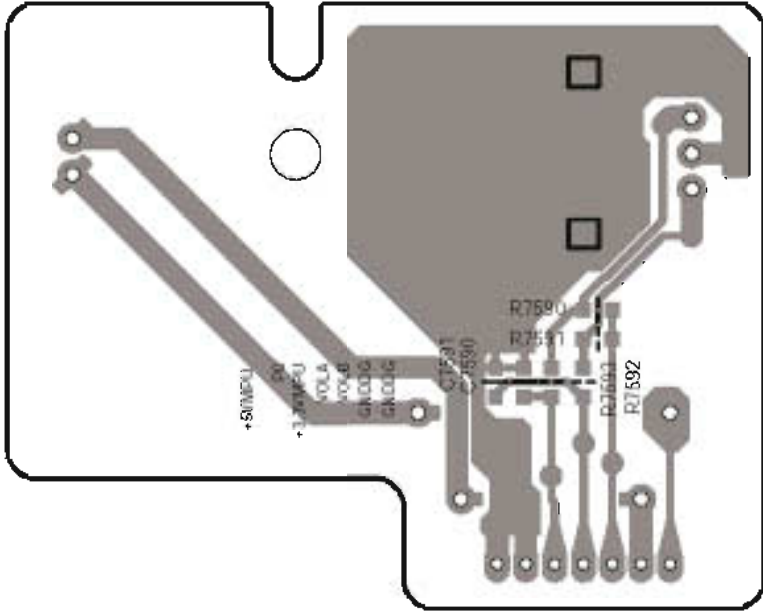

Soldering side view from component side

PRINTED CIRCUIT BOARD VIEW-13

U005 HDMI CIRCUIT PC BOARD BAHDM-0132-1B

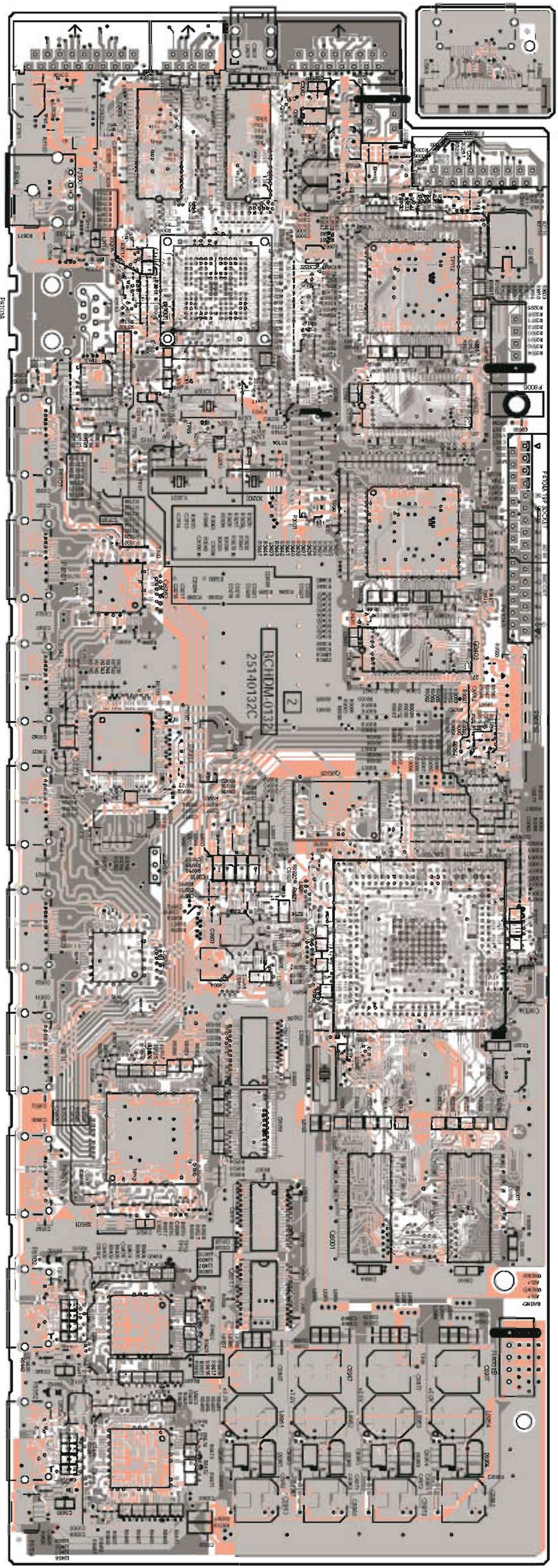

A-side view

A side pattern color
B side pattern color

PRINTED CIRCUIT BOARD VIEW-14

U005 HDMI CIRCUIT PC BOARD BAHDM-0132-1B

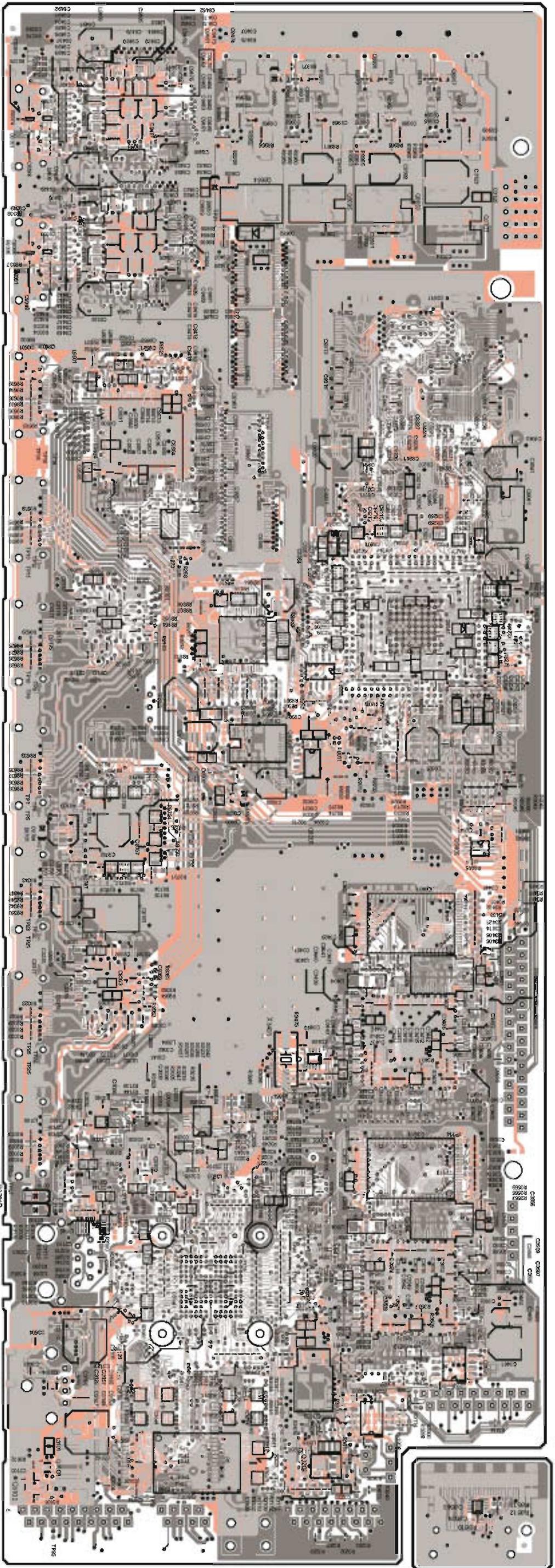

B-side view

A side pattern color
B side pattern color

PACKING PROCEDURE-1

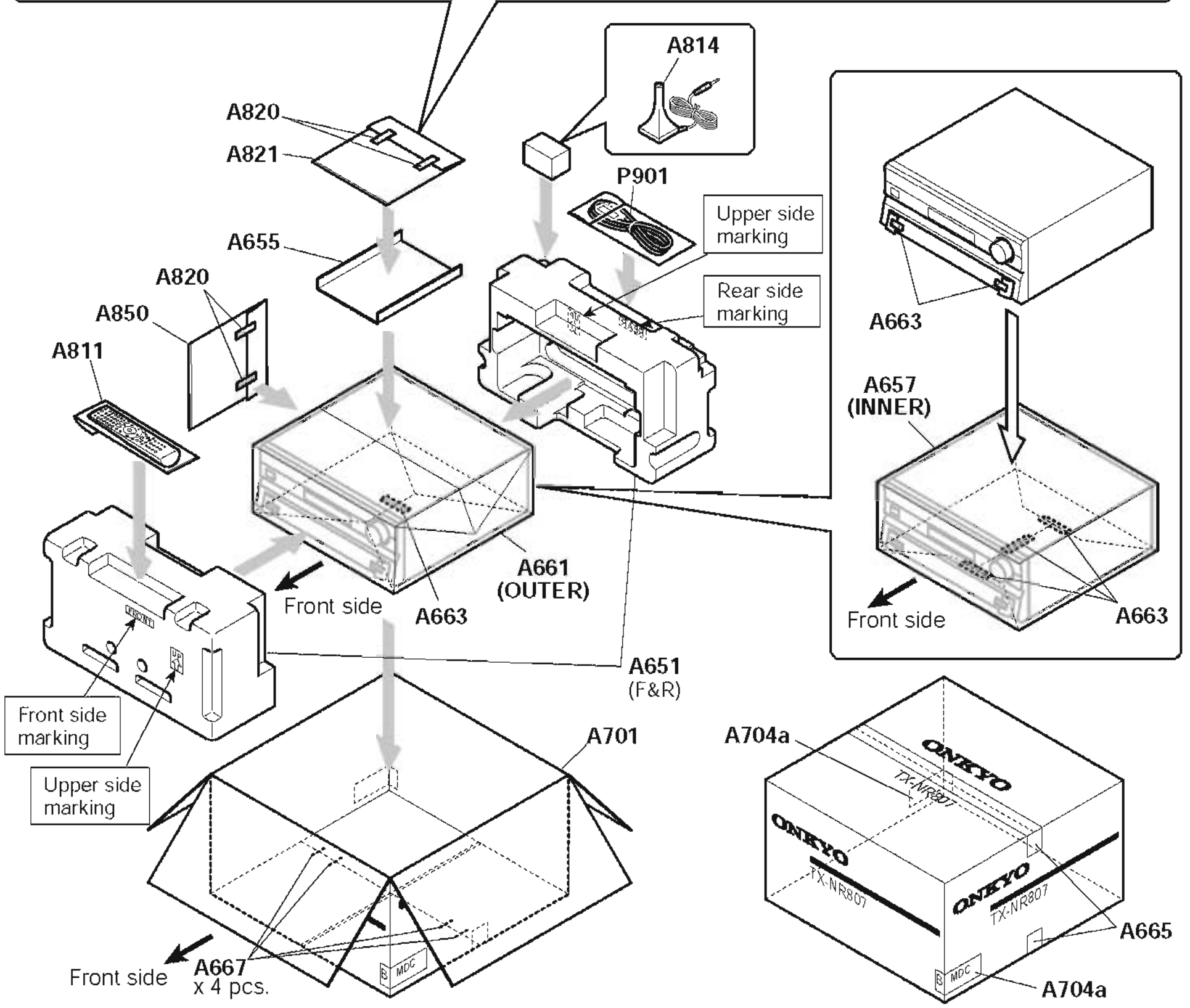
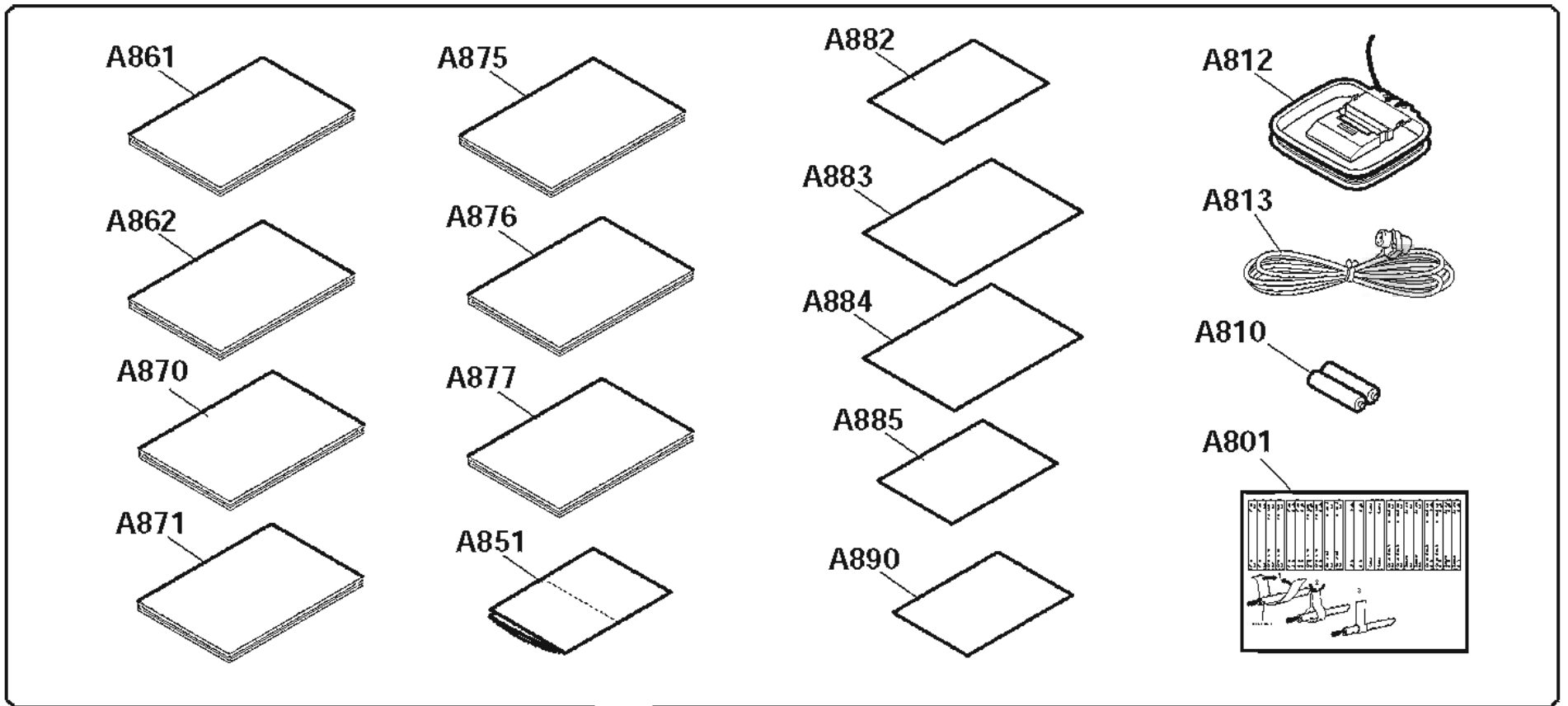

PACKING PROCEDURE-2

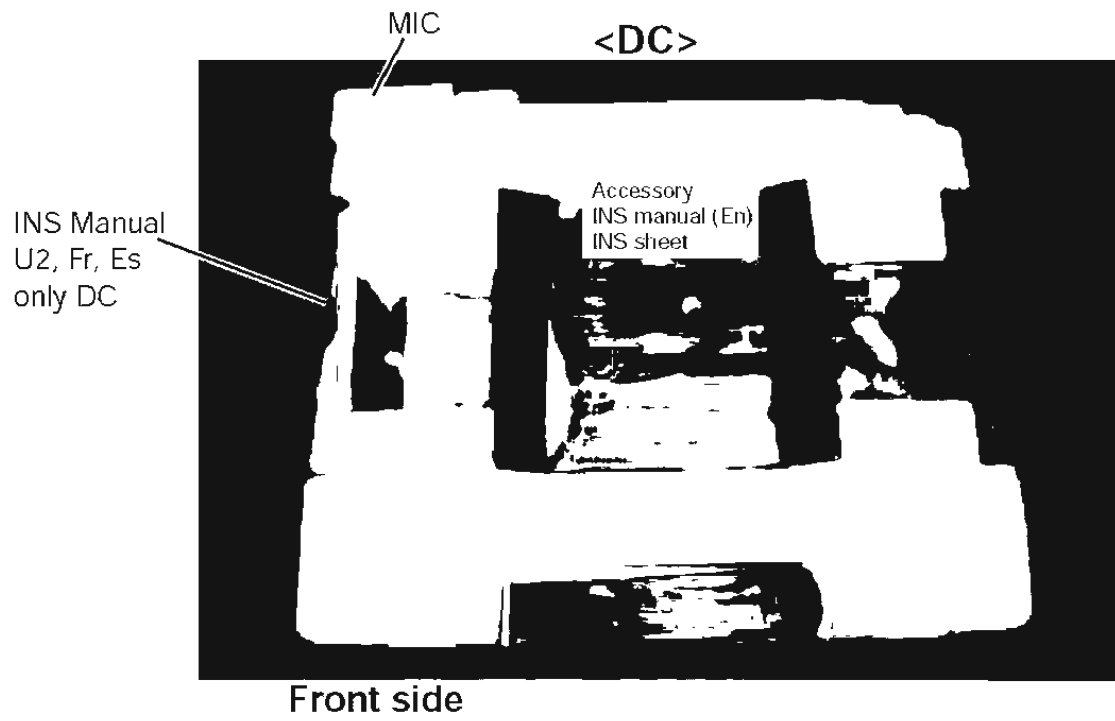
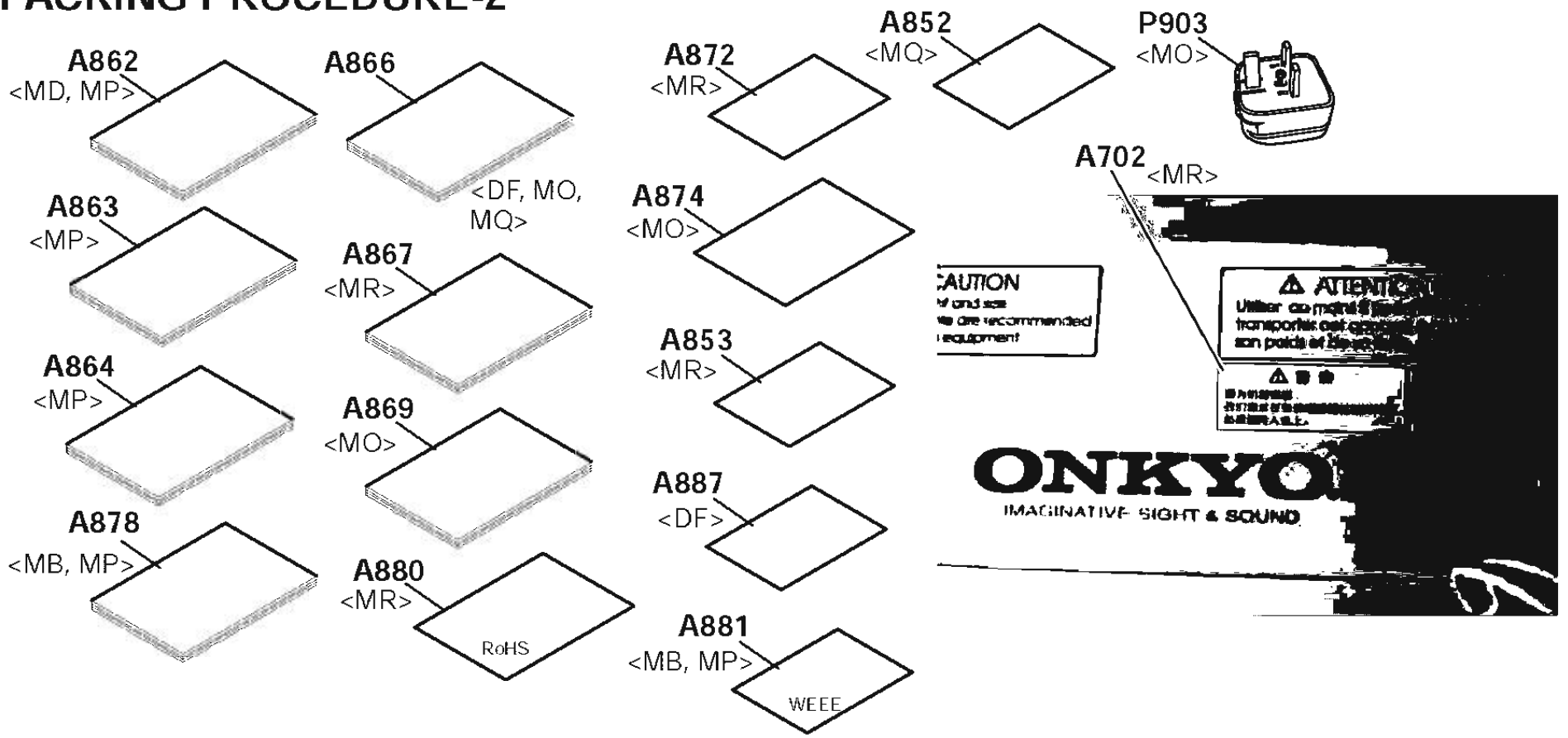

Front side

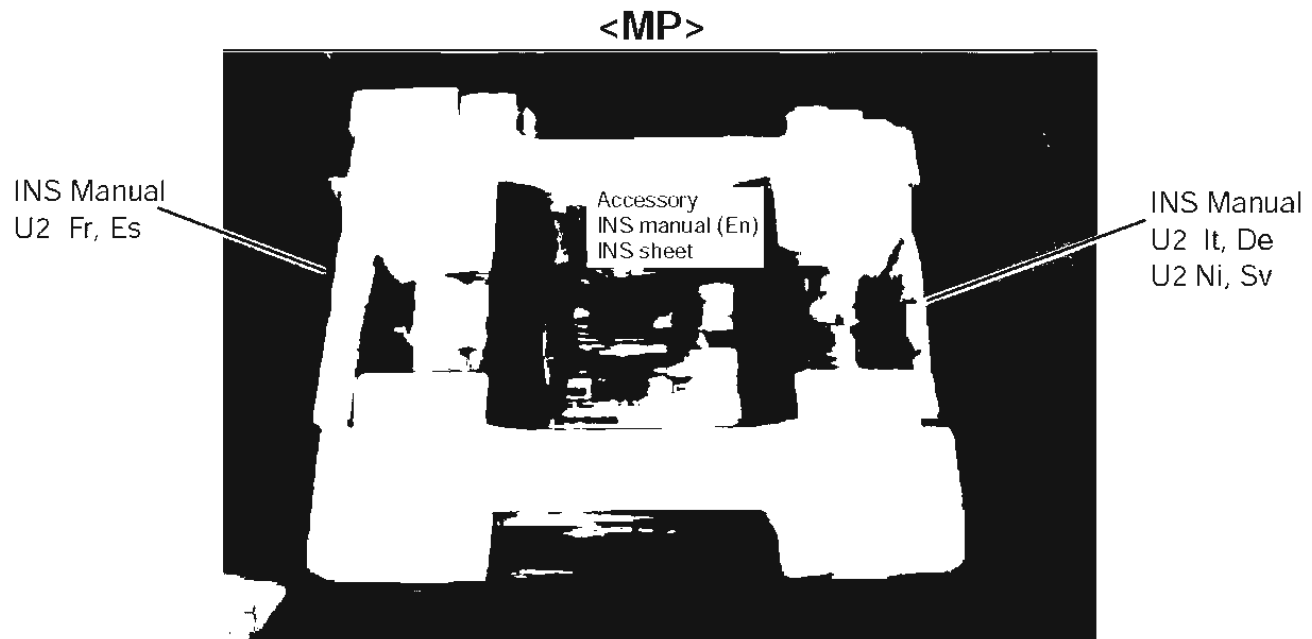

Front side

PARTS LIST

TX-NR807

NOTE : THE COMPONENTS IDENTIFIED BY THE MARK
 ! ARE CRITICAL FOR RISK OF FIRE AND
 ELECTRIC SHOCK. REPLACE ONLY WITH PART
 NUMBER SPECIFIED.

NOTE:
 NSP : Not service parts
 B : Black color
 S : Silver color
 DC : Canadian model
 DF : Taiwan model
 MA : Australian model
 MB : Britain model
 MP : European model
 MO : Saudi Arabia model
 MR : China model
 MQ : Hongkong model

EXCLUDED VIEW PARTS LIST

REF. NO.	PART NAME	DESCRIPTION	Q'TY	PART NO. (SN)	REMARKS
[SEMI CONDUCTOR]		<Note>			
		Must use the same HFE rank mutually about the following parts.			
		Ref. No. : Q6050 - 6056, Q6060 - 6066			
Q6050	TR	TTC0001(Q_T)TO3PN	1	2204130	
Q6050A	ISO SHEET	AC238	2	223024	
Q6050B	ISO SHEET	ISO SHEET	6	223041	
Q6051	TR	TTC0001(Q_T)TO3PN	1	2204130	
Q6052	TR	TTC0001(Q_T)TO3PN	1	2204130	
Q6053	TR	TTC0001(Q_T)TO3PN	1	2204130	
Q6054	TR	TTC0001(Q_T)TO3PN	1	2204130	
Q6055	TR	TTC0001(Q_T)TO3PN	1	2204130	
Q6056	TR	TTC0001(Q_T)TO3PN	1	2204130	
Q6060	TR	TTA0001(Q_T)TO3PN	1	2204120	
Q6061	TR	TTA0001(Q_T)TO3PN	1	2204120	

Q6062	TR	TTA0001(Q_T)TO3PN	1	2204120	
Q6063	TR	TTA0001(Q_T)TO3PN	1	2204120	
Q6064	TR	TTA0001(Q_T)TO3PN	1	2204120	
Q6065	TR	TTA0001(Q_T)TO3PN	1	2204120	
Q6066	TR	TTA0001(Q_T)TO3PN	1	2204120	

[TRANS COIL]

T901	P TRANS	NPT-1571D	1	2301935	! B DC, DF !
T901	P TRANS	NPT-1571M	1	2301936A	N ! B MA, MB, MO, MP, MQ, MR, S !

[SW TRIM]

F4000	FUSE	4A-UL/T-233	1	252325GR	! !
F4000or	FUSE	4A-T/UL-ST2	(1)	252257GR	! !
F4001	FUSE	4A-UL/T-233	1	252325GR	! !
F4001or	FUSE	4A-T/UL-ST2	(1)	252257GR	! !
F6901	FUSE	15A-TUL-250V	1	252303GR	! !
F6902	FUSE	15A-TUL-250V	1	252303GR	! !
F901	FUSE	6.3A-SE-EAK FUSE	1	252079GR	! B MA, MB, MO, MP, MQ, MR, S !
F901or	FUSE	6.3A-SE-TL250V	(1)	252279GR	! B MA, MB, MO, MP, MQ, MR, S !
F901	FUSE	12A-TUL-250V	1	252301GR	! B DC, DF !
F901A	LABEL	T6 3AL/250V	1	29361681	B MR
F901A	FUSE LABEL	12A/250V	1	29362325	B DC, DF
F901B	LABEL	T6 3AL/250V	1	29361681	B MA, MB, MO, MP, MQ, S
F901B	LABEL	15A/250V	1	29362252	B JJ
P103	FFC	NCFC7-111012	1	2047111012	
P4104	FFC	NCFC7-311012	1	2047311012	
P500	WIRE TIE	BSK-1	15	260208	
P6600A	P RIVET	JB-407A-C	22	880052	B MA, MB, MO, MP, MQ, MR, S
P691	FAN	D05X-12TL	1	24502317	
P693	FAN	D09A-12PG13	1	24502328	
P7501	SOCKET AS	NSAS-80P1788	1	2009991154UL	
P9008	SOCKET AS	NSAS-3P1760	1	2009991127UL	B DC, DF
P9008	SOCKET AS	NSAS-4P1797	1	2009991163UL	B JJ, MA, MB, MO, MP, MQ, MR, S

[CHASSIS SCREW]

A001	CHASSIS	807	1	27100539	
A003	LEG	---	4	27175419	
A005	CUSHION	(LEG)	4	28141660	
A007	CUSHION	(BUTYL)	1	28141748	
A009	SCREW	3TTB+8B(3CM)SR	4	801637	
A015	SCREW	4TTC+8C(3BC)	4	830440089GR	
A017	SPACER	---	1	27270439	

A018	RETAINER	(TR)	1	27142165
A021	BRACKET	(FAN-L)	1	27131046
A023	BUSHING	(FAN-L)	4	28170091A
A025	SCREW	3TTB+8B(3BC)	3	838430088GR
A029	HEAT SINK	---	1	27160620A
A031	SCREW	3SMS8W.SW+14B(CU)	14	801634
A033	SCREW	3TTB+8B(3CM)SR	1	801637
A041	RETAINER	(HT-L8)	1	27142110A
A043	RETAINER	(HT-R8)	1	27142111
A044	SCREW	3TTB+8B(3CM)SR	2	801637
A045	SCREW	3TTB+8B(3CM)SR	4	801637
A049	SCREW	3TTB+8B(3CM)SR	3	801637
A051	BRACKET	(FAN-S)	1	27131047
A052	CUSHION	T10*10*10EPT	1	28141813
A053	BUSHING	(FAN-S)	2	28170090
A055	SCREW	3TTB+8B(3CM)SR	2	801637
A057	IB CUSHION	W15*3T TAPE	1	28141585
A059	SCREW	3TTB+8B(3CM)SR	2	801637
A061	RETAINER	(PC)	1	27142125
A063	RIVET	P-RIVET NRP-345	2	880009
A065	CUSHION	---	4	28141783
A067	CUSHION	(PCB)	2	28141789
A071	CLAMP	WS-2NS	1	27300833
A075	HOLDER	HOLDER KGLS-8S	6	27190480
A077	HOLDER	KGPS-14RF	8	27190802
A079	HOLDER	KGLS-14S	1	27190164
A081	HOLDER	HOLDER KGLS-18S	4	27190470
A085	HOLDER	KGLS-12RT	1	27190266
A087	HOLDER	KGLS-10RT	1	27190428A
A089	HOLDER	KGLS-22RT	1	27190772
A091	HOLDER	SPM-4	4	27191154
A101	SCREW	3TTB+8B(3CM)SR	1	801637
A105	SCREW	4TTC+8C(3BC)	2	830440089GR
A107	SCREW	3TTB+8B(3CM)SR	2	801637
A109	SCREW	3TTB+8B(3BC)	2	838430088GR
A111	CUSHION	(BUTYL)	1	28141748
A113	CUSHION	(BUTYL)	1	28141748
A115	TAPE	TAPE(CLOTH-8U)	1	29110082
A121	LABEL	(PT)	1	29363408-1

A131	BRACKET	(F)807	1	27131065A	
A133	BUSHING	L125	2	28170004	
A135	HOLDER	(φ77) UA-0	2	27190432	
A137	RETAINER	(SIDE)	2	27142107	
A139	SCREW	3TTB+8B(3CM)SR	4	801637	
A141	TAPE	TAPE(CLOTH-16U)	1	29110083	
A147	SCREW	3TTB+8B(3CM)SR	7	801637	
A171	REAR PANEL	TX-NR807MDC	1	27124005A	N B DC, DF
A171	REAR PANEL	TX-NR807MMA	1	27124006B	N B MA, MB, MO, MP, MQ, S
A171	REAR PANEL	TX-NR807MMR	1	27124007A	B MR
A173	SCREW	3TTB+8B(3BC)	44	838430088GR	B DC, DF
A173	SCREW	3TTB+8B(3BC)	44	838430088GR	B MA, MB, MO, MP, MQ, MR, S
A175	SCREW	3P+6FN(3BC)	7	82143006GR	
A177	SCREW	3P+6FN(3BC)	2	82143006GR	
A179	SCREW	3P+6FN(3BC)	1	82143006GR	B DC, DF
A183	SCREW	4TTB+10B(3BC)	2	838440108GR	
A185	TRM	E#-27#	1	25060151	
A189	WASHER	W3*10F(3BC)	1	87643010GR	
A191	LABEL	(SP1)	1	29390790	
A193	LABEL	(SP2)	1	29390791	
[CABINET]					
A205	F BRACKET	AS(BLACK)	1	27111561D	
A205	F BRACKET	AS(SILVER)	1	27111562D	S
A206	TAPE	TAPE(CLOTH-8U)	1	29110082	
A209	BUSHING	(DOOR)	2	28170095	
A209	BUSHING	(DOOR) GRAY	2	28170096	S
A251	B PLATE	(B)	1	28133428	B
A251	B PLATE	(S)	1	28133429	S
A251	B PLATE	BLUE	1	28133436	B
A255	FACET	(VOL)	1	28200040A	
A257	SCREW	3TTB+8B(3CM)SR	2	801637	
A265	KNOB	(POW) (B)	1	28326454	B JJ, MA, MB, MO, MP, MQ, MR
A265	KNOB	(POW)(S) 09	1	28326729	S
A267	SCREW	3P+6FN(3BC)	2	82143006GR	B JJ, MA, MB, MO, MP, MQ, MR, S
A311	KNOB	(STBY)807	1	28326702	S
A321	RETAINER	(F)	1	27142155A	
A351	CUSHION	15*30*5	1	28141562	
A353	CUSHION	(T3*W35*D10)	1	28141741	
A355	TAPE	TAPE(CLOTH-16U)	1	29110083	

A357	IB CUSHION	W15*3t TAPE	1	28141585	
A363	SCREW	3TTB+8B(3CM)SR	20	801637	
A375	SCREW	3TTB+8B(3BC)	3	838430088GR	
A377	SCREW	3TTB+8B(3BC)	3	838430088GR	
A383	SCREW	3TTB+8B(3CM)SR	3	801637	
A385	SCREW	3TTB+8B(3CM)SR	1	801637	
A405	F PANEL	807(B)D/C/DF	1	27213255	N B DC, DF
A405	F PANEL	807(B)M/A/MO/MQ	1	27213256	B M/A, MB, MO, MP, MQ, MR
A405	F PANEL	807(S)M/A/MO	1	27213257	S
A409	BADGE	BADGE	1	28135244	
A409	BADGE	---	1	28135298	S
A411	CLEAR PLT	(AS) NR807	1	28192265	N B DC, DF, MA, MB, MO, MP, MQ, MR, S
A455	KNOB	(VOL)AS 807B	1	28326693	
A455	KNOB	(VOL)AS 807S	1	28326694	S
A456	CUSHION	10.9*Φ48	1	28141824	
A501	DOOR	SR807(B)MDC	1	28148732	N B DC, DF
A501	DOOR	(B)MMA/P/O/Q/DF	1	28148733	N B MA, MB, MO, MP, MQ, MR
A501	DOOR	SR807(S)MMA/P/O	1	28148734	N S
A511	RETAINER AS	(L)	1	27142166	
A513	RETAINER AS	(R)	1	27142167	
A515	SCREW	3TTB+8B(3CM)SR	3	801637	
A519	HOLDER	(DAMPER)	1	27191334B	
A521	SCREW	3TTB+8B(3CM)SR	1	801637	
A523	DAMPER	002P Type-L	1	27301965	
A525	SCREW	3TTB+8B(3CM)SR	1	801637	
A529	PLATE	(LOCK)	1	27262843	
A531	SCREW	3P+6FN(3BC)	2	82143006GR	
A533	BRACKET	(L)	1	27131062B	
A535	BRACKET	(R)	1	27131063B	
A537	SCREW	3P+6FN(3BC)	2	82143006GR	
A545	E-WASHER	ES-3S	1	8930301S	
A603	COVER	(B) (Bent)	1	28210037	
A603	COVER	(S) (Bent)	1	28210038	S
A603	COVER	(B) (Not Bent)	1	28210037Z	
A605	LABEL	HOOKUP-ONKYO	1	29363194	B DC
A607	LABEL	(CAUTION)	1	29363797	S
A607	LABEL	(COVER)	1	29364123	
A611	SCREW	3TTB+8B(3CM)SR	3	801637	S
A611	SCREW	3TTB+8B(3BC)	3	838430088GR	

A612	LABEL	(UK-CR)	1	29364600		B MB
A613	ST SCREW	4TTB+8C(NI)	6	838240089		S
A613	SCREW	4TTB+8C(3BC)	6	838440089GR		
A615	TAPE	FIXLON #817 W12	1	29110207		
A615or	TAPE	SLIONTEC 9514	(1)	29110201		
A616	CUSHION	EPE 12.5x40x10	2	28141819		
A617	INST SHEET	txnr807 door	1	29355770		

[PC BORAD ASSY UNIT]

U001	U0010+U0011+U0012 +U0013+U0015	BAAMP-0072-1G *	1	1B234572-1G	N	B DC, DF
U001	U0010+U0011+U0012 +U0013+U0015	BAAMP-0072-1H *	1	1B234572-1H	N	B MA, MB, MO, MP, MQ, MR, S
U0010	Power amplifier circuit PC board a'ssy	BAAMP-0072-1G	1	1B2345072-1G	N	B DC, DF
U0010	Power amplifier circuit PC board a'ssy	BAAMP-0072-1H	1	1B2345072-1H	N	B MA, MB, MO, MP, MQ, MR, S
U0011	Audio input circuit PC board a'ssy	BAASP-0073-1G	1	1B2345073-1G	N	
U0011	Audio input circuit PC board a'ssy	BAASP-0073-1H	1	1B2345073-1H	N	B MA, MB, MO, MP, MQ, MR, S
U0012	Thermister PC board a'ssy	BAETC-0074-1G	1	---	N	NSP, B DC, DF
U0012	Thermister PC board a'ssy	BAETC-0074-1H	1	---	N	NSP, B MA, MB, MO, MP, MQ, MR, S
U0013	Connection board	BAETC-0075-1G	1	---	N	NSP, B DC, DF
U0013	Connection board	BAETC-0075-1H	1	---	N	NSP, B MA, MB, MO, MP, MQ, MR, S
U0015	AC Inlet terminal PC board a'ssy	BAETC-0089-1G	1	---	N	NSP, B DC, DF
U0015	AC Inlet terminal PC board a'ssy	BAETC-0089-1H	1	---	N	NSP, B MA, MB, MO, MP, MQ, MR, S
U002	U0020+U0021+U0022 +U0023+U0024	BATRM-0083-1G *	1	1B234583-1G	N	B DC, DF, JJ
U002	U0020+U0021+U0022 +U0023+U0024	BATRM-0083-1H *	1	1B234583-1H	N	B MA, MB, MO, MP, MQ, MR, S
U0020	Speaker terminal-1 PC board a'ssy	BATRM-0083-1G	1	1B2345083-1G	N	B DC, DF, JJ
U0020	Speaker terminal-1 PC board a'ssy	BATRM-0083-1H	1	1B2345083-1H	N	B MA, MB, MO, MP, MQ, MR, S
U0021	Primary power supply PC board a'ssy	BAPS-0084-1G	1	1B2345084-1G	N	B DC, DF
U0021	Primary power supply PC board a'ssy	BAPS-0084-1H	1	1B2345084-1H	N	B MA, MB, MO, MP, MQ, MR, S
U0022	Speaker terminal-2 PC board a'ssy	BATRM-0085-1G	1	1B2345085-1G	N	B DC, DF
U0022	Speaker terminal-2 PC board a'ssy	BATRM-0085-1H	1	1B2345085-1H	N	B MA, MB, MO, MP, MQ, MR, S
U0023	Center speaker PC board a'ssy	BATRM-0086-1G	1	1B2345086-1G	N	B DC, DF
U0023	Center speaker PC board a'ssy	BATRM-0086-1H	1	1B2345086-1H	N	B MA, MB, MO, MP, MQ, MR, S
U0024	Power amp. Input circuit PC board a's	BACLA-0087-1G	1	1B2345087-1G	N	B DC, DF
U0024	Power amp. Input circuit PC board a's	BACLA-0087-1H	1	1B2345087-1H	N	B MA, MB, MO, MP, MQ, MR, S
U003	U0030+U0031+U0032+U0033	BADG-0099-1G *	1	1B234599-1G	N	
U003	U0030+U0031+U0032+U0033	BADG-0099-1H *	1	1B234599-1H	N	B DC, DF
U0030	DAC/ DIR circuit PC board a'ssy	BADG-0099-1G	1	1B2345099-1G	N	
U0030	DAC/ DIR circuit PC board a'ssy	BADG-0099-1H	1	1B2345099-1H	N	B DC, DF
U0031	CPU Circuit PC board a'ssy	BACPU-0100-1G	1	1B2345100-1G	N	B DC, DF

U0031	CPU Circuit PC board assy	BACPU-0100-1H	1	1B2345100-1H	N	B MA, MB, MO, MP, MQ, MR, S
U0032	Video circuit PC board assy	BAVD-0101-1G	1	1B2345101-1G	N	B DC, DF
U0032	Video circuit PC board assy	BAVD-0101-1H	1	1B2345101-1H	N	B MA, MB, MO, MP, MQ, MR, S
U0033	Unuversal port PC board assy	BAETC-0103-1G	1	---	N	NSP, B DC, DF
U0033	Unuversal port PC board assy	BAETC-0103-1H	1	---	N	NSP, B MA, MB, MO, MP, MQ, MR, S
U004	U0040+U0041+U0042+U0042 +U0043+U0044+U0045+U0046 +U0047+U0048+U0049+U00410 +U00411+U00412	BADIS-0135-1A *	1	1B234535-1A	N	B DC, DF
U004	U0040+U0041+U0042+U0042 +U0043+U0044+U0045+U0046 +U0047+U0048+U0049+U00410 +U00411+U00412	BADIS-0135-1C *	1	1B234535-1C	N	B JJ, MA, MB, MO, MP, MQ, MR, S
U0040	Display circuit PC board assy	BADIS-0135-1A	1	1B2345135-1A	N	B DC, DF
U0040	Display circuit PC board assy	BADIS-0135-1C	1	1B2345135-1C	N	B JJ, MA, MB, MO, MP, MQ, MR, S
U0041	Standby switch PC board assy	BASW-0136-1A	1	1B2345136-1A	N	B DC, DF
U0041	Standby switch PC board assy	BASW-0136-1C	1	1B2345136-1C	N	B JJ, MA, MB, MO, MP, MQ, MR, S
U0042	Headphone terminal PC board assy	BAETC-0137-1A	1	---	N	NSP, B DC, DF
U0042	Headphone terminal PC board assy	BAETC-0137-1C	1	---	N	NSP, B JJ, MA, MB, MO, MP, MQ, MR, S
U0043	Front digital input PC board assy	BAETC-0138-1A	1	---	N	NSP, B DC, DF
U0043	Front digital input PC board assy	BAETC-0138-1C	1	---	N	NSP, B JJ, MA, MB, MO, MP, MQ, MR, S
U0044	Volume LED PC board assy	BAETC-0139-1A	1	---	N	NSP, B DC, DF
U0044	Volume LED PC board assy	BAETC-0139-1C	1	---	N	NSP, B JJ, MA, MB, MO, MP, MQ, MR, S
U0045	Fuse PC board assy	BAPS-0140-1A	1	1B2345140-1A	N	B DC, DF
U0045	Fuse PC board assy	BAPS-0140-1C	1	1B2345140-1C	N	B JJ, MA, MB, MO, MP, MQ, MR, S
U0046	Support PC board-1	BAETC-0145-1A	1	---	N	NSP, B DC, DF
U0046	Support PC board-1	BAETC-0145-1C	1	---	N	NSP, B JJ, MA, MB, MO, MP, MQ, MR, S
U0047	Support PC board-2	BAETC-0142-1A	1	---	N	NSP, B DC, DF
U0047	Support PC board-2	BAETC-0142-1C	1	---	N	NSP, B JJ, MA, MB, MO, MP, MQ, MR, S
U0048	Support PC board-3	BAETC-0128-1A	1	---	N	NSP, B DC, DF
U0048	Support PC board-3	BAETC-0128-1C	1	---	N	NSP, B JJ, MA, MB, MO, MP, MQ, MR, S
U0049	FFC Support PC board	BAETC-0130-1A	1	---	N	NSP, B DC, DF
U0049	FFC Support PC board	BAETC-0130-1C	1	---	N	NSP, B JJ, MA, MB, MO, MP, MQ, MR, S
U00410	Support PC board-4	BAETC-0144-1A	1	---	N	NSP, B DC, DF
U00410	Support PC board-4	BAETC-0144-1C	1	---	N	NSP, B JJ, MA, MB, MO, MP, MQ, MR, S
U00411	Support PC board-5	BAETC-0129-1A	1	---	N	NSP, B DC, DF
U00411	Support PC board-5	BAETC-0129-1C	1	---	N	NSP, B JJ, MA, MB, MO, MP, MQ, MR, S
U00412	Power switch PC board	BASW-0143-1C	1	1B2345143-1C	N	B JJ, MA, MB, MO, MP, MQ, MR, S
U005	HDMI Circuit PC board assy	BAHDM-0132-1B	1	1B234532-1B	N	
U011	TUNER UNIT	FAEH06-E01EX	1	240165	B MA, MB, MO, MP, MQ, MR, S	
U011	TUNER UNIT	FAEH06-A01US	1	240166	B DC, DF	

PACKING VIEW PARTS LIST

TX-NR807

[PACKING]									
A651	PAD	AS807	1	29092465A					
A655	SHEET	(ACC)	1	29096104					
A657	SHEET	T0 515*1300*900	1	29096066					
A661	POLY BAG	(W1020xD770)	1	29100253					
A663	TAPE	(SEROHAN)NITTO NO.29	1	29110149					
A665	PP TAPE	W50 SBT-70	1	29110200					
A667	STAPLE	FUKAN-BARI(1000KO)	4	282321					
A701	CARTON	807DC	1	29055013A		N B DC, DF			
A701	CARTON	807PP	1	29055014A		N B MA, MB, MO, MP, MQ, MR, S			
A702	LABEL	(CARTON)	1	29390944		B MR			
A704A	UPC LABEL	807BMDC	{1}	29390802		N B DC			
A704A	EAN LABEL	807BMDF	{1}	29390803		N B DF			
A704A	EAN LABEL	807BMMO	{1}	29390806		N B MO			
A704A	EAN LABEL	807SMMO	{1}	29390807		N S MO			
A704A	EAN LABEL	807BMMMP	{1}	29390808		N B MP			
A704A	EAN LABEL	807SMMMP	{1}	29390809		N S MP			
A704A	EAN LABEL	807BMMQ	{1}	29390810		N B MQ			
A704A	EAN LABEL	TX-NR807(B)MMB	{1}	29390999		N B MB			
A704A	EAN LABEL	TX-NR807(S)MMB	{1}	29391000		N S MB			
A704A	EAN LABEL	807BMMMA	{1}	29390804A		N B MA			
A704A	EAN LABEL	807SMMMA	{1}	29390805A		N S MA			
A704A	EAN LABEL	807BMMMR	{1}	29390949A		N B MR			
[ACCESSARY]									
A801	LABEL	(SPCABLE)2009	1	29390881					
A810	BATTERY	R6/AA(UM-3)	2	3010194		Except MR			
A810or	BATTERY	R6/AA(UM-3)	(2)	3010054		Except MR			
A811	REMO CON	RC-743M	1	24140743		B			
A811	REMO CON	RC-745M	1	24140745		N			
A812	ANT COIL	NMA-3057	1	232140					
A813	FM ANT AS	Type W	1	292191					
A814	MIC	MIC-7000	1	245044					
A820	TAPE	(SEROHAN)NITTO NO.29	1	29110149					
A821	POLY BAG	w250xd350	1	29100250A					
A850	POLY BAG	w250xd350	1	29100250A		B DC			
A850	POLY BAG	w250xd350	2	29100250A		B MP, S MP			
A851	WRNTY CARD	(ONKYO)	1	29365135		B DC			

A852	WRNTY CARD	MGQ	1	29365099A	B MQ
A853	WRNTY CARD	(ONKYO-CH)	1	29365098B	B MR
A861	INS MANUAL	En(TX-NR807)	1	29400021	N
A862	INS MANUAL	U2FtEs(TX-NR807)	1	29400022	N B DC, MP, S MP
A863	INS MANUAL	U2HDe(TX-NR807)	1	29400023	N B MP, S MP
A864	INS MANUAL	U2NISv(TX-NR807)	1	29400024	N B MP, S MP
A866	INS MANUAL	Ct(TX-NR807)	1	29400026	N B DF, MQ, S MO
A867	INS MANUAL	Cs(TX-NR807)	1	29400027	B MR
A869	INS MANUAL	Ar(TX-NR807)	1	29400029	N B MQ, S MO
A870	INS MANUAL	U3EnFtEs(SIRIUS)	1	29400030A	N B DC
A871	INS MANUAL	En(QSS)(TX-NR807)	1	29400031	N
A872	INS MANUAL	Cs(QSS)(TX-NR807)	1	29400032	B MR
A874	INS MANUAL	(QC ImportantSheet)	1	29344267A	B MQ, S MO
A875	INS MANUAL	U9RC736/737/738/739)	1	29344962	
A876	INS MANUAL	U2JatEn(Software_807/HT-RC180)	1	29400164	
A877	INS MANUAL	U3EnFtEs(Pand/Rhap/InsSir_ONK)	1	29400165	B DC
A878	INS MANUAL	U2Ende(last_fm_807/HT-RC180)	1	29400166	N B MB, MP, S MB, MP
A880	INST SHEET	CHINA ROHS	1	29355616A	B MR
A881	INST SHEET	WEEE	1	29355537A	B MB, MP, S MB, MP
A882	HANDBILL	(SIRIUS)	1	29380149	B DC
A883	INST SHEET	En(2009E_RIHD)	1	29355745	
A884	INST SHEET	U2FtEs(2009E_RIHD)	1	29355746	B DC
A885	INST SHEET	U8(2009E_RIHD)	1	29355747	B DF, MA, MB, MQ, MP, MQ, MR, S
A887	INST SHEET	Ct(CHUISI_MDF)	1	29355749	B DF
A890	HANDBILL	(UP-A1)US	1	29380155	N B DC
A890	HANDBILL	(UP-A1)EU	1	29380156	N B MB, MP, S MB, MP
P901	AC CORD	AS-CEE-3	1	253298VOL	! B MQ, MP, S MQ, MP
P901	AC CORD	AS-UC-2	1	253352ATES	! B DC
P901 or	AC CORD	AS-UC-2	(1)	253297KAW	! B DC
P901	AC CORD	AS-CCC	1	253358VOL	! B MR
P901	AC CORD	AS-SAA	1	253391VOL	! B MA, S MA
P901	AC CORD	AS-BS	1	253425YUN	! B MB, MQ, S MB
P901 or	AC CORD	AS-BS	(1)	253425KAW	! B M MB
P901	AC CORD	AS-CNS	1	253432VOL	! B DF
P903	CV PLUG	SCP-13A-BLK(UK)	1	25056591	! B MQ, S MO

PRINTED CIRCUIT BOARD PARTS LIST

TX-NR807

U001

Power amplifier circuit PC board BAAMP-0072-1G

N B DC, DF

U001	Power amplifier circuit PC board	BAAMP-0072-1H				N B MA, MB, MO, MP, MQ, MR, S
U0011	Audio input circuit PC board a'ss	BAASP-0073-1G				N NSP
U0011	Audio input circuit PC board a'ss	BAASP-0073-1H				N NSP, B MA, MB, MO, MP, MQ, MR, S
U0012	Thermister PC board a'ssy	BAETC-0074-1G				N NSP, B DC, DF
U0012	Thermister PC board a'ssy	BAETC-0074-1H				N NSP, B MA, MB, MO, MP, MQ, MR, S
U0013	Connection board	BAETC-0075-1G				N NSP, B DC, DF
U0013	Connection board	BAETC-0075-1H				N NSP, B MA, MB, MO, MP, MQ, MR, S
U0015	AC Inlet terminal PC board a'ssy	BAETC-0089-1G				NSP, B DC, DF
U0015	AC Inlet terminal PC board a'ssy	BAETC-0089-1H				NSP, B MA, MB, MO, MP, MQ, MR, S

CIRCUIT. NO.	PART NAME	DESCRIPTION	QTY	PART NO. (SN)	REMARKS
[SEMI CONDUCTOR]					
D4600	C-DIODE	ISS352	1	223234R2	< DC, D, MA, MB, MO, MP, MQ, MR, >
D4601	C-DIODE	ISS352	1	223234R2	< DC, D, MA, MB, MO, MP, MQ, MR, >
D4602	C-DIODE	ISS352	1	223234R2	< DC, D, MA, MB, MO, MP, MQ, MR, >
D4603	C-DIODE	ISS352	1	223234R2	< DC, D, MA, MB, MO, MP, MQ, MR, >
D4606	DIODE	RL1N4003	1	22380260T	< DC, D, MA, MB, MO, MP, MQ, MR, >
D5500	ZENER D	MTZJ7.5B	1	224470752T	< B, >
D5501	ZENER D	MTZJ7.5B	1	224470752T	< B, >
D5502	ZENER D	MTZJ3.6B	1	224470362T	< DC, D, MA, MB, MO, MP, MQ, MR, >
D5507	C-DIODE	ISS352	1	223234R2	< B, >
D5507 or	C-DIODE	ISS355	(1)	223269R2	< B, >
D5507 or	C-DIODE	KDS4148U	(1)	223283R2	< B, >
D5507 or	C-DIODE	MA2J1110GL	(1)	223302R2	< B, >
D5508	C-DIODE	ISS352	1	223234R2	< B, >
D5508 or	C-DIODE	ISS355	(1)	223269R2	< B, >
D5508 or	C-DIODE	KDS4148U	(1)	223283R2	< B, >
D5508 or	C-DIODE	MA2J1110GL	(1)	223302R2	< B, >
D5511	C-DIODE	ISS352	1	223234R2	< DC, D, MA, MB, MO, MP, MQ, MR, >
D5512	C-DIODE	ISS352	1	223234R2	< DC, D, MA, MB, MO, MP, MQ, MR, >
D5513	C-DIODE	ISS352	1	223234R2	< B, >
D5514	C-DIODE	ISS352	1	223234R2	< B, >
D5517	C-DIODE	ISS352	1	223234R2	< B, >
D5517 or	C-DIODE	ISS355	(1)	223269R2	< B, >
D5517 or	C-DIODE	KDS4148U	(1)	223283R2	< B, >
D5517 or	C-DIODE	MA2J1110GL	(1)	223302R2	< B, >
D5518	C-DIODE	ISS352	1	223234R2	< B, >
D5518 or	C-DIODE	ISS355	(1)	223269R2	< B, >
D5518 or	C-DIODE	KDS4148U	(1)	223283R2	< B, >
D5518 or	C-DIODE	MA2J1110GL	(1)	223302R2	< B, >

D5520	C-DIODE	ISS352	1	223234R2	< B, >
D5521	ZENER D	UDZS8.2B	1	224550820R2	< B, >
D5522	ZENER D	UDZS3.6B	1	224550360R2	< B, >
D5523	C-DIODE	ISS352	1	223234R2	< B, >
D5601	C-DIODE	S1NB60-4062	1	22380318R2	< B, >
D6000	C-DIODE	ISS352	1	223234R2	< DC, D, MA, MB, MO, MP, MQ, MR, J>
D6000 or	C-DIODE	ISS355	(1)	223269R2	< DC, D, MA, MB, MO, MP, MQ, MR, J>
D6000 or	C-DIODE	KDS4148U	(1)	223283R2	< DC, D, MA, MB, MO, MP, MQ, MR, J>
D6000 or	C-DIODE	MA2J1110GL	(1)	223302R2	< DC, D, MA, MB, MO, MP, MQ, MR, J>
D6001	C-DIODE	ISS352	1	223234R2	< DC, D, MA, MB, MO, MP, MQ, MR, J>
D6001 or	C-DIODE	ISS355	(1)	223269R2	< DC, D, MA, MB, MO, MP, MQ, MR, J>
D6001 or	C-DIODE	KDS4148U	(1)	223283R2	< DC, D, MA, MB, MO, MP, MQ, MR, J>
D6001 or	C-DIODE	MA2J1110GL	(1)	223302R2	< DC, D, MA, MB, MO, MP, MQ, MR, J>
D6002	C-DIODE	ISS352	1	223234R2	< DC, D, MA, MB, MO, MP, MQ, MR, J>
D6002 or	C-DIODE	ISS355	(1)	223269R2	< DC, D, MA, MB, MO, MP, MQ, MR, J>
D6002 or	C-DIODE	KDS4148U	(1)	223283R2	< DC, D, MA, MB, MO, MP, MQ, MR, J>
D6002 or	C-DIODE	MA2J1110GL	(1)	223302R2	< DC, D, MA, MB, MO, MP, MQ, MR, J>
D6003	C-DIODE	ISS352	1	223234R2	< DC, D, MA, MB, MO, MP, MQ, MR, J>
D6003 or	C-DIODE	ISS355	(1)	223269R2	< DC, D, MA, MB, MO, MP, MQ, MR, J>
D6003 or	C-DIODE	KDS4148U	(1)	223283R2	< DC, D, MA, MB, MO, MP, MQ, MR, J>
D6003 or	C-DIODE	MA2J1110GL	(1)	223302R2	< DC, D, MA, MB, MO, MP, MQ, MR, J>
D6004	C-DIODE	ISS352	1	223234R2	< DC, D, MA, MB, MO, MP, MQ, MR, J>
D6004 or	C-DIODE	ISS355	(1)	223269R2	< DC, D, MA, MB, MO, MP, MQ, MR, J>
D6004 or	C-DIODE	KDS4148U	(1)	223283R2	< DC, D, MA, MB, MO, MP, MQ, MR, J>
D6004 or	C-DIODE	MA2J1110GL	(1)	223302R2	< DC, D, MA, MB, MO, MP, MQ, MR, J>
D6005	C-DIODE	ISS352	1	223234R2	< DC, D, MA, MB, MO, MP, MQ, MR, J>
D6005 or	C-DIODE	ISS355	(1)	223269R2	< DC, D, MA, MB, MO, MP, MQ, MR, J>
D6005 or	C-DIODE	KDS4148U	(1)	223283R2	< DC, D, MA, MB, MO, MP, MQ, MR, J>
D6005 or	C-DIODE	MA2J1110GL	(1)	223302R2	< DC, D, MA, MB, MO, MP, MQ, MR, J>
D6006	C-DIODE	ISS352	1	223234R2	< DC, D, MA, MB, MO, MP, MQ, MR, J>
D6006 or	C-DIODE	ISS355	(1)	223269R2	< DC, D, MA, MB, MO, MP, MQ, MR, J>
D6006 or	C-DIODE	KDS4148U	(1)	223283R2	< DC, D, MA, MB, MO, MP, MQ, MR, J>
D6006 or	C-DIODE	MA2J1110GL	(1)	223302R2	< DC, D, MA, MB, MO, MP, MQ, MR, J>
D6701	C-DIODE	ISS352	1	223234R2	< DC, D, MA, MB, MO, MP, MQ, MR, J>
D6701 or	C-DIODE	ISS355	(1)	223269R2	< DC, D, MA, MB, MO, MP, MQ, MR, J>
D6701 or	C-DIODE	KDS4148U	(1)	223283R2	< DC, D, MA, MB, MO, MP, MQ, MR, J>
D6701 or	C-DIODE	MA2J1110GL	(1)	223302R2	< DC, D, MA, MB, MO, MP, MQ, MR, J>
D6702	C-DIODE	ISS352	1	223234R2	< DC, D, MA, MB, MO, MP, MQ, MR, J>
D6702 or	C-DIODE	ISS355	(1)	223269R2	< DC, D, MA, MB, MO, MP, MQ, MR, J>

D6702 or	C-DIODE	KDS4148U	(1)	223283R2	< DC, D, MA, MB, MO, MP, MQ, MR, J>
D6702 or	C-DIODE	MA2J1110GL	(1)	223302R2	< DC, D, MA, MB, MO, MP, MQ, MR, J>
D6703	ZENER D	UDZS3.6B	1	224550360R2	< DC, D, MA, MB, MO, MP, MQ, MR, J>
D6704	ZENER D	UDZS3.6B	1	224550360R2	< DC, D, MA, MB, MO, MP, MQ, MR, J>
D6713	ZENER D	UDZS3.6B	1	224550360R2	< DC, D, MA, MB, MO, MP, MQ, MR, J>
D6901	DIODE	D10XB60H	1	22380337	< DC, D, MA, MB, MO, MP, MQ, MR, J>
D6901A	HEAT SINK	RAAD-152	1	27160483	< DC, D, MA, MB, MO, MP, MQ, MR, J>
D6901B	TAPE	TAPE(CLOTH-8U)	1	29110082	< DC, D, MA, MB, MO, MP, MQ, MR, J>
D6901C	SCREW	3P+10FN(3BC)	2	82143010GR	< DC, D, MA, MB, MO, MP, MQ, MR, J>
D6902	C-DIODE	ISS352	1	223234R2	< DC, D, MA, MB, MO, MP, MQ, MR, J>
D6902 or	C-DIODE	ISS355	(1)	223269R2	< DC, D, MA, MB, MO, MP, MQ, MR, J>
D6902 or	C-DIODE	KDS4148U	(1)	223283R2	< DC, D, MA, MB, MO, MP, MQ, MR, J>
D6902 or	C-DIODE	MA2J1110GL	(1)	223302R2	< DC, D, MA, MB, MO, MP, MQ, MR, J>
D6903	DIODE	D10XB60H	1	22380337	< DC, D, MA, MB, MO, MP, MQ, MR, J>
Q4600	TR	2SB1240-R	1	2213794T	< DC, D, MA, MB, MO, MP, MQ, MR, J>
Q4601	TR	KRC102S	1	2216190R2	< DC, D, MA, MB, MO, MP, MQ, MR, J>
Q4602	TR	2SA1162-GR	1	2214375R2	< DC, D, MA, MB, MO, MP, MQ, MR, J>
Q4603	TR	KRC102S	1	2216190R2	< DC, D, MA, MB, MO, MP, MQ, MR, J>
Q5501	IC	R2A15220FP	1	22242600R3	N < B, >
Q5502	IC	M61540FP	1	22242497R2	< DC, D, MA, MB, MO, MP, MQ, MR, J>
Q5503	IC	NJM4580M-D	1	22241448R2	< B, >
Q5600	TR	RN1441	1	2215410R2	< DC, D, MA, MB, MO, MP, MQ, MR, J>
Q5601	TR	RN1441	1	2215410R2	< DC, D, MA, MB, MO, MP, MQ, MR, J>
Q5602	TR	RN1441	1	2215410R2	< DC, D, MA, MB, MO, MP, MQ, MR, J>
Q5603	TR	RN1441	1	2215410R2	< DC, D, MA, MB, MO, MP, MQ, MR, J>
Q5604	TR	RN1441	1	2215410R2	< DC, D, MA, MB, MO, MP, MQ, MR, J>
Q5605	TR	RN1441	1	2215410R2	< DC, D, MA, MB, MO, MP, MQ, MR, J>
Q5606	TR	RN1441	1	2215410R2	< B, >
Q5607	TR	RN1441	1	2215410R2	< B, >
Q5610	TR	RN1441	1	2215410R2	< DC, D, MA, MB, MO, MP, MQ, MR, J>
Q5611	TR	RN1441	1	2215410R2	< DC, D, MA, MB, MO, MP, MQ, MR, J>
Q5612	TR	RN1441	1	2215410R2	< DC, D, MA, MB, MO, MP, MQ, MR, J>
Q5613	TR	RN1441	1	2215410R2	< DC, D, MA, MB, MO, MP, MQ, MR, J>
Q5614	TR	RN1441	1	2215410R2	< DC, D, MA, MB, MO, MP, MQ, MR, J>
Q5615	TR	RN1441	1	2215410R2	< DC, D, MA, MB, MO, MP, MQ, MR, J>
Q5616	TR	RN1441	1	2215410R2	< B, >
Q5617	TR	RN1441	1	2215410R2	< B, >
Q5618	IC	NJM4580M-D	1	22241448R2	< B, >
Q5630	IC	NJM4580M-D	1	22241448R2	< B, >

Q5632	TR	RN1441	1	2215410R2	< B, >
Q5633	TR	RN1441	1	2215410R2	< B, >
Q5636	TR	RN1441	1	2215410R2	< B, >
Q5637	TR	RN1441	1	2215410R2	< B, >
Q5640	TR	RN1441	1	2215410R2	< B, >
Q5641	TR	RN1441	1	2215410R2	< B, >
Q5645	TR	2SC2712-GR	1	2213145R2	< B, >
Q5646	TR	2SC2712-GR	1	2213145R2	< B, >
Q5647	TR	2SA1162-GR	1	2214375R2	< B, >
Q5670	IC	78M15HF(NJM78M15FA)	1	222780155JRC	< B, >
Q5670 or	IC	UPC78M15AHF-AZ	(1)	222780155NEC	< B, >
Q5670A	HEAT SINK	RAID-252	1	27160641	N < B, >
Q5670B	SCREW	3P+10FN(3BC)	2	82143010GR	< B, >
Q5671	IC	79M15HF(NJM79M15FA)	1	222790155JRC	< B, >
Q5671 or	IC	79M15F(AN79M15F)	(1)	222790155MAT	< B, >
Q5671 or	IC	UPC79M15HF-AZ	(1)	222790155NEC	< B, >
Q5684	TR	2SC2235-O(TPE6_F)	1	2211653T	< B, >
Q5685	TR	2SA965-O(TPE6_F)	1	2211643T	< B, >
Q5708	TR	RN1441	1	2215410R2	< DC, D, MA, MB, MO, MP, MQ, MR, >
Q5709	TR	RN1441	1	2215410R2	< DC, D, MA, MB, MO, MP, MQ, MR, >
Q5903	TR	RN1441	1	2215410R2	< DC, D, MA, MB, MO, MP, MQ, MR, >
Q5904	TR	RN1441	1	2215410R2	< DC, D, MA, MB, MO, MP, MQ, MR, >
Q6000	TR	2SC1740S-S	1	2213285T	< DC, D, MA, MB, MO, MP, MQ, MR, >
Q6001	TR	2SC1740S-S	1	2213285T	< DC, D, MA, MB, MO, MP, MQ, MR, >
Q6002	TR	2SC1740S-S	1	2213285T	< DC, D, MA, MB, MO, MP, MQ, MR, >
Q6003	TR	2SC1740S-S	1	2213285T	< DC, D, MA, MB, MO, MP, MQ, MR, >
Q6004	TR	2SC1740S-S	1	2213285T	< DC, D, MA, MB, MO, MP, MQ, MR, >
Q6005	TR	2SC1740S-S	1	2213285T	< DC, D, MA, MB, MO, MP, MQ, MR, >
Q6006	TR	2SC1740S-S	1	2213285T	< DC, D, MA, MB, MO, MP, MQ, MR, >
Q6010	TR	2SC1740S-S	1	2213285T	< DC, D, MA, MB, MO, MP, MQ, MR, >
Q6011	TR	2SC1740S-S	1	2213285T	< DC, D, MA, MB, MO, MP, MQ, MR, >
Q6012	TR	2SC1740S-S	1	2213285T	< DC, D, MA, MB, MO, MP, MQ, MR, >
Q6013	TR	2SC1740S-S	1	2213285T	< DC, D, MA, MB, MO, MP, MQ, MR, >
Q6014	TR	2SC1740S-S	1	2213285T	< DC, D, MA, MB, MO, MP, MQ, MR, >
Q6015	TR	2SC1740S-S	1	2213285T	< DC, D, MA, MB, MO, MP, MQ, MR, >
Q6016	TR	2SC1740S-S	1	2213285T	< DC, D, MA, MB, MO, MP, MQ, MR, >
Q6030	TR	2SC2229-Y(TPE6_F)	1	2211634T	< DC, D, MA, MB, MO, MP, MQ, MR, >
Q6030 or	TR	2SC2229-O(TPE6_F)	(1)	2211633T	< DC, D, MA, MB, MO, MP, MQ, MR, >
Q6031	TR	2SC2229-Y(TPE6_F)	1	2211634T	< DC, D, MA, MB, MO, MP, MQ, MR, >

Q6100	TR	2SA1930(ONK_Q)	1	2203000	< DC, D, MA, MB, MO, MP, MQ, MR, J>
Q6100 or	TR	2SA2140-Q_P	(1)	2217151	< DC, D, MA, MB, MO, MP, MQ, MR, J>
Q6101	TR	2SA1930(ONK_Q)	1	2203000	< DC, D, MA, MB, MO, MP, MQ, MR, J>
Q6101 or	TR	2SA2140-Q_P	(1)	2217151	< DC, D, MA, MB, MO, MP, MQ, MR, J>
Q6102	TR	2SA1930(ONK_Q)	1	2203000	< DC, D, MA, MB, MO, MP, MQ, MR, J>
Q6102 or	TR	2SA2140-Q_P	(1)	2217151	< DC, D, MA, MB, MO, MP, MQ, MR, J>
Q6103	TR	2SA1930(ONK_Q)	1	2203000	< DC, D, MA, MB, MO, MP, MQ, MR, J>
Q6103 or	TR	2SA2140-Q_P	(1)	2217151	< DC, D, MA, MB, MO, MP, MQ, MR, J>
Q6104	TR	2SA1930(ONK_Q)	1	2203000	< DC, D, MA, MB, MO, MP, MQ, MR, J>
Q6104 or	TR	2SA2140-Q_P	(1)	2217151	< DC, D, MA, MB, MO, MP, MQ, MR, J>
Q6105	TR	2SA1930(ONK_Q)	1	2203000	< DC, D, MA, MB, MO, MP, MQ, MR, J>
Q6105 or	TR	2SA2140-Q_P	(1)	2217151	< DC, D, MA, MB, MO, MP, MQ, MR, J>
Q6106	TR	2SA1930(ONK_Q)	1	2203000	< DC, D, MA, MB, MO, MP, MQ, MR, J>
Q6106 or	TR	2SA2140-Q_P	(1)	2217151	< DC, D, MA, MB, MO, MP, MQ, MR, J>
Q6110	TR	2SC5171(ONK_Q)	1	2203010	< DC, D, MA, MB, MO, MP, MQ, MR, J>
Q6110 or	TR	2SC5993-Q_P	(1)	2217161	< DC, D, MA, MB, MO, MP, MQ, MR, J>
Q6111	TR	2SC5171(ONK_Q)	1	2203010	< DC, D, MA, MB, MO, MP, MQ, MR, J>
Q6111 or	TR	2SC5993-Q_P	(1)	2217161	< DC, D, MA, MB, MO, MP, MQ, MR, J>
Q6112	TR	2SC5171(ONK_Q)	1	2203010	< DC, D, MA, MB, MO, MP, MQ, MR, J>
Q6112 or	TR	2SC5993-Q_P	(1)	2217161	< DC, D, MA, MB, MO, MP, MQ, MR, J>
Q6113	TR	2SC5171(ONK_Q)	1	2203010	< DC, D, MA, MB, MO, MP, MQ, MR, J>
Q6113 or	TR	2SC5993-Q_P	(1)	2217161	< DC, D, MA, MB, MO, MP, MQ, MR, J>
Q6114	TR	2SC5171(ONK_Q)	1	2203010	< DC, D, MA, MB, MO, MP, MQ, MR, J>
Q6114 or	TR	2SC5993-Q_P	(1)	2217161	< DC, D, MA, MB, MO, MP, MQ, MR, J>
Q6115	TR	2SC5171(ONK_Q)	1	2203010	< DC, D, MA, MB, MO, MP, MQ, MR, J>
Q6115 or	TR	2SC5993-Q_P	(1)	2217161	< DC, D, MA, MB, MO, MP, MQ, MR, J>
Q6116	TR	2SC5171(ONK_Q)	1	2203010	< DC, D, MA, MB, MO, MP, MQ, MR, J>
Q6116 or	TR	2SC5993-Q_P	(1)	2217161	< DC, D, MA, MB, MO, MP, MQ, MR, J>
Q6380	IC	LM61CIZ	1	22242212	< DC, D, MA, MB, MO, MP, MQ, MR, J>
Q6380A	RETAINER	(PTH)	1	27141884-1	< DC, D, MA, MB, MO, MP, MQ, MR, J>
Q6701	TR	2SC2712-GR	1	2213145R2	< DC, D, MA, MB, MO, MP, MQ, MR, J>
Q6701 or	TR	KTC3875-GR	(1)	2216175R2	< DC, D, MA, MB, MO, MP, MQ, MR, J>
Q6702	TR	2SC2712-GR	1	2213145R2	< DC, D, MA, MB, MO, MP, MQ, MR, J>
Q6702 or	TR	KTC3875-GR	(1)	2216175R2	< DC, D, MA, MB, MO, MP, MQ, MR, J>
Q6703	TR	2SA1163-BL(TE85L_F)	1	2216756R2	< DC, D, MA, MB, MO, MP, MQ, MR, J>
Q6707	TR	2SC2712-GR	1	2213145R2	< DC, D, MA, MB, MO, MP, MQ, MR, J>
Q6707 or	TR	KTC3875-GR	(1)	2216175R2	< DC, D, MA, MB, MO, MP, MQ, MR, J>
Q6713	TR	2SA1163-BL(TE85L_F)	1	2216756R2	< DC, D, MA, MB, MO, MP, MQ, MR, J>

[TRANS COIL]

L4602	EMFIL	BK1608LM182-T	1	230958R1	< DC, D, MA, MB, MO, MP, MQ, MR, >
L4603	EMFIL	BK1608LM182-T	1	230958R1	< DC, D, MA, MB, MO, MP, MQ, MR, >
L6000	FR CORE	*	1	5597-45502	< DC, D, MA, MB, MO, MP, MQ, MR, J >
L6001	FR CORE	*	1	5597-45502	< DC, D, MA, MB, MO, MP, MQ, MR, J >
L6002	FR CORE	*	1	5597-45502	< DC, D, MA, MB, MO, MP, MQ, MR, J >
L6003	FR CORE	*	1	5597-45502	< DC, D, MA, MB, MO, MP, MQ, MR, J >
L6004	FR CORE	*	1	5597-45502	< DC, D, MA, MB, MO, MP, MQ, MR, J >
L6005	FR CORE	*	1	5597-45502	< DC, D, MA, MB, MO, MP, MQ, MR, J >
L6006	FR CORE	*	1	5597-45502	< DC, D, MA, MB, MO, MP, MQ, MR, J >
L6010	FR CORE	*	1	5597-45502	< DC, D, MA, MB, MO, MP, MQ, MR, J >
L6011	FR CORE	*	1	5597-45502	< DC, D, MA, MB, MO, MP, MQ, MR, J >
L6012	FR CORE	*	1	5597-45502	< DC, D, MA, MB, MO, MP, MQ, MR, J >
L6013	FR CORE	*	1	5597-45502	< DC, D, MA, MB, MO, MP, MQ, MR, J >
L6014	FR CORE	*	1	5597-45502	< DC, D, MA, MB, MO, MP, MQ, MR, J >
L6015	FR CORE	*	1	5597-45502	< DC, D, MA, MB, MO, MP, MQ, MR, J >
L6016	FR CORE	*	1	5597-45502	< DC, D, MA, MB, MO, MP, MQ, MR, J >

[CAPACITORS]

C4604	C-CERA C	CG725CH1H-101J1	1	342101014R1	< DC, D, MA, MB, MO, MP, MQ, MR, >
C4605	C-CERA C	CK725F1E-104Z1	1	332161040R1	< DC, D, MA, MB, MO, MP, MQ, MR, >
C5501	C-CERA C	CG725CH1H-221J1	1	342102214R1	< J >
C5502	C-CERA C	CG725CH1H-221J1	1	342102214R1	< J >
C5503	UPZ C	2AUPZTF221JE	1	376332214T	< B, >
C5504	UPZ C	2AUPZTF221JE	1	376332214T	< B, >
C5505	C-CERA C	CG725CH1H-221J1	1	342102214R1	< B, >
C5506	C-CERA C	CG725CH1H-221J1	1	342102214R1	< B, >
C5507	C-CERA C	CG725CH1H-221J1	1	342102214R1	< B, >
C5508	C-CERA C	CG725CH1H-221J1	1	342102214R1	< B, >
C5509	C-CERA C	CG725CH1H-221J1	1	342102214R1	< B, >
C5510	C-CERA C	CG725CH1H-221J1	1	342102214R1	< B, >
C5511	C-CERA C	CG725CH1H-221J1	1	342102214R1	< B, >
C5512	C-CERA C	CG725CH1H-221J1	1	342102214R1	< B, >
C5513	C-CERA C	CG725CH1H-221J1	1	342102214R1	< B, >
C5514	C-CERA C	CG725CH1H-221J1	1	342102214R1	< B, >
C5515	C-CERA C	CG725CH1H-221J1	1	342102214R1	< B, >
C5516	C-CERA C	CG725CH1H-221J1	1	342102214R1	< B, >
C5517	UTSP C	CE04W10V-470M(UTSP)	1	397534717T	< DC, D, MA, MB, MO, MP, MQ, MR, >
C5518	UTSP C	CE04W10V-470M(UTSP)	1	397534717T	< DC, D, MA, MB, MO, MP, MQ, MR, >
C5519	UPZ C	2AUPZTF221JE	1	376332214T	< B, >
C5520	UPZ C	2AUPZTF221JE	1	376332214T	< B, >

C5527	C-CERA C	CG725CH1H-221J1	1	342102214R1	< B, >
C5528	C-CERA C	CG725CH1H-221J1	1	342102214R1	< B, >
C5529	C-CERA C	CG725CH1H-221J1	1	342102214R1	< B, >
C5530	C-CERA C	CG725CH1H-221J1	1	342102214R1	< B, >
C5531	C-CERA C	CG725CH1H-221J1	1	342102214R1	< B, >
C5532	C-CERA C	CG725CH1H-221J1	1	342102214R1	< B, >
C5533	C-CERA C	CG725CH1H-221J1	1	342102214R1	< B, >
C5534	C-CERA C	CG725CH1H-221J1	1	342102214R1	< B, >
C5535	UTSP C	CE04W25V-47M(UTSP)	1	397554707T	< DC, D, MA, MB, MO, MP, MQ, MR, >
C5536	UTSP C	CE04W25V-47M(UTSP)	1	397554707T	< DC, D, MA, MB, MO, MP, MQ, MR, >
C5540	UTSP C	CE04W50V-10M(UTSP)	1	397581007T	< DC, D, MA, MB, MO, MP, MQ, MR, >
C5541	UTSP C	CE04W50V-10M(UTSP)	1	397581007T	< DC, D, MA, MB, MO, MP, MQ, MR, >
C5542	UTSP C	CE04W50V-10M(UTSP)	1	397581007T	< DC, D, >
C5543	UTSP C	CE04W50V-10M(UTSP)	1	397581007T	< DC, D, >
C5548	C-CERA C	CK725F1E-104Z1	1	332161040R1	< B, >
C5549	C-CERA C	CK725F1E-104Z1	1	332161040R1	< B, >
C5550	C-CERA C	CK725B1H-152K1	1	332101525R1	< B, >
C5551	C-CERA C	CK725B1H-152K1	1	332101525R1	< B, >
C5555	UTSP C	CE04W25V-47M(UTSP)	1	397554707T	< B, >
C5559	TF C	ECQ-V50V-473J	1	374724734T	< B, >
C5560	TF C	ECQ-V50V-473J	1	374724734T	< B, >
C5561	TF C	ECQ-V50V-224J	1	374722244T	< B, >
C5562	TF C	ECQ-V50V-224J	1	374722244T	< B, >
C5563	TF C	ECQ-V50V-223J	1	374722234T	< B, >
C5564	TF C	ECQ-V50V-223J	1	374722234T	< B, >
C5569	UTSP C	CE04W50V-47M(UTSP)	1	397584707T	< B, >
C5570	UTSP C	CE04W50V-47M(UTSP)	1	397584707T	< B, >
C5571	UTSP C	CE04W50V-47M(UTSP)	1	397584707T	< B, >
C5572	UTSP C	CE04W50V-47M(UTSP)	1	397584707T	< B, >
C5573	UTSP C	CE04W50V-47M(UTSP)	1	397584707T	< B, >
C5574	UTSP C	CE04W50V-47M(UTSP)	1	397584707T	< B, >
C5575	UTSP C	CE04W50V-47M(UTSP)	1	397584707T	< B, >
C5576	UTSP C	CE04W50V-47M(UTSP)	1	397584707T	< B, >
C5579	C-CERA C	CG725CH1H-102J1	1	342101024R1	< B, >
C5580	UTSP C	CE04W10V-470M(UTSP)	1	397534717T	< B, >
C5581	UTSP C	CE04W10V-470M(UTSP)	1	397534717T	< B, >
C5582	C-CERA C	CG725CH1H-102J1	1	342101024R1	< B, >
C5583	C-CERA C	CG725CH1H-102J1	1	342101024R1	< B, >
C5584	UTSP C	CE04W25V-47M(UTSP)	1	397554707T	< B, >

C5585	UTSP C	CE04W25V-47M(UTSP)	1	397554707T	< B, >
C5586	UTSP C	CE04W10V-220M(UTSP)	1	397532217T	< B, >
C5587	UTSP C	CE04W10V-220M(UTSP)	1	397532217T	< B, >
C5588	TF C	ECQ-V50V-123J	1	374721234T	< B, >
C5589	TF C	ECQ-V50V-123J	1	374721234T	< B, >
C5590	C-CERA C	CC725CH1H-101J1	1	342101014R1	< B, >
C5591	C-CERA C	CC725CH1H-101J1	1	342101014R1	< B, >
C5592	MKT C	B32529C0332J289	1	376493324T	< B, >
C5593	MKT C	B32529C0332J289	1	376493324T	< B, >
C5594	C-CERA C	CC725CH1H-101J1	1	342101014R1	< B, >
C5595	C-CERA C	CC725CH1H-101J1	1	342101014R1	< B, >
C5596	UTSP C	CE04W50V-10M(UTSP)	1	397581007T	< B, >
C5597	UTSP C	CE04W50V-10M(UTSP)	1	397581007T	< B, >
C5598	C-CERA C	CC725CH1H-102J1	1	342101024R1	< B, >
C5600	UTSP C	CE04W50V-47M(UTSP)	1	397584707T	< DC, D, MA, MB, MO, MP, MQ, MR, J >
C5601	UTSP C	CE04W50V-47M(UTSP)	1	397584707T	< DC, D, MA, MB, MO, MP, MQ, MR, J >
C5602	UTSP C	CE04W50V-47M(UTSP)	1	397584707T	< DC, D, MA, MB, MO, MP, MQ, MR, J >
C5603	UTSP C	CE04W50V-47M(UTSP)	1	397584707T	< DC, D, MA, MB, MO, MP, MQ, MR, J >
C5604	UTSP C	CE04W50V-47M(UTSP)	1	397584707T	< DC, D, MA, MB, MO, MP, MQ, MR, J >
C5605	UTSP C	CE04W50V-47M(UTSP)	1	397584707T	< DC, D, MA, MB, MO, MP, MQ, MR, J >
C5606	UTSP C	CE04W50V-47M(UTSP)	1	397584707T	< B, >
C5607	UTSP C	CE04W50V-47M(UTSP)	1	397584707T	< B, >
C5608	C-FILM C	ECHU50V-561J	1	373025614R2	< B, >
C5609	C-FILM C	ECHU50V-561J	1	373025614R2	< B, >
C5610	UTSP C	CE04W50V-47M(UTSP)	1	397584707T	< B, >
C5611	UTSP C	CE04W50V-47M(UTSP)	1	397584707T	< B, >
C5612	UTSP C	CE04W50V-47M(UTSP)	1	397584707T	< B, >
C5613	UTSP C	CE04W50V-47M(UTSP)	1	397584707T	< B, >
C5614	UTSP C	CE04W50V-47M(UTSP)	1	397584707T	< B, >
C5615	UTSP C	CE04W50V-47M(UTSP)	1	397584707T	< B, >
C5630	UTSP C	CE04W50V-47M(UTSP)	1	397584707T	< B, >
C5631	C-CERA C	CC725CH1H-221J1	1	342102214R1	< B, >
C5632	TF C	ECQ-V50V-103J	1	374721034T	< B, >
C5660	MMT C	MMT50V-334J	1	375523344T	< B, >
C5661	VR C	CE04W50V-470M(VR)	1	394684717S	< DC, D, MA, MB, MO, MP, MQ, MR, J >
C5662	VR C	CE04W50V-1000M(VR)	1	394681027S	< DC, D, MA, MB, MO, MP, MQ, MR, J >
C5666	UTSP C	CE04W25V-220M(UTSP)	1	397552217T	< B, >
C5667	UTSP C	CE04W25V-220M(UTSP)	1	397552217T	< B, >
C5670	UTSP C	CE04W50V-47M(UTSP)	1	397584707T	< B, >

C5671	UTSP C	CE04W50V-220M(UTSP)	1	397582217T	< DC, D, MA, MB, MO, MP, MQ, MR, J >
C5672	UTSP C	CE04W50V-10M(UTSP)	1	397581007T	< B, >
C5673	UTSP C	CE04W50V-10M(UTSP)	1	397581007T	< B, >
C5674	UTSP C	CE04W10V-470M(UTSP)	1	397534717T	< B, >
C5675	UTSP C	CE04W10V-470M(UTSP)	1	397534717T	< B, >
C5677	UTSP C	CE04W25V-220M(UTSP)	1	397552217T	< DC, D, MA, MB, MO, MP, MQ, MR, >
C5679	UTSP C	CE04W50V 47M(UTSP)	1	397584707T	< B, >
C5680	UTSP C	CE04W50V 47M(UTSP)	1	397584707T	< B, >
C5684	UTSP C	CE04W25V-220M(UTSP)	1	397552217T	< B, >
C5685	UTSP C	CE04W25V-220M(UTSP)	1	397552217T	< B, >
C5686	UTSP C	CE04W25V-220M(UTSP)	1	397552217T	< B, >
C5687	UTSP C	CE04W25V-220M(UTSP)	1	397552217T	< B, >
C5689	TF C	ECQ-V50V-333J	1	374723334T	< DC, D, MA, MB, MO, MP, MQ, MR, >
C5690	TF C	ECQ-V50V-333J	1	374723334T	< DC, D, MA, MB, MO, MP, MQ, MR, >
C5691	TF C	ECQ-V50V-473J	1	374724734T	< DC, D, MA, MB, MO, MP, MQ, MR, >
C5692	TF C	ECQ-V50V-224J	1	374722244T	< DC, D, MA, MB, MO, MP, MQ, MR, >
C5693	TF C	ECQ-V50V-473J	1	374724734T	< DC, D, MA, MB, MO, MP, MQ, MR, >
C5694	TF C	ECQ-V50V-224J	1	374722244T	< DC, D, MA, MB, MO, MP, MQ, MR, >
C5695	UTSP C	CE04W50V 47M(UTSP)	1	397584707T	< B, >
C5696	UTSP C	CE04W50V 47M(UTSP)	1	397584707T	< B, >
C5697	UTSP C	CE04W50V 47M(UTSP)	1	397584707T	< B, >
C5698	UTSP C	CE04W50V 47M(UTSP)	1	397584707T	< B, >
C5707	C-CERA C	CC725CH1H-221J1	1	342102214R1	< B, >
C5708	C-CERA C	CC725CH1H-221J1	1	342102214R1	< B, >
C5709	C-CERA C	CC725CH1H-221J1	1	342102214R1	< B, >
C5720	UTSP C	CE04W50V 47M(UTSP)	1	397584707T	< DC, D, MA, MB, MO, MP, MQ, MR, >
C5721	UTSP C	CE04W50V 47M(UTSP)	1	397584707T	< DC, D, MA, MB, MO, MP, MQ, MR, >
C5722	C-CERA C	CC725CH1H-221J1	1	342102214R1	< DC, D, MA, MB, MO, MP, MQ, MR, >
C5723	C-CERA C	CC725CH1H-221J1	1	342102214R1	< DC, D, MA, MB, MO, MP, MQ, MR, >
C5724	C-CERA C	CC725CH1H-221J1	1	342102214R1	< DC, D, MA, MB, MO, MP, MQ, MR, >
C5738	UTSP C	CE04W10V-100M(UTSP)	1	397531017T	< B, >
C5739	UTSP C	CE04W25V-220M(UTSP)	1	397552217T	< B, >
C5905	UTSP C	CE04W50V 47M(UTSP)	1	397584707T	< DC, D, MA, MB, MO, MP, MQ, MR, >
C5906	UTSP C	CE04W50V 47M(UTSP)	1	397584707T	< DC, D, MA, MB, MO, MP, MQ, MR, >
C5907	C-CERA C	CC725CH1H-221J1	1	342102214R1	< DC, D, MA, MB, MO, MP, MQ, MR, >
C5908	C-CERA C	CC725CH1H-221J1	1	342102214R1	< DC, D, MA, MB, MO, MP, MQ, MR, >
C5910	C-CERA C	CK725B1H-152K1	1	332101525R1	< DC, D, MA, MB, MO, MP, MQ, MR, >
C5911	C-CERA C	CK725B1H-152K1	1	332101525R1	< DC, D, MA, MB, MO, MP, MQ, MR, >
C6020	UTSP C	CE04W50V 47M(UTSP)	1	397584707T	< DC, D, MA, MB, MO, MP, MQ, MR, J >

C6021	UTSP C	CE04W50V-47M(UTSP)	1	397584707T	< DC, D, MA, MB, MO, MP, MQ, MR, J>
C6022	UTSP C	CE04W50V-47M(UTSP)	1	397584707T	< DC, D, MA, MB, MO, MP, MQ, MR, J>
C6023	UTSP C	CE04W50V-47M(UTSP)	1	397584707T	< DC, D, MA, MB, MO, MP, MQ, MR, J>
C6024	UTSP C	CE04W50V-47M(UTSP)	1	397584707T	< DC, D, MA, MB, MO, MP, MQ, MR, J>
C6025	UTSP C	CE04W50V-47M(UTSP)	1	397584707T	< DC, D, MA, MB, MO, MP, MQ, MR, J>
C6026	UTSP C	CE04W50V-47M(UTSP)	1	397584707T	< DC, D, MA, MB, MO, MP, MQ, MR, J>
C6050	TF C	ECQ-V50V-104J	1	374721044T	< DC, D, MA, MB, MO, MP, MQ, MR, J>
C6051	TF C	ECQ-V50V-104J	1	374721044T	< DC, D, MA, MB, MO, MP, MQ, MR, J>
C6052	TF C	ECQ-V50V-104J	1	374721044T	< DC, D, MA, MB, MO, MP, MQ, MR, J>
C6053	TF C	ECQ-V50V-104J	1	374721044T	< DC, D, MA, MB, MO, MP, MQ, MR, J>
C6054	TF C	ECQ-V50V-104J	1	374721044T	< DC, D, MA, MB, MO, MP, MQ, MR, J>
C6055	TF C	ECQ-V50V-104J	1	374721044T	< DC, D, MA, MB, MO, MP, MQ, MR, J>
C6056	TF C	ECQ-V50V-104J	1	374721044T	< DC, D, MA, MB, MO, MP, MQ, MR, J>
C6701	UTSP C	CE04W10V-220M(UTSP)	1	397532217T	< DC, D, MA, MB, MO, MP, MQ, MR, J>
C6703	C-CERA C	CK725FH-104Z1	1	332151040R1	< DC, D, MA, MB, MO, MP, MQ, MR, J>
C6704	UTSP C	CE04W50V-1M(UTSP)	1	397580107T	< DC, D, MA, MB, MO, MP, MQ, MR, J>
C6706	UTSP C	CE04W25V-47M(UTSP)	1	397547077T	< DC, D, MA, MB, MO, MP, MQ, MR, J>
C6710	C-CERA C	CK725F1A-105Z1	1	332181050R1	< DC, D, MA, MB, MO, MP, MQ, MR, J>
C6713	C-CERA C	CK725FH-104Z1	1	332151040R1	< DC, D, MA, MB, MO, MP, MQ, MR, J>
C6714	UTSP C	CE04W50V-2.2M(UTSP)	1	397580227T	< DC, D, MA, MB, MO, MP, MQ, MR, J>
C6901	ELECT C	CE69W71V-15000M	1	3504467	< DC, D, MA, MB, MO, MP, MQ, MR, J>
C6902	ELECT C	CE69W71V-15000M	1	3504467	< DC, D, MA, MB, MO, MP, MQ, MR, J>
C6911	C-CERA C	CC725CHH-102J1	1	342101024R1	< DC, D, MA, MB, MO, MP, MQ, MR, J>
C6912	TF C	ECQ-V100V-334J	1	374733344T	< DC, D, MA, MB, MO, MP, MQ, MR, J>
C6913	TF C	ECQ-V100V-334J	1	374733344T	< DC, D, MA, MB, MO, MP, MQ, MR, J>
C6915	TF C	ECQ-V50V-104J	1	374721044T	< DC, D, MA, MB, MO, MP, MQ, MR, J>
C6916	TF C	ECQ-V50V-104J	1	374721044T	< DC, D, MA, MB, MO, MP, MQ, MR, J>

[RESISTOR]

R4600	C-CARBON R	RN72K1J-039JE	1	435030394R1	< DC, D, MA, MB, MO, MP, MQ, MR, J>
R4601	C-CARBON R	RN72K1J-224JE	1	435032244R1	< DC, D, MA, MB, MO, MP, MQ, MR, J>
R4602	C-CARBON R	RN72K1J-102JE	1	435031024R1	< DC, D, MA, MB, MO, MP, MQ, MR, J>
R4603	C-CARBON R	RN72K1J-220JE	1	435032204R1	< DC, D, MA, MB, MO, MP, MQ, MR, J>
R4605	C-CARBON R	RN72K1J-224JE	1	435032244R1	< DC, D, MA, MB, MO, MP, MQ, MR, J>
R4606	C-CARBON R	RN72K1J-102JE	1	435031024R1	< DC, D, MA, MB, MO, MP, MQ, MR, J>
R4608	C-CARBON R	RN72K1J-101JE	1	435031014R1	< DC, D, MA, MB, MO, MP, MQ, MR, J>
R4612	C-CARBON R	RN72K1J-000JE	1	435030004R1	< DC, D, MA, MB, MO, MP, MQ, MR, J>
R4614	C-CARBON R	RN72K1J-000JE	1	435030004R1	< DC, D, MA, MB, MO, MP, MQ, MR, J>
R4616	C-CARBON R	RN72K1J-000JE	1	435030004R1	< DC, D, MA, MB, MO, MP, MQ, MR, J>
R4622	C-CARBON R	RN72K1J-000JE	1	435030004R1	< DC, D, MA, MB, MO, MP, MQ, MR, J>

R5501	C-CARBON R	RN72KIJ-331JE	1	435033314R1	< J>
R5502	C-CARBON R	RN72KIJ-331JE	1	435033314R1	< J>
R5503	C-CARBON R	RN72KIJ-331JE	1	435033314R1	< B,>
R5504	C-CARBON R	RN72KIJ-331JE	1	435033314R1	< B,>
R5505	C-CARBON R	RN72KIJ-331JE	1	435033314R1	< B,>
R5506	C-CARBON R	RN72KIJ-331JE	1	435033314R1	< B,>
R5507	C-CARBON R	RN72KIJ-331JE	1	435033314R1	< B,>
R5508	C-CARBON R	RN72KIJ-331JE	1	435033314R1	< B,>
R5509	C-CARBON R	RN72KIJ-331JE	1	435033314R1	< B,>
R5510	C-CARBON R	RN72KIJ-331JE	1	435033314R1	< B,>
R5511	C-CARBON R	RN72KIJ-331JE	1	435033314R1	< B,>
R5512	C-CARBON R	RN72KIJ-331JE	1	435033314R1	< B,>
R5513	C-CARBON R	RN72KIJ-331JE	1	435033314R1	< B,>
R5514	C-CARBON R	RN72KIJ-331JE	1	435033314R1	< B,>
R5515	C-CARBON R	RN72KIJ-331JE	1	435033314R1	< B,>
R5516	C-CARBON R	RN72KIJ-331JE	1	435033314R1	< B,>
R5517	METAL O R	RS1WBJ-10	1	443621004T	< DC, D, MA, MB, MO, MP, MQ, MR, >
R5518	METAL O R	RS1WBJ-10	1	443621004T	< DC, D, MA, MB, MO, MP, MQ, MR, >
R5519	C-CARBON R	RN72KIJ-331JE	1	435033314R1	< B,>
R5520	C-CARBON R	RN72KIJ-331JE	1	435033314R1	< B,>
R5526	C-CARBON R	RN72KIJ-101JE	1	435031014R1	< B,>
R5527	C-CARBON R	RN72KIJ-101JE	1	435031014R1	< B,>
R5528	C-CARBON R	RN72KIJ-101JE	1	435031014R1	< B,>
R5529	C-CARBON R	RN72KIJ-101JE	1	435031014R1	< B,>
R5530	C-CARBON R	RN72KIJ-101JE	1	435031014R1	< B,>
R5531	C-CARBON R	RN72KIJ-101JE	1	435031014R1	< B,>
R5532	C-CARBON R	RN72KIJ-101JE	1	435031014R1	< B,>
R5533	C-CARBON R	RN72KIJ-101JE	1	435031014R1	< B,>
R5534	C-CARBON R	RN72KIJ-101JE	1	435031014R1	< B,>
R5535	C-CARBON R	RN72KIJ-224JE	1	435032244R1	< B,>
R5538	C-CARBON R	RN72KIJ-103JE	1	435031034R1	< DC, D, MA, MB, MO, MP, MQ, MR, >
R5539	C-CARBON R	RN72KIJ-103JE	1	435031034R1	< DC, D, MA, MB, MO, MP, MQ, MR, >
R5540	C-CARBON R	RN72KIJ-224JE	1	435032244R1	< B,>
R5541	C-CARBON R	RN72KIJ-224JE	1	435032244R1	< J>
R5542	C-CARBON R	RN72KIJ-224JE	1	435032244R1	< J>
R5543	C-CARBON R	RN72KIJ-224JE	1	435032244R1	< B,>
R5544	C-CARBON R	RN72KIJ-224JE	1	435032244R1	< B,>
R5545	C-CARBON R	RN72KIJ-224JE	1	435032244R1	< B,>
R5546	C-CARBON R	RN72KIJ-224JE	1	435032244R1	< B,>

R5547	C-CARBON R	RN72KIJ-224JE	1	43503224R1	< B, >
R5548	C-CARBON R	RN72KIJ-224JE	1	43503224R1	< B, >
R5549	C-CARBON R	RN72KIJ-224JE	1	43503224R1	< B, >
R5550	C-CARBON R	RN72KIJ-224JE	1	43503224R1	< B, >
R5551	C-CARBON R	RN72KIJ-224JE	1	43503224R1	< B, >
R5552	C-CARBON R	RN72KIJ-224JE	1	43503224R1	< B, >
R5553	C-CARBON R	RN72KIJ-224JE	1	43503224R1	< B, >
R5554	C-CARBON R	RN72KIJ-224JE	1	43503224R1	< B, >
R5555	C-CARBON R	RN72KIJ-224JE	1	43503224R1	< B, >
R5556	C-CARBON R	RN72KIJ-224JE	1	43503224R1	< B, >
R5557	C-CARBON R	RN72KIJ-224JE	1	43503224R1	< B, >
R5558	C-CARBON R	RN72KIJ-224JE	1	43503224R1	< B, >
R5559	C-CARBON R	RN72KIJ-224JE	1	43503224R1	< B, >
R5560	C-CARBON R	RN72KIJ-224JE	1	43503224R1	< B, >
R5561	C-CARBON R	RN72KIJ-000JE	1	43503000R1	< B, >
R5562	C-CARBON R	RN72KIJ-000JE	1	43503000R1	< B, >
R5563	C-CARBON R	RN72KIJ-224JE	1	43503224R1	< B, >
R5564	C-CARBON R	RN72KIJ-224JE	1	43503224R1	< B, >
R5565	C-CARBON R	RN72KIJ-224JE	1	43503224R1	< B, >
R5567	C-CARBON R	RN72KIJ-224JE	1	43503224R1	< B, >
R5568	C-CARBON R	RN72KIJ-223JE	1	43503223R1	< B, >
R5569	C-CARBON R	RN72KIJ-224JE	1	43503224R1	< B, >
R5570	C-CARBON R	RN72KIJ-224JE	1	43503224R1	< B, >
R5571	C-CARBON R	RN72KIJ-224JE	1	43503224R1	< B, >
R5572	C-CARBON R	RN72KIJ-224JE	1	43503224R1	< B, >
R5573	C-CARBON R	RN72KIJ-224JE	1	43503224R1	< B, >
R5574	C-CARBON R	RN72KIJ-224JE	1	43503224R1	< B, >
R5575	C-CARBON R	RN72KIJ-224JE	1	43503224R1	< B, >
R5576	C-CARBON R	RN72KIJ-224JE	1	43503224R1	< B, >
R5577	C-CARBON R	RN72KIJ-104JE	1	43503104R1	< B, >
R5578	C-CARBON R	RN72KIJ-104JE	1	43503104R1	< B, >
R5579	C-CARBON R	RN72KIJ-104JE	1	43503104R1	< B, >
R5580	C-CARBON R	RN72KIJ-104JE	1	43503104R1	< B, >
R5582	C-CARBON R	RN72KIJ-224JE	1	43503224R1	< B, >
R5583	C-CARBON R	RN72KIJ-224JE	1	43503224R1	< B, >
R5585	C-CARBON R	RN72KIJ-472JE	1	43503472R1	< B, >
R5586	C-CARBON R	RN72KIJ-472JE	1	43503472R1	< B, >
R5587	C-CARBON R	RN72KIJ-103JE	1	43503103R1	< B, >
R5588	C-CARBON R	RN72KIJ-103JE	1	43503103R1	< B, >

R5590	C-CARBON R	RN72KIJ-223JE	1	435032234R1	< B, >
R5591	C-CARBON R	RN72KIJ-223JE	1	435032234R1	< B, >
R5592	C-CARBON R	RN72KIJ-332JE	1	435033324R1	< B, >
R5593	C-CARBON R	RN72KIJ-332JE	1	435033324R1	< B, >
R5594	C-CARBON R	RN72KIJ-331JE	1	435033314R1	< B, >
R5595	C-CARBON R	RN72KIJ-331JE	1	435033314R1	< B, >
R5596	C-CARBON R	RN72KIJ-123JE	1	435031234R1	< B, >
R5597	C-CARBON R	RN72KIJ-123JE	1	435031234R1	< B, >
R5598	C-CARBON R	RN72KIJ-103JE	1	435031034R1	< B, >
R5599	C-CARBON R	RN72KIJ-103JE	1	435031034R1	< B, >
R5600	C-CARBON R	RN72KIJ-224JE	1	435032244R1	< DC, D, MA, MB, MO, MP, MQ, MR, J>
R5601	C-CARBON R	RN72KIJ-224JE	1	435032244R1	< DC, D, MA, MB, MO, MP, MQ, MR, J>
R5602	C-CARBON R	RN72KIJ-224JE	1	435032244R1	< DC, D, MA, MB, MO, MP, MQ, MR, J>
R5603	C-CARBON R	RN72KIJ-224JE	1	435032244R1	< DC, D, MA, MB, MO, MP, MQ, MR, J>
R5604	C-CARBON R	RN72KIJ-224JE	1	435032244R1	< DC, D, MA, MB, MO, MP, MQ, MR, J>
R5605	C-CARBON R	RN72KIJ-224JE	1	435032244R1	< DC, D, MA, MB, MO, MP, MQ, MR, J>
R5606	C-CARBON R	RN72KIJ-224JE	1	435032244R1	< B, >
R5607	C-CARBON R	RN72KIJ-224JE	1	435032244R1	< B, >
R5608	C-CARBON R	RN72KIJ-224JE	1	435032244R1	< B, >
R5609	C-CARBON R	RN72KIJ-224JE	1	435032244R1	< B, >
R5610	C-CARBON R	RN72KIJ-121JE	1	435031214R1	< DC, D, MA, MB, MO, MP, MQ, MR, J>
R5611	C-CARBON R	RN72KIJ-121JE	1	435031214R1	< DC, D, MA, MB, MO, MP, MQ, MR, J>
R5612	C-CARBON R	RN72KIJ-121JE	1	435031214R1	< DC, D, MA, MB, MO, MP, MQ, MR, J>
R5613	C-CARBON R	RN72KIJ-121JE	1	435031214R1	< DC, D, MA, MB, MO, MP, MQ, MR, J>
R5614	C-CARBON R	RN72KIJ-121JE	1	435031214R1	< DC, D, MA, MB, MO, MP, MQ, MR, J>
R5615	C-CARBON R	RN72KIJ-121JE	1	435031214R1	< DC, D, MA, MB, MO, MP, MQ, MR, J>
R5616	C-CARBON R	RN72KIJ-121JE	1	435031214R1	< B, >
R5617	C-CARBON R	RN72KIJ-121JE	1	435031214R1	< B, >
R5620	C-CARBON R	RN72KIJ-101JE	1	435031014R1	< DC, D, MA, MB, MO, MP, MQ, MR, J>
R5621	C-CARBON R	RN72KIJ-101JE	1	435031014R1	< DC, D, MA, MB, MO, MP, MQ, MR, J>
R5622	C-CARBON R	RN72KIJ-101JE	1	435031014R1	< DC, D, MA, MB, MO, MP, MQ, MR, J>
R5623	C-CARBON R	RN72KIJ-101JE	1	435031014R1	< DC, D, MA, MB, MO, MP, MQ, MR, J>
R5624	C-CARBON R	RN72KIJ-101JE	1	435031014R1	< DC, D, MA, MB, MO, MP, MQ, MR, J>
R5625	C-CARBON R	RN72KIJ-101JE	1	435031014R1	< DC, D, MA, MB, MO, MP, MQ, MR, J>
R5626	C-CARBON R	RN72KIJ-101JE	1	435031014R1	< B, >
R5627	C-CARBON R	RN72KIJ-101JE	1	435031014R1	< B, >
R5630	C-CARBON R	RN72KIJ-221JE	1	435032214R1	< B, >
R5631	C-CARBON R	RN72KIJ-473JE	1	435034734R1	< B, >
R5632	C-CARBON R	RN72KIJ-153JE	1	435031534R1	< B, >

R5633	C-CARBON R	RN72KIJ-122JE	1	435031224R1	< B, >
R5634	C-CARBON R	RN72KIJ-103JE	1	435031034R1	< B, >
R5635	C-CARBON R	RN72KIJ-000JE	1	435030004R1	< DC, D, MA, MB, MO, MP, MQ, MR, >
R5636	C-CARBON R	RN72KIJ-000JE	1	435030004R1	< DC, D, MA, MB, MO, MP, MQ, MR, >
R5637	METAL OR	RS1/2WBJ-10	1	443521004T	< B, >
R5638	METAL OR	RS1/2WBJ-10	1	443521004T	< B, >
R5639	C-CARBON R	RN72KIJ-331JE	1	435033314R1	< B, >
R5640	C-CARBON R	RN72KIJ-331JE	1	435033314R1	< B, >
R5641	C-CARBON R	RN72KIJ-563JE	1	435035634R1	< B, >
R5642	C-CARBON R	RN72KIJ-563JE	1	435035634R1	< B, >
R5643	C-CARBON R	RN72KIJ-474JE	1	435034744R1	< B, >
R5644	C-CARBON R	RN72KIJ-474JE	1	435034744R1	< B, >
R5645	C-CARBON R	RN72KIJ-561JE	1	435035614R1	< B, >
R5646	C-CARBON R	RN72KIJ-561JE	1	435035614R1	< B, >
R5647	C-CARBON R	RN72KIJ-274JE	1	435032744R1	< B, >
R5648	C-CARBON R	RN72KIJ-274JE	1	435032744R1	< B, >
R5649	C-CARBON R	RN72KIJ-223JE	1	435032234R1	< B, >
R5650	C-CARBON R	RN72KIJ-223JE	1	435032234R1	< B, >
R5651	C-CARBON R	RN72KIJ-122JE	1	435031224R1	< B, >
R5652	C-CARBON R	RN72KIJ-122JE	1	435031224R1	< B, >
R5653	C-CARBON R	RN72KIJ-101JE	1	435031014R1	< B, >
R5654	C-CARBON R	RN72KIJ-101JE	1	435031014R1	< B, >
R5655	C-CARBON R	RN72KIJ-224JE	1	435032244R1	< B, >
R5656	C-CARBON R	RN72KIJ-224JE	1	435032244R1	< B, >
R5657	C-CARBON R	RN72KIJ-224JE	1	435032244R1	< B, >
R5660	METAL R	RNU1WCJ-1.5	1	453630154T	< DC, D, MA, MB, MO, MP, MQ, MR, J>
R5661	METAL R	RNU1WCJ-1.5	1	453630154T	< DC, D, MA, MB, MO, MP, MQ, MR, J>
R5663	CEMENT R	RSS5WJ-15(BGR.SNJ)	1	4800082	< DC, D, MA, MB, MO, MP, MQ, MR, J>
R5664	CEMENT R	RSS5WJ-15(BGR.SNJ)	1	4800082	< DC, D, MA, MB, MO, MP, MQ, MR, J>
R5666	CARBON R	R16J-22	1	417342204T	< B, >
R5667	CARBON R	R16J-22	1	417342204T	< B, >
R5669	C-CARBON R	RN72KIJ-224JE	1	435032244R1	< B, >
R5672	C-CARBON R	RN72KIJ-100JE	1	435031004R1	< B, >
R5673	C-CARBON R	RN72KIJ-100JE	1	435031004R1	< B, >
R5674	METAL OR	RS1WBJ-470	1	443624714T	< DC, D, MA, MB, MO, MP, MQ, MR, >
R5675	METAL OR	RS1WBJ-22	1	443622204T	< B, >
R5676	METAL OR	RS1WBJ-22	1	443622204T	< B, >
R5677	METAL OR	RS1WBJ-22	1	443622204T	< B, >
R5678	METAL OR	RS1WBJ-22	1	443622204T	< B, >

R5679	CARBON R	RI6J-1.2K	1	417341224T	< B, >
R5681	C-CARBON R	RN72KIJ-224JE	1	435032244R1	< B, >
R5682	C-CARBON R	RN72KIJ-224JE	1	435032244R1	< B, >
R5683	C-CARBON R	RN72KIJ-224JE	1	435032244R1	< B, >
R5684	C-CARBON R	RN72KIJ-224JE	1	435032244R1	< B, >
R5685	CARBON R	RI6J-1.2K	1	417341224T	< B, >
R5692	C-CARBON R	RN72KIJ-104JE	1	435031044R1	< B, >
R5693	C-CARBON R	RN72KIJ-472JE	1	435034724R1	< DC, D, MA, MB, MO, MP, MQ, MR, >
R5694	C-CARBON R	RN72KIJ-472JE	1	435034724R1	< DC, D, MA, MB, MO, MP, MQ, MR, >
R5695	C-CARBON R	RN72KIJ-224JE	1	435032244R1	< B, >
R5696	C-CARBON R	RN72KIJ-224JE	1	435032244R1	< B, >
R5711	C-CARBON R	RN72KIJ-224JE	1	435032244R1	< B, >
R5712	C-CARBON R	RN72KIJ-224JE	1	435032244R1	< B, >
R5714	C-CARBON R	RN72KIJ-224JE	1	435032244R1	< B, >
R5715	C-CARBON R	RN72KIJ-224JE	1	435032244R1	< B, >
R5716	C-CARBON R	RN72KIJ-224JE	1	435032244R1	< B, >
R5732	C-CARBON R	RN72KIJ-224JE	1	435032244R1	< B, >
R5733	C-CARBON R	RN72KIJ-224JE	1	435032244R1	< B, >
R5734	C-CARBON R	RN72KIJ-391JE	1	435033914R1	< B, >
R5735	C-CARBON R	RN72KIJ-391JE	1	435033914R1	< B, >
R5738	C-CARBON R	RN72KIJ-224JE	1	435032244R1	< B, >
R5739	C-CARBON R	RN72KIJ-224JE	1	435032244R1	< B, >
R5740	C-CARBON R	RN72KIJ-391JE	1	435033914R1	< B, >
R5741	C-CARBON R	RN72KIJ-391JE	1	435033914R1	< B, >
R5744	C-CARBON R	RN72KIJ-224JE	1	435032244R1	< B, >
R5745	C-CARBON R	RN72KIJ-224JE	1	435032244R1	< B, >
R5746	C-CARBON R	RN72KIJ-391JE	1	435033914R1	< B, >
R5747	C-CARBON R	RN72KIJ-391JE	1	435033914R1	< B, >
R5750	C-CARBON R	RN72KIJ-102JE	1	435031024R1	< DC, D, MA, MB, MO, MP, MQ, MR, >
R5751	C-CARBON R	RN72KIJ-102JE	1	435031024R1	< DC, D, MA, MB, MO, MP, MQ, MR, >
R5752	C-CARBON R	RN72KIJ-101JE	1	435031014R1	< DC, D, MA, MB, MO, MP, MQ, MR, >
R5753	C-CARBON R	RN72KIJ-101JE	1	435031014R1	< DC, D, MA, MB, MO, MP, MQ, MR, >
R5754	C-CARBON R	RN72KIJ-224JE	1	435032244R1	< DC, D, MA, MB, MO, MP, MQ, MR, >
R5755	C-CARBON R	RN72KIJ-224JE	1	435032244R1	< DC, D, MA, MB, MO, MP, MQ, MR, >
R5756	C-CARBON R	RN72KIJ-101JE	1	435031014R1	< DC, D, MA, MB, MO, MP, MQ, MR, >
R5757	C-CARBON R	RN72KIJ-101JE	1	435031014R1	< DC, D, MA, MB, MO, MP, MQ, MR, >
R5782	C-CARBON R	RN72KIJ-224JE	1	435032244R1	< DC, D, MA, MB, MO, MP, MQ, MR, >
R5783	C-CARBON R	RN72KIJ-224JE	1	435032244R1	< DC, D, MA, MB, MO, MP, MQ, MR, >
R5788	C-CARBON R	RN72KIJ-472JE	1	435034724R1	< B, >

R5789	C-CARBON R	RN72K1J-103JE	1	435031034R1	< B, >
R5790	C-CARBON R	RN72K1J-123JE	1	435031234R1	< B, >
R5791	C-CARBON R	RN72K1J-223JE	1	435032234R1	< B, >
R5792	C-CARBON R	RN72K1J-103JE	1	435031034R1	< B, >
R5793	C-CARBON R	RN72K1J-333JE	1	435033334R1	< B, >
R5794	C-CARBON R	RN72K1J-333JE	1	435033334R1	< B, >
R5795	C-CARBON R	RN72K1J-333JE	1	435033334R1	< B, >
R5796	C-CARBON R	RN72K1J-682JE	1	435036824R1	< B, >
R5797	C-CARBON R	RN72K1J-104JE	1	435031044R1	< B, >
R5798	CARBON R	R16J-12K	1	417341234T	< B, >
R5800	C-CARBON R	RN72K1J-102JE	1	435031024R1	< DC, D, MA, MB, MO, MP, MQ, MR, >
R5801	C-CARBON R	RN72K1J-102JE	1	435031024R1	< DC, D, MA, MB, MO, MP, MQ, MR, >
R5813	C-CARBON R	RN72K1J-000JE	1	435030004R1	< B, >
R5815	C-CARBON R	RN72K1J-000JE	1	435030004R1	< B, >
R5816	C-CARBON R	RN72K1J-000JE	1	435030004R1	< B, >
R5817	C-CARBON R	RN72K1J-000JE	1	435030004R1	< B, >
R5818	C-CARBON R	RN72K1J-000JE	1	435030004R1	< B, >
R5819	C-CARBON R	RN72K1J-000JE	1	435030004R1	< B, >
R5820	C-CARBON R	RN72K1J-000JE	1	435030004R1	< B, >
R5821	C-CARBON R	RN72K1J-000JE	1	435030004R1	< B, >
R5822	C-CARBON R	RN72K1J-000JE	1	435030004R1	< B, >
R5823	C-CARBON R	RN72K1J-000JE	1	435030004R1	< B, >
R5824	C-CARBON R	RN72K1J-000JE	1	435030004R1	< B, >
R5825	C-CARBON R	RN72K1J-000JE	1	435030004R1	< B, >
R5826	C-CARBON R	RN72K1J-000JE	1	435030004R1	< B, >
R5827	C-CARBON R	RN72K1J-000JE	1	435030004R1	< B, >
R5828	C-CARBON R	RN72K1J-000JE	1	435030004R1	< B, >
R5829	C-CARBON R	RN72K1J-000JE	1	435030004R1	< B, >
R5830	C-CARBON R	RN72K1J-000JE	1	435030004R1	< B, >
R5831	C-CARBON R	RN72K1J-000JE	1	435030004R1	< B, >
R5832	C-CARBON R	RN72K1J-000JE	1	435030004R1	< B, >
R5833	C-CARBON R	RN72K1J-000JE	1	435030004R1	< B, >
R5834	C-CARBON R	RN72K1J-000JE	1	435030004R1	< B, >
R5835	C-CARBON R	RN72K1J-000JE	1	435030004R1	< B, >
R5836	C-CARBON R	RN72K1J-000JE	1	435030004R1	< B, >
R5839	C-CARBON R	RN72K1J-000JE	1	435030004R1	< B, >
R5840	C-CARBON R	RN72K1J-000JE	1	435030004R1	< B, >
R5841	C-CARBON R	RN72K1J-000JE	1	435030004R1	< B, >
R5842	C-CARBON R	RN72K1J-000JE	1	435030004R1	< B, >

R6314	NF CARBON R	R25J-10	1	415471004T	< DC, D, MA, MB, MO, MP, MQ, MR, J >
R6315	NF CARBON R	R25J-10	1	415471004T	< DC, D, MA, MB, MO, MP, MQ, MR, J >
R6316	NF CARBON R	R25J-10	1	415471004T	< DC, D, MA, MB, MO, MP, MQ, MR, J >
R6701	C-CARBON R	RN72K1J-223JE	1	435032234R1	< DC, D, MA, MB, MO, MP, MQ, MR, J >
R6702	C-CARBON R	RN72K1J-103JE	1	435031034R1	< DC, D, MA, MB, MO, MP, MQ, MR, J >
R6704	C-CARBON R	RN72K1J-473JE	1	435034734R1	< DC, D, MA, MB, MO, MP, MQ, MR, J >
R6706	C-CARBON R	RN72K1J-224JE	1	435032244R1	< DC, D, MA, MB, MO, MP, MQ, MR, J >
R6708	C-CARBON R	RN72K1J-333JE	1	435033334R1	< DC, D, MA, MB, MO, MP, MQ, MR, J >
R6709	C-CARBON R	RN72K1J-392JE	1	435033924R1	< DC, D, MA, MB, MO, MP, MQ, MR, J >
R6710	C-CARBON R	RN72K1J-123JE	1	435031234R1	< DC, D, MA, MB, MO, MP, MQ, MR, J >
R6712	C-CARBON R	RN72K1J-103JE	1	435031034R1	< DC, D, MA, MB, MO, MP, MQ, MR, J >
R6714	C-CARBON R	RN72K1J-333JE	1	435033334R1	< DC, D, MA, MB, MO, MP, MQ, MR, J >
R6716	C-CARBON R	RN72K1J-563JE	1	435035634R1	< DC, D, MA, MB, MO, MP, MQ, MR, J >
R6902	C-CARBON R	RN72K1J-102JE	1	435031024R1	< DC, D, MA, MB, MO, MP, MQ, MR, J >
R6903	C-CARBON R	RN72K1J-473JE	1	435034734R1	< DC, D, MA, MB, MO, MP, MQ, MR, J >
R6907	C-CARBON R	RN72K1J-000JE	1	435030004R1	< DC, D, MA, MB, MO, MP, MQ, MR, J >

[SW TRM]

E5507A	TRM	NTM-1P232(MI700)	1	25060301	< DC, D, MA, MB, MO, MP, MQ, MR, J >
E5509A	TRM	NTM-1P232(MI700)	1	25060301	< DC, D, MA, MB, MO, MP, MQ, MR, J >
E5519	TRM-423(SCREW)	NEJTANSI ST3	1	25060495	< B, >
E5520	TRM-423(SCREW)	NEJTANSI ST3	1	25060495	< B, >
F6901A	FUSE HOLDER	SNS5051	1	250113	< DC, D, MA, MB, MO, MP, MQ, MR, J >
F6901B	FUSE HOLDER	SNS5051	1	250113	< DC, D, MA, MB, MO, MP, MQ, MR, J >
F6902A	FUSE HOLDER	SNS5051	1	250113	< DC, D, MA, MB, MO, MP, MQ, MR, J >
F6902B	FUSE HOLDER	SNS5051	1	250113	< DC, D, MA, MB, MO, MP, MQ, MR, J >
JL104A	WIRE HOL	NSCT-9P880	1	25051093	< DC, D, MA, MB, MO, MP, MQ, MR, J >
JL4500A	WIRE HOL	NSCT-3P874	1	25051087	< DC, D, MA, MB, MO, MP, MQ, MR, J >
JL5513A	WIRE HOL	NSCT-5P876	1	25051089	< DC, D, MA, MB, MO, MP, MQ, MR, J >
JL5514A	WIRE HOL	NSCT-7P898	1	25051111	< DC, D, MA, MB, MO, MP, MQ, MR, J >
JL5514B	SOCKET	NSCT-7P99	1	25050271	< B, >
JL5515B	WIRE TRAP	NPLG-11P594	1	25055632	< DC, D, MA, MB, MO, MP, MQ, MR, J >
JL6402A	WIRE HOL	NSCT-3P874	1	25051087	< DC, D, MA, MB, MO, MP, MQ, MR, J >
JL6402B	WIRE HOL	NSCT-3P874	1	25051087	< DC, D, MA, MB, MO, MP, MQ, MR, J >
JL6600A	WIRE HOL	NSCT-7P898	1	25051111	< DC, D, MA, MB, MO, MP, MQ, MR, J >
JL6603A	WIRE HOL	NSCT-9P900	1	25051113	< DC, D, MA, MB, MO, MP, MQ, MR, J >
JL6606B	WIRE TRAP	NPLG-7P590	1	25055628	< DC, D, MA, MB, MO, MP, MQ, MR, J >
JL6620A	WIRE HOL	NSCT-7P878	1	25051091	< DC, D, MA, MB, MO, MP, MQ, MR, J >
P4500	PLUG	NPLG-2P83	1	25055099	< DC, D, MA, MB, MO, MP, MQ, MR, J >
P4600	ST JACK	HSJ1002-01-6020	1	25045647	< DC, D, MA, MB, MO, MP, MQ, MR, J >

P4602	ST JACK	HS11002-01-6020	1	25045647	< DC, D, MA, MB, MO, MP, MQ, MR, >
P5500	PIN JACK	NPI-2PDWR558	1	25045776	< DC, D, MA, MB, MO, MP, MQ, MR, >
P5500	PIN JACK	NPI-4PDWRRR624	1	25045845	< J >
P5501	PIN JACK	NPI-6PDWRRR561	1	25045779	< DC, D, MA, MB, MO, MP, MQ, MR, J >
P5502	PIN JACK	NPI-6PDWRRR561	1	25045779	< DC, D, MA, MB, MO, MP, MQ, MR, J >
P5503	PIN JACK	NPI-6PDWRRRR561	1	25045779	< DC, D, MA, MB, MO, MP, MQ, MR, J >
P5504	PIN JACK	NPI-1PDG699	1	25045933	< DC, D, MA, MB, MO, MP, MQ, MR, J >
P5505	PIN JACK	NPI-6PDLENTP701	1	25045935	< DC, D, MA, MB, MO, MP, MQ, MR, J >
P5506	PIN JACK	NPI-4PDWRRR624	1	25045845	< DC, D, MA, MB, MO, MP, MQ, MR, >
P5509	CRIMP AS	CRIMP AS	1	2069925170UL	< DC, D, MA, MB, MO, MP, MQ, MR, J >
P5510A	SOCKET AS	NSAS-26P1742	1	200999118UL	< DC, D, MA, MB, MO, MP, MQ, MR, J >
P5510B	PLUG	NPLG-13P360	1	25055377	< DC, D, MA, MB, MO, MP, MQ, MR, J >
P5510C	CRIMP AS	CRIMP SR805_2	1	20799170UL	< DC, D, MA, MB, MO, MP, MQ, MR, J >
P5510D	CRIMP AS	CRIMP SR805_1	1	20799169UL	< DC, D, MA, MB, MO, MP, MQ, MR, J >
P5512	SOCKET	NSCT-15P2195	1	25052298	< B, >
P5513	SOCKET	NSCT-19P2199	1	25052302	< B, >
P5516	HOLDER	HOLDER(CLAMP)	1	27190540-1	< DC, D, MA, MB, MO, MP, MQ, MR, J >
P5518	SOCKET	NSCT-3P2183	1	25052286	< B, >
P6000B	PLUG	NPLG-7P0962	1	25056012	< DC, D, MA, MB, MO, MP, MQ, MR, J >
P6001B	PLUG	NPLG-7P0962	1	25056012	< DC, D, MA, MB, MO, MP, MQ, MR, J >
P6002B	PLUG	NPLG-7P0962	1	25056012	< DC, D, MA, MB, MO, MP, MQ, MR, J >
P6003B	PLUG	NPLG-7P0962	1	25056012	< DC, D, MA, MB, MO, MP, MQ, MR, J >
P6004B	PLUG	NPLG-7P0962	1	25056012	< DC, D, MA, MB, MO, MP, MQ, MR, J >
P6005B	PLUG	NPLG-7P0962	1	25056012	< DC, D, MA, MB, MO, MP, MQ, MR, J >
P6006B	PLUG	NPLG-7P0962	1	25056012	< DC, D, MA, MB, MO, MP, MQ, MR, J >
P6011A	RETAINER	(BUS-D)	1	27142115A	< DC, D, MA, MB, MO, MP, MQ, MR, J >
P6020	HOLDER	HOLDER(CLAMP)	1	27190540-1	< DC, D, MA, MB, MO, MP, MQ, MR, J >
P6080	PLUG	NPLG-2P130	1	25055146	< DC, D, MA, MB, MO, MP, MQ, MR, J >
P6081	PLUG	NPLG-2P130	1	25055146	< DC, D, MA, MB, MO, MP, MQ, MR, J >
P6082	PLUG	NPLG-2P130	1	25055146	< DC, D, MA, MB, MO, MP, MQ, MR, J >
P6083	PLUG	NPLG-2P130	1	25055146	< DC, D, MA, MB, MO, MP, MQ, MR, J >
P6084	PLUG	NPLG-2P130	1	25055146	< DC, D, MA, MB, MO, MP, MQ, MR, J >
P6085	PLUG	NPLG-2P130	1	25055146	< DC, D, MA, MB, MO, MP, MQ, MR, J >
P6086	PLUG	NPLG-2P130	1	25055146	< DC, D, MA, MB, MO, MP, MQ, MR, J >
P6900	CRIMP AS	CRIMP AS	1	2069925170UL	< DC, D, MA, MB, MO, MP, MQ, MR, J >
P6901	CRIMP AS	CRIMP AS	1	2069925142UL	< DC, D, MA, MB, MO, MP, MQ, MR, J >
P6902	CRIMP AS	CRIMP AS	1	2069925208UL	< DC, D, MA, MB, MO, MP, MQ, MR, J >
P6950	PLUG	NPLG-5P152	1	25055168	< DC, D, MA, MB, MO, MP, MQ, MR, J >
P907	AC INLET	NPLG-3P836	1	25055880	< J >

p907	AC INLET	NPL-G-2P913	1	25055960	< DC, D, MA, MB, MO, MP, MQ, MR, >
p921	SOCKET AS	NSAS-2P1796	1	2009991162UL	< DC, D, MA, MB, MO, MP, MQ, MR, J >
RL6901	RELAY	NRL-1P10A-DC12-140	1	25065584	< DC, D, MA, MB, MO, MP, MQ, MR, J >
RL6902	RELAY	NRL-1P10A-DC12-140	1	25065584	< DC, D, MA, MB, MO, MP, MQ, MR, J >

PRINTED CIRCUIT BOARD PARTS LIST

U003	DAC/ DIR circuit PC board a'ssy	BADG-0099-1G *	N
U003	DAC/ DIR circuit PC board a'ssy	BADG-0099-1H *	N B DC, DF
U0031	CPU Circuit PC board a'ssy	BACPU-0100-1G	N NSP, B DC, DF
U0031	CPU Circuit PC board a'ssy	BACPU-0100-1H	N NSP, B MA, MB, MO, MP, MQ, MR, S
U0032	Video circuit PC board a'ssy	BAVD-0101-1G	N NSP, B DC, DF
U0032	Video circuit PC board a'ssy	BAVD-0101-1H	N NSP, B MA, MB, MO, MP, MQ, MR, S
U0033	Unuversal port PC board a'ssy	BAETC-0103-1G	N NSP, B DC, DF
U0033	Unuversal port PC board a'ssy	BAETC-0103-1H	N NSP, B MA, MB, MO, MP, MQ, MR, S

CIRCUIT. NO.	PART NAME	DESCRIPTION	Q'TY	PART NO. (SN)	REMARKS
[TUNER UNIT]					
UI100	REMO SENS	KSM-603TE2Q	1	24130018	< DC, D, MA, MB, MO, MP, MQ, MR, >
UI301	PHT CP	JSR1165-001recieving	1	24120143	< B, >
UI302	PHT CP	JSR1165-001recieving	1	24120143	< B, >
[SEMI CONDUCTOR]					
D1001	C-DIODE	ISS352	1	223234R2	< B, >
D1001 or	C-DIODE	MA2J111	(1)	223279R2	< B, >
D1001 or	C-DIODE	KDS4148U	(1)	223283R2	< B, >
D1002	C-DIODE	ISS352	1	223234R2	< B, >
D1002 or	C-DIODE	MA2J111	(1)	223279R2	< B, >
D1002 or	C-DIODE	KDS4148U	(1)	223283R2	< B, >
D1005	C-DIODE	ISS352	1	223234R2	< B, >
D1005 or	C-DIODE	MA2J111	(1)	223279R2	< B, >
D1005 or	C-DIODE	KDS4148U	(1)	223283R2	< B, >
D1007	C-DIODE	ISS352	1	223234R2	< B, >
D1007 or	C-DIODE	MA2J111	(1)	223279R2	< B, >
D1007 or	C-DIODE	KDS4148U	(1)	223283R2	< B, >
D1100	SPCF D	SIR-34ST3F	1	225456	< DC, D, MA, MB, MO, MP, MQ, MR, >
D1101	SPCF D	SIR-34ST3F	1	225456	< DC, D, MA, MB, MO, MP, MQ, MR, >
D4001	C-DIODE	ISS352	1	223234R2	< B, >
D4001 or	C-DIODE	MA2J111	(1)	223279R2	< B, >
D4001 or	C-DIODE	KDS4148U	(1)	223283R2	< B, >

D4002	ZENER D	UDZS5.6B	1	224550560R2	< B, >
D4002 or	ZENER D	MAZ8056-M	(1)	224750562R2	< B, >
D4003	C-DIODE	ISS352	1	223234R2	< B, >
D4003 or	C-DIODE	MA2J111	(1)	223279R2	< B, >
D4003 or	C-DIODE	KDS4148U	(1)	223283R2	< B, >
D4004	DIODE	DSSBA20	1	22380130F	< B, >
D4005	DIODE	RB070M-30	1	22380361R2	< B, >
D4006	DIODE	RL1N4003	1	22380260T	< B, >
D4009	DIODE	DSSBA20	1	22380271F	< B, >
D4010	C-DIODE	ISS352	1	223234R2	< B, >
D4010 or	C-DIODE	MA2J111	(1)	223279R2	< B, >
D4010 or	C-DIODE	KDS4148U	(1)	223283R2	< B, >
D4015	C-DIODE	ISS352	1	223234R2	< B, >
D4015 or	C-DIODE	MA2J111	(1)	223279R2	< B, >
D4015 or	C-DIODE	KDS4148U	(1)	223283R2	< B, >
D4016	C-DIODE	ISS352	1	223234R2	< B, >
D4016 or	C-DIODE	MA2J111	(1)	223279R2	< B, >
D4016 or	C-DIODE	KDS4148U	(1)	223283R2	< B, >
D4017	ZENER D	UDZS3.3B	1	224550330R2	< B, >
D4500	C-DIODE	ISS352	1	223234R2	< B, >
D4500 or	C-DIODE	MA2J111	(1)	223279R2	< B, >
D4500 or	C-DIODE	KDS4148U	(1)	223283R2	< B, >
D4501	C-DIODE	ISS352	1	223234R2	< B, >
D4501 or	C-DIODE	MA2J111	(1)	223279R2	< B, >
D4501 or	C-DIODE	KDS4148U	(1)	223283R2	< B, >
D4606	DIODE	RL1N4003	1	22380260T	< B, >
Q10	IC	NJM4580M-D	1	22241448R2	< DC, D >
Q1001	TR	KRC104S	1	2216210R2	< B, >
Q1001 or	TR	RN1404	(1)	2214490R2	< B, >
Q1002	TR	KRA102S	1	2216220R2	< B, >
Q1002 or	TR	RN2402	(1)	2214530R2	< B, >
Q1003	TR	KRC104S	1	2216210R2	< B, >
Q1003 or	TR	RN1404	(1)	2214490R2	< B, >
Q1004	TR	KRA102S	1	2216220R2	< B, >
Q1004 or	TR	RN2402	(1)	2214530R2	< B, >
Q1005	TR	KRC102S	1	2216190R2	< B, >
Q1005 or	TR	RN1402	(1)	2214470R2	< B, >
Q1005 or	TR	DTC114EKA	(1)	2216250R2	< B, >
Q1006	TR	KRA107S	1	2216350R2	< B, >

Q1006 or	TR	RN2407(TE8SL_F)	(1)	2216360R2	< B, >
Q1006 or	TR	DTA114YKA	(1)	2216480R2	< B, >
Q1007	TR	KRC102S	1	2216190R2	< B, >
Q1007 or	TR	RN1402	(1)	2214470R2	< B, >
Q1007 or	TR	DTC114EKA	(1)	2216250R2	< B, >
Q1008	TR	KRA107S	1	2216350R2	< B, >
Q1008 or	TR	RN2407(TE8SL_F)	(1)	2216360R2	< B, >
Q1008 or	TR	DTA114YKA	(1)	2216480R2	< B, >
Q1009	TR	KRC102S	1	2216190R2	< B, >
Q1009 or	TR	RN1402	(1)	2214470R2	< B, >
Q1009 or	TR	DTC114EKA	(1)	2216250R2	< B, >
Q101	IC	LC72725KV-TLM-E	1	22242584R2	< MA, MB, MO, MP, MQ, MR, >
Q1010	TR	KRC104S	1	2216210R2	< B, >
Q1010 or	TR	RN1404	(1)	2214490R2	< B, >
Q1011	TR	KRA102S	1	2216220R2	< B, >
Q1011 or	TR	RN2402	(1)	2214530R2	< B, >
Q1016	IC (MAIN MICROPROCESSOR)	MPD70E3746GJ-GAE-AX (0298)	1	222W0079R302980	< B, >
Q1017	IC	XC6202P502FR	1	22242331R2	< B, >
Q1018	IC	XC6213B332MR	1	22242277R2	< B, >
Q1019	IC	S-812C33AUA-C2N	1	22242222R2	< B, >
Q102	IC	S-812C33AUA-C2N	1	22242222R2	< MA, MB, MO, MP, MQ, MR, >
Q1020	IC	S-812C56AUA-C3K	1	22242207R2	< B, >
Q1022	IC	RIEX25064AS.A00A	1	22242581R2	< B, >
Q1023	IC	NJU7706F27A3	1	22242614R2	< B, >
Q1027	TR	KRA102S	1	2216220R2	< B, >
Q1028	TR	KRC104S	1	2216210R2	< B, >
Q1029	TR	KRA102S	1	2216220R2	< B, >
Q1030	TR	KRC104S	1	2216210R2	< B, >
Q1031	TR	KRA102S	1	2216220R2	< B, >
Q1032	TR	KRC104S	1	2216210R2	< B, >
Q1033	TR	KRA102S	1	2216220R2	< B, >
Q1034	TR	KRC104S	1	2216210R2	< B, >
Q1035	TR	KRA102S	1	2216220R2	< B, >
Q1036	TR	KRC104S	1	2216210R2	< B, >
Q1037	TR	KRA102S	1	2216220R2	< B, >
Q1038	TR	KRC104S	1	2216210R2	< B, >
Q1101	IC	S3F80K9	1	22242602R3	N < DC, D, MA, MB, MO, MP, MQ, MR, >
Q1102	TR	2SC2712-GR	1	2213145R2	< DC, D, MA, MB, MO, MP, MQ, MR, >
Q1290	TR	2SC2712-GR	1	2213145R2	< B, >

Q1291	IC	TC4066BFT	1	22284066MR2TO	< B, >
Q1292	TR	2SC2712-GR	1	2213145R2	< B, >
Q1301	IC	TA4805BF(TEI6L_NQ)	1	22278005DBR2TO	< B, >
Q1301A	RETAINER	(REG)	1	27142168	N < B, >
Q1302	IC	TA48033BF(TEI6L_NQ)	1	22278033DBR2TO	< B, >
Q1311	IC	TC74VHC157FT	1	22274157ER2TO	< B, >
Q1322	IC	TC74VHCT00AFT (EKJ)	1	22274000G1R2TO	< B, >
Q1322 or	IC	TC74VHCT00AFT	(1)	22274000GR2TO	< B, >
Q1324	IC	CS42516-CQZ(R)-D	1	22242294R2	< B, >
Q1325	IC	74HCU04F	1	222740046R2	< B, >
Q1325 or	IC	TC74HCU04AF	(1)	222740046R2TO	< B, >
Q1327	IC	TC7WU04FU(TEI2L_F)	1	22240935R2	< B, >
Q1421	IC	PCM1690DCAR	1	22242599R2	N < B, >
Q1601	IC	NJM4580M-D	1	22241448R2	< B, >
Q1602	IC	NJM4580M-D	1	22241448R2	< B, >
Q1603	IC	NJM4580M-D	1	22241448R2	< B, >
Q1604	IC	NJM4580M-D	1	22241448R2	< B, >
Q1611	IC	NJM4580M-D	1	22241448R2	< B, >
Q1612	IC	NJM4580M-D	1	22241448R2	< B, >
Q1613	IC	NJM4580M-D	1	22241448R2	< B, >
Q1614	IC	NJM4580M-D	1	22241448R2	< B, >
Q1621	IC	NJM4580M-D	1	22241448R2	< B, >
Q1622	IC	NJM4580M-D	1	22241448R2	< B, >
Q1623	IC	NJM4580M-D	1	22241448R2	< B, >
Q1624	IC	NJM4580M-D	1	22241448R2	< B, >
Q1631	IC	NJM4580M-D	1	22241448R2	< B, >
Q1632	IC	NJM4580M-D	1	22241448R2	< B, >
Q1633	IC	NJM4580M-D	1	22241448R2	< B, >
Q1634	IC	NJM4580M-D	1	22241448R2	< B, >
Q1800	IC	NJM4580M-D	1	22241448R2	< B, >
Q1801	IC	NJM4580M-D	1	22241448R2	< B, >
Q1904	IC	NJM4580M-D	1	22241448R2	< B, >
Q1940	IC	XC6202P502FR	1	22242331R2	< B, >
Q1950	IC	NJM2505AF	1	22242490R2	< B, >
Q1960	IC	NJM2505AF	1	22242490R2	< B, >
Q1970	IC	NJM2505AF	1	22242490R2	< B, >
Q2	IC	78M09HF(NJM78M09FA)	1	222780095JRC	< DC, D, MA, MB, MO, MP, MQ, MR, >
Q4000	TR	KRC105S	1	2217290R2	< B, >
Q4000 or	TR	RN1405	(1)	2214500R2	< B, >

Q4001	IC	78M05(NJM78M05FA)	1	22278005JRC	< B, >
Q4002	IC	S18008TM	1	22242323R2	< B, >
Q4003	TR	KRC105S	1	2217290R2	< B, >
Q4003 or	TR	RN1405	(1)	2214500R2	< B, >
Q4100	IC	NJW1325	1	22242596R3	< B, >
Q4101	TR ARRAY	UM6K1N	1	226066R2	< B, >
Q4500	TR	2SA950-Y	1	2211504T	< DC, D, MA, MB, MO, MP, MQ, MR, , >
Q4500 or	TR	2SA950-O	(1)	2211503T	< DC, D, MA, MB, MO, MP, MQ, MR, , >
Q4501	TR	2SC1815-GR	1	2211255T	< DC, D, MA, MB, MO, MP, MQ, MR, , >
Q4502	TR	2SA950-Y	1	2211504T	< B, >
Q4502 or	TR	2SA950-O	(1)	2211503T	< B, >
Q4503	TR	2SC1815-GR	1	2211255T	< B, >
Q4504	TR	2SA854S-R	1	2217394T	< B, >
Q4504 or	TR	2SB1240-R	(1)	2213794T	< B, >
Q4700	IC	ICL3221ECVZ	1	22242268R2	< DC, D, MA, MB, MO, MP, MQ, MR, , >
Q4901	IC	TC4052BF(EL_N_F)	1	222840521R2TO	
Q4902	IC	TC4052BF(EL_N_F)	1	222840521R2TO	
Q4903	IC	NJM2585M	1	22242352R2	
Q9	IC	NJM4580M-D	1	22241448R2	< DC, D, MA, MB, MO, MP, MQ, MR, >

[TRANS COIL]

L1090	CHOKE COIL	BLM21PG221SNI	1	230949R2	< B, >
L1290	CHOKE COIL	LBC2518T470M	1	231364M470R2	< B, >
L1301	CHOKE COIL	LBC2518T470M	1	231364M470R2	< B, >
L1305	CHOKE COIL	LBC2518T2R2M	1	231364M022R2	< B, >
L1306	CHOKE COIL	LBC2518T470M	1	231364M470R2	< B, >
L1307	CHOKE COIL	LBC2518T2R2M	1	231364M022R2	< B, >
L1308	CHOKE COIL	LBC2518T2R2M	1	231364M022R2	< B, >
L1309	CHOKE COIL	LBC2518T4R7M	1	231364M047R2	< B, >
L1312	CHOKE COIL	LBC2518T470M	1	231364M470R2	< B, >
L1313	CHOKE COIL	LBC2518T4R7M	1	231364M047R2	< B, >
L1314	CHOKE COIL	LBC2518T4R7M	1	231364M047R2	< B, >
L1315	CHOKE COIL	LBC2518T4R7M	1	231364M047R2	< B, >
L1316	EMIFIL	BK1608LM182-T	1	230958R1	< B, >
L1317	EMIFIL	BK1608LM182-T	1	230958R1	< B, >
L1318	CHOKE COIL	LBC2518T470M	1	231364M470R2	< B, >
L1319	CHOKE COIL	LBC2518T470M	1	231364M470R2	< B, >
L1320	EMIFIL	BK1608LM182-T	1	230958R1	< B, >
L1321	EMIFIL	BK1608LM182-T	1	230958R1	< B, >
L1322	EMIFIL	BK1608LM182-T	1	230958R1	< B, >

L1323	EMIFIL	BK1608HS102-T	1	230955R2	< B, >
L1324	EMIFIL	BK1608HS102-T	1	230955R2	< B, >
L1325	EMIFIL	BK1608HS102-T	1	230955R2	< B, >
L1404	CHOKE COIL	LBC2518T4R7M	1	231364M047R2	< B, >
L1407	CHOKE COIL	LBC2518T4R7M	1	231364M047R2	< B, >
L1900	CHOKE COIL	BLM21PG221SN1	1	230949R2	< B, >
L1901	CHOKE COIL	BLM21PG221SN1	1	230949R2	< B, >
L1902	EMIFIL	BK1608LM182-T	1	230958R1	< B, >
L1903	EMIFIL	BK1608LM182-T	1	230958R1	< B, >
L1904	EMIFIL	BK1608LM182-T	1	230958R1	< B, >
L1905	EMIFIL	BK1608LM182-T	1	230958R1	< B, >
L1906	CHOKE COIL	BLM21PG221SN1	1	230949R2	< B, >
L1907	CHOKE COIL	BLM21PG221SN1	1	230949R2	< B, >
L1908	EMIFIL	BK1608LM182-T	1	230958R1	< B, >
L1909	EMIFIL	BK1608LM182-T	1	230958R1	< B, >
L1910	EMIFIL	BK1608LM182-T	1	230958R1	< B, >
L1911	EMIFIL	BK1608LM182-T	1	230958R1	< B, >
L1912	EMIFIL	BK1608LM182-T	1	230958R1	< B, >
L1913	EMIFIL	BK1608LM182-T	1	230958R1	< B, >
L1914	EMIFIL	BK1608LM182-T	1	230958R1	< B, >
L1915	EMIFIL	BK1608LM182-T	1	230958R1	< B, >
L1916	EMIFIL	BK1608LM182-T	1	230958R1	< B, >
L1917	EMIFIL	BK1608LM182-T	1	230958R1	< B, >
L1918	EMIFIL	BK1608LM182-T	1	230958R1	< B, >
L1919	EMIFIL	BK1608LM182-T	1	230958R1	< B, >
L1920	EMIFIL	BK1608LM182-T	1	230958R1	< B, >
L1921	EMIFIL	BK1608LM182-T	1	230958R1	< B, >
L4000	COIL	0182-7310-470K-RB	1	231389	< B, >
L4001	CHOKE COIL	LBC2518T4R7M	1	231364M047R2	< B, >
L4005	CHOKE COIL	LBC2518T4R7M	1	231364M047R2	< B, >
L4700	CHOKE COIL	LBC2518T470M	1	231364M470R2	< B, >
L5	CHOKE COIL	LBC2518T100M	1	231364M100R2	< DC, D, MA, MB, MO, MP, MQ, MR, >
X1001	CERA LOCK	CSTCR5M00G53-B0	1	3010356R2	< B, >
X1002	CERA LOCK	CSTCE8M00G55-R0	1	3010416R2	< DC, D, MA, MB, MO, MP, MQ, MR, >
X101	CRYSTAL	HC-49S 4.332MHz	1	3010469T	< MA, MB, MO, MP, MQ, MR, >
X1301	CRYSTAL	HC-49US24.576MHz	1	3010423T	< B, >

[CAPACITOR]

C1	UTSP C	CE04W50V-10M(UTSP)	1	397581007T	< DC, D, MA, MB, MO, MP, MQ, MR, >
C1001	C-CERA C	CK725F1A-105Z1	1	332181050R1	< B, >

C1004	C-CERA C	CK725F1A-105Z1	1	332181050R1	< B, >
C1005	C-CERA C	CK725F1E-104Z1	1	332161040R1	< B, >
C1006	C-CERA C	CK725F1E-104Z1	1	332161040R1	< B, >
C1007	C-CERA C	CK725F1A-105Z1	1	332181050R1	< B, >
C1008	C-CERA C	CG725CH1H-101J1	1	342101014R1	< B, >
C1009	C-CERA C	CG725CH1H-101J1	1	342101014R1	< B, >
C1010	C-CERA C	CG725CH1H-221J1	1	342102214R1	< MA, MB, MO, MP, MQ, MR, >
C1010	C-CERA C	CG725CH1H-101J1	1	342101014R1	< B, >
C1015	UTSP C	CE04W25V-100M(UTSP)	1	397551017T	< B, >
C1017	UTSP C	CE04W10V-100M(UTSP)	1	397531017T	< B, >
C1019	UTSP C	CE04W10V-100M(UTSP)	1	397531017T	< B, >
C102	C-CERA C	CG725CH1H-331J1	1	342103314R1	< MA, MB, MO, MP, MQ, MR, >
C1020	C-CERA C	CK725F1A-105Z1	1	332181050R1	< B, >
C1021	C-CERA C	CK725B1H-102K1	1	332101025R1	< B, >
C1022	C-CERA C	CK725B1H-102K1	1	332101025R1	< B, >
C1023	ELECT C	CE04W25V-4.7M(MA)	1	355750479T	< B, >
C1024	C-CERA C	CK725B1H-102K1	1	332101025R1	< B, >
C1025	C-CERA C	CK725B1H-102K1	1	332101025R1	< B, >
C1026	C-CERA C	CK725B1H-102K1	1	332101025R1	< B, >
C1027	C-CERA C	CK725B1H-102K1	1	332101025R1	< B, >
C1028	UTSP C	CE04W50V-10M(UTSP)	1	397581007T	< B, >
C1029	UTSP C	CE04W10V-100M(UTSP)	1	397531017T	< B, >
C103	UTSP C	CE04W50V-10M(UTSP)	1	397581007T	< MA, MB, MO, MP, MQ, MR, >
C1030	C-CERA C	CK725F1E-104Z1	1	332161040R1	< B, >
C1031	C-CERA C	CK725F1E-104Z1	1	332161040R1	< B, >
C1032	C-CERA C	CK725F1E-104Z1	1	332161040R1	< B, >
C1033	C-CERA C	CK725F1E-104Z1	1	332161040R1	< B, >
C1034	C-CERA C	CK725F1E-104Z1	1	332161040R1	< B, >
C1036	C-CERA C	CK725F1E-104Z1	1	332161040R1	< B, >
C1037	C-CERA C	CK725F1E-104Z1	1	332161040R1	< B, >
C1038	UTSP C	CE04W50V-10M(UTSP)	1	397581007T	< B, >
C1039	C-CERA C	CK725F1E-104Z1	1	332161040R1	< B, >
C104	UTSP C	CE04W50V-10M(UTSP)	1	397581007T	< MA, MB, MO, MP, MQ, MR, >
C1040	UTSP C	CE04W10V-470M(UTSP)	1	397534717T	< B, >
C1041	ELECT C	CE04W16V-10M	1	355741009T	< B, >
C1042	C-CERA C	CK725F1E-104Z1	1	332161040R1	< B, >
C1043	C-CERA C	CK725F1A-105Z1	1	332181050R1	< B, >
C1044	C-CERA C	CK725F1A-105Z1	1	332181050R1	< B, >
C1045	C-CERA C	CK725F1A-105Z1	1	332181050R1	< B, >

C1046	C-CERA C	CK725F1A-105Z1	1	332181050R1	< B, >
C1047	C-CERA C	CK725F1A-105Z1	1	332181050R1	< B, >
C1048	C-CERA C	CK725F1A-105Z1	1	332181050R1	< B, >
C105	C-CERA C	CK725B1H-103K1	1	332101035R1	< MA, MB, MO, MP, MQ, MR, >
C1053	C-CERA C	CK725B1H-102K1	1	332101025R1	< DC, D, MA, MB, MO, MP, MQ, MR, >
C1054	UTSP C	CE04W10V-220M(UTSP)	1	397532217T	< DC, D, MA, MB, MO, MP, MQ, MR, >
C106	C-CERA C	CC725CH1H-331J1	1	342103314R1	< MA, MB, MO, MP, MQ, MR, >
C1060	C-CERA C	CK725B1H-102K1	1	332101025R1	< B, >
C1061	C-CERA C	CK725B1H-102K1	1	332101025R1	< B, >
C107	C-CERA C	CK725F1E-104Z1	1	332161040R1	< MA, MB, MO, MP, MQ, MR, >
C108	C-CERA C	CC725CH1H-150J1	1	342101504R1	< MA, MB, MO, MP, MQ, MR, >
C109	C-CERA C	CC725CH1H-150J1	1	342101504R1	< MA, MB, MO, MP, MQ, MR, >
C110	C-CERA C	CK725F1A-105Z1	1	332181050R1	< MA, MB, MO, MP, MQ, MR, >
C1101	UTSP C	CE04W10V-470M(UTSP)	1	397534717T	< DC, D, MA, MB, MO, MP, MQ, MR, >
C1104	C-CERA C	CK725F1E-104Z1	1	332161040R1	< DC, D, MA, MB, MO, MP, MQ, MR, >
C1290	UTSP C	CE04W25V-100M(UTSP)	1	397551017T	< B, >
C1291	C-CERA C	CK725F1E-104Z1	1	332161040R1	< B, >
C1292	UTSP C	CE04W50V-10M(UTSP)	1	397581007T	< B, >
C1293	UTSP C	CE04W50V-10M(UTSP)	1	397581007T	< B, >
C1294	UTSP C	CE04W50V-22M(UTSP)	1	397582207T	< B, >
C1295	UTSP C	CE04W50V-22M(UTSP)	1	397582207T	< B, >
C1296	UTSP C	CE04W50V-22M(UTSP)	1	397582207T	< B, >
C1302	UTSP C	CE04W10V-100M(UTSP)	1	397531017T	< B, >
C1303	UTSP C	CE04W50V-47M(UTSP)	1	397584707T	< B, >
C1304	C-CERA C	CK725F1E-104Z1	1	332161040R1	< B, >
C1305	UTSP C	CE04W10V-470M(UTSP)	1	397534717T	< B, >
C1306	C-CERA C	CK725F1E-104Z1	1	332161040R1	< B, >
C1307	UTSP C	CE04W50V-10M(UTSP)	1	397581007T	< B, >
C1308	C-CERA C	CK725F1E-104Z1	1	332161040R1	< B, >
C1309	C-CERA C	CK725F1E-104Z1	1	332161040R1	< B, >
C1310	UTSP C	CE04W10V-470M(UTSP)	1	397534717T	< B, >
C1311	C-CERA C	CK725F1E-104Z1	1	332161040R1	< B, >
C1365	C-CERA C	CK725B1C-104K1	1	332121045R1	< B, >
C1366	C-CERA C	CC725CH1H-101J1	1	342101014R1	< B, >
C1368	C-CERA C	CC725CH1H-101J1	1	342101014R1	< B, >
C1369	UTSP C	CE04W10V-100M(UTSP)	1	397531017T	< B, >
C1370	UTSP C	CE04W10V-470M(UTSP)	1	397534717T	< B, >
C1371	C-CERA C	CK725F1E-104Z1	1	332161040R1	< B, >
C1372	C-CERA C	CK725F1E-104Z1	1	332161040R1	< B, >

C1373	C-CERA C	CK725F1E-104Z1	1	332161040R1	< B, >
C1374	UTSP C	CE04W10V-470M(UTSP)	1	397534717T	< B, >
C1375	C-CERA C	CK725B1C-104K1	1	332121045R1	< B, >
C1376	UTSP C	CE04W10V-100M(UTSP)	1	397531017T	< B, >
C1377	UTSJ C	CE04W50V-47M(UTSJ)	1	398084707T	< B, >
C1379	C-CERA C	CK725F1E-104Z1	1	332161040R1	< B, >
C1380	C-CERA C	CK725B1C-104K1	1	332121045R1	< B, >
C1381	C-CERA C	CG725CH1H-101J1	1	342101014R1	< B, >
C1388	C-CERA C	CK725B1H-102K1	1	332101025R1	< B, >
C1390	C-CERA C	CK725B1H-223K1	1	332102235R1	< B, >
C1392	C-CERA C	CK725F1E-104Z1	1	332161040R1	< B, >
C1396	C-CERA C	CK725F1E-104Z1	1	332161040R1	< B, >
C1397	C-CERA C	CK725B1H-102K1	1	332101025R1	< B, >
C1398	C-CERA C	CK725F1E-104Z1	1	332161040R1	< B, >
C1399	UTSP C	CE04W10V-470M(UTSP)	1	397534717T	< B, >
C1400	C-CERA C	CK725F1E-104Z1	1	332161040R1	< B, >
C1401	C-CERA C	CG725CH1H-330J1	1	342103304R1	< B, >
C1402	C-CERA C	CG725CH1H-330J1	1	342103304R1	< B, >
C1403	C-CERA C	CG725CH1H-330J1	1	342103304R1	< B, >
C1404	C-CERA C	CG725CH1H-330J1	1	342103304R1	< B, >
C1405	C-CERA C	CG725CH1H-330J1	1	342103304R1	< B, >
C1406	C-CERA C	CG725CH1H-330J1	1	342103304R1	< B, >
C1408	C-CERA C	CG725CH1H-080D1	1	342100802R1	< B, >
C1409	C-CERA C	CG725CH1H-080D1	1	342100802R1	< B, >
C1410	UTSP C	CE04W10V-470M(UTSP)	1	397534717T	< B, >
C1411	UTSP C	CE04W10V-470M(UTSP)	1	397534717T	< B, >
C1413	C-CERA C	CK725F1E-104Z1	1	332161040R1	< B, >
C1414	C-CERA C	CK725F1E-104Z1	1	332161040R1	< B, >
C1415	C-CERA C	CK725F1E-104Z1	1	332161040R1	< B, >
C1417	C-CERA C	CK725F1E-104Z1	1	332161040R1	< B, >
C1418	C-CERA C	CK725F1E-104Z1	1	332161040R1	< B, >
C1419	C-CERA C	CG725CH1H-080D1	1	342100802R1	< B, >
C1421	UTSP C	CE04W10V-220M(UTSP)	1	397532217T	< B, >
C1424	C-CERA C	CG725CH1H-060D1	1	342100602R1	< B, >
C1425	C-CERA C	CG725CH1H-060D1	1	342100602R1	< B, >
C1430	UTSP C	CE04W10V-470M(UTSP)	1	397534717T	< B, >
C1454	C-FILM C	ECHU16V-104J	1	373041044R2	< B, >
C1455	C-FILM C	ECHU16V-104J	1	373041044R2	< B, >
C1456	C-FILM C	ECHU16V-104J	1	373041044R2	< B, >

C1460	UTSJ C	CE04W50V-47M(UTSJ)	1	398084707T	< B, >
C1499	UTSP C	CE04W10V-100M(UTSP)	1	397531017T	< B, >
C1582	C-FILM C	ECHU50V-222J	1	373022224R2	< B, >
C1583	C-FILM C	ECHU50V-222J	1	373022224R2	< B, >
C1600	UPZ C	2AUPZTF331JE	1	376333314T	< DC, D, MA, MB, MO, MP, MQ, MR, >
C1600	UPZ C	2AUPZTF471JE	1	376334714T	< DC, D, MA, MB, MO, MP, MQ, MR, >
C1601	UPZ C	2AUPZTF331JE	1	376333314T	< DC, D, MA, MB, MO, MP, MQ, MR, >
C1601	UPZ C	2AUPZTF471JE	1	376334714T	< DC, D, MA, MB, MO, MP, MQ, MR, >
C1602	UPZ C	2AUPZTF331JE	1	376333314T	< DC, D, MA, MB, MO, MP, MQ, MR, >
C1602	UPZ C	2AUPZTF471JE	1	376334714T	< DC, D, MA, MB, MO, MP, MQ, MR, >
C1603	UPZ C	2AUPZTF331JE	1	376333314T	< DC, D, MA, MB, MO, MP, MQ, MR, >
C1603	UPZ C	2AUPZTF471JE	1	376334714T	< DC, D, MA, MB, MO, MP, MQ, MR, >
C1604	UPZ C	2AUPZTF331JE	1	376333314T	< DC, D, MA, MB, MO, MP, MQ, MR, >
C1604	UPZ C	2AUPZTF471JE	1	376334714T	< DC, D, MA, MB, MO, MP, MQ, MR, >
C1605	UPZ C	2AUPZTF331JE	1	376333314T	< DC, D, MA, MB, MO, MP, MQ, MR, >
C1605	UPZ C	2AUPZTF471JE	1	376334714T	< DC, D, MA, MB, MO, MP, MQ, MR, >
C1606	UPZ C	2AUPZTF331JE	1	376333314T	< DC, D, MA, MB, MO, MP, MQ, MR, >
C1606	UPZ C	2AUPZTF471JE	1	376334714T	< DC, D, MA, MB, MO, MP, MQ, MR, >
C1607	UPZ C	2AUPZTF331JE	1	376333314T	< DC, D, MA, MB, MO, MP, MQ, MR, >
C1607	UPZ C	2AUPZTF471JE	1	376334714T	< DC, D, MA, MB, MO, MP, MQ, MR, >
C1610	CERA C	CG45SL50V-101J	1	345021014T	< DC, D, MA, MB, MO, MP, MQ, MR, >
C1610	CERA C	CG45SL50V-470J	1	345024704T	< DC, D, MA, MB, MO, MP, MQ, MR, >
C1611	CERA C	CG45SL50V-101J	1	345021014T	< DC, D, MA, MB, MO, MP, MQ, MR, >
C1611	CERA C	CG45SL50V-470J	1	345024704T	< DC, D, MA, MB, MO, MP, MQ, MR, >
C1612	CERA C	CG45SL50V-101J	1	345021014T	< DC, D, MA, MB, MO, MP, MQ, MR, >
C1612	CERA C	CG45SL50V-470J	1	345024704T	< DC, D, MA, MB, MO, MP, MQ, MR, >
C1613	CERA C	CG45SL50V-101J	1	345021014T	< DC, D, MA, MB, MO, MP, MQ, MR, >
C1613	CERA C	CG45SL50V-470J	1	345024704T	< DC, D, MA, MB, MO, MP, MQ, MR, >
C1614	CERA C	CG45SL50V-101J	1	345021014T	< DC, D, MA, MB, MO, MP, MQ, MR, >
C1614	CERA C	CG45SL50V-470J	1	345024704T	< DC, D, MA, MB, MO, MP, MQ, MR, >
C1615	CERA C	CG45SL50V-101J	1	345021014T	< DC, D, MA, MB, MO, MP, MQ, MR, >
C1615	CERA C	CG45SL50V-470J	1	345024704T	< DC, D, MA, MB, MO, MP, MQ, MR, >
C1616	CERA C	CG45SL50V-101J	1	345021014T	< DC, D, MA, MB, MO, MP, MQ, MR, >
C1616	CERA C	CG45SL50V-470J	1	345024704T	< DC, D, MA, MB, MO, MP, MQ, MR, >
C1617	CERA C	CG45SL50V-101J	1	345021014T	< DC, D, MA, MB, MO, MP, MQ, MR, >
C1617	CERA C	CG45SL50V-470J	1	345024704T	< DC, D, MA, MB, MO, MP, MQ, MR, >
C1620	CERA C	CG45SL50V-101J	1	345021014T	< DC, D, MA, MB, MO, MP, MQ, MR, >
C1620	CERA C	CG45SL50V-470J	1	345024704T	< DC, D, MA, MB, MO, MP, MQ, MR, >
C1621	CERA C	CG45SL50V-101J	1	345021014T	< DC, D, MA, MB, MO, MP, MQ, MR, >

C1621	CERA C	CC45SL50V-470J	1	345024704T	
C1622	CERA C	CC45SL50V-101J	1	345021014T	< DC, D, MA, MB, MO, MP, MQ, MR, >
C1622	CERA C	CC45SL50V-470J	1	345024704T	
C1623	CERA C	CC45SL50V-101J	1	345021014T	< DC, D, MA, MB, MO, MP, MQ, MR, >
C1623	CERA C	CC45SL50V-470J	1	345024704T	
C1624	CERA C	CC45SL50V-101J	1	345021014T	< DC, D, MA, MB, MO, MP, MQ, MR, >
C1624	CERA C	CC45SL50V-470J	1	345024704T	
C1625	CERA C	CC45SL50V-101J	1	345021014T	< DC, D, MA, MB, MO, MP, MQ, MR, >
C1625	CERA C	CC45SL50V-470J	1	345024704T	
C1626	CERA C	CC45SL50V-101J	1	345021014T	< DC, D, MA, MB, MO, MP, MQ, MR, >
C1626	CERA C	CC45SL50V-470J	1	345024704T	
C1627	CERA C	CC45SL50V-101J	1	345021014T	< DC, D, MA, MB, MO, MP, MQ, MR, >
C1627	CERA C	CC45SL50V-470J	1	345024704T	
C1630	C-FILM C	ECHU50V-122J	1	373021224R2	
C1631	C-FILM C	ECHU50V-122J	1	373021224R2	
C1632	C-FILM C	ECHU50V-122J	1	373021224R2	
C1633	C-FILM C	ECHU50V-122J	1	373021224R2	
C1634	C-FILM C	ECHU50V-122J	1	373021224R2	
C1635	C-FILM C	ECHU50V-122J	1	373021224R2	
C1636	C-FILM C	ECHU50V-122J	1	373021224R2	
C1637	C-FILM C	ECHU50V-122J	1	373021224R2	
C1640	UPZ C	2AUPZTF471JE	1	376334714T	
C1641	UPZ C	2AUPZTF471JE	1	376334714T	
C1642	UPZ C	2AUPZTF471JE	1	376334714T	
C1643	UPZ C	2AUPZTF471JE	1	376334714T	
C1644	UPZ C	2AUPZTF471JE	1	376334714T	
C1645	UPZ C	2AUPZTF471JE	1	376334714T	
C1646	UPZ C	2AUPZTF471JE	1	376334714T	
C1647	UPZ C	2AUPZTF471JE	1	376334714T	
C1650	UTSP C	CE04W25V-220M(UTSP)	1	397552217T	< B, >
C1651	UTSP C	CE04W25V-220M(UTSP)	1	397552217T	< B, >
C1800	UTSP C	CE04W25V-47M(UTSP)	1	397554707T	< B, >
C1801	UTSP C	CE04W25V-47M(UTSP)	1	397554707T	< B, >
C1810	UTSP C	CE04W25V-47M(UTSP)	1	397554707T	< B, >
C1811	UTSP C	CE04W25V-47M(UTSP)	1	397554707T	< B, >
C1900	UTSP C	CE04W25V-100M(UTSP)	1	397551017T	< B, >
C1902	UTSP C	CE04W25V-100M(UTSP)	1	397551017T	< B, >
C1904	UTSP C	CE04W50V-10M(UTSP)	1	397581007T	< B, >
C1905	UTSP C	CE04W50V-10M(UTSP)	1	397581007T	< B, >

C1906	C-CERA C	CC725CHIH-101J1	1	342101014R1	< B, >
C1907	C-CERA C	CC725CHIH-101J1	1	342101014R1	< B, >
C1908	UTSP C	CE04W50V-10M(UTSP)	1	397581007T	< B, >
C1909	UTSP C	CE04W50V-10M(UTSP)	1	397581007T	< B, >
C1911	C-CERA C	CC725CHIH-101J1	1	342101014R1	< B, >
C1912	C-CERA C	CC725CHIH-101J1	1	342101014R1	< B, >
C1913	C-CERA C	CC725CHIH-470J1	1	342104704R1	< B, >
C1914	C-CERA C	CK725F1E-104Z1	1	332161040R1	< B, >
C1915	C-CERA C	CK725F1E-104Z1	1	332161040R1	< B, >
C1921	C-CERA C	CC725CHIH-471J1	1	342104714R1	< B, >
C1922	C-CERA C	CC725CHIH-471J1	1	342104714R1	< B, >
C1923	C-CERA C	CC725CHIH-221J1	1	342102214R1	< B, >
C1924	C-CERA C	CC725CHIH-221J1	1	342102214R1	< B, >
C1930	C-CERA C	CK725F1E-104Z1	1	332161040R1	< B, >
C1931	C-CERA C	CC725CHIH-470J1	1	342104704R1	< B, >
C1941	UTSP C	CE04W25V-100M(UTSP)	1	397551017T	< B, >
C1942	C-CERA C	CK725F1E-104Z1	1	332161040R1	< B, >
C1943	C-CERA C	CK725F1E-104Z1	1	332161040R1	< B, >
C1944	UTSP C	CE04W25V-47M(UTSP)	1	397554707T	< B, >
C1951	VR C	CE04W6.3V-470M(VR)	1	394624717T	< B, >
C1952	VR C	CE04W6.3V-470M(VR)	1	394624717T	< B, >
C1953	UTSP C	CE04W50V-10M(UTSP)	1	397581007T	< B, >
C1954	UTSP C	CE04W10V-100M(UTSP)	1	397531017T	< B, >
C1955	C-CERA C	CK725F1E-104Z1	1	332161040R1	< B, >
C1956	C-CERA C	CC725CHIH-470J1	1	342104704R1	< B, >
C1957	C-CERA C	CC725CHIH-470J1	1	342104704R1	< B, >
C1961	VR C	CE04W6.3V-470M(VR)	1	394624717T	< B, >
C1962	VR C	CE04W6.3V-470M(VR)	1	394624717T	< B, >
C1963	UTSP C	CE04W50V-10M(UTSP)	1	397581007T	< B, >
C1964	UTSP C	CE04W10V-100M(UTSP)	1	397531017T	< B, >
C1965	C-CERA C	CK725F1E-104Z1	1	332161040R1	< B, >
C1966	C-CERA C	CC725CHIH-470J1	1	342104704R1	< B, >
C1967	C-CERA C	CC725CHIH-470J1	1	342104704R1	< B, >
C1971	VR C	CE04W6.3V-470M(VR)	1	394624717T	< B, >
C1972	VR C	CE04W6.3V-470M(VR)	1	394624717T	< B, >
C1973	UTSP C	CE04W50V-10M(UTSP)	1	397581007T	< B, >
C1974	UTSP C	CE04W10V-100M(UTSP)	1	397531017T	< B, >
C1975	C-CERA C	CK725F1E-104Z1	1	332161040R1	< B, >
C1976	C-CERA C	CK725B1H-102K1	1	332101025R1	< B, >

C1977	C-CERA C	CC725CH1H-470I1	1	342104704R1	< B, >
C1978	C-CERA C	CK725B1H-102K1	1	332101025R1	< B, >
C1979	C-CERA C	CK725B1H-102K1	1	332101025R1	< B, >
C1980	C-CERA C	CC725CH1H-470I1	1	342104704R1	< B, >
C1981	C-CERA C	CC725CH1H-470I1	1	342104704R1	< B, >
C2	VR C	CE04W16V-100M(VR)	1	394641017T	< DC, D, MA, MB, MO, MP, MQ, MR, >
C4000	UTSP C	CE04W50V-4.7M(UTSP)	1	397580477T	< B, >
C4001	VR C	CE04W16V-470M(VR)	1	394644717T	< B, >
C4002	UTSP C	CE04W10V-470M(UTSP)	1	397534717T	< B, >
C4003	TF C	ECQ-V50V-334J	1	374723344T	< B, >
C4004	UTSP C	CE04W10V-470M(UTSP)	1	397534717T	< B, >
C4005	C-CERA C	CK725B1H-223K1	1	332102235R1	< B, >
C4006	C-CERA C	CK725F1E-104Z1	1	332161040R1	< B, >
C4007	ELECT C	CE04W35V-4700M(VZ)	1	394564727S	< B, >
C4009	TF C	ECQ-V50V-334J	1	374723344T	< B, >
C4010	TF C	ECQ-V50V-334J	1	374723344T	< B, >
C4012	TF C	ECQ-V50V-334J	1	374723344T	< B, >
C4013	ELECT C	CE04W35V-4700M(VZ)	1	394564727S	< B, >
C4100	UTSP C	CE04W50V-10M(UTSP)	1	397581007T	< B, >
C4101	UTSP C	CE04W50V-10M(UTSP)	1	397581007T	< B, >
C4102	UTSP C	CE04W50V-10M(UTSP)	1	397581007T	< B, >
C4103	UTSP C	CE04W50V-2.2M(UTSP)	1	397580227T	< B, >
C4111	C-CERA C	CK725F1E-104Z1	1	332161040R1	< B, >
C4112	C-CERA C	CK725B1H-102K1	1	332101025R1	< B, >
C4114	UTSP C	CE04W50V-1M(UTSP)	1	397580107T	< B, >
C4115	VR C	CE04W6.3V-470M(VR)	1	394624717T	< B, >
C4119	VR C	CE04W6.3V-470M(VR)	1	394624717T	< B, >
C4121	C-CERA C	CK725F1E-104Z1	1	332161040R1	< B, >
C4122	UTSP C	CE04W50V-1M(UTSP)	1	397580107T	< B, >
C4123	UTSP C	CE04W50V-2.2M(UTSP)	1	397580227T	< B, >
C4124	VR C	CE04W6.3V-470M(VR)	1	394624717T	< B, >
C4125	VR C	CE04W6.3V-470M(VR)	1	394624717T	< B, >
C4126	VR C	CE04W6.3V-470M(VR)	1	394624717T	< B, >
C4129	C-CERA C	CK725F1E-104Z1	1	332161040R1	< DC, D, MA, MB, MO, MP, MQ, MR, >
C4131	C-CERA C	CK725B1H-102K1	1	332101025R1	< B, >
C4132	VR C	CE04W6.3V-470M(VR)	1	394624717T	< B, >
C4133	UTSP C	CE04W50V-1M(UTSP)	1	397580107T	< B, >
C4134	C-CERA C	CK725F1E-104Z1	1	332161040R1	< B, >
C4135	UTSP C	CE04W25V-47M(UTSP)	1	397554707T	< B, >

C4136	C-CERA C	CK725BIH-102K1	1	332101025R1	< B, >
C4137	C-CERA C	CK725B0J-106K	1	332091065R2	< B, >
C4138	VR C	CE04W6.3V-470M(VR)	1	394624717T	< B, >
C4139	UTSP C	CE04W50V-2.2M(UTSP)	1	397582207T	< B, >
C4140	C-CERA C	CK725F1E-104Z1	1	332161040R1	< B, >
C4141	UTSP C	CE04W50V-1M(UTSP)	1	397580107T	< B, >
C4143	VR C	CE04W6.3V-470M(VR)	1	394624717T	< B, >
C4144	C-CERA C	CK725F1E-104Z1	1	332161040R1	< B, >
C4145	UTSP C	CE04W50V-2.2M(UTSP)	1	397580227T	< B, >
C4146	VR C	CE04W6.3V-470M(VR)	1	394624717T	< B, >
C4150	VR C	CE04W6.3V-470M(VR)	1	394624717T	< B, >
C4151	UTSP C	CE04W25V-47M(UTSP)	1	397554707T	< B, >
C4152	UTSP C	CE04W25V-47M(UTSP)	1	397554707T	< B, >
C4154	C-CERA C	CK725F1E-104Z1	1	332161040R1	< B, >
C4156	UTSP C	CE04W25V-47M(UTSP)	1	397554707T	< B, >
C4157	VR C	CE04W6.3V-470M(VR)	1	394624717T	< B, >
C4159	C-CERA C	CK725BIH-102K1	1	332101025R1	< B, >
C4160	VR C	CE04W6.3V-470M(VR)	1	394624717T	< B, >
C4161	C-CERA C	CK725F1E-104Z1	1	332161040R1	< B, >
C4162	C-CERA C	CK725F1E-104Z1	1	332161040R1	< B, >
C4163	VR C	CE04W6.3V-470M(VR)	1	394624717T	< B, >
C4167	C-CERA C	CK725F1A-105Z1	1	332181050R1	< B, >
C4168	UTSP C	CE04W50V-1M(UTSP)	1	397580107T	< B, >
C4169	UTSP C	CE04W50V-2.2M(UTSP)	1	397580227T	< B, >
C4173	VR C	CE04W6.3V-470M(VR)	1	394624717T	< B, >
C4174	C-CERA C	CK725BIH-102K1	1	332101025R1	< B, >
C4175	C-CERA C	CK725F1A-105Z1	1	332181050R1	< B, >
C4176	UTSP C	CE04W50V-1M(UTSP)	1	397580107T	< B, >
C4179	UTSP C	CE04W50V-2.2M(UTSP)	1	397580227T	< B, >
C4183	C-CERA C	CK725F1E-104Z1	1	332161040R1	< B, >
C4184	UTSP C	CE04W25V-47M(UTSP)	1	397554707T	< B, >
C4186	UTSP C	CE04W25V-47M(UTSP)	1	397554707T	< B, >
C4187	UTSP C	CE04W25V-47M(UTSP)	1	397554707T	< B, >
C4192	UTSP C	CE04W50V-1M(UTSP)	1	397580107T	< B, >
C4193	C-CERA C	CC725CH1H-151J1	1	342101514R1	< B, >
C4194	C-CERA C	CC725CH1H-151J1	1	342101514R1	< B, >
C4195	C-CERA C	CC725CH1H-151J1	1	342101514R1	< B, >
C4196	C-CERA C	CK725BIH-102K1	1	332101025R1	< B, >
C4197	C-CERA C	CK725F1A-105Z1	1	332181050R1	< B, >

C4198	UTSP C	CE04W50V-1M(UTSP)	1	397580107T	< B, >
C4199	UTSP C	CE04W50V-2.2M(UTSP)	1	397580227T	< B, >
C4200	UTSP C	CE04W50V-1M(UTSP)	1	397580107T	< B, >
C4202	C-CERA C	CK725F1A-105Z1	1	332181050R1	< B, >
C4203	UTSP C	CE04W25V-47M(UTSP)	1	397554707T	< B, >
C4205	UTSP C	CE04W50V-1M(UTSP)	1	397580107T	< B, >
C4206	UTSP C	CE04W50V-2.2M(UTSP)	1	397580227T	< B, >
C4207	UTSP C	CE04W50V-1M(UTSP)	1	397580107T	< B, >
C4209	C-CERA C	CK725B1H-102K1	1	332101025R1	< B, >
C4211	VR C	CE04W6.3V-470M(VR)	1	394624717T	< B, >
C4212	C-CERA C	CC725CH1H-151J1	1	342101514R1	< B, >
C4213	C-CERA C	CC725CH1H-151J1	1	342101514R1	< B, >
C4214	C-CERA C	CC725CH1H-151J1	1	342101514R1	< B, >
C4215	UTSP C	CE04W25V-47M(UTSP)	1	397554707T	< B, >
C4218	C-CERA C	CK725F1E-104Z1	1	332161040R1	< B, >
C4219	C-CERA C	CK725F1E-104Z1	1	332161040R1	< B, >
C4226	VR C	CE04W6.3V-470M(VR)	1	394624717T	< B, >
C4228	C-CERA C	CK725F1E-104Z1	1	332161040R1	< DC, D, MA, MB, MO, MP, MQ, MR, >
C4234	VR C	CE04W6.3V-470M(VR)	1	394624717T	< B, >
C4235	VR C	CE04W6.3V-470M(VR)	1	394624717T	< B, >
C4236	UTSP C	CE04W50V-2.2M(UTSP)	1	397580227T	< DC, D, MA, MB, MO, MP, MQ, MR, >
C4237	UTSP C	CE04W50V-1M(UTSP)	1	397580107T	< DC, D, MA, MB, MO, MP, MQ, MR, >
C4238	UTSP C	CE04W50V-1M(UTSP)	1	397580107T	< DC, D, MA, MB, MO, MP, MQ, MR, >
C4239	UTSP C	CE04W50V-1M(UTSP)	1	397580107T	< DC, D, MA, MB, MO, MP, MQ, MR, >
C4240	UTSP C	CE04W50V-1M(UTSP)	1	397580107T	< DC, D, MA, MB, MO, MP, MQ, MR, >
C4241	UTSP C	CE04W50V-2.2M(UTSP)	1	397580227T	< DC, D, MA, MB, MO, MP, MQ, MR, >
C4253	C-CERA C	CK725F1E-104Z1	1	332161040R1	< DC, D, MA, MB, MO, MP, MQ, MR, >
C4253	C-CERA C	CC725CH1H-101J1	1	342101014R1	< DC, D, MA, MB, MO, MP, MQ, MR, >
C4254	C-CERA C	CK725F1E-104Z1	1	332161040R1	< DC, D, MA, MB, MO, MP, MQ, MR, >
C4255	C-CERA C	CK725F1E-104Z1	1	332161040R1	< DC, D, MA, MB, MO, MP, MQ, MR, >
C4256	C-CERA C	CK725F1E-104Z1	1	332161040R1	< DC, D, MA, MB, MO, MP, MQ, MR, >
C4500	UTSP C	CE04W25V-220M(UTSP)	1	397552217T	< B, >
C4501	UTSP C	CE04W25V-220M(UTSP)	1	397552217T	< DC, D, MA, MB, MO, MP, MQ, MR, >
C4502	UTSP C	CE04W25V-220M(UTSP)	1	397552217T	< B, >
C4503	UTSP C	CE04W25V-220M(UTSP)	1	397552217T	< B, >
C47	ELECT C	CE04W35V-10M(S)	1	353761009T	< DC, D, MA, MB, MO, MP, MQ, MR, >
C4700	UTSP C	CE04W50V-1M(UTSP)	1	397580107T	< B, >
C4701	UTSP C	CE04W50V-1M(UTSP)	1	397580107T	< B, >
C4702	VR C	CE04W16V-100M(VR)	1	394641017T	< B, >

C4703	C-CERA C	CK725F1E-104Z1	1	332161040R1	< B, >
C4704	UTSP C	CE04W50V-1M(UTSP)	1	397580107T	< B, >
C4705	UTSP C	CE04W50V-1M(UTSP)	1	397580107T	< B, >
C4706	C-CERA C	CK725B1H-102K1	1	332101025R1	< B, >
C48	ELECT C	CE04W35V-10M(S)	1	353761009T	< DC, D, MA, MB, MO, MP, MQ, MR, >
C4903	C-CERA C	CC725CH1H-220J1	1	342102204R1	
C4904	C-CERA C	CC725CH1H-220J1	1	342102204R1	
C4905	C-CERA C	CC725CH1H-220J1	1	342102204R1	
C4906	VR C	CE04W16V-100M(VR)	1	394641017T	
C4907	C-CERA C	CK725F1E-104Z1	1	332161040R1	
C4908	C-CERA C	CK725F1E-104Z1	1	332161040R1	
C4909	C-CERA C	CK725F1A-105Z1	1	332181050R1	
C4910	C-CERA C	CK725B1H-102K1	1	332101025R1	
C4911	VR C	CE04W6.3V-470M(VR)	1	394624717T	
C4912	C-CERA C	CK725F1A-105Z1	1	332181050R1	
C4913	C-CERA C	CK725B1H-102K1	1	332101025R1	
C4914	C-CERA C	CK725F1A-105Z1	1	332181050R1	
C4916	C-CERA C	CK725B1H-102K1	1	332101025R1	
C4917	C-CERA C	CK725B1H-102K1	1	332101025R1	
C4918	C-CERA C	CK725B0J-106K	1	332091065R2	
C4919	C-CERA C	CK725B0J-106K	1	332091065R2	
C4920	UTSP C	CE04W50V-0.47M(UTSP)	1	397584797T	
C4921	C-CERA C	CK725F1A-105Z1	1	332181050R1	
C4922	C-CERA C	CK725B1H-102K1	1	332101025R1	
C4923	C-CERA C	CK725B1H-102K1	1	332101025R1	
C4924	C-CERA C	CK725F1A-105Z1	1	332181050R1	
C4925	C-CERA C	CK725F1A-105Z1	1	332181050R1	
C4926	C-CERA C	CK725B1H-102K1	1	332101025R1	
C4927	C-CERA C	CK725B1H-103K1	1	332101035R1	
C52	UTSP C	CE04W50V-10M(UTSP)	1	397581007T	< DC, D>
C53	UTSP C	CE04W50V-10M(UTSP)	1	397581007T	< DC, D>
C7	UTSP C	CE04W25V-47M(UTSP)	1	39754707T	< DC, D, MA, MB, MO, MP, MQ, MR, >
[RESISTOR]					
C4170	C-CERA C	CK725B0J-106K	1	332091065R2	
C4171	C-CERA C	CK725B0J-106K	1	332091065R2	
C4172	C-CERA C	CK725B0J-106K	1	332091065R2	
R1001	C-CARBON R	RN72K1J-473JE	1	435034734R1	< B, >
R1002	C-CARBON R	RN72K1J-222JE	1	435032224R1	< B, >
R1003	C-CARBON R	RN72K1J-222JE	1	435032224R1	< B, >

R1004	C-CARBON R	RN72K1J-102JE	1	435031024R1	< B, >
R1005	C-CARBON R	RN72K1J-102JE	1	435031024R1	< B, >
R1006	C-CARBON R	RN72K1J-473JE	1	435034734R1	< B, >
R1007	C-CARBON R	RN72K1J-222JE	1	435032224R1	< B, >
R1008	C-CARBON R	RN72K1J-101JE	1	435031014R1	< B, >
R1010	C-CARBON R	RN72K1J-103JE	1	435031034R1	< B, >
R1011	C-CARBON R	RN72K1J-102JE	1	435031024R1	< B, >
R1012	C-CARBON R	RN72K1J-470JE	1	435034704R1	< B, >
R1013	C-CARBON R	RN72K1J-470JE	1	435034704R1	< B, >
R1014	C-CARBON R	RN72K1J-470JE	1	435034704R1	< B, >
R1015	C-CARBON R	RN72K1J-470JE	1	435034704R1	< B, >
R1016	C-CARBON R	RN72K1J-222JE	1	435032224R1	< B, >
R1017	C-CARBON R	RN72K1J-102JE	1	435031024R1	< B, >
R1019	C-CARBON R	RN72K1J-470JE	1	435034704R1	< B, >
R1020	C-CARBON R	RN72K1J-472JE	1	435034724R1	< B, >
R1026	C-CARBON R	RN72K1J-224JE	1	435032244R1	< B, >
R1027	C-CARBON R	RN72K1J-473JE	1	435034734R1	< B, >
R1028	C-CARBON R	RN72K1J-470JE	1	435034704R1	< B, >
R1029	C-CARBON R	RN72K1J-470JE	1	435034704R1	< B, >
R1031	C-CARBON R	RN72K1J-221JE	1	435032214R1	< B, >
R1032	C-CARBON R	RN72K1J-221JE	1	435032214R1	< B, >
R1033	C-CARBON R	RN72K1J-221JE	1	435032214R1	< B, >
R1034	C-CARBON R	RN72K1J-000JE	1	435030004R1	< B, >
R1035	C-CARBON R	RN72K1J-103JE	1	435031034R1	< B, >
R1036	C-CARBON R	RN72K1J-222JE	1	435032224R1	< B, >
R1037	C-CARBON R	RN72K1J-473JE	1	435034734R1	< B, >
R1038	C-CARBON R	RN72K1J-473JE	1	435034734R1	< B, >
R1039	C-CARBON R	RN72K1J-473JE	1	435034734R1	< B, >
R1040	C-CARBON R	RN72K1J-473JE	1	435034734R1	< B, >
R1041	C-CARBON R	RN72K1J-103JE	1	435031034R1	< B, >
R1042	C-CARBON R	RN72K1J-473JE	1	435034734R1	< B, >
R1043	C-CARBON R	RN72K1J-473JE	1	435034734R1	< B, >
R1044	C-CARBON R	RN72K1J-470JE	1	435034704R1	< B, >
R1045	C-CARBON R	RN72K1J-470JE	1	435034704R1	< B, >
R1046	C-CARBON R	RN72K1J-222JE	1	435032224R1	< B, >
R1047	C-CARBON R	RN72K1J-102JE	1	435031024R1	< B, >
R1048	C-CARBON R	RN72K1J-473JE	1	435034734R1	< B, >
R1049	C-CARBON R	RN72K1J-470JE	1	435034704R1	< B, >
R1050	C-CARBON R	RN72K1J-470JE	1	435034704R1	< B, >

R1051	C-CARBON R	RN72K1J-473JE	1	435034734R1	< B, >
R1052	C-CARBON R	RN72K1J-473JE	1	435034734R1	< B, >
R1055	C-CARBON R	RN72K1J-273JE	1	435032734R1	< B, >
R1056	C-CARBON R	RN72K1J-273JE	1	435032734R1	< B, >
R1057	C-CARBON R	RN72K1J-470JE	1	435034704R1	< B, >
R1058	C-CARBON R	RN72K1J-103JE	1	435031034R1	< B, >
R1059	C-CARBON R	RN72K1J-103JE	1	435031034R1	< B, >
R1060	C-CARBON R	RN72K1J-470JE	1	435034704R1	< B, >
R1061	C-CARBON R	RN72K1J-103JE	1	435031034R1	< B, >
R1062	C-CARBON R	RN72K1J-470JE	1	435034704R1	< B, >
R1063	C-CARBON R	RN72K1J-470JE	1	435034704R1	< B, >
R1064	C-CARBON R	RN72K1J-222JE	1	435032224R1	< B, >
R1065	C-CARBON R	RN72K1J-221JE	1	435032214R1	< B, >
R1066	C-CARBON R	RN72K1J-470JE	1	435034704R1	< B, >
R1067	C-CARBON R	RN72K1J-224JE	1	435032244R1	< B, >
R1068	C-CARBON R	RN72K1J-273JE	1	435032734R1	< B, >
R1069	C-CARBON R	RN72K1J-101JE	1	435031014R1	< B, >
R1070	C-CARBON R	RN72K1J-103JE	1	435031034R1	< B, >
R1071	C-CARBON R	RN72K1J-473JE	1	435034734R1	< B, >
R1072	C-CARBON R	RN72K1J-473JE	1	435034734R1	< B, >
R1073	C-CARBON R	RN72K1J-473JE	1	435034734R1	< B, >
R1074	C-CARBON R	RN72K1J-473JE	1	435034734R1	< B, >
R1075	C-CARBON R	RN72K1J-102JE	1	435031024R1	< B, >
R1077	C-CARBON R	RN72K1J-470JE	1	435034704R1	< B, >
R1078	C-CARBON R	RN72K1J-221JE	1	435032214R1	< B, >
R1079	C-CARBON R	RN72K1J-103JE	1	435031034R1	< B, >
R1080	C-CARBON R	RN72K1J-103JE	1	435031034R1	< B, >
R1081	C-CARBON R	RN72K1J-272JE	1	435032724R1	< B, >
R1082	C-CARBON R	RN72K1J-272JE	1	435032724R1	< B, >
R1083	C-CARBON R	RN72K1J-221JE	1	435032214R1	< B, >
R1084	C-CARBON R	RN72K1J-272JE	1	435032724R1	< B, >
R1085	C-CARBON R	RN72K1J-221JE	1	435032214R1	< B, >
R1086	C-CARBON R	RN72K1J-221JE	1	435032214R1	< B, >
R1087	C-CARBON R	RN72K1J-221JE	1	435032214R1	< B, >
R1088	C-CARBON R	RN72K1J-470JE	1	435034704R1	< B, >
R1089	C-CARBON R	RN72K1J-221JE	1	435032214R1	< B, >
R1090	C-CARBON R	RN72K1J-470JE	1	435034704R1	< B, >
R1091	C-CARBON R	RN72K1J-221JE	1	435032214R1	< B, >
R1092	C-CARBON R	RN72K1J-221JE	1	435032214R1	< B, >

R1093	C-CARBON R	RN72KIJ-473JE	1	435034734R1	< B, >
R1094	C-CARBON R	RN72KIJ-221JE	1	435032214R1	< B, >
R1095	C-CARBON R	RN72KIJ-221JE	1	435032214R1	< B, >
R1096	C-CARBON R	RN72KIJ-470JE	1	435034704R1	< B, >
R1097	C-CARBON R	RN72KIJ-472JE	1	435034724R1	< B, >
R1098	C-CARBON R	RN72KIJ-470JE	1	435034704R1	< B, >
R1099	C-CARBON R	RN72KIJ-103JE	1	435031034R1	< B, >
R11	METAL O R	RS1/2WBJ-10	1	443521004T	< DC, D, MA, MB, MO, MP, MQ, MR, >
R1101	C-CARBON R	RN72KIJ-221JE	1	435032214R1	< B, >
R1104	C-CARBON R	RN72KIJ-221JE	1	435032214R1	< B, >
R1107	C-CARBON R	RN72KIJ-470JE	1	435034704R1	< B, >
R1109	C-CARBON R	RN72KIJ-470JE	1	435034704R1	< B, >
R1111	C-CARBON R	RN72KIJ-221JE	1	435032214R1	< B, >
R1113	C-CARBON R	RN72KIJ-221JE	1	435032214R1	< B, >
R1114	C-CARBON R	RN72KIJ-470JE	1	435034704R1	< DC, D>
R1115	C-CARBON R	RN72KIJ-221JE	1	435032214R1	< B, >
R1116	C-CARBON R	RN72KIJ-470JE	1	435034704R1	< DC, D>
R1117	C-CARBON R	RN72KIJ-221JE	1	435032214R1	< B, >
R1118	C-CARBON R	RN72KIJ-470JE	1	435034704R1	< DC, D>
R1119	C-CARBON R	RN72KIJ-221JE	1	435032214R1	< B, >
R1120	C-CARBON R	RN72KIJ-470JE	1	435034704R1	< B, >
R1121	C-CARBON R	RN72KIJ-221JE	1	435032214R1	< B, >
R1122	C-CARBON R	RN72KIJ-470JE	1	435034704R1	< B, >
R1123	C-CARBON R	RN72KIJ-473JE	1	435034734R1	< B, >
R1124	C-CARBON R	RN72KIJ-221JE	1	435032214R1	< B, >
R1126	C-CARBON R	RN72KIJ-221JE	1	435032214R1	< B, >
R1128	C-CARBON R	RN72KIJ-470JE	1	435034704R1	< B, >
R1130	C-CARBON R	RN72KIJ-221JE	1	435032214R1	< B, >
R1131	C-CARBON R	RN72KIJ-221JE	1	435032214R1	< B, >
R1132	C-CARBON R	RN72KIJ-470JE	1	435034704R1	< B, >
R1133	C-CARBON R	RN72KIJ-221JE	1	435032214R1	< B, >
R1134	C-CARBON R	RN72KIJ-470JE	1	435034704R1	< B, >
R1136	C-CARBON R	RN72KIJ-102JE	1	435031024R1	< B, >
R1137	C-CARBON R	RN72KIJ-470JE	1	435034704R1	< B, >
R1138	C-CARBON R	RN72KIJ-102JE	1	435031024R1	< B, >
R1139	C-CARBON R	RN72KIJ-221JE	1	435032214R1	< B, >
R1140	C-CARBON R	RN72KIJ-221JE	1	435032214R1	< B, >
R1141	C-CARBON R	RN72KIJ-470JE	1	435034704R1	< B, >
R1142	C-CARBON R	RN72KIJ-473JE	1	435034734R1	< B, >

R1143	C-CARBON R	RN72K1J-470JE	1	435034704R1	< B, >
R1144	C-CARBON R	RN72K1J-221JE	1	435032214R1	< B, >
R1146	METAL R	RNU1WCG-1.5	1	453630154T	< B, >
R1147	METAL R	RNU1WCG-1.5	1	453630154T	< B, >
R1148	C-CARBON R	RN72K1J-221JE	1	435032214R1	< B, >
R1149	C-CARBON R	RN72K1J-470JE	1	435034704R1	< B, >
R1150	C-CARBON R	RN72K1J-333JE	1	435033334R1	< B, >
R1151	C-CARBON R	RN72K1J-103JE	1	435031034R1	< B, >
R1152	C-CARBON R	RN72K1J-000JE	1	435030004R1	< DC, D, MA, MB, MO, MP, MQ, MR, >
R1152	C-CARBON R	RN72K1J-472JE	1	435034724R1	< B, >
R1153	C-CARBON R	RN72K1J-470JE	1	435034704R1	< B, >
R1154	C-CARBON R	RN72K1J-103JE	1	435031034R1	< DC, D, MA, MB, MO, MP, MQ, MR, >
R1154	C-CARBON R	RN72K1J-563JE	1	435035634R1	< B, >
R1155	C-CARBON R	RN72K1J-103JE	1	435031034R1	< DC, D, MA, MB, MO, MP, MQ, MR, >
R1155	C-CARBON R	RN72K1J-333JE	1	435033334R1	< B, >
R1156	C-CARBON R	RN72K1J-470JE	1	435034704R1	< B, >
R1157	C-CARBON R	RN72K1J-103JE	1	435031034R1	< DC, D, MA, MB, MO, MP, MQ, MR, >
R1158	C-CARBON R	RN72K1J-000JE	1	435030004R1	< DC, D, MA, MB, MO, MP, MQ, MR, >
R1158	C-CARBON R	RN72K1J-333JE	1	435033334R1	< B, >
R1159	C-CARBON R	RN72K1J-103JE	1	435031034R1	< MA, MB, MO, MP, MQ, MR, >
R1160	C-CARBON R	RN72K1J-000JE	1	435030004R1	< DC, D, >
R1160	C-CARBON R	RN72K1J-103JE	1	435031034R1	< MA, MB, MO, MP, MQ, MR, >
R1160	C-CARBON R	RN72K1J-333JE	1	435033334R1	< B, >
R1161	C-CARBON R	RN72K1J-472JE	1	435034724R1	< B, >
R1162	C-CARBON R	RN72K1J-472JE	1	435034724R1	< B, >
R1164	C-CARBON R	RN72K1J-472JE	1	435034724R1	< B, >
R1165	C-CARBON R	RN72K1J-472JE	1	435034724R1	< B, >
R1166	C-CARBON R	RN72K1J-472JE	1	435034724R1	< B, >
R1167	C-CARBON R	RN72K1J-472JE	1	435034724R1	< B, >
R1168	C-CARBON R	RN72K1J-272JE	1	435032724R1	< B, >
R1170	C-CARBON R	RN72K1J-272JE	1	435032724R1	< B, >
R1171	C-CARBON R	RN72K1J-272JE	1	435032724R1	< B, >
R1172	C-CARBON R	RN72K1J-272JE	1	435032724R1	< B, >
R1173	C-CARBON R	RN72K1J-470JE	1	435034704R1	< B, >
R1175	C-CARBON R	RN72K1J-473JE	1	435034734R1	< B, >
R1176	C-CARBON R	RN72K1J-473JE	1	435034734R1	< B, >
R1177	C-CARBON R	RN72K1J-473JE	1	435034734R1	< B, >
R1178	C-CARBON R	RN72K1J-272JE	1	435032724R1	< B, >
R1179	C-CARBON R	RN72K1J-272JE	1	435032724R1	< B, >

R1180	C-CARBON R	RN72K1J-473JE	1	435034734R1	< B, >
R1182	C-CARBON R	RN72K1J-470JE	1	435034704R1	< B, >
R1183	C-CARBON R	RN72K1J-470JE	1	435034704R1	< B, >
R1184	C-CARBON R	RN72K1J-470JE	1	435034704R1	< B, >
R1185	C-CARBON R	RN72K1J-000JE	1	435030004R1	< B, >
R1186	C-CARBON R	RN72K1J-221JE	1	435032214R1	< B, >
R1187	C-CARBON R	RN72K1J-470JE	1	435034704R1	< B, >
R1188	C-CARBON R	RN72K1J-470JE	1	435034704R1	< DC, D, MA, MB, MO, MP, MQ, MR, >
R1189	C-CARBON R	RN72K1J-470JE	1	435034704R1	< B, >
R1190	C-CARBON R	RN72K1J-470JE	1	435034704R1	< B, >
R1191	C-CARBON R	RN72K1J-470JE	1	435034704R1	< B, >
R1192	C-CARBON R	RN72K1J-470JE	1	435034704R1	< B, >
R1193	C-CARBON R	RN72K1J-470JE	1	435034704R1	< B, >
R1194	C-CARBON R	RN72K1J-221JE	1	435032214R1	< B, >
R1195	C-CARBON R	RN72K1J-221JE	1	435032214R1	< B, >
R1196	C-CARBON R	RN72K1J-470JE	1	435034704R1	< B, >
R1197	C-CARBON R	RN72K1J-470JE	1	435034704R1	< B, >
R1198	C-CARBON R	RN72K1J-470JE	1	435034704R1	< B, >
R1199	C-CARBON R	RN72K1J-470JE	1	435034704R1	< B, >
R1200	C-CARBON R	RN72K1J-473JE	1	435034734R1	< B, >
R1201	C-CARBON R	RN72K1J-473JE	1	435034734R1	< B, >
R1202	C-CARBON R	RN72K1J-103JE	1	435031034R1	< B, >
R1203	C-CARBON R	RN72K1J-103JE	1	435031034R1	< B, >
R1204	C-CARBON R	RN72K1J-224JE	1	435032244R1	< B, >
R1205	C-CARBON R	RN72K1J-472JE	1	435034724R1	< B, >
R1207	C-CARBON R	RN72K1J-473JE	1	435034734R1	< B, >
R1209	C-CARBON R	RN72K1J-473JE	1	435034734R1	< B, >
R1210	C-CARBON R	RN72K1J-473JE	1	435034734R1	< B, >
R1211	C-CARBON R	RN72K1J-473JE	1	435034734R1	< B, >
R1212	C-CARBON R	RN72K1J-473JE	1	435034734R1	< B, >
R1213	C-CARBON R	RN72K1J-272JE	1	435032724R1	< B, >
R1214	C-CARBON R	RN72K1J-272JE	1	435032724R1	< B, >
R1217	C-CARBON R	RN72K1J-103JE	1	435031034R1	< B, >
R1218	C-CARBON R	RN72K1J-103JE	1	435031034R1	< B, >
R1219	C-CARBON R	RN72K1J-332JE	1	435033324R1	< B, >
R1220	C-CARBON R	RN72K1J-103JE	1	435031034R1	< DC, D, >
R1221	C-CARBON R	RN72K1J-470JE	1	435034704R1	< B, >
R1222	C-CARBON R	RN72K1J-470JE	1	435034704R1	< B, >
R1223	C-CARBON R	RN72K1J-473JE	1	435034734R1	< B, >

R1224	C-CARBON R	RN72K1J-332JE	1	435033324R1	< B, >
R1225	C-CARBON R	RN72K1J-103JE	1	435031034R1	< B, >
R1226	C-CARBON R	RN72K1J-473JE	1	435034734R1	< B, >
R1228	C-CARBON R	RN72K1J-473JE	1	435034734R1	< B, >
R1230	C-CARBON R	RN72K1J-221JE	1	435032214R1	< B, >
R1231	C-CARBON R	RN72K1J-102JE	1	435031024R1	< B, >
R1235	C-CARBON R	RN72K1J-224JE	1	435032244R1	< B, >
R1240	C-CARBON R	RN72K1J-103JE	1	435031034R1	< B, >
R1241	C-CARBON R	RN72K1J-272JE	1	435032724R1	< B, >
R1242	C-CARBON R	RN72K1J-470JE	1	435034704R1	< B, >
R1243	C-CARBON R	RN72K1J-470JE	1	435034704R1	< B, >
R1244	C-CARBON R	RN72K1J-470JE	1	435034704R1	< B, >
R1245	C-CARBON R	RN72K1J-470JE	1	435034704R1	< B, >
R1246	C-CARBON R	RN72K1J-221JE	1	435032214R1	< B, >
R1247	C-CARBON R	RN72K1J-103JE	1	435031034R1	< B, >
R1248	C-CARBON R	RN72K1J-470JE	1	435034704R1	< B, >
R1249	C-CARBON R	RN72K1J-000JE	1	435030004R1	< B, >
R1250	C-CARBON R	RN72K1J-470JE	1	435034704R1	< B, >
R1251	C-CARBON R	RN72K1J-470JE	1	435034704R1	< B, >
R1252	C-CARBON R	RN72K1J-470JE	1	435034704R1	< B, >
R1253	C-CARBON R	RN72K1J-473JE	1	435034734R1	< B, >
R1254	C-CARBON R	RN72K1J-473JE	1	435034734R1	< B, >
R1255	C-CARBON R	RN72K1J-473JE	1	435034734R1	< B, >
R1264	C-CARBON R	RN72K1J-222JE	1	435032224R1	< B, >
R1266	C-CARBON R	RN72K1J-222JE	1	435032224R1	< B, >
R1267	C-CARBON R	RN72K1J-102JE	1	435031024R1	< B, >
R1268	C-CARBON R	RN72K1J-221JE	1	435032214R1	< B, >
R1270	C-CARBON R	RN72K1J-101JE	1	435031014R1	< DC, D, MA, MB, MO, MP, MQ, MR, >
R1271	C-CARBON R	RN72K1J-102JE	1	435031024R1	< DC, D, MA, MB, MO, MP, MQ, MR, >
R1272	C-CARBON R	RN72K1J-100JE	1	435031004R1	< DC, D, MA, MB, MO, MP, MQ, MR, >
R1273	C-CARBON R	RN72K1J-000JE	1	435030004R1	< DC, D, MA, MB, MO, MP, MQ, MR, >
R1274	C-CARBON R	RN72K1J-000JE	1	435030004R1	< DC, D, MA, MB, MO, MP, MQ, MR, >
R1275	C-CARBON R	RN72K1J-823JE	1	435038234R1	< DC, D, MA, MB, MO, MP, MQ, MR, >
R1280	C-CARBON R	RN72K1J-470JE	1	435034704R1	< DC, D, MA, MB, MO, MP, MQ, MR, >
R1281	C-CARBON R	RN72K1J-470JE	1	435034704R1	< DC, D, MA, MB, MO, MP, MQ, MR, >
R1282	C-CARBON R	RN72K1J-273JE	1	435032734R1	< DC, D, MA, MB, MO, MP, MQ, MR, >
R1283	C-CARBON R	RN72K1J-470JE	1	435034704R1	< DC, D, MA, MB, MO, MP, MQ, MR, >
R1284	C-CARBON R	RN72K1J-470JE	1	435034704R1	< B, >
R1285	C-CARBON R	RN72K1J-470JE	1	435034704R1	< B, >

R1286	C-CARBON R	RN72K1J-470JE	1	435034704R1	< B, >
R1287	C-CARBON R	RN72K1J-470JE	1	435034704R1	< DC, D, MA, MB, MO, MP, MQ, MR, >
R1288	C-CARBON R	RN72K1J-470JE	1	435034704R1	< DC, D, MA, MB, MO, MP, MQ, MR, >
R1289	C-CARBON R	RN72K1J-104JE	1	435031044R1	< B, >
R1290	C-CARBON R	RN72K1J-103JE	1	435031034R1	< B, >
R1291	C-CARBON R	RN72K1J-104JE	1	435031044R1	< B, >
R1292	C-CARBON R	RN72K1J-103JE	1	435031034R1	< B, >
R1293	C-CARBON R	RN72K1J-473JE	1	435034734R1	< B, >
R1294	C-CARBON R	RN72K1J-473JE	1	435034734R1	< B, >
R1295	C-CARBON R	RN72K1J-473JE	1	435034734R1	< B, >
R1296	C-CARBON R	RN72K1J-473JE	1	435034734R1	< B, >
R1297	C-CARBON R	RN72K1J-473JE	1	435034734R1	< B, >
R1298	C-CARBON R	RN72K1J-473JE	1	435034734R1	< B, >
R1299	C-CARBON R	RN72K1J-102JE	1	435031024R1	< B, >
R1300	THERMISTOR	FUSB090F	1	4000252T	< B, >
R1301	METAL R	RNU1WCJ-4.7	1	453630474T	< B, >
R1302	METAL R	RNU1WCJ-4.7	1	453630474T	< B, >
R1303	METAL O R	RS1WBJ-22	1	443622204T	< B, >
R1304	METAL O R	RS1WBJ-22	1	443622204T	< B, >
R1311	C-CARBON R	RN72K1J-331JE	1	435033314R1	< B, >
R1312	C-CARBON R	RN72K1J-331JE	1	435033314R1	< B, >
R1313	C-CARBON R	RN72K1J-331JE	1	435033314R1	< B, >
R1315	C-CARBON R	RN72K1J-331JE	1	435033314R1	< B, >
R1316	C-CARBON R	RN72K1J-331JE	1	435033314R1	< B, >
R1317	C-CARBON R	RN72K1J-470JE	1	435034704R1	< B, >
R1318	C-CARBON R	RN72K1J-470JE	1	435034704R1	< B, >
R1319	C-CARBON R	RN72K1J-331JE	1	435033314R1	< B, >
R1320	C-CARBON R	RN72K1J-331JE	1	435033314R1	< B, >
R1321	C-CARBON R	RN72K1J-470JE	1	435034704R1	< B, >
R1322	C-CARBON R	RN72K1J-331JE	1	435033314R1	< B, >
R1323	C-CARBON R	RN72K1J-331JE	1	435033314R1	< B, >
R1325	C-CARBON R	RN72K1J-470JE	1	435034704R1	< B, >
R1485	C-CARBON R	RN72K1J-100JE	1	435031004R1	< B, >
R1486	C-CARBON R	RN72K1J-100JE	1	435031004R1	< B, >
R1487	C-CARBON R	RN72K1J-750JE	1	435037504R1	< B, >
R1488	C-CARBON R	RN72K1J-224JE	1	435032244R1	< B, >
R1490	C-CARBON R	RN72K1J-750JE	1	435037504R1	< B, >
R1491	C-CARBON R	RN72K1J-224JE	1	435032244R1	< B, >
R1492	C-CARBON R	RN72K1J-100JE	1	435031004R1	< B, >

R1496	C-CARBON R	RN72K1J-750JE	1	435037504R1	< B, >
R1497	C-CARBON R	RN72K1J-224JE	1	435032244R1	< B, >
R1500	C-CARBON R	RN72K1J-392JE	1	435033924R1	< B, >
R1504	C-CARBON R	RN72K1J-221JE	1	435032214R1	< B, >
R1506	C-CARBON R	RN72K1J-470JE	1	435034704R1	< B, >
R1507	C-CARBON R	RN72K1J-152JE	1	435031524R1	< B, >
R1508	C-CARBON R	RN72K1J-102JE	1	435031024R1	< B, >
R1509	C-CARBON R	RN72K1J-331JE	1	435033314R1	< B, >
R1510	C-CARBON R	RN72K1J-331JE	1	435033314R1	< B, >
R1511	C-CARBON R	RN72K1J-102JE	1	435031024R1	< B, >
R1512	C-CARBON R	RN72K1J-470JE	1	435034704R1	< B, >
R1513	C-CARBON R	RN72K1J-331JE	1	435033314R1	< B, >
R1514	C-CARBON R	RN72K1J-102JE	1	435031024R1	< B, >
R1515	C-CARBON R	RN72K1J-331JE	1	435033314R1	< B, >
R1517	C-CARBON R	RN72K1J-331JE	1	435033314R1	< B, >
R1518	C-CARBON R	RN72K1J-331JE	1	435033314R1	< B, >
R1519	C-CARBON R	RN72K1J-331JE	1	435033314R1	< B, >
R1520	C-CARBON R	RN72K1J-470JE	1	435034704R1	< B, >
R1521	C-CARBON R	RN72K1J-823JE	1	435038234R1	< B, >
R1522	C-CARBON R	RN72K1J-103JE	1	435031034R1	< B, >
R1523	C-CARBON R	RN72K1J-103JE	1	435031034R1	< B, >
R1524	C-CARBON R	RN72K1J-823JE	1	435038234R1	< B, >
R1525	C-CARBON R	RN72K1J-470JE	1	435034704R1	< B, >
R1526	C-CARBON R	RN72K1J-470JE	1	435034704R1	< B, >
R1527	C-CARBON R	RN72K1J-221JE	1	435032214R1	< B, >
R1528	C-CARBON R	RN72K1J-470JE	1	435034704R1	< B, >
R1529	C-CARBON R	RN72K1J-470JE	1	435034704R1	< B, >
R1530	C-CARBON R	RN72K1J-470JE	1	435034704R1	< B, >
R1531	C-CARBON R	RN72K1J-470JE	1	435034704R1	< B, >
R1532	C-CARBON R	RN72K1J-103JE	1	435031034R1	< B, >
R1534	C-CARBON R	RN72K1J-823JE	1	435038234R1	< B, >
R1535	C-CARBON R	RN72K1J-105JE	1	435031054R1	< B, >
R1567	C-CARBON R	RN72K1J-220JE	1	435032204R1	< B, >
R1568	C-CARBON R	RN72K1J-220JE	1	435032204R1	< B, >
R1569	C-CARBON R	RN72K1J-220JE	1	435032204R1	< B, >
R1570	C-CARBON R	RN72K1J-220JE	1	435032204R1	< B, >
R1571	C-CARBON R	RN72K1J-220JE	1	435032204R1	< B, >
R1572	C-CARBON R	RN72K1J-220JE	1	435032204R1	< B, >
R1573	C-CARBON R	RN72K1J-221JE	1	435032214R1	< B, >

R1677	C-CARBON R	RN72KIJ-222JE	1	435032224R1
R1680	C-CARBON R	RN72KIJ-103JE	1	435031034R1
R1681	C-CARBON R	RN72KIJ-103JE	1	435031034R1
R1682	C-CARBON R	RN72KIJ-103JE	1	435031034R1
R1683	C-CARBON R	RN72KIJ-103JE	1	435031034R1
R1684	C-CARBON R	RN72KIJ-103JE	1	435031034R1
R1685	C-CARBON R	RN72KIJ-103JE	1	435031034R1
R1686	C-CARBON R	RN72KIJ-103JE	1	435031034R1
R1687	C-CARBON R	RN72KIJ-103JE	1	435031034R1
R1690	C-CARBON R	RN72KIJ-103JE	1	435031034R1
R1691	C-CARBON R	RN72KIJ-103JE	1	435031034R1
R1692	C-CARBON R	RN72KIJ-103JE	1	435031034R1
R1693	C-CARBON R	RN72KIJ-103JE	1	435031034R1
R1694	C-CARBON R	RN72KIJ-103JE	1	435031034R1
R1695	C-CARBON R	RN72KIJ-103JE	1	435031034R1
R1696	C-CARBON R	RN72KIJ-103JE	1	435031034R1
R1697	C-CARBON R	RN72KIJ-103JE	1	435031034R1
R1700	C-CARBON R	RN72KIJ-152JE	1	435031524R1
R1701	C-CARBON R	RN72KIJ-152JE	1	435031524R1
R1702	C-CARBON R	RN72KIJ-152JE	1	435031524R1
R1703	C-CARBON R	RN72KIJ-152JE	1	435031524R1
R1704	C-CARBON R	RN72KIJ-152JE	1	435031524R1
R1705	C-CARBON R	RN72KIJ-152JE	1	435031524R1
R1706	C-CARBON R	RN72KIJ-152JE	1	435031524R1
R1707	C-CARBON R	RN72KIJ-152JE	1	435031524R1
R1710	C-CARBON R	RN72KIJ-223JE	1	435032234R1
R1711	C-CARBON R	RN72KIJ-223JE	1	435032234R1
R1712	C-CARBON R	RN72KIJ-223JE	1	435032234R1
R1713	C-CARBON R	RN72KIJ-223JE	1	435032234R1
R1714	C-CARBON R	RN72KIJ-223JE	1	435032234R1
R1715	C-CARBON R	RN72KIJ-223JE	1	435032234R1
R1716	C-CARBON R	RN72KIJ-223JE	1	435032234R1
R1717	C-CARBON R	RN72KIJ-223JE	1	435032234R1
R1720	C-CARBON R	RN72KIJ-223JE	1	435032234R1
R1721	C-CARBON R	RN72KIJ-223JE	1	435032234R1
R1722	C-CARBON R	RN72KIJ-223JE	1	435032234R1
R1723	C-CARBON R	RN72KIJ-223JE	1	435032234R1
R1724	C-CARBON R	RN72KIJ-223JE	1	435032234R1
R1725	C-CARBON R	RN72KIJ-223JE	1	435032234R1

R1726	C-CARBON R	RN72K1J-223JE	1	435032234R1	
R1727	C-CARBON R	RN72K1J-223JE	1	435032234R1	
R1730	C-CARBON R	RN72K1J-223JE	1	435032234R1	
R1731	C-CARBON R	RN72K1J-223JE	1	435032234R1	
R1732	C-CARBON R	RN72K1J-223JE	1	435032234R1	
R1733	C-CARBON R	RN72K1J-223JE	1	435032234R1	
R1734	C-CARBON R	RN72K1J-223JE	1	435032234R1	
R1735	C-CARBON R	RN72K1J-223JE	1	435032234R1	
R1736	C-CARBON R	RN72K1J-223JE	1	435032234R1	
R1737	C-CARBON R	RN72K1J-223JE	1	435032234R1	
R1740	C-CARBON R	RN72K1J-223JE	1	435032234R1	
R1741	C-CARBON R	RN72K1J-223JE	1	435032234R1	
R1742	C-CARBON R	RN72K1J-223JE	1	435032234R1	
R1743	C-CARBON R	RN72K1J-223JE	1	435032234R1	
R1744	C-CARBON R	RN72K1J-223JE	1	435032234R1	
R1745	C-CARBON R	RN72K1J-223JE	1	435032234R1	
R1746	C-CARBON R	RN72K1J-223JE	1	435032234R1	
R1747	C-CARBON R	RN72K1J-223JE	1	435032234R1	
R1750	C-CARBON R	RN72K1J-152JE	1	435031524R1	
R1751	C-CARBON R	RN72K1J-152JE	1	435031524R1	
R1752	C-CARBON R	RN72K1J-152JE	1	435031524R1	
R1753	C-CARBON R	RN72K1J-152JE	1	435031524R1	
R1754	C-CARBON R	RN72K1J-152JE	1	435031524R1	
R1755	C-CARBON R	RN72K1J-152JE	1	435031524R1	
R1756	C-CARBON R	RN72K1J-152JE	1	435031524R1	
R1757	C-CARBON R	RN72K1J-152JE	1	435031524R1	
R1760	C-CARBON R	RN72K1J-152JE	1	435031524R1	
R1761	C-CARBON R	RN72K1J-152JE	1	435031524R1	
R1762	C-CARBON R	RN72K1J-152JE	1	435031524R1	
R1763	C-CARBON R	RN72K1J-152JE	1	435031524R1	
R1764	C-CARBON R	RN72K1J-152JE	1	435031524R1	
R1765	C-CARBON R	RN72K1J-152JE	1	435031524R1	
R1766	C-CARBON R	RN72K1J-152JE	1	435031524R1	
R1767	C-CARBON R	RN72K1J-152JE	1	435031524R1	
R1770	C-CARBON R	RN72K1J-000JE	1	435030004R1	< DC, D, MA, MB, MO, MP, MQ, MR, >
R1771	C-CARBON R	RN72K1J-000JE	1	435030004R1	< DC, D, MA, MB, MO, MP, MQ, MR, >
R1772	C-CARBON R	RN72K1J-000JE	1	435030004R1	< DC, D, MA, MB, MO, MP, MQ, MR, >
R1773	C-CARBON R	RN72K1J-000JE	1	435030004R1	< DC, D, MA, MB, MO, MP, MQ, MR, >
R1774	C-CARBON R	RN72K1J-000JE	1	435030004R1	< DC, D, MA, MB, MO, MP, MQ, MR, >

R1775	C-CARBON R	RN72KIJ-000JE	1	435030004R1	< DC, D, MA, MB, MO, MP, MQ, MR, >
R1776	C-CARBON R	RN72KIJ-000JE	1	435030004R1	< DC, D, MA, MB, MO, MP, MQ, MR, >
R1777	C-CARBON R	RN72KIJ-000JE	1	435030004R1	< DC, D, MA, MB, MO, MP, MQ, MR, >
R1780	METAL OR	RS1/2WBJ-22	1	443522204T	< B, >
R1781	METAL OR	RS1/2WBJ-22	1	443522204T	< B, >
R1800	C-CARBON R	RN72KIJ-101JE	1	435031014R1	< B, >
R1801	C-CARBON R	RN72KIJ-101JE	1	435031014R1	< B, >
R1810	C-CARBON R	RN72KIJ-101JE	1	435031014R1	< B, >
R1811	C-CARBON R	RN72KIJ-101JE	1	435031014R1	< B, >
R1820	C-CARBON R	RN72KIJ-103JE	1	435031034R1	< B, >
R1821	C-CARBON R	RN72KIJ-103JE	1	435031034R1	< B, >
R1830	C-CARBON R	RN72KIJ-103JE	1	435031034R1	< B, >
R1831	C-CARBON R	RN72KIJ-103JE	1	435031034R1	< B, >
R1840	C-CARBON R	RN72KIJ-103JE	1	435031034R1	< B, >
R1841	C-CARBON R	RN72KIJ-103JE	1	435031034R1	< B, >
R1850	C-CARBON R	RN72KIJ-103JE	1	435031034R1	< B, >
R1851	C-CARBON R	RN72KIJ-103JE	1	435031034R1	< B, >
R1860	C-CARBON R	RN72KIJ-103JE	1	435031034R1	< B, >
R1861	C-CARBON R	RN72KIJ-103JE	1	435031034R1	< B, >
R1900	C-CARBON R	RN72KIJ-104JE	1	435031044R1	< B, >
R1901	C-CARBON R	RN72KIJ-104JE	1	435031044R1	< B, >
R1902	C-CARBON R	RN72KIJ-105JE	1	435031054R1	< B, >
R1904	C-CARBON R	RN72KIJ-223JE	1	435032234R1	< B, >
R1905	C-CARBON R	RN72KIJ-223JE	1	435032234R1	< B, >
R1906	C-CARBON R	RN72KIJ-223JE	1	435032234R1	< B, >
R1907	C-CARBON R	RN72KIJ-223JE	1	435032234R1	< B, >
R1908	C-CARBON R	RN72KIJ-471JE	1	435034714R1	< B, >
R1909	C-CARBON R	RN72KIJ-471JE	1	435034714R1	< B, >
R1910	C-CARBON R	RN72KIJ-223JE	1	435032234R1	< B, >
R1911	C-CARBON R	RN72KIJ-223JE	1	435032234R1	< B, >
R1912	C-CARBON R	RN72KIJ-220JE	1	435032204R1	< B, >
R1913	C-CARBON R	RN72KIJ-220JE	1	435032204R1	< B, >
R1920	C-CARBON R	RN72KIJ-223JE	1	435032234R1	< B, >
R1921	C-CARBON R	RN72KIJ-223JE	1	435032234R1	< B, >
R1951	C-CARBON R	RN72KIJ-220JE	1	435032204R1	< B, >
R1952	C-CARBON R	RN72KIJ-220JE	1	435032204R1	< B, >
R1953	C-CARBON R	RN72KIJ-750JE	1	435037504R1	< B, >
R1954	C-CARBON R	RN72KIJ-222JE	1	435032224R1	< B, >
R1955	C-CARBON R	RN72KIJ-220JE	1	435032204R1	< B, >

R1956	C-CARBON R	RN72K1J-105JE	1	435031054R1	< B, >
R1961	C-CARBON R	RN72K1J-220JE	1	435032204R1	< B, >
R1962	C-CARBON R	RN72K1J-220JE	1	435032204R1	< B, >
R1963	C-CARBON R	RN72K1J-750JE	1	435037504R1	< B, >
R1964	C-CARBON R	RN72K1J-222JE	1	435032224R1	< B, >
R1965	C-CARBON R	RN72K1J-220JE	1	435032204R1	< B, >
R1971	C-CARBON R	RN72K1J-220JE	1	435032204R1	< B, >
R1972	C-CARBON R	RN72K1J-220JE	1	435032204R1	< B, >
R1973	C-CARBON R	RN72K1J-750JE	1	435037504R1	< B, >
R1974	C-CARBON R	RN72K1J-222JE	1	435032224R1	< B, >
R1975	C-CARBON R	RN72K1J-220JE	1	435032204R1	< B, >
R1980	THERMISTOR	FUSB090F	1	4000252T	< B, >
R39	C-CARBON R	RN72K1J-220JE	1	435032204R1	< DC, D>
R4000	METAL R	RNU1/2WCI-4.7	1	453530474T	< B, >
R4001	C-CARBON R	RN72K1J-103JE	1	435031034R1	< DC, D, MA, MB, MO, MP, MQ, MR, , >
R4002	METAL R	RNU1WCI-0.22	1	453632294T	< B, >
R4003	METAL R	RNU1/2WCI-0.47	1	453534794T	< B, >
R4004	C-CARBON R	RN72K1J-562JE	1	435035624R1	< B, >
R4005	C-CARBON R	RN72K1J-152JE	1	435031524R1	< B, >
R4006	C-CARBON R	RN72K1J-102JE	1	435031024R1	< B, >
R4007	C-CARBON R	RN72K1J-392JE	1	435033924R1	< B, >
R4008	C-CARBON R	RN72K2E-022JE	1	435220224R1	< B, >
R4022	METAL OR	RS2WBI-3.3	1	441720334F	< B, >
R4024	C-CARBON R	RN72K1J-470JE	1	435034704R1	< B, >
R41	C-CARBON R	RN72K1J-220JE	1	435032204R1	< DC, D>
R4106	C-CARBON R	RN72K1J-000JE	1	435030004R1	< B, >
R4107	C-CARBON R	RN72K1J-000JE	1	435030004R1	< B, >
R4108	C-CARBON R	RN72K1J-101JE	1	435031014R1	< B, >
R4109	C-CARBON R	RN72K1J-000JE	1	435030004R1	< B, >
R4110	C-CARBON R	RN72K1J-750JE	1	435037504R1	< B, >
R4111	C-CARBON R	RN72K1J-392JE	1	435033924R1	< B, >
R4112	C-CARBON R	RN72K1J-750JE	1	435037504R1	< B, >
R4113	C-CARBON R	RN72K1J-101JE	1	435031014R1	< B, >
R4115	C-CARBON R	RN72K1J-750JE	1	435037504R1	< B, >
R4116	C-CARBON R	RN72K1J-000JE	1	435030004R1	< B, >
R4117	C-CARBON R	RN72K1J-750JE	1	435037504R1	< B, >
R4118	C-CARBON R	RN72K1J-000JE	1	435030004R1	< B, >
R4119	C-CARBON R	RN72K2E-022JE	1	435220224R1	< B, >
R4120	C-CARBON R	RN72K1J-750JE	1	435037504R1	< B, >

R4121	C-CARBON R	RN72K1J-750JE	1	435037504R1	< B, >
R4122	C-CARBON R	RN72K1J-750JE	1	435037504R1	< B, >
R4123	C-CARBON R	RN72K1J-104JE	1	435031044R1	< B, >
R4124	C-CARBON R	RN72K1J-750JE	1	435037504R1	< B, >
R4125	C-CARBON R	RN72K1J-104JE	1	435031044R1	< B, >
R4126	C-CARBON R	RN72K1J-750JE	1	435037504R1	< B, >
R4127	C-CARBON R	RN72K1J-104JE	1	435031044R1	< B, >
R4135	C-CARBON R	RN72K1J-750JE	1	435037504R1	< B, >
R4136	C-CARBON R	RN72K1J-750JE	1	435037504R1	< B, >
R4137	C-CARBON R	RN72K1J-750JE	1	435037504R1	< B, >
R4138	C-CARBON R	RN72K2E-022JE	1	435220224R1	< B, >
R4139	C-CARBON R	RN72K1J-750JE	1	435037504R1	< B, >
R4140	C-CARBON R	RN72K1J-750JE	1	435037504R1	< B, >
R4141	C-CARBON R	RN72K1J-750JE	1	435037504R1	< B, >
R4142	C-CARBON R	RN72K1J-750JE	1	435037504R1	< B, >
R4143	C-CARBON R	RN72K1J-750JE	1	435037504R1	< B, >
R4144	C-CARBON R	RN72K1J-750JE	1	435037504R1	< B, >
R4145	C-CARBON R	RN72K1J-104JE	1	435031044R1	< B, >
R4146	C-CARBON R	RN72K1J-104JE	1	435031044R1	< B, >
R4147	C-CARBON R	RN72K1J-104JE	1	435031044R1	< B, >
R4148	C-CARBON R	RN72K1J-392JE	1	435033924R1	< B, >
R4149	C-CARBON R	RN72K1J-750JE	1	435037504R1	< B, >
R4150	C-CARBON R	RN72K1J-750JE	1	435037504R1	< B, >
R4151	C-CARBON R	RN72K1J-750JE	1	435037504R1	< B, >
R4152	C-CARBON R	RN72K1J-101JE	1	435031014R1	< B, >
R4153	C-CARBON R	RN72K1J-101JE	1	435031014R1	< B, >
R4155	C-CARBON R	RN72K1J-750JE	1	435037504R1	< B, >
R4156	C-CARBON R	RN72K1J-750JE	1	435037504R1	< B, >
R4157	C-CARBON R	RN72K1J-750JE	1	435037504R1	< B, >
R4158	C-CARBON R	RN72K1J-000JE	1	435030004R1	< DC, D, MA, MB, MO, MP, MQ, MR, , >
R4159	C-CARBON R	RN72K1J-750JE	1	435037504R1	< B, >
R4160	C-CARBON R	RN72K2E-022JE	1	435220224R1	< B, >
R4161	C-CARBON R	RN72K1J-750JE	1	435037504R1	< B, >
R4162	C-CARBON R	RN72K1J-750JE	1	435037504R1	< B, >
R4163	C-CARBON R	RN72K1J-104JE	1	435031044R1	< B, >
R4164	C-CARBON R	RN72K1J-104JE	1	435031044R1	< B, >
R4165	C-CARBON R	RN72K1J-104JE	1	435031044R1	< B, >
R4166	C-CARBON R	RN72K1J-104JE	1	435031044R1	< B, >
R4167	C-CARBON R	RN72K1J-104JE	1	435031044R1	< B, >

R4168	C-CARBON R	RN72K1J-101JE	1	435031014R1	< B, >
R4169	C-CARBON R	RN72K1J-101JE	1	435031014R1	< B, >
R4170	C-CARBON R	RN72K2E-022JE	1	435220224R1	< B, >
R4171	C-CARBON R	RN72K2E-022JE	1	435220224R1	< B, >
R4172	C-CARBON R	RN72K1J-682JE	1	435036824R1	< B, >
R4173	C-CARBON R	RN72K1J-682JE	1	435036824R1	< B, >
R4174	C-CARBON R	RN72K2E-022JE	1	435220224R1	< B, >
R4175	C-CARBON R	RN72K1J-000JE	1	435030004R1	< B, >
R4176	C-CARBON R	RN72K1J-000JE	1	435030004R1	< B, >
R4177	C-CARBON R	RN72K1J-000JE	1	435030004R1	< B, >
R4181	C-CARBON R	RN72K1J-000JE	1	435030004R1	< B, >
R4182	C-CARBON R	RN72K1J-000JE	1	435030004R1	< B, >
R4183	C-CARBON R	RN72K1J-000JE	1	435030004R1	< B, >
R4187	C-CARBON R	RN72K1J-104JE	1	435031044R1	< B, >
R4189	C-CARBON R	RN72K1J-104JE	1	435031044R1	< B, >
R4200	C-CARBON R	RN72K1J-104JE	1	435031044R1	< B, >
R4201	C-CARBON R	RN72K1J-103JE	1	435031034R1	< B, >
R4202	C-CARBON R	RN72K1J-101JE	1	435031014R1	< B, >
R4205	C-CARBON R	RN72K1J-101JE	1	435031014R1	< B, >
R4206	C-CARBON R	RN72K1J-000JE	1	435030004R1	< B, >
R4207	C-CARBON R	RN72K2E-022JE	1	435220224R1	< B, >
R4208	C-CARBON R	RN72K1J-104JE	1	435031044R1	< B, >
R4209	C-CARBON R	RN72K1J-392JE	1	435033924R1	< B, >
R4211	C-CARBON R	RN72K1J-103JE	1	435031034R1	< B, >
R4212	C-CARBON R	RN72K1J-103JE	1	435031034R1	< B, >
R4213	C-CARBON R	RN72K1J-000JE	1	435030004R1	< DC, D, MA, MB, MO, MP, MQ, MR, , >
R4214	C-CARBON R	RN72K1J-000JE	1	435030004R1	< DC, D, MA, MB, MO, MP, MQ, MR, , >
R4215	C-CARBON R	RN72K1J-105JE	1	435031054R1	< B, >
R4216	C-CARBON R	RN72K1J-105JE	1	435031054R1	< B, >
R4217	C-CARBON R	RN72K1J-105JE	1	435031054R1	< B, >
R4218	C-CARBON R	RN72K1J-105JE	1	435031054R1	< B, >
R4219	C-CARBON R	RN72K1J-105JE	1	435031054R1	< B, >
R4220	C-CARBON R	RN72K1J-105JE	1	435031054R1	< B, >
R4221	C-CARBON R	RN72K1J-105JE	1	435031054R1	< B, >
R4222	C-CARBON R	RN72K1J-105JE	1	435031054R1	< B, >
R4223	C-CARBON R	RN72K1J-105JE	1	435031054R1	< B, >
R4224	C-CARBON R	RN72K1J-105JE	1	435031054R1	< B, >
R4225	C-CARBON R	RN72K1J-105JE	1	435031054R1	< B, >
R4226	C-CARBON R	RN72K1J-105JE	1	435031054R1	< B, >

R4227	C-CARBON R	RN72K1J-682JE	1	435036824R1	< B, >
R4228	C-CARBON R	RN72K1J-222JE	1	435032224R1	< B, >
R4229	C-CARBON R	RN72K1J-331JE	1	435033314R1	< B, >
R4233	C-CARBON R	RN72K1J-222JE	1	435032224R1	< B, >
R4235	C-CARBON R	RN72K1J-222JE	1	435032224R1	< B, >
R4238	C-CARBON R	RN72K1J-222JE	1	435032224R1	< B, >
R4258	C-CARBON R	RN72K2E-022JE	1	435220224R1	< B, >
R43	C-CARBON R	RN72K1J-000JE	1	435030004R1	< DC, D >
R44	NF CARBON R	R25J-10	1	415471004T	< DC, D, MA, MB, MO, MP, MQ, MR, >
R45	NF CARBON R	R25J-10	1	415471004T	< DC, D, MA, MB, MO, MP, MQ, MR, >
R4500	C-CARBON R	RN72K1J-223JE	1	435032234R1	< DC, D, MA, MB, MO, MP, MQ, MR, >
R4501	C-CARBON R	RN72K1J-101JE	1	435031014R1	< DC, D, MA, MB, MO, MP, MQ, MR, >
R4502	C-CARBON R	RN72K1J-473JE	1	435034734R1	< DC, D, MA, MB, MO, MP, MQ, MR, >
R4503	C-CARBON R	RN72K1J-473JE	1	435034734R1	< DC, D, MA, MB, MO, MP, MQ, MR, >
R4504	C-CARBON R	RN72K1J-151JE	1	435031514R1	< DC, D, MA, MB, MO, MP, MQ, MR, >
R4505	C-CARBON R	RN72K1J-223JE	1	435032234R1	< B, >
R4506	C-CARBON R	RN72K1J-122JE	1	435031224R1	< B, >
R4507	C-CARBON R	RN72K1J-473JE	1	435034734R1	< B, >
R4508	C-CARBON R	RN72K1J-182JE	1	435031824R1	< B, >
R4509	C-CARBON R	RN72K1J-331JE	1	435033314R1	< B, >
R4510	C-CARBON R	RN72K1J-562JE	1	435035624R1	< B, >
R4511	METAL R	RNU1WCI-1	1	453630104T	< B, >
R4512	C-CARBON R	RN72K1J-223JE	1	435032234R1	< DC, D, MA, MB, MO, MP, MQ, MR, >
R46	C-CARBON R	RN72K1J-103JE	1	435031034R1	< MA, MB, MO, MP, MQ, MR, >
R47	C-CARBON R	RN72K1J-101JE	1	435031014R1	< MA, MB, MO, MP, MQ, MR, >
R4700	C-CARBON R	RN72K1J-103JE	1	435031034R1	< B, >
R4701	C-CARBON R	RN72K1J-103JE	1	435031034R1	< B, >
R4702	C-CARBON R	RN72K1J-331JE	1	435033314R1	< B, >
R4703	C-CARBON R	RN72K1J-331JE	1	435033314R1	< B, >
R4704	C-CARBON R	RN72K1J-103JE	1	435031034R1	< B, >
R4705	C-CARBON R	RN72K1J-331JE	1	435033314R1	< B, >
R4707	C-CARBON R	RN72K1J-331JE	1	435033314R1	< B, >
R48	C-CARBON R	RN72K1J-101JE	1	435031014R1	< MA, MB, MO, MP, MQ, MR, >
R49	C-CARBON R	RN72K1J-103JE	1	435031034R1	< DC, D, MA, MB, MO, MP, MQ, MR, >
R4900	METAL R	RNU12WCI-2	1	453530224T	
R4901	C-CARBON R	RN72K1J-750JE	1	435037504R1	
R4902	C-CARBON R	RN72K1J-750JE	1	435037504R1	
R4903	C-CARBON R	RN72K1J-750JE	1	435037504R1	
R4904	C-CARBON R	RN72K1J-750JE	1	435037504R1	

R4907	C-CARBON R	RN72K1J-750JE	1	435037504R1	
R4908	C-CARBON R	RN72K1J-750JE	1	435037504R1	
R4910	C-CARBON R	RN72K1J-105JE	1	435031054R1	
R4911	C-CARBON R	RN72K1J-105JE	1	435031054R1	
R4912	C-CARBON R	RN72K1J-105JE	1	435031054R1	
R4914	C-CARBON R	RN72K1J-750JE	1	435037504R1	
R4916	C-CARBON R	RN72K1J-750JE	1	435037504R1	
R4917	C-CARBON R	RN72K1J-750JE	1	435037504R1	
R4919	C-CARBON R	RN72K1J-103JE	1	435031034R1	
R4920	C-CARBON R	RN72K1J-103JE	1	435031034R1	
R4921	C-CARBON R	RN72K1J-750JE	1	435037504R1	
R4922	C-CARBON R	RN72K1J-750JE	1	435037504R1	
R4923	C-CARBON R	RN72K1J-750JE	1	435037504R1	
R4924	C-CARBON R	RN72K1J-750JE	1	435037504R1	
R4925	C-CARBON R	RN72K1J-750JE	1	435037504R1	
R4926	C-CARBON R	RN72K1J-750JE	1	435037504R1	
R50	C-CARBON R	RN72K1J-103JE	1	435031034R1	< DC, D, MA, MB, MO, MP, MQ, MR, >
R51	C-CARBON R	RN72K1J-273JE	1	435032734R1	< DC, D, MA, MB, MO, MP, MQ, MR, >
R52	C-CARBON R	RN72K1J-273JE	1	435032734R1	< DC, D, MA, MB, MO, MP, MQ, MR, >
R53	C-CARBON R	RN72K1J-223JE	1	435032234R1	< DC, D, MA, MB, MO, MP, MQ, MR, >
R54	C-CARBON R	RN72K1J-103JE	1	435031034R1	< DC, D, MA, MB, MO, MP, MQ, MR, >
R55	C-CARBON R	RN72K1J-103JE	1	435031034R1	< DC, D, MA, MB, MO, MP, MQ, MR, >
R56	C-CARBON R	RN72K1J-223JE	1	435032234R1	< DC, D, MA, MB, MO, MP, MQ, MR, >
R57	C-CARBON R	RN72K1J-103JE	1	435031034R1	< DC, D, >
R58	C-CARBON R	RN72K1J-103JE	1	435031034R1	< DC, D, >
R59	C-CARBON R	RN72K1J-103JE	1	435031034R1	< DC, D, >
R60	C-CARBON R	RN72K1J-103JE	1	435031034R1	< DC, D, >
R61	C-CARBON R	RN72K1J-103JE	1	435031034R1	< DC, D, >
R62	C-CARBON R	RN72K1J-103JE	1	435031034R1	< DC, D, >
R63	C-CARBON R	RN72K1J-103JE	1	435031034R1	< DC, D, >
R64	C-CARBON R	RN72K1J-103JE	1	435031034R1	< DC, D, >

[SW TRM]

E1911	TRM-423(SCREW)	NETTANSI ST3	1	25060495	< B, >
F4000A	FUSE HOL	NSCT-1P2031	1	25052133T	< B, >
F4000B	FUSE HOL	NSCT-1P2031	1	25052133T	< B, >
F4001A	FUSE HOL	NSCT-1P2031	1	25052133T	< B, >
F4001B	FUSE HOL	NSCT-1P2031	1	25052133T	< B, >
JL104B	WIRE TRAP	NPLG-9P592	1	25055630	< DC, D, MA, MB, MO, MP, MQ, MR, >
JL4500B	WIRE TRAP	NPLG-3P586	1	25055624	< DC, D, MA, MB, MO, MP, MQ, MR, >

JL515A	WIRE HOL	NSCT-11P882	1	25051095	< DC, D, MA, MB, MO, MP, MQ, MR, >
JL802A	WIRE HOL	NSCT-5P896	1	25051109	< B, >
JL901B	WIRE TRAP	NPLG-5P588	1	25055626	< B, >
P001	PWB	BCDG-0099	1	25140099C	N < B, >
P002	PWB	BCCPU-0100	{1}	25140100	N < B, >
P003	PWB	BCVD-0101	{1}	25140101	N < B, >
P004	PWB	BCVD-0102	{1}	25140102	< B, >
P005	PWB	BCETC-0103	{1}	25140103	N < B, >
P1004A	SOCKET	NSCT-9P2243	1	25052346	< B, >
P1008B	PLUG	IMSA-9142B-20A	1	25056600	< B, >
P1010B	PLUG	IMSA-9142B-20A	1	25056600	< B, >
P103B	SOCKET	NSCT-11P2104	1	25052207	< DC, D, MA, MB, MO, MP, MQ, MR, >
P1208	ST JACK	MSJ-035-22	1	25045887	< B, >
P1307	TRM-423(SCREW)	NEITTANSI ST3	1	25060495	< B, >
P1309	PIN JACK	NPI-3PDO656	1	25045884	< DC, D, MA, MB, MO, MP, MQ, MR, >
P1309 or	PIN JACK	NPI-3PDO465	(1)	25045666	< DC, D, MA, MB, MO, MP, MQ, MR, >
P1901A	PLUG	IMSA-9142B-22A	1	25056601	N < B, >
P1901B	SOCKET	IMSA-9142S-22A	1	25053233	N < B, >
P1902	SOCKET	NNA1-01-006	1	25053357	< B, >
P3605B	SOCKET	IMSA-9142S-18A	1	25053231	< B, >
P3607B	SOCKET	IMSA-9142S-16A	1	25053230	< B, >
P3608B	SOCKET	IMSA-9142S-18A	1	25053231	< B, >
P4000B	PLUG	NPLG-5P119	1	25055135	< B, >
P4100A	PLUG	IMSA-9142B-16A	1	25056598	< B, >
P4100B	SOCKET	IMSA-9142S-16A	1	25053230	< B, >
P4101A	PLUG	IMSA-9142B-18A	1	25056599	< B, >
P4101B	SOCKET	IMSA-9142S-18A	1	25053231	< B, >
P4104A	SOCKET	NSCT-31P2124	1	25052227	< DC, D, MA, MB, MO, MP, MQ, MR, >
P4110	PIN JACK	NPI-9PDGLRGLR563	1	25045781	< DC, D, MA, MB, MO, MP, MQ, MR, >
P4110 or	PIN JACK	NPI-9PDGLR519	(1)	25045731	< DC, D, MA, MB, MO, MP, MQ, MR, >
P4112	PIN JACK	NPI-10PDBY621	1	25045842	< DC, D, MA, MB, MO, MP, MQ, MR, >
P4112 or	PIN JACK	NPI-10PDBY478	(1)	25045681	< DC, D, MA, MB, MO, MP, MQ, MR, >
P4113	PIN JACK	NPI-10PDBY621	1	25045842	< DC, D, MA, MB, MO, MP, MQ, MR, >
P4113 or	PIN JACK	NPI-10PDBY478	(1)	25045681	< DC, D, MA, MB, MO, MP, MQ, MR, >
P4114	PIN JACK	NPI-10PDBY621	1	25045842	< DC, D, MA, MB, MO, MP, MQ, MR, >
P4114 or	PIN JACK	NPI-10PDBY478	(1)	25045681	< DC, D, MA, MB, MO, MP, MQ, MR, >
P4118	TRM-423(SCREW)	NEITTANSI ST3	1	25060495	< B, >
P4119	RETAINER	(JOINT)	1	27142069	< B, >
P4501	PLUG	NPLG-2P83	1	25055099	< B, >

P4700	SOCKET	MDS-09P-V-01(DSUB9P)	1	25053363	< DC, D, MA, MB, MO, MP, MQ, MR, >
P4900A	SOCKET	NSCT-15P2108	1	25052211	
P4900B	SOCKET	NSCT-15P2108	1	25052211	
P4901	SOCKET	NSCT-14P2510	1	25052613	
P4902	SOCKET	NSCT-14P2510	1	25052613	
P4904	SOCKET	NSCT-14P2510	1	25052613	
P5512B	PLUG	NPLG-15P0970	1	25056020	< B, >
P5513B	PLUG	NPLG-19P0974	1	25056024	< B, >
P5518B	PLUG	NPLG-3P0958	1	25056008	< B, >
P6621B	PLUG	IMSA-9142B-16A	1	25056598	< DC, D, MA, MB, MO, MP, MQ, MR, >
P7501A	PLUG	A2545WR2-2x20P(DDE40SIDE)	1	25056643	N < B, >
P8	SOCKET	2MJ-3516-002	1	25053355	< DC, D >

PRINTED CIRCUIT BOARD PARTS LIST

U004	Display circuit PC board a'ssy	BADIS-0135-1A *			N B DC, DF
U004	Display circuit PC board a'ssy	BADIS-0135-1C *			B JJ, MA, MB, MO, MP, MQ, MR, S
U0041	Standby switch PC board a'ssy	BASW-0136-1A			NSP, B DC, DF
U0041	Standby switch PC board a'ssy	BASW-0136-1C			NSP, B JJ, MA, MB, MO, MP, MQ, MR, S
U0042	Headphone terminal PC board a	BAETC-0137-1A			NSP, B DC, DF
U0042	Headphone terminal PC board a	BAETC-0137-1C			NSP, B JJ, MA, MB, MO, MP, MQ, MR, S
U0043	Front digital input PC board a'ss	BAETC-0138-1A			NSP, B DC, DF
U0043	Front digital input PC board a'ss	BAETC-0138-1C			NSP, B JJ, MA, MB, MO, MP, MQ, MR, S
U0044	Volume LED PC board a'ssy	BAETC-0139-1A			NSP, B DC, DF
U0044	Volume LED PC board a'ssy	BAETC-0139-1C			NSP, B JJ, MA, MB, MO, MP, MQ, MR, S
U0045	Fuse PC board a'ssy	BAPS-0140-1A			NSP, B DC, DF
U0045	Fuse PC board a'ssy	BAPS-0140-1C			NSP, B JJ, MA, MB, MO, MP, MQ, MR, S
U0046	Support PC board-1	BAETC-0145-1A			NSP, B DC, DF
U0046	Support PC board-1	BAETC-0145-1C			NSP, B JJ, MA, MB, MO, MP, MQ, MR, S
U0047	Support PC board-2	BAETC-0142-1A			NSP, B DC, DF
U0047	Support PC board-2	BAETC-0142-1C			NSP, B JJ, MA, MB, MO, MP, MQ, MR, S
U0048	Support PC board-3	BAETC-0128-1A			NSP, B DC, DF
U0048	Support PC board-3	BAETC-0128-1C			NSP, B JJ, MA, MB, MO, MP, MQ, MR, S
U0049	FFC Support PC board	BAETC-0130-1A			N NSP, B DC, DF
U0049	FFC Support PC board	BAETC-0130-1C			N NSP, B JJ, MA, MB, MO, MP, MQ, MR, S
U00410	Support PC board-4	BAETC-0144-1A			NSP, B DC, DF
U00410	Support PC board-4	BAETC-0144-1C			NSP, B JJ, MA, MB, MO, MP, MQ, MR, S
U00411	Support PC board-5	BAETC-0129-1A			N NSP, B DC, DF
U00411	Support PC board-5	BAETC-0129-1C			N NSP, B JJ, MA, MB, MO, MP, MQ, MR, S
U00412	Power switch PC board	BASW-0143-1C			N NSP, B JJ, MA, MB, MO, MP, MQ, MR, S

CIRCUIT. NO.	PART NAME	DESCRIPTION	QTY	PART NO. (SN)	REMARKS
[TUNER UNIT]					
U7520	PHT CP	JSR1321-001	1	24120138	
U7560	REMO SENS	TSOP34338RPIF	1	24130017	
[SEMI CONDUCTOR]					
D7500	ZENER D	UDZS10B	1	224551000R2	
D7520	C-DIODE	ISS355	1	223269R2	
D7520 or	C-DIODE	ISS352	(1)	223234R2	
D7520 or	C-DIODE	MA2J111	(1)	223279R2	
D7520 or	C-DIODE	KDS4148U	(1)	223283R2	
D7521	C-DIODE	ISS355	1	223269R2	
D7521 or	C-DIODE	ISS352	(1)	223234R2	
D7521 or	C-DIODE	MA2J111	(1)	223279R2	
D7521 or	C-DIODE	KDS4148U	(1)	223283R2	
D7522	C-DIODE	ISS355	1	223269R2	
D7522 or	C-DIODE	ISS352	(1)	223234R2	
D7522 or	C-DIODE	MA2J111	(1)	223279R2	
D7522 or	C-DIODE	KDS4148U	(1)	223283R2	
D7523	C-DIODE	ISS355	1	223269R2	
D7523 or	C-DIODE	ISS352	(1)	223234R2	
D7523 or	C-DIODE	MA2J111	(1)	223279R2	
D7523 or	C-DIODE	KDS4148U	(1)	223283R2	
D7530	ZENER D	UDZS5.1B	1	224550510R2	
D7531	C-DIODE	ISS355	1	223269R2	
D7531 or	C-DIODE	ISS352	(1)	223234R2	
D7531 or	C-DIODE	MA2J111	(1)	223279R2	
D7531 or	C-DIODE	KDS4148U	(1)	223283R2	
D7532	C-DIODE	ISS355	1	223269R2	
D7532 or	C-DIODE	ISS352	(1)	223234R2	
D7532 or	C-DIODE	MA2J111	(1)	223279R2	
D7532 or	C-DIODE	KDS4148U	(1)	223283R2	
D7560	C-DIODE	ISS355	1	223269R2	
D7560 or	C-DIODE	ISS352	(1)	223234R2	
D7560 or	C-DIODE	MA2J111	(1)	223279R2	
D7560 or	C-DIODE	KDS4148U	(1)	223283R2	
D7561	C-DIODE	ISS355	1	223269R2	
D7561 or	C-DIODE	ISS352	(1)	223234R2	
D7561 or	C-DIODE	MA2J111	(1)	223279R2	

D7561 or	C-DIODE	KDS4148U	(1)	223283R2	
D7570	SPCF D	TSAL5300	1	225488	N
D7580	C-DIODE	ISS355	1	223269R2	
D7580 or	C-DIODE	ISS352	(1)	223234R2	
D7580 or	C-DIODE	MA2J111	(1)	223279R2	
D7580 or	C-DIODE	KDS4148U	(1)	223283R2	
D7581	C-DIODE	ISS355	1	223269R2	
D7581 or	C-DIODE	ISS352	(1)	223234R2	
D7581 or	C-DIODE	MA2J111	(1)	223279R2	
D7581 or	C-DIODE	KDS4148U	(1)	223283R2	
D7582	C-DIODE	ISS355	1	223269R2	
D7582 or	C-DIODE	ISS352	(1)	223234R2	
D7582 or	C-DIODE	MA2J111	(1)	223279R2	
D7582 or	C-DIODE	KDS4148U	(1)	223283R2	
D7583	C-DIODE	ISS355	1	223269R2	
D7583 or	C-DIODE	ISS352	(1)	223234R2	
D7583 or	C-DIODE	MA2J111	(1)	223279R2	
D7583 or	C-DIODE	KDS4148U	(1)	223283R2	
D7585	LED	SCB3318E-D2	1	225487	
D7590	LED	SCB3318E-D2	1	225487	
D7590	LED	SCB3318E-D2	1	225487	
D7592	LED	SLR-342MGTE7P	1	225455T	
D7593	LED	SLR-342MGTE7P	1	225455T	
D7595	LED	SLI-343URC-TE7	1	225449T	
D9306	ZENER D	UDZS30B	1	224553000R2	
D9310	ZENER D	UDZS16B	1	224551600R2	
D9312	DIODE	RL1N4003	1	22380260T	
D9313	DIODE	RL1N4003	1	22380260T	
D9314	DIODE	RL1N4003	1	22380260T	
D9315	DIODE	RL1N4003	1	22380260T	
D9316	DIODE	RL1N4003	1	22380260T	
Q7500	FL TUBE	HNA-16SL05T	1	212271A	
Q7500A	HOLDER	(FL)	1	27191303	
Q7501	IC	M66005-0001AHP	1	22242208R3	
Q7502	IC	M66005-0001AHP	1	22242208R3	
Q7503	TR	2SC2712-GR	1	2213145R2	
Q7504	TR	2SC2712-GR	1	2213145R2	
Q7530	IC	NJM4580M-D	1	22241448R2	
Q7532	TR	RN1441	1	2215410R2	

Q7533	TR		RN2403	1	2214540R2
Q7533 or	TR		KRA103S	(1)	2216230R2
Q7534	IC		NJM4580M-D	1	22241448R2
Q7540	TR		DTA123JKA	1	2214090R2
Q7592	TR		DTC123JKA	1	2216690R2
Q7593	TR		DTC123JKA	1	2216690R2
Q7595	TR		DTC123JKA	1	2216690R2
Q7595	TR		DTC123JKA	1	2216690R2
Q7597	TR		DTC123JKA	1	2216690R2
Q7598	TR		DTC123JKA	1	2216690R2
Q9301	TR		2SC2235-Y(TPE6_F)	1	2211654T

[TRANS COIL]

L7520	CHOKE COIL		LBC2518T2R2M	1	231364M022R2
L7530	CHOKE COIL		LBC2518T2R2M	1	231364M022R2
L7580	CHOKE COIL		LBC2518T2R2M	1	231364M022R2
L7581	CHOKE COIL		LBC2518T2R2M	1	231364M022R2
L7582	CHOKE COIL		LBC2518T2R2M	1	231364M022R2

[CAPACITOR]

C7501	C-CERA C		CK725B1H-223K1	1	332102235R1
C7502	C-CERA C		CK725F1E-104Z1	1	332161040R1
C7503	C-CERA C		CK725F1E-104Z1	1	332161040R1
C7504	C-CERA C		CK725B1H-473K1	1	332104735R1
C7505	C-CERA C		CK725B1H-473K1	1	332104735R1
C7506	ELECT C		CE04W50V-33M	1	355783309T
C7511	C-CERA C		CK725F1E-104Z1	1	332161040R1
C7512	C-CERA C		CC725CH1H-180J1	1	342101804R1
C7513	C-CERA C		CK725F1E-104Z1	1	332161040R1
C7514	C-CERA C		CK725F1E-104Z1	1	332161040R1
C7518	C-CERA C		CK725F1E-104Z1	1	332161040R1
C7519	C-CERA C		CK725F1E-104Z1	1	332161040R1
C7520	C-CERA C		CK725B1H-223K1	1	332102235R1
C7521	UTSP C		CE04W10V-100M(UTSP)	1	397531017T
C7522	C-CERA C		CC725CH1H-221J1	1	342102214R1
C7523	C-CERA C		CC725CH1H-221J1	1	342102214R1
C7524	C-CERA C		CK725B1H-102K1	1	332101025R1
C7530	C-CERA C		CK725B1H-102K1	1	332101025R1
C7531	C-CERA C		CK725B1H-102K1	1	332101025R1
C7533	ELECT C		CE04W35V-47M	1	355764709T
C7534	ELECT C		CE04W16V-47M	1	355744709T

C7535	ELECT C	CE04W35V-10M(S)	1	353761009T
C7536	C-CERA C	CC725CH1H-101J1	1	342101014R1
C7537	C-CERA C	CC725CH1H-330I1	1	342103304R1
C7538	ELECT C	CE04W35V-10M(S)	1	353761009T
C7539	ELECT C	CE04W35V-10M(S)	1	353761009T
C7540	ELECT C	CE04W35V-10M(S)	1	353761009T
C7543	C-CERA C	CK725B1H-102K1	1	332101025R1
C7560	ELECT C	CE04W6.3V-220M	1	355722219T
C7561	C-CERA C	CK725B1H-102K1	1	332101025R1
C7562	C-CERA C	CK725B1H-102K1	1	332101025R1
C7580	MKT C	B32529C0102J289	1	376491024T
C7581	MKT C	B32529C0102J289	1	376491024T
C7582	MKT C	B32529C0102J289	1	376491024T
C7583	MKT C	B32529C0102J289	1	376491024T
C7590	C-CERA C	CK725B1H-103K1	1	332101035R1
C7591	C-CERA C	CK725B1H-103K1	1	332101035R1
C7900	C-CERA C	CK725F1E-104Z1	1	332161040R1
C9304	VR C	CE04W63V-220M(VR)	1	394672217T
C9304	VR C	CE04W63V-220M(VR)	1	394672217T
C9305	VR C	CE04W63V-47M(VR)	1	394674707T
C9306	TF C	ECQ-V50V-223J	1	374722234T

[RESISTOR]

R7500	C-CARBON R	RN72K1J-221JE	1	435032214R1
R7501	C-CARBON R	RN72K1J-221JE	1	435032214R1
R7502	C-CARBON R	RN72K1J-273JE	1	435032734R1
R7503	C-CARBON R	RN72K1J-222JE	1	435032224R1
R7504	C-CARBON R	RN72K1J-222JE	1	435032224R1
R7505	C-CARBON R	RN72K1J-222JE	1	435032224R1
R7506	C-CARBON R	RN72K1J-222JE	1	435032224R1
R7507	C-CARBON R	RN72K1J-222JE	1	435032224R1
R7508	C-CARBON R	RN72K1J-222JE	1	435032224R1
R7509	C-CARBON R	RN72K1J-222JE	1	435032224R1
R7510	C-CARBON R	RN72K1J-222JE	1	435032224R1
R7520	C-CARBON R	RN72K1J-221JE	1	435032214R1
R7521	C-CARBON R	RN72K1J-331JE	1	435033314R1
R7522	C-CARBON R	RN72K1J-331JE	1	435033314R1
R7523	C-CARBON R	RN72K1J-750JE	1	435037504R1
R7526	C-CARBON R	RN72K1J-223JE	1	435032234R1
R7527	C-CARBON R	RN72K1J-223JE	1	435032234R1

R7528	C-CARBON R	RN72KIJ-224JE	1	43503224R1
R7529	C-CARBON R	RN72KIJ-224JE	1	43503224R1
R7530	C-CARBON R	RN72KIJ-472JE	1	43503472R1
R7531	C-CARBON R	RN72KIJ-101JE	1	43503101R1
R7532	C-CARBON R	RN72KIJ-331JE	1	43503331R1
R7533	C-CARBON R	RN72KIJ-182JE	1	43503182R1
R7534	C-CARBON R	RN72KIJ-104JE	1	43503104R1
R7535	C-CARBON R	RN72KIJ-102JE	1	43503102R1
R7536	C-CARBON R	RN72KIJ-333JE	1	43503333R1
R7537	C-CARBON R	RN72KIJ-333JE	1	43503333R1
R7538	C-CARBON R	RN72KIJ-221JE	1	43503221R1
R7539	C-CARBON R	RN72KIJ-221JE	1	43503221R1
R7540	C-CARBON R	RN72KIJ-473JE	1	43503473R1
R7541	C-CARBON R	RN72KIJ-180JE	1	43503180R1
R7560	C-CARBON R	RN72KIJ-102JE	1	43503102R1
R7561	C-CARBON R	RN72KIJ-101JE	1	43503101R1
R7562	C-CARBON R	RN72KIJ-105JE	1	43503105R1
R7580	METAL O R	RS1WBJ-33	1	443623304T
R7581	METAL O R	RS1WBJ-33	1	443623304T
R7590	C-CARBON R	RN72KIJ-103JE	1	43503103R1
R7591	C-CARBON R	RN72KIJ-103JE	1	43503103R1
R7592	C-CARBON R	RN72KIJ-103JE	1	43503103R1
R7593	C-CARBON R	RN72KIJ-103JE	1	43503103R1
R7594	C-CARBON R	RN72KIJ-121JE	1	43503121R1
R7596	C-CARBON R	RN72KIJ-181JE	1	43503181R1
R7597	C-CARBON R	RN72KIJ-181JE	1	43503181R1
R7599	C-CARBON R	RN72KIJ-102JE	1	43503102R1
R7600	C-CARBON R	RN72KIJ-121JE	1	43503121R1
R7600	C-CARBON R	RN72KIJ-121JE	1	43503121R1
R7611	C-CARBON R	RN72KIJ-271JE	1	43503271R1
R7612	C-CARBON R	RN72KIJ-331JE	1	43503331R1
R7613	C-CARBON R	RN72KIJ-471JE	1	43503471R1
R7614	C-CARBON R	RN72KIJ-561JE	1	43503561R1
R7615	C-CARBON R	RN72KIJ-821JE	1	43503821R1
R7616	C-CARBON R	RN72KIJ-122JE	1	43503122R1
R7617	C-CARBON R	RN72KIJ-222JE	1	43503222R1
R7618	C-CARBON R	RN72KIJ-392JE	1	43503392R1
R7619	C-CARBON R	RN72KIJ-123JE	1	43503123R1
R7621	C-CARBON R	RN72KIJ-271JE	1	43503271R1

R7622	C-CARBON R	RN72KIJ-331JE	1	435033314R1
R7623	C-CARBON R	RN72KIJ-471JE	1	435034714R1
R7624	C-CARBON R	RN72KIJ-561JE	1	435035614R1
R7625	C-CARBON R	RN72KIJ-821JE	1	435038214R1
R7626	C-CARBON R	RN72KIJ-122JE	1	435031224R1
R7627	C-CARBON R	RN72KIJ-222JE	1	435032224R1
R7628	C-CARBON R	RN72KIJ-392JE	1	435033924R1
R7629	C-CARBON R	RN72KIJ-123JE	1	435031234R1
R7631	C-CARBON R	RN72KIJ-271JE	1	435032714R1
R7632	C-CARBON R	RN72KIJ-331JE	1	435033314R1
R7633	C-CARBON R	RN72KIJ-471JE	1	435034714R1
R7634	C-CARBON R	RN72KIJ-561JE	1	435035614R1
R7635	C-CARBON R	RN72KIJ-821JE	1	435038214R1
R7636	C-CARBON R	RN72KIJ-122JE	1	435031224R1
R7637	C-CARBON R	RN72KIJ-222JE	1	435032224R1
R7638	C-CARBON R	RN72KIJ-392JE	1	435033924R1
R7639	C-CARBON R	RN72KIJ-123JE	1	435031234R1
R7641	C-CARBON R	RN72KIJ-271JE	1	435032714R1
R7642	C-CARBON R	RN72KIJ-331JE	1	435033314R1
R7643	C-CARBON R	RN72KIJ-471JE	1	435034714R1
R7644	C-CARBON R	RN72KIJ-561JE	1	435035614R1
R7645	C-CARBON R	RN72KIJ-821JE	1	435038214R1
R7646	C-CARBON R	RN72KIJ-122JE	1	435031224R1
R7647	C-CARBON R	RN72KIJ-222JE	1	435032224R1
R7648	C-CARBON R	RN72KIJ-392JE	1	435033924R1
R7649	C-CARBON R	RN72KIJ-123JE	1	435031234R1
R7802	C-CARBON R	RN72KIJ-103JE	1	435031034R1
R7939	C-CARBON R	RN72KIJ-104JE	1	435031044R1
R7954	C-CARBON R	RN72KIJ-104JE	1	435031044R1
R9304	METAL O R	RS1/2WBJ-10	1	443521004T
R9305	C-CARBON R	RN72KIJ-562JE	1	435035624R1
R9307	C-CARBON R	RN72KIJ-333JE	1	435033334R1
R9308	METAL R	RNU1/2WCI-1	1	453530104T
R9308	METAL R	RNU1/2WCI-1	1	453530104T
R9310	METAL O R	RS1/2WBJ-10	1	443521004T
R9310	METAL O R	RS1/2WBJ-10	1	443521004T

[SW TRM]

E7580	TRM	NTM-1P233(M1969)	1	25060302
E7601	TRM-423(SCREW)	NETTANSI ST3	1	25060495

E7601	TRM-423(SCREW)	NEITANSI ST3	1	25060495	
JL4103B	SOCKET	NSCT-5P97	1	25050269	
JL7560A	WIRE HOL	NSCT-3P874	1	25051087	
JL7560B	WIRE HOL	NSCT-3P874	1	25051087	
JL9303A	WIRE HOL	NSCT-5P876	1	25051089	
JL9303B	WIRE TRAP	NPLG-5P588	1	25055626	
P7501B	PLUG	A2545WR2-2x20P(IDE40SIDE)	1	25056643	
P7522	PIN JACK	NPI-3PDB693	1	25045925	
P7522	PIN JACK	NPI-3PDB693	1	25045925	
P7530	ST JACK	MSJ-035-05C B AG SR type	1	25045879	
P7530	ST JACK	MSJ-035-05C B AG SR type	1	25045879	
P7556	PWB	BCDIS-0135	1	25140135C	N
P7557	PWB	BCSW-0136	{1}	25140136	
P7558	PWB	BCETC-0137	{1}	25140137	
P7559	PWB	BCETC-0138	{1}	25140138	
P7560	PWB	BCETC-0139	{1}	25140139	
P7561	PWB	BCPS-0140	{1}	25140140	
P7562	PWB	BCETC-0144	{1}	25140144	
P7563	PWB	BCETC-0145	{1}	25140145	
P7564	PWB	BCETC-0130	{1}	25140130	N
P7564	PWB	BCETC-0130	{1}	25140130	N
P7565	PWB	BCETC-0142	{1}	25140142	
P7566	PWB	BCSW-0143	{1}	25140143	
P7567	PWB	BCETC-0128	{1}	25140128	
P7568	PWB	BCETC-0129	{1}	25140129	N
P7568	PWB	BCETC-0129	{1}	25140129	N
P7580	ST JACK	MSJ-064-05A SR	1	25045783	
P7580	ST JACK	MSJ-064-05A SR	1	25045783	
P7590A	SOCKET AS	NSAS-18P1798	1	200AA391810UL	
P7591A	SOCKET AS	NSAS-7P1799	1	200AA391415UL	
P9008B	PLUG	NPLG-2P631	1	25055675	
P9301A	PLUG	NPLG-6P120	1	25055136	
S7590	R ENCODE	EC12E2425WTH WASHER	1	25065655W	
S7611	PUSH SW	NPS-111-S681	1	25035718T	
S7612	PUSH SW	NPS-111-S681	1	25035718T	
S7613	PUSH SW	NPS-111-S681	1	25035718T	
S7614	PUSH SW	NPS-111-S681	1	25035718T	
S7615	PUSH SW	NPS-111-S681	1	25035718T	
S7615	PUSH SW	NPS-111-S681	1	25035718T	

S7616	PUSH SW	NPS-111-S681	1	25035718T
S7618	PUSH SW	NPS-111-S681	1	25035718T
S7619	PUSH SW	NPS-111-S681	1	25035718T
S7620	PUSH SW	NPS-111-S681	1	25035718T
S7621	PUSH SW	NPS-111-S681	1	25035718T
S7622	PUSH SW	NPS-111-S681	1	25035718T
S7623	PUSH SW	NPS-111-S681	1	25035718T
S7624	PUSH SW	NPS-111-S681	1	25035718T
S7625	PUSH SW	NPS-111-S681	1	25035718T
S7626	PUSH SW	NPS-111-S681	1	25035718T
S7627	PUSH SW	NPS-111-S681	1	25035718T
S7628	PUSH SW	NPS-111-S681	1	25035718T
S7629	PUSH SW	NPS-111-S681	1	25035718T
S7630	PUSH SW	NPS-111-S681	1	25035718T
S7632	PUSH SW	NPS-111-S681	1	25035718T
S7633	PUSH SW	NPS-111-S681	1	25035718T
S7634	PUSH SW	NPS-111-S681	1	25035718T
S7635	PUSH SW	NPS-111-S681	1	25035718T
S7636	PUSH SW	NPS-111-S681	1	25035718T
S7637	PUSH SW	NPS-111-S681	1	25035718T
S7638	PUSH SW	NPS-111-S681	1	25035718T
S7639	PUSH SW	NPS-111-S681	1	25035718T
S7640	PUSH SW	NPS-111-S681	1	25035718T
S7641	PUSH SW	NPS-111-S681	1	25035718T
S7642	PUSH SW	NPS-111-S681	1	25035718T
S7643	PUSH SW	NPS-111-S681	1	25035718T
S7644	PUSH SW	NPS-111-S681	1	25035718T
S7645	PUSH SW	NPS-111-S681	1	25035718T
S7646	PUSH SW	NPS-111-S681	1	25035718T
S7647	PUSH SW	NPS-111-S681	1	25035718T
S7648	PUSH SW	NPS-111-S681	1	25035718T
S7649	PUSH SW	NPS-111-S681	1	25035718T
S7650	PUSH SW	NPS-111-S681	1	25035718T
S9000	P SW	NPS-111-L687P(TV-5)	1	25035724

[CHASSIS SCREW]

D7570A HOLDER (LED)LH-5-5 1 27191312

PRINTED CIRCUIT BOARD PARTS LIST

U005 HDMI Circuit PC board a'ssy BAHDM-0132-1B

N

CIRCUIT. NO.	PART NAME	DESCRIPTION	QTY	PART NO. (SN)	REMARKS
	[SEMI CONDUCTOR]				
D3101	C-DIODE	KDS4148U	1	223283R2	
D3101 or	C-DIODE	ISS352	(1)	223234R2	
D3401	C-DIODE	KDS4148U	1	223283R2	
D3401 or	C-DIODE	ISS352	(1)	223234R2	
D8041	DIODE	RB070M-30	1	22380361R2	
D8043	DIODE	RB070M-30	1	22380361R2	
D8301	C-DIODE	ISS226(TTE85L_F)	1	223266R2	
D8302	C-DIODE	KDS4148U	1	223283R2	
D8302 or	C-DIODE	ISS352	(1)	223234R2	
D8652	C-DIODE	ISR154-400	1	22380284R2	
D8653	C-DIODE	KDS4148U	1	223283R2	
D8653 or	C-DIODE	ISS352	(1)	223234R2	
D8701	C-DIODE	KDS4148U	1	223283R2	
D8701 or	C-DIODE	ISS352	(1)	223234R2	
D8801	C-DIODE	KDS4148U	1	223283R2	
D8801 or	C-DIODE	ISS352	(1)	223234R2	
D8951	DIODE	RSX501LA-20	1	22380364R2	
D8952	DIODE	RSX501LA-20	1	22380364R2	
D8953	DIODE	RSX501LA-20	1	22380364R2	
D8954	DIODE	RSX501LA-20	1	22380364R2	
D8958	C-DIODE	ISS352	1	223234R2	
D8958 or	C-DIODE	MA2J111	(1)	223279R2	
D8958 or	C-DIODE	KDS4148U	(1)	223283R2	
Q205	IC	TC74VHC15FT	1	22274157ER2TO	
Q3001	IC	D830K011AZKKB300ZrevC	1	22242617R3	N
Q3002	IC (DSP)	NAND256W3A2BN6E(0309)	1	222W0092R303096	
Q3003	IC	IS42S16160C-7TL	1	22242592R3	
Q3003 or	IC	K4S561632J-UC75	(1)	22242524AR3	
Q3004	IC	IS42S16160C-7TL	1	22242592R3	
Q3004 or	IC	K4S561632J-UC75	(1)	22242524AR3	
Q3005	IC	TC7W32FU	1	22241162R2	
Q3006	IC	S-80127CNMC-JKM-T2	1	22241642R2	
Q3103	IC	BH18LB1W-G-TR	1	22242562R2	
Q3106	IC	BH33FB1W-G-TR	1	22242585R2	
Q3107	IC	BA33BC0FP	1	22278033DR2RH	
Q3107 or	IC	TA48033BF(TE16L_NQ)	(1)	22278033DBR2TO	

Q3107 or	IC	TA48033AF(TEI6L_NQ)	(1)	22278033DR2TO
Q3108	IC	KSZ8041NL	1	2224259IR2
Q3109	IC	BD7820	1	2224230OR2
Q3202	IC	TC74VHC15FT	1	22274157ER2TO
Q3204	IC	TC7SZU04FU	1	22242512R2TO
Q3205	IC	TC7SZU04FU	1	22242512R2TO
Q3206	IC	NE5532APSR	1	22242283R2
Q3207	IC	NE5532APSR	1	22242283R2
Q3210	IC	TC7WH241FU(TEI2L_F)	1	22242076R2TO
Q3401	IC (DSP2)	ES29LV160FT-70TG(0324)	1	222W0069R303247
Q3401 or	IC (DSP2)	S29AL016D70TFH10(0324)	(1)	222W0063R303247
Q3401 or	IC (DSP2)	S29AL016I70TFH10(0324)	(1)	222W0100R303247
Q3402	IC	D788E001BRFP266Z	1	22242502R3
Q3403	IC	K4S641632K-UC60	1	22242462R2
Q3403 or	IC	K4S641632N-LC60	(1)	22242603R2
Q3403 or	IC	EM638165TS-7G	(1)	22242607R2
Q3404	IC	BD7820	1	22242300R2
Q3405	IC	TC7WU04FU(TEI2L_F)	1	22240935R2
Q3406	IC	TA48033AF(TEI6L_NQ)	1	22278033DR2TO
Q3406 or	IC	TA48033BF(TEI6L_NQ)	(1)	22278033DBR2TO
Q3604	IC	PCM1754DBQR	1	22242598R2
Q8000	IC	HY5DU561622FTP-4-C	1	22242450R3
Q8000 or	IC	HY5DU561622FTP-4-C	(1)	22242577R3
Q8001	IC	HY5DU561622FTP-4-C	1	22242450R3
Q8001 or	IC	HY5DU561622FTP-4-C	(1)	22242577R3
Q8005	IC (VSP)	MX29LV320CTTC-70G(0311)	1	222W0052R30311A
Q8005 or	IC (VSP)	MX29LV320DTTI-70G(0311)	1	222W0109R30311A
Q8041	IC	TA48018BF(TEI6L_NQ)	1	22278018DBR2TO
Q8161	IC	TA48018BF(TEI6L_NQ)	1	22278018DBR2TO
Q8162	IC	SH9185ACTU	1	22242471R3
Q8200	IC	FLI30336	1	22242469R3
Q8201	IC	BR24S32FJ-WE2	1	22242569R2
Q8201 or	IC	24LC32A-I/SN	(1)	22242521R2
Q8287	IC	MK2302S-01LFTR	1	22242552R2
Q8305	IC	S-812C50BUC-C5ET2G	1	22242407R2
Q8306	IC	NC7SZ08P5X_F042	1	22242482R2
Q8306 or	IC	TC7SZ08FU(TE85L_F)	(1)	22242071R2TO
Q8309	TR ARRAY	UM6KIN	1	226066R2
Q8362	IC	SH9185ACTU	1	22242471R3

Q8401	IC	SHI9134CTU	1	22242394R3	
Q8404	IC	BH18LB1WG-TR	1	22242562R2	
Q8405	IC	SN74CB3Q3305PWR	1	22242258R2	
Q8501	IC	SHI9233ACTU	1	22242582R3	
Q8595	IC	TA48018BF(TEI6L_NQ)	1	22278018DBR2TO	
Q8652	IC	BH33FB1WG-TR	1	22242585R2	
Q8654	IC	BD7820	1	22242300R2	
Q8701	IC (HDMI/VIDEO)	MPD70F3739GC-UEU-AX(0299)	1	222W0102R302995	N
Q8801	IC	ADV7342BSTZ-3	1	22242608R3	
Q8802	IC	BH18LB1WG-TR	1	22242562R2	
Q8803	TR	DTC144EE	1	2216390R2	
Q8803 or	TR	KRC404E	(1)	2216450R2	
Q8813	IC	TC74VCX162827	1	22242395R2	
Q8814	IC	TC74VCX162827	1	22242395R2	
Q8817	IC	TC74VCX162827	1	22242395R2	
Q8818	IC	TC74VCX162827	1	22242395R2	
Q8951	IC	MPI1593DN	1	22242601R2	N
Q8952	IC	MPI1593DN	1	22242601R2	N
Q8953	IC	MPI1593DN	1	22242601R2	N
Q8954	IC	MPI1593DN	1	22242601R2	N
Q8955	TR	DTC144EE	1	2216390R2	
Q8955 or	TR	KRC404E	(1)	2216450R2	
Q8956	TR	DTC144EE	1	2216390R2	
Q8956 or	TR	KRC404E	(1)	2216450R2	
Q8957	TR	DTC144EE	1	2216390R2	
Q8957 or	TR	KRC404E	(1)	2216450R2	
Q8958	TR	DTC144EE	1	2216390R2	
Q8958 or	TR	KRC404E	(1)	2216450R2	
Q8963	TR	DTC144EE	1	2216390R2	
Q8963 or	TR	KRC404E	(1)	2216450R2	

[TRANS COIL]

L251	CORE	BLM18PG181SNID	1	2350005R1	
L261	EMIFIL	BK1608LM182-T	1	230958R1	
L3001	CORE	BLM18PG121SNID	1	2350006R1	
L3002	CORE	BLM18PG121SNID	1	2350006R1	
L3003	CORE	BLM18PG121SNID	1	2350006R1	
L3004	CORE	BLM18PG121SNID	1	2350006R1	
L3005	CORE	BLM18PG121SNID	1	2350006R1	
L3103	CORE	BLM18PG121SNID	1	2350006R1	

L3104	CORE	BLM18PG121SNID	1	2350006R1
L3105	CORE	BLM18PG121SNID	1	2350006R1
L3106	CORE	BLM18PG121SNID	1	2350006R1
L3107	CORE	BLM18PG121SNID	1	2350006R1
L3108	CORE	BLM18PG121SNID	1	2350006R1
L3109	CORE	BLM18PG121SNID	1	2350006R1
L3110	CORE	BLM18PG121SNID	1	2350006R1
L3202	C-CARBON R	RN72K1J-000JE	1	435030004R1
L3203	CORE	MMZ1608Y601BT	1	2350004R1
L3204	CORE	MMZ1608Y601BT	1	2350004R1
L3205	CORE	BLM18PG121SNID	1	2350006R1
L3206	CORE	BLM18PG121SNID	1	2350006R1
L3207	CORE	MMZ1608Y601BT	1	2350004R1
L3208	CORE	MMZ1608Y601BT	1	2350004R1
L3209	CORE	MMZ1608Y601BT	1	2350004R1
L3401	C-CARBON R	RN72K1J-000JE	1	435030004R1
L3402	CORE	BLM18PG121SNID	1	2350006R1
L3403	CORE	MMZ1608Y601BT	1	2350004R1
L3405	CORE	BLM18PG121SNID	1	2350006R1
L3406	CORE	BLM18PG121SNID	1	2350006R1
L3407	CORE	BLM18PG121SNID	1	2350006R1
L3408	CORE	BLM18PG121SNID	1	2350006R1
L3409	CORE	BLM18PG121SNID	1	2350006R1
L3410	CORE	MMZ1608Y601BT	1	2350004R1
L3411	CORE	MMZ1608Y601BT	1	2350004R1
L3509	CHOKE COIL	LBC2518T470M	1	231364M470R2
L8021	CHOKE COIL	BLM21PG221SN1	1	230949R2
L8022	CHOKE COIL	BLM21PG221SN1	1	230949R2
L8023	CHOKE COIL	BLM21PG221SN1	1	230949R2
L8024	CHOKE COIL	BLM21PG221SN1	1	230949R2
L8025	CHOKE COIL	BLM21PG221SN1	1	230949R2
L8026	CHOKE COIL	BLM21PG221SN1	1	230949R2
L8027	CHOKE COIL	BLM21PG221SN1	1	230949R2
L8041	CHOKE COIL	BLM21PG221SN1	1	230949R2
L8042	CHOKE COIL	BLM21PG221SN1	1	230949R2
L8043	CHOKE COIL	BLM21PG221SN1	1	230949R2
L8161	CORE	BLM18PG181SNID	1	2350005R1
L8162	CORE	BLM18PG181SNID	1	2350005R1
L8163	CORE	BLM18PG181SNID	1	2350005R1

L8361	CORE	BLM18PG181SNID	1	2350005R1	
L8362	CORE	BLM18PG181SNID	1	2350005R1	
L8363	CORE	BLM18PG181SNID	1	2350005R1	
L8401	CORE	BLM18PG181SNID	1	2350005R1	
L8402	CORE	BLM18PG181SNID	1	2350005R1	
L8403	CORE	BLM18PG181SNID	1	2350005R1	
L8404	CORE	BLM18PG181SNID	1	2350005R1	
L8405	CORE	BLM18PG181SNID	1	2350005R1	
L8406	C-R NET	MNRI12E0API000	1	43464900002R2	
L8407	C-R NET	MNRI12E0API000	1	43464900002R2	
L8408	CORE	BLM18PG181SNID	1	2350005R1	
L8409	C-R NET	MNRI12E0API000	1	43464900002R2	
L8410	C-R NET	MNRI12E0API000	1	43464900002R2	
L8601	CORE	BLM18PG181SNID	1	2350005R1	
L8602	CORE	BLM18PG181SNID	1	2350005R1	
L8603	CORE	BLM18PG181SNID	1	2350005R1	
L8604	CORE	BLM18PG181SNID	1	2350005R1	
L8605	CORE	BLM18PG181SNID	1	2350005R1	
L8606	CORE	BLM18PG181SNID	1	2350005R1	
L8608	EMIFIL	BK1608LMI82-T	1	230958R1	
L8701	CORE	BLM18PG181SNID	1	2350005R1	
L8801	CHOKE COIL	LBC2518T4R7M	1	231364M047R2	
L8802	CHOKE COIL	LBC2518T4R7M	1	231364M047R2	
L8803	CHOKE COIL	LBC2518T4R7M	1	231364M047R2	
L8804	CHOKE COIL	LBC2518T4R7M	1	231364M047R2	
L8851	C-CARBON R	RN72K2B-0001E	1	433220004R1	
L8852	C-CARBON R	RN72K2B-0001E	1	433220004R1	
L8853	C-CARBON R	RN72K2B-0001E	1	433220004R1	
L8854	C-CARBON R	RN72K2B-0001E	1	433220004R1	
L8855	C-CARBON R	RN72K2B-0001E	1	433220004R1	
L8856	C-CARBON R	RN72K2B-0001E	1	433220004R1	
L8951	CHOKE COIL	0182-7E08Q-100M-RA	1	231396M100R2	
L8952	CHOKE COIL	0182-7E08Q-6R8N-RA	1	231395P068R2	
L8953	CHOKE COIL	0182-7E08Q-6R8N-RA	1	231395P068R2	
L8954	CHOKE COIL	0182-7E08Q-100M-RA	1	231396M100R2	
L8955	CHOKE COIL	BLM21PG221SN1	1	230949R2	
L8956	CHOKE COIL	BLM21PG221SN1	1	230949R2	
L8957	CHOKE COIL	BLM21PG221SN1	1	230949R2	
L8958	CHOKE COIL	BLM21PG221SN1	1	230949R2	

L8959	CHOKE COIL	BLM21PG221SN1	1	230949R2	
L8960	CHOKE COIL	BLM21PG221SN1	1	230949R2	
L8961	CHOKE COIL	BLM21PG221SN1	1	230949R2	
L8962	CHOKE COIL	BLM21PG221SN1	1	230949R2	
L8963	CHOKE COIL	BLM21PG221SN1	1	230949R2	
L8964	CHOKE COIL	BLM21PG221SN1	1	230949R2	
L8965	CHOKE COIL	BLM21PG221SN1	1	230949R2	
L8966	CHOKE COIL	BLM21PG221SN1	1	230949R2	
X3001	CRYSTAL	HC-49SMD24.000MHZ	1	3010479R2	
X3001 or	CRYSTAL	HC-49USSMD24.00MHZ	(1)	3010471R2	
X3201	CRYSTAL	HC-49/U03C 12.288MHZ	1	3010323R2	
X3202	CRYSTAL	HC-49SMD11.2896MHZ	1	3010480R2	
X3202 or	CRYSTAL	HC-49USSMD11.2896MHZ	(1)	3010472R2	
X3401	CRYSTAL	HC-49USSMD17.734MHZ	1	3010442R2	
X8200	CRYSTAL	HC-49USSMD19.6608M	1	3010458R2	
X8501	CRYSTAL	DSX530GAK27.00000MHZ	1	3010474R2	N
X8701	CERA LOCK	CSTCR5M00G53-B0	1	3010356R2	

[CAPACITOR]

C251	C-CERA C	CK725F1A-105Z1	1	332181050R1	
C252	C-CERA C	CK725F1A-105Z1	1	332181050R1	
C3001	C-CERA C	CK725F1A-105Z1	1	332181050R1	
C3002	C-CERA C	CK725F1A-105Z1	1	332181050R1	
C3003	C-CERA C	CK725B0J-106K	1	332091065R2	
C3004	C-CERA C	CK725B0J-106K	1	332091065R2	
C3005	C-CERA C	CK725F1A-105Z1	1	332181050R1	
C3006	C-CERA C	CC725CH1H-102J1	1	342101024R1	
C3007	C-CERA C	CK725F1A-105Z1	1	332181050R1	
C3008	C-CERA C	CC725CH1H-102J1	1	342101024R1	
C3009	C-CERA C	CK725F1A-105Z1	1	332181050R1	
C3010	C-CERA C	CK725F1A-105Z1	1	332181050R1	
C3011	C-CERA C	CK725F1A-105Z1	1	332181050R1	
C3012	C-CERA C	CC725CH1H-102J1	1	342101024R1	
C3013	C-CERA C	CK725F1A-105Z1	1	332181050R1	
C3014	C-CERA C	CC725CH1H-102J1	1	342101024R1	
C3015	C-CERA C	CC725CH1H-102J1	1	342101024R1	
C3016	C-CERA C	CK725F1A-105Z1	1	332181050R1	
C3017	C-CERA C	CK725F1A-105Z1	1	332181050R1	
C3018	C-CERA C	CK725F1A-105Z1	1	332181050R1	
C3019	C-CERA C	CC725CH1H-102J1	1	342101024R1	

C3020	C-CERA C	CK725F1A-105Z1	1	332181050R1
C3021	C-CERA C	CK725F1A-105Z1	1	332181050R1
C3022	C-CERA C	CK725F1A-105Z1	1	332181050R1
C3023	C-CERA C	CK725B0U-106K	1	332091065R2
C3024	C-CERA C	CC725CH1H-102J1	1	342101024R1
C3025	C-CERA C	CK725F1A-105Z1	1	332181050R1
C3026	C-CERA C	CK725B1C-104K1	1	332121045R1
C3027	C-CERA C	CC725CH1H-102J1	1	342101024R1
C3028	C-CERA C	CK725F1A-105Z1	1	332181050R1
C3029	C-CERA C	CC725CH1H-102J1	1	342101024R1
C3030	C-CERA C	CK725F1A-105Z1	1	332181050R1
C3031	C-CERA C	CK725F1A-105Z1	1	332181050R1
C3032	C-CERA C	CC725CH1H-102J1	1	342101024R1
C3033	C-CERA C	CK725F1A-105Z1	1	332181050R1
C3034	C-CERA C	CC725CH1H-120J1	1	342101204R1
C3035	C-CERA C	CC725CH1H-102J1	1	342101024R1
C3036	C-CERA C	CC725CH1H-120J1	1	342101204R1
C3037	C-CERA C	CK725F1A-105Z1	1	332181050R1
C3038	C-CERA C	CK725F1A-105Z1	1	332181050R1
C3039	C-CERA C	CK725B1H-103K1	1	332101035R1
C3040	C-CERA C	CK725F1A-105Z1	1	332181050R1
C3041	C-CERA C	CK725B0U-106K	1	332091065R2
C3042	C-CERA C	CK725F1A-105Z1	1	332181050R1
C3043	C-CERA C	CK725F1A-105Z1	1	332181050R1
C3105	C-CERA C	CK725F1A-105Z1	1	332181050R1
C3106	C-CERA C	CK725B0U-106K	1	332091065R2
C3107	C-CERA C	CK725F1A-105Z1	1	332181050R1
C3108	C-CERA C	CK725F1A-105Z1	1	332181050R1
C3109	C-CERA C	CK725B0U-106K	1	332091065R2
C3110	C-CERA C	CK725B1A-224K1	1	332132245R1
C3112	C-CERA C	CK725B0U-106K	1	332091065R2
C3113	C-CERA C	CK725F1A-105Z1	1	332181050R1
C3114	C-CERA C	CK725F1A-105Z1	1	332181050R1
C3115	C-CERA C	CK725B0U-106K	1	332091065R2
C3116	C-CERA C	CK725B0U-106K	1	332091065R2
C3117	C-CERA C	CC725CH1H-102J1	1	342101024R1
C3118	C-CERA C	CK725F1A-105Z1	1	332181050R1
C3119	C-CERA C	CK725F1A-105Z1	1	332181050R1
C3120	C-CERA C	CK725B0U-106K	1	332091065R2

C3121	C-CERA C	CK725F1A-105Z1	1	332181050R1
C3122	C-CERA C	CK725F1A-105Z1	1	332181050R1
C3123	CHIP ELECT C	CEWX10V-220M	1	398132217R2
C3124	C-CERA C	CK725F1A-105Z1	1	332181050R1
C3125	C-CERA C	CK725B0U-106K	1	332091065R2
C3126	C-CERA C	CK725B0U-106K	1	332091065R2
C3127	C-CERA C	CK725F1A-105Z1	1	332181050R1
C3128	C-CERA C	CK725F1A-105Z1	1	332181050R1
C3129	C-CERA C	CK725F1A-105Z1	1	332181050R1
C3130	C-CERA C	CK725B0U-106K	1	332091065R2
C3131	C-CERA C	CK725F1A-105Z1	1	332181050R1
C3132	C-CERA C	CC725CH1H-101J1	1	342101014R1
C3133	C-CERA C	CK725F1A-105Z1	1	332181050R1
C3134	C-CERA C	CK725B1C-104K1	1	332121045R1
C3135	C-CERA C	CK725B1C-104K1	1	332121045R1
C3136	C-CERA C	CK725F1A-105Z1	1	332181050R1
C3137	C-CERA C	CK725F1A-105Z1	1	332181050R1
C3138	C-CERA C	CK725F1A-105Z1	1	332181050R1
C3139	C-CERA C	CK725F1A-105Z1	1	332181050R1
C3140	C-CERA C	CK725F1A-105Z1	1	332181050R1
C3143	C-CERA C	CK725F1A-105Z1	1	332181050R1
C3144	C-CERA C	CK725F1A-105Z1	1	332181050R1
C3145	C-CERA C	CK725B0U-106K	1	332091065R2
C3146	C-CERA C	CK725F1A-105Z1	1	332181050R1
C3147	C-CERA C	CK725B0U-106K	1	332091065R2
C3148	C-CERA C	CK725B1H-223K1	1	332102235R1
C3149	C-CERA C	CK725F1A-105Z1	1	332181050R1
C3150	CHIP ELECT C	CEWX4V-22M	1	3981G2207R2
C3151	C-CERA C	CK725B1H-103K1	1	332101035R1
C3152	C-CERA C	CK725B0U-106K	1	332091065R2
C3153	C-CERA C	CK725F1A-105Z1	1	332181050R1
C3154	C-CERA C	CK725B0U-106K	1	332091065R2
C3155	C-CERA C	CK725F1A-105Z1	1	332181050R1
C3156	C-CERA C	CC725CH1H-102J1	1	342101024R1
C3157	C-CERA C	CK725F1A-105Z1	1	332181050R1
C3158	C-CERA C	CK725F1A-105Z1	1	332181050R1
C3159	C-CERA C	CK725F1A-105Z1	1	332181050R1
C3202	C-CERA C	CK725F1A-105Z1	1	332181050R1
C3204	C-CERA C	CK725B0U-106K	1	332091065R2

C3205	C-CERA C	CK725F1A-105Z1	1	332181050R1
C3206	C-CERA C	CK725F1A-105Z1	1	332181050R1
C3207	C-CERA C	CK725B0J-106K	1	332091065R2
C3208	C-CERA C	CK725F1A-105Z1	1	332181050R1
C3209	C-CERA C	CK725F1A-105Z1	1	332181050R1
C3210	CHIP ELECT C	CEWX16V-100M	1	398141017R2
C3211	C-CERA C	CK725B1H-222K1	1	332102225R1
C3213	C-CERA C	CK725F1A-105Z1	1	332181050R1
C3214	C-CERA C	CK725B0J-106K	1	332091065R2
C3215	CHIP ELECT C	CEWX16V-10M	1	398141007R2
C3216	C-CERA C	CC725CH1H-120I1	1	342101204R1
C3219	C-CERA C	CC725CH1H-120I1	1	342101204R1
C3220	C-CERA C	CC725CH1H-120I1	1	342101204R1
C3223	C-CERA C	CC725CH1H-120I1	1	342101204R1
C3224	C-CERA C	CK725B1H-152K1	1	332101525R1
C3225	C-CERA C	CK725B1H-152K1	1	332101525R1
C3226	C-CERA C	CK725F1A-105Z1	1	332181050R1
C3227	CHIP ELECT C	CEWX16V-10M	1	398141007R2
C3228	C-CERA C	CK725B1H-222K1	1	332102225R1
C3229	C-CERA C	CK725F1A-105Z1	1	332181050R1
C3230	C-CERA C	CK725B0J-106K	1	332091065R2
C3231	C-CERA C	CK725F1A-105Z1	1	332181050R1
C3233	CHIP ELECT C	CEWX16V-100M	1	398141017R2
C3402	C-CERA C	CK725F1A-105Z1	1	332181050R1
C3403	C-CERA C	CK725F1A-105Z1	1	332181050R1
C3404	C-CERA C	CK725F1A-105Z1	1	332181050R1
C3405	C-CERA C	CK725F1A-105Z1	1	332181050R1
C3406	C-CERA C	CK725F1A-105Z1	1	332181050R1
C3407	C-CERA C	CK725F1A-105Z1	1	332181050R1
C3408	C-CERA C	CK725F1A-105Z1	1	332181050R1
C3409	C-CERA C	CK725F1A-105Z1	1	332181050R1
C3410	C-CERA C	CK725F1A-105Z1	1	332181050R1
C3412	C-CERA C	CK725F1A-105Z1	1	332181050R1
C3413	C-CERA C	CK725F1A-105Z1	1	332181050R1
C3414	C-CERA C	CC725CH1H-102I1	1	342101024R1
C3415	C-CERA C	CK725F1A-105Z1	1	332181050R1
C3416	C-CERA C	CK725F1A-105Z1	1	332181050R1
C3417	C-CERA C	CK725F1A-105Z1	1	332181050R1
C3418	C-CERA C	CK725F1A-105Z1	1	332181050R1

C3419	C-CERA C	CK725F1A-105Z1	1	332181050R1
C3420	C-CERA C	CK725B0U-106K	1	332091065R2
C3421	C-CERA C	CK725F1A-105Z1	1	332181050R1
C3422	C-CERA C	CK725F1A-105Z1	1	332181050R1
C3423	C-CERA C	CK725F1A-105Z1	1	332181050R1
C3424	C-CERA C	CK725F1A-105Z1	1	332181050R1
C3425	C-CERA C	CK725F1A-105Z1	1	332181050R1
C3426	C-CERA C	CK725F1A-105Z1	1	332181050R1
C3427	C-CERA C	CK725F1A-105Z1	1	332181050R1
C3428	C-CERA C	CK725F1A-105Z1	1	332181050R1
C3429	C-CERA C	CK725F1A-105Z1	1	332181050R1
C3430	C-CERA C	CK725F1A-105Z1	1	332181050R1
C3431	C-CERA C	CK725F1A-105Z1	1	332181050R1
C3432	C-CERA C	CK725F1A-105Z1	1	332181050R1
C3433	C-CERA C	CK725F1A-105Z1	1	332181050R1
C3434	C-CERA C	CK725F1A-105Z1	1	332181050R1
C3435	C-CERA C	CK725F1A-105Z1	1	332181050R1
C3436	C-CERA C	CK725F1A-105Z1	1	332181050R1
C3437	C-CERA C	CK725F1A-105Z1	1	332181050R1
C3438	C-CERA C	CK725F1A-105Z1	1	332181050R1
C3439	C-CERA C	CK725F1A-105Z1	1	332181050R1
C3440	C-CERA C	CK725F1A-105Z1	1	332181050R1
C3441	C-CERA C	CK725F1A-105Z1	1	332181050R1
C3442	C-CERA C	CK725B0U-106K	1	332091065R2
C3443	C-CERA C	CK725F1A-105Z1	1	332181050R1
C3444	C-CERA C	CC725CH1H-102I1	1	342101024R1
C3445	C-CERA C	CK725F1A-105Z1	1	332181050R1
C3446	C-CERA C	CK725B0U-106K	1	332091065R2
C3447	C-CERA C	CK725B0U-106K	1	332091065R2
C3448	C-CERA C	CK725B0U-106K	1	332091065R2
C3449	C-CERA C	CK725F1A-105Z1	1	332181050R1
C3450	C-CERA C	CK725F1A-105Z1	1	332181050R1
C3451	C-CERA C	CK725F1A-105Z1	1	332181050R1
C3452	C-CERA C	CK725F1A-105Z1	1	332181050R1
C3453	CHIP ELECT C	CEWX4V-22M	1	3981G2207R2
C3454	C-CERA C	CK725B1H-103K1	1	332101035R1
C3455	C-CERA C	CK725F1A-105Z1	1	332181050R1
C3456	C-CERA C	CK725B0U-106K	1	332091065R2
C3457	C-CERA C	CK725F1A-105Z1	1	332181050R1

C3458	C-CERA C	CK725B0J-106K	1	332091065R2
C3459	C-CERA C	CK725F1A-105Z1	1	332181050R1
C3461	CHIP ELECT C	CEWX4V-220M	1	3981G2217R2
C3462	C-CERA C	CK725F1A-105Z1	1	332181050R1
C3463	C-CERA C	CC725CH1H-060D1	1	342100602R1
C3464	C-CERA C	CC725CH1H-060D1	1	342100602R1
C8000	CHIP TANTAL	TCSCS0J226MAAR	1	396522207R2
C8000 or	CHIP TANTAL	F93-6.3V-22M	(1)	395522207R2
C8001	C-CERA C	CK725F1E-104Z1	1	332161040R1
C8002	C-CERA C	CK725F1E-104Z1	1	332161040R1
C8003	CHIP TANTAL	TCSCS0J226MAAR	1	396522207R2
C8003 or	CHIP TANTAL	F93-6.3V-22M	(1)	395522207R2
C8004	CHIP TANTAL	TCSCS0J226MAAR	1	396522207R2
C8004 or	CHIP TANTAL	F93-6.3V-22M	(1)	395522207R2
C8005	C-CERA C	CK725B1H-103K1	1	332101035R1
C8006	C-CERA C	CK725F1A-105Z1	1	332181050R1
C8007	C-CERA C	CK725F1A-105Z1	1	332181050R1
C8008	C-CERA C	CK725F1A-105Z1	1	332181050R1
C8009	C-CERA C	CK725F1A-105Z1	1	332181050R1
C8010	C-CERA C	CK725F1A-105Z1	1	332181050R1
C8011	C-CERA C	CK725F1A-105Z1	1	332181050R1
C8012	C-CERA C	CK725F1A-105Z1	1	332181050R1
C8013	C-CERA C	CK725F1A-105Z1	1	332181050R1
C8014	C-CERA C	CK725F1A-105Z1	1	332181050R1
C8015	C-CERA C	CK725F1A-105Z1	1	332181050R1
C8016	C-CERA C	CK725F1A-105Z1	1	332181050R1
C8017	C-CERA C	CK725F1A-105Z1	1	332181050R1
C8018	C-CERA C	CK725F1A-105Z1	1	332181050R1
C8021	CHIP ELECT C	CEWX16V-100M	1	398141017R2
C8022	C-CERA C	CK725F1A-105Z1	1	332181050R1
C8023	CHIP ELECT C	CEWX4V-100M	1	3981G1017R2
C8026	CHIP ELECT C	CEWX4V-220M	1	3981G2217R2
C8030	CHIP TANTAL	TCSCS0J226MAAR	1	396522207R2
C8030 or	CHIP TANTAL	F93-6.3V-22M	(1)	395522207R2
C8031	C-CERA C	CK725F1E-104Z1	1	332161040R1
C8032	C-CERA C	CK725B1H-103K1	1	332101035R1
C8033	C-CERA C	CK725F1E-104Z1	1	332161040R1
C8034	CHIP TANTAL	TCSCS0J226MAAR	1	396522207R2
C8034 or	CHIP TANTAL	F93-6.3V-22M	(1)	395522207R2

C8041	CHIP ELECT C	CEWX16V-100M	1	398141017R2
C8042	C-CERA C	CK725F1E-104Z1	1	332161040R1
C8043	CHIP ELECT C	CEWX4V-220M	1	3981G2217R2
C8044	CHIP ELECT C	CEWX4V-220M	1	3981G2217R2
C8051	C-CERA C	CK725F1E-104Z1	1	332161040R1
C8052	C-CERA C	CK725F1E-104Z1	1	332161040R1
C8053	C-CERA C	CK725F1E-104Z1	1	332161040R1
C8054	C-CERA C	CK725F1E-104Z1	1	332161040R1
C8055	C-CERA C	CK725F1E-104Z1	1	332161040R1
C8056	C-CERA C	CK725F1E-104Z1	1	332161040R1
C8057	C-CERA C	CK725F1E-104Z1	1	332161040R1
C8058	C-CERA C	CK725F1E-104Z1	1	332161040R1
C8059	C-CERA C	CK725F1E-104Z1	1	332161040R1
C8060	C-CERA C	CK725F1E-104Z1	1	332161040R1
C8061	C-CERA C	CK725F1E-104Z1	1	332161040R1
C8062	C-CERA C	CK725F1E-104Z1	1	332161040R1
C8063	C-CERA C	CK725F1E-104Z1	1	332161040R1
C8064	C-CERA C	CK725F1E-104Z1	1	332161040R1
C8065	C-CERA C	CK725F1E-104Z1	1	332161040R1
C8066	C-CERA C	CK725F1E-104Z1	1	332161040R1
C8077	C-CERA C	CK725F1E-104Z1	1	332161040R1
C8078	C-CERA C	CK725F1E-104Z1	1	332161040R1
C8079	C-CERA C	CK725F1E-104Z1	1	332161040R1
C8080	C-CERA C	CK725F1E-104Z1	1	332161040R1
C8142	C-CARBON R	RN72K1J-000JE	1	435030004R1
C8161	C-CERA C	CK725F1A-105Z1	1	332181050R1
C8162	CHIP ELECT C	CEWX4V-100M	1	3981G1017R2
C8163	C-CERA C	CK725B1H-102K1	1	332101025R1
C8164	C-CERA C	CK725B0J-106K	1	332091065R2
C8165	C-CERA C	CK725F1E-104Z1	1	332161040R1
C8166	C-CERA C	CK725B0J-106K	1	332091065R2
C8167	C-CERA C	CK725F1E-104Z1	1	332161040R1
C8168	C-CERA C	CK725B0J-106K	1	332091065R2
C8169	C-CERA C	CK725F1E-104Z1	1	332161040R1
C8170	C-CERA C	CK725F1E-104Z1	1	332161040R1
C8171	C-CERA C	CK725F1E-104Z1	1	332161040R1
C8172	C-CERA C	CK725F1E-104Z1	1	332161040R1
C8173	C-CERA C	CK725F1E-104Z1	1	332161040R1
C8174	C-CERA C	CK725F1E-104Z1	1	332161040R1

C8175	C-CERA C	CK725F1E-104Z1	1	332161040R1
C8176	C-CERA C	CK725F1E-104Z1	1	332161040R1
C8177	C-CERA C	CK725F1E-104Z1	1	332161040R1
C8178	C-CERA C	CK725F1E-104Z1	1	332161040R1
C8179	C-CERA C	CK725F1E-104Z1	1	332161040R1
C8180	C-CERA C	CK725F1E-104Z1	1	332161040R1
C8181	C-CERA C	CK725F1E-104Z1	1	332161040R1
C8200	CHIP TANTAL	TCSCS0J226MAAR	1	396522207R2
C8200 or	CHIP TANTAL	F93-6.3V-22M	(1)	395522207R2
C8201	CHIP TANTAL	TCSCS0J226MAAR	1	396522207R2
C8201 or	CHIP TANTAL	F93-6.3V-22M	(1)	395522207R2
C8202	C-CERA C	CK725F1E-104Z1	1	332161040R1
C8203	C-CERA C	CK725F1E-104Z1	1	332161040R1
C8204	C-CERA C	CK725F1E-104Z1	1	332161040R1
C8205	C-CERA C	CK725F1E-104Z1	1	332161040R1
C8206	C-CERA C	CK725F1E-104Z1	1	332161040R1
C8207	C-CERA C	CK725F1E-104Z1	1	332161040R1
C8208	C-CERA C	CK725F1E-104Z1	1	332161040R1
C8209	C-CERA C	CK725F1E-104Z1	1	332161040R1
C8210	C-CERA C	CK725F1E-104Z1	1	332161040R1
C8211	C-CERA C	CK725F1E-104Z1	1	332161040R1
C8212	C-CERA C	CK725F1E-104Z1	1	332161040R1
C8213	C-CERA C	CK725F1E-104Z1	1	332161040R1
C8214	C-CERA C	CK725F1E-104Z1	1	332161040R1
C8215	C-CERA C	CK725F1E-104Z1	1	332161040R1
C8216	C-CERA C	CK725F1E-104Z1	1	332161040R1
C8217	C-CERA C	CK725F1E-104Z1	1	332161040R1
C8218	C-CERA C	CK725F1E-104Z1	1	332161040R1
C8219	CHIP TANTAL	TCSCS0J226MAAR	1	396522207R2
C8219 or	CHIP TANTAL	F93-6.3V-22M	(1)	395522207R2
C8220	CHIP TANTAL	TCSCS0J226MAAR	1	396522207R2
C8220 or	CHIP TANTAL	F93-6.3V-22M	(1)	395522207R2
C8221	C-CERA C	CK725B1H-103K1	1	332101035R1
C8222	C-CERA C	CK725B1H-103K1	1	332101035R1
C8223	C-CERA C	CK725F1E-104Z1	1	332161040R1
C8224	C-CERA C	CK725B1H-103K1	1	332101035R1
C8225	C-CERA C	CK725F1E-104Z1	1	332161040R1
C8226	C-CERA C	CK725F1E-104Z1	1	332161040R1
C8227	C-CERA C	CK725B1H-103K1	1	332101035R1

C8228	C-CERA C	CK725F1E-104Z1	1	332161040R1
C8229	C-CERA C	CK725F1E-104Z1	1	332161040R1
C8230	C-CERA C	CK725F1E-104Z1	1	332161040R1
C8231	C-CERA C	CK725B1H-103K1	1	332101035R1
C8232	C-CERA C	CK725F1E-104Z1	1	332161040R1
C8233	C-CERA C	CK725F1E-104Z1	1	332161040R1
C8234	C-CERA C	CK725F1E-104Z1	1	332161040R1
C8235	C-CERA C	CK725B1H-103K1	1	332101035R1
C8236	CHIP TANTAL	TCSGS0J226MAAR	1	396522207R2
C8236 or	CHIP TANTAL	F93-6.3V-22M	(1)	395522207R2
C8237	CHIP TANTAL	TCSGS0J226MAAR	1	396522207R2
C8237 or	CHIP TANTAL	F93-6.3V-22M	(1)	395522207R2
C8238	C-CERA C	CK725F1E-104Z1	1	332161040R1
C8239	C-CERA C	CK725F1E-104Z1	1	332161040R1
C8240	C-CERA C	CK725F1E-104Z1	1	332161040R1
C8241	C-CERA C	CK725F1E-104Z1	1	332161040R1
C8242	C-CERA C	CK725F1E-104Z1	1	332161040R1
C8243	C-CERA C	CK725F1E-104Z1	1	332161040R1
C8244	C-CERA C	CK725F1E-104Z1	1	332161040R1
C8245	C-CERA C	CK725F1E-104Z1	1	332161040R1
C8246	C-CERA C	CK725F1E-104Z1	1	332161040R1
C8247	C-CERA C	CK725F1E-104Z1	1	332161040R1
C8248	C-CERA C	CK725F1E-104Z1	1	332161040R1
C8249	C-CERA C	CK725F1E-104Z1	1	332161040R1
C8250	C-CERA C	CK725F1E-104Z1	1	332161040R1
C8251	CHIP TANTAL	TCSGS0J226MAAR	1	396522207R2
C8251 or	CHIP TANTAL	F93-6.3V-22M	(1)	395522207R2
C8252	C-CERA C	CK725F1E-104Z1	1	332161040R1
C8253	C-CERA C	CK725F1E-104Z1	1	332161040R1
C8254	C-CERA C	CK725F1E-104Z1	1	332161040R1
C8255	CHIP TANTAL	TCSGS0J226MAAR	1	396522207R2
C8255 or	CHIP TANTAL	F93-6.3V-22M	(1)	395522207R2
C8256	C-CERA C	CK725F1E-104Z1	1	332161040R1
C8257	C-CERA C	CK725F1E-104Z1	1	332161040R1
C8258	CHIP TANTAL	TCSGS0J226MAAR	1	396522207R2
C8258 or	CHIP TANTAL	F93-6.3V-22M	(1)	395522207R2
C8259	C-CERA C	CK725F1E-104Z1	1	332161040R1
C8260	CHIP TANTAL	TCSGS0J226MAAR	1	396522207R2
C8260 or	CHIP TANTAL	F93-6.3V-22M	(1)	395522207R2

C8261	C-CERA C	CK725F1E-104Z1	1	332161040R1
C8262	C-CERA C	CK725F1E-104Z1	1	332161040R1
C8263	C-CERA C	CK725F1E-104Z1	1	332161040R1
C8264	CHIP TANTAL	TCSGS0J226MAAR	1	396522207R2
C8264 or	CHIP TANTAL	F93-6.3V-22M	(1)	395522207R2
C8265	C-CERA C	CK725F1E-104Z1	1	332161040R1
C8266	C-CERA C	CK725F1E-104Z1	1	332161040R1
C8267	C-CERA C	CK725F1E-104Z1	1	332161040R1
C8268	CHIP TANTAL	TCSGS0J226MAAR	1	396522207R2
C8268 or	CHIP TANTAL	F93-6.3V-22M	(1)	395522207R2
C8269	C-CERA C	CK725F1E-104Z1	1	332161040R1
C8270	C-CERA C	CK725F1E-104Z1	1	332161040R1
C8271	C-CERA C	CK725F1E-104Z1	1	332161040R1
C8272	C-CERA C	CK725F1E-104Z1	1	332161040R1
C8273	CHIP TANTAL	TCSGS0J226MAAR	1	396522207R2
C8273 or	CHIP TANTAL	F93-6.3V-22M	(1)	395522207R2
C8274	C-CERA C	CK725F1E-104Z1	1	332161040R1
C8275	C-CERA C	CK725F1E-104Z1	1	332161040R1
C8276	C-CERA C	CK725B1H-103K1	1	332101035R1
C8282	C-CERA C	CK725F1E-104Z1	1	332161040R1
C8284	C-CERA C	CK725F1E-104Z1	1	332161040R1
C8288	C-CERA C	CG725CH1H-330I1	1	342103304R1
C8289	C-CERA C	CG725CH1H-330I1	1	342103304R1
C8290	C-CERA C	CK725B1H-102K1	1	332101025R1
C8291	C-CERA C	CK725F1E-104Z1	1	332161040R1
C8321	C-CARBON R	RN72K1J-000JE	1	435030004R1
C8322	C-CARBON R	RN72K1J-000JE	1	435030004R1
C8326	C-CERA C	CK725F1E-104Z1	1	332161040R1
C8327	C-CERA C	CK725F1A-105Z1	1	332181050R1
C8328	CHIP ELECT C	CEWX16V-22M	1	398142207R2
C8329	C-CERA C	CK725F1A-105Z1	1	332181050R1
C8330	C-CERA C	CK725F1A-105Z1	1	332181050R1
C8332	C-CERA C	CK725F1E-104Z1	1	332161040R1
C8341	C-CARBON R	RN72K1J-000JE	1	435030004R1
C8342	C-CARBON R	RN72K1J-000JE	1	435030004R1
C8348	C-CARBON R	RN72K1J-000JE	1	435030004R1
C8349	C-CARBON R	RN72K1J-000JE	1	435030004R1
C8362	C-CERA C	CK725F1E-104Z1	1	332161040R1
C8364	C-CERA C	CK725B0J-106K	1	332091065R2

C8365	C-CERA C	CK725F1E-104Z1	1	332161040R1
C8366	C-CERA C	CK725B0J-106K	1	332091065R2
C8367	C-CERA C	CK725F1E-104Z1	1	332161040R1
C8368	C-CERA C	CK725B0J-106K	1	332091065R2
C8369	C-CERA C	CK725F1E-104Z1	1	332161040R1
C8370	C-CERA C	CK725F1E-104Z1	1	332161040R1
C8371	C-CERA C	CK725F1E-104Z1	1	332161040R1
C8372	C-CERA C	CK725F1E-104Z1	1	332161040R1
C8373	C-CERA C	CK725F1E-104Z1	1	332161040R1
C8374	C-CERA C	CK725F1E-104Z1	1	332161040R1
C8375	C-CERA C	CK725F1E-104Z1	1	332161040R1
C8376	C-CERA C	CK725F1E-104Z1	1	332161040R1
C8377	C-CERA C	CK725F1E-104Z1	1	332161040R1
C8378	C-CERA C	CK725F1E-104Z1	1	332161040R1
C8379	C-CERA C	CK725F1E-104Z1	1	332161040R1
C8380	C-CERA C	CK725F1E-104Z1	1	332161040R1
C8381	C-CERA C	CK725F1E-104Z1	1	332161040R1
C8401	CHIP ELECT C	CEWX4V-22M	1	3981G2207R2
C8402	CHIP ELECT C	CEWX4V-22M	1	3981G2207R2
C8403	C-CERA C	CK725F1A-105Z1	1	332181050R1
C8404	C-CERA C	CK725B1H-102K1	1	332101025R1
C8405	C-CERA C	CK725F1A-105Z1	1	332181050R1
C8406	C-CERA C	CK725B1H-102K1	1	332101025R1
C8408	CHIP ELECT C	CEWX4V-22M	1	3981G2207R2
C8409	CHIP ELECT C	CEWX4V-22M	1	3981G2207R2
C8410	C-CERA C	CK725F1A-105Z1	1	332181050R1
C8411	C-CERA C	CK725B1H-102K1	1	332101025R1
C8412	C-CERA C	CK725F1A-105Z1	1	332181050R1
C8413	C-CERA C	CK725B1H-102K1	1	332101025R1
C8414	C-CERA C	CK725F1A-105Z1	1	332181050R1
C8415	C-CERA C	CK725B1H-102K1	1	332101025R1
C8416	C-CERA C	CK725B1H-102K1	1	332101025R1
C8417	C-CERA C	CK725F1A-105Z1	1	332181050R1
C8418	CHIP ELECT C	CEWX4V-22M	1	3981G2207R2
C8419	C-CERA C	CK725B1H-102K1	1	332101025R1
C8420	C-CERA C	CK725F1A-105Z1	1	332181050R1
C8421	C-CERA C	CK725B1H-102K1	1	332101025R1
C8422	C-CERA C	CK725F1A-105Z1	1	332181050R1
C8423	C-CERA C	CK725B1H-102K1	1	332101025R1

C8424	C-CERA C	CK725F1A-105Z1	1	332181050R1
C8425	C-CERA C	CK725B1H-102K1	1	332101025R1
C8426	C-CERA C	CK725F1A-105Z1	1	332181050R1
C8427	C-CERA C	CK725B1H-102K1	1	332101025R1
C8428	C-CERA C	CK725F1A-105Z1	1	332181050R1
C8429	C-CERA C	CK725B1H-102K1	1	332101025R1
C8430	C-CERA C	CK725F1A-105Z1	1	332181050R1
C8431	C-CERA C	CK725B1H-102K1	1	332101025R1
C8432	C-CERA C	CK725F1A-105Z1	1	332181050R1
C8433	C-CERA C	CK725B1H-102K1	1	332101025R1
C8434	C-CERA C	CK725F1A-105Z1	1	332181050R1
C8435	C-CERA C	CK725F1A-105Z1	1	332181050R1
C8436	C-CERA C	CK725F1A-105Z1	1	332181050R1
C8437	CHIP ELECT C	CEWX4V-22M	1	3981G2207R2
C8438	C-CERA C	CK725B1H-102K1	1	332101025R1
C8439	C-CERA C	CK725F1A-105Z1	1	332181050R1
C8440	C-CERA C	CK725B0U-106K	1	332091065R2
C8441	CHIP ELECT C	CEWX4V-220M	1	3981G2217R2
C8501	C-CERA C	CK725B1H-102K1	1	332101025R1
C8502	C-CERA C	CK725B0U-106K	1	332091065R2
C8503	C-CERA C	CK725F1A-105Z1	1	332181050R1
C8504	C-CERA C	CK725B1H-102K1	1	332101025R1
C8505	C-CERA C	CK725F1A-105Z1	1	332181050R1
C8506	C-CERA C	CK725B0U-106K	1	332091065R2
C8507	C-CERA C	CK725B1H-102K1	1	332101025R1
C8508	C-CERA C	CK725F1A-105Z1	1	332181050R1
C8509	C-CERA C	CK725B1H-102K1	1	332101025R1
C8510	C-CERA C	CK725F1A-105Z1	1	332181050R1
C8511	C-CERA C	CK725B1H-102K1	1	332101025R1
C8512	C-CERA C	CK725F1A-105Z1	1	332181050R1
C8513	C-CERA C	CK725B1H-102K1	1	332101025R1
C8514	C-CERA C	CK725F1A-105Z1	1	332181050R1
C8515	C-CERA C	CK725B1H-102K1	1	332101025R1
C8516	C-CERA C	CK725F1A-105Z1	1	332181050R1
C8517	C-CERA C	CK725B1H-102K1	1	332101025R1
C8518	C-CERA C	CK725F1A-105Z1	1	332181050R1
C8519	C-CERA C	CK725F1A-105Z1	1	332181050R1
C8521	C-CERA C	CK725F1E-104Z1	1	332161040R1
C8522	C-CERA C	CK725B0U-106K	1	332091065R2

C8525	C-CERA C	CK725B0J-106K	1	332091065R2
C8527	C-CERA C	CK725B1H-102K1	1	332101025R1
C8529	C-CERA C	CK725B0J-106K	1	332091065R2
C8530	C-CERA C	CK725F1A-105Z1	1	332181050R1
C8531	C-CERA C	CK725B1H-102K1	1	332101025R1
C8532	C-CERA C	CK725F1A-105Z1	1	332181050R1
C8533	C-CERA C	CK725B1H-102K1	1	332101025R1
C8534	C-CERA C	CK725F1A-105Z1	1	332181050R1
C8535	C-CERA C	CK725B1H-102K1	1	332101025R1
C8536	C-CERA C	CK725F1A-105Z1	1	332181050R1
C8537	C-CERA C	CK725B1H-102K1	1	332101025R1
C8538	C-CERA C	CK725F1A-105Z1	1	332181050R1
C8539	C-CERA C	CK725B1H-102K1	1	332101025R1
C8540	C-CERA C	CK725F1A-105Z1	1	332181050R1
C8548	C-CERA C	CK725F1A-105Z1	1	332181050R1
C8549	C-CERA C	CK725B1H-102K1	1	332101025R1
C8550	C-CERA C	CK725F1A-105Z1	1	332181050R1
C8551	C-CERA C	CK725B1H-102K1	1	332101025R1
C8552	C-CERA C	CK725F1A-105Z1	1	332181050R1
C8553	C-CERA C	CK725B1H-102K1	1	332101025R1
C8554	C-CERA C	CK725F1A-105Z1	1	332181050R1
C8555	C-CERA C	CK725B1H-102K1	1	332101025R1
C8556	C-CERA C	CK725F1A-105Z1	1	332181050R1
C8557	C-CERA C	CK725B1H-102K1	1	332101025R1
C8558	C-CERA C	CK725F1A-105Z1	1	332181050R1
C8559	C-CERA C	CK725B1H-102K1	1	332101025R1
C8560	C-CERA C	CK725B0J-106K	1	332091065R2
C8563	C-CERA C	CK725F1A-105Z1	1	332181050R1
C8564	C-CERA C	CK725B0J-106K	1	332091065R2
C8565	C-CERA C	CK725B0J-106K	1	332091065R2
C8566	C-CERA C	CK725B1H-102K1	1	332101025R1
C8567	C-CERA C	CK725F1A-105Z1	1	332181050R1
C8573	C-CERA C	CK725F1A-105Z1	1	332181050R1
C8574	C-CERA C	CC725CH1H-070D1	1	342100702R1
C8575	C-CERA C	CC725CH1H-070D1	1	342100702R1
C8584	C-CERA C	CK725B0J-106K	1	332091065R2
C8585	C-CERA C	CK725B0J-106K	1	332091065R2
C8605	C-CARBON R	RN72K1J-000JE	1	435030004R1
C8608	C-CERA C	CK725F1A-105Z1	1	332181050R1

C8609	C-CERA C	CK725B0J-106K	1	332091065R2
C8611	C-CARBON R	RN72K1J-000JE	1	435030004R1
C8612	C-CARBON R	RN72K1J-000JE	1	435030004R1
C8621	C-CARBON R	RN72K1J-000JE	1	435030004R1
C8622	C-CARBON R	RN72K1J-000JE	1	435030004R1
C8631	C-CARBON R	RN72K1J-000JE	1	435030004R1
C8632	C-CARBON R	RN72K1J-000JE	1	435030004R1
C8675	CHIP ELECT C	CEWX4V-100M	1	3981G1017R2
C8676	C-CERA C	CK725F1A-105Z1	1	332181050R1
C8701	C-CERA C	CK725F1A-105Z1	1	332181050R1
C8702	C-CERA C	CK725F1A-105Z1	1	332181050R1
C8703	C-CERA C	CK725F1A-105Z1	1	332181050R1
C8704	CHIP ELECT C	CEWX50V-4.7M	1	398180477R2
C8705	C-CERA C	CK725F1A-105Z1	1	332181050R1
C8706	C-CERA C	CK725F1A-105Z1	1	332181050R1
C8707	C-CERA C	CK725F1A-105Z1	1	332181050R1
C8708	C-CERA C	CK725F1A-105Z1	1	332181050R1
C8709	CHIP ELECT C	CEWX4V-220M	1	3981G2217R2
C8710	C-CERA C	CK725F1A-105Z1	1	332181050R1
C8801	C-CERA C	CK725F1A-105Z1	1	332181050R1
C8802	CHIP ELECT C	CEWX4V-220M	1	3981G2217R2
C8803	CHIP ELECT C	CEWX4V-220M	1	3981G2217R2
C8804	CHIP ELECT C	CEWX4V-220M	1	3981G2217R2
C8805	CHIP ELECT C	CEWX4V-220M	1	3981G2217R2
C8810	C-CERA C	CK725F1A-105Z1	1	332181050R1
C8811	C-CERA C	CK725F1A-105Z1	1	332181050R1
C8812	C-CERA C	CK725B1A-154K1	1	332131545R1
C8813	C-CERA C	CK725B1H-153K1	1	332101535R1
C8814	C-CERA C	CK725F1A-105Z1	1	332181050R1
C8815	C-CERA C	CK725B1A-154K1	1	332131545R1
C8816	C-CERA C	CK725B1H-153K1	1	332101535R1
C8817	C-CERA C	CK725B1H-222K1	1	332102225R1
C8818	C-CERA C	CK725F1A-105Z1	1	332181050R1
C8819	C-CERA C	CK725B1H-222K1	1	332102225R1
C8820	C-CERA C	CK725F1A-105Z1	1	332181050R1
C8821	C-CERA C	CK725F1A-105Z1	1	332181050R1
C8822	C-CERA C	CK725F1A-105Z1	1	332181050R1
C8823	C-CERA C	CK725F1A-105Z1	1	332181050R1
C8825	C-CERA C	CK725B0J-225K	1	332092255R1

C8826	CHIP ELECT C	CEWX4V-100M	1	3981G1017R2
C8838	C-CERA C	CC725CHIH-470I1	1	342104704R1
C8839	C-CERA C	CC725CHIH-470I1	1	342104704R1
C8840	C-CERA C	CC725CHIH-470I1	1	342104704R1
C8855	C-CERA C	CK725F1E-104Z1	1	332161040R1
C8856	C-CERA C	CK725F1E-104Z1	1	332161040R1
C8857	C-CERA C	CK725F1E-104Z1	1	332161040R1
C8858	C-CERA C	CK725F1E-104Z1	1	332161040R1
C8859	C-CERA C	CK725F1E-104Z1	1	332161040R1
C8860	C-CERA C	CK725F1E-104Z1	1	332161040R1
C8861	C-CERA C	CK725F1E-104Z1	1	332161040R1
C8862	C-CERA C	CK725F1E-104Z1	1	332161040R1
C8863	C-CERA C	CK725F1E-104Z1	1	332161040R1
C8864	C-CERA C	CK725F1E-104Z1	1	332161040R1
C8865	C-CERA C	CK725F1E-104Z1	1	332161040R1
C8866	C-CERA C	CK725F1E-104Z1	1	332161040R1
C8867	C-CERA C	CK725F1E-104Z1	1	332161040R1
C8868	C-CERA C	CK725F1E-104Z1	1	332161040R1
C8869	C-CERA C	CK725F1E-104Z1	1	332161040R1
C8870	C-CERA C	CK725F1E-104Z1	1	332161040R1
C8951	C-CERA C	CK725B1C-104K1	1	332121045R1
C8952	C-CERA C	CK725F1A-105Z1	1	332181050R1
C8953	CD C	UCDIE221MNL1GS	1	396652217R2
C8954	C-CERA C	CK725B1H-103K1	1	332101035R1
C8955	C-CERA C	CK725B1H-332K1	1	332103325R1
C8956	C-CERA C	CK725F1A-105Z1	1	332181050R1
C8957	CHIP ELECT C	CEWT10V-470M	1	395734717R2
C8958	C-CERA C	CK725F1A-105Z1	1	332181050R1
C8961	C-CERA C	CK725B1A-224K1	1	332132245R1
C8962	C-CERA C	CK725F1A-105Z1	1	332181050R1
C8963	CD C	UCDIE221MNL1GS	1	396652217R2
C8964	C-CERA C	CK725B1H-332K1	1	332103325R1
C8965	C-CERA C	CK725B1H-332K1	1	332103325R1
C8966	C-CERA C	CK725F1A-105Z1	1	332181050R1
C8967	CHIP ELECT C	CEWT10V-470M	1	395734717R2
C8968	C-CERA C	CK725F1A-105Z1	1	332181050R1
C8971	C-CERA C	CK725B1C-104K1	1	332121045R1
C8972	C-CERA C	CK725F1A-105Z1	1	332181050R1
C8973	CD C	UCDIE221MNL1GS	1	396652217R2

C8974	C-CERA C	CK725BIH-332K1	1	332103325R1
C8975	C-CERA C	CK725BIH-332K1	1	332103325R1
C8976	C-CERA C	CK725F1A-105Z1	1	332181050R1
C8977	CHIP ELECT C	CEWT10V-470M	1	395734717R2
C8978	C-CERA C	CK725F1A-105Z1	1	332181050R1
C8979	C-CERA C	CK725F1A-105Z1	1	332181050R1
C8981	C-CERA C	CK725BIH-223K1	1	332102235R1
C8982	C-CERA C	CK725F1A-105Z1	1	332181050R1
C8983	CD C	UCD1E221MNL1GS	1	396652217R2
C8984	C-CERA C	CK725BIH-103K1	1	332101035R1
C8985	C-CERA C	CK725BIH-222K1	1	332102225R1
C8986	C-CERA C	CK725F1A-105Z1	1	332181050R1
C8987	CHIP ELECT C	CEWT10V-470M	1	395734717R2
C8988	C-CERA C	CK725F1A-105Z1	1	332181050R1

[RESISTOR]

R268	C-CARBON R	RN72K1J-331JE	1	435033314R1
R269	C-CARBON R	RN72K1J-331JE	1	435033314R1
R270	C-CARBON R	RN72K1J-331JE	1	435033314R1
R271	C-CARBON R	RN72K1J-470JE	1	435034704R1
R272	C-CARBON R	RN72K1J-331JE	1	435033314R1
R273	C-CARBON R	RN72K1J-331JE	1	435033314R1
R274	C-CARBON R	RN72K1J-470JE	1	435034704R1
R275	C-CARBON R	RN72K1J-221JE	1	435032214R1
R276	C-CARBON R	RN72K1J-221JE	1	435032214R1
R277	C-CARBON R	RN72K1J-151JE	1	435031514R1
R278	C-CARBON R	RN72K1J-331JE	1	435033314R1
R279	C-CARBON R	RN72K1J-331JE	1	435033314R1
R280	C-CARBON R	RN72K1J-470JE	1	435034704R1
R3009	C-CARBON R	RN72K1J-330JE	1	435033304R1
R3010	C-R NET	RM71J330X04	1	43484733004R2
R3011	C-R NET	RM71J330X04	1	43484733004R2
R3012	C-R NET	RM71J330X04	1	43484733004R2
R3013	C-R NET	RM71J330X04	1	43484733004R2
R3014	C-R NET	RM71J330X04	1	43484733004R2
R3015	C-R NET	RM71J330X04	1	43484733004R2
R3016	C-CARBON R	RN72K1J-470JE	1	435034704R1
R3017	C-R NET	RM71J330X04	1	43484733004R2
R3018	C-CARBON R	RN72K1J-470JE	1	435034704R1
R3019	C-R NET	RM71J330X04	1	43484733004R2

R3020	C-R NET	RM7LJ330X04	1	43484733004R2
R3021	C-CARBON R	RN72KIJ-470JE	1	435034704R1
R3022	C-CARBON R	RN72KIJ-470JE	1	435034704R1
R3023	C-R NET	RM7LJ470X04	1	43484747004R2
R3024	C-CARBON R	RN72KIJ-470JE	1	435034704R1
R3025	C-CARBON R	RN72KIJ-102JE	1	435031024R1
R3026	C-CARBON R	RN72KIJ-470JE	1	435034704R1
R3028	C-CARBON R	RN72KIJ-470JE	1	435034704R1
R3029	C-CARBON R	RN72KIJ-102JE	1	435031024R1
R3032	C-CARBON R	RN72KIJ-103JE	1	435031034R1
R3033	C-CARBON R	RN72KIJ-470JE	1	435034704R1
R3034	C-CARBON R	RN72KIJ-470JE	1	435034704R1
R3035	C-CARBON R	RN72KIJ-470JE	1	435034704R1
R3036	C-CARBON R	RN72KIJ-470JE	1	435034704R1
R3037	C-CARBON R	RN72KIJ-470JE	1	435034704R1
R3038	C-CARBON R	RN72KIJ-470JE	1	435034704R1
R3039	C-CARBON R	RN72KIJ-470JE	1	435034704R1
R3040	C-CARBON R	RN72KIJ-103JE	1	435031034R1
R3041	C-R NET	RM7LJ330X04	1	43484733004R2
R3042	C-R NET	RM7LJ330X04	1	43484733004R2
R3043	C-CARBON R	RN72KIJ-000JE	1	435030004R1
R3044	C-R NET	RM7LJ330X04	1	43484733004R2
R3045	C-R NET	RM7LJ330X04	1	43484733004R2
R3047	C-CARBON R	RN72KIJ-560JE	1	435035604R1
R3048	C-CARBON R	RN72KIJ-000JE	1	435030004R1
R3049	C-CARBON R	RN72KIJ-560JE	1	435035604R1
R3050	C-CARBON R	RN72KIJ-560JE	1	435035604R1
R3051	C-CARBON R	RN72KIJ-560JE	1	435035604R1
R3052	C-CARBON R	RN72KIJ-103JE	1	435031034R1
R3053	C-CARBON R	RN72KIJ-103JE	1	435031034R1
R3054	C-CARBON R	RN72KIJ-103JE	1	435031034R1
R3055	C-CARBON R	RN72KIJ-472JE	1	435034724R1
R3056	C-CARBON R	RN72KIJ-472JE	1	435034724R1
R3060	C-CARBON R	RN72KIJ-680JE	1	435036804R1
R3061	C-CARBON R	RN72KIJ-470JE	1	435034704R1
R3062	C-CARBON R	RN72KIJ-680JE	1	435036804R1
R3063	C-CARBON R	RN72KIJ-680JE	1	435036804R1
R3064	C-CARBON R	RN72KIJ-680JE	1	435036804R1
R3065	C-CARBON R	RN72KIJ-680JE	1	435036804R1

R3066	C-CARBON R	RN72KIJ-102JE	1	435031024R1	
R3101	C-CARBON R	RN72KIJ-103JE	1	435031034R1	
R3102	C-CARBON R	RN72KIJ-153JE	1	435031534R1	
R3108	C-CARBON R	RN72KIJ-103JE	1	435031034R1	
R3110	C-CARBON R	RN72KIJ-103JE	1	435031034R1	
R3111	C-CARBON R	RN72KIJ-103JE	1	435031034R1	
R3113	C-CARBON R	RN72KIJ-103JE	1	435031034R1	
R3115	C-CARBON R	RN72KIJ-103JE	1	435031034R1	
R3117	C-CARBON R	RN72KIJ-103JE	1	435031034R1	
R3119	C-CARBON R	RN72KIJ-472JE	1	435034724R1	
R3121	C-CARBON R	RN72KIJ-153JE	1	435031534R1	
R3122	C-CARBON R	RN72KIJ-102JE	1	435031024R1	
R3123	C-CARBON R	RN72KIJ-000JE	1	435030004R1	
R3124	C-CARBON R	RN72KIJ-331JE	1	435033314R1	
R3125	C-CARBON R	RN72KIJ-470JE	1	435034704R1	
R3126	C-CARBON R	RN72KIJ-470JE	1	435034704R1	
R3127	C-CARBON R	RN72KIJ-470JE	1	435034704R1	
R3128	C-CARBON R	RN72KIJ-472JE	1	435034724R1	
R3129	C-CARBON R	RN72KIJ-470JE	1	435034704R1	
R3130	C-CARBON R	RN72KIJ-470JE	1	435034704R1	
R3131	C-CARBON R	RN72KIJ-470JE	1	435034704R1	
R3132	C-CARBON R	RN72KIJ-103JE	1	435031034R1	
R3133	C-CARBON R	RN72KIJ-470JE	1	435034704R1	
R3134	C-CARBON R	RN72KIJ-103JE	1	435031034R1	
R3135	C-CARBON R	RN72KIJ-103JE	1	435031034R1	
R3136	C-CARBON R	RN72KIJ-000JE	1	435030004R1	
R3137	C-CARBON R	RN72KIJ-000JE	1	435030004R1	
R3139	C-CARBON R	RN72KIJ-101JE	1	435031014R1	
R3140	C-CARBON R	RN72KIJ-103JE	1	435031034R1	
R3143	C-CARBON R	RN72KIJ-103JE	1	435031034R1	
R3144	C-CARBON R	RN72KIJ-101JE	1	435031014R1	
R3145	C-CARBON R	RN72KIJ-103JE	1	435031034R1	
R3146	C-CARBON R	RN72KIJ-390JE	1	435033904R1	
R3147	C-CARBON R	RN72KIJ-000JE	1	435030004R1	
R3148	C-CARBON R	RN72KIJ-390JE	1	435033904R1	
R3149	C-CARBON R	RN72KIJ-102JE	1	435031024R1	
R3150	C-CARBON R	RN72KIJ-330JE	1	435033304R1	
R3151	C-CARBON R	RN72KIJ-103JE	1	435031034R1	
R3152	C-CARBON R	RN72KIJ-103JE	1	435031034R1	

R3154	C-CARBON R	RN72KIJ-390JE	1	435033904R1
R3155	C-CARBON R	RN72KIJ-390JE	1	435033904R1
R3156	C-CARBON R	RN72KIJ-390JE	1	435033904R1
R3157	C-CARBON R	RN72KIJ-000JE	1	435030004R1
R3158	C-CARBON R	RN72KIJ-000JE	1	435030004R1
R3159	C-CARBON R	RN72KIJ-000JE	1	435030004R1
R3160	C-CARBON R	RN72KIJ-000JE	1	435030004R1
R3162	C-CARBON R	RN72KIJ-390JE	1	435033904R1
R3163	C-CARBON R	RN72KIJ-220JE	1	435032204R1
R3164	C-CARBON R	RN72KIJ-472JE	1	435034724R1
R3168	C-CARBON R	RN72KIJ-220JE	1	435032204R1
R3169	C-CARBON R	RN72KIJ-220JE	1	435032204R1
R3170	C-CARBON R	RN72KIJ-391FE	1	435033912R1
R3171	C-CARBON R	RN72KIJ-222FE	1	435032222R1
R3172	C-CARBON R	RN72KIJ-392FE	1	435033922R1
R3173	C-CARBON R	RN72KIJ-390JE	1	435033904R1
R3174	C-CARBON R	RN72KIJ-390JE	1	435033904R1
R3176	C-CARBON R	MCR03EZPF49R9(49.9_1%)	1	4100037R2
R3177	C-CARBON R	MCR03EZPF49R9(49.9_1%)	1	4100037R2
R3178	C-CARBON R	MCR03EZPF49R9(49.9_1%)	1	4100037R2
R3179	C-CARBON R	MCR03EZPF49R9(49.9_1%)	1	4100037R2
R3180	C-CARBON R	RN72KIJ-100FE	1	435031002R1
R3181	C-CARBON R	RN72KIJ-470JE	1	435034704R1
R3182	C-CARBON R	RN72KIJ-472JE	1	435034724R1
R3183	C-CARBON R	RN72KIJ-470JE	1	435034704R1
R3184	C-CARBON R	RN72KIJ-470JE	1	435034704R1
R3185	C-CARBON R	RN72KIJ-392FE	1	435033922R1
R3186	C-CARBON R	RN72KIJ-472JE	1	435034724R1
R3187	C-CARBON R	RN72KIJ-223FE	1	435032232R1
R3188	C-CARBON R	RN72KIJ-224FE	1	435032242R1
R3189	C-CARBON R	RN72KIJ-103FE	1	435031032R1
R3190	C-CARBON R	RN72KIJ-393FE	1	435033932R1
R3191	C-CARBON R	RN72KIJ-105FE	1	435031052R1
R3192	C-CARBON R	RN72KIJ-472JE	1	435034724R1
R3193	C-CARBON R	RN72KIJ-472JE	1	435034724R1
R3194	C-CARBON R	RN72KIJ-472JE	1	435034724R1
R3195	C-CARBON R	RN72KIJ-221JE	1	435032214R1
R3196	C-CARBON R	RN72KIJ-221JE	1	435032214R1
R3199	C-CARBON R	RN72KIJ-102JE	1	435031024R1

R3200	C-CARBON R	RN72KIJ-103JE	1	435031034R1
R3201	C-CARBON R	RN72KIJ-103JE	1	435031034R1
R3202	C-CARBON R	RN72KIJ-103JE	1	435031034R1
R3203	C-CARBON R	RN72KIJ-103JE	1	435031034R1
R3204	C-CARBON R	RN72KIJ-103JE	1	435031034R1
R3205	C-CARBON R	RN72KIJ-103JE	1	435031034R1
R3208	C-CARBON R	RN72KIJ-220JE	1	435032204R1
R3212	C-CARBON R	RN72KIJ-220JE	1	435032204R1
R3215	C-CARBON R	RN72KIJ-221JE	1	435032214R1
R3218	C-CARBON R	RN72KIJ-220JE	1	435032204R1
R3219	C-CARBON R	RN72KIJ-221JE	1	435032214R1
R3221	C-CARBON R	RN72KIJ-470JE	1	435034704R1
R3224	C-CARBON R	RN72KIJ-220JE	1	435032204R1
R3225	C-CARBON R	RN72KIJ-220JE	1	435032204R1
R3226	C-R NET	RM7LJ470X04	1	43484747004R2
R3227	C-CARBON R	RN72KIJ-470JE	1	435034704R1
R3228	C-CARBON R	RN72KIJ-470JE	1	435034704R1
R3229	C-CARBON R	RN72KIJ-470JE	1	435034704R1
R3230	C-CARBON R	RN72KIJ-221JE	1	435032214R1
R3231	C-CARBON R	RN72KIJ-470JE	1	435034704R1
R3232	C-CARBON R	RN72KIJ-221JE	1	435032214R1
R3233	C-CARBON R	RN72KIJ-221JE	1	435032214R1
R3234	C-CARBON R	RN72KIJ-470JE	1	435034704R1
R3236	C-CARBON R	RN72KIJ-470JE	1	435034704R1
R3237	C-CARBON R	RN72KIJ-221JE	1	435032214R1
R3238	C-CARBON R	RN72KIJ-470JE	1	435034704R1
R3239	C-CARBON R	RN72KIJ-221JE	1	435032214R1
R3240	C-CARBON R	RN72KIJ-103JE	1	435031034R1
R3241	C-CARBON R	RN72KIJ-221JE	1	435032214R1
R3242	C-CARBON R	RN72KIJ-221JE	1	435032214R1
R3243	C-CARBON R	RN72KIJ-220JE	1	435032204R1
R3244	C-CARBON R	RN72KIJ-470JE	1	435034704R1
R3245	C-CARBON R	RN72KIJ-103JE	1	435031034R1
R3246	C-CARBON R	RN72KIJ-103JE	1	435031034R1
R3247	C-CARBON R	RN72KIJ-331JE	1	435033314R1
R3248	C-CARBON R	RN72KIJ-220JE	1	435032204R1
R3249	C-CARBON R	RN72KIJ-470JE	1	435034704R1
R3250	C-CARBON R	RN72KIJ-470JE	1	435034704R1
R3251	C-CARBON R	RN72KIJ-470JE	1	435034704R1

R3252	C-CARBON R	RN72KIJ-220JE	1	435032204R1
R3253	C-CARBON R	RN72KIJ-470JE	1	435034704R1
R3254	C-CARBON R	RN72KIJ-470JE	1	435034704R1
R3255	C-CARBON R	RN72KIJ-103JE	1	435031034R1
R3256	C-CARBON R	RN72KIJ-470JE	1	435034704R1
R3257	C-CARBON R	RN72KIJ-470JE	1	435034704R1
R3259	C-CARBON R	RN72KIJ-220JE	1	435032204R1
R3260	C-CARBON R	RN72KIJ-390JE	1	435033904R1
R3261	C-CARBON R	RN72KIJ-470JE	1	435034704R1
R3262	C-CARBON R	RN72KIJ-221JE	1	435032214R1
R3264	C-CARBON R	RN72KIJ-470JE	1	435034704R1
R3265	C-CARBON R	RN72KIJ-390JE	1	435033904R1
R3267	C-CARBON R	RN72KIJ-470JE	1	435034704R1
R3268	C-CARBON R	RN72KIJ-390JE	1	435033904R1
R3270	C-CARBON R	RN72KIJ-470JE	1	435034704R1
R3271	C-CARBON R	RN72KIJ-390JE	1	435033904R1
R3272	C-CARBON R	RN72KIJ-470JE	1	435034704R1
R3273	C-CARBON R	RN72KIJ-470JE	1	435034704R1
R3274	C-CARBON R	RN72KIJ-390JE	1	435033904R1
R3275	C-CARBON R	RN72KIJ-220JE	1	435032204R1
R3276	C-CARBON R	RN72KIJ-470JE	1	435034704R1
R3277	C-CARBON R	RN72KIJ-220JE	1	435032204R1
R3278	C-CARBON R	RN72KIJ-470JE	1	435034704R1
R3279	C-CARBON R	RN72KIJ-470JE	1	435034704R1
R3280	C-CARBON R	RN72KIJ-470JE	1	435034704R1
R3281	C-CARBON R	RN72KIJ-103JE	1	435031034R1
R3282	C-CARBON R	RN72KIJ-103JE	1	435031034R1
R3283	C-CARBON R	RN72KIJ-103JE	1	435031034R1
R3284	C-CARBON R	RN72KIJ-103JE	1	435031034R1
R3285	C-CARBON R	RN72KIJ-103JE	1	435031034R1
R3286	C-CARBON R	RN72KIJ-103JE	1	435031034R1
R3287	C-CARBON R	RN72KIJ-220JE	1	435032204R1
R3288	C-CARBON R	RN72KIJ-223JE	1	435032234R1
R3289	C-CARBON R	RN72KIJ-152JE	1	435031524R1
R3290	C-CARBON R	RN72KIJ-105JE	1	435031054R1
R3291	C-CARBON R	RN72KIJ-105JE	1	435031054R1
R3292	C-CARBON R	RN72KIJ-561FE	1	435035612R1
R3293	C-CARBON R	RN72KIJ-560JE	1	435035604R1
R3294	C-CARBON R	RN72KIJ-561FE	1	435035612R1

R3295	C-CARBON R	RN72KIJ-560JE	1	435035604R1
R3296	C-CARBON R	RN72KIJ-223JE	1	435032234R1
R3297	C-CARBON R	RN72KIJ-332JE	1	435033324R1
R3298	C-CARBON R	RN72KIJ-182JE	1	435031824R1
R3299	C-CARBON R	RN72KIJ-220JE	1	435032204R1
R3300	C-CARBON R	RN72KIJ-153JE	1	435031534R1
R3301	C-CARBON R	RN72KIJ-153JE	1	435031534R1
R3302	C-CARBON R	RN72KIJ-332JE	1	435033324R1
R3303	C-CARBON R	RN72KIJ-104JE	1	435031044R1
R3304	C-CARBON R	RN72KIJ-153JE	1	435031534R1
R3305	C-CARBON R	RN72KIJ-153JE	1	435031534R1
R3306	C-CARBON R	RN72KIJ-332JE	1	435033324R1
R3307	C-CARBON R	RN72KIJ-104JE	1	435031044R1
R3308	C-CARBON R	RN72KIJ-223JE	1	435032234R1
R3309	C-CARBON R	RN72KIJ-332JE	1	435033324R1
R3310	C-CARBON R	RN72KIJ-182JE	1	435031824R1
R3311	C-CARBON R	RN72KIJ-471JE	1	435034714R1
R3312	C-CARBON R	RN72KIJ-223JE	1	435032234R1
R3313	C-CARBON R	RN72KIJ-152JE	1	435031524R1
R3314	C-CARBON R	RN72KIJ-391JE	1	435033914R1
R3315	C-CARBON R	RN72KIJ-560JE	1	435035604R1
R3401	C-R NET	RM7LJ330X04	1	43484733004R2
R3402	C-R NET	RM7LJ330X04	1	43484733004R2
R3403	C-R NET	RM7LJ330X04	1	43484733004R2
R3404	C-R NET	RM7LJ330X04	1	43484733004R2
R3405	C-CARBON R	RN72KIJ-103JE	1	435031034R1
R3406	C-CARBON R	RN72KIJ-103JE	1	435031034R1
R3407	C-CARBON R	RN72KIJ-103JE	1	435031034R1
R3408	C-CARBON R	RN72KIJ-103JE	1	435031034R1
R3409	C-CARBON R	RN72KIJ-103JE	1	435031034R1
R3410	C-CARBON R	RN72KIJ-221JE	1	435032214R1
R3411	C-CARBON R	RN72KIJ-221JE	1	435032214R1
R3412	C-CARBON R	RN72KIJ-470JE	1	435034704R1
R3413	C-CARBON R	RN72KIJ-470JE	1	435034704R1
R3414	C-CARBON R	RN72KIJ-470JE	1	435034704R1
R3416	C-CARBON R	RN72KIJ-331JE	1	435033314R1
R3417	C-CARBON R	RN72KIJ-330JE	1	435033304R1
R3418	C-CARBON R	RN72KIJ-470JE	1	435034704R1
R3419	C-CARBON R	RN72KIJ-750JE	1	435037504R1

R3420	C-CARBON R	RN72KIJ-470JE	1	435034704R1
R3421	C-CARBON R	RN72KIJ-102JE	1	435031024R1
R3422	C-CARBON R	RN72KIJ-330JE	1	435033304R1
R3423	C-CARBON R	RN72KIJ-470JE	1	435034704R1
R3424	C-CARBON R	RN72KIJ-470JE	1	435034704R1
R3425	C-CARBON R	RN72KIJ-470JE	1	435034704R1
R3426	C-R NET	RM7LJ330X04	1	43484733004R2
R3427	C-CARBON R	RN72KIJ-470JE	1	435034704R1
R3428	C-CARBON R	RN72KIJ-470JE	1	435034704R1
R3429	C-R NET	RM7LJ330X04	1	43484733004R2
R3430	C-R NET	RM7LJ330X04	1	43484733004R2
R3431	C-CARBON R	RN72KIJ-103JE	1	435031034R1
R3432	C-CARBON R	RN72KIJ-103JE	1	435031034R1
R3433	C-CARBON R	RN72KIJ-103JE	1	435031034R1
R3435	C-R NET	RM7LJ330X04	1	43484733004R2
R3436	C-CARBON R	RN72KIJ-331JE	1	435033314R1
R3437	C-CARBON R	RN72KIJ-331JE	1	435033314R1
R3438	C-CARBON R	RN72KIJ-331JE	1	435033314R1
R3439	C-R NET	RM7LJ330X04	1	43484733004R2
R3440	C-CARBON R	RN72KIJ-331JE	1	435033314R1
R3441	C-CARBON R	RN72KIJ-331JE	1	435033314R1
R3442	C-CARBON R	RN72KIJ-331JE	1	435033314R1
R3443	C-CARBON R	RN72KIJ-331JE	1	435033314R1
R3444	C-CARBON R	RN72KIJ-331JE	1	435033314R1
R3445	C-R NET	RM7LJ330X04	1	43484733004R2
R3446	C-CARBON R	RN72KIJ-470JE	1	435034704R1
R3447	C-CARBON R	RN72KIJ-470JE	1	435034704R1
R3448	C-CARBON R	RN72KIJ-470JE	1	435034704R1
R3449	C-CARBON R	RN72KIJ-470JE	1	435034704R1
R3450	C-CARBON R	RN72KIJ-470JE	1	435034704R1
R3451	C-CARBON R	RN72KIJ-103JE	1	435031034R1
R3452	C-CARBON R	RN72KIJ-103JE	1	435031034R1
R3453	C-CARBON R	RN72KIJ-103JE	1	435031034R1
R3454	C-CARBON R	RN72KIJ-470JE	1	435034704R1
R3455	C-CARBON R	RN72KIJ-103JE	1	435031034R1
R3456	C-CARBON R	RN72KIJ-470JE	1	435034704R1
R3457	C-CARBON R	RN72KIJ-470JE	1	435034704R1
R3458	C-CARBON R	RN72KIJ-470JE	1	435034704R1
R3459	C-CARBON R	RN72KIJ-470JE	1	435034704R1

R3460	C-CARBON R	RN72KIJ-470JE	1	435034704R1
R3461	C-CARBON R	RN72KIJ-470JE	1	435034704R1
R3462	C-CARBON R	RN72KIJ-470JE	1	435034704R1
R3464	C-CARBON R	RN72KIJ-102JE	1	435031024R1
R3465	C-CARBON R	RN72KIJ-223FE	1	435032232R1
R3466	C-CARBON R	RN72KIJ-392FE	1	435033922R1
R3467	C-CARBON R	RN72KIJ-224FE	1	435032242R1
R3468	C-CARBON R	RN72KIJ-103FE	1	435031032R1
R3469	C-CARBON R	RN72KIJ-333FE	1	435033332R1
R3470	C-CARBON R	RN72KIJ-391JE	1	435033914R1
R3471	C-CARBON R	RN72KIJ-391JE	1	435033914R1
R3472	C-CARBON R	RN72KIJ-105JE	1	435031054R1
R3473	C-CARBON R	RN72KIJ-000JE	1	435030004R1
R3570	C-CARBON R	RN72KIJ-000JE	1	435030004R1
R3622	C-CARBON R	RN72KIJ-000JE	1	435030004R1
R3623	C-CARBON R	RN72KIJ-000JE	1	435030004R1
R3624	C-CARBON R	RN72KIJ-000JE	1	435030004R1
R3625	C-CARBON R	RN72KIJ-000JE	1	435030004R1
R3626	C-CARBON R	RN72KIJ-000JE	1	435030004R1
R3627	C-CARBON R	RN72KIJ-000JE	1	435030004R1
R3670	C-CARBON R	RN72KIJ-103JE	1	435031034R1
R3671	C-CARBON R	RN72KIJ-000JE	1	435030004R1
R3672	C-CARBON R	RN72KIJ-000JE	1	435030004R1
R3673	C-CARBON R	RN72KIJ-000JE	1	435030004R1
R3674	C-CARBON R	RN72KIJ-000JE	1	435030004R1
R8000	C-CARBON R	RN72KIJ-103JE	1	435031034R1
R8001	C-CARBON R	RN72KIJ-103JE	1	435031034R1
R8002	C-CARBON R	RN72KIJ-271JE	1	435032714R1
R8003	C-CARBON R	RN72KIJ-271JE	1	435032714R1
R8010	C-CARBON R	RN72KIJ-103JE	1	435031034R1
R8011	C-CARBON R	RN72KIJ-103JE	1	435031034R1
R8012	C-CARBON R	RN72KIJ-000JE	1	435030004R1
R8013	C-CARBON R	RN72KIJ-103JE	1	435031034R1
R8014	C-CARBON R	RN72KIJ-103JE	1	435031034R1
R8015	C-CARBON R	RN72KIJ-103JE	1	435031034R1
R8016	C-CARBON R	RN72KIJ-103JE	1	435031034R1
R8017	C-CARBON R	RN72KIJ-103JE	1	435031034R1
R8018	C-CARBON R	RN72KIJ-103JE	1	435031034R1
R8019	C-CARBON R	RN72KIJ-103JE	1	435031034R1

R8020	C-CARBON R	RN72KIJ-103JE	1	435031034R1
R8021	C-CARBON R	RN72KIJ-103JE	1	435031034R1
R8022	C-CARBON R	RN72KIJ-103JE	1	435031034R1
R8026	C-CARBON R	RN72KIJ-103JE	1	435031034R1
R8028	C-CARBON R	RN72KIJ-103JE	1	435031034R1
R8029	C-CARBON R	RN72KIJ-103JE	1	435031034R1
R8033	C-CARBON R	RN72KIJ-103JE	1	435031034R1
R8034	C-CARBON R	RN72KIJ-000JE	1	435030004R1
R8035	C-CARBON R	RN72KIJ-000JE	1	435030004R1
R8036	C-CARBON R	RN72KIJ-103JE	1	435031034R1
R8038	C-CARBON R	RN72KIJ-330JE	1	435033304R1
R8045	C-CARBON R	RN72KIJ-750JE	1	435037504R1
R8046	C-CARBON R	RN72KIJ-750JE	1	435037504R1
R8047	C-CARBON R	RN72KIJ-750JE	1	435037504R1
R8048	C-CARBON R	RN72KIJ-750JE	1	435037504R1
R8049	C-CARBON R	RN72KIJ-750JE	1	435037504R1
R8050	C-CARBON R	RN72KIJ-750JE	1	435037504R1
R8051	C-CARBON R	RN72KIJ-680JE	1	435036804R1
R8052	C-CARBON R	RN72KIJ-471JE	1	435034714R1
R8053	C-CARBON R	RN72KIJ-680JE	1	435036804R1
R8054	C-CARBON R	RN72KIJ-471JE	1	435034714R1
R8055	C-CARBON R	RN72KIJ-680JE	1	435036804R1
R8056	C-CARBON R	RN72KIJ-471JE	1	435034714R1
R8057	C-CARBON R	RN72KIJ-680JE	1	435036804R1
R8058	C-CARBON R	RN72KIJ-471JE	1	435034714R1
R8059	C-CARBON R	RN72KIJ-680JE	1	435036804R1
R8060	C-CARBON R	RN72KIJ-680JE	1	435036804R1
R8061	C-CARBON R	RN72KIJ-680JE	1	435036804R1
R8062	C-CARBON R	RN72KIJ-220JE	1	435032204R1
R8063	C-CARBON R	RN72KIJ-220JE	1	435032204R1
R8064	C-CARBON R	RN72KIJ-220JE	1	435032204R1
R8065	C-CARBON R	RN72KIJ-103JE	1	435031034R1
R8066	C-CARBON R	RN72KIJ-103JE	1	435031034R1
R8067	C-CARBON R	RN72KIJ-103JE	1	435031034R1
R8068	C-CARBON R	RN72KIJ-750JE	1	435037504R1
R8069	C-CARBON R	RN72KIJ-750JE	1	435037504R1
R8070	C-CARBON R	RN72KIJ-750JE	1	435037504R1
R8071	C-CARBON R	RN72KIJ-750JE	1	435037504R1
R8072	C-CARBON R	RN72KIJ-750JE	1	435037504R1

R8073	C-CARBON R	RN72KIJ-750JE	1	435037504R1	
R8074	C-CARBON R	RN72KIJ-103JE	1	435031034R1	
R8075	C-CARBON R	RN72KIJ-103JE	1	435031034R1	
R8076	C-CARBON R	RN72KIJ-103JE	1	435031034R1	
R8079	C-CARBON R	RN72KIJ-220JE	1	435032204R1	
R8080	C-CARBON R	RN72KIJ-220JE	1	435032204R1	
R8081	C-CARBON R	RN72KIJ-220JE	1	435032204R1	
R8082	C-CARBON R	RN72KIJ-680JE	1	435036804R1	
R8083	C-CARBON R	RN72KIJ-471JE	1	435034714R1	
R8084	C-CARBON R	RN72KIJ-471JE	1	435034714R1	
R8085	C-CARBON R	RN72KIJ-471JE	1	435034714R1	
R8086	C-CARBON R	RN72KIJ-471JE	1	435034714R1	
R8087	C-CARBON R	RN72KIJ-220JE	1	435032204R1	
R8088	C-CARBON R	RN72KIJ-220JE	1	435032204R1	
R8089	C-CARBON R	RN72KIJ-102JE	1	435031024R1	
R8090	C-CARBON R	RN72KIJ-102JE	1	435031024R1	
R8154	C-CARBON R	RN72KIJ-000JE	1	435030004R1	
R8160	C-CARBON R	RN72KIJ-332JE	1	435033324R1	
R8161	C-CARBON R	RN72KIJ-681JE	1	435036814R1	
R8162	C-CARBON R	RN72KIJ-101JE	1	435031014R1	
R8165	C-CARBON R	RN72KIJ-103JE	1	435031034R1	
R8201	C-CARBON R	RN72KIJ-330JE	1	435033304R1	
R8202	C-CARBON R	RN72KIJ-000JE	1	435030004R1	
R8203	C-CARBON R	RN72KIJ-000JE	1	435030004R1	
R8205	C-CARBON R	RN72KIJ-220JE	1	435032204R1	
R8206	C-CARBON R	RN72KIJ-103JE	1	435031034R1	
R8207	C-CARBON R	RN72KIJ-103JE	1	435031034R1	
R8208	C-CARBON R	RN72KIJ-103JE	1	435031034R1	
R8209	C-CARBON R	RN72KIJ-103JE	1	435031034R1	
R8210	C-CARBON R	RN72KIJ-103JE	1	435031034R1	
R8212	C-CARBON R	RN72KIJ-103JE	1	435031034R1	
R8213	C-CARBON R	RN72KIJ-103JE	1	435031034R1	
R8214	C-CARBON R	RN72KIJ-272JE	1	435032724R1	
R8215	C-CARBON R	RN72KIJ-272JE	1	435032724R1	
R8219	C-CARBON R	RN72KIJ-103JE	1	435031034R1	
R8223	C-CARBON R	RN72KIJ-103JE	1	435031034R1	
R8224	C-CARBON R	RN72KIJ-103JE	1	435031034R1	
R8230	C-R NET	RM7LJ330X04	1	43484733004R2	
R8231	C-R NET	RM7LJ330X04	1	43484733004R2	

R8232	C-R NET	RM7LJ330X04	1	43484733004R2
R8233	C-R NET	RM7LJ330X04	1	43484733004R2
R8234	C-R NET	RM7LJ330X04	1	43484733004R2
R8235	C-R NET	RM7LJ330X04	1	43484733004R2
R8236	C-R NET	RM7LJ330X04	1	43484733004R2
R8238	C-R NET	RM7LJ330X04	1	43484733004R2
R8239	C-R NET	RM7LJ330X04	1	43484733004R2
R8240	C-R NET	RM7LJ330X04	1	43484733004R2
R8241	C-R NET	RM7LJ330X04	1	43484733004R2
R8243	C-R NET	RM7LJ330X04	1	43484733004R2
R8245	C-R NET	RM7LJ330X04	1	43484733004R2
R8248	C-R NET	RM7LJ330X04	1	43484733004R2
R8249	C-R NET	RM7LJ330X04	1	43484733004R2
R8251	C-R NET	RM7LJ220X04	1	43484722004R2
R8252	C-R NET	RM7LJ220X04	1	43484722004R2
R8253	C-R NET	RM7LJ220X04	1	43484722004R2
R8254	C-R NET	RM7LJ220X04	1	43484722004R2
R8255	C-R NET	RM7LJ220X04	1	43484722004R2
R8256	C-R NET	RM7LJ220X04	1	43484722004R2
R8257	C-R NET	RM7LJ220X04	1	43484722004R2
R8258	C-R NET	RM7LJ220X04	1	43484722004R2
R8259	C-R NET	RM7LJ220X04	1	43484722004R2
R8264	C-CARBON R	RN72KIJ-103JE	1	435031034R1
R8271	C-R NET	RM7LJ220X04	1	43484722004R2
R8272	C-R NET	RM7LJ220X04	1	43484722004R2
R8273	C-R NET	RM7LJ220X04	1	43484722004R2
R8274	C-R NET	RM7LJ220X04	1	43484722004R2
R8275	C-R NET	RM7LJ220X04	1	43484722004R2
R8276	C-R NET	RM7LJ220X04	1	43484722004R2
R8277	C-R NET	RM7LJ220X04	1	43484722004R2
R8278	C-R NET	RM7LJ220X04	1	43484722004R2
R8279	C-R NET	RM7LJ220X04	1	43484722004R2
R8280	C-CARBON R	RN72KIJ-120JE	1	435031204R1
R8284	C-CARBON R	RN72KIJ-330JE	1	435033304R1
R8323	C-CARBON R	RN72KIJ-103JE	1	435031034R1
R8329	C-CARBON R	RN72KIJ-473JE	1	435034734R1
R8330	C-CARBON R	RN72KIJ-473JE	1	435034734R1
R8333	C-CARBON R	RN72KIJ-103JE	1	435031034R1
R8334	C-CARBON R	RN72KIJ-222JE	1	435032224R1

R8335	C-CARBON R	RN72K1J-222JE	1	435032224R1
R8336	C-CARBON R	RN72K1J-472JE	1	435034724R1
R8337	C-CARBON R	RN72K1J-473JE	1	435034734R1
R8338	C-CARBON R	RN72K1J-473JE	1	435034734R1
R8339	C-CARBON R	RN72K2E-470JE	1	435224704R1
R8343	C-CARBON R	RN72K1J-103JE	1	435031034R1
R8349	C-CARBON R	RN72K1J-473JE	1	435034734R1
R8350	C-CARBON R	RN72K1J-473JE	1	435034734R1
R8360	C-CARBON R	RN72K1J-103JE	1	435031034R1
R8361	C-CARBON R	RN72K1J-681JE	1	435036814R1
R8362	C-CARBON R	RN72K1J-101JE	1	435031014R1
R8365	C-CARBON R	RN72K1J-103JE	1	435031034R1
R8401	C-R NET	RM71J220X04	1	43484722004R2
R8402	C-CARBON R	RN72K1J-220JE	1	435032204R1
R8403	C-R NET	RM71J220X04	1	43484722004R2
R8404	C-CARBON R	RN72K1J-220JE	1	435032204R1
R8405	C-CARBON R	RN72K1J-220JE	1	435032204R1
R8408	C-CARBON R	RN72K1J-220JE	1	435032204R1
R8409	C-CARBON R	RN72K1J-101JE	1	435031014R1
R8410	C-CARBON R	RN72K1J-681JE	1	435036814R1
R8411	C-CARBON R	RN72K1J-472JE	1	435034724R1
R8416	C-R NET	RM71J220X04	1	43484722004R2
R8417	C-R NET	RM71J220X04	1	43484722004R2
R8418	C-R NET	RM71J220X04	1	43484722004R2
R8419	C-R NET	RM71J220X04	1	43484722004R2
R8420	C-R NET	RM71J220X04	1	43484722004R2
R8421	C-R NET	RM71J220X04	1	43484722004R2
R8422	C-R NET	RM71J220X04	1	43484722004R2
R8423	C-R NET	RM71J220X04	1	43484722004R2
R8424	C-R NET	RM71J220X04	1	43484722004R2
R8425	C-CARBON R	RN72K1J-220JE	1	435032204R1
R8429	C-CARBON R	RN72K1J-220JE	1	435032204R1
R8431	C-CARBON R	RN72K1J-472JE	1	435034724R1
R8432	C-CARBON R	RN72K1J-220JE	1	435032204R1
R8442	C-CARBON R	RN72K1J-102JE	1	435031024R1
R8501	C-CARBON R	RN72K1J-000JE	1	435030004R1
R8502	C-CARBON R	RN72K1J-120JE	1	435031204R1
R8503	C-R NET	RM71J000X04	1	43484700004R2
R8504	C-R NET	RM71J330X04	1	43484733004R2

R8505	C-R NET	RM7LJ000X04	1	4348470004R2
R8507	C-R NET	RM7LJ000X04	1	4348470004R2
R8508	C-R NET	RM7LJ000X04	1	4348470004R2
R8509	C-R NET	RM7LJ000X04	1	4348470004R2
R8510	C-R NET	RM7LJ000X04	1	4348470004R2
R8511	C-R NET	RM7LJ000X04	1	4348470004R2
R8512	C-R NET	RM7LJ000X04	1	4348470004R2
R8513	C-R NET	RM7LJ000X04	1	4348470004R2
R8516	C-CARBON R	RN72KIJ-101JE	1	435031014R1
R8517	C-CARBON R	RN72KIJ-101JE	1	435031014R1
R8518	C-CARBON R	RN72KIJ-472JE	1	435034724R1
R8519	C-CARBON R	RN72KIJ-151JE	1	435031514R1
R8522	C-R NET	RM7LJ330X04	1	4348473304R2
R8523	C-CARBON R	RN72KIJ-330JE	1	435033304R1
R8524	C-CARBON R	RN72KIJ-330JE	1	435033304R1
R8525	C-CARBON R	RN72KIJ-472JE	1	435034724R1
R8526	C-CARBON R	RN72KIJ-472JE	1	435034724R1
R8527	C-CARBON R	RN72KIJ-562JE	1	435035624R1
R8528	C-CARBON R	RN72KIJ-562JE	1	435035624R1
R8529	C-CARBON R	RN72KIJ-103JE	1	435031034R1
R8530	C-CARBON R	RN72KIJ-105JE	1	435031054R1
R8531	C-CARBON R	RN72KIJ-000JE	1	435030004R1
R8533	C-CARBON R	RN72KIJ-562JE	1	435035624R1
R8534	C-CARBON R	RN72KIJ-562JE	1	435035624R1
R8535	C-CARBON R	RN72KIJ-000JE	1	435030004R1
R8536	C-CARBON R	RN72KIJ-000JE	1	435030004R1
R8601	C-CARBON R	RN72KIJ-000JE	1	435030004R1
R8602	C-CARBON R	RN72KIJ-000JE	1	435030004R1
R8607	C-CARBON R	RN72KIJ-473JE	1	435034734R1
R8608	C-CARBON R	RN72KIJ-473JE	1	435034734R1
R8609	C-CARBON R	RN72KIJ-000JE	1	435030004R1
R8617	C-CARBON R	RN72KIJ-473JE	1	435034734R1
R8618	C-CARBON R	RN72KIJ-473JE	1	435034734R1
R8619	C-CARBON R	RN72KIJ-103JE	1	435031034R1
R8627	C-CARBON R	RN72KIJ-473JE	1	435034734R1
R8628	C-CARBON R	RN72KIJ-473JE	1	435034734R1
R8629	C-CARBON R	RN72KIJ-103JE	1	435031034R1
R8637	C-CARBON R	RN72KIJ-473JE	1	435034734R1
R8638	C-CARBON R	RN72KIJ-473JE	1	435034734R1

R8639	C-CARBON R	RN72KIJ-103JE	1	435031034R1
R8654	C-CARBON R	RN72KIJ-223JE	1	435032234R1
R8655	C-CARBON R	RN72KIJ-224JE	1	435032244R1
R8656	C-CARBON R	RN72KIJ-333JE	1	435033334R1
R8701	C-CARBON R	RN72KIJ-103JE	1	435031034R1
R8702	C-CARBON R	RN72KIJ-103JE	1	435031034R1
R8703	C-CARBON R	RN72KIJ-103JE	1	435031034R1
R8705	C-CARBON R	RN72KIJ-220JE	1	435032204R1
R8706	C-CARBON R	RN72KIJ-220JE	1	435032204R1
R8707	C-CARBON R	RN72KIJ-220JE	1	435032204R1
R8708	C-CARBON R	RN72KIJ-103JE	1	435031034R1
R8709	C-CARBON R	RN72KIJ-103JE	1	435031034R1
R8710	C-CARBON R	RN72KIJ-103JE	1	435031034R1
R8711	C-CARBON R	RN72KIJ-222JE	1	435032224R1
R8712	C-R NET	RM7LJ222X04	1	43484722204R2
R8713	C-R NET	RM7LJ222X04	1	43484722204R2
R8714	C-R NET	RM7LJ222X04	1	43484722204R2
R8715	C-R NET	RM7LJ103X04	1	43484710304R2
R8716	C-CARBON R	RN72KIJ-103JE	1	435031034R1
R8717	C-CARBON R	RN72KIJ-103JE	1	435031034R1
R8718	C-CARBON R	RN72KIJ-220JE	1	435032204R1
R8719	C-CARBON R	RN72KIJ-103JE	1	435031034R1
R8720	C-CARBON R	RN72KIJ-220JE	1	435032204R1
R8721	C-CARBON R	RN72KIJ-220JE	1	435032204R1
R8722	C-CARBON R	RN72KIJ-103JE	1	435031034R1
R8723	C-CARBON R	RN72KIJ-103JE	1	435031034R1
R8733	C-CARBON R	RN72KIJ-103JE	1	435031034R1
R8742	C-CARBON R	RN72KIJ-103JE	1	435031034R1
R8744	C-CARBON R	RN72KIJ-103JE	1	435031034R1
R8746	C-CARBON R	RN72KIJ-103JE	1	435031034R1
R8747	C-CARBON R	RN72KIJ-103JE	1	435031034R1
R8749	C-CARBON R	RN72KIJ-220JE	1	435032204R1
R8750	C-CARBON R	RN72KIJ-000JE	1	435030004R1
R8751	C-CARBON R	RN72KIJ-000JE	1	435030004R1
R8752	C-CARBON R	RN72KIJ-000JE	1	435030004R1
R8801	C-R NET	RM7LJ220X04	1	43484722004R2
R8802	C-R NET	RM7LJ220X04	1	43484722004R2
R8803	C-R NET	RM7LJ220X04	1	43484722004R2
R8804	C-R NET	RM7LJ220X04	1	43484722004R2

R8805	C-R NET	RM7LJ220X04	1	43484722004R2
R8806	C-CARBON R	RN72KIJ-103JE	1	435031034R1
R8810	C-R NET	RM7LJ220X04	1	43484722004R2
R8811	C-R NET	RM7LJ220X04	1	43484722004R2
R8812	C-R NET	RM7LJ220X04	1	43484722004R2
R8813	C-CARBON R	RN72KIJ-220JE	1	435032204R1
R8814	C-CARBON R	RN72KIJ-181JE	1	435031814R1
R8815	C-CARBON R	RN72KIJ-332JE	1	435033324R1
R8816	C-CARBON R	RN72KIJ-181JE	1	435031814R1
R8817	C-CARBON R	RN72KIJ-332JE	1	435033324R1
R8818	C-CARBON R	RN72KIJ-332JE	1	435033324R1
R8819	C-CARBON R	RN72KIJ-821JE	1	435038214R1
R8820	C-CARBON R	RN72KIJ-332JE	1	435033324R1
R8821	C-CARBON R	RN72KIJ-821JE	1	435038214R1
R8822	C-CARBON R	RN72KIJ-473JE	1	435034734R1
R8823	C-CARBON R	RN72KIJ-000JE	1	435030004R1
R8824	C-CARBON R	RN72KIJ-000JE	1	435030004R1
R8901	C-CARBON R	RN72KIJ-122JE	1	435031224R1
R8902	C-CARBON R	RN72KIJ-122JE	1	435031224R1
R8903	C-CARBON R	RN72KIJ-122JE	1	435031224R1
R8904	C-CARBON R	RN72KIJ-122JE	1	435031224R1
R8905	C-CARBON R	RN72KIJ-122JE	1	435031224R1
R8906	C-CARBON R	RN72KIJ-122JE	1	435031224R1
R8907	C-CARBON R	RN72KIJ-122JE	1	435031224R1
R8908	C-CARBON R	RN72KIJ-122JE	1	435031224R1
R8909	C-CARBON R	RN72KIJ-122JE	1	435031224R1
R8910	C-CARBON R	RN72KIJ-122JE	1	435031224R1
R8911	C-CARBON R	RN72KIJ-122JE	1	435031224R1
R8912	C-CARBON R	RN72KIJ-122JE	1	435031224R1
R8913	C-CARBON R	RN72KIJ-122JE	1	435031224R1
R8914	C-CARBON R	RN72KIJ-122JE	1	435031224R1
R8915	C-CARBON R	RN72KIJ-122JE	1	435031224R1
R8916	C-CARBON R	RN72KIJ-122JE	1	435031224R1
R8917	C-CARBON R	RN72KIJ-122JE	1	435031224R1
R8918	C-CARBON R	RN72KIJ-122JE	1	435031224R1
R8919	C-CARBON R	RN72KIJ-122JE	1	435031224R1
R8920	C-CARBON R	RN72KIJ-122JE	1	435031224R1
R8921	C-CARBON R	RN72KIJ-122JE	1	435031224R1
R8922	C-CARBON R	RN72KIJ-122JE	1	435031224R1

R8923	C-CARBON R	RN72K1J-122JE	1	435031224R1	
R8924	C-CARBON R	RN72K1J-122JE	1	435031224R1	
R8937	C-CARBON R	RN72K1J-103JE	1	435031034R1	
R8951	C-CARBON R	RN72K1J-103JE	1	435031034R1	
R8952	C-CARBON R	RN72K1J-683JE	1	435036834R1	
R8953	C-CARBON R	RN72K1J-183FE	1	435031832R1	
R8954	C-CARBON R	RN72K1J-224FE	1	435032242R1	
R8955	C-CARBON R	RN72K1J-103FE	1	435031032R1	
R8957	C-CARBON R	RN72K1J-333JE	1	435033334R1	
R8958	C-CARBON R	RN72K1J-333FE	1	435033332R1	
R8959	C-CARBON R	RN72K1J-562FE	1	435035622R1	
R8960	C-CARBON R	RN72K1J-103FE	1	435031032R1	
R8962	C-CARBON R	RN72K1J-333JE	1	435033334R1	
R8963	C-CARBON R	RN72K1J-153FE	1	435031532R1	
R8964	C-CARBON R	RN72K1J-333FE	1	435033332R1	
R8965	C-CARBON R	RN72K1J-103FE	1	435031032R1	
R8967	C-CARBON R	RN72K1J-683JE	1	435036834R1	
R8968	C-CARBON R	RN72K1J-333FE	1	435033332R1	
R8969	C-CARBON R	RN72K1J-394FE	1	435033942R1	
R8970	C-CARBON R	RN72K1J-103FE	1	435031032R1	
R8971	C-CARBON R	RN72K1J-473JE	1	435034734R1	
R8972	C-CARBON R	RN72K1J-103JE	1	435031034R1	
R8973	C-CARBON R	RN72K1J-103JE	1	435031034R1	
R8974	C-CARBON R	RN72K1J-103JE	1	435031034R1	
R8976	C-CARBON R	RN72K1J-103JE	1	435031034R1	
R8977	C-CARBON R	RN72K1J-562JE	1	435035624R1	
R8978	C-CARBON R	RN72K1J-682JE	1	435036824R1	
R8979	C-CARBON R	RN72K1J-562JE	1	435035624R1	
[SW TRM]					
JL3201	WIRE TRAP	NPLG-5P588	1	25055626	
JL8002B	SOCKET	NSCT-5P97	1	25050269	
P005	PWB	BCHDM-0132	1	25140132C	N
P3001	SOCKET(B to B)	IMSA-9850S-20Y900	1	25052813R2	
P3102A	SOCKET	NSCT-9P2472	1	25052575R2	
P3104	SOCKET	SI-60073-F	1	25053307	
P3104 or	SOCKET	J0026D21NL	(1)	25053250	
P3605A	PLUG	IMSA-9142B-18A	1	25056599	
P3607A	PLUG	IMSA-9142B-16A	1	25056598	
P3608A	PLUG	IMSA-9142B-18A	1	25056599	

P3609	SOCKET	04FMMN-SMT-A-TF	1	25052821R2	
P4104A	SOCKET	NSCT-31P2124	1	25052227	
P8005A	TRM-423(SCREW)	NETTANSI ST3	1	25060495	
P8006	HOLDER	(φ7.7') UA-0	1	27190432	
P8302	SOCKET	YKPF45-7037V	1	25053253R3	
P8321	SOCKET	YKPF45-7037V	1	25053253R3	
P8341	SOCKET	YKPF45-7037V	1	25053253R3	
P8601	SOCKET	YKPF45-7037V	1	25053253R3	
P8611	SOCKET	YKPF45-7037V	1	25053253R3	
P8621	SOCKET	YKPF45-7037V	1	25053253R3	
P8631	SOCKET	YKPF45-7037V	1	25053253R3	
P8702	SOCKET	NSCT-9P2472	1	25052575R2	
P8704	SOCKET	04FMMN-SMT-A-TF	1	25052821R2	

PRINTED CIRCUIT BOARD PARTS LIST

U002	Speaker terminal-1 PC board a's BATTRM-0083-1G				N B DC, DF, JU
U002	Speaker terminal-1 PC board a's BATTRM-0083-1H				B MA, MB, MO, MP, MQ, MR, S
U0021	Primary power supply PC board BAPS-0084-1G				N NSP, B DC, DF
U0021	Primary power supply PC board BAPS-0084-1H				N NSP, B MA, MB, MO, MP, MQ, MR, S
U0022	Speaker terminal-2 PC board a's BATTRM-0085-1G				N NSP, B DC, DF
U0022	Speaker terminal-2 PC board a's BATTRM-0085-1H				N NSP, B MA, MB, MO, MP, MQ, MR, S
U0023	Center speaker PC board a'ssy BATTRM-0086-1G				NSP, B DC, DF
U0023	Center speaker PC board a'ssy BATTRM-0086-1H				N NSP, B MA, MB, MO, MP, MQ, MR, S
U0024	Power amp. Input circuit PC board BACLA-0087-1G				NSP, B DC, DF
U0024	Power amp. Input circuit PC board BACLA-0087-1H				N NSP, B MA, MB, MO, MP, MQ, MR, S

CIRCUIT. NO.	PART NAME	DESCRIPTION	QTY	PART NO. (SN)	REMARKS
[SEMI CONDUCTOR]					
D5000	ZENER D	MTZJ5.6B	1	224470562T	< DC, DF, J, MA, MB, MO, MP, MQ, MR, >
D5001	ZENER D	MTZJ5.6B	1	224470562T	< DC, DF, J, MA, MB, MO, MP, MQ, MR, >
D5002	ZENER D	MTZJ5.6B	1	224470562T	< DC, DF, J, MA, MB, MO, MP, MQ, MR, >
D5003	ZENER D	MTZJ5.6B	1	224470562T	< DC, DF, J, MA, MB, MO, MP, MQ, MR, >
D5004	ZENER D	MTZJ5.6B	1	224470562T	< DC, DF, J, MA, MB, MO, MP, MQ, MR, >
D5005	ZENER D	MTZJ5.6B	1	224470562T	< DC, DF, J, MA, MB, MO, MP, MQ, MR, >
D5006	ZENER D	MTZJ5.6B	1	224470562T	< DC, DF, J, MA, MB, MO, MP, MQ, MR, >
D6600	DIODE	ISS133	1	223163T	< DC, DF, J, MA, MB, MO, MP, MQ, MR, >
D6603	DIODE	ISS133	1	223163T	< DC, DF, J, MA, MB, MO, MP, MQ, MR, >
D6605	DIODE	ISS133	1	223163T	< DC, DF, J, MA, MB, MO, MP, MQ, MR, >
D6607	DIODE	ISS133	1	223163T	< DC, DF, J, MA, MB, MO, MP, MQ, MR, >

D6609	DIODE	ISS133	1	223163T	< DC, DF, J, MA, MB, MO, MP, MQ, MR, >
D6610	DIODE	ISS133	1	223163T	< DC, DF, J, MA, MB, MO, MP, MQ, MR, >
D911	DIODE	ISS133	1	223163T	< B, >
D912	DIODE	ISS133	1	223163T	< B, >
D921	DIODE	ISS133	1	223163T	< B, >
D922	DIODE	ISS133	1	223163T	< B, >
D923	DIODE	ISS133	1	223163T	< B, >
D924	DIODE	ISS133	1	223163T	< B, >
D925	DIODE	ISS133	1	223163T	< B, >
D930	DIODE	ISS133	1	223163T	< B, >
D931	DIODE	ISS133	1	223163T	< B, >
D933	DIODE	ISS133	1	223163T	< B, >
D934	ZENER D	MTZJ3.6B	1	224470362T	< B, >
D935	DIODE	ISS133	1	223163T	< B, >
Q5000	TR	2SC2240-BL(TPE2_F)	1	2211406T	< DC, DF, J, MA, MB, MO, MP, MQ, MR, >
Q5001	TR	2SC2240-BL(TPE2_F)	1	2211406T	< DC, DF, J, MA, MB, MO, MP, MQ, MR, >
Q5002	TR	2SC2240-BL(TPE2_F)	1	2211406T	< DC, DF, J, MA, MB, MO, MP, MQ, MR, >
Q5003	TR	2SC2240-BL(TPE2_F)	1	2211406T	< DC, DF, J, MA, MB, MO, MP, MQ, MR, >
Q5004	TR	2SC2240-BL(TPE2_F)	1	2211406T	< DC, DF, J, MA, MB, MO, MP, MQ, MR, >
Q5005	TR	2SC2240-BL(TPE2_F)	1	2211406T	< DC, DF, J, MA, MB, MO, MP, MQ, MR, >
Q5006	TR	2SC2240-BL(TPE2_F)	1	2211406T	< DC, DF, J, MA, MB, MO, MP, MQ, MR, >
Q5010	TR	2SC2240-BL(TPE2_F)	1	2211406T	< DC, DF, J, MA, MB, MO, MP, MQ, MR, >
Q5011	TR	2SC2240-BL(TPE2_F)	1	2211406T	< DC, DF, J, MA, MB, MO, MP, MQ, MR, >
Q5012	TR	2SC2240-BL(TPE2_F)	1	2211406T	< DC, DF, J, MA, MB, MO, MP, MQ, MR, >
Q5013	TR	2SC2240-BL(TPE2_F)	1	2211406T	< DC, DF, J, MA, MB, MO, MP, MQ, MR, >
Q5014	TR	2SC2240-BL(TPE2_F)	1	2211406T	< DC, DF, J, MA, MB, MO, MP, MQ, MR, >
Q5015	TR	2SC2240-BL(TPE2_F)	1	2211406T	< DC, DF, J, MA, MB, MO, MP, MQ, MR, >
Q5016	TR	2SC2240-BL(TPE2_F)	1	2211406T	< DC, DF, J, MA, MB, MO, MP, MQ, MR, >
Q5030	TR	2SA949-Y(TPE6_F)	1	2211354T	< DC, DF, J, MA, MB, MO, MP, MQ, MR, >
Q5031	TR	2SA949-Y(TPE6_F)	1	2211354T	< DC, DF, J, MA, MB, MO, MP, MQ, MR, >
Q5032	TR	2SA949-Y(TPE6_F)	1	2211354T	< DC, DF, J, MA, MB, MO, MP, MQ, MR, >
Q5033	TR	2SA949-Y(TPE6_F)	1	2211354T	< DC, DF, J, MA, MB, MO, MP, MQ, MR, >
Q5034	TR	2SA949-Y(TPE6_F)	1	2211354T	< DC, DF, J, MA, MB, MO, MP, MQ, MR, >
Q5035	TR	2SA949-Y(TPE6_F)	1	2211354T	< DC, DF, J, MA, MB, MO, MP, MQ, MR, >
Q5036	TR	2SA949-Y(TPE6_F)	1	2211354T	< DC, DF, J, MA, MB, MO, MP, MQ, MR, >
Q5040	TR	2SA949-Y(TPE6_F)	1	2211354T	< DC, DF, J, MA, MB, MO, MP, MQ, MR, >
Q5041	TR	2SA949-Y(TPE6_F)	1	2211354T	< DC, DF, J, MA, MB, MO, MP, MQ, MR, >
Q5042	TR	2SA949-Y(TPE6_F)	1	2211354T	< DC, DF, J, MA, MB, MO, MP, MQ, MR, >
Q5043	TR	2SA949-Y(TPE6_F)	1	2211354T	< DC, DF, J, MA, MB, MO, MP, MQ, MR, >

Q5044	TR	2SA949-Y(TTPE6_F)	1	2211354T	< DC, DF, J, MA, MB, MO, MP, MQ, MR, >
Q5045	TR	2SA949-Y(TTPE6_F)	1	2211354T	< DC, DF, J, MA, MB, MO, MP, MQ, MR, >
Q5046	TR	2SA949-Y(TTPE6_F)	1	2211354T	< DC, DF, J, MA, MB, MO, MP, MQ, MR, >
Q5050	TR	2SC2240-BL(TTPE2_F)	1	2211406T	< DC, DF, J, MA, MB, MO, MP, MQ, MR, >
Q5050 or	TR	2SC2240-GR	(1)	2211405T	< DC, DF, J, MA, MB, MO, MP, MQ, MR, >
Q5051	TR	2SC2240-BL(TTPE2_F)	1	2211406T	< DC, DF, J, MA, MB, MO, MP, MQ, MR, >
Q5051 or	TR	2SC2240-GR	(1)	2211405T	< DC, DF, J, MA, MB, MO, MP, MQ, MR, >
Q5052	TR	2SC2240-BL(TTPE2_F)	1	2211406T	< DC, DF, J, MA, MB, MO, MP, MQ, MR, >
Q5052 or	TR	2SC2240-GR	(1)	2211405T	< DC, DF, J, MA, MB, MO, MP, MQ, MR, >
Q5053	TR	2SC2240-BL(TTPE2_F)	1	2211406T	< DC, DF, J, MA, MB, MO, MP, MQ, MR, >
Q5053 or	TR	2SC2240-GR	(1)	2211405T	< DC, DF, J, MA, MB, MO, MP, MQ, MR, >
Q5054	TR	2SC2240-BL(TTPE2_F)	1	2211406T	< DC, DF, J, MA, MB, MO, MP, MQ, MR, >
Q5054 or	TR	2SC2240-GR	(1)	2211405T	< DC, DF, J, MA, MB, MO, MP, MQ, MR, >
Q5055	TR	2SC2240-BL(TTPE2_F)	1	2211406T	< DC, DF, J, MA, MB, MO, MP, MQ, MR, >
Q5055 or	TR	2SC2240-GR	(1)	2211405T	< DC, DF, J, MA, MB, MO, MP, MQ, MR, >
Q5056	TR	2SC2240-BL(TTPE2_F)	1	2211406T	< DC, DF, J, MA, MB, MO, MP, MQ, MR, >
Q5056 or	TR	2SC2240-GR	(1)	2211405T	< DC, DF, J, MA, MB, MO, MP, MQ, MR, >
Q5060	TR	2SA1360-Y	1	2202094	< DC, DF, J, MA, MB, MO, MP, MQ, MR, >
Q5061	TR	2SA1360-Y	1	2202094	< DC, DF, J, MA, MB, MO, MP, MQ, MR, >
Q5062	TR	2SA1360-Y	1	2202094	< DC, DF, J, MA, MB, MO, MP, MQ, MR, >
Q5063	TR	2SA1360-Y	1	2202094	< DC, DF, J, MA, MB, MO, MP, MQ, MR, >
Q5064	TR	2SA1360-Y	1	2202094	< DC, DF, J, MA, MB, MO, MP, MQ, MR, >
Q5065	TR	2SA1360-Y	1	2202094	< DC, DF, J, MA, MB, MO, MP, MQ, MR, >
Q5066	TR	2SA1360-Y	1	2202094	< DC, DF, J, MA, MB, MO, MP, MQ, MR, >
Q5070	TR	2SC3423-Y	1	2202104	< DC, DF, J, MA, MB, MO, MP, MQ, MR, >
Q5071	TR	2SC3423-Y	1	2202104	< DC, DF, J, MA, MB, MO, MP, MQ, MR, >
Q5072	TR	2SC3423-Y	1	2202104	< DC, DF, J, MA, MB, MO, MP, MQ, MR, >
Q5073	TR	2SC3423-Y	1	2202104	< DC, DF, J, MA, MB, MO, MP, MQ, MR, >
Q5074	TR	2SC3423-Y	1	2202104	< DC, DF, J, MA, MB, MO, MP, MQ, MR, >
Q5075	TR	2SC3423-Y	1	2202104	< DC, DF, J, MA, MB, MO, MP, MQ, MR, >
Q5076	TR	2SC3423-Y	1	2202104	< DC, DF, J, MA, MB, MO, MP, MQ, MR, >
Q6601	TR	RN1226	1	2214680T	< DC, DF, J, MA, MB, MO, MP, MQ, MR, >
Q6602	TR	RN1226	1	2214680T	< DC, DF, J, MA, MB, MO, MP, MQ, MR, >
Q6603	TR	RN1226	1	2214680T	< DC, DF, J, MA, MB, MO, MP, MQ, MR, >
Q6604	TR	RN1226	1	2214680T	< DC, DF, J, MA, MB, MO, MP, MQ, MR, >
Q6605	TR	RN1226	1	2214680T	< DC, DF, J, MA, MB, MO, MP, MQ, MR, >
Q6606	TR	RN1226	1	2214680T	< DC, DF, J, MA, MB, MO, MP, MQ, MR, >

[TRANS COIL]

L6600 S COIL SC-0.8X11 5X12.5T-6.5L 1 231393S < DC, DF, J, MA, MB, MO, MP, MQ, MR, >

L6601	S COIL	SC-0.8X11.5X12.5T-6.5L	1	231393S	< DC, DF, J, MA, MB, MO, MP, MQ, MR, >
L6602	S COIL	SC-0.8X11.5X12.5T-6.5L	1	231393S	< DC, DF, J, MA, MB, MO, MP, MQ, MR, >
L6603	S COIL	SC-0.8X11.5X12.5T-6.5L	1	231393S	< DC, DF, J, MA, MB, MO, MP, MQ, MR, >
L6604	S COIL	SC-0.8X11.5X12.5T-6.5L	1	231393S	< DC, DF, J, MA, MB, MO, MP, MQ, MR, >
L6605	S COIL	SC-0.8X11.5X12.5T-6.5L	1	231393S	< DC, DF, J, MA, MB, MO, MP, MQ, MR, >
L6606	S COIL	SC-0.8X11.5X12.5T-6.5L	1	231393S	< DC, DF, J, MA, MB, MO, MP, MQ, MR, >
T902	P TRANS	NPT-1520IQ	1	2301812A	< DC, DF, J >
T902	P TRANS	NPT-1520GQ	1	2301813A	< MA, MB, MO, MP, MQ, MR, >

[CAPACITORS]

C5000	UPZ C	2AUPZTF101JE	1	376331014T	< DC, DF, J, MA, MB, MO, MP, MQ, MR, >
C5001	UPZ C	2AUPZTF101JE	1	376331014T	< DC, DF, J, MA, MB, MO, MP, MQ, MR, >
C5002	UPZ C	2AUPZTF101JE	1	376331014T	< DC, DF, J, MA, MB, MO, MP, MQ, MR, >
C5003	UPZ C	2AUPZTF101JE	1	376331014T	< DC, DF, J, MA, MB, MO, MP, MQ, MR, >
C5004	UPZ C	2AUPZTF101JE	1	376331014T	< DC, DF, J, MA, MB, MO, MP, MQ, MR, >
C5005	UPZ C	2AUPZTF101JE	1	376331014T	< DC, DF, J, MA, MB, MO, MP, MQ, MR, >
C5006	UPZ C	2AUPZTF101JE	1	376331014T	< DC, DF, J, MA, MB, MO, MP, MQ, MR, >
C5010	UTSJ C	CE04W25V-47M(UTSJ)	1	398054707T	< DC, DF, J, MA, MB, MO, MP, MQ, MR, >
C5011	UTSJ C	CE04W25V-47M(UTSJ)	1	398054707T	< DC, DF, J, MA, MB, MO, MP, MQ, MR, >
C5012	UTSJ C	CE04W25V-47M(UTSJ)	1	398054707T	< DC, DF, J, MA, MB, MO, MP, MQ, MR, >
C5013	UTSJ C	CE04W25V-47M(UTSJ)	1	398054707T	< DC, DF, J, MA, MB, MO, MP, MQ, MR, >
C5014	UTSJ C	CE04W25V-47M(UTSJ)	1	398054707T	< DC, DF, J, MA, MB, MO, MP, MQ, MR, >
C5015	UTSJ C	CE04W25V-47M(UTSJ)	1	398054707T	< DC, DF, J, MA, MB, MO, MP, MQ, MR, >
C5016	UTSJ C	CE04W25V-47M(UTSJ)	1	398054707T	< DC, DF, J, MA, MB, MO, MP, MQ, MR, >
C5020	UTSP C	CE04W50V-10M(UTSP)	1	397581007T	< DC, DF, J, MA, MB, MO, MP, MQ, MR, >
C5021	UTSP C	CE04W50V-10M(UTSP)	1	397581007T	< DC, DF, J, MA, MB, MO, MP, MQ, MR, >
C5022	UTSP C	CE04W50V-10M(UTSP)	1	397581007T	< DC, DF, J, MA, MB, MO, MP, MQ, MR, >
C5023	UTSP C	CE04W50V-10M(UTSP)	1	397581007T	< DC, DF, J, MA, MB, MO, MP, MQ, MR, >
C5024	UTSP C	CE04W50V-10M(UTSP)	1	397581007T	< DC, DF, J, MA, MB, MO, MP, MQ, MR, >
C5025	UTSP C	CE04W50V-10M(UTSP)	1	397581007T	< DC, DF, J, MA, MB, MO, MP, MQ, MR, >
C5026	UTSP C	CE04W50V-10M(UTSP)	1	397581007T	< DC, DF, J, MA, MB, MO, MP, MQ, MR, >
C5040	UTSP C	CE04W10V-470M(UTSP)	1	397534717T	< DC, DF, J, MA, MB, MO, MP, MQ, MR, >
C5041	UTSP C	CE04W10V-470M(UTSP)	1	397534717T	< DC, DF, J, MA, MB, MO, MP, MQ, MR, >
C5042	UTSP C	CE04W10V-470M(UTSP)	1	397534717T	< DC, DF, J, MA, MB, MO, MP, MQ, MR, >
C5043	UTSP C	CE04W10V-470M(UTSP)	1	397534717T	< DC, DF, J, MA, MB, MO, MP, MQ, MR, >
C5044	UTSP C	CE04W10V-470M(UTSP)	1	397534717T	< DC, DF, J, MA, MB, MO, MP, MQ, MR, >
C5045	UTSP C	CE04W10V-470M(UTSP)	1	397534717T	< DC, DF, J, MA, MB, MO, MP, MQ, MR, >
C5046	UTSP C	CE04W10V-470M(UTSP)	1	397534717T	< DC, DF, J, MA, MB, MO, MP, MQ, MR, >
C5050	UTSP C	CE04W50V-47M(UTSP)	1	397584707T	< DC, DF, J, MA, MB, MO, MP, MQ, MR, >
C5051	UTSP C	CE04W50V-47M(UTSP)	1	397584707T	< DC, DF, J, MA, MB, MO, MP, MQ, MR, >

C6630	TF C	ECQ-V50V-473J	1	374724734T	< DC, DF, J, MA, MB, MO, MP, MQ, MR, >
C6631	TF C	ECQ-V50V-473J	1	374724734T	< DC, DF, J, MA, MB, MO, MP, MQ, MR, >
C6632	TF C	ECQ-V50V-473J	1	374724734T	< DC, DF, J, MA, MB, MO, MP, MQ, MR, >
C6633	TF C	ECQ-V50V-473J	1	374724734T	< DC, DF, J, MA, MB, MO, MP, MQ, MR, >
C6634	TF C	ECQ-V50V-473J	1	374724734T	< DC, DF, J, MA, MB, MO, MP, MQ, MR, >
C6635	TF C	ECQ-V50V-473J	1	374724734T	< DC, DF, J, MA, MB, MO, MP, MQ, MR, >
C6636	TF C	ECQ-V50V-473J	1	374724734T	< DC, DF, J, MA, MB, MO, MP, MQ, MR, >
C6639	MKT C	B32529C0472J289	1	376494724T	< MA, MB, MO, MP, MQ, MR, >
C6640	MKT C	B32529C0472J289	1	376494724T	< MA, MB, MO, MP, MQ, MR, >
C6641	MKT C	B32529C0472J289	1	376494724T	< MA, MB, MO, MP, MQ, MR, >
C6642	MKT C	B32529C0472J289	1	376494724T	< MA, MB, MO, MP, MQ, MR, >
C6643	MKT C	B32529C0472J289	1	376494724T	< MA, MB, MO, MP, MQ, MR, >
C6644	MKT C	B32529C0472J289	1	376494724T	< MA, MB, MO, MP, MQ, MR, >
C6645	MKT C	B32529C0472J289	1	376494724T	< MA, MB, MO, MP, MQ, MR, >
C6646	MKT C	B32529C0472J289	1	376494724T	< MA, MB, MO, MP, MQ, MR, >
C6647	MKT C	B32529C0472J289	1	376494724T	< MA, MB, MO, MP, MQ, MR, >
C6648	MKT C	B32529C0472J289	1	376494724T	< MA, MB, MO, MP, MQ, MR, >
C6649	MKT C	B32529C0472J289	1	376494724T	< MA, MB, MO, MP, MQ, MR, >
C6650	MKT C	B32529C0102J289	1	376491024T	< DC, DF, J, MA, MB, MO, MP, MQ, MR, >
C6651	MKT C	B32529C0102J289	1	376491024T	< DC, DF, J, MA, MB, MO, MP, MQ, MR, >
C6652	MKT C	B32529C0102J289	1	376491024T	< DC, DF, J, MA, MB, MO, MP, MQ, MR, >
C6653	MKT C	B32529C0102J289	1	376491024T	< DC, DF, J, MA, MB, MO, MP, MQ, MR, >
C6654	MKT C	B32529C0102J289	1	376491024T	< DC, DF, J, MA, MB, MO, MP, MQ, MR, >
C6655	MKT C	B32529C0102J289	1	376491024T	< DC, DF, J, MA, MB, MO, MP, MQ, MR, >
C6656	MKT C	B32529C0102J289	1	376491024T	< DC, DF, J, MA, MB, MO, MP, MQ, MR, >
C6657	MKT C	B32529C0102J289	1	376491024T	< DC, DF, J, MA, MB, MO, MP, MQ, MR, >
C6658	MKT C	B32529C0102J289	1	376491024T	< DC, DF, J, MA, MB, MO, MP, MQ, MR, >
C6659	MKT C	B32529C0102J289	1	376491024T	< DC, DF, J, MA, MB, MO, MP, MQ, MR, >
C6660	MKT C	B32529C0102J289	1	376491024T	< DC, DF, J, MA, MB, MO, MP, MQ, MR, >
C901	IS C	ECQU2A103MLC	1	3800039S	< B, >
C901 or	IS C	RE275V-103M	(1)	3500196S	< B, >
C901 or	IS C	LE103-C3.5	(1)	3800042S	< B, >
C902	TF C	ECQ-V50V-104J	1	374721044T	< B, >
C903	PLA C	MKP R46 104M	1	3800041S	< B, >
C911	MKT C	B32529C0102J289	1	376491024T	< B, >
C921	TF C	ECQ-V50V-223J	1	374722234T	< B, >
C922	UTSP C	CE04W25V-470M(UTSP)	1	397554717T	< B, >
C930	UTSP C	CE04W25V-220M(UTSP)	1	397552217T	< B, >
C933	UTSP C	CE04W50V-4.7M(UTSP)	1	397580477T	< B, >

R934	CARBON R	RI6J-33K	1	417343334T	< B, >
[SW TRM]					
E5507B	TRM	NTM-1P233(M1969)	1	25060302	< DC, DF, J, MA, MB, MO, MP, MQ, MR, >
E5509B	TRM	NTM-1P233(M1969)	1	25060302	< DC, DF, J, MA, MB, MO, MP, MQ, MR, >
E6611	TRM	NTM-1P232(M1700)	1	25060301	< B, >
E6612	TRM-423(SCREW)	NEJTANSI ST3	1	25060495	< DC, DF, J, MA, MB, MO, MP, MQ, MR, >
E901	TRM-423(SCREW)	NEJTANSI ST3	1	25060495	< B, >
E902	TRM	NTM-1P233(M1969)	1	25060302	< B, >
F901A	FUSE HOLDER	SNS051	1	250113	< DC, DF, J >
F901B	FUSE HOLDER	SNS051	1	250113	< DC, DF, J >
F901C	FUSE HOL	NSCT-1P2031	1	25052133T	< MA, MB, MO, MP, MQ, MR, >
F901D	FUSE HOL	NSCT-1P2031	1	25052133T	< MA, MB, MO, MP, MQ, MR, >
JL4103A	SOCKET	NSCT-5P97	1	25050269	< DC, DF, J, MA, MB, MO, MP, MQ, MR, >
JL6600B	SOCKET	NSCT-7P99	1	25050271	< DC, DF, J, MA, MB, MO, MP, MQ, MR, >
JL6603B	SOCKET	NSCT-9P101	1	25050273	< DC, DF, J, MA, MB, MO, MP, MQ, MR, >
JL6604A	WIRE HOL	NSCT-11P882	1	25051095	< DC, DF, J, MA, MB, MO, MP, MQ, MR, >
JL6604B	WIRE TRAP	NPLG-11P594	1	25055632	< DC, DF, J, MA, MB, MO, MP, MQ, MR, >
JL6606A	WIRE HOL	NSCT-7P878	1	25051091	< DC, DF, J, MA, MB, MO, MP, MQ, MR, >
JL6607A	WIRE HOL	NSCT-3P874	1	25051087	< DC, DF, J, MA, MB, MO, MP, MQ, MR, >
JL6607B	WIRE HOL	NSCT-3P874	1	25051087	< DC, DF, J, MA, MB, MO, MP, MQ, MR, >
JL6620B	WIRE TRAP	NPLG-7P590	1	25055628	< DC, DF, J, MA, MB, MO, MP, MQ, MR, >
JL901A	WIRE HOL	NSCT-5P876	1	25051089	< B, >
P001	PWB	BCTRM-0083	1	25140083B	N < B, >
P002	PWB	BCPS-0084	{ 1 }	25140084	N < B, >
P003	PWB	BCTRM-0085	{ 1 }	25140085	N < B, >
P004	PWB	BCTRM-0086	{ 1 }	25140086	< DC, DF, J, MA, MB, MO, MP, MQ, MR, >
P005	PWB	BCCLA-0087	{ 1 }	25140087	< DC, DF, J, MA, MB, MO, MP, MQ, MR, >
P1008B	SOCKET	IMSA-9142S-20A	1	25053232	< B, >
P1010B	SOCKET	IMSA-9142S-20A	1	25053232	< B, >
P6000A	SOCKET	NSCT-7P2187	1	25052290	< DC, DF, J, MA, MB, MO, MP, MQ, MR, >
P6001A	SOCKET	NSCT-7P2187	1	25052290	< DC, DF, J, MA, MB, MO, MP, MQ, MR, >
P6002A	SOCKET	NSCT-7P2187	1	25052290	< DC, DF, J, MA, MB, MO, MP, MQ, MR, >
P6003A	SOCKET	NSCT-7P2187	1	25052290	< DC, DF, J, MA, MB, MO, MP, MQ, MR, >
P6004A	SOCKET	NSCT-7P2187	1	25052290	< DC, DF, J, MA, MB, MO, MP, MQ, MR, >
P6005A	SOCKET	NSCT-7P2187	1	25052290	< DC, DF, J, MA, MB, MO, MP, MQ, MR, >
P6006A	SOCKET	NSCT-7P2187	1	25052290	< DC, DF, J, MA, MB, MO, MP, MQ, MR, >
P6600	TRM	NTM-2PDMCR400	1	25060472	< DC, DF, J, MA, MB, MO, MP, MQ, MR, >
P6601	TRM	NTM-2PDMCR400	1	25060472	< DC, DF, J, MA, MB, MO, MP, MQ, MR, >
P6602	TRM	NTM-2PDMCR400	1	25060472	< DC, DF, J, MA, MB, MO, MP, MQ, MR, >

P6603	TRM	NTM-2PDMCR400	1	25060472	< DC, DF, J, MA, MB, MO, MP, MQ, MR, >
P6604	TRM	NTM-2PDMCR400	1	25060472	< DC, DF, J, MA, MB, MO, MP, MQ, MR, >
P6605	TRM	NTM-2PDMCR400	1	25060472	< DC, DF, J, MA, MB, MO, MP, MQ, MR, >
P6606	TRM	NTM-2PDMCR400	1	25060472	< DC, DF, J, MA, MB, MO, MP, MQ, MR, >
P6607	TRM	NTM-2PDMCR400	1	25060472	< DC, DF, J, MA, MB, MO, MP, MQ, MR, >
P6608	TRM	NTM-2PDMCR400	1	25060472	< DC, DF, J, MA, MB, MO, MP, MQ, MR, >
P6609	TRM	NTM-2PDMCR400	1	25060472	< DC, DF, J, MA, MB, MO, MP, MQ, MR, >
P6610	TRM	NTM-2PDMCR400	1	25060472	< DC, DF, J, MA, MB, MO, MP, MQ, MR, >
P6621	SOCKET	IMSA-9142S-16A	1	25053230	< DC, DF, J, MA, MB, MO, MP, MQ, MR, >
P902B	PLUG	NPLG-2P631	1	25055675	< DC, DF, J, MA, MB, MO, MP, MQ, MR, >
P902Bor	PLUG	1-1123724-2	(1)	25056402	< DC, DF, J, MA, MB, MO, MP, MQ, MR, >
P911	PLUG	NPLG-2P631	1	25055675	< B, >
P911 or	PLUG	1-1123724-2	(1)	25056402	< B, >
P921C	PLUG	NPLG-2P631	1	25055675	< B, >
P921Cor	PLUG	1-1123724-2	(1)	25056402	< B, >
RL6600	RELAY	NRL-2P5A-DC24-193	1	25065703	< DC, DF, J, MA, MB, MO, MP, MQ, MR, >
RL6602	RELAY	NRL-2P5A-DC24-193	1	25065703	< DC, DF, J, MA, MB, MO, MP, MQ, MR, >
RL6603	RELAY	NRL-2P5A-DC24-193	1	25065703	< DC, DF, J, MA, MB, MO, MP, MQ, MR, >
RL6605	RELAY	NRL-2P5A-DC24-193	1	25065703	< DC, DF, J, MA, MB, MO, MP, MQ, MR, >
RL6607	RELAY	NRL-2P5A-DC24-193	1	25065703	< DC, DF, J, MA, MB, MO, MP, MQ, MR, >
RL6609	RELAY	NRL-2P5A-DC24-193	1	25065703	< DC, DF, J, MA, MB, MO, MP, MQ, MR, >
RL901	RELAY	NRL-1P10A-DC9-186	1	25065683	< B, >

[TUNER UNIT]

Q5030A	RETAINER	(CLA)	1	27142123	< DC, DF, J, MA, MB, MO, MP, MQ, MR, >
Q5031A	RETAINER	(CLA)	1	27142123	< DC, DF, J, MA, MB, MO, MP, MQ, MR, >
Q5032A	RETAINER	(CLA)	1	27142123	< DC, DF, J, MA, MB, MO, MP, MQ, MR, >
Q5033A	RETAINER	(CLA)	1	27142123	< DC, DF, J, MA, MB, MO, MP, MQ, MR, >
Q5034A	RETAINER	(CLA)	1	27142123	< DC, DF, J, MA, MB, MO, MP, MQ, MR, >
Q5035A	RETAINER	(CLA)	1	27142123	< DC, DF, J, MA, MB, MO, MP, MQ, MR, >
Q5036A	RETAINER	(CLA)	1	27142123	< DC, DF, J, MA, MB, MO, MP, MQ, MR, >

ONKYO CORPORATION

Service Dept. Technical Support : 2-1, Nisshin-cho, Neyagawa-shi, OSAKA 572-8540, JAPAN
Tel: 072-831-8023 Fax: 072-831-8163

ONKYO U.S.A. CORPORATION

18 Park Way, Upper Saddle River, N.J. 07458, U.S.A.
Tel: 201-785-2600 Fax: 201-785-2650 <http://www.us.onkyo.com/>

ONKYO EUROPE ELECTRONICS GmbH (DUISBURG OFFICE)

Hafenr.7602, Logport Office-Center, Bliersheimerstr.80B, 47229 Duisburg, Germany
Tel: +49-2065-90198-00 Fax: +49-2065-90198-40 <http://www.eu.onkyo.com/>

ONKYO EUROPE UK Office

Suite 1, Gregories Court, Gregories Road, Beaconsfield, Buckinghamshire, HP9 1HQ
UNITED KINGDOM Tel: +44-(0)1494-681515 Fax: +44(0)-1494-680452

ONKYO CHINA LIMITED

Units 2102-2107, Metroplaza Tower I, 223 Hing Fong Road, Kwai Chung,
N.T., HONG KONG Tel: 852-2429-3118 Fax: 852-2428-9039
<http://www.ch.onkyo.com/>

