

# ONKYO SERVICE MANUAL

## AV RECEIVER MODEL TX-SR576

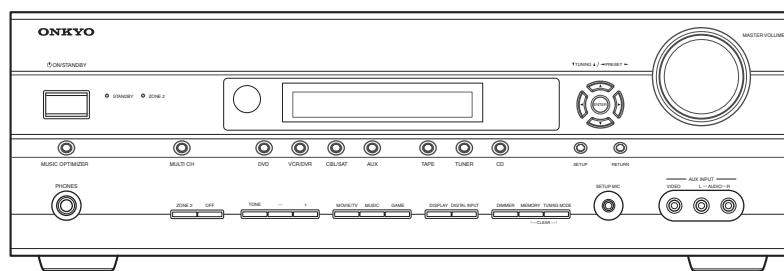

RC-709M

### Black and Silver models

B MDD, B MDC, S MDD	120V AC, 60Hz
B MPP, S MPP	230V AC, 50Hz
B MPA, S MPA	230V AC, 50Hz

### SAFETY-RELATED COMPONENT WARNING!!

COMPONENTS IDENTIFIED BY MARK  ON THE SCHEMATIC DIAGRAM AND IN THE PARTS LIST ARE CRITICAL FOR RISK OF FIRE AND ELECTRIC SHOCK. REPLACE THESE COMPONENTS WITH ONKYO PARTS WHOSE PART NUMBERS APPEAR AS SHOWN IN THIS MANUAL.

MAKE LEAKAGE-CURRENT OR RESISTANCE MEASUREMENTS TO DETERMINE THAT EXPOSED PARTS ARE ACCEPTABLY INSULATED FROM THE SUPPLY CIRCUIT BEFORE RETURNING THE APPLIANCE TO THE CUSTOMER.



## EXPLODED VIEWS-2

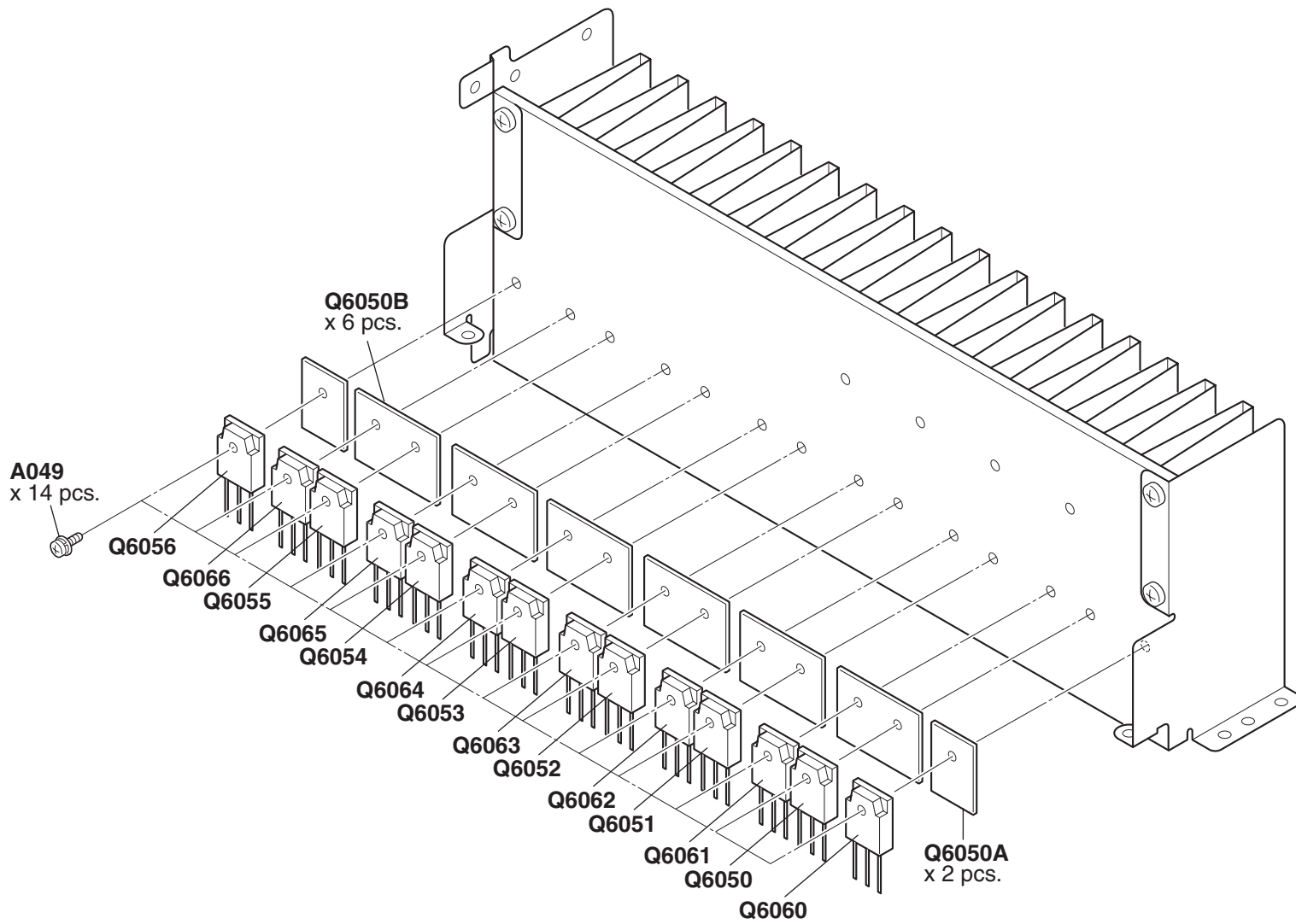

# BLOCK DIAGRAMS-1

## AUDIO SECTION

1

2

3

4

5

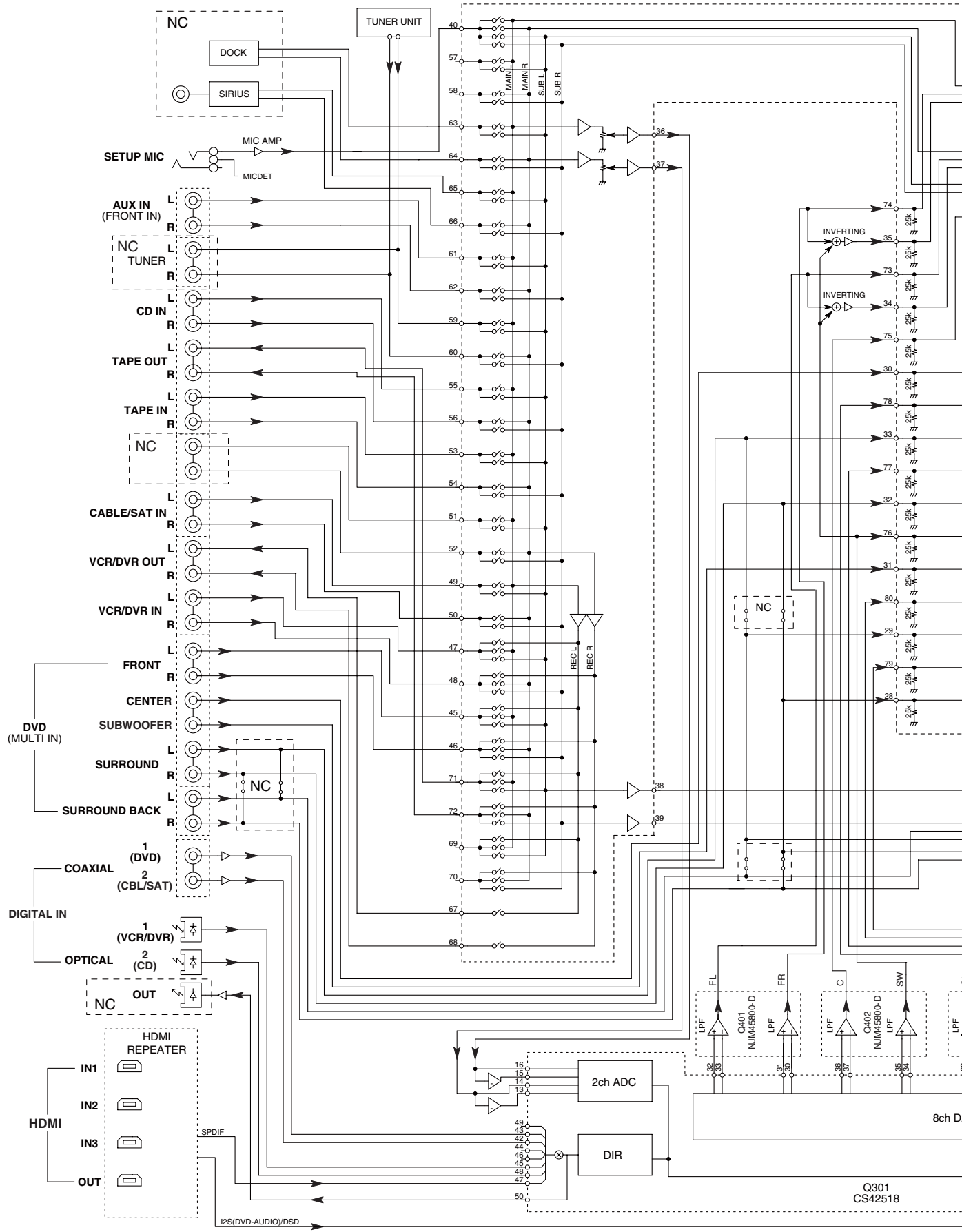

E

F

G

H

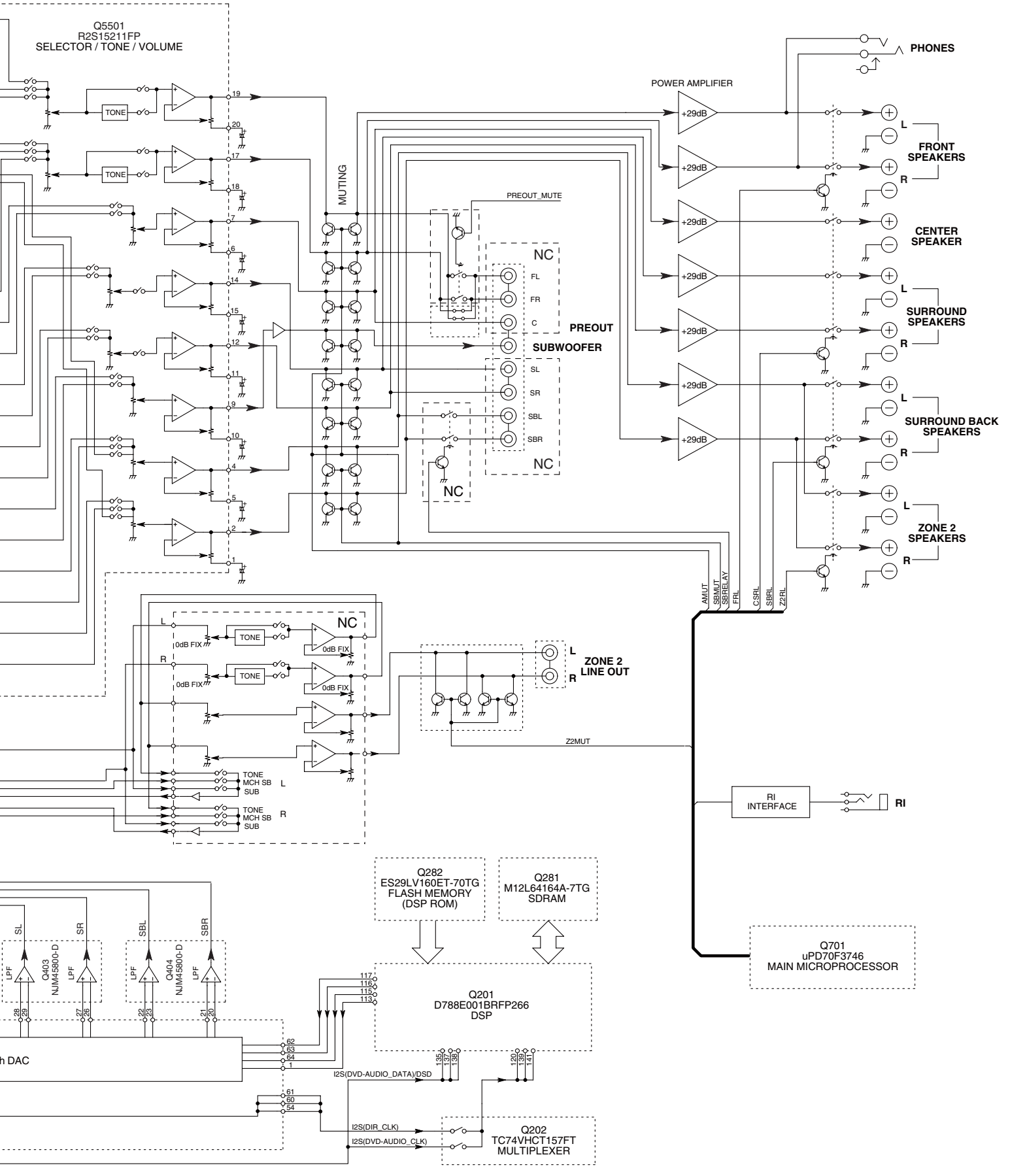

**BLOCK DIAGRAMS-2**  
**VIDEO / HDMI SECTION**

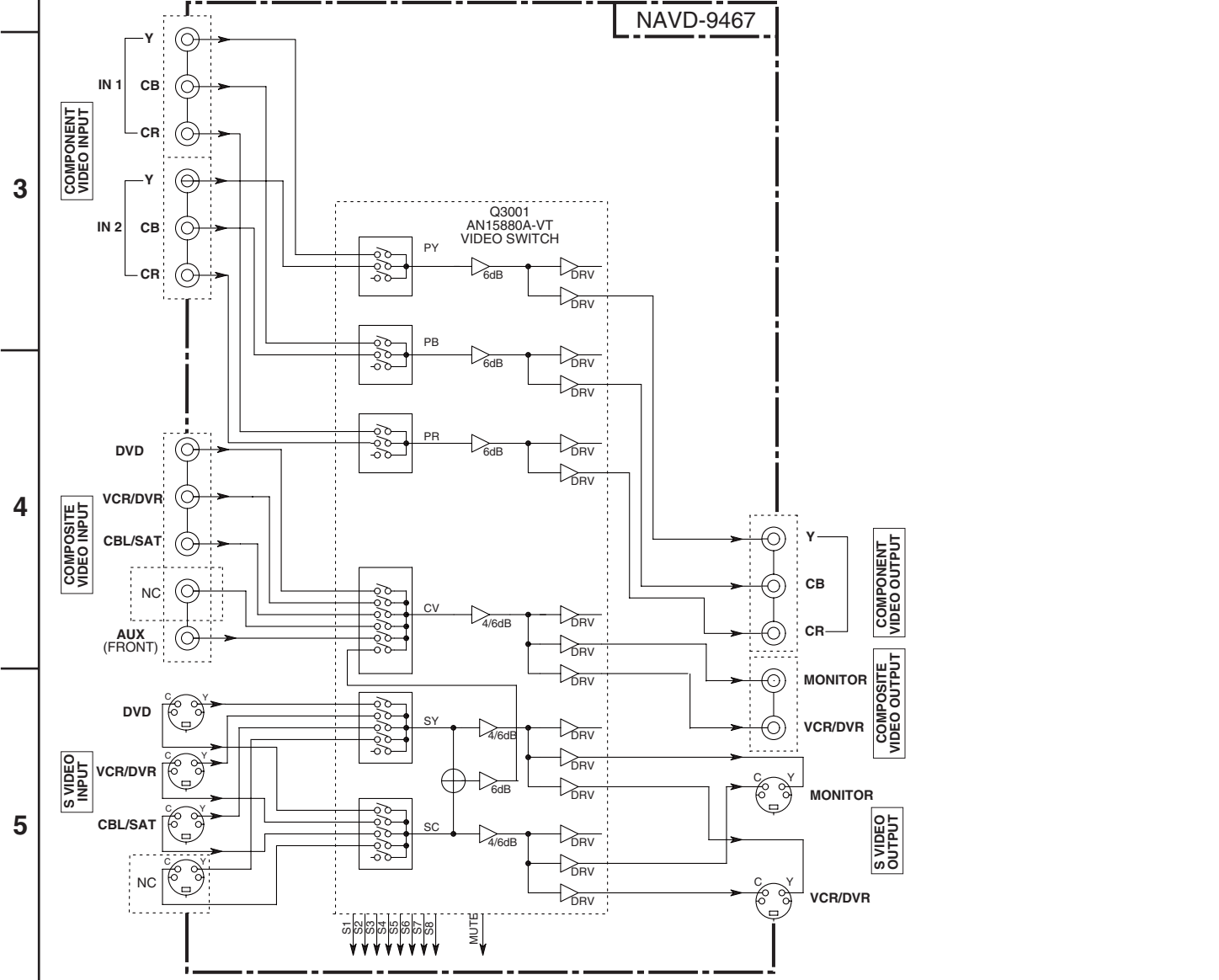
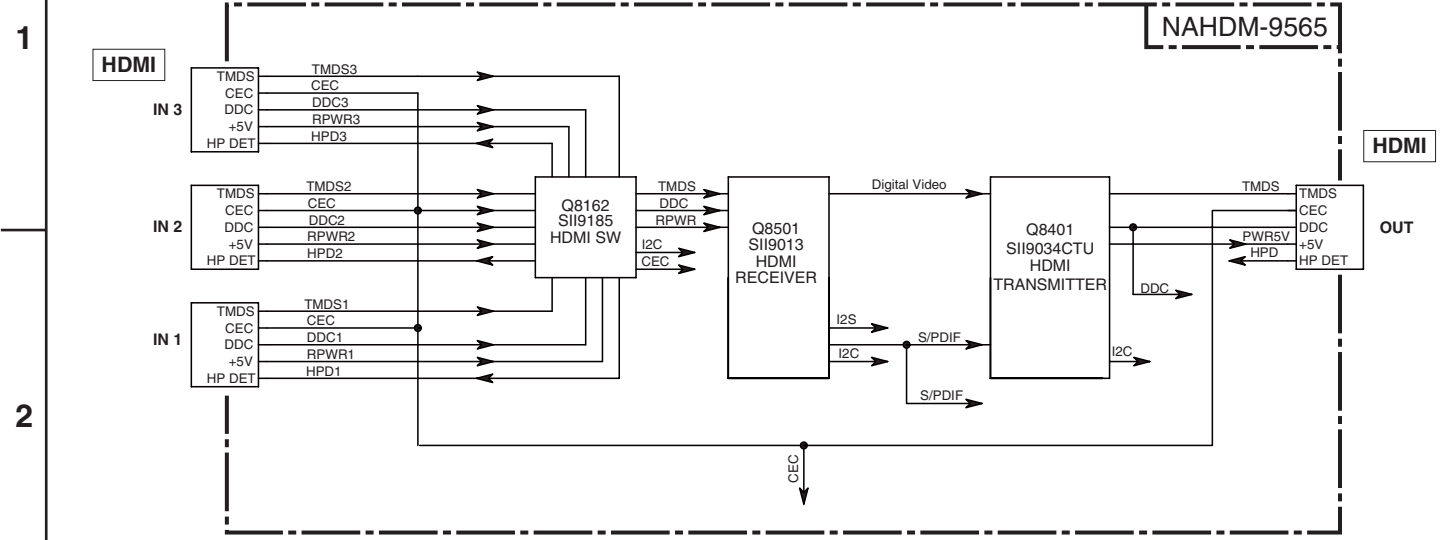

# SCHEMATIC DIAGRAMS-1 (SD-1)

## AUDIO INPUT SECTION

<Note>

NC = No mount of parts.

SD-Z : XY

Location of connected terminal in schematic diagrams.

SD-Z = Schematic diagrams-Z. X = A to H, Y = 1 to 5.

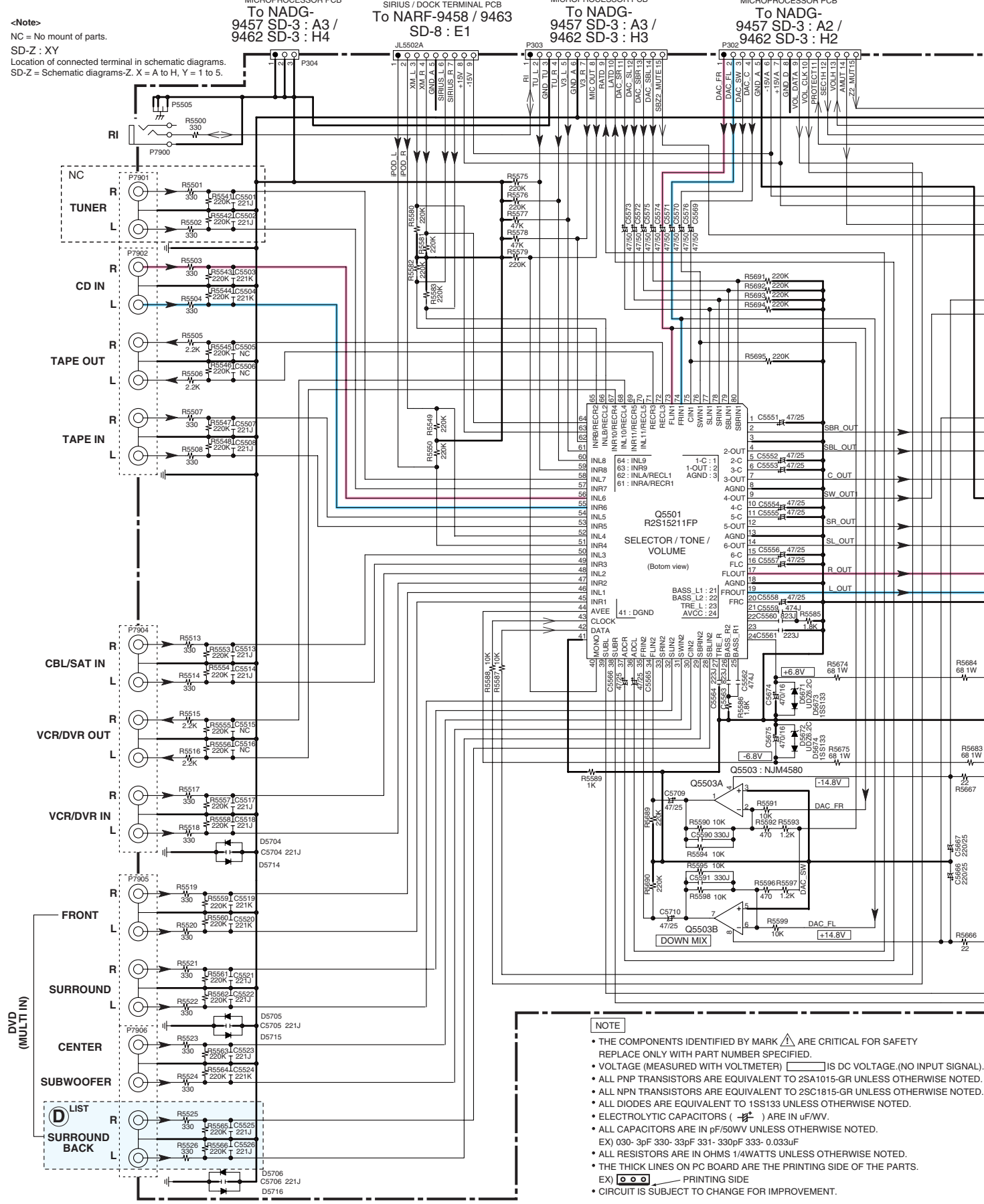

- NOTE**
- THE COMPONENTS IDENTIFIED BY MARK ARE CRITICAL FOR SAFETY. REPLACE ONLY WITH PART NUMBER SPECIFIED.
  - VOLTAGE (MEASURED WITH VOLTMETER) IS DC VOLTAGE. (NO INPUT SIGNAL).
  - ALL PNP TRANSISTORS ARE EQUIVALENT TO 2SA1015-GR UNLESS OTHERWISE NOTED.
  - ALL NPN TRANSISTORS ARE EQUIVALENT TO 2SC1815-GR UNLESS OTHERWISE NOTED.
  - ALL DIODES ARE EQUIVALENT TO 1SS133 UNLESS OTHERWISE NOTED.
  - ELECTROLYTIC CAPACITORS ( ) ARE IN uF/WW.
  - ALL CAPACITORS ARE IN pF/50WV UNLESS OTHERWISE NOTED.  
EX) 030-3pF 330-33pF 331-330pF 333-0.03uF
  - ALL RESISTORS ARE IN OHMS 1/4WATTS UNLESS OTHERWISE NOTED.
  - THE THICK LINES ON PC BOARD ARE THE PRINTING SIDE OF THE PARTS.  
EX) PRINTING SIDE
  - CIRCUIT IS SUBJECT TO CHANGE FOR IMPROVEMENT.

1

2

3

4

5

DVD (MULTI IN)

LIST

SURROUND BACK

CENTER

SURROUND

FRONT

VCR/DVR IN

VCR/DVR OUT

CBL/SAT IN

TAPE IN

TAPE OUT

CD IN

TUNER

NC

RI

MICROPROCESSOR PCB  
To NADG-  
9457 SD-3 : A3 /  
9462 SD-3 : H4

SIRIUS / DOCK TERMINAL PCB  
To NARF-9458 / 9463  
SD-8 : E1

MICROPROCESSOR PCB  
To NADG-  
9457 SD-3 : A3 /  
9462 SD-3 : H3

MICROPROCESSOR PCB  
To NADG-  
9457 SD-3 : A2 /  
9462 SD-3 : H2

E

F

G

H

**CONNECTION**

		TX-SR506	HT-R518	HT-R560	TX-SR576	HT-R667	HT-R960
P301	To NADG-	NC	NC	NC	9462	9462	9462
P302_303	To NADG-	9457	9457	9457	9462	9462	9462
P304	To NADG-	9457	9457	9457	9462	9462	9462
JL5502A	To NARF-	NC	NC	9458	NC	9463	NC

MICROPROCESSOR PCB  
To NADG-9462  
SD-3 : H2

**U01** **NAAF-9419(1/2)**  
**AMPLIFIER PCB BOARD**

AMPLIFIER PCB  
To NAAF-9419(2/2)  
SD-2 : B3

Refer to following table about the parts displayed by mark "LIST".  
TA20 : Jumper wire L=20 mm

	TX-SR506	HT-R518	HT-R560	TX-SR576	HT-R667	HT-R960
R5680, 5682	220K	NC	NC	220K	220K	NC
R5813	0	NC	NC	0	0	NC
R5814	NC	NC	0	NC	NC	0
R5611, 5612	2.2K	NC	2.2K	2.2K	2.2K	2.2K
R5621, 5622	0	NC	0	0	0	0
R5677, 5678	NC	15 (2W)	15 (2W)	NC	NC	15 (2W)
J5246, 5247	TA20	NC	NC	TA20	TA20	NC
(A)	Yes	None	None	Yes	Yes	None
(B)	Yes	None	Yes	Yes	Yes	Yes
(C)	Yes	None	None	Yes	Yes	None
(D)	Yes	None	Yes	Yes	Yes	Yes

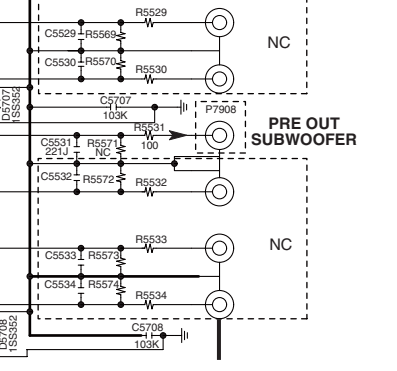
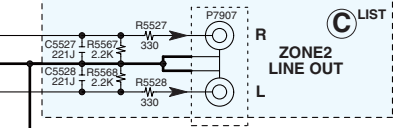
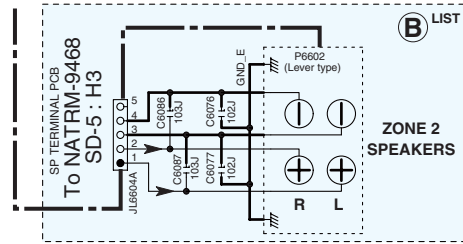
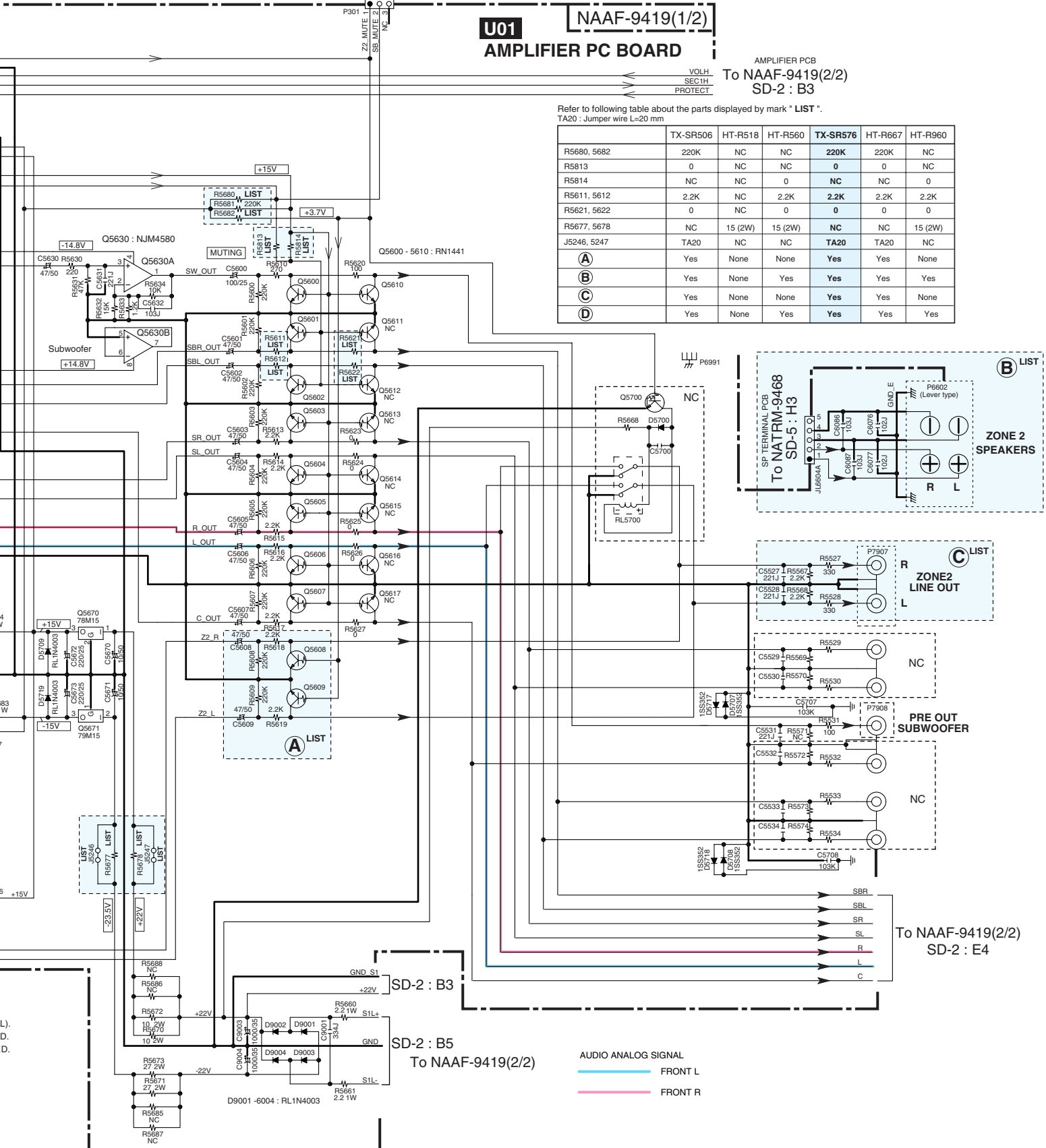

SD-2 : B3  
SD-2 : B5  
To NAAF-9419(2/2)

AUDIO ANALOG SIGNAL  
FRONT L  
FRONT R

To NAAF-9419(2/2)  
SD-2 : E4



# SCHEMATIC DIAGRAMS-2 (SD-2)

## POWER AMP. SECTION

<Note>  
 NC = No mount of parts.  
 SD-Z : XY  
 Location of connected terminal in schematic diagrams.  
 SD-Z = Schematic diagrams-Z. X = A to H, Y = 1 to 5.

NAAF-9419 (2/2)

### U01 AMPLIFIER PC BOARD

Refer to following table about the parts displayed by mark \* LIST \*.

	TX-SR506		HT-R518		HT-R560		TX-SR576		HT-R667		HT-R960	
	DD, DC	PP, PB	GK, GO, GR	WT, WO, WF	PP	DD, DC	PP	DD, DC, PA	PP	DD	DC	PP
Q6050 - 52	MN130S	12SC5198	MN130S	MN130S	MN130S	2SC5242	MN130S	2SC5198	MN130S	MN130S	2SC5242	
Q6060 - 62	MP130S	12SA1941	MP130S	MP130S	MP130S	2SA1962	MP130S	2SA1941	MP130S	MP130S	2SA1962	
Q6053 - 54	MN130S	12SC5198	MN130S	MN130S	MN130S	2SC5242	MN130S	2SC5198	MN130S	MN130S	2SC5242	
Q6063 - 64	MP130S	12SA1941	MP130S	MP130S	MP130S	2SA1962	MP130S	2SA1941	MP130S	MP130S	2SA1962	
Q6055 - 56	2SC5198	12SC5198	2SC5198	MN130S	2SC5198	2SC5242	2SC5198	2SC5198	MN130S	MP130S	2SC5242	
Q6065 - 66	2SA1941	12SA1941	2SA1941	MP130S	2SA1941	2SA1962	2SA1941	2SA1941	MP130S	MP130S	2SA1962	
Q5050 - 56		2SC1815			2SC2240	2SC2240	2SC1815		2SC1815		2SC2240	
R5160 - 5166		100(1/4W)			150(1/4W)	150(1/4W)	100(1/4W)		100(1/4W)		150(1/4W)	
R5170 - 5176		100(1/4W)			150(1/4W)	150(1/4W)	100(1/4W)		100(1/4W)		150(1/4W)	
R6070 - 6072		82(1/4W)			120(1/4W)	120(1/4W)	82(1/4W)		82(1/4W)		120(1/4W)	
R6073 - 6076		100(1/4W)			120(1/4W)	120(1/4W)	100(1/4W)		100(1/4W)		120(1/4W)	
C6901, 6902		63V/8200u			69V/10000u	69V/10000u	63V/10000u		63V/10000u		63V/10000u	
R6710		5.6K			5.6K	4.7K	5.6K		5.6K		4.7K	

AMPLIFIER PCB  
 To NAAF-9419(1/2)

AUDIO ANALOG SIGNAL  
 FRONT L  
 FRONT R

TRANS. SEC. TERMINAL PCB  
 To NAPS-9420  
 SD-5 : D3

AMPLIFIER PCB  
 To NAAF-9419(1/2)  
 SD-1 : F5

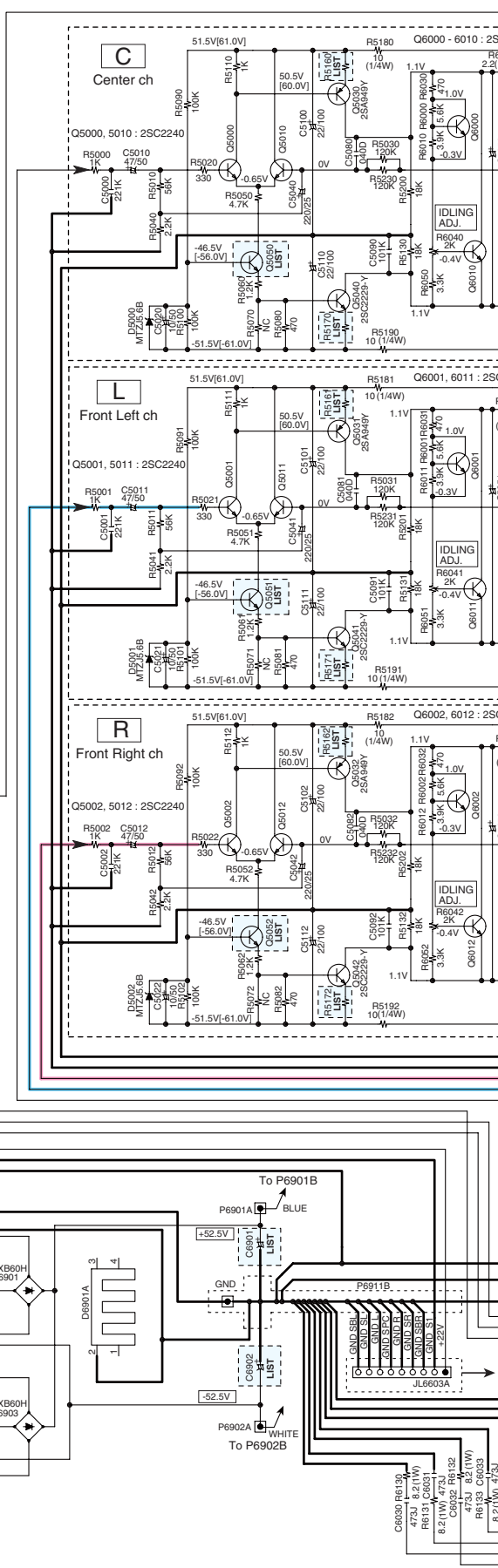

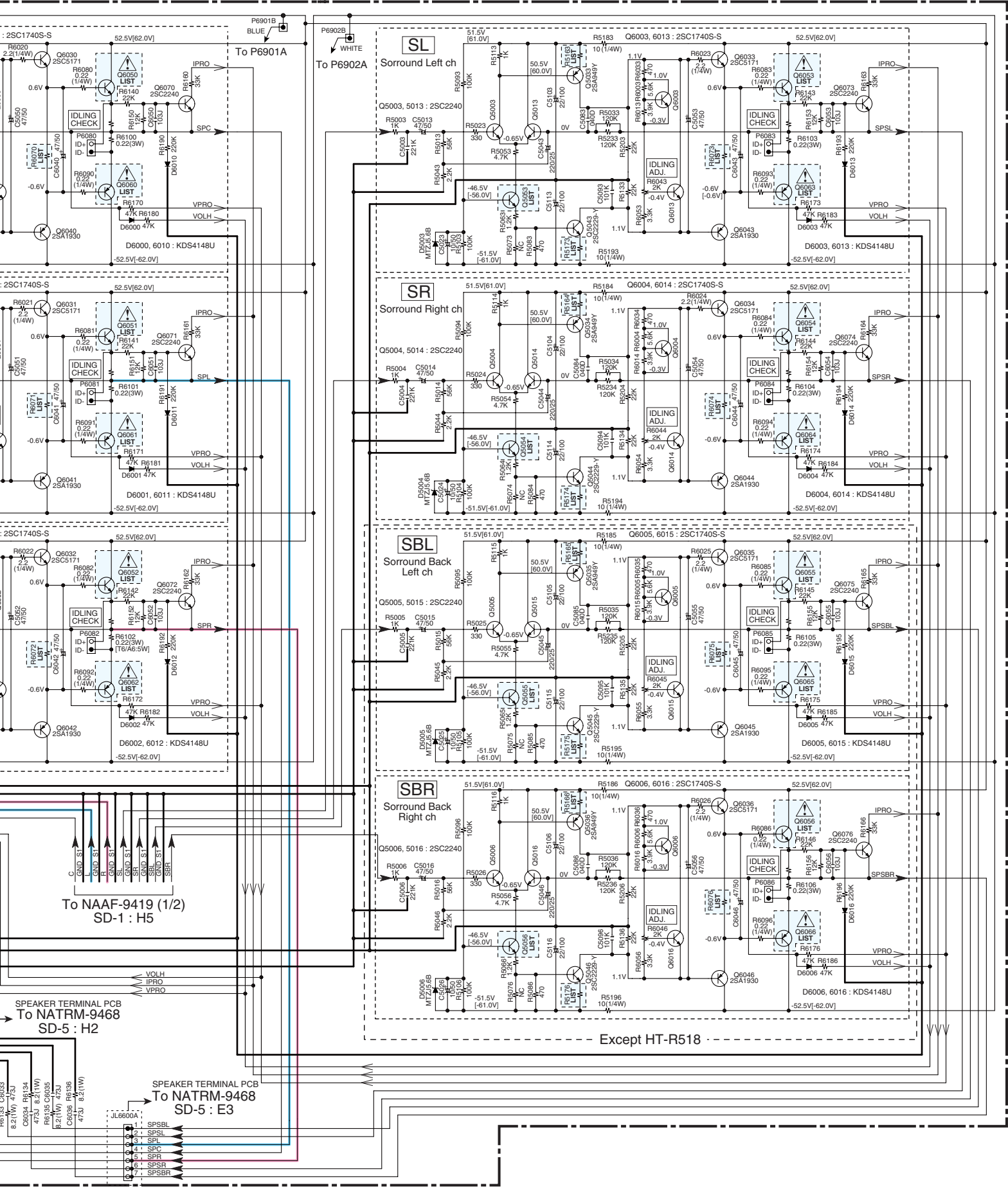

SL

Sorround Left ch

SR

Sorround Right ch

SBL

Sorround Back Left ch

SBR

Sorround Back Right ch

To NAAF-9419 (1/2)  
SD-1 : H5

SPEAKER TERMINAL PCB  
To NATRM-9468  
SD-5 : H2

SPEAKER TERMINAL PCB  
To NATRM-9468  
SD-5 : E3

Except HT-R518

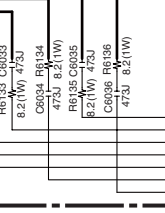

# SCHEMATIC DIAGRAMS-3 (SD-3) MICROPROCESSOR SECTION

DSP/HDMI PCB  
To NAHDM-9473  
SD-8 : F1

NADG-9462

U32  
MICROPROCESSOR PC BOARD

DISPLAY PCB  
To NADIS-9430  
SD-6 : H1

VIDEO PCB  
To NAVD-9467  
SD-4 : G4

VIDEO PCB  
To NAVD-9467  
SD-4 : G4

<Note>  
NC = No mount of parts.  
SD-Z : XY  
Location of connected terminal in schematic diagrams.  
SD-Z = Schematic diagrams-Z. X = A to H, Y = 1 to 5.

AUDIO DIGITAL SIGNAL  
AUDIO ANALOG SIGNAL  
FRONT L  
FRONT R

COAXIAL

DIGITAL IN

OPTICAL

DIGITAL OUT  
OPTICAL

LIST (A)

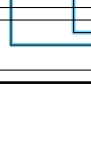
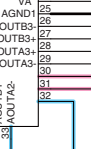
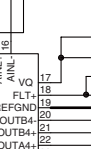
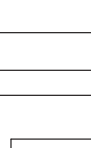
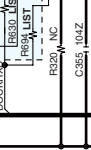
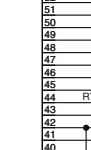
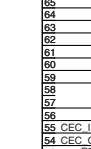
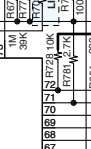
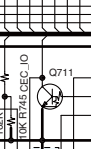
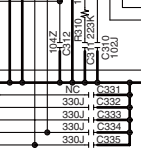
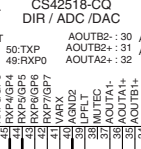
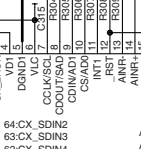
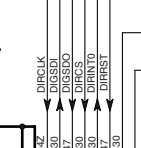
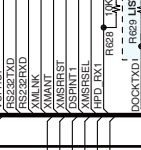
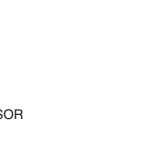
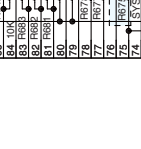
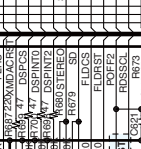
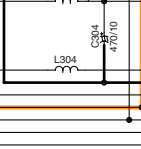
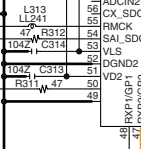
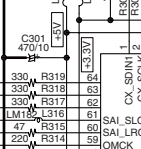
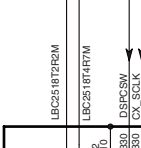
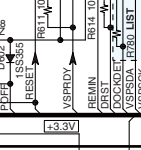
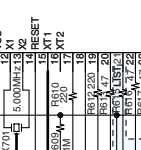
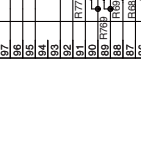
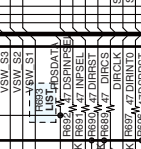
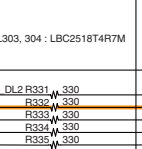
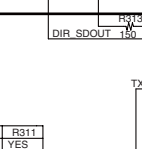
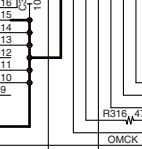
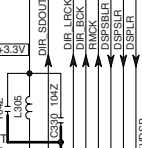
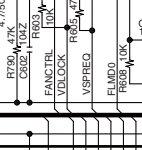
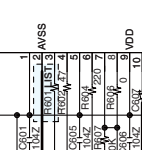
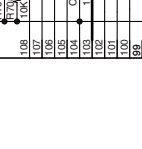
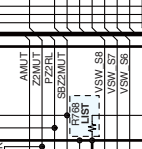
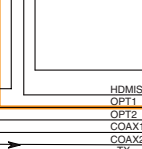
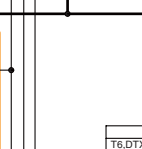
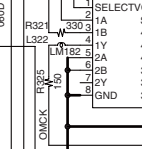
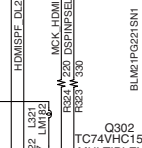
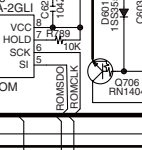
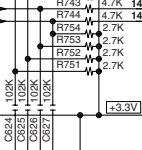
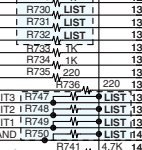
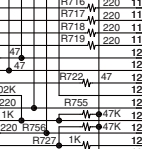
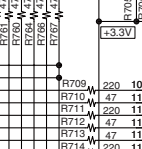
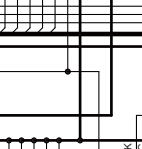
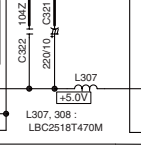
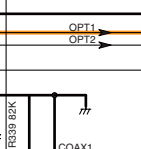
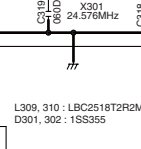
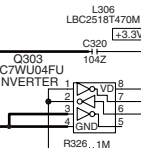
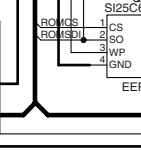
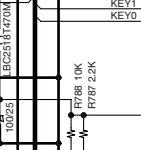
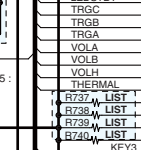
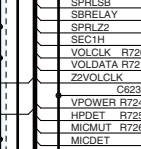
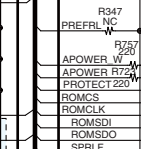
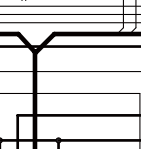
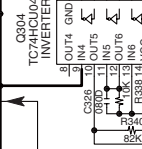
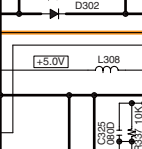
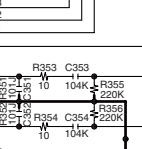
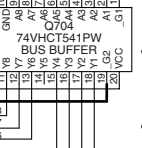
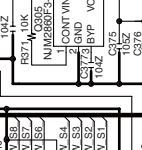
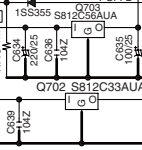
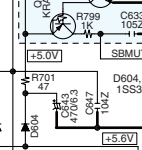
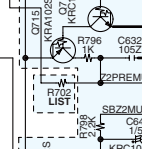
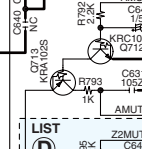
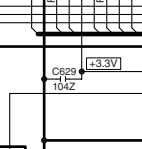
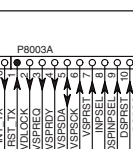
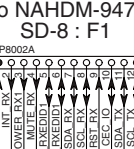
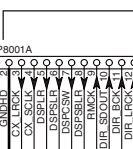
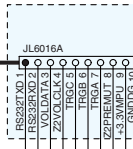
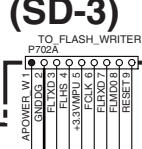

Q701  
uP070F3746  
MAIN MICROPROCESSOR

NU : NO USE

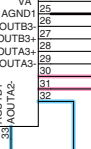
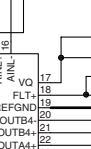
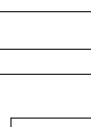
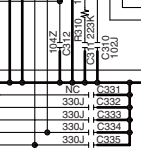
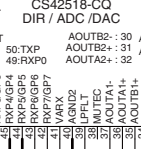
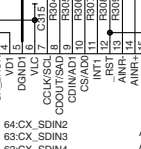
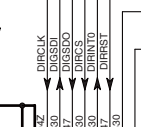
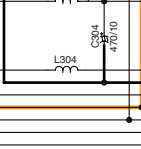
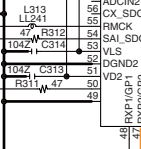
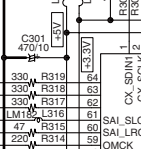
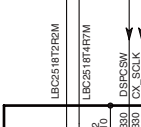
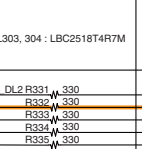
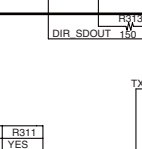
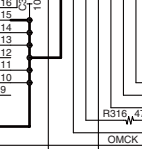
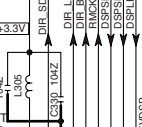
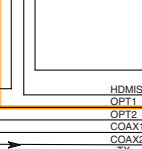
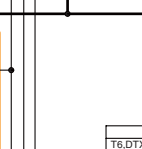
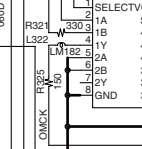
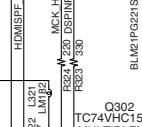
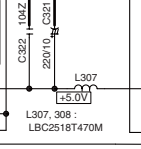
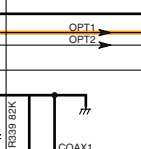
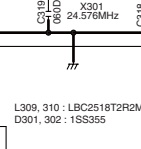
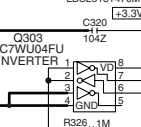

Q302  
TC74VHC157F  
MULTIPLEXER

Q303  
TC74VHC157F  
MULTIPLEXER

Q304  
TC74VHC157F  
MULTIPLEXER

Q305  
TC74VHC157F  
MULTIPLEXER

Q306  
TC74VHC157F  
MULTIPLEXER

Q307  
TC74VHC157F  
MULTIPLEXER

Q308  
TC74VHC157F  
MULTIPLEXER

Q309  
TC74VHC157F  
MULTIPLEXER

Q310  
TC74VHC157F  
MULTIPLEXER

Q311  
TC74VHC157F  
MULTIPLEXER

Q312  
TC74VHC157F  
MULTIPLEXER

Q313  
TC74VHC157F  
MULTIPLEXER

Q314  
TC74VHC157F  
MULTIPLEXER

Q315  
TC74VHC157F  
MULTIPLEXER

Q316  
TC74VHC157F  
MULTIPLEXER

Q317  
TC74VHC157F  
MULTIPLEXER

Q318  
TC74VHC157F  
MULTIPLEXER

Q319  
TC74VHC157F  
MULTIPLEXER

Q320  
TC74VHC157F  
MULTIPLEXER

Q321  
TC74VHC157F  
MULTIPLEXER

Q322  
TC74VHC157F  
MULTIPLEXER

Q323  
TC74VHC157F  
MULTIPLEXER

Q324  
TC74VHC157F  
MULTIPLEXER

Q325  
TC74VHC157F  
MULTIPLEXER

Q326  
TC74VHC157F  
MULTIPLEXER

Q327  
TC74VHC157F  
MULTIPLEXER

Q328  
TC74VHC157F  
MULTIPLEXER

Q329  
TC74VHC157F  
MULTIPLEXER

Q330  
TC74VHC157F  
MULTIPLEXER

Q331  
TC74VHC157F  
MULTIPLEXER

Q332  
TC74VHC157F  
MULTIPLEXER

Q333  
TC74VHC157F  
MULTIPLEXER

Q334  
TC74VHC157F  
MULTIPLEXER

Q335  
TC74VHC157F  
MULTIPLEXER

Q336  
TC74VHC157F  
MULTIPLEXER

Q337  
TC74VHC157F  
MULTIPLEXER

Q338  
TC74VHC157F  
MULTIPLEXER

Q339  
TC74VHC157F  
MULTIPLEXER

Q340  
TC74VHC157F  
MULTIPLEXER

Q341  
TC74VHC157F  
MULTIPLEXER

Q342  
TC74VHC157F  
MULTIPLEXER

Q343  
TC74VHC157F  
MULTIPLEXER

Q344  
TC74VHC157F  
MULTIPLEXER

Q345  
TC74VHC157F  
MULTIPLEXER

Q346  
TC74VHC157F  
MULTIPLEXER

Q347  
TC74VHC157F  
MULTIPLEXER

Q348  
TC74VHC157F  
MULTIPLEXER

Q349  
TC74VHC157F  
MULTIPLEXER

Q350  
TC74VHC157F  
MULTIPLEXER

Q351  
TC74VHC157F  
MULTIPLEXER

Q352  
TC74VHC157F  
MULTIPLEXER

Q353  
TC74VHC157F  
MULTIPLEXER

Q354  
TC74VHC157F  
MULTIPLEXER

Q355  
TC74VHC157F  
MULTIPLEXER

Q356  
TC74VHC157F  
MULTIPLEXER

Q357  
TC74VHC157F  
MULTIPLEXER

Q358  
TC74VHC157F  
MULTIPLEXER

Q359  
TC74VHC157F  
MULTIPLEXER

Q360  
TC74VHC157F  
MULTIPLEXER

Q361  
TC74VHC157F  
MULTIPLEXER

Q362  
TC74VHC157F  
MULTIPLEXER

Q363  
TC74VHC157F  
MULTIPLEXER

Q364  
TC74VHC157F  
MULTIPLEXER

Q365  
TC74VHC157F  
MULTIPLEXER

Q366  
TC74VHC157F  
MULTIPLEXER

Q367  
TC74VHC157F  
MULTIPLEXER

Q368  
TC74VHC157F  
MULTIPLEXER

Q369  
TC74VHC157F  
MULTIPLEXER

Q370  
TC74VHC157F  
MULTIPLEXER

Q371  
TC74VHC157F  
MULTIPLEXER

Q372  
TC74VHC157F  
MULTIPLEXER

Q373  
TC74VHC157F  
MULTIPLEXER

Q374  
TC74VHC157F  
MULTIPLEXER

Q375  
TC74VHC157F  
MULTIPLEXER

Q376  
TC74VHC157F  
MULTIPLEXER

Q377  
TC74VHC157F  
MULTIPLEXER

Q378  
TC74VHC157F  
MULTIPLEXER

Q379  
TC74VHC157F  
MULTIPLEXER

Q380  
TC74VHC157F  
MULTIPLEXER

Q381  
TC74VHC157F  
MULTIPLEXER

Q382  
TC74VHC157F  
MULTIPLEXER

Q383  
TC74VHC157F  
MULTIPLEXER

Q384  
TC74VHC157F  
MULTIPLEXER

Q385  
TC74VHC157F  
MULTIPLEXER

Q386  
TC74VHC157F  
MULTIPLEXER

Q387  
TC74VHC157F  
MULTIPLEXER

Q388  
TC74VHC157F  
MULTIPLEXER

Q389  
TC74VHC157F  
MULTIPLEXER

Q390  
TC74VHC157F  
MULTIPLEXER

Q391  
TC74VHC157F  
MULTIPLEXER

Q392  
TC74VHC157F  
MULTIPLEXER

Q393  
TC74VHC157F  
MULTIPLEXER

Q394  
TC74VHC157F  
MULTIPLEXER

Q395  
TC74VHC157F  
MULTIPLEXER

Q396  
TC74VHC157F  
MULTIPLEXER

Q397  
TC74VHC157F  
MULTIPLEXER

Q398  
TC74VHC157F  
MULTIPLEXER

Q399  
TC74VHC157F  
MULTIPLEXER

Q400  
TC74VHC157F  
MULTIPLEXER

Q401  
TC74VHC157F  
MULTIPLEXER

Q402  
TC74VHC157F  
MULTIPLEXER

Q403  
TC74VHC157F  
MULTIPLEXER

Q404  
TC74VHC157F  
MULTIPLEXER

Q405  
TC74VHC157F  
MULTIPLEXER





**E**

**F**

**G**

**H**

Refer to following table about the parts displayed by mark "LIST".

	TX-SR506				HT-R518	HT-R560		TX-SR576		HT-R667	HT-R960			TX-SR606				TX-SA606X
	DD, DC	PP, PB	GK, GQ, GR	WT, WO, WF	PP	DD, DC	PP	DD, DC	PP, PA	DD	DC	PP	DD, DC	PP, PA	GK, GQ, GR	WT, WO, WF	JJ	
(A)	None	None	None	Yes	None	None	None	None	None	None	None	None	None	None	None	Yes	None	
(B)	None				None	None	None	None	None	None	None	None	Yes				Yes	
(C)	None	Yes	Yes	Yes	None	None	None	None	Yes	None	None	None	None	Yes	Yes	Yes	Yes	
C3009, C3054, C3085	NC				NC	NC	NC	NC	470/6.3	470/6.3	470/6.3	470/6.3	470/6.3				470/6.3	
C3086	NC				NC	NC	NC	NC	104Z	104Z	104Z	104Z	104Z				104Z	
D9016	UDZS6.2B				UDZS6.2B	UDZS6.2B	UDZS6.2B	UDZS6.2B	UDZS7.5B	UDZS7.5B	UDZS7.5B	UDZS7.5B	UDZS7.5B				UDZS7.5B	
R9035	1(1/2W)	NC	NC	NC	1(1/2W)	1(1/2W)	1(1/2W)	1(1/2W)	NC	1(1/2W)	1(1/2W)	NC	1(1/2W)	NC	NC	NC	NC	

**CONNECTION**

	TX-SR506	HT-R518	HT-R560	TX-SR576	HT-R667	HT-R960	TX-SR606	TX-SA606X
P2801A To NAHDM-	NC	NC	NC	NC	9473	9473	9473	9473
JL8001A To NAHDM-	9475	9475	9475	9565	9473	9473	9473	9473
JL8002A To NARF-	NC	NC	9458	NC	9463	NC	9463	NC
P2004B To NADG-	9457	9457	9457	9462	9462	9462	9462	9462
JL6017A To NAETC-	NC	NC	NC	NC	NC	NC	NC	NC
P3007A To NAVD-	NC	NC	NC	NC	NC	NC	NC	9464

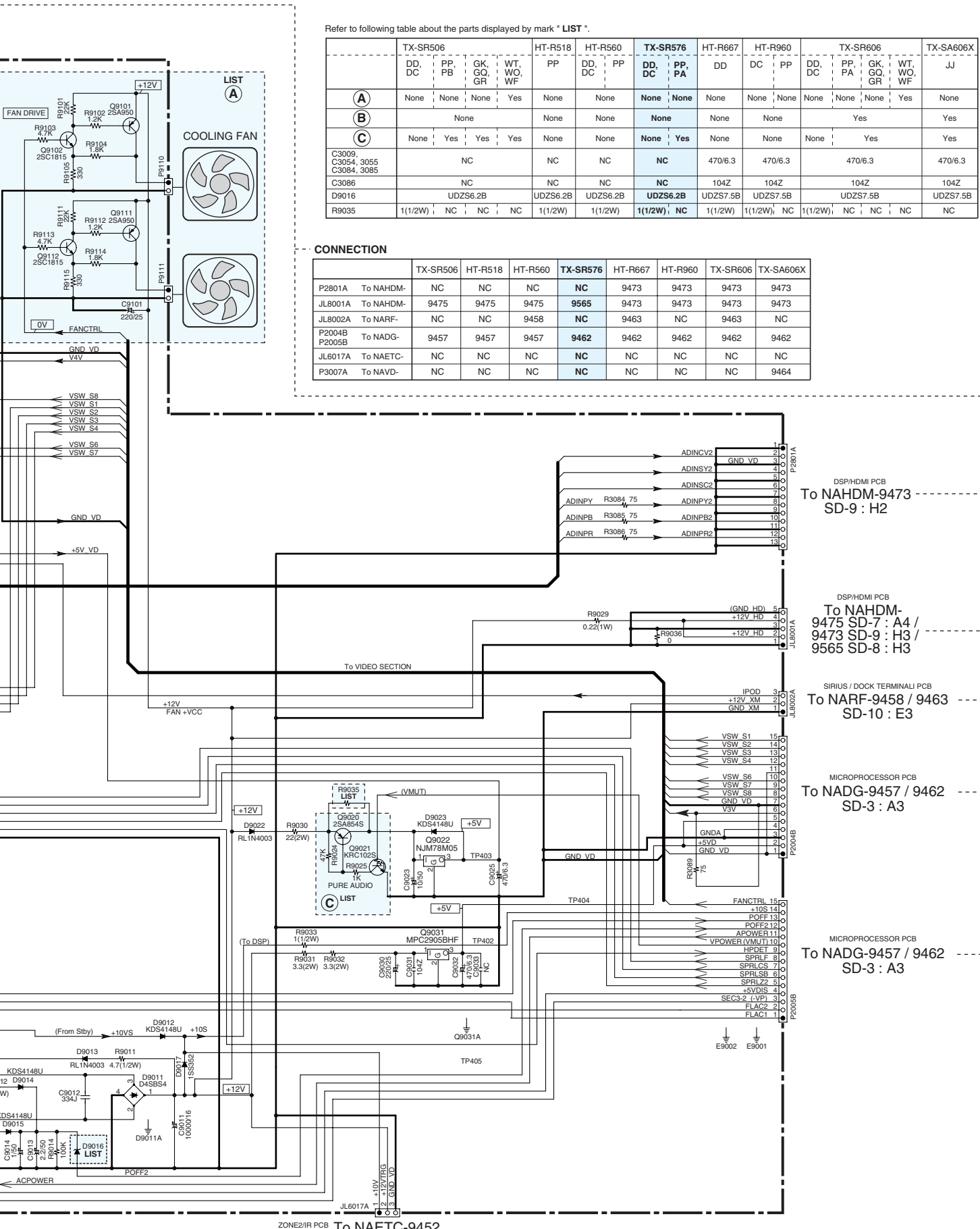

DSP/HDMI PCB  
To NAHDM-9473  
SD-9 : H2

DSP/HDMI PCB  
To NAHDM-9475 SD-7 : A4 /  
9473 SD-9 : H3 /  
9565 SD-8 : H3

SIRIUS / DOCK TERMINAL PCB  
To NARF-9458 / 9463  
SD-10 : E3

MICROPROCESSOR PCB  
To NADG-9457 / 9462  
SD-3 : A3

MICROPROCESSOR PCB  
To NADG-9457 / 9462  
SD-3 : A3

ZONE2/IR PCB To NAETC-9452

# SCHEMATIC DIAGRAMS-5 (SD-5) SPEAKER TERMINAL / POWER SUPPLY SECTION

<Note>  
NC = No mount of parts.  
SD-Z : XY  
Location of connected terminal in schematic diagrams.  
SD-Z = Schematic diagrams-Z. X = A to H, Y = 1 to 5.

1

2

3

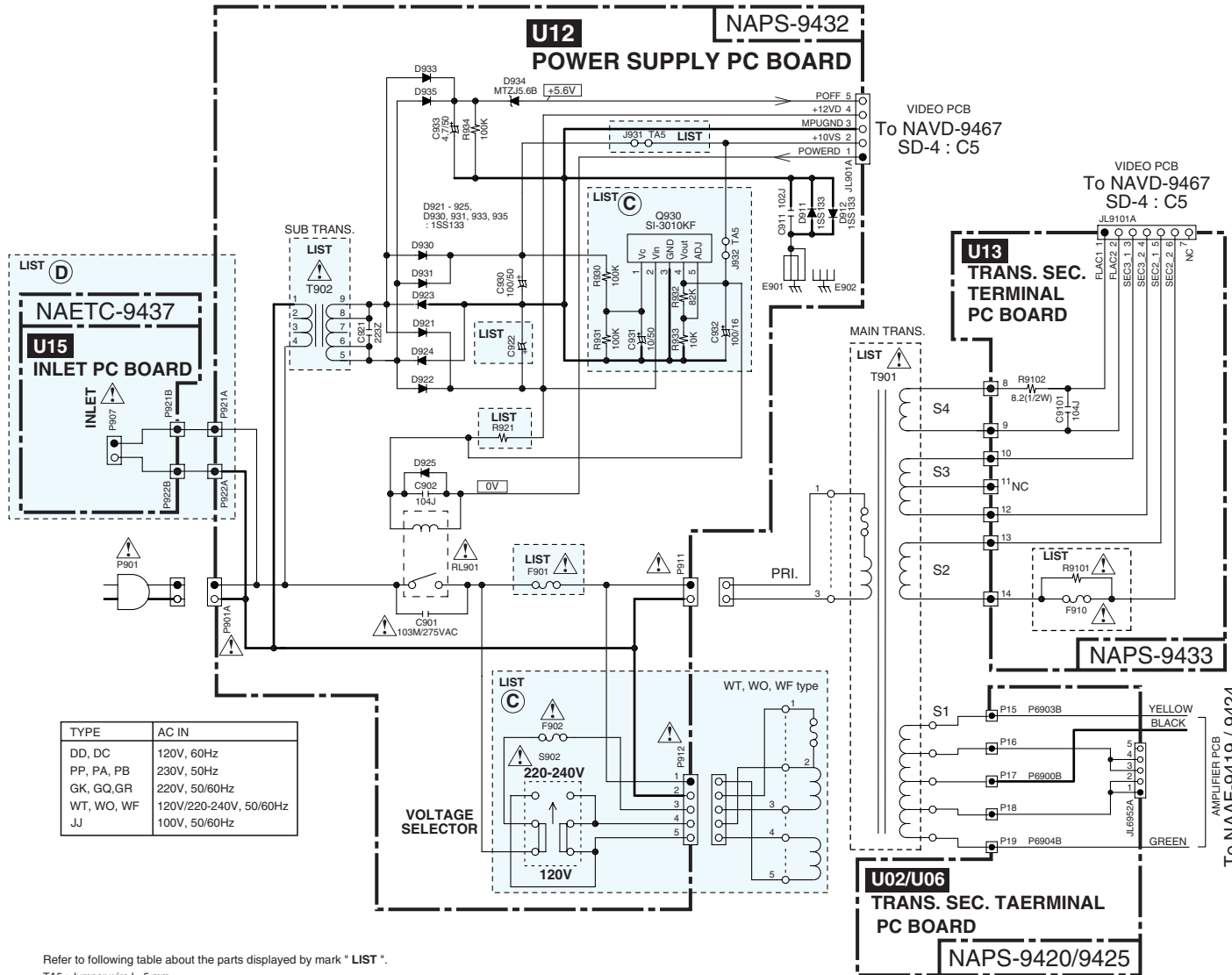

TYPE	AC IN
DD, DC	120V, 60Hz
PP, PA, PB	230V, 50Hz
GK, GQ, GR	220V, 50/60Hz
WT, WO, WF	120V/220-240V, 50/60Hz
JJ	100V, 50/60Hz

Refer to following table about the parts displayed by mark "LIST".  
TA5 : Jumper wire L=5 mm

4

	TX-SR506				HT-R518		HT-R560		TX-SR576		HT-R667		HT-R960		TX-SR606				TX-SA606X
	DD, DC	PP, PB	GK, GQ, GR	WT, WO, WF	PP	DD, DC	PP	DD, DC	PP, PA	DD	DC	PP	DD, DC	PP, PA, PB	GK, GQ, GR	WT, WO, WF	JJ		
(C)	None	None	None	Yes	None	None	None	None	None	None	None	None	None	None	None	Yes	None		
(D)	None				None		None		None		None		None				Yes		
T901	NPT-1516D	1516P	1516P	1516DG	1517P	1517D	1517P	1516D	1516P	1574D	1574D	1574P	1552D	1552P	1552G	1552DQ	1552J		
T902	NPT-1520JQ	1520GQ	1520GQ	1520JQ	1520GQ	1520JQ	1520GQ	1520JQ	1520GQ	1520JQ	1520JQ	1520GQ	1520JQ	1520GQ	1520GQ	1520JQ	1520JQ		
C922	2200/25	2200/16	2200/35	2200/35	2200/16	2200/25	2200/16	2200/25	2200/16	2200/25	2200/25	2200/16	2200/25	2200/16	2200/16	2200/35	2200/16		
R921	47(1/2W)				NC	47(1/2W)	47(1/2W)	47(1/2W)	47(1/2W)	47(1/2W)	47(1/2W)	47(1/2W)	47(1/2W)				NC		
R9101	0.1(1/2W)	0.22(1/W)		0.22(1/W)	0.1(1/2W)	0.1(1/2W)	0.22(1/W)	0.1(1/2W)	0.22(1/W)	0.1(1/2W)	0.1(1/2W)	0.22(1/W)	NC				NC		
F901	8A/125V		4A/250V		4A/250V	8A/125V	4A/250V	8A/125V	4A/250V	8A/125V	8A/125V	4A/250V	10A/250V	5A/250V		NC	12A/250V		
F902	NC				NC	NC	NC	NC	NC	NC	NC	NC	NC				NC		
F910	NC				NC	NC	NC	NC	NC	NC	NC	NC	5A/125V				5A/125V		
J931	TA5				NC	NC	NC	TA5	NC	NC	NC	NC	Yes				No		

5

**CAUTION**  
FOR CONTINUED PROTECTION AGAINST FIRE HAZARD, REPLACE ONLY WITH FUSE OF SAME TYPE AND RATING INDICATED.

**ATTENTION**  
AFIN D'ASSURER UNE PROTECTION PERMANENTE CONTRE LES RISQUES D'INCENDIE, REMPLACER UNIQUEMENT PAR UN FUSIBLE DE MEME TYPE ET CALIBRATION COMME INDIQUE.

**NOTE**  
THIS SYMBOL LOCATED NEAR THE FUSE INDICATES THAT THE FUSE USED IS SLOW OPERATING TYPE FOR CONTINUED PROTECTION AGAINST FIRE HAZARD. REPLACE WITH SAME TYPE FUSE. FOR FUSE RATING REFER TO THE MARKING ADJACENT TO THE SYMBOL.

CE SYMBOLE INDIQUE QUE LE FUSIBLE UTILISE EST LE LENT. POUR UNE PROTECTION PERMANENTE, UTILISER QUE DES FUSIBLES DE MEME TYPE. CE DERNIER EST INDIQUE LA OU LE PRESENT SYMBOLE EST APPOSE.

**NOTE**

- THE COMPONENTS IDENTIFIED BY MARK ARE CRITICAL FOR SAFETY REPLACE ONLY WITH PART NUMBER SPECIFIED.
- VOLTAGE (MEASURED WITH VOLTMETER) IS DC VOLTAGE. (No INPUT SIGNAL).
- ALL PNP TRANSISTORS ARE EQUIVALENT TO 2SA1015-GR UNLESS OTHERWISE NOTED.
- ALL NPN TRANSISTORS ARE EQUIVALENT TO 2SC1815-GR UNLESS OTHERWISE NOTED.
- ALL DIODES ARE EQUIVALENT TO 1SS133 UNLESS OTHERWISE NOTED.
- ELECTROLYTIC CAPACITORS ( ) ARE IN uF/WV.
- ALL CAPACITORS ARE IN pF/50WV UNLESS OTHERWISE NOTED.
- EX) 030- 3pF 330- 33pF 331- 330pF 333- 0.033uF
- ALL RESISTORS ARE IN OHMS 1/4WATTS UNLESS OTHERWISE NOTED.
- THE THICK LINES ON PC BOARD ARE THE PRINTING SIDE OF THE PARTS.
- EX) PRINTING SIDE
- CIRCUIT IS SUBJECT TO CHANGE FOR IMPROVEMENT.

AMPLIFIER PCB  
To NAAF-9419 / 9424  
SD-2 : A5

E F G H

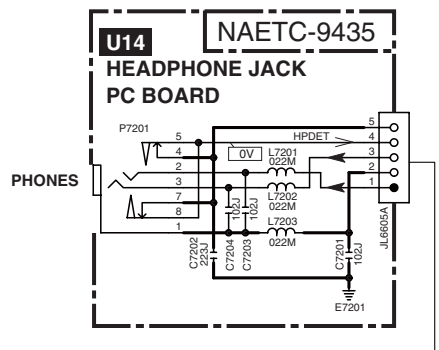

AUDIO ANALOG SIGNAL  
 — FRONT L  
 — FRONT R

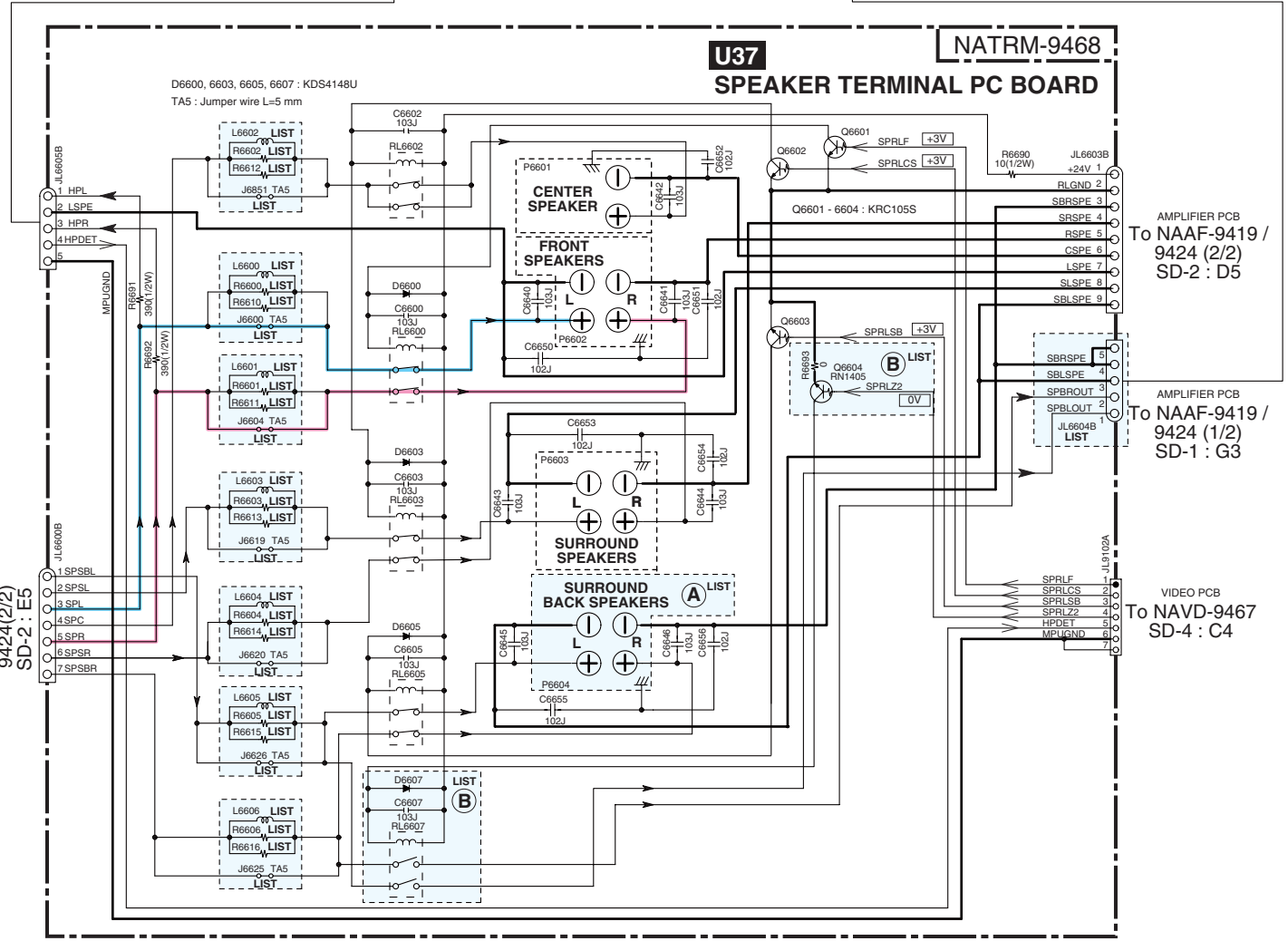
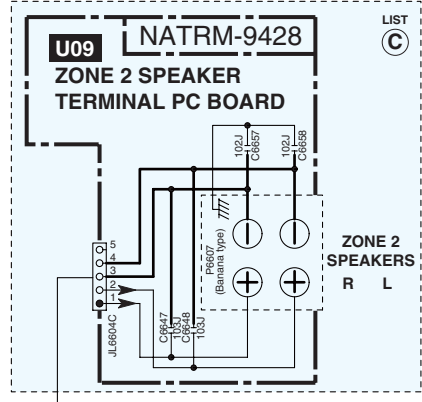

Refer to following table about the parts displayed by mark "LIST".

	TX-SR506			HT-R518	HT-R560	TX-SR576		HT-R667	HT-R960	TX-SR606			TX-SA606X		
	DD, DC	PP, PB	GK, GQ, GR	WT, WO, WF	PP	DD, DC	PP	DD, DC	DC	PP	DD, DC	PP, PA	GK, GQ, GR	WT, WO, WF	JJ
L6600 - 6604	None		S-1.3C	S1.3C	None	S-1.3C	None	S-1.3C	None	None	S-1.3C	None	S-1.3C	None	None
L6605, 6606	None		S-1.3C	None	None	S-1.3C	None	S-1.3C	None	None	S-1.3C	None	S-1.3C	None	None
R6600 - 6606, R6610 - 6616	None	22		22	None	22	None	22	None	None	22	None	22	None	None
R6605, 6606, R6615, 6616	None	22		None	None	22	None	22	None	None	22	None	22	None	None
J6600, 6604, J6619, 6620, J6625, 6626, 6851	TA5		None	None	Yes	None	Yes	None	None	Yes	None	Yes	None	None	Yes
JL6604	Yes			None	Yes		Yes		Yes	Yes		Yes		None	None
(A)	Yes			None	Yes		Yes		Yes	Yes		Yes		Yes	Yes
(B)	None			None	None		Yes		None	None		Yes		None	None
(C)	None			None	None		None		None	None	No	Yes		None	None



**A B C D**

**SCHEMATIC DIAGRAMS-6 (SD-6)  
DISPLAY SECTION**

**NOTE**

- THE COMPONENTS IDENTIFIED BY MARK  $\Delta$  ARE CRITICAL FOR SAFETY. REPLACE ONLY WITH PART NUMBER SPECIFIED.
- VOLTAGE (MEASURED WITH VOLTMETER)  $\square$  IS DC VOLTAGE. (NO INPUT SIGNAL).
- ALL PNP TRANSISTORS ARE EQUIVALENT TO 2SA1015-GR UNLESS OTHERWISE NOTED.
- ALL NPN TRANSISTORS ARE EQUIVALENT TO 2SC1815-GR UNLESS OTHERWISE NOTED.
- ALL DIODES ARE EQUIVALENT TO 1SS133 UNLESS OTHERWISE NOTED.
- ELECTROLYTIC CAPACITORS (  $\text{---}$  ) ARE IN  $\mu$ F/WV.
- ALL CAPACITORS ARE IN pF/50WV UNLESS OTHERWISE NOTED.
- EX) 030- 3pF 330- 33pF 331- 330pF 333- 0.033uF
- ALL RESISTORS ARE IN OHMS 1/4WATTS UNLESS OTHERWISE NOTED.
- THE THICK LINES ON PC BOARD ARE THE PRINTING SIDE OF THE PARTS.
- EX)  $\square$  PRINTING SIDE
- CIRCUIT IS SUBJECT TO CHANGE FOR IMPROVEMENT.

**<Note>**

NC = No mount of parts.  
SD-Z : XY  
Location of connected terminal in schematic diagrams.  
SD-Z = Schematic diagrams-Z. X = A to H, Y = 1 to 5.

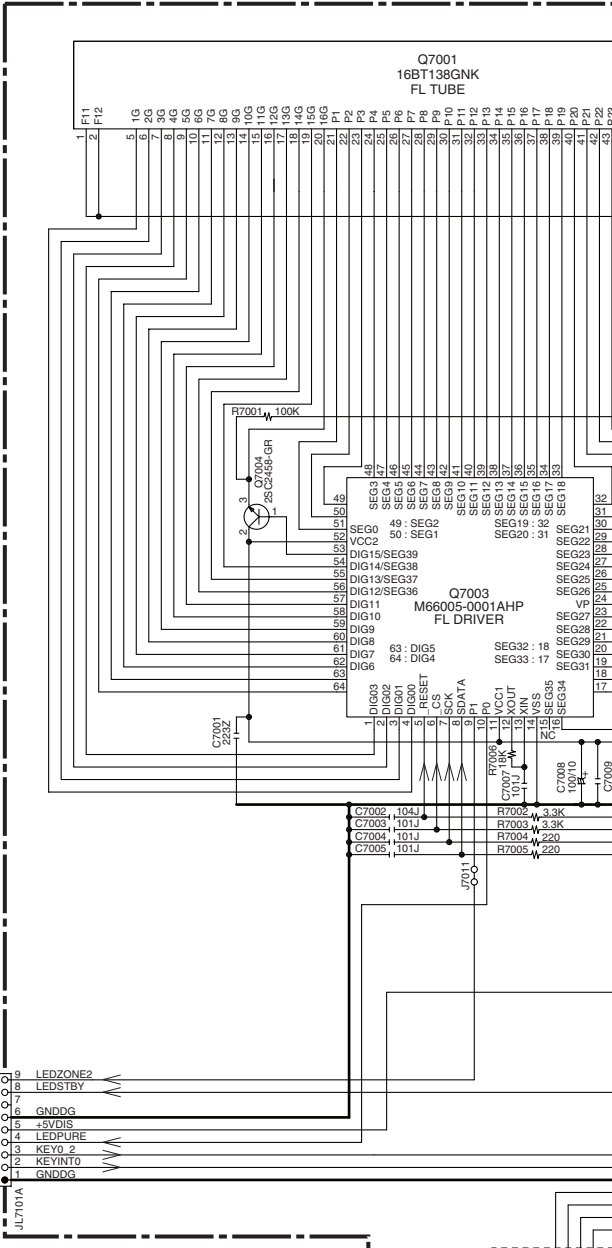
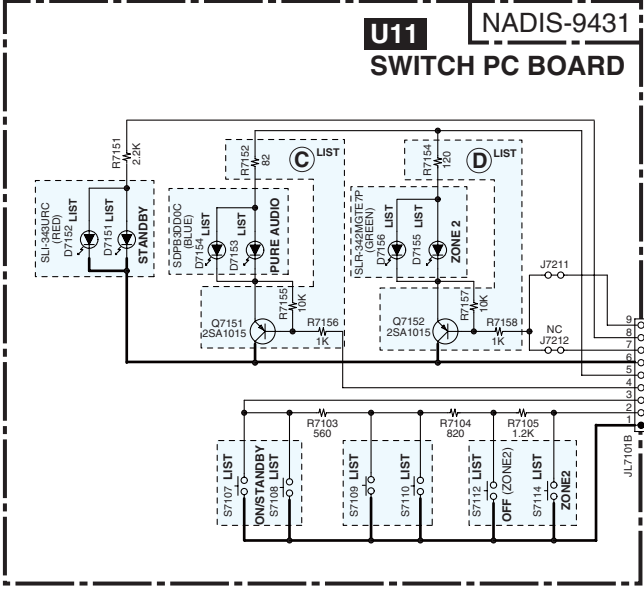

Refer to following table about the parts displayed by mark "LIST".

	TX-SR506			HT-R518	HT-R560	TX-SR576		HT-R667	HT-R960			TX-SR606				TX-SA606X
	DD, DC	PP, PB	GK, GQ, GR	WT, WO, WF	PP	DD, DC	PP, PA	DD	DC	PP	DD, DC	PP, PA	GK, GQ, GR	WT, WO, WF	JJ	
D7151		Yes			Yes	Yes	Yes	Yes	Yes	Yes			None		None	
D7152		None			None	None	None	None	None	None			Yes		Yes	
D7153	None	Yes			Yes	None	Yes	Yes	None	Yes			None		None	
D7154		None			None	None	None	None	None	None			Yes	Yes	Yes	
D7155		None			None	None	None	None	None	None			Yes		None	
D7156		Yes			None	None	Yes	None	None	None			None		None	
(A)		Yes			Yes	Yes	Yes	Yes	Yes	Yes			None		None	
(B)		None			None	None	None	None	None	None			Yes		Yes	
(C)	None	Yes			Yes	None	None	None	None	None			Yes	Yes	Yes	
(D)		Yes			None	None	Yes	None	None	None			Yes		None	
S7001, S7107		Yes			Yes	Yes	Yes	Yes	Yes	Yes			None		None	
S7002, S7108		None			None	None	None	None	None	None			Yes		Yes	
S7109		MUSIC OPTIMIZER	PURE AUDIO		PURE AUDIO	DOCK	MUSIC OPTIMIZER	PURE AUDIO	DOCK				None		None	
S7110		None			None	None	None	None	None	None			Yes		Yes	
S7112, S7114		None			None	None	None	None	None	None			Yes		None	

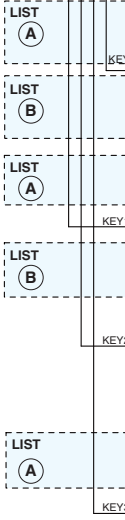

**U10** NADIS-9430  
**DISPLAY PC BOARD**

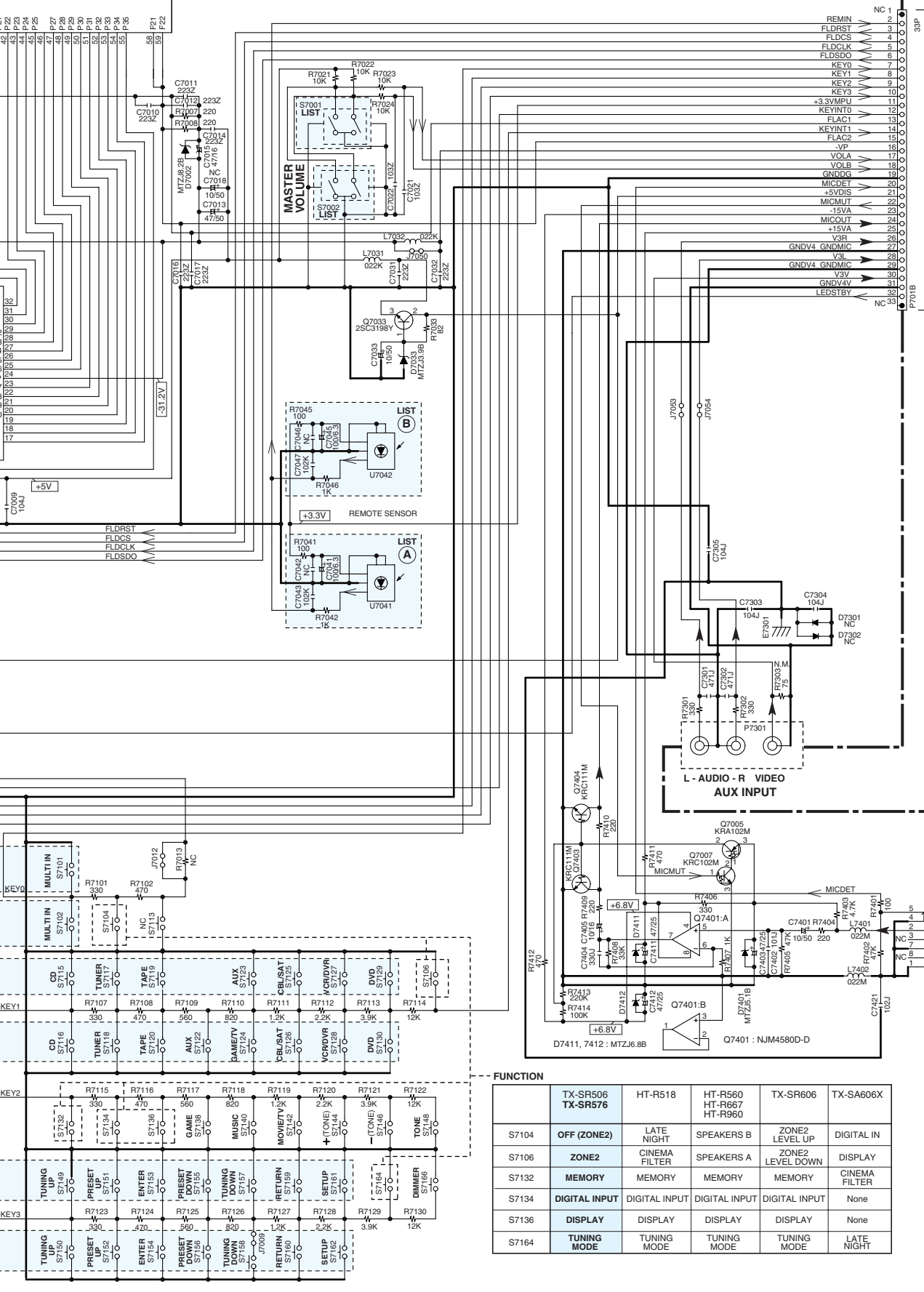

MICROPROCESSOR PCB  
To NADG-9457  
/9462  
SD-3 : A2

**FUNCTION**

	TX-SR506 TX-SR576	HT-R518	HT-R560 HT-R667 HT-R667	TX-SR606	TX-SA606X
S7104	OFF (ZONE2)	LATE NIGHT	SPEAKERS B	ZONE2 LEVEL UP	DIGITAL IN
S7106	ZONE2	CINEMA FILTER	SPEAKERS A	ZONE2 LEVEL DOWN	DISPLAY
S7132	MEMORY	MEMORY	MEMORY	MEMORY	CINEMA FILTER
S7134	DIGITAL INPUT	DIGITAL INPUT	DIGITAL INPUT	DIGITAL INPUT	None
S7136	DISPLAY	DISPLAY	DISPLAY	DISPLAY	None
S7164	TUNING MODE	TUNING MODE	TUNING MODE	TUNING MODE	LATE NIGHT



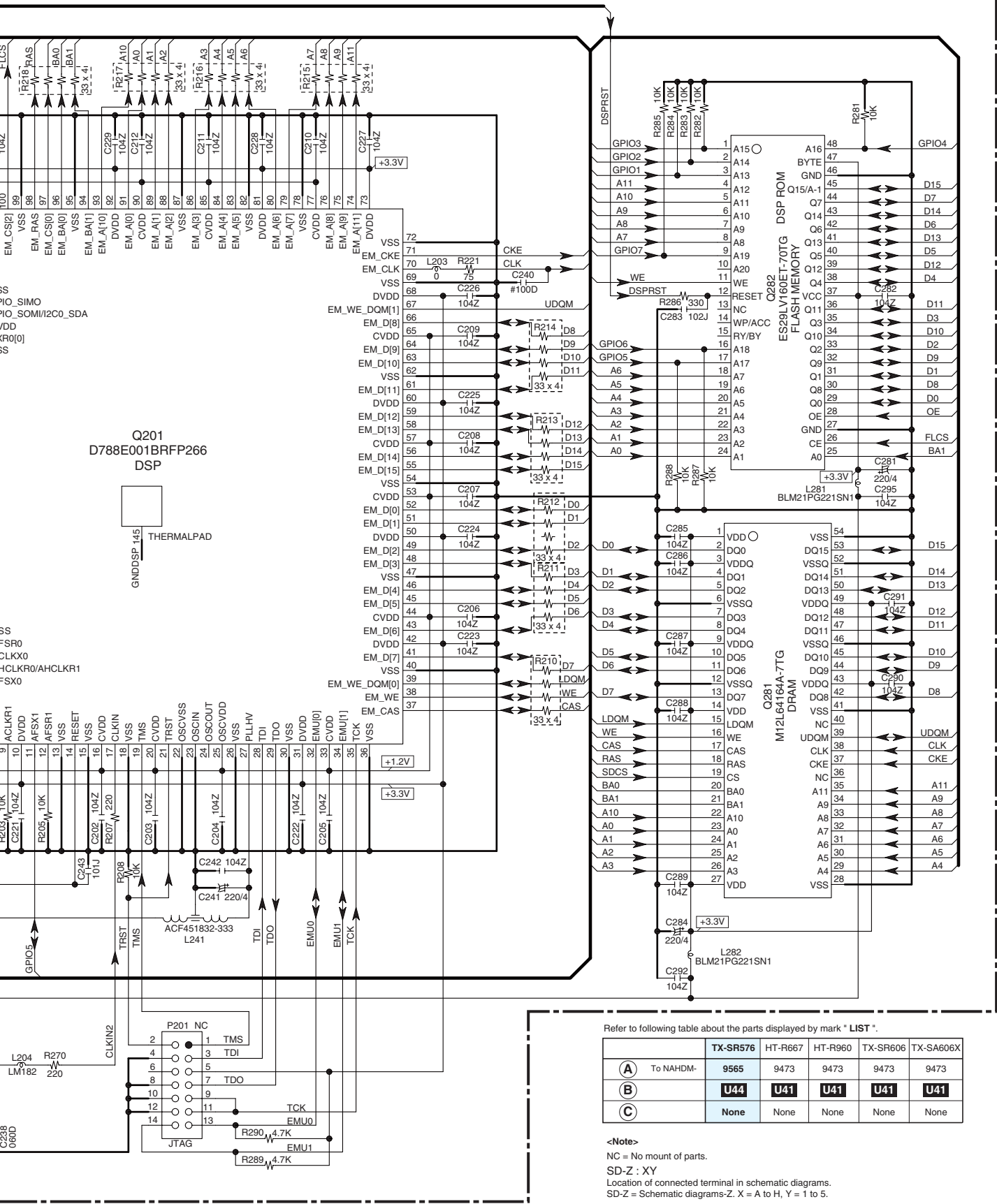

Refer to following table about the parts displayed by mark "LIST".

	TX-SR576	HT-R667	HT-R960	TX-SR606	TX-SA606X
(A)	To NAHDM-	9565	9473	9473	9473
(B)		U44	U41	U41	U41
(C)		None	None	None	None

<Note>  
 NC = No mount of parts.  
 SD-Z : XY  
 Location of connected terminal in schematic diagrams.  
 SD-Z = Schematic diagrams-Z. X = A to H, Y = 1 to 5.

# SCHEMATIC DIAGRAMS-8 (SD-8) HDMI SECTION

1

2

3

4

5

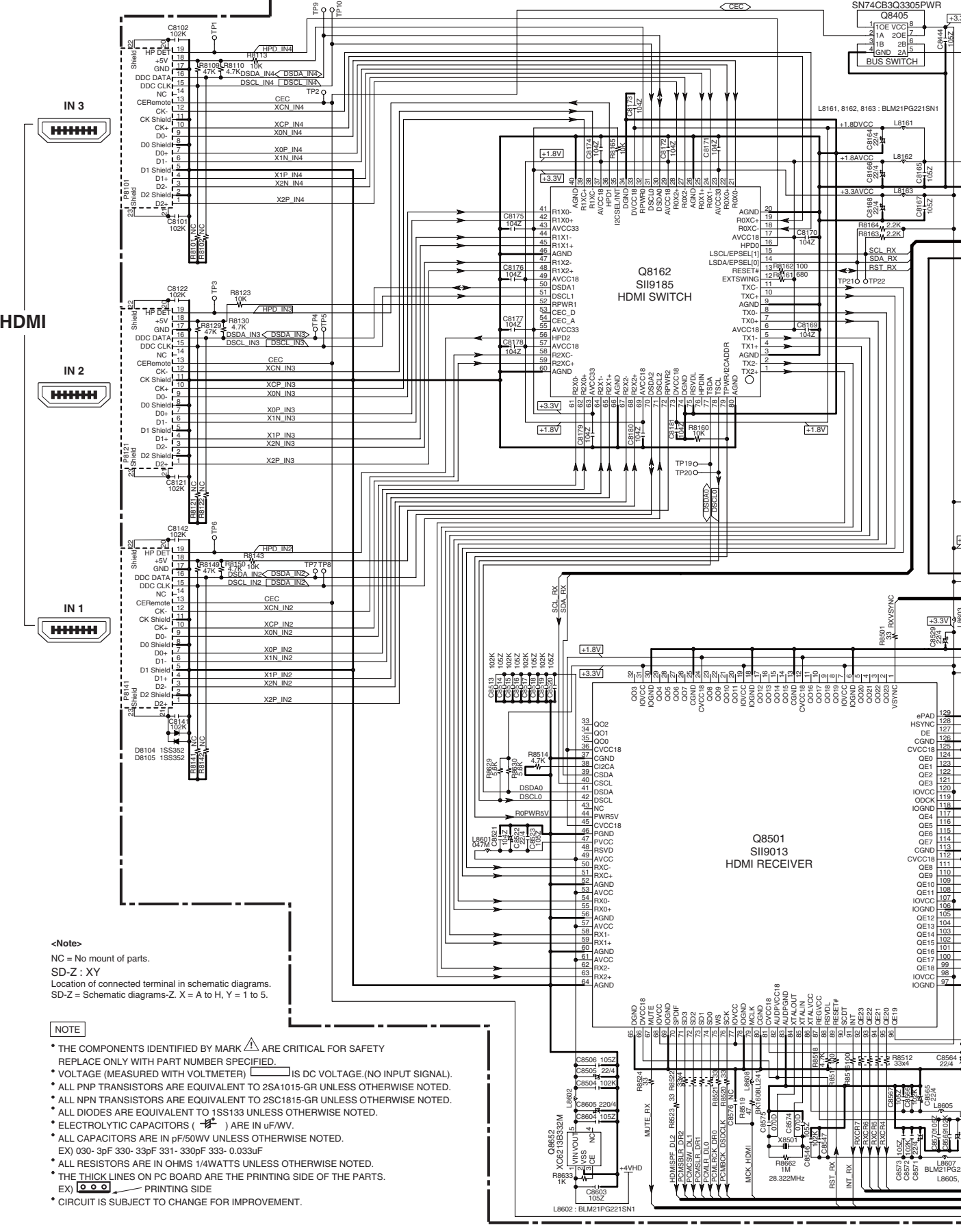

**<Note>**  
 NC = No mount of parts.  
 SD-Z : XY  
 Location of connected terminal in schematic diagrams.  
 SD-Z = Schematic diagrams-Z. X = A to H, Y = 1 to 5.

- NOTE**
- THE COMPONENTS IDENTIFIED BY MARK ARE CRITICAL FOR SAFETY. REPLACE ONLY WITH PART NUMBER SPECIFIED.
  - VOLTAGE (MEASURED WITH VOLTMETER) IS DC VOLTAGE.(NO INPUT SIGNAL).
  - ALL PNP TRANSISTORS ARE EQUIVALENT TO 2SA1015-GR UNLESS OTHERWISE NOTED.
  - ALL NPN TRANSISTORS ARE EQUIVALENT TO 2SC1815-GR UNLESS OTHERWISE NOTED.
  - ALL DIODES ARE EQUIVALENT TO 1SS133 UNLESS OTHERWISE NOTED.
  - ELECTROLYTIC CAPACITORS ( ) ARE IN uF/WV.
  - ALL CAPACITORS ARE IN pF/50WV UNLESS OTHERWISE NOTED.  
 EX) 030-3pF 330-33pF 331-330pF 333-0.033uF
  - ALL RESISTORS ARE IN OHMS 1/4WATT UNLESS OTHERWISE NOTED.
  - THE THICK LINES ON PC BOARD ARE THE PRINTING SIDE OF THE PARTS.  
 EX) PRINTING SIDE
  - CIRCUIT IS SUBJECT TO CHANGE FOR IMPROVEMENT.

L8602 : BLM21PG221SN1

MICROPROCESSOR PCB  
To NADGx-9462  
SD-3 : D1

**U44** NAHDM-9565 (2/2)  
**DSP / HDMI PC BOARD**

DSP / HDMI PCB  
To DSP SECTION  
NAHDM-9565 (1/2)  
SD-7 : A1

To NAVD-9467  
SD-4 : H3

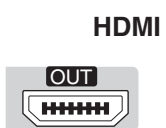
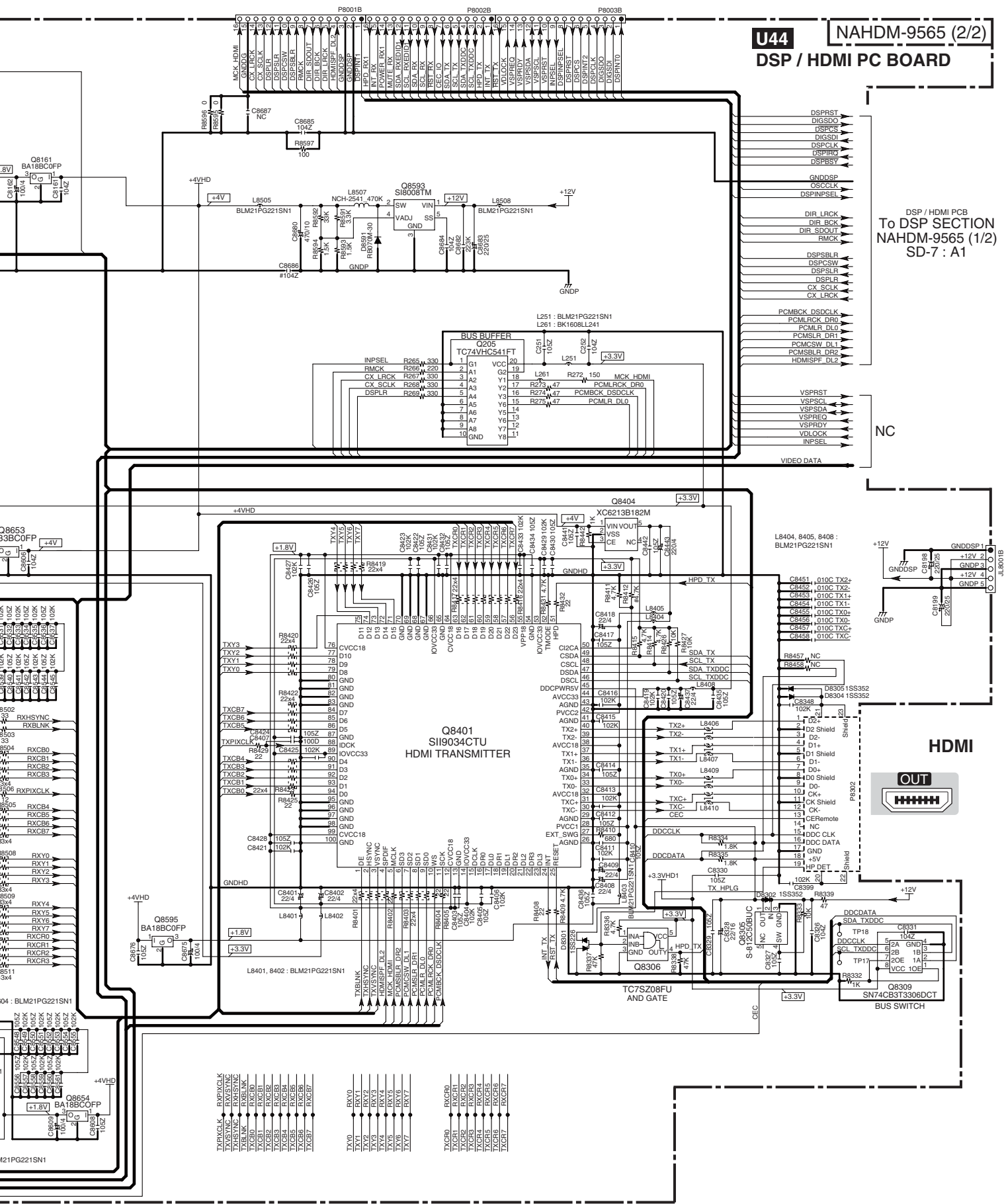

**HDMI**



OUT



TX+, TX-, TX0+, TX0-, TX1+, TX1-, TX0+, TX0-, TXC+, TXC-, TXC, TXC, EXT\_SWG, AGND

TX+, TX-, TX0+, TX0-, TX1+, TX1-, TX0+, TX0-, TXC+, TXC-, TXC, TXC, EXT\_SWG, AGND

TX+, TX-, TX0+, TX0-, TX1+, TX1-, TX0+, TX0-, TXC+, TXC-, TXC, TXC, EXT\_SWG, AGND

TX+, TX-, TX0+, TX0-, TX1+, TX1-, TX0+, TX0-, TXC+, TXC-, TXC, TXC, EXT\_SWG, AGND

TX+, TX-, TX0+, TX0-, TX1+, TX1-, TX0+, TX0-, TXC+, TXC-, TXC, TXC, EXT\_SWG, AGND

TX+, TX-, TX0+, TX0-, TX1+, TX1-, TX0+, TX0-, TXC+, TXC-, TXC, TXC, EXT\_SWG, AGND

TX+, TX-, TX0+, TX0-, TX1+, TX1-, TX0+, TX0-, TXC+, TXC-, TXC, TXC, EXT\_SWG, AGND

TX+, TX-, TX0+, TX0-, TX1+, TX1-, TX0+, TX0-, TXC+, TXC-, TXC, TXC, EXT\_SWG, AGND

TX+, TX-, TX0+, TX0-, TX1+, TX1-, TX0+, TX0-, TXC+, TXC-, TXC, TXC, EXT\_SWG, AGND

TX+, TX-, TX0+, TX0-, TX1+, TX1-, TX0+, TX0-, TXC+, TXC-, TXC, TXC, EXT\_SWG, AGND

TX+, TX-, TX0+, TX0-, TX1+, TX1-, TX0+, TX0-, TXC+, TXC-, TXC, TXC, EXT\_SWG, AGND

TX+, TX-, TX0+, TX0-, TX1+, TX1-, TX0+, TX0-, TXC+, TXC-, TXC, TXC, EXT\_SWG, AGND

TX+, TX-, TX0+, TX0-, TX1+, TX1-, TX0+, TX0-, TXC+, TXC-, TXC, TXC, EXT\_SWG, AGND

TX+, TX-, TX0+, TX0-, TX1+, TX1-, TX0+, TX0-, TXC+, TXC-, TXC, TXC, EXT\_SWG, AGND

TX+, TX-, TX0+, TX0-, TX1+, TX1-, TX0+, TX0-, TXC+, TXC-, TXC, TXC, EXT\_SWG, AGND

# PACKING PROCEDURE

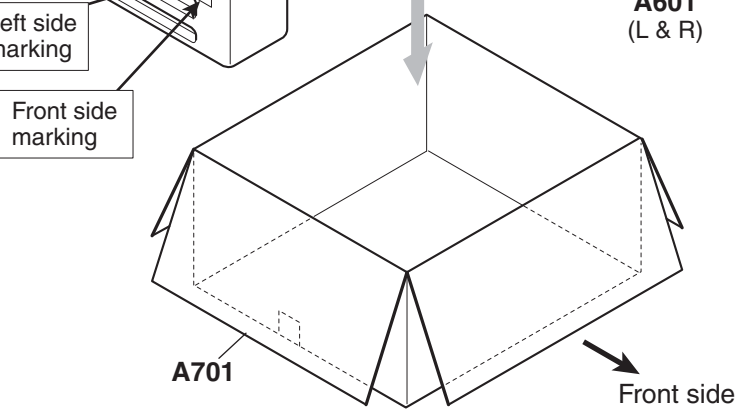
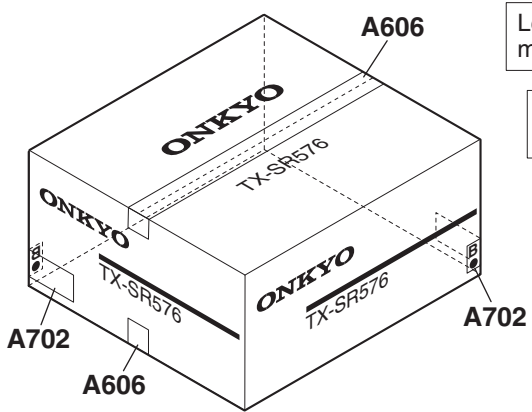
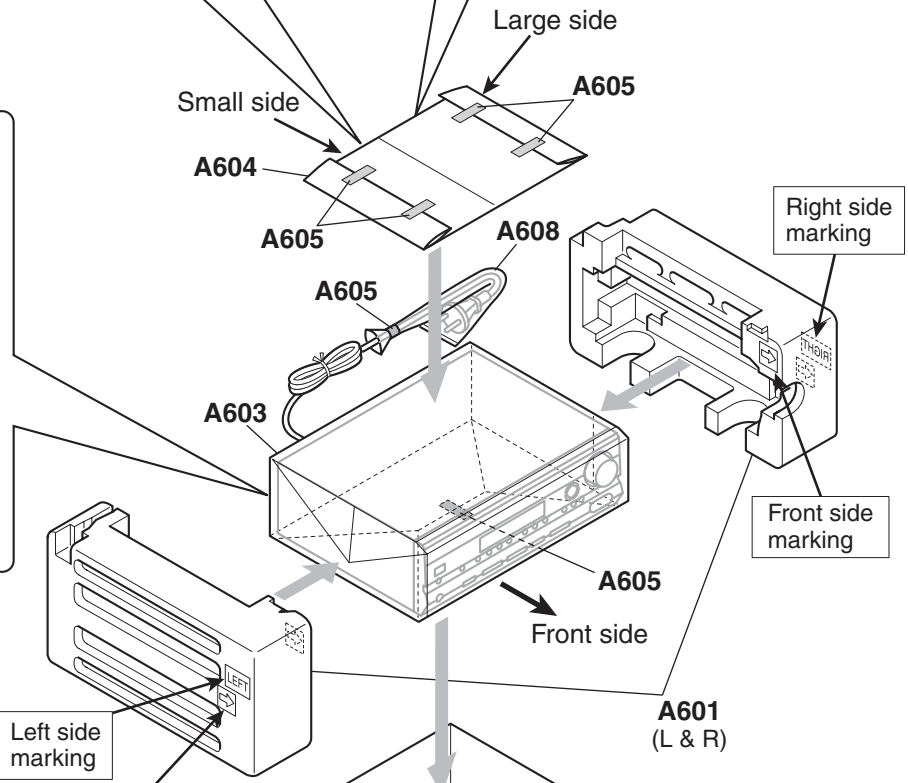
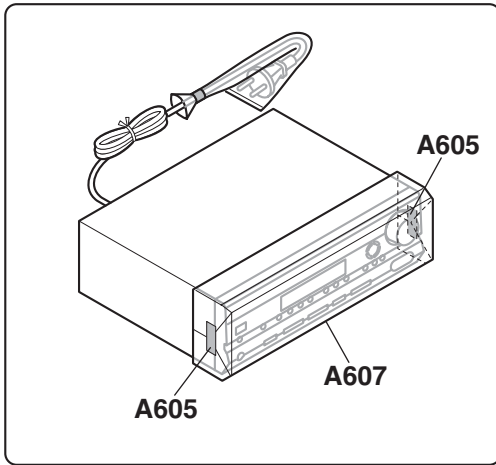
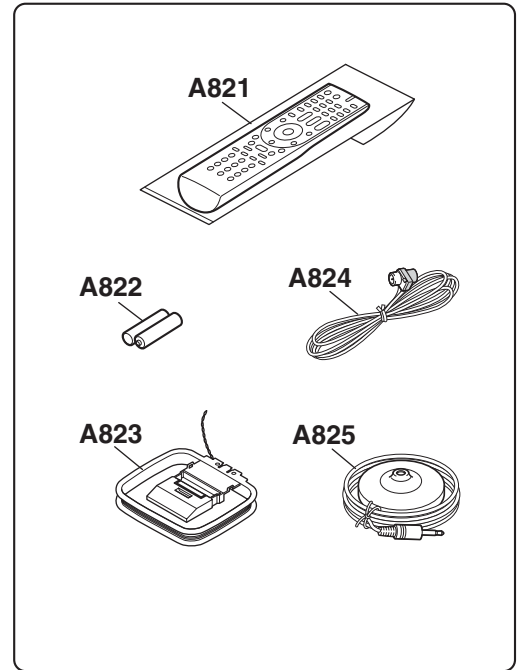
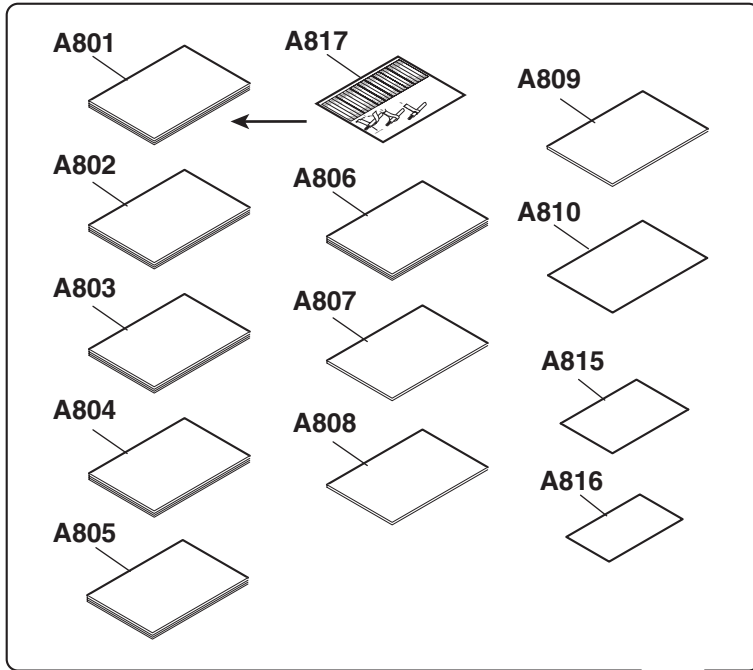

**TX-SR576****<Note>**

Parts marked by "NSP" are generally unavailable because they are not in our Master Spare Parts List.

**NOTE : THE COMPONENTS IDENTIFIED BY THE MARK  
! ARE CRITICAL FOR RISK OF FIRE AND  
ELECTRIC SHOCK. REPLACE ONLY WITH PART  
NUMBER SPECIFIED.**

**<Notes>**

(B) : Black model

(S) : Silver model

&lt;DD&gt; : USA model

&lt;DC&gt; : Canadian model

&lt;PP&gt; : European model

&lt;PA&gt; : Australian model

**EXPLODED VIEW PARTS LIST**

	REF. NO.	PART NAME	DESCRIPTION	Q'TY	PART NO. (SN)	REMARKS
EV	A001	CHASSIS	(FRONT)	1	27100513A	
EV	A002	SCREW	3TTB+8B(3CM)SR	5	801637	
EV	A003	B PLATE	---	1	28133425	(B)
EV	A003	B PLATE	---	1	28133426	(S)
EV	A004	RETAINER	(F)	1	27142099	
EV	A005	SCREW	3TTB+8B(3CM)SR	2	801637	
EV	A011	SCREW	2.6TTB+8B(3BC)	18	838426088GR	
EV	A012	SCREW	2.6TTB+8B(3BC)	3	838426088GR	
EV	A013	WIRE TIE	BSK-1	8	260208	
EV	A016	SCREW	3TTB+8B(3CM)SR	1	801637	
EV	A018	HOLDER	KGLS-22S	3	27190369	
EV	A019	HOLDER	KGLS-14S	1	27190164	
EV	A020	HOLDER	KGLS-16RT	2	27190511	
EV	A021	HOLDER	KGPS-16RF	5	27190991	



EV	A022	HOLDER	KGLS-10RT	1	27190428A	
EV	A030	SCREW	4TTC+8C(3BC)	4	830440089GR	
EV	A031	SPACER	---	1	27270439	
EV	A033	LABEL	(PT)	1	29363379-1	
EV	A035	HOLDER	KGLS-14RT	1	27190524	
EV	A037	BUSHING	S-RELIEF #2271	1	27300750	!
EV	A039	TAPE	TAPE(CLOTH-16U)	(1)	29110083	
EV	A040	HEAT SINK	(AS)	1	27160602A	
EV	A041	BRACKET	(HT-L)	1	27131016B	
EV	A042	BRACKET	(HT-R)	1	27131017A	
EV	A043	SCREW	3TTB+8B(3CM)SR	4	801637	
EV	A044	SCREW	3TTB+8B(3CM)SR	4	801637	
EV	A046	SCREW	3TTB+8B(3CM)SR	2	801637	
EV	A047	SCREW	3TTB+8B(3CM)SR	2	801637	
EV	A048	SCREW	3TTB+8B(3CM)SR	1	801637	
EV	A049	SCREW	3SMS8W.SW+14B(CU)	14	801634	
EV	A050	IB CUSHION	W15 x 3t TAPE	1	28141585	
EV	A052	SCREW	3TTB+8B(3CM)SR	1	801637	
EV	A055	KNOB	(VOL) BLACK	1	28326514	(B)
EV	A055	KNOB	(VOL) SILVER	1	28326515	(S)
EV	A060	COVER	(B)	1	28210010	(B)
EV	A060	COVER	(S)	1	28210011	(S)
EV	A061	SCREW	3TTB+8B(3BC)	6	838430088GR	(B)
EV	A061	SCREW	3TTB+8B(3CM)SR	6	801637	(S)
EV	A062	CUSHION	---	2	28141681	
EV	A066	BOTTOM LEG	TX-SR506	4	27175441	
EV	A068	WASHER	W3 x 8F(3CM)	8	87613008GR	
EV	A067	SCREW	3TTB+10B(3BC)	4	838430108GR	
EV	A071	CUSHION	---	3	28141688	
EV	A072	CHASSIS	506	1	---	
EV	A073	F PANEL	(B)MDD/576	1	27213081A	(B) <DD, DC>
EV	A073	F PANEL	(B)MPP/576	1	27213083A	(B) <PP>
EV	A073	F PANEL	(B)MPA/576	1	27213085A	(B) <PA>

EV	A073	F PANEL	(S)MDC/576	1	27213082A	(S) <DD>
EV	A073	F PANEL	(S)MPP/576	1	27213084A	(S) <PP>
EV	A073	F PANEL	(S)MPA/576	1	27213086A	(S) <PA>
EV	A074	KNOB	(PRE)/B	1	28326618	(B)
EV	A074	KNOB	(PRE)/S	1	28326619	(S)
EV	A075	KNOB	(A)/B	1	28326615	(B)
EV	A075	KNOB	(A)/S	1	28326616	(S)
EV	A076	KNOB	(STNBY)/B	1	28326621	(B)
EV	A076	KNOB	(STNBY)/S	1	28326622	(S)
EV	A077	BADGE	---	1	28135244	(B)
EV	A077	BADGE	---	1	28135298	(S)
EV	A083	CLEAR PLT	TX-SR576(B)DD	1	28192191	<DD, DC>
EV	A083	CLEAR PLT	TX-SR506(B)PP	1	28192192	<PP, PA>
EV	A089	SCREW	3TTB+8B(3BC)	3	838430088GR	
EV	A093	REAR PANEL	TX-SR576MDD/MDC	1	27123796	<DD, DC>
EV	A093	REAR PANEL	TX-SR576MPP/MPA	1	27123797	<PP>
EV	A093	REAR PANEL	TX-SR576MPP/MPA	1	27123797	<PA>
EV	A096	SCREW	3P+6FN(3BC)	4	82143006GR	
EV	A097	SCREW	3TTB+8B(3BC)	31	838430088GR	
EV	A102	LABEL	(COVER)	1	29364123	
EV	A103	LABEL	(SP)	1	29390249	
EV	A104	LABEL	(SP_RE)TX-SR506	1	29390384	
EV	A109	LABEL	HOOKUP-ONKYO	1	29363194	<DD, DC>
EV	F901	FUSE	8A-UL/T-233	1	252329GR	!, <DD, DC>
EV	F901 or	FUSE	8A-T/UL-ST2	(1)	252261GR	!, <DD, DC>
EV	F901	FUSE	4A-SE-EAK FUSE	1	252077GR	!, <PP, PA>
EV	F901 or	FUSE	4A-SE-TL250V	(1)	252277GR	!, <PP, PA>
EV	F901C	LABEL	T4AL250V	1	29361732A	!, <PP, PA>
EV	P101	FFC	NCFC7-132512	1	2047132512	
EV	P6601A	P RIVET	JB-407A-C	14	880052	<PP, PA>
EV	P701	FFC	NCFC7-332512	1	2047332512	
EV	F6901	FUSE	10A-UL/T-233	1	252330GR	
EV	F6901 or	FUSE	10A-T/UL-ST2	(1)	252333GR	

EV	F6902	FUSE	10A-UL/T-233	1	252330GR	
EV	F6902 or	FUSE	10A-T/UL-ST2	(1)	252333GR	
EV	P901	AC CORD	AS-UC-2	1	253333VOL	!, <DD, DC>
EV	P901 or	AC CORD	AS-UC-2	(1)	253368AYUN	!, <DD, DC>
EV	P901 or	AC CORD	AS-UC-2	(1)	253368BLTK	!, <DD, DC>
EV	P901 or	AC CORD	AS-UC-2	(1)	253368HSN	!, <DD, DC>
EV	P901	AC CORD	AS-SAA	1	253388LTK	!, <PA>
EV	P901 or	AC CORD	AS-SAA	(1)	253388LON	!, <PA>
EV	P901	AC CORD	AS-CEE-2	1	253306VOL	!, <PP>
EV	P901 or	AC CORD	AS-CEE-2	(1)	253374YUN	!, <PP>
EV	Q6050	TR	MN130S-P	1	2203666	!, <DD, DC, PA>
EV	Q6050 or	TR	2SC5198-R	(1)	2203062	!, <DD, DC, PA>
EV	Q6050 or	TR	2SC5198-O	(1)	2203063	!, <DD, DC, PA>
EV	Q6050 or	TR	MN130S-O	(1)	2203663	!, <DD, DC, PA>
EV	Q6050 or	TR	MN130S-Y	(1)	2203664	!, <DD, DC, PA>
EV	Q6050	TR	2SC5198-O	1	2203063	!, <PP>
EV	Q6050 or	TR	2SC5198-R	(1)	2203062	!, <PP>
EV	Q6050A	ISO SHEET	AC238	2	223024	
EV	Q6050B	ISO SHEET	ISO SHEET	6	223041	
EV	Q6051	TR	MN130S-P	1	2203666	!, <DD, DC, PA>
EV	Q6051 or	TR	2SC5198-R	(1)	2203062	!, <DD, DC, PA>
EV	Q6051 or	TR	2SC5198-O	(1)	2203063	!, <DD, DC, PA>
EV	Q6051 or	TR	MN130S-O	(1)	2203663	!, <DD, DC, PA>
EV	Q6051 or	TR	MN130S-Y	(1)	2203664	!, <DD, DC, PA>
EV	Q6051	TR	2SC5198-O	1	2203063	!, <PP>
EV	Q6051 or	TR	2SC5198-R	(1)	2203062	!, <PP>
EV	Q6052	TR	MN130S-P	1	2203666	!, <DD, DC, PA>
EV	Q6052 or	TR	2SC5198-R	(1)	2203062	!, <DD, DC, PA>
EV	Q6052 or	TR	2SC5198-O	(1)	2203063	!, <DD, DC, PA>
EV	Q6052 or	TR	MN130S-O	(1)	2203663	!, <DD, DC, PA>
EV	Q6052 or	TR	MN130S-Y	(1)	2203664	!, <DD, DC, PA>
EV	Q6052	TR	2SC5198-O	1	2203063	!, <PP>
EV	Q6052 or	TR	2SC5198-R	(1)	2203062	!, <PP>

EV	Q6053	TR	MN130S-P	1	2203666	!, <DD, DC, PA>
EV	Q6053 or	TR	2SC5198-R	(1)	2203062	!, <DD, DC, PA>
EV	Q6053 or	TR	2SC5198-O	(1)	2203063	!, <DD, DC, PA>
EV	Q6053 or	TR	MN130S-O	(1)	2203663	!, <DD, DC, PA>
EV	Q6053 or	TR	MN130S-Y	(1)	2203664	!, <DD, DC, PA>
EV	Q6053 or	TR	KTC5242A-R	(1)	2203952	!, <DD, DC, PA>
EV	Q6053 or	TR	KTC5242A-O	(1)	2203953	!, <DD, DC, PA>
EV	Q6053	TR	2SC5198-O	1	2203063	!, <PP>
EV	Q6053 or	TR	2SC5198-R	(1)	2203062	!, <PP>
EV	Q6054	TR	MN130S-P	1	2203666	!, <DD, DC, PA>
EV	Q6054 or	TR	2SC5198-R	(1)	2203062	!, <DD, DC, PA>
EV	Q6054 or	TR	2SC5198-O	(1)	2203063	!, <DD, DC, PA>
EV	Q6054 or	TR	MN130S-O	(1)	2203663	!, <DD, DC, PA>
EV	Q6054 or	TR	MN130S-Y	(1)	2203664	!, <DD, DC, PA>
EV	Q6054 or	TR	KTC5242A-R	(1)	2203952	!, <DD, DC, PA>
EV	Q6054 or	TR	KTC5242A-O	(1)	2203953	!, <DD, DC, PA>
EV	Q6054	TR	2SC5198-O	1	2203063	!, <PP>
EV	Q6054 or	TR	2SC5198-R	(1)	2203062	!, <PP>
EV	Q6055	TR	MN130S-P	1	2203666	!, <DD, DC, PA>
EV	Q6055 or	TR	2SC5198-R	(1)	2203062	!, <DD, DC, PA>
EV	Q6055 or	TR	2SC5198-O	(1)	2203063	!, <DD, DC, PA>
EV	Q6055 or	TR	MN130S-O	(1)	2203663	!, <DD, DC, PA>
EV	Q6055 or	TR	MN130S-Y	(1)	2203664	!, <DD, DC, PA>
EV	Q6055 or	TR	KTC5242A-R	(1)	2203952	!, <DD, DC, PA>
EV	Q6055 or	TR	KTC5242A-O	(1)	2203953	!, <DD, DC, PA>
EV	Q6055	TR	2SC5198-O	1	2203063	!, <PP>
EV	Q6055 or	TR	2SC5198-R	(1)	2203062	!, <PP>
EV	Q6056	TR	MN130S-P	1	2203666	!, <DD, DC, PA>
EV	Q6056 or	TR	2SC5198-R	(1)	2203062	!, <DD, DC, PA>
EV	Q6056 or	TR	2SC5198-O	(1)	2203063	!, <DD, DC, PA>
EV	Q6056 or	TR	MN130S-O	(1)	2203663	!, <DD, DC, PA>
EV	Q6056 or	TR	MN130S-Y	(1)	2203664	!, <DD, DC, PA>
EV	Q6056 or	TR	KTC5242A-R	(1)	2203952	!, <DD, DC, PA>

EV	Q6056 or	TR	KTC5242A-O	(1)	2203953	!, <DD, DC, PA>
EV	Q6056	TR	2SC5198-O	1	2203063	!, <PP>
EV	Q6056 or	TR	2SC5198-R	(1)	2203062	!, <PP>
EV	Q6060	TR	MP130S-P	1	2203676	!, <DD, DC, PA>
EV	Q6060 or	TR	2SA1941-R	(1)	2203052	!, <DD, DC, PA>
EV	Q6060 or	TR	2SA1941-O	(1)	2203053	!, <DD, DC, PA>
EV	Q6060 or	TR	MP130S-O	(1)	2203673	!, <DD, DC, PA>
EV	Q6060 or	TR	MP130S-Y	(1)	2203674	!, <DD, DC, PA>
EV	Q6060	TR	2SA1941-O	1	2203053	!, <PP>
EV	Q6060 or	TR	2SA1941-R	(1)	2203052	!, <PP>
EV	Q6061	TR	MP130S-P	1	2203676	!, <DD, DC, PA>
EV	Q6061 or	TR	2SA1941-R	(1)	2203052	!, <DD, DC, PA>
EV	Q6061 or	TR	2SA1941-O	(1)	2203053	!, <DD, DC, PA>
EV	Q6061 or	TR	MP130S-O	(1)	2203673	!, <DD, DC, PA>
EV	Q6061 or	TR	MP130S-Y	(1)	2203674	!, <DD, DC, PA>
EV	Q6061	TR	2SA1941-O	1	2203053	!, <PP>
EV	Q6061 or	TR	2SA1941-R	(1)	2203052	!, <PP>
EV	Q6062	TR	MP130S-P	1	2203676	!, <DD, DC, PA>
EV	Q6062 or	TR	2SA1941-R	(1)	2203052	!, <DD, DC, PA>
EV	Q6062 or	TR	2SA1941-O	(1)	2203053	!, <DD, DC, PA>
EV	Q6062 or	TR	MP130S-O	(1)	2203673	!, <DD, DC, PA>
EV	Q6062 or	TR	MP130S-Y	(1)	2203674	!, <DD, DC, PA>
EV	Q6062	TR	2SA1941-O	1	2203053	!, <PP>
EV	Q6062 or	TR	2SA1941-R	(1)	2203052	!, <PP>
EV	Q6063	TR	MP130S-P	1	2203676	!, <DD, DC, PA>
EV	Q6063 or	TR	2SA1941-R	(1)	2203052	!, <DD, DC, PA>
EV	Q6063 or	TR	2SA1941-O	(1)	2203053	!, <DD, DC, PA>
EV	Q6063 or	TR	MP130S-O	(1)	2203673	!, <DD, DC, PA>
EV	Q6063 or	TR	MP130S-Y	(1)	2203674	!, <DD, DC, PA>
EV	Q6063 or	TR	KTA1962A-R	(1)	2203942	!, <DD, DC, PA>
EV	Q6063 or	TR	KTA1962A-O	(1)	2203943	!, <DD, DC, PA>
EV	Q6063	TR	2SA1941-O	1	2203053	!, <PP>
EV	Q6063 or	TR	2SA1941-R	(1)	2203052	!, <PP>

EV	Q6064	TR	MP130S-P	1	2203676	!, <DD, DC, PA>
EV	Q6064 or	TR	2SA1941-R	(1)	2203052	!, <DD, DC, PA>
EV	Q6064 or	TR	2SA1941-O	(1)	2203053	!, <DD, DC, PA>
EV	Q6064 or	TR	MP130S-O	(1)	2203673	!, <DD, DC, PA>
EV	Q6064 or	TR	MP130S-Y	(1)	2203674	!, <DD, DC, PA>
EV	Q6064 or	TR	KTA1962A-R	(1)	2203942	!, <DD, DC, PA>
EV	Q6064 or	TR	KTA1962A-O	(1)	2203943	!, <DD, DC, PA>
EV	Q6064	TR	2SA1941-O	1	2203053	!, <PP>
EV	Q6064 or	TR	2SA1941-R	(1)	2203052	!, <PP>
EV	Q6065	TR	MP130S-P	1	2203676	!, <DD, DC, PA>
EV	Q6065 or	TR	2SA1941-R	(1)	2203052	!, <DD, DC, PA>
EV	Q6065 or	TR	2SA1941-O	(1)	2203053	!, <DD, DC, PA>
EV	Q6065 or	TR	MP130S-O	(1)	2203673	!, <DD, DC, PA>
EV	Q6065 or	TR	MP130S-Y	(1)	2203674	!, <DD, DC, PA>
EV	Q6065 or	TR	KTA1962A-R	(1)	2203942	!, <DD, DC, PA>
EV	Q6065 or	TR	KTA1962A-O	(1)	2203943	!, <DD, DC, PA>
EV	Q6065	TR	2SA1941-O	1	2203053	!, <PP>
EV	Q6065 or	TR	2SA1941-R	(1)	2203052	!, <PP>
EV	Q6066	TR	MP130S-P	1	2203676	!, <DD, DC, PA>
EV	Q6066 or	TR	2SA1941-R	(1)	2203052	!, <DD, DC, PA>
EV	Q6066 or	TR	2SA1941-O	(1)	2203053	!, <DD, DC, PA>
EV	Q6066 or	TR	MP130S-O	(1)	2203673	!, <DD, DC, PA>
EV	Q6066 or	TR	MP130S-Y	(1)	2203674	!, <DD, DC, PA>
EV	Q6066 or	TR	KTA1962A-R	(1)	2203942	!, <DD, DC, PA>
EV	Q6066 or	TR	KTA1962A-O	(1)	2203943	!, <DD, DC, PA>
EV	Q6066	TR	2SA1941-O	1	2203053	!, <PP>
EV	Q6066 or	TR	2SA1941-R	(1)	2203052	!, <PP>
EV	<b>&lt;Note&gt;</b>					
EV	Must use the same HFE rank mutually about the following parts.					
EV	Ref. No. : Q6050 - 6056, Q6060 - Q6066					
EV	T901	P TRANS	NPT-1516D	1	2301798	!, <DD, DC>
EV	T901	P TRANS	NPT-1516P	1	2301799	!, <PP, PA>
EV	U01	AMPLIFIER PCB	NAAF-9419-1E	1	1B211519-1E	<DD, DC>

EV	U01	AMPLIFIER PC board ass'y	NAAF-9419-1F	1	1B211519-1F	<PP, PA>
EV	U02	TRANS. SEC. TERMINAL PC board ass'y	NAPS-9420-1E	1	1B211520-1E	<DD, DC>
EV	U02	TRANS. SEC. TERMINAL PC board ass'y	NAPS-9420-1F	1	1B211520-1F	<PP, PA>
EV	U03	THERMAL SENSOR PC board ass'y	NAETC-9421-1E	1	---	<DD, DC> NSP
EV	U03	THERMAL SENSOR PC board ass'y	NAETC-9421-1F	1	---	<PP, PA> NSP
EV	U04	HOLDER PC board	NAETC-9422	1	---	NSP
EV	U10	DISPLAY PC board ass'y	NADIS-9430-1A	1	1B211530-1A	<DD, DC>
EV	U10	DISPLAY PC board ass'y	NADIS-9430-1B	1	1B211530-1B	<PP, PA>
EV	U11	SWITCH PC board ass'y	NADIS-9431-1A	1	1B211531-1A	<DD, DC>
EV	U11	SWITCH PC board ass'y	NADIS-9431-1B	1	1B211531-1B	<PP, PA>
EV	U12	POWER SUPPLY PC board ass'y	NAPS-9432-1A	1	1B211532-1A	<DD, DC>
EV	U12	POWER SUPPLY PC board ass'y	NAPS-9432-1B	1	1B211532-1B	<PP, PA>
EV	U13	TRANS. SEC. TERMINAL PC board ass'y	NAPS-9433-1A	1	1B211533-1A	<DD, DC>
EV	U13	TRANS. SEC. TERMINAL PC board ass'y	NAPS-9433-1B	1	1B211533-1B	<PP, PA>
EV	U14	HEADPHONE JACK PC board ass'y	NAETC-9435-1A	1	---	<DD, DC>
EV	U14	HEADPHONE JACK PC board ass'y	NAETC-9435-1B	1	---	<PP, PA>
EV	U17	HOLDER PC board	NAETC-9441	1	---	NSP
EV	U32	MICROPROCESSOR PC board ass'y	NADG-9462-1A	1	1B211562-1A	<DD, DC>
EV	U32	MICROPROCESSOR PC board ass'y	NADG-9462-1B	1	1B211562-1B	<PP>
EV	U32	MICROPROCESSOR PC board ass'y	NADG-9462-1C	1	1B211562-1C	<PA>
EV	U36	VIDEO PC board ass'y	NAVD-9467-1G	1	1B211567-1G	<DD, DC>
EV	U36	VIDEO PC board ass'y	NAVD-9467-1H	1	1B211567-1H	<PP, PA>
EV	U37	SPEAKER TRMINAL PC board ass'y	NATRM-9468-1G	1	1B211568-1G	<DD, DC>
EV	U37	SPEAKER TRMINAL PC board ass'y	NATRM-9468-1G	1	1B211568-1G	<DD, DC>
EV	U44	DSP/HDMI PC board ass'y	NAHDM-9565-1A	1	1B211565-1A	
EV	U45	TUNER UNIT	ENG06507QFUS	1	240156	<DD, DC>
EV	U45 or	TUNER UNIT	FAE385-A11US	(1)	240152	<DD, DC>
EV	U45	TUNER UNIT	ENG07506QFEX	1	240159	<PA>
EV	U45 or	TUNER UNIT	FAE485-E12EX	(1)	240155	<PA>
EV	U45	TUNER UNIT	ENG07505QFEU	1	240158	<PP>
EV	U45 or	TUNER UNIT	FAE485-E11EU	(1)	240154	<PP>

### PC BOARD PARTS LIST

PCB1	<b>U01</b>	AMPLIFIER PC BOARD (NAAF-9419-1E / 1F)
PCB1	<b>U02</b>	TRANS. SEC. TERMINAL PC BOARD (NAPS-9420-1E / 1F)
PCB1	<b>U03</b>	THERMAL SENSOR PC BOARD (NAETC-9421-1E / 1F)

PCB1

PCB1	CIRCUIT NO.	PART NAME	DESCRIPTION	Q'TY	PART NO. (SN)	REMARKS
PCB1	Q5000	TR	2SC2240-BL(TPE2_F)	1	2211406T	
PCB1	Q5001	TR	2SC2240-BL(TPE2_F)	1	2211406T	
PCB1	Q5002	TR	2SC2240-BL(TPE2_F)	1	2211406T	
PCB1	Q5003	TR	2SC2240-BL(TPE2_F)	1	2211406T	
PCB1	Q5004	TR	2SC2240-BL(TPE2_F)	1	2211406T	
PCB1	Q5005	TR	2SC2240-BL(TPE2_F)	1	2211406T	
PCB1	Q5006	TR	2SC2240-BL(TPE2_F)	1	2211406T	
PCB1	Q5010	TR	2SC2240-BL(TPE2_F)	1	2211406T	
PCB1	Q5011	TR	2SC2240-BL(TPE2_F)	1	2211406T	
PCB1	Q5012	TR	2SC2240-BL(TPE2_F)	1	2211406T	
PCB1	Q5013	TR	2SC2240-BL(TPE2_F)	1	2211406T	
PCB1	Q5014	TR	2SC2240-BL(TPE2_F)	1	2211406T	
PCB1	Q5015	TR	2SC2240-BL(TPE2_F)	1	2211406T	
PCB1	Q5016	TR	2SC2240-BL(TPE2_F)	1	2211406T	
PCB1	Q5030	TR	2SA949-Y(TPE6_F)	1	2211354T	
PCB1	Q5031	TR	2SA949-Y(TPE6_F)	1	2211354T	
PCB1	Q5032	TR	2SA949-Y(TPE6_F)	1	2211354T	
PCB1	Q5033	TR	2SA949-Y(TPE6_F)	1	2211354T	
PCB1	Q5034	TR	2SA949-Y(TPE6_F)	1	2211354T	
PCB1	Q5035	TR	2SA949-Y(TPE6_F)	1	2211354T	
PCB1	Q5036	TR	2SA949-Y(TPE6_F)	1	2211354T	
PCB1	Q5040	TR	2SC2229-Y(TPE6_F)	1	2211634T	
PCB1	Q5041	TR	2SC2229-Y(TPE6_F)	1	2211634T	
PCB1	Q5042	TR	2SC2229-Y(TPE6_F)	1	2211634T	
PCB1	Q5043	TR	2SC2229-Y(TPE6_F)	1	2211634T	
PCB1	Q5044	TR	2SC2229-Y(TPE6_F)	1	2211634T	



PCB1	Q5045	TR	2SC2229-Y(TPE6_F)	1	2211634T
PCB1	Q5046	TR	2SC2229-Y(TPE6_F)	1	2211634T
PCB1	Q5050	TR	2SC1815-GR	1	2211255T
PCB1	Q5051	TR	2SC1815-GR	1	2211255T
PCB1	Q5052	TR	2SC1815-GR	1	2211255T
PCB1	Q5053	TR	2SC1815-GR	1	2211255T
PCB1	Q5054	TR	2SC1815-GR	1	2211255T
PCB1	Q5055	TR	2SC1815-GR	1	2211255T
PCB1	Q5056	TR	2SC1815-GR	1	2211255T
PCB1	Q5501	IC	R2S15211FP	1	22242297R3
PCB1	Q5503	IC	NJM4580M-D	1	22241448R2
PCB1	Q5600	TR	RN1441	1	2215410R2
PCB1	Q5601	TR	RN1441	1	2215410R2
PCB1	Q5602	TR	RN1441	1	2215410R2
PCB1	Q5603	TR	RN1441	1	2215410R2
PCB1	Q5604	TR	RN1441	1	2215410R2
PCB1	Q5605	TR	RN1441	1	2215410R2
PCB1	Q5606	TR	RN1441	1	2215410R2
PCB1	Q5607	TR	RN1441	1	2215410R2
PCB1	Q5608	TR	RN1441	1	2215410R2
PCB1	Q5609	TR	RN1441	1	2215410R2
PCB1	Q5610	TR	RN1441	1	2215410R2
PCB1	Q5630	IC	NJM4580M-D	1	22241448R2
PCB1	Q5670	IC	78M15HF(NJM78M15FA)	1	222780155JRC
PCB1	Q5670 or	IC	UPC78M15AHF-AZ	(1)	222780155NEC
PCB1	Q5670A	HEAT-SINK	HEAT-SINK(RAD-68)	1	27160211
PCB1	Q5670B	SCREW	3P+10FN(3BC)	1	82143010GR
PCB1	Q5671	IC	79M15HF(NJM79M15FA)	1	222790155JRC
PCB1	Q5671 or	IC	UPC79M15HF-AZ	(1)	222790155NEC
PCB1	Q5671A	HEAT-SINK	HEAT-SINK(RAD-68)	1	27160211
PCB1	Q5671B	SCREW	3P+10FN(3BC)	1	82143010GR
PCB1	Q6000	TR	2SC1740S-S	1	2213285T
PCB1	Q6001	TR	2SC1740S-S	1	2213285T

PCB1	Q6002	TR	2SC1740S-S	1	2213285T
PCB1	Q6003	TR	2SC1740S-S	1	2213285T
PCB1	Q6004	TR	2SC1740S-S	1	2213285T
PCB1	Q6005	TR	2SC1740S-S	1	2213285T
PCB1	Q6006	TR	2SC1740S-S	1	2213285T
PCB1	Q6010	TR	2SC1740S-S	1	2213285T
PCB1	Q6011	TR	2SC1740S-S	1	2213285T
PCB1	Q6012	TR	2SC1740S-S	1	2213285T
PCB1	Q6013	TR	2SC1740S-S	1	2213285T
PCB1	Q6014	TR	2SC1740S-S	1	2213285T
PCB1	Q6015	TR	2SC1740S-S	1	2213285T
PCB1	Q6016	TR	2SC1740S-S	1	2213285T
PCB1	Q6030	TR	2SC5171(ONK_Q)	1	2203010
PCB1	Q6030 or	TR	2SC5993-Q_P	(1)	2217161
PCB1	Q6031	TR	2SC5171(ONK_Q)	1	2203010
PCB1	Q6031 or	TR	2SC5993-Q_P	(1)	2217161
PCB1	Q6032	TR	2SC5171(ONK_Q)	1	2203010
PCB1	Q6032 or	TR	2SC5993-Q_P	(1)	2217161
PCB1	Q6033	TR	2SC5171(ONK_Q)	1	2203010
PCB1	Q6033 or	TR	2SC5993-Q_P	(1)	2217161
PCB1	Q6033 or	TR	KTD2061-Y	(1)	2203434
PCB1	Q6034	TR	2SC5171(ONK_Q)	1	2203010
PCB1	Q6034 or	TR	2SC5993-Q_P	(1)	2217161
PCB1	Q6034 or	TR	KTD2061-Y	(1)	2203434
PCB1	Q6035	TR	2SC5171(ONK_Q)	1	2203010
PCB1	Q6035 or	TR	2SC5993-Q_P	(1)	2217161
PCB1	Q6035 or	TR	KTD2061-Y	(1)	2203434
PCB1	Q6036	TR	2SC5171(ONK_Q)	1	2203010
PCB1	Q6036 or	TR	2SC5993-Q_P	(1)	2217161
PCB1	Q6036 or	TR	KTD2061-Y	(1)	2203434
PCB1	Q6040	TR	2SA1930(ONK_Q)	1	2203000
PCB1	Q6040 or	TR	2SA2140-Q_P	(1)	2217151
PCB1	Q6041	TR	2SA1930(ONK_Q)	1	2203000

PCB1	Q6041 or	TR	2SA2140-Q_P	(1)	2217151
PCB1	Q6042	TR	2SA1930(ONK_Q)	1	2203000
PCB1	Q6042 or	TR	2SA2140-Q_P	(1)	2217151
PCB1	Q6043	TR	2SA1930(ONK_Q)	1	2203000
PCB1	Q6043 or	TR	2SA2140-Q_P	(1)	2217151
PCB1	Q6043 or	TR	KTB1369-Y	(1)	2203424
PCB1	Q6044	TR	2SA1930(ONK_Q)	1	2203000
PCB1	Q6044 or	TR	2SA2140-Q_P	(1)	2217151
PCB1	Q6044 or	TR	KTB1369-Y	(1)	2203424
PCB1	Q6045	TR	2SA1930(ONK_Q)	1	2203000
PCB1	Q6045 or	TR	2SA2140-Q_P	(1)	2217151
PCB1	Q6045 or	TR	KTB1369-Y	(1)	2203424
PCB1	Q6046	TR	2SA1930(ONK_Q)	1	2203000
PCB1	Q6046 or	TR	2SA2140-Q_P	(1)	2217151
PCB1	Q6046 or	TR	KTB1369-Y	(1)	2203424
PCB1	Q6070	TR	2SC2240-BL(TPE2_F)	1	2211406T
PCB1	Q6070 or	TR	2SC2240-GR	(1)	2211405T
PCB1	Q6071	TR	2SC2240-BL(TPE2_F)	1	2211406T
PCB1	Q6071 or	TR	2SC2240-GR	(1)	2211405T
PCB1	Q6072	TR	2SC2240-BL(TPE2_F)	1	2211406T
PCB1	Q6072 or	TR	2SC2240-GR	(1)	2211405T
PCB1	Q6073	TR	2SC2240-BL(TPE2_F)	1	2211406T
PCB1	Q6073 or	TR	2SC2240-GR	(1)	2211405T
PCB1	Q6074	TR	2SC2240-BL(TPE2_F)	1	2211406T
PCB1	Q6074 or	TR	2SC2240-GR	(1)	2211405T
PCB1	Q6075	TR	2SC2240-BL(TPE2_F)	1	2211406T
PCB1	Q6075 or	TR	2SC2240-GR	(1)	2211405T
PCB1	Q6076	TR	2SC2240-BL(TPE2_F)	1	2211406T
PCB1	Q6076 or	TR	2SC2240-GR	(1)	2211405T
PCB1	Q6380	IC	LM61CIZ	1	22242212
PCB1	Q6380A	RETAINER	(PTH)	1	27141884-1
PCB1	Q6701	TR	2SC2712-GR	1	2213145R2
PCB1	Q6701 or	TR	KTC3875-GR	(1)	2216175R2

PCB1	Q6702	TR	2SC2712-GR	1	2213145R2
PCB1	Q6702 or	TR	KTC3875-GR	(1)	2216175R2
PCB1	Q6703	TR	2SA1163-BL(TE85L_F)	1	2216756R2
PCB1	Q6707	TR	2SC2712-GR	1	2213145R2
PCB1	Q6707 or	TR	KTC3875-GR	(1)	2216175R2
PCB1	D5000	ZENER D	MTZJ5.6B	1	224470562T
PCB1	D5001	ZENER D	MTZJ5.6B	1	224470562T
PCB1	D5002	ZENER D	MTZJ5.6B	1	224470562T
PCB1	D5003	ZENER D	MTZJ5.6B	1	224470562T
PCB1	D5004	ZENER D	MTZJ5.6B	1	224470562T
PCB1	D5005	ZENER D	MTZJ5.6B	1	224470562T
PCB1	D5006	ZENER D	MTZJ5.6B	1	224470562T
PCB1	D5671	ZENER D	MTZJ6.2B	1	224470622T
PCB1	D5672	ZENER D	MTZJ6.2B	1	224470622T
PCB1	D5673	DIODE	1SS133	1	223163T
PCB1	D5674	DIODE	1SS133	1	223163T
PCB1	D5704	C-DIODE	KDS4148U	1	223283R2
PCB1	D5704 or	C-DIODE	1SS352	(1)	223234R2
PCB1	D5704 or	C-DIODE	MA2J111	(1)	223279R2
PCB1	D5705	C-DIODE	KDS4148U	1	223283R2
PCB1	D5705 or	C-DIODE	1SS352	(1)	223234R2
PCB1	D5705 or	C-DIODE	MA2J111	(1)	223279R2
PCB1	D5706	C-DIODE	KDS4148U	1	223283R2
PCB1	D5706 or	C-DIODE	1SS352	(1)	223234R2
PCB1	D5706 or	C-DIODE	MA2J111	(1)	223279R2
PCB1	D5707	C-DIODE	KDS4148U	1	223283R2
PCB1	D5707 or	C-DIODE	1SS352	(1)	223234R2
PCB1	D5707 or	C-DIODE	MA2J111	(1)	223279R2
PCB1	D5708	C-DIODE	KDS4148U	1	223283R2
PCB1	D5708 or	C-DIODE	1SS352	(1)	223234R2
PCB1	D5708 or	C-DIODE	MA2J111	(1)	223279R2
PCB1	D5709	DIODE	RL1N4003	1	22380260T
PCB1	D5714	C-DIODE	KDS4148U	1	223283R2

PCB1	D5714 or	C-DIODE	ISS352	(1)	223234R2
PCB1	D5714 or	C-DIODE	MA2J111	(1)	223279R2
PCB1	D5715	C-DIODE	KDS4148U	1	223283R2
PCB1	D5715 or	C-DIODE	ISS352	(1)	223234R2
PCB1	D5715 or	C-DIODE	MA2J111	(1)	223279R2
PCB1	D5716	C-DIODE	KDS4148U	1	223283R2
PCB1	D5716 or	C-DIODE	ISS352	(1)	223234R2
PCB1	D5716 or	C-DIODE	MA2J111	(1)	223279R2
PCB1	D5717	C-DIODE	KDS4148U	1	223283R2
PCB1	D5717 or	C-DIODE	ISS352	(1)	223234R2
PCB1	D5717 or	C-DIODE	MA2J111	(1)	223279R2
PCB1	D5718	C-DIODE	KDS4148U	1	223283R2
PCB1	D5718 or	C-DIODE	ISS352	(1)	223234R2
PCB1	D5718 or	C-DIODE	MA2J111	(1)	223279R2
PCB1	D5719	DIODE	RL1N4003	1	22380260T
PCB1	D6000	C-DIODE	KDS4148U	1	223283R2
PCB1	D6000 or	C-DIODE	ISS352	(1)	223234R2
PCB1	D6000 or	C-DIODE	MA2J111	(1)	223279R2
PCB1	D6001	C-DIODE	KDS4148U	1	223283R2
PCB1	D6001 or	C-DIODE	ISS352	(1)	223234R2
PCB1	D6001 or	C-DIODE	MA2J111	(1)	223279R2
PCB1	D6002	C-DIODE	KDS4148U	1	223283R2
PCB1	D6002 or	C-DIODE	ISS352	(1)	223234R2
PCB1	D6002 or	C-DIODE	MA2J111	(1)	223279R2
PCB1	D6003	C-DIODE	KDS4148U	1	223283R2
PCB1	D6003 or	C-DIODE	ISS352	(1)	223234R2
PCB1	D6003 or	C-DIODE	MA2J111	(1)	223279R2
PCB1	D6004	C-DIODE	KDS4148U	1	223283R2
PCB1	D6004 or	C-DIODE	ISS352	(1)	223234R2
PCB1	D6004 or	C-DIODE	MA2J111	(1)	223279R2
PCB1	D6005	C-DIODE	KDS4148U	1	223283R2
PCB1	D6005 or	C-DIODE	ISS352	(1)	223234R2
PCB1	D6005 or	C-DIODE	MA2J111	(1)	223279R2

PCB1	D6006	C-DIODE	KDS4148U	1	223283R2
PCB1	D6006 or	C-DIODE	1SS352	(1)	223234R2
PCB1	D6006 or	C-DIODE	MA2J111	(1)	223279R2
PCB1	D6010	C-DIODE	KDS4148U	1	223283R2
PCB1	D6010 or	C-DIODE	1SS352	(1)	223234R2
PCB1	D6010 or	C-DIODE	MA2J111	(1)	223279R2
PCB1	D6011	C-DIODE	KDS4148U	1	223283R2
PCB1	D6011 or	C-DIODE	1SS352	(1)	223234R2
PCB1	D6011 or	C-DIODE	MA2J111	(1)	223279R2
PCB1	D6012	C-DIODE	KDS4148U	1	223283R2
PCB1	D6012 or	C-DIODE	1SS352	(1)	223234R2
PCB1	D6012 or	C-DIODE	MA2J111	(1)	223279R2
PCB1	D6013	C-DIODE	KDS4148U	1	223283R2
PCB1	D6013 or	C-DIODE	1SS352	(1)	223234R2
PCB1	D6013 or	C-DIODE	MA2J111	(1)	223279R2
PCB1	D6014	C-DIODE	KDS4148U	1	223283R2
PCB1	D6014 or	C-DIODE	1SS352	(1)	223234R2
PCB1	D6014 or	C-DIODE	MA2J111	(1)	223279R2
PCB1	D6015	C-DIODE	KDS4148U	1	223283R2
PCB1	D6015 or	C-DIODE	1SS352	(1)	223234R2
PCB1	D6015 or	C-DIODE	MA2J111	(1)	223279R2
PCB1	D6016	C-DIODE	KDS4148U	1	223283R2
PCB1	D6016 or	C-DIODE	1SS352	(1)	223234R2
PCB1	D6016 or	C-DIODE	MA2J111	(1)	223279R2
PCB1	D6701	C-DIODE	KDS4148U	1	223283R2
PCB1	D6701 or	C-DIODE	1SS352	(1)	223234R2
PCB1	D6701 or	C-DIODE	MA2J111	(1)	223279R2
PCB1	D6702	C-DIODE	KDS4148U	1	223283R2
PCB1	D6702 or	C-DIODE	1SS352	(1)	223234R2
PCB1	D6702 or	C-DIODE	MA2J111	(1)	223279R2
PCB1	D6703	ZENER D	UDZ3.3B	1	224490330R2
PCB1	D6704	ZENER D	UDZ3.3B	1	224490330R2
PCB1	D6901	DIODE	D10XB60H	1	22380337

PCB1	D6901A	HEAT SINK	RAD-196	1	27160545
PCB1	D6901C	SCREW	3P+10FN(3BC)	2	82143010GR
PCB1	D6902	C-DIODE	KDS4148U	1	223283R2
PCB1	D6902 or	C-DIODE	1SS352	(1)	223234R2
PCB1	D6902 or	C-DIODE	MA2J111	(1)	223279R2
PCB1	D6903	DIODE	D10XB60H	1	22380337
PCB1	D9001	DIODE	RL1N4003	1	22380260T
PCB1	D9002	DIODE	RL1N4003	1	22380260T
PCB1	D9003	DIODE	RL1N4003	1	22380260T
PCB1	D9004	DIODE	RL1N4003	1	22380260T
PCB1	C5000	TF C	ECQ-B50V-221K	1	374722215T
PCB1	C5001	TF C	ECQ-B50V-221K	1	374722215T
PCB1	C5002	TF C	ECQ-B50V-221K	1	374722215T
PCB1	C5003	TF C	ECQ-B50V-221K	1	374722215T
PCB1	C5004	TF C	ECQ-B50V-221K	1	374722215T
PCB1	C5005	TF C	ECQ-B50V-221K	1	374722215T
PCB1	C5006	TF C	ECQ-B50V-221K	1	374722215T
PCB1	C5010	UTSP C	CE04W50V 47M(UTSP)	1	397584707T
PCB1	C5011	UTSP C	CE04W50V 47M(UTSP)	1	397584707T
PCB1	C5012	UTSP C	CE04W50V 47M(UTSP)	1	397584707T
PCB1	C5013	UTSP C	CE04W50V 47M(UTSP)	1	397584707T
PCB1	C5014	UTSP C	CE04W50V 47M(UTSP)	1	397584707T
PCB1	C5015	UTSP C	CE04W50V 47M(UTSP)	1	397584707T
PCB1	C5016	UTSP C	CE04W50V 47M(UTSP)	1	397584707T
PCB1	C5020	UTSP C	CE04W50V-10M(UTSP)	1	397581007T
PCB1	C5021	UTSP C	CE04W50V-10M(UTSP)	1	397581007T
PCB1	C5022	UTSP C	CE04W50V-10M(UTSP)	1	397581007T
PCB1	C5023	UTSP C	CE04W50V-10M(UTSP)	1	397581007T
PCB1	C5024	UTSP C	CE04W50V-10M(UTSP)	1	397581007T
PCB1	C5025	UTSP C	CE04W50V-10M(UTSP)	1	397581007T
PCB1	C5026	UTSP C	CE04W50V-10M(UTSP)	1	397581007T
PCB1	C5040	UTSP C	CE04W25V-220M(UTSP)	1	397552217T
PCB1	C5041	UTSP C	CE04W25V-220M(UTSP)	1	397552217T

PCB1	C5042	UTSP C	CE04W25V-220M(UTSP)	1	397552217T
PCB1	C5043	UTSP C	CE04W25V-220M(UTSP)	1	397552217T
PCB1	C5044	UTSP C	CE04W25V-220M(UTSP)	1	397552217T
PCB1	C5045	UTSP C	CE04W25V-220M(UTSP)	1	397552217T
PCB1	C5046	UTSP C	CE04W25V-220M(UTSP)	1	397552217T
PCB1	C5050	UTSP C	CE04W50V 47M(UTSP)	1	397584707T
PCB1	C5051	UTSP C	CE04W50V 47M(UTSP)	1	397584707T
PCB1	C5052	UTSP C	CE04W50V 47M(UTSP)	1	397584707T
PCB1	C5053	UTSP C	CE04W50V 47M(UTSP)	1	397584707T
PCB1	C5054	UTSP C	CE04W50V 47M(UTSP)	1	397584707T
PCB1	C5055	UTSP C	CE04W50V 47M(UTSP)	1	397584707T
PCB1	C5056	UTSP C	CE04W50V 47M(UTSP)	1	397584707T
PCB1	C5080	CERA C	CC45SL50V-040C	1	345020401T
PCB1	C5081	CERA C	CC45SL50V-040C	1	345020401T
PCB1	C5082	CERA C	CC45SL50V-040C	1	345020401T
PCB1	C5083	CERA C	CC45SL50V-040C	1	345020401T
PCB1	C5084	CERA C	CC45SL50V-040C	1	345020401T
PCB1	C5085	CERA C	CC45SL50V-040C	1	345020401T
PCB1	C5086	CERA C	CC45SL50V-040C	1	345020401T
PCB1	C5090	TF C	ECQ-B50V-101K	1	374721015T
PCB1	C5091	TF C	ECQ-B50V-101K	1	374721015T
PCB1	C5092	TF C	ECQ-B50V-101K	1	374721015T
PCB1	C5093	TF C	ECQ-B50V-101K	1	374721015T
PCB1	C5094	TF C	ECQ-B50V-101K	1	374721015T
PCB1	C5095	TF C	ECQ-B50V-101K	1	374721015T
PCB1	C5096	TF C	ECQ-B50V-101K	1	374721015T
PCB1	C5100	VR C	CE04W100V-22M(VR)	1	394692207T
PCB1	C5101	VR C	CE04W100V-22M(VR)	1	394692207T
PCB1	C5102	VR C	CE04W100V-22M(VR)	1	394692207T
PCB1	C5103	VR C	CE04W100V-22M(VR)	1	394692207T
PCB1	C5104	VR C	CE04W100V-22M(VR)	1	394692207T
PCB1	C5105	VR C	CE04W100V-22M(VR)	1	394692207T
PCB1	C5106	VR C	CE04W100V-22M(VR)	1	394692207T



PCB1	C5110	VR C	CE04W100V-22M(VR)	1	394692207T
PCB1	C5111	VR C	CE04W100V-22M(VR)	1	394692207T
PCB1	C5112	VR C	CE04W100V-22M(VR)	1	394692207T
PCB1	C5113	VR C	CE04W100V-22M(VR)	1	394692207T
PCB1	C5114	VR C	CE04W100V-22M(VR)	1	394692207T
PCB1	C5115	VR C	CE04W100V-22M(VR)	1	394692207T
PCB1	C5116	VR C	CE04W100V-22M(VR)	1	394692207T
PCB1	C5503	TF C	ECQ-B50V-221K	1	374722215T
PCB1	C5504	TF C	ECQ-B50V-221K	1	374722215T
PCB1	C5507	C-CERA C	CC725CH1H-221J1	1	342102214R1
PCB1	C5508	C-CERA C	CC725CH1H-221J1	1	342102214R1
PCB1	C5513	C-CERA C	CC725CH1H-221J1	1	342102214R1
PCB1	C5514	C-CERA C	CC725CH1H-221J1	1	342102214R1
PCB1	C5517	C-CERA C	CC725CH1H-221J1	1	342102214R1
PCB1	C5518	C-CERA C	CC725CH1H-221J1	1	342102214R1
PCB1	C5519	TF C	ECQ-B50V-221K	1	374722215T
PCB1	C5520	TF C	ECQ-B50V-221K	1	374722215T
PCB1	C5521	C-CERA C	CC725CH1H-221J1	1	342102214R1
PCB1	C5522	C-CERA C	CC725CH1H-221J1	1	342102214R1
PCB1	C5523	C-CERA C	CC725CH1H-221J1	1	342102214R1
PCB1	C5524	TF C	ECQ-B50V-221K	1	374722215T
PCB1	C5525	C-CERA C	CC725CH1H-221J1	1	342102214R1
PCB1	C5526	C-CERA C	CC725CH1H-221J1	1	342102214R1
PCB1	C5527	C-CERA C	CC725CH1H-221J1	1	342102214R1
PCB1	C5528	C-CERA C	CC725CH1H-221J1	1	342102214R1
PCB1	C5531	C-CERA C	CC725CH1H-221J1	1	342102214R1
PCB1	C5551	UTSP C	CE04W25V-47M(UTSP)	1	397554707T
PCB1	C5552	UTSP C	CE04W25V-47M(UTSP)	1	397554707T
PCB1	C5553	UTSP C	CE04W25V-47M(UTSP)	1	397554707T
PCB1	C5554	UTSP C	CE04W25V-47M(UTSP)	1	397554707T
PCB1	C5555	UTSP C	CE04W25V-47M(UTSP)	1	397554707T
PCB1	C5556	UTSP C	CE04W25V-47M(UTSP)	1	397554707T
PCB1	C5557	UTSP C	CE04W25V-47M(UTSP)	1	397554707T

PCB1	C5558	UTSP C	CE04W25V-47M(UTSP)	1	397554707T
PCB1	C5559	TF C	ECQ-V50V-474J	1	374724744T
PCB1	C5560	TF C	ECQ-V50V-823J	1	374728234T
PCB1	C5561	TF C	ECQ-B50V-223J	1	374722234T
PCB1	C5562	TF C	ECQ-V50V-474J	1	374724744T
PCB1	C5563	TF C	ECQ-V50V-823J	1	374728234T
PCB1	C5564	TF C	ECQ-B50V-223J	1	374722234T
PCB1	C5565	UTSP C	CE04W25V-47M(UTSP)	1	397554707T
PCB1	C5566	UTSP C	CE04W25V-47M(UTSP)	1	397554707T
PCB1	C5569	UTSP C	CE04W25V-47M(UTSP)	1	397554707T
PCB1	C5570	UTSP C	CE04W25V-47M(UTSP)	1	397554707T
PCB1	C5571	UTSP C	CE04W25V-47M(UTSP)	1	397554707T
PCB1	C5572	UTSP C	CE04W25V-47M(UTSP)	1	397554707T
PCB1	C5573	UTSP C	CE04W25V-47M(UTSP)	1	397554707T
PCB1	C5574	UTSP C	CE04W25V-47M(UTSP)	1	397554707T
PCB1	C5575	UTSP C	CE04W25V-47M(UTSP)	1	397554707T
PCB1	C5576	UTSP C	CE04W25V-47M(UTSP)	1	397554707T
PCB1	C5590	C-CERA C	CC725CH1H-330J1	1	342103304R1
PCB1	C5591	C-CERA C	CC725CH1H-330J1	1	342103304R1
PCB1	C5600	UTSP C	CE04W25V-100M(UTSP)	1	397551017T
PCB1	C5601	UTSP C	CE04W25V-47M(UTSP)	1	397554707T
PCB1	C5602	UTSP C	CE04W25V-47M(UTSP)	1	397554707T
PCB1	C5603	UTSP C	CE04W25V-47M(UTSP)	1	397554707T
PCB1	C5604	UTSP C	CE04W25V-47M(UTSP)	1	397554707T
PCB1	C5605	UTSP C	CE04W25V-47M(UTSP)	1	397554707T
PCB1	C5606	UTSP C	CE04W25V-47M(UTSP)	1	397554707T
PCB1	C5607	UTSP C	CE04W25V-47M(UTSP)	1	397554707T
PCB1	C5608	UTSP C	CE04W25V-47M(UTSP)	1	397554707T
PCB1	C5609	UTSP C	CE04W25V-47M(UTSP)	1	397554707T
PCB1	C5630	UTSP C	CE04W25V-47M(UTSP)	1	397554707T
PCB1	C5631	C-CERA C	CC725CH1H-221J1	1	342102214R1
PCB1	C5632	TF C	ECQ-B50V-103J	1	374721034T
PCB1	C5666	UTSP C	CE04W25V-220M(UTSP)	1	397552217T

PCB1	C5667	UTSP C	CE04W25V-220M(UTSP)	1	397552217T
PCB1	C5670	UTSP C	CE04W50V-10M(UTSP)	1	397581007T
PCB1	C5671	UTSP C	CE04W50V-10M(UTSP)	1	397581007T
PCB1	C5672	UTSP C	CE04W25V-220M(UTSP)	1	397552217T
PCB1	C5673	UTSP C	CE04W25V-220M(UTSP)	1	397552217T
PCB1	C5674	UTSP C	CE04W16V-470M(UTSP)	1	397544717T
PCB1	C5675	UTSP C	CE04W16V-470M(UTSP)	1	397544717T
PCB1	C5704	C-CERA C	CC725CH1H-221J1	1	342102214R1
PCB1	C5705	C-CERA C	CC725CH1H-221J1	1	342102214R1
PCB1	C5706	C-CERA C	CC725CH1H-221J1	1	342102214R1
PCB1	C5707	C-CERA C	CK725B1H-103K1	1	332101035R1
PCB1	C5708	C-CERA C	CK725B1H-103K1	1	332101035R1
PCB1	C5709	UTSP C	CE04W25V-47M(UTSP)	1	397554707T
PCB1	C5710	UTSP C	CE04W25V-47M(UTSP)	1	397554707T
PCB1	C6030	TF C	ECQ-V50V-473J	1	374724734T
PCB1	C6031	TF C	ECQ-V50V-473J	1	374724734T
PCB1	C6032	TF C	ECQ-V50V-473J	1	374724734T
PCB1	C6033	TF C	ECQ-V50V-473J	1	374724734T
PCB1	C6034	TF C	ECQ-V50V-473J	1	374724734T
PCB1	C6035	TF C	ECQ-V50V-473J	1	374724734T
PCB1	C6036	TF C	ECQ-V50V-473J	1	374724734T
PCB1	C6040	UTSP C	CE04W50V 47M(UTSP)	1	397584707T
PCB1	C6041	UTSP C	CE04W50V 47M(UTSP)	1	397584707T
PCB1	C6042	UTSP C	CE04W50V 47M(UTSP)	1	397584707T
PCB1	C6043	UTSP C	CE04W50V 47M(UTSP)	1	397584707T
PCB1	C6044	UTSP C	CE04W50V 47M(UTSP)	1	397584707T
PCB1	C6045	UTSP C	CE04W50V 47M(UTSP)	1	397584707T
PCB1	C6046	UTSP C	CE04W50V 47M(UTSP)	1	397584707T
PCB1	C6050	TF C	ECQ-B50V-103J	1	374721034T
PCB1	C6051	TF C	ECQ-B50V-103J	1	374721034T
PCB1	C6052	TF C	ECQ-B50V-103J	1	374721034T
PCB1	C6053	TF C	ECQ-B50V-103J	1	374721034T
PCB1	C6054	TF C	ECQ-B50V-103J	1	374721034T

PCB1	C6055	TF C	ECQ-B50V-103J	1	374721034T	
PCB1	C6056	TF C	ECQ-B50V-103J	1	374721034T	
PCB1	C6076	TF C	ECQ-B50V-102J	1	374721024T	<PP, PA>
PCB1	C6077	TF C	ECQ-B50V-102J	1	374721024T	<PP, PA>
PCB1	C6086	TF C	ECQ-B50V-103J	1	374721034T	<PP, PA>
PCB1	C6087	TF C	ECQ-B50V-103J	1	374721034T	<PP, PA>
PCB1	C6630	C-CERA C	CK725F1E-104Z1	1	332161040R1	
PCB1	C6701	UTSP C	CE04W25V-100M(UTSP)	1	397551017T	
PCB1	C6703	C-CERA C	CK725F1H-104Z1	1	332151040R1	
PCB1	C6704	UTSP C	CE04W50V-1M(UTSP)	1	397580107T	
PCB1	C6706	UTSP C	CE04W50V-10M(UTSP)	1	397581007T	
PCB1	C6901	ELECT C	CE69W63V-10000MB	1	3504418	
PCB1	C6901 or	ELECT C	CE69W63V-10000MA	(1)	3504417	
PCB1	C6901A	IB CUSHION	W15 x 3t TAPE	1	28141585	
PCB1	C6902	ELECT C	CE69W63V-10000MB	1	3504418	
PCB1	C6902 or	ELECT C	CE69W63V-10000MA	(1)	3504417	
PCB1	C6902A	IB CUSHION	W15 x 3t TAPE	1	28141585	
PCB1	C6911	C-CERA C	CC725CH1H-102J1	1	342101024R1	
PCB1	C6912	TF C	ECQ-V50V-334J	1	374723344T	
PCB1	C6913	TF C	ECQ-V50V-334J	1	374723344T	
PCB1	C6915	TF C	ECQ-V50V-104J	1	374721044T	
PCB1	C6916	TF C	ECQ-V50V-104J	1	374721044T	
PCB1	C9001	MMT C	MMT50V-334J	1	375523344T	
PCB1	C9003	VR C	CE04W35V-1000M(VR)	1	394661027S	
PCB1	C9004	VR C	CE04W35V-470M(VR)	1	394664717T	
PCB1	R5000	CARBON R	R16J-1K	1	417341024T	
PCB1	R5001	CARBON R	R16J-1K	1	417341024T	
PCB1	R5002	CARBON R	R16J-1K	1	417341024T	
PCB1	R5003	CARBON R	R16J-1K	1	417341024T	
PCB1	R5004	CARBON R	R16J-1K	1	417341024T	
PCB1	R5005	CARBON R	R16J-1K	1	417341024T	
PCB1	R5006	CARBON R	R16J-1K	1	417341024T	
PCB1	R5010	CARBON R	R16J-56K	1	417345634T	

PCB1	R5011	CARBON R	R16J-56K	1	417345634T
PCB1	R5012	CARBON R	R16J-56K	1	417345634T
PCB1	R5013	CARBON R	R16J-56K	1	417345634T
PCB1	R5014	CARBON R	R16J-56K	1	417345634T
PCB1	R5015	CARBON R	R16J-56K	1	417345634T
PCB1	R5016	CARBON R	R16J-56K	1	417345634T
PCB1	R5020	CARBON R	R16J-330	1	417343314T
PCB1	R5021	CARBON R	R16J-330	1	417343314T
PCB1	R5022	CARBON R	R16J-330	1	417343314T
PCB1	R5023	CARBON R	R16J-330	1	417343314T
PCB1	R5024	CARBON R	R16J-330	1	417343314T
PCB1	R5025	CARBON R	R16J-330	1	417343314T
PCB1	R5026	CARBON R	R16J-330	1	417343314T
PCB1	R5030	CARBON R	R16J-120K	1	417341244T
PCB1	R5031	CARBON R	R16J-120K	1	417341244T
PCB1	R5032	CARBON R	R16J-120K	1	417341244T
PCB1	R5033	CARBON R	R16J-120K	1	417341244T
PCB1	R5034	CARBON R	R16J-120K	1	417341244T
PCB1	R5035	CARBON R	R16J-120K	1	417341244T
PCB1	R5036	CARBON R	R16J-120K	1	417341244T
PCB1	R5040	CARBON R	R16J-2.2K	1	417342224T
PCB1	R5041	CARBON R	R16J-2.2K	1	417342224T
PCB1	R5042	CARBON R	R16J-2.2K	1	417342224T
PCB1	R5043	CARBON R	R16J-2.2K	1	417342224T
PCB1	R5044	CARBON R	R16J-2.2K	1	417342224T
PCB1	R5045	CARBON R	R16J-2.2K	1	417342224T
PCB1	R5046	CARBON R	R16J-2.2K	1	417342224T
PCB1	R5050	CARBON R	R16J-4.7K	1	417344724T
PCB1	R5051	CARBON R	R16J-4.7K	1	417344724T
PCB1	R5052	CARBON R	R16J-4.7K	1	417344724T
PCB1	R5053	CARBON R	R16J-4.7K	1	417344724T
PCB1	R5054	CARBON R	R16J-4.7K	1	417344724T
PCB1	R5055	CARBON R	R16J-4.7K	1	417344724T

PCB1	R5056	CARBON R	R16J-4.7K	1	417344724T
PCB1	R5060	CARBON R	R16J-1.2K	1	417341224T
PCB1	R5061	CARBON R	R16J-1.2K	1	417341224T
PCB1	R5062	CARBON R	R16J-1.2K	1	417341224T
PCB1	R5063	CARBON R	R16J-1.2K	1	417341224T
PCB1	R5064	CARBON R	R16J-1.2K	1	417341224T
PCB1	R5065	CARBON R	R16J-1.2K	1	417341224T
PCB1	R5066	CARBON R	R16J-1.2K	1	417341224T
PCB1	R5080	CARBON R	R16J-470	1	417344714T
PCB1	R5081	CARBON R	R16J-470	1	417344714T
PCB1	R5082	CARBON R	R16J-470	1	417344714T
PCB1	R5083	CARBON R	R16J-470	1	417344714T
PCB1	R5084	CARBON R	R16J-470	1	417344714T
PCB1	R5085	CARBON R	R16J-470	1	417344714T
PCB1	R5086	CARBON R	R16J-470	1	417344714T
PCB1	R5090	CARBON R	R16J-100K	1	417341044T
PCB1	R5091	CARBON R	R16J-100K	1	417341044T
PCB1	R5092	CARBON R	R16J-100K	1	417341044T
PCB1	R5093	CARBON R	R16J-100K	1	417341044T
PCB1	R5094	CARBON R	R16J-100K	1	417341044T
PCB1	R5095	CARBON R	R16J-100K	1	417341044T
PCB1	R5096	CARBON R	R16J-100K	1	417341044T
PCB1	R5100	CARBON R	R16J-100K	1	417341044T
PCB1	R5101	CARBON R	R16J-100K	1	417341044T
PCB1	R5102	CARBON R	R16J-100K	1	417341044T
PCB1	R5103	CARBON R	R16J-100K	1	417341044T
PCB1	R5104	CARBON R	R16J-100K	1	417341044T
PCB1	R5105	CARBON R	R16J-100K	1	417341044T
PCB1	R5106	CARBON R	R16J-100K	1	417341044T
PCB1	R5110	CARBON R	R16J-1K	1	417341024T
PCB1	R5111	CARBON R	R16J-1K	1	417341024T
PCB1	R5112	CARBON R	R16J-1K	1	417341024T
PCB1	R5113	CARBON R	R16J-1K	1	417341024T

PCB1	R5114	CARBON R	R16J-1K	1	417341024T
PCB1	R5115	CARBON R	R16J-1K	1	417341024T
PCB1	R5116	CARBON R	R16J-1K	1	417341024T
PCB1	R5130	CARBON R	R16J-18K	1	417341834T
PCB1	R5131	CARBON R	R16J-18K	1	417341834T
PCB1	R5132	CARBON R	R16J-18K	1	417341834T
PCB1	R5133	CARBON R	R16J-22K	1	417342234T
PCB1	R5134	CARBON R	R16J-22K	1	417342234T
PCB1	R5135	CARBON R	R16J-22K	1	417342234T
PCB1	R5136	CARBON R	R16J-22K	1	417342234T
PCB1	R5160	NF CARBON R	R25J-100	1	415471014T
PCB1	R5161	NF CARBON R	R25J-100	1	415471014T
PCB1	R5162	NF CARBON R	R25J-100	1	415471014T
PCB1	R5163	NF CARBON R	R25J-100	1	415471014T
PCB1	R5164	NF CARBON R	R25J-100	1	415471014T
PCB1	R5165	NF CARBON R	R25J-100	1	415471014T
PCB1	R5166	NF CARBON R	R25J-100	1	415471014T
PCB1	R5170	NF CARBON R	R25J-100	1	415471014T
PCB1	R5171	NF CARBON R	R25J-100	1	415471014T
PCB1	R5172	NF CARBON R	R25J-100	1	415471014T
PCB1	R5173	NF CARBON R	R25J-100	1	415471014T
PCB1	R5174	NF CARBON R	R25J-100	1	415471014T
PCB1	R5175	NF CARBON R	R25J-100	1	415471014T
PCB1	R5176	NF CARBON R	R25J-100	1	415471014T
PCB1	R5180	NF CARBON R	R25J-10	1	415471004T
PCB1	R5181	NF CARBON R	R25J-10	1	415471004T
PCB1	R5182	NF CARBON R	R25J-10	1	415471004T
PCB1	R5183	NF CARBON R	R25J-10	1	415471004T
PCB1	R5184	NF CARBON R	R25J-10	1	415471004T
PCB1	R5185	NF CARBON R	R25J-10	1	415471004T
PCB1	R5186	NF CARBON R	R25J-10	1	415471004T
PCB1	R5190	NF CARBON R	R25J-10	1	415471004T
PCB1	R5191	NF CARBON R	R25J-10	1	415471004T

PCB1	R5192	NF CARBON R	R25J-10	1	415471004T
PCB1	R5193	NF CARBON R	R25J-10	1	415471004T
PCB1	R5194	NF CARBON R	R25J-10	1	415471004T
PCB1	R5195	NF CARBON R	R25J-10	1	415471004T
PCB1	R5196	NF CARBON R	R25J-10	1	415471004T
PCB1	R5200	CARBON R	R16J-18K	1	417341834T
PCB1	R5201	CARBON R	R16J-18K	1	417341834T
PCB1	R5202	CARBON R	R16J-18K	1	417341834T
PCB1	R5203	CARBON R	R16J-22K	1	417342234T
PCB1	R5204	CARBON R	R16J-22K	1	417342234T
PCB1	R5205	CARBON R	R16J-22K	1	417342234T
PCB1	R5206	CARBON R	R16J-22K	1	417342234T
PCB1	R5230	CARBON R	R16J-120K	1	417341244T
PCB1	R5231	CARBON R	R16J-120K	1	417341244T
PCB1	R5232	CARBON R	R16J-120K	1	417341244T
PCB1	R5233	CARBON R	R16J-120K	1	417341244T
PCB1	R5234	CARBON R	R16J-120K	1	417341244T
PCB1	R5235	CARBON R	R16J-120K	1	417341244T
PCB1	R5236	CARBON R	R16J-120K	1	417341244T
PCB1	R5500	C-CARBON R	RN72K1J-331JE	1	435033314R1
PCB1	R5503	C-CARBON R	RN72K1J-331JE	1	435033314R1
PCB1	R5504	C-CARBON R	RN72K1J-331JE	1	435033314R1
PCB1	R5505	C-CARBON R	RN72K1J-222JE	1	435032224R1
PCB1	R5506	C-CARBON R	RN72K1J-222JE	1	435032224R1
PCB1	R5507	C-CARBON R	RN72K1J-331JE	1	435033314R1
PCB1	R5508	C-CARBON R	RN72K1J-331JE	1	435033314R1
PCB1	R5513	C-CARBON R	RN72K1J-331JE	1	435033314R1
PCB1	R5514	C-CARBON R	RN72K1J-331JE	1	435033314R1
PCB1	R5515	C-CARBON R	RN72K1J-222JE	1	435032224R1
PCB1	R5516	C-CARBON R	RN72K1J-222JE	1	435032224R1
PCB1	R5517	C-CARBON R	RN72K1J-331JE	1	435033314R1
PCB1	R5518	C-CARBON R	RN72K1J-331JE	1	435033314R1
PCB1	R5519	C-CARBON R	RN72K1J-331JE	1	435033314R1



PCB1	R5520	C-CARBON R	RN72K1J-331JE	1	435033314R1
PCB1	R5521	C-CARBON R	RN72K1J-331JE	1	435033314R1
PCB1	R5522	C-CARBON R	RN72K1J-331JE	1	435033314R1
PCB1	R5523	C-CARBON R	RN72K1J-331JE	1	435033314R1
PCB1	R5524	C-CARBON R	RN72K1J-331JE	1	435033314R1
PCB1	R5525	C-CARBON R	RN72K1J-331JE	1	435033314R1
PCB1	R5526	C-CARBON R	RN72K1J-331JE	1	435033314R1
PCB1	R5527	C-CARBON R	RN72K1J-331JE	1	435033314R1
PCB1	R5528	C-CARBON R	RN72K1J-331JE	1	435033314R1
PCB1	R5531	C-CARBON R	RN72K1J-101JE	1	435031014R1
PCB1	R5541	C-CARBON R	RN72K1J-224JE	1	435032244R1
PCB1	R5542	C-CARBON R	RN72K1J-224JE	1	435032244R1
PCB1	R5543	C-CARBON R	RN72K1J-224JE	1	435032244R1
PCB1	R5544	C-CARBON R	RN72K1J-224JE	1	435032244R1
PCB1	R5545	C-CARBON R	RN72K1J-224JE	1	435032244R1
PCB1	R5546	C-CARBON R	RN72K1J-224JE	1	435032244R1
PCB1	R5547	C-CARBON R	RN72K1J-224JE	1	435032244R1
PCB1	R5548	C-CARBON R	RN72K1J-224JE	1	435032244R1
PCB1	R5553	C-CARBON R	RN72K1J-224JE	1	435032244R1
PCB1	R5554	C-CARBON R	RN72K1J-224JE	1	435032244R1
PCB1	R5555	C-CARBON R	RN72K1J-224JE	1	435032244R1
PCB1	R5556	C-CARBON R	RN72K1J-224JE	1	435032244R1
PCB1	R5557	C-CARBON R	RN72K1J-224JE	1	435032244R1
PCB1	R5558	C-CARBON R	RN72K1J-224JE	1	435032244R1
PCB1	R5559	C-CARBON R	RN72K1J-224JE	1	435032244R1
PCB1	R5560	C-CARBON R	RN72K1J-224JE	1	435032244R1
PCB1	R5561	C-CARBON R	RN72K1J-224JE	1	435032244R1
PCB1	R5562	C-CARBON R	RN72K1J-224JE	1	435032244R1
PCB1	R5563	C-CARBON R	RN72K1J-224JE	1	435032244R1
PCB1	R5564	C-CARBON R	RN72K1J-224JE	1	435032244R1
PCB1	R5565	C-CARBON R	RN72K1J-224JE	1	435032244R1
PCB1	R5566	C-CARBON R	RN72K1J-224JE	1	435032244R1
PCB1	R5567	C-CARBON R	RN72K1J-222JE	1	435032224R1

PCB1	R5568	C-CARBON R	RN72K1J-222JE	1	435032224R1
PCB1	R5571	C-CARBON R	RN72K1J-223JE	1	435032234R1
PCB1	R5575	C-CARBON R	RN72K1J-224JE	1	435032244R1
PCB1	R5576	C-CARBON R	RN72K1J-224JE	1	435032244R1
PCB1	R5577	C-CARBON R	RN72K1J-103JE	1	435031034R1
PCB1	R5578	C-CARBON R	RN72K1J-103JE	1	435031034R1
PCB1	R5579	C-CARBON R	RN72K1J-224JE	1	435032244R1
PCB1	R5585	C-CARBON R	RN72K1J-182JE	1	435031824R1
PCB1	R5586	C-CARBON R	RN72K1J-182JE	1	435031824R1
PCB1	R5587	C-CARBON R	RN72K1J-103JE	1	435031034R1
PCB1	R5588	C-CARBON R	RN72K1J-103JE	1	435031034R1
PCB1	R5589	CARBON R	R16J-1K	1	417341024T
PCB1	R5590	C-CARBON R	RN72K1J-103JE	1	435031034R1
PCB1	R5591	C-CARBON R	RN72K1J-103JE	1	435031034R1
PCB1	R5592	C-CARBON R	RN72K1J-471JE	1	435034714R1
PCB1	R5593	C-CARBON R	RN72K1J-122JE	1	435031224R1
PCB1	R5594	C-CARBON R	RN72K1J-103JE	1	435031034R1
PCB1	R5595	C-CARBON R	RN72K1J-103JE	1	435031034R1
PCB1	R5596	C-CARBON R	RN72K1J-471JE	1	435034714R1
PCB1	R5597	C-CARBON R	RN72K1J-122JE	1	435031224R1
PCB1	R5598	C-CARBON R	RN72K1J-103JE	1	435031034R1
PCB1	R5599	C-CARBON R	RN72K1J-103JE	1	435031034R1
PCB1	R5600	C-CARBON R	RN72K1J-224JE	1	435032244R1
PCB1	R5601	C-CARBON R	RN72K1J-224JE	1	435032244R1
PCB1	R5602	C-CARBON R	RN72K1J-224JE	1	435032244R1
PCB1	R5603	C-CARBON R	RN72K1J-224JE	1	435032244R1
PCB1	R5604	C-CARBON R	RN72K1J-224JE	1	435032244R1
PCB1	R5605	C-CARBON R	RN72K1J-224JE	1	435032244R1
PCB1	R5606	C-CARBON R	RN72K1J-224JE	1	435032244R1
PCB1	R5607	C-CARBON R	RN72K1J-224JE	1	435032244R1
PCB1	R5608	C-CARBON R	RN72K1J-224JE	1	435032244R1
PCB1	R5609	C-CARBON R	RN72K1J-224JE	1	435032244R1
PCB1	R5610	C-CARBON R	RN72K1J-271JE	1	435032714R1

PCB1	R5611	C-CARBON R	RN72K1J-222JE	1	435032224R1
PCB1	R5612	C-CARBON R	RN72K1J-222JE	1	435032224R1
PCB1	R5613	C-CARBON R	RN72K1J-222JE	1	435032224R1
PCB1	R5614	C-CARBON R	RN72K1J-222JE	1	435032224R1
PCB1	R5615	C-CARBON R	RN72K1J-222JE	1	435032224R1
PCB1	R5616	C-CARBON R	RN72K1J-222JE	1	435032224R1
PCB1	R5617	C-CARBON R	RN72K1J-222JE	1	435032224R1
PCB1	R5618	C-CARBON R	RN72K1J-222JE	1	435032224R1
PCB1	R5619	C-CARBON R	RN72K1J-222JE	1	435032224R1
PCB1	R5620	C-CARBON R	RN72K1J-101JE	1	435031014R1
PCB1	R5621	C-CARBON R	RN72K1J-000JE	1	435030004R1
PCB1	R5622	C-CARBON R	RN72K1J-000JE	1	435030004R1
PCB1	R5623	C-CARBON R	RN72K1J-000JE	1	435030004R1
PCB1	R5624	C-CARBON R	RN72K1J-000JE	1	435030004R1
PCB1	R5625	C-CARBON R	RN72K1J-000JE	1	435030004R1
PCB1	R5626	C-CARBON R	RN72K1J-000JE	1	435030004R1
PCB1	R5627	C-CARBON R	RN72K1J-000JE	1	435030004R1
PCB1	R5630	C-CARBON R	RN72K1J-221JE	1	435032214R1
PCB1	R5631	C-CARBON R	RN72K1J-473JE	1	435034734R1
PCB1	R5632	C-CARBON R	RN72K1J-153JE	1	435031534R1
PCB1	R5633	C-CARBON R	RN72K1J-122JE	1	435031224R1
PCB1	R5634	C-CARBON R	RN72K1J-103JE	1	435031034R1
PCB1	R5660	METAL R	RNU1WCJ-2.2	1	453630224T
PCB1	R5661	METAL R	RNU1WCJ-2.2	1	453630224T
PCB1	R5666	CARBON R	R16J-22	1	417342204T
PCB1	R5667	CARBON R	R16J-22	1	417342204T
PCB1	R5670	METAL O R	RS2WBJ-10	1	441721004F
PCB1	R5671	METAL O R	RS2WBJ-27	1	441722704F
PCB1	R5672	METAL O R	RS2WBJ-10	1	441721004F
PCB1	R5673	METAL O R	RS2WBJ-27	1	441722704F
PCB1	R5674	METAL O R	RS1WBJ-68	1	443626804T
PCB1	R5675	METAL O R	RS1WBJ-68	1	443626804T
PCB1	R5680	C-CARBON R	RN72K1J-224JE	1	435032244R1

PCB1	R5681	C-CARBON R	RN72K1J-224JE	1	435032244R1
PCB1	R5682	C-CARBON R	RN72K1J-224JE	1	435032244R1
PCB1	R5683	METAL O R	RS1WBJ-68	1	443626804T
PCB1	R5684	METAL O R	RS1WBJ-68	1	443626804T
PCB1	R5689	C-CARBON R	RN72K1J-224JE	1	435032244R1
PCB1	R5690	C-CARBON R	RN72K1J-224JE	1	435032244R1
PCB1	R5691	C-CARBON R	RN72K1J-224JE	1	435032244R1
PCB1	R5692	C-CARBON R	RN72K1J-224JE	1	435032244R1
PCB1	R5693	C-CARBON R	RN72K1J-224JE	1	435032244R1
PCB1	R5694	C-CARBON R	RN72K1J-224JE	1	435032244R1
PCB1	R5695	C-CARBON R	RN72K1J-224JE	1	435032244R1
PCB1	R5813	C-CARBON R	RN72K1J-000JE	1	435030004R1
PCB1	R5820	C-CARBON R	RN72K1J-000JE	1	435030004R1
PCB1	R5822	C-CARBON R	RN72K1J-000JE	1	435030004R1
PCB1	R5823	C-CARBON R	RN72K1J-000JE	1	435030004R1
PCB1	R5824	C-CARBON R	RN72K1J-000JE	1	435030004R1
PCB1	R5825	C-CARBON R	RN72K1J-000JE	1	435030004R1
PCB1	R5826	C-CARBON R	RN72K1J-000JE	1	435030004R1
PCB1	R6000	CARBON R	R16J-5.6K	1	417345624T
PCB1	R6001	CARBON R	R16J-5.6K	1	417345624T
PCB1	R6002	CARBON R	R16J-5.6K	1	417345624T
PCB1	R6003	CARBON R	R16J-5.6K	1	417345624T
PCB1	R6004	CARBON R	R16J-5.6K	1	417345624T
PCB1	R6005	CARBON R	R16J-5.6K	1	417345624T
PCB1	R6006	CARBON R	R16J-5.6K	1	417345624T
PCB1	R6010	CARBON R	R16J-3.9K	1	417343924T
PCB1	R6011	CARBON R	R16J-3.9K	1	417343924T
PCB1	R6012	CARBON R	R16J-3.9K	1	417343924T
PCB1	R6013	CARBON R	R16J-3.9K	1	417343924T
PCB1	R6014	CARBON R	R16J-3.9K	1	417343924T
PCB1	R6015	CARBON R	R16J-3.9K	1	417343924T
PCB1	R6016	CARBON R	R16J-3.9K	1	417343924T
PCB1	R6020	NF CARBON R	R25J-2.2	1	415470224T

PCB1	R6021	NF CARBON R	R25J-2.2	1	415470224T
PCB1	R6022	NF CARBON R	R25J-2.2	1	415470224T
PCB1	R6023	NF CARBON R	R25J-2.2	1	415470224T
PCB1	R6024	NF CARBON R	R25J-2.2	1	415470224T
PCB1	R6025	NF CARBON R	R25J-2.2	1	415470224T
PCB1	R6026	NF CARBON R	R25J-2.2	1	415470224T
PCB1	R6030	CARBON R	R16J-470	1	417344714T
PCB1	R6031	CARBON R	R16J-470	1	417344714T
PCB1	R6032	CARBON R	R16J-470	1	417344714T
PCB1	R6033	CARBON R	R16J-470	1	417344714T
PCB1	R6034	CARBON R	R16J-470	1	417344714T
PCB1	R6035	CARBON R	R16J-470	1	417344714T
PCB1	R6036	CARBON R	R16J-470	1	417344714T
PCB1	R6040	TRIM R	N06HR2KBC	1	5210390T
PCB1	R6041	TRIM R	N06HR2KBC	1	5210390T
PCB1	R6042	TRIM R	N06HR2KBC	1	5210390T
PCB1	R6043	TRIM R	N06HR2KBC	1	5210390T
PCB1	R6044	TRIM R	N06HR2KBC	1	5210390T
PCB1	R6045	TRIM R	N06HR2KBC	1	5210390T
PCB1	R6046	TRIM R	N06HR2KBC	1	5210390T
PCB1	R6050	CARBON R	R16J-3.3K	1	417343324T
PCB1	R6051	CARBON R	R16J-3.3K	1	417343324T
PCB1	R6052	CARBON R	R16J-3.3K	1	417343324T
PCB1	R6053	CARBON R	R16J-3.3K	1	417343324T
PCB1	R6054	CARBON R	R16J-3.3K	1	417343324T
PCB1	R6055	CARBON R	R16J-3.3K	1	417343324T
PCB1	R6056	CARBON R	R16J-3.3K	1	417343324T
PCB1	R6070	NF CARBON R	R25J-82	1	415478204T
PCB1	R6071	NF CARBON R	R25J-82	1	415478204T
PCB1	R6072	NF CARBON R	R25J-82	1	415478204T
PCB1	R6073	NF CARBON R	R25J-100	1	415471014T
PCB1	R6074	NF CARBON R	R25J-100	1	415471014T
PCB1	R6075	NF CARBON R	R25J-100	1	415471014T

PCB1	R6076	NF CARBON R	R25J-100	1	415471014T
PCB1	R6080	NF CARBON R	R25J-0.22	1	415472294T
PCB1	R6081	NF CARBON R	R25J-0.22	1	415472294T
PCB1	R6082	NF CARBON R	R25J-0.22	1	415472294T
PCB1	R6083	NF CARBON R	R25J-0.22	1	415472294T
PCB1	R6084	NF CARBON R	R25J-0.22	1	415472294T
PCB1	R6085	NF CARBON R	R25J-0.22	1	415472294T
PCB1	R6086	NF CARBON R	R25J-0.22	1	415472294T
PCB1	R6090	NF CARBON R	R25J-0.22	1	415472294T
PCB1	R6091	NF CARBON R	R25J-0.22	1	415472294T
PCB1	R6092	NF CARBON R	R25J-0.22	1	415472294T
PCB1	R6093	NF CARBON R	R25J-0.22	1	415472294T
PCB1	R6094	NF CARBON R	R25J-0.22	1	415472294T
PCB1	R6095	NF CARBON R	R25J-0.22	1	415472294T
PCB1	R6096	NF CARBON R	R25J-0.22	1	415472294T
PCB1	R6100	METAL PR	MPR2W+2W 0R22	1	4000234
PCB1	R6101	METAL PR	MPR2W+2W 0R22	1	4000234
PCB1	R6102	METAL PR	MPR2W+2W 0R22	1	4000234
PCB1	R6103	METAL PR	MPR2W+2W 0R22	1	4000234
PCB1	R6104	METAL PR	MPR2W+2W 0R22	1	4000234
PCB1	R6105	METAL PR	MPR2W+2W 0R22	1	4000234
PCB1	R6106	METAL PR	MPR2W+2W 0R22	1	4000234
PCB1	R6130	METAL R	RNU1WCJ-8.2	1	453630824T
PCB1	R6131	METAL R	RNU1WCJ-8.2	1	453630824T
PCB1	R6132	METAL R	RNU1WCJ-8.2	1	453630824T
PCB1	R6133	METAL R	RNU1WCJ-8.2	1	453630824T
PCB1	R6134	METAL R	RNU1WCJ-8.2	1	453630824T
PCB1	R6135	METAL R	RNU1WCJ-8.2	1	453630824T
PCB1	R6136	METAL R	RNU1WCJ-8.2	1	453630824T
PCB1	R6140	C-CARBON R	RN72K1J-223JE	1	435032234R1
PCB1	R6141	C-CARBON R	RN72K1J-223JE	1	435032234R1
PCB1	R6142	C-CARBON R	RN72K1J-223JE	1	435032234R1
PCB1	R6143	C-CARBON R	RN72K1J-223JE	1	435032234R1

PCB1	R6144	C-CARBON R	RN72K1J-223JE	1	435032234R1
PCB1	R6145	C-CARBON R	RN72K1J-223JE	1	435032234R1
PCB1	R6146	C-CARBON R	RN72K1J-223JE	1	435032234R1
PCB1	R6150	C-CARBON R	RN72K1J-123JE	1	435031234R1
PCB1	R6151	C-CARBON R	RN72K1J-123JE	1	435031234R1
PCB1	R6152	C-CARBON R	RN72K1J-123JE	1	435031234R1
PCB1	R6153	C-CARBON R	RN72K1J-123JE	1	435031234R1
PCB1	R6154	C-CARBON R	RN72K1J-123JE	1	435031234R1
PCB1	R6155	C-CARBON R	RN72K1J-123JE	1	435031234R1
PCB1	R6156	C-CARBON R	RN72K1J-123JE	1	435031234R1
PCB1	R6160	CARBON R	R16J-33K	1	417343334T
PCB1	R6161	CARBON R	R16J-33K	1	417343334T
PCB1	R6162	CARBON R	R16J-33K	1	417343334T
PCB1	R6163	CARBON R	R16J-33K	1	417343334T
PCB1	R6164	CARBON R	R16J-33K	1	417343334T
PCB1	R6165	CARBON R	R16J-33K	1	417343334T
PCB1	R6166	CARBON R	R16J-33K	1	417343334T
PCB1	R6170	CARBON R	R16J-47K	1	417344734T
PCB1	R6171	CARBON R	R16J-47K	1	417344734T
PCB1	R6172	CARBON R	R16J-47K	1	417344734T
PCB1	R6173	CARBON R	R16J-47K	1	417344734T
PCB1	R6174	CARBON R	R16J-47K	1	417344734T
PCB1	R6175	CARBON R	R16J-47K	1	417344734T
PCB1	R6176	CARBON R	R16J-47K	1	417344734T
PCB1	R6180	CARBON R	R16J-47K	1	417344734T
PCB1	R6181	CARBON R	R16J-47K	1	417344734T
PCB1	R6182	CARBON R	R16J-47K	1	417344734T
PCB1	R6183	CARBON R	R16J-47K	1	417344734T
PCB1	R6184	CARBON R	R16J-47K	1	417344734T
PCB1	R6185	CARBON R	R16J-47K	1	417344734T
PCB1	R6186	CARBON R	R16J-47K	1	417344734T
PCB1	R6190	C-CARBON R	RN72K1J-224JE	1	435032244R1
PCB1	R6191	C-CARBON R	RN72K1J-224JE	1	435032244R1

PCB1	R6192	C-CARBON R	RN72K1J-224JE	1	435032244R1	
PCB1	R6193	C-CARBON R	RN72K1J-224JE	1	435032244R1	
PCB1	R6194	C-CARBON R	RN72K1J-224JE	1	435032244R1	
PCB1	R6195	C-CARBON R	RN72K1J-224JE	1	435032244R1	
PCB1	R6196	C-CARBON R	RN72K1J-224JE	1	435032244R1	
PCB1	R6197	METAL R	RNU1WCJ-8.2	1	453630824T	
PCB1	R6701	C-CARBON R	RN72K1J-223JE	1	435032234R1	
PCB1	R6702	C-CARBON R	RN72K1J-103JE	1	435031034R1	
PCB1	R6704	C-CARBON R	RN72K1J-473JE	1	435034734R1	
PCB1	R6706	C-CARBON R	RN72K1J-224JE	1	435032244R1	
PCB1	R6708	C-CARBON R	RN72K1J-333JE	1	435033334R1	
PCB1	R6709	C-CARBON R	RN72K1J-562JE	1	435035624R1	
PCB1	R6710	C-CARBON R	RN72K1J-562JE	1	435035624R1	
PCB1	R6902	C-CARBON R	RN72K1J-102JE	1	435031024R1	
PCB1	R6903	C-CARBON R	RN72K1J-473JE	1	435034734R1	
PCB1	RL6901	RELAY	NRL-1P10A-DC12-140	1	25065584	!
PCB1	RL6901 or	RELAY	NRL-1P10A-DC12-143	(1)	25065588	!
PCB1	RL6902	RELAY	NRL-1P10A-DC12-140	1	25065584	!
PCB1	RL6902 or	RELAY	NRL-1P10A-DC12-143	(1)	25065588	!
PCB1	P302	PLUG	NPLG-15P0970	1	25056020	
PCB1	P303	PLUG	NPLG-15P0970	1	25056020	
PCB1	P304	PLUG	NPLG-3P0958	1	25056008	
PCB1	P5505	TRM-423(SCREW)	NEJITANSI ST3	1	25060495	
PCB1	P6080	PLUG	NPLG-2P130	1	25055146	
PCB1	P6081	PLUG	NPLG-2P130	1	25055146	
PCB1	P6082	PLUG	NPLG-2P130	1	25055146	
PCB1	P6083	PLUG	NPLG-2P130	1	25055146	
PCB1	P6084	PLUG	NPLG-2P130	1	25055146	
PCB1	P6085	PLUG	NPLG-2P130	1	25055146	
PCB1	P6086	PLUG	NPLG-2P130	1	25055146	
PCB1	P6101	CLAMP	WS-2NS	1	27300833	
PCB1	P6602	TRM	NTM-4PDML422	1	25060494	
PCB1	P6900	CRIMP AS	CRIMP AS	1	20799162UL	



PCB1	P6901	CRIMP AS	CRIMP AS	1	2069925226UL	
PCB1	P6902	CRIMP AS	CRIMP AS	1	2069925189UL	
PCB1	P6903	CRIMP AS	CRIMP AS	1	20799163UL	
PCB1	P6904	CRIMP AS	CRIMP AS	1	20799164UL	
PCB1	P6911	RETAINER	(BUS)	1	27142022	
PCB1	P6991	TRM-423(SCREW)	NEJITANSI ST3	1	25060495	
PCB1	P7900	ST JACK	MSJ-035-22	1	25045887	
PCB1	P7900 or	JACK	YKB21-5130	(1)	25045387	
PCB1	P7902	PIN JACK	NPJ-6PDWWWRRR561	1	25045779	
PCB1	P7902 or	PIN JACK	NPJ-6PDBL159	(1)	25045300	
PCB1	P7904	PIN JACK	NPJ-6PDWWWRRR561	1	25045779	
PCB1	P7904 or	PIN JACK	NPJ-6PDBL159	(1)	25045300	
PCB1	P7905	PIN JACK	NPJ-4PDWLRE642	1	25045866	
PCB1	P7906	PIN JACK	NPJ-4PDGNPT643	1	25045867	
PCB1	P7907	PIN JACK	NPJ-2PDWR558	1	25045776	
PCB1	P7907 or	PIN JACK	NPJ-2PDBL185	(1)	25045333	
PCB1	P7908	PIN JACK	NPJ-1PDP555	1	25045773	
PCB1	F6901C	FUSE HOL	NSCT-1P2031	1	25052133T	
PCB1	F6901D	FUSE HOL	NSCT-1P2031	1	25052133T	
PCB1	F6902C	FUSE HOL	NSCT-1P2031	1	25052133T	
PCB1	F6902D	FUSE HOL	NSCT-1P2031	1	25052133T	
PCB1	J5500	PVC	1007#24 .2/7HAND B	1	---	NSP
PCB1	J5500 or	PVC	1007#24 .2/7HAND R	(1)	---	NSP
PCB1	JL6402	JUMPER LEAD	JL3 300 B	1	---	NSP
PCB1	JL6402A	WIRE HOL	NSCT-3P874	1	25051087	
PCB1	JL6600	JUMPER LEAD	JL7 250 H	1	---	NSP
PCB1	JL6600A	WIRE HOL	NSCT-7P898	1	25051111	
PCB1	JL6603	JUMPER LEAD	JL9 200 H	1	---	NSP
PCB1	JL6603A	WIRE HOL	NSCT-9P900	1	25051113	
PCB1	JL6604	JUMPER LEAD	JL5 200 H	1	---	NSP
PCB1	JL6604A	WIRE HOL	NSCT-5P896	1	25051109	
PCB1	JL6952	JUMPER LEAD	JL5 150 H	1	---	NSP
PCB1	JL6952A	WIRE HOL	NSCT-5P896	1	25051109	

PCB1	JL6952B	WIRE HOL	NSCT-5P896	1	25051109	
PCB2	<b>U10</b>	DISPLAY PC BOARD (NADIS-9430-1A / 1B)				
PCB2	<b>U11</b>	SWITCH PC BOARD (NADIS-9431-1A / 1B)				
PCB2	<b>U12</b>	POWER SUPPLY PC BOARD (NAPS-9432-1A / 1B)				
PCB2	<b>U13</b>	TRANS. SEC. TERMINAL PC BOARD (NAPS-9433-1A / 1B)				
PCB2	<b>U14</b>	HEADPHONE JACK PC BOARD (NAETC-9435-1A / 1B)				
PCB2						
PCB2	<b>CIRCUIT NO.</b>	<b>PART NAME</b>	<b>DESCRIPTION</b>	<b>Q'TY</b>	<b>PART NO. (SN)</b>	<b>REMARKS</b>
PCB2	U7041	REMO SENS	NJL34H380A	1	241365	
PCB2	Q7001	FL TUBE	16-BT-138GNK	1	212268	
PCB2	Q7001A	HOLDER	(FL)	1	27191222C	
PCB2	Q7003	IC	M66005-0001AHP	1	22242208R3	
PCB2	Q7004	TR	2SC2458-GR	1	2212115T	
PCB2	Q7004 or	TR	2SC1740S-R	(1)	2213284T	
PCB2	Q7004 or	TR	2SC1740S-S	(1)	2213285T	
PCB2	Q7005	TR	KRA102M	1	2215770T	
PCB2	Q7005 or	TR	DTA114ES	(1)	2213510T	
PCB2	Q7007	TR	KRC102M	1	2215960T	
PCB2	Q7007 or	TR	DTC114ES	(1)	2213290T	
PCB2	Q7033	TR	KTC3198-GR	1	2215985T	
PCB2	Q7033 or	TR	2SC1815-GR	(1)	2211255T	
PCB2	Q7151	TR	2SA1015-GR	1	2211455T	<PP, PA>
PCB2	Q7152	TR	2SA1015-GR	1	2211455T	
PCB2	Q7401	IC	NJM4580D-D	1	22241112	
PCB2	Q7403	TR	KRC111M	1	2216320T	
PCB2	Q7403 or	TR	DTC114TS	(1)	221299T	
PCB2	Q7404	TR	KRC111M	1	2216320T	
PCB2	Q7404 or	TR	DTC114TS	(1)	221299T	
PCB2	D911	DIODE	1SS133	1	223163T	
PCB2	D912	DIODE	1SS133	1	223163T	
PCB2	D921	DIODE	1SS133	1	223163T	
PCB2	D922	DIODE	1SS133	1	223163T	

PCB2	D923	DIODE	ISS133	1	223163T	
PCB2	D924	DIODE	ISS133	1	223163T	
PCB2	D925	DIODE	ISS133	1	223163T	
PCB2	D930	DIODE	ISS133	1	223163T	
PCB2	D931	DIODE	ISS133	1	223163T	
PCB2	D933	DIODE	ISS133	1	223163T	
PCB2	D934	ZENER D	MTZJ5.6B	1	224470562T	
PCB2	D935	DIODE	ISS133	1	223163T	
PCB2	D7002	ZENER D	MTZJ8.2B	1	224470822T	
PCB2	D7033	ZENER D	MTZJ3.9B	1	224470392T	
PCB2	D7151	LED	SLI-343URC-TE7	1	225449T	
PCB2	D7153	LED	SDPB3DD0C0000-ABCDEF	1	225473	<PP, PA>
PCB2	D7156	LED	SLR-342MGTE7P	1	225455T	
PCB2	D7401	ZENER D	MTZJ5.1B	1	224470512T	
PCB2	D7411	ZENER D	MTZJ6.8B	1	224470682T	
PCB2	D7412	ZENER D	MTZJ6.8B	1	224470682T	
PCB2	T902	P TRANS	NPT-1520JQ	1	2301812A	!, <DD, DC>
PCB2	T902	P TRANS	NPT-1520GQ	1	2301813A	!, <PP, PA>
PCB2	L7031	CHOKO COIL	NCH-1561 022K	1	233526K022T	
PCB2	L7201	CHOKO COIL	NCH-1561 022K	1	233526K022T	
PCB2	L7202	CHOKO COIL	NCH-1561 022K	1	233526K022T	
PCB2	L7203	CHOKO COIL	NCH-1561 022K	1	233526K022T	
PCB2	L7401	CHOKO COIL	NCH-1561 022K	1	233526K022T	
PCB2	L7402	CHOKO COIL	NCH-1561 022K	1	233526K022T	
PCB2	C901	IS C	LE103-C3.5	1	3800042S	!
PCB2	C901 or	IS C	ECQU2A103MLC	(1)	3800039S	!
PCB2	C902	TF C	ECQ-V50V-104J	1	374721044T	
PCB2	C911	TF C	ECQ-B50V-102J	1	374721024T	
PCB2	C921	CERA C	CK45F50V-223Z	1	335622230T	
PCB2	C922	VR C	CE04W25V-2200M(VR)	1	394652227S	<DD, DC>
PCB2	C922	VR C	CE04W16V-2200M(VR)	1	394642227S	<PP, PA>
PCB2	C930	UTSP C	CE04W50V-100M(UTSP)	1	397581017T	
PCB2	C933	UTSP C	CE04W50V-4.7M(UTSP)	1	397580477T	

PCB2	C7001	CERA C	CK45F50V-223Z	1	335622230T
PCB2	C7002	MMT C	MMT50V-104J	1	375521044T
PCB2	C7003	CERA C	CC45SL50V-101J	1	345021014T
PCB2	C7004	CERA C	CC45SL50V-101J	1	345021014T
PCB2	C7005	CERA C	CC45SL50V-101J	1	345021014T
PCB2	C7007	CERA C	CC45SL50V-101J	1	345021014T
PCB2	C7008	UTSP C	CE04W10V-100M(UTSP)	1	397531017T
PCB2	C7009	MMT C	MMT50V-104J	1	375521044T
PCB2	C7010	CERA C	CK45F50V-223Z	1	335622230T
PCB2	C7011	CERA C	CK45F50V-223Z	1	335622230T
PCB2	C7012	CERA C	CK45F50V-223Z	1	335622230T
PCB2	C7013	UTSP C	CE04W50V-47M(UTSP)	1	397584707T
PCB2	C7014	CERA C	CK45F50V-223Z	1	335622230T
PCB2	C7015	ELECT C	CE04W16V-47M(S)	1	353744709T
PCB2	C7016	CERA C	CK45F50V-223Z	1	335622230T
PCB2	C7017	CERA C	CK45F50V-223Z	1	335622230T
PCB2	C7021	CERA C	CK45F50V-103Z	1	335621030T
PCB2	C7022	CERA C	CK45F50V-103Z	1	335621030T
PCB2	C7031	CERA C	CK45F50V-223Z	1	335622230T
PCB2	C7032	CERA C	CK45F50V-223Z	1	335622230T
PCB2	C7033	UTSP C	CE04W50V-10M(UTSP)	1	397581007T
PCB2	C7041	ELECT C	CE04W6.3V-100M(S)	1	353721019T
PCB2	C7043	CERA C	CK45B50V-102K	1	335321025T
PCB2	C7201	TF C	ECQ-B50V-102J	1	374721024T
PCB2	C7202	TF C	ECQ-B50V-223J	1	374722234T
PCB2	C7203	TF C	ECQ-B50V-102J	1	374721024T
PCB2	C7204	TF C	ECQ-B50V-102J	1	374721024T
PCB2	C7301	TF C	ECQ-B50V-471J	1	374724714T
PCB2	C7302	TF C	ECQ-B50V-471J	1	374724714T
PCB2	C7303	MMT C	MMT50V-104J	1	375521044T
PCB2	C7304	MMT C	MMT50V-104J	1	375521044T
PCB2	C7305	MMT C	MMT50V-104J	1	375521044T
PCB2	C7401	UTSP C	CE04W50V-10M(UTSP)	1	397581007T

PCB2	C7402	CERA C	CC45SL50V-101J	1	345021014T
PCB2	C7403	UTSP C	CE04W25V-47M(UTSP)	1	397554707T
PCB2	C7404	CERA C	CC45SL50V-330J	1	345023304T
PCB2	C7405	ELECT C	CE04W16V-10M(S)	1	353741009T
PCB2	C7411	UTSP C	CE04W25V-47M(UTSP)	1	397554707T
PCB2	C7412	UTSP C	CE04W25V-47M(UTSP)	1	397554707T
PCB2	C7421	CERA C	CK45B50V-102K	1	335321025T
PCB2	C9101	MMT C	MMT50V-104J	1	375521044T
PCB2	R921	METAL O R	RS1/2WBJ-47	1	443524704T
PCB2	R934	CARBON R	R16J-100K	1	417341044T
PCB2	R7001	CARBON R	R16J-100K	1	417341044T
PCB2	R7002	CARBON R	R16J-3.3K	1	417343324T
PCB2	R7003	CARBON R	R16J-3.3K	1	417343324T
PCB2	R7004	CARBON R	R16J-220	1	417342214T
PCB2	R7005	CARBON R	R16J-220	1	417342214T
PCB2	R7006	CARBON R	R16J-18K	1	417341834T
PCB2	R7007	CARBON R	R16J-220	1	417342214T
PCB2	R7008	CARBON R	R16J-220	1	417342214T
PCB2	R7021	CARBON R	R16J-10K	1	417341034T
PCB2	R7022	CARBON R	R16J-10K	1	417341034T
PCB2	R7023	CARBON R	R16J-10K	1	417341034T
PCB2	R7024	CARBON R	R16J-10K	1	417341034T
PCB2	R7033	CARBON R	R16J-82	1	417348204T
PCB2	R7041	CARBON R	R16J-100	1	417341014T
PCB2	R7042	CARBON R	R16J-1K	1	417341024T
PCB2	R7101	CARBON R	R16J-330	1	417343314T
PCB2	R7102	CARBON R	R16J-470	1	417344714T
PCB2	R7103	CARBON R	R16J-560	1	417345614T
PCB2	R7104	CARBON R	R16J-820	1	417348214T
PCB2	R7105	CARBON R	R16J-1.2K	1	417341224T
PCB2	R7107	CARBON R	R16J-330	1	417343314T
PCB2	R7108	CARBON R	R16J-470	1	417344714T
PCB2	R7109	CARBON R	R16J-560	1	417345614T

PCB2	R7110	CARBON R	R16J-820	1	417348214T	
PCB2	R7111	CARBON R	R16J-1.2K	1	417341224T	
PCB2	R7112	CARBON R	R16J-2.2K	1	417342224T	
PCB2	R7113	CARBON R	R16J-3.9K	1	417343924T	
PCB2	R7114	CARBON R	R16J-12K	1	417341234T	
PCB2	R7115	CARBON R	R16J-330	1	417343314T	
PCB2	R7116	CARBON R	R16J-470	1	417344714T	
PCB2	R7117	CARBON R	R16J-560	1	417345614T	
PCB2	R7118	CARBON R	R16J-820	1	417348214T	
PCB2	R7119	CARBON R	R16J-1.2K	1	417341224T	
PCB2	R7120	CARBON R	R16J-2.2K	1	417342224T	
PCB2	R7121	CARBON R	R16J-3.9K	1	417343924T	
PCB2	R7122	CARBON R	R16J-12K	1	417341234T	
PCB2	R7123	CARBON R	R16J-330	1	417343314T	
PCB2	R7124	CARBON R	R16J-470	1	417344714T	
PCB2	R7125	CARBON R	R16J-560	1	417345614T	
PCB2	R7126	CARBON R	R16J-820	1	417348214T	
PCB2	R7127	CARBON R	R16J-1.2K	1	417341224T	
PCB2	R7128	CARBON R	R16J-2.2K	1	417342224T	
PCB2	R7129	CARBON R	R16J-3.9K	1	417343924T	
PCB2	R7130	CARBON R	R16J-12K	1	417341234T	
PCB2	R7151	CARBON R	R16J-2.2K	1	417342224T	
PCB2	R7152	CARBON R	R16J-82	1	417348204T	<PP, PA>
PCB2	R7154	CARBON R	R16J-120	1	417341214T	
PCB2	R7155	CARBON R	R16J-10K	1	417341034T	<PP, PA>
PCB2	R7156	CARBON R	R16J-1K	1	417341024T	<PP, PA>
PCB2	R7157	CARBON R	R16J-10K	1	417341034T	
PCB2	R7158	CARBON R	R16J-1K	1	417341024T	
PCB2	R7301	CARBON R	R16J-330	1	417343314T	
PCB2	R7302	CARBON R	R16J-330	1	417343314T	
PCB2	R7401	CARBON R	R16J-100	1	417341014T	
PCB2	R7402	CARBON R	R16J-220K	1	417342244T	
PCB2	R7403	CARBON R	R16J-4.7K	1	417344724T	

PCB2	R7404	CARBON R	R16J-220	1	417342214T	
PCB2	R7405	CARBON R	R16J-47K	1	417344734T	
PCB2	R7406	CARBON R	R16J-330	1	417343314T	
PCB2	R7407	CARBON R	R16J-1K	1	417341024T	
PCB2	R7408	CARBON R	R16J-33K	1	417343334T	
PCB2	R7409	CARBON R	R16J-220	1	417342214T	
PCB2	R7410	CARBON R	R16J-220	1	417342214T	
PCB2	R7411	CARBON R	R16J-470	1	417344714T	
PCB2	R7412	CARBON R	R16J-470	1	417344714T	
PCB2	R7413	CARBON R	R16J-220K	1	417342244T	
PCB2	R7414	CARBON R	R16J-100K	1	417341044T	
PCB2	R9101	METAL R	RNU1/2WCJ-0.1	1	453531094T	!, <DD, DC>
PCB2	R9101	METAL R	RNU1/2WCJ-0.22	1	453532294T	!, <PP, PA>
PCB2	R9102	METAL R	RNU1/2WCJ-8.2	1	453530824T	
PCB2	RL901	RELAY	NRL-1P5A-DC9-179	1	25065669	!
PCB2	S7001	R ENCODE	EC12E2425WITH WASHER	1	25065655W	
PCB2	S7101	PUSH SW	NPS-111-S681	1	25035718T	
PCB2	S7104	PUSH SW	NPS-111-S681	1	25035718T	
PCB2	S7106	PUSH SW	NPS-111-S681	1	25035718T	
PCB2	S7107	PUSH SW	NPS-111-S681	1	25035718T	
PCB2	S7109	PUSH SW	NPS-111-S681	1	25035718T	
PCB2	S7115	PUSH SW	NPS-111-S681	1	25035718T	
PCB2	S7117	PUSH SW	NPS-111-S681	1	25035718T	
PCB2	S7119	PUSH SW	NPS-111-S681	1	25035718T	
PCB2	S7123	PUSH SW	NPS-111-S681	1	25035718T	
PCB2	S7125	PUSH SW	NPS-111-S681	1	25035718T	
PCB2	S7127	PUSH SW	NPS-111-S681	1	25035718T	
PCB2	S7129	PUSH SW	NPS-111-S681	1	25035718T	
PCB2	S7132	PUSH SW	NPS-111-S681	1	25035718T	
PCB2	S7134	PUSH SW	NPS-111-S681	1	25035718T	
PCB2	S7136	PUSH SW	NPS-111-S681	1	25035718T	
PCB2	S7138	PUSH SW	NPS-111-S681	1	25035718T	
PCB2	S7140	PUSH SW	NPS-111-S681	1	25035718T	

PCB2	S7142	PUSH SW	NPS-111-S681	1	25035718T	
PCB2	S7144	PUSH SW	NPS-111-S681	1	25035718T	
PCB2	S7146	PUSH SW	NPS-111-S681	1	25035718T	
PCB2	S7148	PUSH SW	NPS-111-S681	1	25035718T	
PCB2	S7149	PUSH SW	NPS-111-S681	1	25035718T	
PCB2	S7151	PUSH SW	NPS-111-S681	1	25035718T	
PCB2	S7153	PUSH SW	NPS-111-S681	1	25035718T	
PCB2	S7155	PUSH SW	NPS-111-S681	1	25035718T	
PCB2	S7157	PUSH SW	NPS-111-S681	1	25035718T	
PCB2	S7159	PUSH SW	NPS-111-S681	1	25035718T	
PCB2	S7161	PUSH SW	NPS-111-S681	1	25035718T	
PCB2	S7164	PUSH SW	NPS-111-S681	1	25035718T	
PCB2	S7166	PUSH SW	NPS-111-S681	1	25035718T	
PCB2	P701B	SOCKET	NSCT-33P2163	1	25052266	
PCB2	P901A	PLUG	NPLG-2P631	1	25055675	!
PCB2	P901A or	PLUG	1-1123724-2	(1)	25056402	!
PCB2	P911	PLUG	NPLG-2P631	1	25055675	!
PCB2	P911 or	PLUG	1-1123724-2	(1)	25056402	!
PCB2	P7201	ST JACK	MSJ-064-05A SR	1	25045783	
PCB2	P7201 or	ST JACK	YKB21-5005	(1)	25045724	
PCB2	P7301	PIN JACK	NPI-7PDB477	1	25045680	
PCB2	P7401	ST JACK	MSJ-035-05C B AG SR type	1	25045879	
PCB2	E901	TRM-423(SCREW)	NEJITANSI ST3	1	25060495	
PCB2	E902	TRM-423(SCREW)	NEJITANSI ST3	1	25060495	
PCB2	E7201	TRM-423(SCREW)	NEJITANSI ST3	1	25060495	
PCB2	E7301	RETAINER	(S)	1	27142074	
PCB2	F901C	FUSE HOL	NSCT-1P2031	1	25052133T	!
PCB2	F901D	FUSE HOL	NSCT-1P2031	1	25052133T	!
PCB2	JL901	JUMPER LEAD	JL5 300 B	1	---	NSP
PCB2	JL6605	JUMPER LEAD	JL5 350 H	1	---	NSP
PCB2	JL6605A	WIRE HOL	NSCT-5P896	1	25051109	
PCB2	JL7101	JUMPER LEAD	JL9 200 H	1	---	NSP
PCB2	JL7101A	WIRE HOL	NSCT-9P900	1	25051113	



PCB2	JL7101B	WIRE HOL	NSCT-9P900	1	25051113	
PCB2	JL901A	WIRE HOL	NSCT-5P876	1	25051089	
PCB2	JL9101	JUMPER LEAD	JL7 350 H	1	---	NSP
PCB2	JL9101A	WIRE HOL	NSCT-7P898	1	25051111	
PCB3	<b>U32</b>	MICROPROCESSOR PC BOARD (NADG-9462-1A / 1B / 1C)				
PCB3						
PCB3	<b>CIRCUIT NO.</b>	<b>PART NAME</b>	<b>DESCRIPTION</b>	<b>Q'TY</b>	<b>PART NO. (SN)</b>	<b>REMARKS</b>
PCB3	U301	PHT CP	JSR1165-001recieving	1	24120143	
PCB3	U301 or	PHT CP	GP1FAV51RK0F	(1)	24120129	
PCB3	U302	PHT CP	JSR1165-001recieving	1	24120143	
PCB3	U302 or	PHT CP	GP1FAV51RK0F	(1)	24120129	
PCB3	Q301	IC	CS42518-CQZR-D	1	22242229R2	
PCB3	Q302	IC	TC74VHC157FT	1	22274157ER2TO	
PCB3	Q303	IC	TC7WU04FU(TE12L_F)	1	22240935R2	
PCB3	Q304	IC	74HCU04F	1	222740046R2	
PCB3	Q305	IC	NJM2860F3-33	1	22242087R2	
PCB3	Q306	IC	NJM4580M-D	1	22241448R2	
PCB3	Q307	TR	2SC2235-Y(TPE6_F)	1	2211654T	
PCB3	Q401	IC	NJM4580M-D	1	22241448R2	
PCB3	Q402	IC	NJM4580M-D	1	22241448R2	
PCB3	Q403	IC	NJM4580M-D	1	22241448R2	
PCB3	Q404	IC	NJM4580M-D	1	22241448R2	
PCB3	Q701	IC (MAIN MICROPROCESSOR)	MPD70F3746	1	222W0079R3	
PCB3	Q702	IC	S-812C33AUA-C2N	1	22242222R2	
PCB3	Q703	IC	S-812C56AUA-C3K	1	22242207R2	
PCB3	Q704	IC	TC74VHCT541AFT	1	22274541GR2TO	
PCB3	Q705	IC	IS25C64A-2GLI	1	22242385R2	
PCB3	Q706	TR	KRC104S	1	2216210R2	
PCB3	Q706 or	TR	RN1404	(1)	2214490R2	
PCB3	Q707	TR	KRA107S	1	2216350R2	
PCB3	Q707 or	TR	RN2407(TE85L_F)	(1)	2216360R2	
PCB3	Q707 or	TR	DTA114YKA	(1)	2216480R2	

PCB3	Q708	TR	KRC107S	1	2216340R2
PCB3	Q708 or	TR	RN1407	(1)	2216260R2
PCB3	Q708 or	TR	DTC114YKA	(1)	2216470R2
PCB3	Q709	TR	KRC107S	1	2216340R2
PCB3	Q709 or	TR	RN1407	(1)	2216260R2
PCB3	Q709 or	TR	DTC114YKA	(1)	2216470R2
PCB3	Q710	TR	KRA107S	1	2216350R2
PCB3	Q710 or	TR	RN2407(TE85L_F)	(1)	2216360R2
PCB3	Q710 or	TR	DTA114YKA	(1)	2216480R2
PCB3	Q711	TR	KRC107S	1	2216340R2
PCB3	Q711 or	TR	RN1407	(1)	2216260R2
PCB3	Q711 or	TR	DTC114YKA	(1)	2216470R2
PCB3	Q712	TR	KRC104S	1	2216210R2
PCB3	Q712 or	TR	RN1404	(1)	2214490R2
PCB3	Q713	TR	KRA102S	1	2216220R2
PCB3	Q713 or	TR	RN2402	(1)	2214530R2
PCB3	Q714	TR	KRC104S	1	2216210R2
PCB3	Q714 or	TR	RN1404	(1)	2214490R2
PCB3	Q715	TR	KRA102S	1	2216220R2
PCB3	Q715 or	TR	RN2402	(1)	2214530R2
PCB3	Q716	TR	KRC104S	1	2216210R2
PCB3	Q716 or	TR	RN1404	(1)	2214490R2
PCB3	Q717	TR	KRA102S	1	2216220R2
PCB3	Q717 or	TR	RN2402	(1)	2214530R2
PCB3	D301	C-DIODE	KDS4148U	1	223283R2
PCB3	D301 or	C-DIODE	1SS352	(1)	223234R2
PCB3	D301 or	C-DIODE	MA2J111	(1)	223279R2
PCB3	D302	C-DIODE	KDS4148U	1	223283R2
PCB3	D302 or	C-DIODE	1SS352	(1)	223234R2
PCB3	D302 or	C-DIODE	MA2J111	(1)	223279R2
PCB3	D303	ZENER D	MAZ8100-M	1	224751002R2
PCB3	D303 or	ZENER D	UDZS10B	(1)	224551000R2
PCB3	D601	C-DIODE	KDS4148U	1	223283R2

PCB3	D601 or	C-DIODE	ISS352	(1)	223234R2
PCB3	D601 or	C-DIODE	MA2J111	(1)	223279R2
PCB3	D602	C-DIODE	KDS4148U	1	223283R2
PCB3	D602 or	C-DIODE	ISS352	(1)	223234R2
PCB3	D602 or	C-DIODE	MA2J111	(1)	223279R2
PCB3	D603	C-DIODE	KDS4148U	1	223283R2
PCB3	D603 or	C-DIODE	ISS352	(1)	223234R2
PCB3	D603 or	C-DIODE	MA2J111	(1)	223279R2
PCB3	D604	C-DIODE	KDS4148U	1	223283R2
PCB3	D604 or	C-DIODE	ISS352	(1)	223234R2
PCB3	D604 or	C-DIODE	MA2J111	(1)	223279R2
PCB3	D605	C-DIODE	KDS4148U	1	223283R2
PCB3	D605 or	C-DIODE	ISS352	(1)	223234R2
PCB3	D605 or	C-DIODE	MA2J111	(1)	223279R2
PCB3	X301	CRYSTAL	HC-49US24.576MHz	1	3010423T
PCB3	X701	CERA LOCK	CSTCR5M00G53-B0	1	3010356R2
PCB3	C301	UTSP C	CE04W10V-470M(UTSP)	1	397534717T
PCB3	C302	UTSP C	CE04W10V-470M(UTSP)	1	397534717T
PCB3	C303	UTSP C	CE04W25V-100M(UTSP)	1	397551017T
PCB3	C304	UTSP C	CE04W10V-470M(UTSP)	1	397534717T
PCB3	C305	UTSJ C	CE04W25V-47M(UTSJ)	1	398054707T
PCB3	C306	UTSP C	CE04W10V-100M(UTSP)	1	397531017T
PCB3	C307	C-CERA C	CK725F1E-104Z1	1	332161040R1
PCB3	C308	C-CERA C	CK725F1E-104Z1	1	332161040R1
PCB3	C309	C-CERA C	CK725F1E-104Z1	1	332161040R1
PCB3	C310	C-CERA C	CC725CH1H-102J1	1	342101024R1
PCB3	C311	C-CERA C	CK725B1H-223K1	1	332102235R1
PCB3	C312	C-CERA C	CK725F1E-104Z1	1	332161040R1
PCB3	C313	C-CERA C	CK725F1E-104Z1	1	332161040R1
PCB3	C314	C-CERA C	CK725F1E-104Z1	1	332161040R1
PCB3	C315	C-CERA C	CK725F1E-104Z1	1	332161040R1
PCB3	C316	C-CERA C	CC725CH1H-221J1	1	342102214R1
PCB3	C317	C-CERA C	CK725F1E-104Z1	1	332161040R1

PCB3	C318	C-CERA C	CC725CH1H-060D1	1	342100602R1
PCB3	C319	C-CERA C	CC725CH1H-060D1	1	342100602R1
PCB3	C320	C-CERA C	CK725F1E-104Z1	1	332161040R1
PCB3	C321	UTSP C	CE04W10V-220M(UTSP)	1	397532217T
PCB3	C322	C-CERA C	CK725F1E-104Z1	1	332161040R1
PCB3	C323	C-CERA C	CK725F1E-104Z1	1	332161040R1
PCB3	C324	UTSP C	CE04W10V-220M(UTSP)	1	397532217T
PCB3	C325	C-CERA C	CC725CH1H-080D1	1	342100802R1
PCB3	C326	C-CERA C	CC725CH1H-080D1	1	342100802R1
PCB3	C328	C-CERA C	CK725F1E-104Z1	1	332161040R1
PCB3	C329	C-CERA C	CK725F1E-104Z1	1	332161040R1
PCB3	C330	C-CERA C	CK725F1E-104Z1	1	332161040R1
PCB3	C332	C-CERA C	CC725CH1H-330J1	1	342103304R1
PCB3	C333	C-CERA C	CC725CH1H-330J1	1	342103304R1
PCB3	C334	C-CERA C	CC725CH1H-330J1	1	342103304R1
PCB3	C335	C-CERA C	CC725CH1H-330J1	1	342103304R1
PCB3	C336	C-CERA C	CK725B1H-103K1	1	332101035R1
PCB3	C337	C-CERA C	CK725B1H-102K1	1	332101025R1
PCB3	C338	C-CERA C	CK725F1E-104Z1	1	332161040R1
PCB3	C339	UTSP C	CE04W50V 47M(UTSP)	1	397584707T
PCB3	C340	C-CERA C	CK725F1E-104Z1	1	332161040R1
PCB3	C351	C-CERA C	CC725CH1H-101J1	1	342101014R1
PCB3	C352	C-CERA C	CC725CH1H-101J1	1	342101014R1
PCB3	C353	C-CERA C	CK725B1C-104K1	1	332121045R1
PCB3	C354	C-CERA C	CK725B1C-104K1	1	332121045R1
PCB3	C355	C-CERA C	CK725F1E-104Z1	1	332161040R1
PCB3	C363	C-CERA C	CC725CH1H-101J1	1	342101014R1
PCB3	C364	C-CERA C	CC725CH1H-101J1	1	342101014R1
PCB3	C365	UTSP C	CE04W50V-10M(UTSP)	1	397581007T
PCB3	C366	UTSP C	CE04W50V-10M(UTSP)	1	397581007T
PCB3	C367	UTSP C	CE04W50V-10M(UTSP)	1	397581007T
PCB3	C368	UTSP C	CE04W50V-10M(UTSP)	1	397581007T
PCB3	C369	C-FILM C	ECHU50V-222J	1	373022224R2

PCB3	C370	C-FILM C	ECHU50V-222J	1	373022224R2
PCB3	C375	C-CERA C	CK725F1A-105Z1	1	332181050R1
PCB3	C376	C-CERA C	CK725F1A-105Z1	1	332181050R1
PCB3	C377	C-CERA C	CK725F1E-104Z1	1	332161040R1
PCB3	C378	C-CERA C	CK725F1E-104Z1	1	332161040R1
PCB3	C379	C-CERA C	CK725F1E-104Z1	1	332161040R1
PCB3	C401	TF C	ECQ-B50V-222J	1	374722224T
PCB3	C402	TF C	ECQ-B50V-222J	1	374722224T
PCB3	C403	TF C	ECQ-B50V-222J	1	374722224T
PCB3	C404	TF C	ECQ-V50V-333J	1	374723334T
PCB3	C405	TF C	ECQ-B50V-222J	1	374722224T
PCB3	C406	TF C	ECQ-B50V-222J	1	374722224T
PCB3	C407	TF C	ECQ-B50V-222J	1	374722224T
PCB3	C408	TF C	ECQ-B50V-222J	1	374722224T
PCB3	C409	UTSP C	CE04W25V-47M(UTSP)	1	397554707T
PCB3	C410	UTSP C	CE04W25V-47M(UTSP)	1	397554707T
PCB3	C411	TF C	ECQ-B50V-331K	1	374723315T
PCB3	C412	TF C	ECQ-B50V-331K	1	374723315T
PCB3	C413	TF C	ECQ-B50V-331K	1	374723315T
PCB3	C414	TF C	ECQ-V50V-333J	1	374723334T
PCB3	C415	C-CERA C	CC725CH1H-331J1	1	342103314R1
PCB3	C416	C-CERA C	CC725CH1H-331J1	1	342103314R1
PCB3	C417	C-CERA C	CC725CH1H-331J1	1	342103314R1
PCB3	C418	C-CERA C	CC725CH1H-331J1	1	342103314R1
PCB3	C421	TF C	ECQ-B50V-331K	1	374723315T
PCB3	C422	TF C	ECQ-B50V-331K	1	374723315T
PCB3	C423	TF C	ECQ-B50V-331K	1	374723315T
PCB3	C424	TF C	ECQ-V50V-333J	1	374723334T
PCB3	C425	C-CERA C	CC725CH1H-331J1	1	342103314R1
PCB3	C426	C-CERA C	CC725CH1H-331J1	1	342103314R1
PCB3	C427	C-CERA C	CC725CH1H-331J1	1	342103314R1
PCB3	C428	C-CERA C	CC725CH1H-331J1	1	342103314R1
PCB3	C601	C-CERA C	CK725F1E-104Z1	1	332161040R1

PCB3	C602	C-CERA C	CK725F1E-104Z1	1	332161040R1
PCB3	C603	UTSP C	CE04W50V-4.7M(UTSP)	1	397580477T
PCB3	C605	C-CERA C	CK725F1E-104Z1	1	332161040R1
PCB3	C606	C-CERA C	CK725F1E-104Z1	1	332161040R1
PCB3	C607	UTSP C	CE04W50V-4.7M(UTSP)	1	397580477T
PCB3	C608	C-CERA C	CK725F1E-104Z1	1	332161040R1
PCB3	C609	C-CERA C	CK725F1E-104Z1	1	332161040R1
PCB3	C610	C-CERA C	CK725B1H-102K1	1	332101025R1
PCB3	C611	C-CERA C	CK725B1H-102K1	1	332101025R1
PCB3	C615	UTSP C	CE04W25V-220M(UTSP)	1	397552217T
PCB3	C616	UTSP C	CE04W25V-220M(UTSP)	1	397552217T
PCB3	C618	C-CERA C	CC725CH1H-101J1	1	342101014R1
PCB3	C619	C-CERA C	CC725CH1H-101J1	1	342101014R1
PCB3	C621	C-CERA C	CK725B1H-102K1	1	332101025R1
PCB3	C622	C-CERA C	CK725F1E-104Z1	1	332161040R1
PCB3	C623	C-CERA C	CK725B1H-102K1	1	332101025R1
PCB3	C624	C-CERA C	CK725B1H-102K1	1	332101025R1
PCB3	C625	C-CERA C	CK725B1H-102K1	1	332101025R1
PCB3	C626	C-CERA C	CK725B1H-102K1	1	332101025R1
PCB3	C627	C-CERA C	CK725B1H-102K1	1	332101025R1
PCB3	C628	C-CERA C	CK725F1E-104Z1	1	332161040R1
PCB3	C629	C-CERA C	CK725F1E-104Z1	1	332161040R1
PCB3	C631	C-CERA C	CK725F1A-105Z1	1	332181050R1
PCB3	C632	C-CERA C	CK725F1A-105Z1	1	332181050R1
PCB3	C633	C-CERA C	CK725F1A-105Z1	1	332181050R1
PCB3	C634	UTSP C	CE04W25V-220M(UTSP)	1	397552217T
PCB3	C635	UTSP C	CE04W25V-100M(UTSP)	1	397551017T
PCB3	C636	C-CERA C	CK725F1E-104Z1	1	332161040R1
PCB3	C637	UTSP C	CE04W25V-100M(UTSP)	1	397551017T
PCB3	C639	C-CERA C	CK725F1E-104Z1	1	332161040R1
PCB3	C641	C-CERA C	CK725F1E-104Z1	1	332161040R1
PCB3	C642	C-CERA C	CK725F1E-104Z1	1	332161040R1
PCB3	C643	VR C	CE04W6.3V-470M(VR)	1	394624717T

PCB3	C644	UTSP C	CE04W50V-0.47M(UTSP)	1	397584797T	
PCB3	C645	UTSP C	CE04W50V-1M(UTSP)	1	397580107T	
PCB3	C646	UTSP C	CE04W50V-1M(UTSP)	1	397580107T	
PCB3	C647	C-CERA C	CK725F1E-104Z1	1	332161040R1	
PCB3	L301	CHOKE COIL	BLM21PG221SN1	1	230949R2	
PCB3	L302	CHOKE COIL	BLM21PG221SN1	1	230949R2	
PCB3	L303	CHOKE COIL	BLM21PG221SN1	1	230949R2	
PCB3	L304	CHOKE COIL	LBC2518T4R7M	1	231364M047R2	
PCB3	L305	CHOKE COIL	BLM21PG221SN1	1	230949R2	
PCB3	L306	CHOKE COIL	LBC2518T470M	1	231364M470R2	
PCB3	L307	CHOKE COIL	LBC2518T470M	1	231364M470R2	
PCB3	L308	CHOKE COIL	LBC2518T470M	1	231364M470R2	
PCB3	L309	CHOKE COIL	LBC2518T2R2M	1	231364M022R2	
PCB3	L310	CHOKE COIL	LBC2518T2R2M	1	231364M022R2	
PCB3	L313	EMIFIL	BK1608LM182-T	1	230958R1	
PCB3	L316	EMIFIL	BK1608LM182-T	1	230958R1	
PCB3	L321	EMIFIL	BK1608LM182-T	1	230958R1	
PCB3	L322	EMIFIL	BK1608LM182-T	1	230958R1	
PCB3	L611	CHOKE COIL	LBC2518T470M	1	231364M470R2	
PCB3	R106	C-CARBON R	RN72K1J-000JE	1	435030004R1	<DD, DC>
PCB3	R106	C-CARBON R	RN72K1J-000JE	1	435030004R1	<PA>
PCB3	R107	C-CARBON R	RN72K1J-000JE	1	435030004R1	<DD, DC>
PCB3	R107	C-CARBON R	RN72K1J-000JE	1	435030004R1	<PA>
PCB3	R301	C-CARBON R	RN72K1J-331JE	1	435033314R1	
PCB3	R302	C-CARBON R	RN72K1J-331JE	1	435033314R1	
PCB3	R303	C-CARBON R	RN72K1J-331JE	1	435033314R1	
PCB3	R304	C-CARBON R	RN72K1J-331JE	1	435033314R1	
PCB3	R305	C-CARBON R	RN72K1J-470JE	1	435034704R1	
PCB3	R306	C-CARBON R	RN72K1J-331JE	1	435033314R1	
PCB3	R307	C-CARBON R	RN72K1J-331JE	1	435033314R1	
PCB3	R308	C-CARBON R	RN72K1J-470JE	1	435034704R1	
PCB3	R309	C-CARBON R	RN72K1J-331JE	1	435033314R1	
PCB3	R310	C-CARBON R	RN72K1J-152JE	1	435031524R1	

PCB3	R312	C-CARBON R	RN72K1J-470JE	1	435034704R1
PCB3	R313	C-CARBON R	RN72K1J-151JE	1	435031514R1
PCB3	R314	C-CARBON R	RN72K1J-221JE	1	435032214R1
PCB3	R315	C-CARBON R	RN72K1J-470JE	1	435034704R1
PCB3	R316	C-CARBON R	RN72K1J-470JE	1	435034704R1
PCB3	R317	C-CARBON R	RN72K1J-331JE	1	435033314R1
PCB3	R318	C-CARBON R	RN72K1J-331JE	1	435033314R1
PCB3	R319	C-CARBON R	RN72K1J-331JE	1	435033314R1
PCB3	R321	C-CARBON R	RN72K1J-331JE	1	435033314R1
PCB3	R322	C-CARBON R	RN72K1J-470JE	1	435034704R1
PCB3	R323	C-CARBON R	RN72K1J-331JE	1	435033314R1
PCB3	R324	C-CARBON R	RN72K1J-221JE	1	435032214R1
PCB3	R325	C-CARBON R	RN72K1J-151JE	1	435031514R1
PCB3	R326	C-CARBON R	RN72K1J-105JE	1	435031054R1
PCB3	R328	C-CARBON R	RN72K1J-221JE	1	435032214R1
PCB3	R329	C-CARBON R	RN72K1J-221JE	1	435032214R1
PCB3	R331	C-CARBON R	RN72K1J-331JE	1	435033314R1
PCB3	R332	C-CARBON R	RN72K1J-331JE	1	435033314R1
PCB3	R333	C-CARBON R	RN72K1J-331JE	1	435033314R1
PCB3	R334	C-CARBON R	RN72K1J-331JE	1	435033314R1
PCB3	R335	C-CARBON R	RN72K1J-331JE	1	435033314R1
PCB3	R337	C-CARBON R	RN72K1J-103JE	1	435031034R1
PCB3	R338	C-CARBON R	RN72K1J-103JE	1	435031034R1
PCB3	R339	C-CARBON R	RN72K1J-823JE	1	435038234R1
PCB3	R340	C-CARBON R	RN72K1J-823JE	1	435038234R1
PCB3	R341	C-CARBON R	RN72K1J-470JE	1	435034704R1
PCB3	R342	C-CARBON R	RN72K1J-470JE	1	435034704R1
PCB3	R345	C-CARBON R	RN72K1J-000JE	1	435030004R1
PCB3	R348	C-CARBON R	RN72K1J-333JE	1	435033334R1
PCB3	R349	METAL O R	RS1WBJ-22	1	443622204T
PCB3	R351	C-CARBON R	RN72K1J-750JE	1	435037504R1
PCB3	R352	C-CARBON R	RN72K1J-750JE	1	435037504R1
PCB3	R353	C-CARBON R	RN72K1J-100JE	1	435031004R1



PCB3	R354	C-CARBON R	RN72K1J-100JE	1	435031004R1
PCB3	R355	C-CARBON R	RN72K1J-224JE	1	435032244R1
PCB3	R356	C-CARBON R	RN72K1J-224JE	1	435032244R1
PCB3	R361	C-CARBON R	RN72K1J-103JE	1	435031034R1
PCB3	R362	C-CARBON R	RN72K1J-103JE	1	435031034R1
PCB3	R363	C-CARBON R	RN72K1J-103JE	1	435031034R1
PCB3	R364	C-CARBON R	RN72K1J-103JE	1	435031034R1
PCB3	R365	C-CARBON R	RN72K1J-560JE	1	435035604R1
PCB3	R366	C-CARBON R	RN72K1J-560JE	1	435035604R1
PCB3	R367	C-CARBON R	RN72K1J-560JE	1	435035604R1
PCB3	R368	C-CARBON R	RN72K1J-560JE	1	435035604R1
PCB3	R369	C-CARBON R	RN72K1J-392JE	1	435033924R1
PCB3	R370	C-CARBON R	RN72K1J-392JE	1	435033924R1
PCB3	R371	C-CARBON R	RN72K1J-103JE	1	435031034R1
PCB3	R401	C-CARBON R	RN72K1J-332JE	1	435033324R1
PCB3	R402	C-CARBON R	RN72K1J-332JE	1	435033324R1
PCB3	R403	C-CARBON R	RN72K1J-332JE	1	435033324R1
PCB3	R404	C-CARBON R	RN72K1J-332JE	1	435033324R1
PCB3	R405	C-CARBON R	RN72K1J-332JE	1	435033324R1
PCB3	R406	C-CARBON R	RN72K1J-332JE	1	435033324R1
PCB3	R407	C-CARBON R	RN72K1J-332JE	1	435033324R1
PCB3	R408	C-CARBON R	RN72K1J-332JE	1	435033324R1
PCB3	R411	C-CARBON R	RN72K1J-332JE	1	435033324R1
PCB3	R412	C-CARBON R	RN72K1J-332JE	1	435033324R1
PCB3	R413	C-CARBON R	RN72K1J-332JE	1	435033324R1
PCB3	R414	C-CARBON R	RN72K1J-332JE	1	435033324R1
PCB3	R415	C-CARBON R	RN72K1J-332JE	1	435033324R1
PCB3	R416	C-CARBON R	RN72K1J-332JE	1	435033324R1
PCB3	R417	C-CARBON R	RN72K1J-332JE	1	435033324R1
PCB3	R418	C-CARBON R	RN72K1J-332JE	1	435033324R1
PCB3	R421	C-CARBON R	RN72K1J-471JE	1	435034714R1
PCB3	R422	C-CARBON R	RN72K1J-471JE	1	435034714R1
PCB3	R423	C-CARBON R	RN72K1J-471JE	1	435034714R1

PCB3	R424	C-CARBON R	RN72K1J-471JE	1	435034714R1
PCB3	R425	C-CARBON R	RN72K1J-471JE	1	435034714R1
PCB3	R426	C-CARBON R	RN72K1J-471JE	1	435034714R1
PCB3	R427	C-CARBON R	RN72K1J-471JE	1	435034714R1
PCB3	R428	C-CARBON R	RN72K1J-471JE	1	435034714R1
PCB3	R431	C-CARBON R	RN72K1J-471JE	1	435034714R1
PCB3	R432	C-CARBON R	RN72K1J-471JE	1	435034714R1
PCB3	R433	C-CARBON R	RN72K1J-471JE	1	435034714R1
PCB3	R434	C-CARBON R	RN72K1J-471JE	1	435034714R1
PCB3	R435	C-CARBON R	RN72K1J-471JE	1	435034714R1
PCB3	R436	C-CARBON R	RN72K1J-471JE	1	435034714R1
PCB3	R437	C-CARBON R	RN72K1J-471JE	1	435034714R1
PCB3	R438	C-CARBON R	RN72K1J-471JE	1	435034714R1
PCB3	R441	C-CARBON R	RN72K1J-472JE	1	435034724R1
PCB3	R442	C-CARBON R	RN72K1J-472JE	1	435034724R1
PCB3	R443	C-CARBON R	RN72K1J-472JE	1	435034724R1
PCB3	R444	C-CARBON R	RN72K1J-472JE	1	435034724R1
PCB3	R445	C-CARBON R	RN72K1J-472JE	1	435034724R1
PCB3	R446	C-CARBON R	RN72K1J-472JE	1	435034724R1
PCB3	R447	C-CARBON R	RN72K1J-472JE	1	435034724R1
PCB3	R448	C-CARBON R	RN72K1J-472JE	1	435034724R1
PCB3	R451	C-CARBON R	RN72K1J-472JE	1	435034724R1
PCB3	R452	C-CARBON R	RN72K1J-472JE	1	435034724R1
PCB3	R453	C-CARBON R	RN72K1J-472JE	1	435034724R1
PCB3	R454	C-CARBON R	RN72K1J-472JE	1	435034724R1
PCB3	R455	C-CARBON R	RN72K1J-472JE	1	435034724R1
PCB3	R456	C-CARBON R	RN72K1J-472JE	1	435034724R1
PCB3	R457	C-CARBON R	RN72K1J-472JE	1	435034724R1
PCB3	R458	C-CARBON R	RN72K1J-472JE	1	435034724R1
PCB3	R461	C-CARBON R	RN72K1J-181JE	1	435031814R1
PCB3	R462	C-CARBON R	RN72K1J-181JE	1	435031814R1
PCB3	R463	C-CARBON R	RN72K1J-181JE	1	435031814R1
PCB3	R464	C-CARBON R	RN72K1J-181JE	1	435031814R1

PCB3	R465	C-CARBON R	RN72K1J-181JE	1	435031814R1
PCB3	R466	C-CARBON R	RN72K1J-181JE	1	435031814R1
PCB3	R467	C-CARBON R	RN72K1J-181JE	1	435031814R1
PCB3	R468	C-CARBON R	RN72K1J-181JE	1	435031814R1
PCB3	R471	C-CARBON R	RN72K1J-181JE	1	435031814R1
PCB3	R472	C-CARBON R	RN72K1J-181JE	1	435031814R1
PCB3	R473	C-CARBON R	RN72K1J-181JE	1	435031814R1
PCB3	R474	C-CARBON R	RN72K1J-181JE	1	435031814R1
PCB3	R475	C-CARBON R	RN72K1J-181JE	1	435031814R1
PCB3	R476	C-CARBON R	RN72K1J-181JE	1	435031814R1
PCB3	R477	C-CARBON R	RN72K1J-181JE	1	435031814R1
PCB3	R478	C-CARBON R	RN72K1J-181JE	1	435031814R1
PCB3	R571	C-CARBON R	RN72K1J-000JE	1	435030004R1
PCB3	R572	C-CARBON R	RN72K1J-000JE	1	435030004R1
PCB3	R573	C-CARBON R	RN72K1J-000JE	1	435030004R1
PCB3	R574	C-CARBON R	RN72K1J-000JE	1	435030004R1
PCB3	R575	C-CARBON R	RN72K1J-000JE	1	435030004R1
PCB3	R576	C-CARBON R	RN72K1J-000JE	1	435030004R1
PCB3	R577	C-CARBON R	RN72K1J-000JE	1	435030004R1
PCB3	R578	C-CARBON R	RN72K1J-000JE	1	435030004R1
PCB3	R591	METAL O R	RS1/2WBJ-22	1	443522204T
PCB3	R592	METAL O R	RS1/2WBJ-22	1	443522204T
PCB3	R602	C-CARBON R	RN72K1J-470JE	1	435034704R1
PCB3	R603	C-CARBON R	RN72K1J-103JE	1	435031034R1
PCB3	R604	C-CARBON R	RN72K1J-221JE	1	435032214R1
PCB3	R605	C-CARBON R	RN72K1J-473JE	1	435034734R1
PCB3	R606	C-CARBON R	RN72K1J-000JE	1	435030004R1
PCB3	R607	C-CARBON R	RN72K1J-103JE	1	435031034R1
PCB3	R608	C-CARBON R	RN72K1J-103JE	1	435031034R1
PCB3	R609	C-CARBON R	RN72K1J-105JE	1	435031054R1
PCB3	R610	C-CARBON R	RN72K1J-221JE	1	435032214R1
PCB3	R611	C-CARBON R	RN72K1J-103JE	1	435031034R1
PCB3	R612	C-CARBON R	RN72K1J-221JE	1	435032214R1

PCB3	R613	C-CARBON R	RN72K1J-470JE	1	435034704R1
PCB3	R614	C-CARBON R	RN72K1J-103JE	1	435031034R1
PCB3	R616	C-CARBON R	RN72K1J-470JE	1	435034704R1
PCB3	R617	C-CARBON R	RN72K1J-470JE	1	435034704R1
PCB3	R618	C-CARBON R	RN72K1J-470JE	1	435034704R1
PCB3	R619	C-CARBON R	RN72K1J-470JE	1	435034704R1
PCB3	R620	C-CARBON R	RN72K1J-470JE	1	435034704R1
PCB3	R621	C-CARBON R	RN72K1J-103JE	1	435031034R1
PCB3	R625	C-CARBON R	RN72K1J-470JE	1	435034704R1
PCB3	R627	C-CARBON R	RN72K1J-470JE	1	435034704R1
PCB3	R628	C-CARBON R	RN72K1J-103JE	1	435031034R1
PCB3	R632	C-CARBON R	RN72K1J-103JE	1	435031034R1
PCB3	R637	C-CARBON R	RN72K1J-472JE	1	435034724R1
PCB3	R638	C-CARBON R	RN72K1J-472JE	1	435034724R1
PCB3	R639	C-CARBON R	RN72K1J-272JE	1	435032724R1
PCB3	R640	C-CARBON R	RN72K1J-272JE	1	435032724R1
PCB3	R641	C-CARBON R	RN72K1J-272JE	1	435032724R1
PCB3	R642	C-CARBON R	RN72K1J-272JE	1	435032724R1
PCB3	R643	C-CARBON R	RN72K1J-470JE	1	435034704R1
PCB3	R644	C-CARBON R	RN72K1J-470JE	1	435034704R1
PCB3	R645	C-CARBON R	RN72K1J-102JE	1	435031024R1
PCB3	R646	C-CARBON R	RN72K1J-470JE	1	435034704R1
PCB3	R647	C-CARBON R	RN72K1J-470JE	1	435034704R1
PCB3	R648	C-CARBON R	RN72K1J-470JE	1	435034704R1
PCB3	R649	C-CARBON R	RN72K1J-221JE	1	435032214R1
PCB3	R650	C-CARBON R	RN72K1J-470JE	1	435034704R1
PCB3	R651	C-CARBON R	RN72K1J-470JE	1	435034704R1
PCB3	R652	C-CARBON R	RN72K1J-470JE	1	435034704R1
PCB3	R653	C-CARBON R	RN72K1J-470JE	1	435034704R1
PCB3	R654	C-CARBON R	RN72K1J-221JE	1	435032214R1
PCB3	R655	C-CARBON R	RN72K1J-221JE	1	435032214R1
PCB3	R656	C-CARBON R	RN72K1J-470JE	1	435034704R1
PCB3	R657	C-CARBON R	RN72K1J-470JE	1	435034704R1

PCB3	R661	C-CARBON R	RN72K1J-470JE	1	435034704R1	
PCB3	R662	C-CARBON R	RN72K1J-470JE	1	435034704R1	
PCB3	R663	C-CARBON R	RN72K1J-103JE	1	435031034R1	
PCB3	R664	C-CARBON R	RN72K1J-470JE	1	435034704R1	
PCB3	R665	C-CARBON R	RN72K1J-470JE	1	435034704R1	
PCB3	R666	C-CARBON R	RN72K1J-103JE	1	435031034R1	
PCB3	R667	C-CARBON R	RN72K1J-221JE	1	435032214R1	
PCB3	R668	C-CARBON R	RN72K1J-221JE	1	435032214R1	
PCB3	R669	C-CARBON R	RN72K1J-221JE	1	435032214R1	
PCB3	R670	C-CARBON R	RN72K1J-221JE	1	435032214R1	
PCB3	R671	C-CARBON R	RN72K1J-470JE	1	435034704R1	
PCB3	R672	C-CARBON R	RN72K1J-470JE	1	435034704R1	
PCB3	R673	C-CARBON R	RN72K1J-470JE	1	435034704R1	
PCB3	R674	C-CARBON R	RN72K1J-103JE	1	435031034R1	
PCB3	R675	C-CARBON R	RN72K1J-102JE	1	435031024R1	<PP>
PCB3	R676	C-CARBON R	RN72K1J-105JE	1	435031054R1	
PCB3	R677	C-CARBON R	RN72K1J-221JE	1	435032214R1	
PCB3	R678	C-CARBON R	RN72K1J-221JE	1	435032214R1	
PCB3	R679	C-CARBON R	RN72K1J-103JE	1	435031034R1	
PCB3	R680	C-CARBON R	RN72K1J-103JE	1	435031034R1	
PCB3	R681	C-CARBON R	RN72K1J-103JE	1	435031034R1	
PCB3	R682	C-CARBON R	RN72K1J-103JE	1	435031034R1	
PCB3	R683	C-CARBON R	RN72K1J-103JE	1	435031034R1	
PCB3	R684	C-CARBON R	RN72K1J-000JE	1	435030004R1	
PCB3	R685	C-CARBON R	RN72K1J-000JE	1	435030004R1	
PCB3	R686	C-CARBON R	RN72K1J-103JE	1	435031034R1	
PCB3	R689	C-CARBON R	RN72K1J-470JE	1	435034704R1	
PCB3	R690	C-CARBON R	RN72K1J-470JE	1	435034704R1	
PCB3	R691	C-CARBON R	RN72K1J-470JE	1	435034704R1	
PCB3	R692	C-CARBON R	RN72K1J-470JE	1	435034704R1	
PCB3	R693	C-CARBON R	RN72K1J-102JE	1	435031024R1	<PP>
PCB3	R695	C-CARBON R	RN72K1J-470JE	1	435034704R1	
PCB3	R696	C-CARBON R	RN72K1J-470JE	1	435034704R1	

PCB3	R697	C-CARBON R	RN72K1J-470JE	1	435034704R1	
PCB3	R698	C-CARBON R	RN72K1J-470JE	1	435034704R1	
PCB3	R699	C-CARBON R	RN72K1J-470JE	1	435034704R1	
PCB3	R700	C-CARBON R	RN72K1J-470JE	1	435034704R1	
PCB3	R701	C-CARBON R	RN72K1J-470JE	1	435034704R1	
PCB3	R703	C-CARBON R	RN72K1J-222JE	1	435032224R1	<PP>
PCB3	R704	C-CARBON R	RN72K1J-103JE	1	435031034R1	
PCB3	R705	C-CARBON R	RN72K1J-103JE	1	435031034R1	
PCB3	R707	C-CARBON R	RN72K1J-103JE	1	435031034R1	
PCB3	R708	C-CARBON R	RN72K1J-103JE	1	435031034R1	
PCB3	R709	C-CARBON R	RN72K1J-221JE	1	435032214R1	
PCB3	R710	C-CARBON R	RN72K1J-470JE	1	435034704R1	
PCB3	R711	C-CARBON R	RN72K1J-221JE	1	435032214R1	
PCB3	R712	C-CARBON R	RN72K1J-470JE	1	435034704R1	
PCB3	R713	C-CARBON R	RN72K1J-470JE	1	435034704R1	
PCB3	R714	C-CARBON R	RN72K1J-221JE	1	435032214R1	
PCB3	R715	C-CARBON R	RN72K1J-221JE	1	435032214R1	
PCB3	R716	C-CARBON R	RN72K1J-221JE	1	435032214R1	
PCB3	R717	C-CARBON R	RN72K1J-221JE	1	435032214R1	
PCB3	R718	C-CARBON R	RN72K1J-221JE	1	435032214R1	
PCB3	R719	C-CARBON R	RN72K1J-221JE	1	435032214R1	
PCB3	R720	C-CARBON R	RN72K1J-470JE	1	435034704R1	
PCB3	R721	C-CARBON R	RN72K1J-470JE	1	435034704R1	
PCB3	R722	C-CARBON R	RN72K1J-470JE	1	435034704R1	
PCB3	R723	C-CARBON R	RN72K1J-221JE	1	435032214R1	
PCB3	R724	C-CARBON R	RN72K1J-221JE	1	435032214R1	
PCB3	R725	C-CARBON R	RN72K1J-102JE	1	435031024R1	
PCB3	R726	C-CARBON R	RN72K1J-221JE	1	435032214R1	
PCB3	R727	C-CARBON R	RN72K1J-102JE	1	435031024R1	
PCB3	R728	C-CARBON R	RN72K1J-103JE	1	435031034R1	
PCB3	R729	C-CARBON R	RN72K1J-470JE	1	435034704R1	
PCB3	R733	C-CARBON R	RN72K1J-102JE	1	435031024R1	
PCB3	R734	C-CARBON R	RN72K1J-102JE	1	435031024R1	

PCB3	R735	C-CARBON R	RN72K1J-221JE	1	435032214R1	
PCB3	R736	C-CARBON R	RN72K1J-221JE	1	435032214R1	
PCB3	R737	C-CARBON R	RN72K1J-103JE	1	435031034R1	<PP>
PCB3	R737	C-CARBON R	RN72K1J-103JE	1	435031034R1	<PA>
PCB3	R739	C-CARBON R	RN72K1J-000JE	1	435030004R1	<DD, DC>
PCB3	R740	C-CARBON R	RN72K1J-000JE	1	435030004R1	<DD, DC>
PCB3	R740	C-CARBON R	RN72K1J-103JE	1	435031034R1	<PP>
PCB3	R741	C-CARBON R	RN72K1J-472JE	1	435034724R1	
PCB3	R742	C-CARBON R	RN72K1J-472JE	1	435034724R1	
PCB3	R743	C-CARBON R	RN72K1J-472JE	1	435034724R1	
PCB3	R744	C-CARBON R	RN72K1J-472JE	1	435034724R1	
PCB3	R745	C-CARBON R	RN72K1J-103JE	1	435031034R1	
PCB3	R746	C-CARBON R	RN72K1J-103JE	1	435031034R1	
PCB3	R747	C-CARBON R	RN72K1J-103JE	1	435031034R1	<DD, DC>
PCB3	R747	C-CARBON R	RN72K1J-333JE	1	435033334R1	<PP>
PCB3	R747	C-CARBON R	RN72K1J-333JE	1	435033334R1	<PA>
PCB3	R748	C-CARBON R	RN72K1J-103JE	1	435031034R1	
PCB3	R749	C-CARBON R	RN72K1J-103JE	1	435031034R1	<PP>
PCB3	R749	C-CARBON R	RN72K1J-103JE	1	435031034R1	<PA>
PCB3	R750	C-CARBON R	RN72K1J-103JE	1	435031034R1	<PP>
PCB3	R750	C-CARBON R	RN72K1J-103JE	1	435031034R1	<PA>
PCB3	R751	C-CARBON R	RN72K1J-272JE	1	435032724R1	
PCB3	R752	C-CARBON R	RN72K1J-272JE	1	435032724R1	
PCB3	R753	C-CARBON R	RN72K1J-272JE	1	435032724R1	
PCB3	R754	C-CARBON R	RN72K1J-272JE	1	435032724R1	
PCB3	R755	C-CARBON R	RN72K1J-473JE	1	435034734R1	
PCB3	R756	C-CARBON R	RN72K1J-473JE	1	435034734R1	
PCB3	R757	C-CARBON R	RN72K1J-221JE	1	435032214R1	
PCB3	R760	C-CARBON R	RN72K1J-473JE	1	435034734R1	
PCB3	R761	C-CARBON R	RN72K1J-473JE	1	435034734R1	
PCB3	R764	C-CARBON R	RN72K1J-473JE	1	435034734R1	
PCB3	R766	C-CARBON R	RN72K1J-473JE	1	435034734R1	
PCB3	R767	C-CARBON R	RN72K1J-473JE	1	435034734R1	

PCB3	R768	C-CARBON R	RN72K1J-222JE	1	435032224R1	<PP>
PCB3	R769	C-CARBON R	RN72K1J-103JE	1	435031034R1	
PCB3	R770	C-CARBON R	RN72K1J-103JE	1	435031034R1	
PCB3	R771	C-CARBON R	RN72K1J-273JE	1	435032734R1	
PCB3	R772	C-CARBON R	RN72K1J-101JE	1	435031014R1	
PCB3	R773	C-CARBON R	RN72K1J-101JE	1	435031014R1	
PCB3	R774	C-CARBON R	RN72K1J-224JE	1	435032244R1	
PCB3	R775	C-CARBON R	RN72K1J-103JE	1	435031034R1	
PCB3	R777	C-CARBON R	RN72K1J-272JE	1	435032724R1	
PCB3	R778	C-CARBON R	RN72K1J-272JE	1	435032724R1	
PCB3	R781	C-CARBON R	RN72K1J-272JE	1	435032724R1	
PCB3	R782	C-CARBON R	RN72K1J-103JE	1	435031034R1	
PCB3	R783	C-CARBON R	RN72K1J-103JE	1	435031034R1	
PCB3	R785	C-CARBON R	RN72K1J-103JE	1	435031034R1	
PCB3	R787	C-CARBON R	RN72K1J-222JE	1	435032224R1	
PCB3	R788	C-CARBON R	RN72K1J-103JE	1	435031034R1	
PCB3	R789	C-CARBON R	RN72K1J-103JE	1	435031034R1	
PCB3	R790	C-CARBON R	RN72K1J-473JE	1	435034734R1	
PCB3	R792	C-CARBON R	RN72K1J-222JE	1	435032224R1	
PCB3	R793	C-CARBON R	RN72K1J-102JE	1	435031024R1	
PCB3	R795	C-CARBON R	RN72K1J-222JE	1	435032224R1	
PCB3	R796	C-CARBON R	RN72K1J-102JE	1	435031024R1	
PCB3	R798	C-CARBON R	RN72K1J-222JE	1	435032224R1	
PCB3	R799	C-CARBON R	RN72K1J-102JE	1	435031024R1	
PCB3	P302A	SOCKET	NSCT-15P2195	1	25052298	
PCB3	P303A	SOCKET	NSCT-15P2195	1	25052298	
PCB3	P304A	SOCKET	NSCT-3P2183	1	25052286	
PCB3	P307	PIN JACK	NPJ-2PDO0626	1	25045847	
PCB3	P307 or	PIN JACK	NPJ-2PDO445	(1)	25045640	
PCB3	P701A	SOCKET	NSCT-33P2126	1	25052229	
PCB3	P702A	SOCKET	NSCT-9P2427	1	25052530	
PCB3	P708A	SOCKET	NSCT-13P2106	1	25052209	
PCB3	P2004A	PLUG	NPLG-15P0970	1	25056020	



PCB3	P2005A	PLUG	NPLG-15P0970	1	25056020	
PCB3	P8001A	PLUG	IMSA-9111B-16	1	25056620	
PCB3	P8002A	PLUG	IMSA-9111B-16	1	25056620	
PCB3	P8003A	PLUG	IMSA-9111B-16	1	25056620	
PCB3	J101	PVC	1007#24 .2/7HAND B	1	---	NSP
PCB3	JL6402B	WIRE TRAP	NPLG-3P586	1	25055624	
PCB4	<b>U36</b>	VIDEO PC BOARD (NAVD-9467-1G / 1H)				
PCB4	<b>U37</b>	SPEAKER TERMINAL PC BOARD (NATRM-9468-1G / 1H)				
PCB4						
PCB4	<b>CIRCUIT NO.</b>	<b>PART NAME</b>	<b>DESCRIPTION</b>	<b>Q'TY</b>	<b>PART NO. (SN)</b>	<b>REMARKS</b>
PCB4	Q3001	IC	AN15880A-VT	1	22242319R3	
PCB4	Q6601	TR	KRC105S	1	2217290R2	
PCB4	Q6601 or	TR	RN1405	(1)	2214500R2	
PCB4	Q6602	TR	KRC105S	1	2217290R2	
PCB4	Q6602 or	TR	RN1405	(1)	2214500R2	
PCB4	Q6603	TR	KRC105S	1	2217290R2	
PCB4	Q6603 or	TR	RN1405	(1)	2214500R2	
PCB4	Q6604	TR	KRC105S	1	2217290R2	
PCB4	Q6604 or	TR	RN1405	(1)	2214500R2	
PCB4	Q9001	TR	2SC2235-Y(TPE6_F)	1	2211654T	
PCB4	Q9001 or	TR	2SC2235-O(TPE6_F)	(1)	2211653T	
PCB4	Q9002	TR	KRC105S	1	2217290R2	
PCB4	Q9002 or	TR	RN1405	(1)	2214500R2	
PCB4	Q9020	TR	2SA854S-R	1	2217394T	<PP, PA>
PCB4	Q9021	TR	KRC102S	1	2216190R2	<PP, PA>
PCB4	Q9021 or	TR	RN1402	(1)	2214470R2	<PP, PA>
PCB4	Q9022	IC	MPC2905BHF	1	22278005DBNE	
PCB4	Q9022 or	IC	78M05AHF(MPC78M05AHF)	(1)	222780055NEC	
PCB4	Q9031	IC	MPC2905BHF	1	22278005DBNE	
PCB4	Q9031A	SCREW	3P+10FN(3BC)	1	82143010GR	
PCB4	Q9031B	HEAT SINK	RAD-140	1	27160471	
PCB4	D3028	C-DIODE	KDS4148U	1	223283R2	

PCB4	D3028 or	C-DIODE	1SS352	(1)	223234R2
PCB4	D3028 or	C-DIODE	MA2J111	(1)	223279R2
PCB4	D3029	C-DIODE	KDS4148U	1	223283R2
PCB4	D3029 or	C-DIODE	1SS352	(1)	223234R2
PCB4	D3029 or	C-DIODE	MA2J111	(1)	223279R2
PCB4	D6600	C-DIODE	KDS4148U	1	223283R2
PCB4	D6600 or	C-DIODE	1SS352	(1)	223234R2
PCB4	D6600 or	C-DIODE	MA2J111	(1)	223279R2
PCB4	D6603	C-DIODE	KDS4148U	1	223283R2
PCB4	D6603 or	C-DIODE	1SS352	(1)	223234R2
PCB4	D6603 or	C-DIODE	MA2J111	(1)	223279R2
PCB4	D6605	C-DIODE	KDS4148U	1	223283R2
PCB4	D6605 or	C-DIODE	1SS352	(1)	223234R2
PCB4	D6605 or	C-DIODE	MA2J111	(1)	223279R2
PCB4	D6607	C-DIODE	KDS4148U	1	223283R2
PCB4	D6607 or	C-DIODE	1SS352	(1)	223234R2
PCB4	D6607 or	C-DIODE	MA2J111	(1)	223279R2
PCB4	D9001	DIODE	RL1N4003	1	22380260T
PCB4	D9002	DIODE	RL1N4003	1	22380260T
PCB4	D9005	ZENER D	UDZS36B	1	224553600R2
PCB4	D9011	DIODE	D5SBA20	1	22380130F
PCB4	D9012	C-DIODE	KDS4148U	1	223283R2
PCB4	D9012 or	C-DIODE	1SS352	(1)	223234R2
PCB4	D9012 or	C-DIODE	MA2J111	(1)	223279R2
PCB4	D9013	DIODE	RL1N4003	1	22380260T
PCB4	D9014	C-DIODE	KDS4148U	1	223283R2
PCB4	D9014 or	C-DIODE	1SS352	(1)	223234R2
PCB4	D9014 or	C-DIODE	MA2J111	(1)	223279R2
PCB4	D9015	C-DIODE	KDS4148U	1	223283R2
PCB4	D9015 or	C-DIODE	1SS352	(1)	223234R2
PCB4	D9015 or	C-DIODE	MA2J111	(1)	223279R2
PCB4	D9016	ZENER D	UDZS6.2B	1	224550620R2
PCB4	D9017	C-DIODE	KDS4148U	1	223283R2

PCB4	D9017 or	C-DIODE	1SS352	(1)	223234R2	
PCB4	D9017 or	C-DIODE	MA2J111	(1)	223279R2	
PCB4	D9022	DIODE	RL1N4003	1	22380260T	
PCB4	D9023	C-DIODE	KDS4148U	1	223283R2	
PCB4	D9023 or	C-DIODE	1SS352	(1)	223234R2	
PCB4	D9023 or	C-DIODE	MA2J111	(1)	223279R2	
PCB4	L6600	S COIL	S-1.3C	1	231176S	<PP, PA>
PCB4	L6601	S COIL	S-1.3C	1	231176S	<PP, PA>
PCB4	L6602	S COIL	S-1.3C	1	231176S	<PP, PA>
PCB4	L6603	S COIL	S-1.3C	1	231176S	<PP, PA>
PCB4	L6604	S COIL	S-1.3C	1	231176S	<PP, PA>
PCB4	L6605	S COIL	S-1.3C	1	231176S	<PP, PA>
PCB4	L6606	S COIL	S-1.3C	1	231176S	<PP, PA>
PCB4	C3001	VR C	CE04W16V-100M(VR)	1	394641017T	
PCB4	C3002	C-CERA C	CK725F1E-104Z1	1	332161040R1	
PCB4	C3003	UTSP C	CE04W50V-22M(UTSP)	1	397582207T	
PCB4	C3004	VR C	CE04W6.3V-470M(VR)	1	394624717T	
PCB4	C3005	C-CERA C	CK725F1E-104Z1	1	332161040R1	
PCB4	C3006	VR C	CE04W16V-100M(VR)	1	394641017T	
PCB4	C3007	VR C	CE04W6.3V-470M(VR)	1	394624717T	
PCB4	C3008	C-CERA C	CK725F1E-104Z1	1	332161040R1	
PCB4	C3010	C-CERA C	CK725F1E-104Z1	1	332161040R1	
PCB4	C3011	VR C	CE04W6.3V-470M(VR)	1	394624717T	
PCB4	C3012	C-CERA C	CK725F1E-104Z1	1	332161040R1	
PCB4	C3013	VR C	CE04W16V-100M(VR)	1	394641017T	
PCB4	C3014	C-CERA C	CK725F1E-104Z1	1	332161040R1	
PCB4	C3015	C-CERA C	CK725F1E-104Z1	1	332161040R1	
PCB4	C3017	VR C	CE04W6.3V-470M(VR)	1	394624717T	
PCB4	C3018	VR C	CE04W6.3V-470M(VR)	1	394624717T	
PCB4	C3019	C-CERA C	CK725F1E-104Z1	1	332161040R1	
PCB4	C3021	VR C	CE04W6.3V-470M(VR)	1	394624717T	
PCB4	C3022	VR C	CE04W16V-100M(VR)	1	394641017T	
PCB4	C3023	C-CERA C	CK725F1E-104Z1	1	332161040R1	

PCB4	C3024	VR C	CE04W6.3V-470M(VR)	1	394624717T
PCB4	C3030	C-CERA C	CK725B1H-102K1	1	332101025R1
PCB4	C3031	C-CERA C	CK725B1H-102K1	1	332101025R1
PCB4	C3032	C-CERA C	CK725B1H-102K1	1	332101025R1
PCB4	C3033	UTSP C	CE04W50V-10M(UTSP)	1	397581007T
PCB4	C3034	UTSP C	CE04W50V-10M(UTSP)	1	397581007T
PCB4	C3035	C-CERA C	CK725F1E-104Z1	1	332161040R1
PCB4	C3036	UTSP C	CE04W50V-10M(UTSP)	1	397581007T
PCB4	C3037	UTSP C	CE04W50V-10M(UTSP)	1	397581007T
PCB4	C3038	C-CERA C	CK725F1E-104Z1	1	332161040R1
PCB4	C3039	C-CERA C	CK725B1H-102K1	1	332101025R1
PCB4	C3040	UTSP C	CE04W50V-10M(UTSP)	1	397581007T
PCB4	C3041	UTSP C	CE04W50V-10M(UTSP)	1	397581007T
PCB4	C3042	C-CERA C	CK725F1E-104Z1	1	332161040R1
PCB4	C3043	C-CERA C	CK725B1H-102K1	1	332101025R1
PCB4	C3044	UTSP C	CE04W50V-1M(UTSP)	1	397580107T
PCB4	C3045	UTSP C	CE04W50V-1M(UTSP)	1	397580107T
PCB4	C3046	UTSP C	CE04W50V-1M(UTSP)	1	397580107T
PCB4	C3047	UTSP C	CE04W50V-1M(UTSP)	1	397580107T
PCB4	C3048	UTSP C	CE04W50V-1M(UTSP)	1	397580107T
PCB4	C3049	UTSP C	CE04W50V-1M(UTSP)	1	397580107T
PCB4	C3050	C-CERA C	CK725B1H-102K1	1	332101025R1
PCB4	C3061	UTSP C	CE04W50V-10M(UTSP)	1	397581007T
PCB4	C3062	C-CERA C	CC725CH1H-101J1	1	342101014R1
PCB4	C3063	C-CERA C	CC725CH1H-101J1	1	342101014R1
PCB4	C3064	C-CERA C	CC725CH1H-101J1	1	342101014R1
PCB4	C3065	C-CERA C	CC725CH1H-101J1	1	342101014R1
PCB4	C3066	C-CERA C	CC725CH1H-101J1	1	342101014R1
PCB4	C3067	C-CERA C	CC725CH1H-101J1	1	342101014R1
PCB4	C3068	C-CERA C	CC725CH1H-470J1	1	342104704R1
PCB4	C3069	C-CERA C	CC725CH1H-470J1	1	342104704R1
PCB4	C3070	C-CERA C	CC725CH1H-470J1	1	342104704R1
PCB4	C6600	TF C	ECQ-B50V-103J	1	374721034T

PCB4	C6602	TF C	ECQ-B50V-103J	1	374721034T	
PCB4	C6603	TF C	ECQ-B50V-103J	1	374721034T	
PCB4	C6605	TF C	ECQ-B50V-103J	1	374721034T	
PCB4	C6607	TF C	ECQ-B50V-103J	1	374721034T	
PCB4	C6640	TF C	ECQ-B50V-103J	1	374721034T	<PP, PA>
PCB4	C6641	TF C	ECQ-B50V-103J	1	374721034T	<PP, PA>
PCB4	C6642	TF C	ECQ-B50V-103J	1	374721034T	<PP, PA>
PCB4	C6643	TF C	ECQ-B50V-103J	1	374721034T	<PP, PA>
PCB4	C6644	TF C	ECQ-B50V-103J	1	374721034T	<PP, PA>
PCB4	C6645	TF C	ECQ-B50V-103J	1	374721034T	<PP, PA>
PCB4	C6646	TF C	ECQ-B50V-103J	1	374721034T	<PP, PA>
PCB4	C6650	TF C	ECQ-B50V-102J	1	374721024T	<PP, PA>
PCB4	C6651	TF C	ECQ-B50V-102J	1	374721024T	<PP, PA>
PCB4	C6652	TF C	ECQ-B50V-102J	1	374721024T	<PP, PA>
PCB4	C6653	TF C	ECQ-B50V-102J	1	374721024T	<PP, PA>
PCB4	C6654	TF C	ECQ-B50V-102J	1	374721024T	<PP, PA>
PCB4	C6655	TF C	ECQ-B50V-102J	1	374721024T	<PP, PA>
PCB4	C6656	TF C	ECQ-B50V-102J	1	374721024T	<PP, PA>
PCB4	C9001	VR C	CE04W63V-470M(VR)	1	394674717S	
PCB4	C9005	UTSP C	CE04W50V 47M(UTSP)	1	397584707T	
PCB4	C9006	C-CERA C	CK725F1E-104Z1	1	332161040R1	
PCB4	C9011	VR C	CE04W16V-10000M(VR)	1	394641037S	
PCB4	C9012	TF C	ECQ-V50V-334J	1	374723344T	
PCB4	C9013	UTSP C	CE04W50V-2.2M(UTSP)	1	397580227T	
PCB4	C9014	UTSP C	CE04W50V-1M(UTSP)	1	397580107T	
PCB4	C9023	UTSP C	CE04W50V-10M(UTSP)	1	397581007T	
PCB4	C9025	VR C	CE04W6.3V-470M(VR)	1	394624717T	
PCB4	C9030	UTSP C	CE04W25V-220M(UTSP)	1	397552217T	
PCB4	C9031	C-CERA C	CK725F1E-104Z1	1	332161040R1	
PCB4	C9032	VR C	CE04W6.3V-470M(VR)	1	394624717T	
PCB4	R3001	C-CARBON R	RN72K1J-000JE	1	435030004R1	
PCB4	R3002	C-CARBON R	RN72K1J-000JE	1	435030004R1	
PCB4	R3003	C-CARBON R	RN72K1J-000JE	1	435030004R1	

PCB4	R3011	C-CARBON R	RN72K1J-750JE	1	435037504R1
PCB4	R3012	C-CARBON R	RN72K1J-750JE	1	435037504R1
PCB4	R3013	C-CARBON R	RN72K1J-750JE	1	435037504R1
PCB4	R3014	C-CARBON R	RN72K1J-750JE	1	435037504R1
PCB4	R3015	C-CARBON R	RN72K1J-750JE	1	435037504R1
PCB4	R3016	C-CARBON R	RN72K1J-750JE	1	435037504R1
PCB4	R3017	C-CARBON R	RN72K1J-750JE	1	435037504R1
PCB4	R3018	C-CARBON R	RN72K1J-750JE	1	435037504R1
PCB4	R3019	C-CARBON R	RN72K1J-750JE	1	435037504R1
PCB4	R3020	C-CARBON R	RN72K1J-750JE	1	435037504R1
PCB4	R3021	C-CARBON R	RN72K1J-750JE	1	435037504R1
PCB4	R3022	C-CARBON R	RN72K1J-750JE	1	435037504R1
PCB4	R3023	C-CARBON R	RN72K1J-750JE	1	435037504R1
PCB4	R3024	C-CARBON R	RN72K1J-750JE	1	435037504R1
PCB4	R3025	C-CARBON R	RN72K1J-750JE	1	435037504R1
PCB4	R3026	C-CARBON R	RN72K1J-750JE	1	435037504R1
PCB4	R3027	C-CARBON R	RN72K1J-750JE	1	435037504R1
PCB4	R3028	C-CARBON R	RN72K1J-750JE	1	435037504R1
PCB4	R3029	C-CARBON R	RN72K1J-750JE	1	435037504R1
PCB4	R3030	C-CARBON R	RN72K1J-750JE	1	435037504R1
PCB4	R3031	C-CARBON R	RN72K1J-750JE	1	435037504R1
PCB4	R3038	METAL R	RNU1/2WCJ-1	1	453530104T
PCB4	R3041	C-CARBON R	RN72K1J-750JE	1	435037504R1
PCB4	R3042	C-CARBON R	RN72K1J-750JE	1	435037504R1
PCB4	R3043	C-CARBON R	RN72K1J-750JE	1	435037504R1
PCB4	R3050	C-CARBON R	RN72K1J-000JE	1	435030004R1
PCB4	R3051	C-CARBON R	RN72K1J-000JE	1	435030004R1
PCB4	R3052	C-CARBON R	RN72K1J-000JE	1	435030004R1
PCB4	R3053	C-CARBON R	RN72K1J-000JE	1	435030004R1
PCB4	R3054	C-CARBON R	RN72K1J-000JE	1	435030004R1
PCB4	R3055	C-CARBON R	RN72K1J-000JE	1	435030004R1
PCB4	R3056	C-CARBON R	RN72K1J-000JE	1	435030004R1
PCB4	R3057	C-CARBON R	RN72K1J-000JE	1	435030004R1

PCB4	R3058	C-CARBON R	RN72K1J-000JE	1	435030004R1	
PCB4	R3059	C-CARBON R	RN72K1J-000JE	1	435030004R1	
PCB4	R3060	C-CARBON R	RN72K1J-000JE	1	435030004R1	
PCB4	R3061	C-CARBON R	RN72K1J-000JE	1	435030004R1	
PCB4	R3062	C-CARBON R	RN72K1J-000JE	1	435030004R1	
PCB4	R3063	C-CARBON R	RN72K1J-000JE	1	435030004R1	
PCB4	R3066	C-CARBON R	RN72K1J-000JE	1	435030004R1	
PCB4	R3067	C-CARBON R	RN72K1J-000JE	1	435030004R1	
PCB4	R3068	C-CARBON R	RN72K1J-000JE	1	435030004R1	
PCB4	R3069	C-CARBON R	RN72K1J-000JE	1	435030004R1	
PCB4	R3070	C-CARBON R	RN72K1J-000JE	1	435030004R1	
PCB4	R3071	C-CARBON R	RN72K1J-000JE	1	435030004R1	
PCB4	R3072	C-CARBON R	RN72K1J-000JE	1	435030004R1	
PCB4	R3073	C-CARBON R	RN72K1J-000JE	1	435030004R1	
PCB4	R3074	C-CARBON R	RN72K1J-000JE	1	435030004R1	
PCB4	R3075	C-CARBON R	RN72K1J-000JE	1	435030004R1	
PCB4	R3089	C-CARBON R	RN72K1J-750JE	1	435037504R1	
PCB4	R6600	C-CARBON R	RN72K2E-220JE	1	435222204R1	<PP, PA>
PCB4	R6601	C-CARBON R	RN72K2E-220JE	1	435222204R1	<PP, PA>
PCB4	R6602	C-CARBON R	RN72K2E-220JE	1	435222204R1	<PP, PA>
PCB4	R6603	C-CARBON R	RN72K2E-220JE	1	435222204R1	<PP, PA>
PCB4	R6604	C-CARBON R	RN72K2E-220JE	1	435222204R1	<PP, PA>
PCB4	R6605	C-CARBON R	RN72K2E-220JE	1	435222204R1	<PP, PA>
PCB4	R6606	C-CARBON R	RN72K2E-220JE	1	435222204R1	<PP, PA>
PCB4	R6610	C-CARBON R	RN72K2E-220JE	1	435222204R1	<PP, PA>
PCB4	R6611	C-CARBON R	RN72K2E-220JE	1	435222204R1	<PP, PA>
PCB4	R6612	C-CARBON R	RN72K2E-220JE	1	435222204R1	<PP, PA>
PCB4	R6613	C-CARBON R	RN72K2E-220JE	1	435222204R1	<PP, PA>
PCB4	R6614	C-CARBON R	RN72K2E-220JE	1	435222204R1	<PP, PA>
PCB4	R6615	C-CARBON R	RN72K2E-220JE	1	435222204R1	<PP, PA>
PCB4	R6616	C-CARBON R	RN72K2E-220JE	1	435222204R1	<PP, PA>
PCB4	R6690	METAL O R	RS1/2WBJ-10	1	443521004T	
PCB4	R6691	METAL O R	RS1/2WBJ-390	1	443523914T	

PCB4	R6692	METAL O R	RS1/2WBJ-390	1	443523914T	
PCB4	R6693	C-CARBON R	RN72K1J-000JE	1	435030004R1	
PCB4	R9001	METAL O R	RS1WBJ-220	1	443622214T	
PCB4	R9002	C-CARBON R	RN72K1J-822JE	1	435038224R1	
PCB4	R9003	C-CARBON R	RN72K1J-822JE	1	435038224R1	
PCB4	R9004	C-CARBON R	RN72K1J-333JE	1	435033334R1	
PCB4	R9011	METAL R	RNU1/2WCJ-4.7	1	453530474T	
PCB4	R9012	METAL R	RNU1/2WCJ-1	1	453530104T	
PCB4	R9013	METAL R	RNU1/2WCJ-1	1	453530104T	
PCB4	R9014	C-CARBON R	RN72K1J-104JE	1	435031044R1	
PCB4	R9024	C-CARBON R	RN72K1J-473JE	1	435034734R1	<PP, PA>
PCB4	R9025	C-CARBON R	RN72K1J-102JE	1	435031024R1	<PP, PA>
PCB4	R9029	METAL R	RNU1WCJ-0.22	1	453632294T	
PCB4	R9030	METAL O R	RS2WBJ-22	1	442722204F	
PCB4	R9031	METAL R	RNU2WCJ-3.3	1	452730334F	
PCB4	R9032	METAL R	RNU2WCJ-3.3	1	452730334F	
PCB4	R9033	METAL R	RNU1/2WCJ-1	1	453530104T	
PCB4	R9035	METAL R	RNU1/2WCJ-1	1	453530104T	<DD, DC>
PCB4	R9036	C-CARBON R	RN72K1J-000JE	1	435030004R1	
PCB4	RL6600	RELAY	NRL-2P5A-DC24-129	1	25065563A	
PCB4	RL6600 or	RELAY	NRL-2P5A-DC24-158	(1)	25065618	
PCB4	RL6602	RELAY	NRL-2P5A-DC24-129	1	25065563A	
PCB4	RL6602 or	RELAY	NRL-2P5A-DC24-158	(1)	25065618	
PCB4	RL6603	RELAY	NRL-2P5A-DC24-129	1	25065563A	
PCB4	RL6603 or	RELAY	NRL-2P5A-DC24-158	(1)	25065618	
PCB4	RL6605	RELAY	NRL-2P5A-DC24-129	1	25065563A	
PCB4	RL6605 or	RELAY	NRL-2P5A-DC24-158	(1)	25065618	
PCB4	RL6607	RELAY	NRL-2P5A-DC24-129	1	25065563A	
PCB4	RL6607 or	RELAY	NRL-2P5A-DC24-158	(1)	25065618	
PCB4	P2004B	SOCKET	NSCT-15P2195	1	25052298	
PCB4	P2005B	SOCKET	NSCT-15P2195	1	25052298	
PCB4	P3001	PIN JACK	NPJ-10PDBY621	1	25045842	
PCB4	P3001 or	PIN JACK	NPJ-10PDBY478	(1)	25045681	



PCB4	P3002	PIN JACK	NPJ-5PDBY622	1	25045843	
PCB4	P3002 or	PIN JACK	NPJ-5PDBY479	(1)	25045682	
PCB4	P3003	PIN JACK	NPJ-10PDBY621	1	25045842	
PCB4	P3003 or	PIN JACK	NPJ-10PDBY478	(1)	25045681	
PCB4	P3005	PIN JACK	NPJ-9PDGLRGLRGLR563	1	25045781	
PCB4	P3005 or	PIN JACK	NPJ-9PDGLR519	(1)	25045731	
PCB4	P6601	TRM	NTM-2PDMCR400	1	25060472	
PCB4	P6602	TRM	NTM-4PDMNRR420	1	25060492	
PCB4	P6603	TRM	NTM-4PDMNRR420	1	25060492	
PCB4	P6604	TRM	NTM-4PDMNRR420	1	25060492	
PCB4	E9001	TRM-423(SCREW)	NEJITANSI ST3	1	25060495	
PCB4	E9002	RETAINER	(JOINT)	1	27142069	
PCB4	JL6600B	SOCKET	NSCT-7P99	1	25050271	
PCB4	JL6603B	SOCKET	NSCT-9P101	1	25050273	
PCB4	JL6604B	SOCKET	NSCT-5P97	1	25050269	
PCB4	JL6605B	SOCKET	NSCT-5P97	1	25050269	
PCB4	JL8001	JUMPER LEAD	JL5 100 B	1	---	NSP
PCB4	JL8001A	WIRE HOL	NSCT-5P876	1	25051089	
PCB4	JL901B	WIRE TRAP	NPLG-5P588	1	25055626	
PCB4	JL9101B	SOCKET	NSCT-7P99	1	25050271	
PCB4	JL9102	JUMPER LEAD	JL7 150 UL2651#24	1	---	NSP
PCB4	JL9102A	WIRE HOL	NSCT-7P878	1	25051091	
PCB4	JL9102B	WIRE HOL	NSCT-7P878	1	25051091	
PCB5	<b>U42</b>	DSP/HDMI PC BOARD (NAHDM-9565-1A)				
PCB5						
PCB5	<b>CIRCUIT NO.</b>	<b>PART NAME</b>	<b>DESCRIPTION</b>	<b>Q'TY</b>	<b>PART NO. (SN)</b>	<b>REMARKS</b>
PCB5	Q201	IC	D788E001BRFP266	1	22242502R3	
PCB5	Q202	IC	TC74VHC157FT	1	22274157ER2TO	
PCB5	Q203	IC	TC7WU04FU(TE12L_F)	1	22240935R2	
PCB5	Q205	IC	TC74VHC541FT(EKJ)	1	22274541E1R2TO	
PCB5	Q271	IC	SI8008TM	1	22242323R2	
PCB5	Q272	IC	TA48033AF(TE16L_NQ)	1	22278033DR2TO	

PCB5	Q272 or	IC	BA33BC0FP	(1)	22278033DR2RH
PCB5	Q272 or	IC	NJM2391DL1-33	(1)	22278033DR2JR
PCB5	Q273	IC	BD7820	1	22242300R2
PCB5	Q281	IC	M12L64164A-7TG	1	22242441R3
PCB5	Q281 or	IC	K4S641632K-UC60	(1)	22242462R2
PCB5	Q282	IC (DSP)	ES29LV160ET-70TG	1	222W0069R3
PCB5	Q282 or	IC (DSP)	S29AL016D70TFI010	(1)	222W0063R3
PCB5	Q8161	IC	TA48018AF(TE16L_NQ)	1	22278018DR2TO
PCB5	Q8161 or	IC	BA18BC0FP	(1)	22278018DR2RH
PCB5	Q8161 or	IC	UPC2918T-E1-AZ	(1)	22278018ER2NE
PCB5	Q8162	IC	SIH9185ACTU	1	22242471R3
PCB5	Q8305	IC	S-812C50BUC-C5ET2G	1	22242407R2
PCB5	Q8306	IC	NC7SZ08P5X_F042	1	22242482R2
PCB5	Q8306 or	IC	TC7SZ08FU(TE85L_F)	(1)	22242071R2TO
PCB5	Q8309	IC	SN74CB3T3306DCT	1	22242454R2
PCB5	Q8401	IC	SIH9034CTU	1	22242487R3
PCB5	Q8404	IC	XC6213B182MR	1	22242443R2
PCB5	Q8405	IC	SN74CB3Q3305PWR	1	22242258R2
PCB5	Q8501	IC	SIH9013CLU	1	22242488R3
PCB5	Q8593	IC	SI8008TM	1	22242323R2
PCB5	Q8595	IC	TA48018AF(TE16L_NQ)	1	22278018DR2TO
PCB5	Q8595 or	IC	BA18BC0FP	(1)	22278018DR2RH
PCB5	Q8595 or	IC	UPC2918T-E1-AZ	(1)	22278018ER2NE
PCB5	Q8652	IC	XC6213B332MR	1	22242277R2
PCB5	Q8653	IC	TA48033AF(TE16L_NQ)	1	22278033DR2TO
PCB5	Q8653 or	IC	BA33BC0FP	(1)	22278033DR2RH
PCB5	Q8653 or	IC	NJM2391DL1-33	(1)	22278033DR2JR
PCB5	Q8654	IC	TA48018AF(TE16L_NQ)	1	22278018DR2TO
PCB5	Q8654 or	IC	BA18BC0FP	(1)	22278018DR2RH
PCB5	Q8654 or	IC	UPC2918T-E1-AZ	(1)	22278018ER2NE
PCB5	D201	DIODE	RB070M-30	1	22380361R2
PCB5	D201 or	C-DIODE	CRS09(TE85L_Q)	(1)	223274R2
PCB5	D203	C-DIODE	1SR154-400	1	22380284R2

PCB5	D204	C-DIODE	KDS4148U	1	223283R2
PCB5	D204 or	C-DIODE	1SS352	(1)	223234R2
PCB5	D204 or	C-DIODE	MA2J111	(1)	223279R2
PCB5	D205	C-DIODE	1SR154-400	1	22380284R2
PCB5	D8301	DIODE	DAN217T146	1	223285R2
PCB5	D8301 or	C-DIODE	1SS226(TE85L_F)	(1)	223266R2
PCB5	D8302	C-DIODE	KDS4148U	1	223283R2
PCB5	D8302 or	C-DIODE	1SS352	(1)	223234R2
PCB5	D8302 or	C-DIODE	MA2J111	(1)	223279R2
PCB5	D8591	DIODE	RB070M-30	1	22380361R2
PCB5	D8591 or	C-DIODE	CRS09(TE85L_Q)	(1)	223274R2
PCB5	X201	CRYSTAL	HC-49USSMD17.734MHz	1	3010442R2
PCB5	X201A	CUSHION	(BUTYL)	1	28141748
PCB5	X8501	CRYSTAL	HC-49-28.332MHz	1	3010417R2
PCB5	L201	CHOKE COIL	BLM21PG221SN1	1	230949R2
PCB5	L202	CHOKE COIL	BLM21PG221SN1	1	230949R2
PCB5	L203	C-CARBON R	RN72K1J-000JE	1	435030004R1
PCB5	L204	EMIFIL	BK1608LM182-T	1	230958R1
PCB5	L205	CHOKE COIL	LBC2518T470M	1	231364M470R2
PCB5	L206	EMIFIL	BK1608LM182-T	1	230958R1
PCB5	L219	CHOKE COIL	BLM21PG221SN1	1	230949R2
PCB5	L241	EMIFIL	ACF451832-333-T	1	230978R2
PCB5	L251	CHOKE COIL	BLM21PG221SN1	1	230949R2
PCB5	L261	EMIFIL	BK1608LL241-T	1	230959R1
PCB5	L271	CHOKE COIL	NCH-2541	1	231363K470
PCB5	L281	CHOKE COIL	BLM21PG221SN1	1	230949R2
PCB5	L282	CHOKE COIL	BLM21PG221SN1	1	230949R2
PCB5	L283	CHOKE COIL	BLM21PG221SN1	1	230949R2
PCB5	L8161	CHOKE COIL	BLM21PG221SN1	1	230949R2
PCB5	L8162	CHOKE COIL	BLM21PG221SN1	1	230949R2
PCB5	L8163	CHOKE COIL	BLM21PG221SN1	1	230949R2
PCB5	L8401	CHOKE COIL	BLM21PG221SN1	1	230949R2
PCB5	L8402	CHOKE COIL	BLM21PG221SN1	1	230949R2

PCB5	L8403	CHOKE COIL	BLM21PG221SN1	1	230949R2
PCB5	L8404	CHOKE COIL	BLM21PG221SN1	1	230949R2
PCB5	L8405	CHOKE COIL	BLM21PG221SN1	1	230949R2
PCB5	L8406	C-R NET	MNR12E0APJ000	1	43464900002R2
PCB5	L8407	C-R NET	MNR12E0APJ000	1	43464900002R2
PCB5	L8408	CHOKE COIL	BLM21PG221SN1	1	230949R2
PCB5	L8409	C-R NET	MNR12E0APJ000	1	43464900002R2
PCB5	L8410	C-R NET	MNR12E0APJ000	1	43464900002R2
PCB5	L8505	CHOKE COIL	BLM21PG221SN1	1	230949R2
PCB5	L8507	CHOKE COIL	NCH-2541	1	231363K470
PCB5	L8508	CHOKE COIL	BLM21PG221SN1	1	230949R2
PCB5	L8601	CHOKE COIL	LBC2518T4R7M	1	231364M047R2
PCB5	L8602	CHOKE COIL	BLM21PG221SN1	1	230949R2
PCB5	L8603	CHOKE COIL	BLM21PG221SN1	1	230949R2
PCB5	L8604	CHOKE COIL	BLM21PG221SN1	1	230949R2
PCB5	L8605	CHOKE COIL	BLM21PG221SN1	1	230949R2
PCB5	L8606	CHOKE COIL	BLM21PG221SN1	1	230949R2
PCB5	L8607	CHOKE COIL	BLM21PG221SN1	1	230949R2
PCB5	L8608	EMIFIL	BK1608LM182-T	1	230958R1
PCB5	C201	C-CERA C	CK725F1E-104Z1	1	332161040R1
PCB5	C202	C-CERA C	CK725F1E-104Z1	1	332161040R1
PCB5	C203	C-CERA C	CK725F1E-104Z1	1	332161040R1
PCB5	C204	C-CERA C	CK725F1E-104Z1	1	332161040R1
PCB5	C205	C-CERA C	CK725F1E-104Z1	1	332161040R1
PCB5	C206	C-CERA C	CK725F1E-104Z1	1	332161040R1
PCB5	C207	C-CERA C	CK725F1E-104Z1	1	332161040R1
PCB5	C208	C-CERA C	CK725F1E-104Z1	1	332161040R1
PCB5	C209	C-CERA C	CK725F1E-104Z1	1	332161040R1
PCB5	C210	C-CERA C	CK725F1E-104Z1	1	332161040R1
PCB5	C211	C-CERA C	CK725F1E-104Z1	1	332161040R1
PCB5	C212	C-CERA C	CK725F1E-104Z1	1	332161040R1
PCB5	C213	C-CERA C	CK725F1E-104Z1	1	332161040R1
PCB5	C214	C-CERA C	CK725F1E-104Z1	1	332161040R1

PCB5	C215	C-CERA C	CK725F1E-104Z1	1	332161040R1
PCB5	C216	C-CERA C	CK725F1E-104Z1	1	332161040R1
PCB5	C217	C-CERA C	CK725F1E-104Z1	1	332161040R1
PCB5	C218	CHIP ELECT C	CEWX4V-220M	1	3981G2217R2
PCB5	C219	C-CERA C	CK725F1A-105Z1	1	332181050R1
PCB5	C220	C-CERA C	CK725F1E-104Z1	1	332161040R1
PCB5	C221	C-CERA C	CK725F1E-104Z1	1	332161040R1
PCB5	C222	C-CERA C	CK725F1E-104Z1	1	332161040R1
PCB5	C223	C-CERA C	CK725F1E-104Z1	1	332161040R1
PCB5	C224	C-CERA C	CK725F1E-104Z1	1	332161040R1
PCB5	C225	C-CERA C	CK725F1E-104Z1	1	332161040R1
PCB5	C226	C-CERA C	CK725F1E-104Z1	1	332161040R1
PCB5	C227	C-CERA C	CK725F1E-104Z1	1	332161040R1
PCB5	C228	C-CERA C	CK725F1E-104Z1	1	332161040R1
PCB5	C229	C-CERA C	CK725F1E-104Z1	1	332161040R1
PCB5	C230	C-CERA C	CK725F1E-104Z1	1	332161040R1
PCB5	C231	C-CERA C	CK725F1E-104Z1	1	332161040R1
PCB5	C232	C-CERA C	CK725F1E-104Z1	1	332161040R1
PCB5	C233	C-CERA C	CK725F1E-104Z1	1	332161040R1
PCB5	C234	C-CERA C	CK725F1E-104Z1	1	332161040R1
PCB5	C235	CHIP ELECT C	CEWX4V-220M	1	3981G2217R2
PCB5	C238	C-CERA C	CC725CH1H-060D1	1	342100602R1
PCB5	C239	C-CERA C	CC725CH1H-060D1	1	342100602R1
PCB5	C241	CHIP ELECT C	CEWX4V-220M	1	3981G2217R2
PCB5	C242	C-CERA C	CK725F1E-104Z1	1	332161040R1
PCB5	C243	C-CERA C	CC725CH1H-101J1	1	342101014R1
PCB5	C244	C-CERA C	CK725F1E-104Z1	1	332161040R1
PCB5	C245	C-CERA C	CK725F1E-104Z1	1	332161040R1
PCB5	C246	C-CERA C	CK725F1E-104Z1	1	332161040R1
PCB5	C247	C-CERA C	CK725F1E-104Z1	1	332161040R1
PCB5	C251	C-CERA C	CK725F1A-105Z1	1	332181050R1
PCB5	C252	C-CERA C	CK725F1E-104Z1	1	332161040R1
PCB5	C271	CD C	UCD1E221MNL1GS	1	396652217R2

PCB5	C272	C-CERA C	CK725B1H-223K1	1	332102235R1
PCB5	C273	C-CERA C	CK725F1E-104Z1	1	332161040R1
PCB5	C274	CD C	UCD1A471MNL1GS	1	396634717R2
PCB5	C275	C-CERA C	CK725F1E-104Z1	1	332161040R1
PCB5	C276	CHIP ELECT C	CEWX4V-100M	1	3981G1017R2
PCB5	C277	C-CERA C	CK725F1E-104Z1	1	332161040R1
PCB5	C278	CHIP ELECT C	CEWX4V-100M	1	3981G1017R2
PCB5	C279	C-CERA C	CK725F1E-104Z1	1	332161040R1
PCB5	C281	CHIP ELECT C	CEWX4V-220M	1	3981G2217R2
PCB5	C282	C-CERA C	CK725F1E-104Z1	1	332161040R1
PCB5	C283	C-CERA C	CC725CH1H-102J1	1	342101024R1
PCB5	C284	CHIP ELECT C	CEWX4V-220M	1	3981G2217R2
PCB5	C285	C-CERA C	CK725F1E-104Z1	1	332161040R1
PCB5	C286	C-CERA C	CK725F1E-104Z1	1	332161040R1
PCB5	C287	C-CERA C	CK725F1E-104Z1	1	332161040R1
PCB5	C288	C-CERA C	CK725F1E-104Z1	1	332161040R1
PCB5	C289	C-CERA C	CK725F1E-104Z1	1	332161040R1
PCB5	C290	C-CERA C	CK725F1E-104Z1	1	332161040R1
PCB5	C291	C-CERA C	CK725F1E-104Z1	1	332161040R1
PCB5	C292	C-CERA C	CK725F1E-104Z1	1	332161040R1
PCB5	C295	C-CERA C	CK725F1E-104Z1	1	332161040R1
PCB5	C8101	C-CERA C	CK725B1H-102K1	1	332101025R1
PCB5	C8102	C-CERA C	CK725B1H-102K1	1	332101025R1
PCB5	C8121	C-CERA C	CK725B1H-102K1	1	332101025R1
PCB5	C8122	C-CERA C	CK725B1H-102K1	1	332101025R1
PCB5	C8141	C-CERA C	CK725B1H-102K1	1	332101025R1
PCB5	C8142	C-CERA C	CK725B1H-102K1	1	332101025R1
PCB5	C8161	C-CERA C	CK725F1E-104Z1	1	332161040R1
PCB5	C8162	CHIP ELECT C	CEWX4V-100M	1	3981G1017R2
PCB5	C8163	C-CERA C	CK725B1H-102K1	1	332101025R1
PCB5	C8164	CHIP ELECT C	CEWX4V-22M	1	3981G2207R2
PCB5	C8165	C-CERA C	CK725F1A-105Z1	1	332181050R1
PCB5	C8166	CHIP ELECT C	CEWX4V-22M	1	3981G2207R2

PCB5	C8167	C-CERA C	CK725F1A-105Z1	1	332181050R1
PCB5	C8168	CHIP ELECT C	CEWX4V-22M	1	3981G2207R2
PCB5	C8169	C-CERA C	CK725F1E-104Z1	1	332161040R1
PCB5	C8170	C-CERA C	CK725F1E-104Z1	1	332161040R1
PCB5	C8171	C-CERA C	CK725F1E-104Z1	1	332161040R1
PCB5	C8172	C-CERA C	CK725F1E-104Z1	1	332161040R1
PCB5	C8173	C-CERA C	CK725F1E-104Z1	1	332161040R1
PCB5	C8174	C-CERA C	CK725F1E-104Z1	1	332161040R1
PCB5	C8175	C-CERA C	CK725F1E-104Z1	1	332161040R1
PCB5	C8176	C-CERA C	CK725F1E-104Z1	1	332161040R1
PCB5	C8177	C-CERA C	CK725F1E-104Z1	1	332161040R1
PCB5	C8178	C-CERA C	CK725F1E-104Z1	1	332161040R1
PCB5	C8179	C-CERA C	CK725F1E-104Z1	1	332161040R1
PCB5	C8180	C-CERA C	CK725F1E-104Z1	1	332161040R1
PCB5	C8181	C-CERA C	CK725F1E-104Z1	1	332161040R1
PCB5	C8198	CD C	UCD1E221MNL1GS	1	396652217R2
PCB5	C8199	CD C	UCD1E221MNL1GS	1	396652217R2
PCB5	C8326	C-CERA C	CK725F1E-104Z1	1	332161040R1
PCB5	C8327	C-CERA C	CK725F1A-105Z1	1	332181050R1
PCB5	C8328	CHIP ELECT C	CEWX16V-22M	1	398142207R2
PCB5	C8329	C-CERA C	CK725F1A-105Z1	1	332181050R1
PCB5	C8330	C-CERA C	CK725F1A-105Z1	1	332181050R1
PCB5	C8331	C-CERA C	CK725F1E-104Z1	1	332161040R1
PCB5	C8348	C-CERA C	CK725B1H-102K1	1	332101025R1
PCB5	C8399	C-CERA C	CK725B1H-102K1	1	332101025R1
PCB5	C8401	CHIP ELECT C	CEWX4V-22M	1	3981G2207R2
PCB5	C8402	CHIP ELECT C	CEWX4V-22M	1	3981G2207R2
PCB5	C8403	C-CERA C	CK725F1A-105Z1	1	332181050R1
PCB5	C8404	C-CERA C	CK725B1H-102K1	1	332101025R1
PCB5	C8405	C-CERA C	CK725F1A-105Z1	1	332181050R1
PCB5	C8406	C-CERA C	CK725B1H-102K1	1	332101025R1
PCB5	C8408	CHIP ELECT C	CEWX4V-22M	1	3981G2207R2
PCB5	C8409	CHIP ELECT C	CEWX4V-22M	1	3981G2207R2

PCB5	C8410	C-CERA C	CK725F1A-105Z1	1	332181050R1
PCB5	C8411	C-CERA C	CK725B1H-102K1	1	332101025R1
PCB5	C8412	C-CERA C	CK725F1A-105Z1	1	332181050R1
PCB5	C8413	C-CERA C	CK725B1H-102K1	1	332101025R1
PCB5	C8414	C-CERA C	CK725F1A-105Z1	1	332181050R1
PCB5	C8415	C-CERA C	CK725B1H-102K1	1	332101025R1
PCB5	C8416	C-CERA C	CK725B1H-102K1	1	332101025R1
PCB5	C8417	C-CERA C	CK725F1A-105Z1	1	332181050R1
PCB5	C8418	CHIP ELECT C	CEWX4V-22M	1	3981G2207R2
PCB5	C8419	C-CERA C	CK725B1H-102K1	1	332101025R1
PCB5	C8420	C-CERA C	CK725F1A-105Z1	1	332181050R1
PCB5	C8421	C-CERA C	CK725B1H-102K1	1	332101025R1
PCB5	C8422	C-CERA C	CK725F1A-105Z1	1	332181050R1
PCB5	C8423	C-CERA C	CK725B1H-102K1	1	332101025R1
PCB5	C8424	C-CERA C	CK725F1A-105Z1	1	332181050R1
PCB5	C8425	C-CERA C	CK725B1H-102K1	1	332101025R1
PCB5	C8426	C-CERA C	CK725F1A-105Z1	1	332181050R1
PCB5	C8427	C-CERA C	CK725B1H-102K1	1	332101025R1
PCB5	C8428	C-CERA C	CK725F1A-105Z1	1	332181050R1
PCB5	C8429	C-CERA C	CK725B1H-102K1	1	332101025R1
PCB5	C8430	C-CERA C	CK725F1A-105Z1	1	332181050R1
PCB5	C8431	C-CERA C	CK725B1H-102K1	1	332101025R1
PCB5	C8432	C-CERA C	CK725F1A-105Z1	1	332181050R1
PCB5	C8433	C-CERA C	CK725B1H-102K1	1	332101025R1
PCB5	C8434	C-CERA C	CK725F1A-105Z1	1	332181050R1
PCB5	C8435	C-CERA C	CK725F1A-105Z1	1	332181050R1
PCB5	C8436	C-CERA C	CK725F1A-105Z1	1	332181050R1
PCB5	C8437	CHIP ELECT C	CEWX4V-22M	1	3981G2207R2
PCB5	C8438	C-CERA C	CK725B1H-102K1	1	332101025R1
PCB5	C8441	C-CERA C	CK725F1A-105Z1	1	332181050R1
PCB5	C8442	C-CERA C	CK725F1A-105Z1	1	332181050R1
PCB5	C8443	CHIP ELECT C	CEWX4V-220M	1	3981G2217R2
PCB5	C8444	C-CERA C	CK725F1A-105Z1	1	332181050R1



PCB5	C8504	C-CERA C	CK725B1H-102K1	1	332101025R1
PCB5	C8505	CHIP ELECT C	CEWX4V-22M	1	3981G2207R2
PCB5	C8506	C-CERA C	CK725F1A-105Z1	1	332181050R1
PCB5	C8513	C-CERA C	CK725B1H-102K1	1	332101025R1
PCB5	C8514	C-CERA C	CK725F1A-105Z1	1	332181050R1
PCB5	C8515	C-CERA C	CK725B1H-102K1	1	332101025R1
PCB5	C8516	C-CERA C	CK725F1A-105Z1	1	332181050R1
PCB5	C8517	C-CERA C	CK725B1H-102K1	1	332101025R1
PCB5	C8518	C-CERA C	CK725F1A-105Z1	1	332181050R1
PCB5	C8519	C-CERA C	CK725B1H-102K1	1	332101025R1
PCB5	C8520	C-CERA C	CK725F1A-105Z1	1	332181050R1
PCB5	C8521	C-CERA C	CK725F1E-104Z1	1	332161040R1
PCB5	C8522	CHIP ELECT C	CEWX4V-22M	1	3981G2207R2
PCB5	C8523	C-CERA C	CK725F1A-105Z1	1	332181050R1
PCB5	C8525	C-CERA C	CK725B1H-102K1	1	332101025R1
PCB5	C8529	CHIP ELECT C	CEWX4V-22M	1	3981G2207R2
PCB5	C8530	C-CERA C	CK725F1A-105Z1	1	332181050R1
PCB5	C8531	C-CERA C	CK725B1H-102K1	1	332101025R1
PCB5	C8532	C-CERA C	CK725F1A-105Z1	1	332181050R1
PCB5	C8533	C-CERA C	CK725B1H-102K1	1	332101025R1
PCB5	C8534	C-CERA C	CK725F1A-105Z1	1	332181050R1
PCB5	C8535	C-CERA C	CK725B1H-102K1	1	332101025R1
PCB5	C8536	C-CERA C	CK725F1A-105Z1	1	332181050R1
PCB5	C8537	C-CERA C	CK725B1H-102K1	1	332101025R1
PCB5	C8538	C-CERA C	CK725F1A-105Z1	1	332181050R1
PCB5	C8539	C-CERA C	CK725B1H-102K1	1	332101025R1
PCB5	C8540	C-CERA C	CK725F1A-105Z1	1	332181050R1
PCB5	C8541	C-CERA C	CK725B1H-102K1	1	332101025R1
PCB5	C8542	C-CERA C	CK725F1A-105Z1	1	332181050R1
PCB5	C8543	C-CERA C	CK725B1H-102K1	1	332101025R1
PCB5	C8544	C-CERA C	CK725F1A-105Z1	1	332181050R1
PCB5	C8545	C-CERA C	CK725B1H-102K1	1	332101025R1
PCB5	C8546	C-CERA C	CK725F1A-105Z1	1	332181050R1

PCB5	C8547	C-CERA C	CK725B1H-102K1	1	332101025R1
PCB5	C8548	C-CERA C	CK725F1A-105Z1	1	332181050R1
PCB5	C8549	C-CERA C	CK725B1H-102K1	1	332101025R1
PCB5	C8550	C-CERA C	CK725F1A-105Z1	1	332181050R1
PCB5	C8551	C-CERA C	CK725B1H-102K1	1	332101025R1
PCB5	C8552	C-CERA C	CK725F1A-105Z1	1	332181050R1
PCB5	C8553	C-CERA C	CK725B1H-102K1	1	332101025R1
PCB5	C8554	C-CERA C	CK725F1A-105Z1	1	332181050R1
PCB5	C8555	C-CERA C	CK725B1H-102K1	1	332101025R1
PCB5	C8556	C-CERA C	CK725F1A-105Z1	1	332181050R1
PCB5	C8557	C-CERA C	CK725B1H-102K1	1	332101025R1
PCB5	C8558	C-CERA C	CK725F1A-105Z1	1	332181050R1
PCB5	C8559	C-CERA C	CK725B1H-102K1	1	332101025R1
PCB5	C8560	C-CERA C	CK725F1A-105Z1	1	332181050R1
PCB5	C8561	C-CERA C	CK725B1H-102K1	1	332101025R1
PCB5	C8564	CHIP ELECT C	CEWX4V-22M	1	3981G2207R2
PCB5	C8565	CHIP ELECT C	CEWX4V-22M	1	3981G2207R2
PCB5	C8566	C-CERA C	CK725B1H-102K1	1	332101025R1
PCB5	C8567	C-CERA C	CK725F1A-105Z1	1	332181050R1
PCB5	C8568	CHIP ELECT C	CEWX4V-22M	1	3981G2207R2
PCB5	C8569	C-CERA C	CK725B1H-102K1	1	332101025R1
PCB5	C8570	C-CERA C	CK725F1A-105Z1	1	332181050R1
PCB5	C8571	CHIP ELECT C	CEWX4V-22M	1	3981G2207R2
PCB5	C8572	C-CERA C	CK725B1H-102K1	1	332101025R1
PCB5	C8573	C-CERA C	CK725F1A-105Z1	1	332181050R1
PCB5	C8574	C-CERA C	CC725CH1H-070D1	1	342100702R1
PCB5	C8575	C-CERA C	CC725CH1H-070D1	1	342100702R1
PCB5	C8603	C-CERA C	CK725F1A-105Z1	1	332181050R1
PCB5	C8604	C-CERA C	CK725F1A-105Z1	1	332181050R1
PCB5	C8605	CHIP ELECT C	CEWX4V-220M	1	3981G2217R2
PCB5	C8606	C-CERA C	CK725F1E-104Z1	1	332161040R1
PCB5	C8607	CHIP ELECT C	CEWX4V-100M	1	3981G1017R2
PCB5	C8608	C-CERA C	CK725F1A-105Z1	1	332181050R1

PCB5	C8609	CHIP ELECT C	CEWX4V-100M	1	3981G1017R2
PCB5	C8675	CHIP ELECT C	CEWX4V-100M	1	3981G1017R2
PCB5	C8676	C-CERA C	CK725F1A-105Z1	1	332181050R1
PCB5	C8680	CD C	UCD1A471MNL1GS	1	396634717R2
PCB5	C8682	C-CERA C	CK725B1H-223K1	1	332102235R1
PCB5	C8683	CD C	UCD1E221MNL1GS	1	396652217R2
PCB5	C8684	C-CERA C	CK725F1E-104Z1	1	332161040R1
PCB5	C8685	C-CERA C	CK725F1E-104Z1	1	332161040R1
PCB5	R200	C-CARBON R	RN72K1J-221JE	1	435032214R1
PCB5	R201	C-CARBON R	RN72K1J-103JE	1	435031034R1
PCB5	R202	C-CARBON R	RN72K1J-103JE	1	435031034R1
PCB5	R203	C-CARBON R	RN72K1J-103JE	1	435031034R1
PCB5	R205	C-CARBON R	RN72K1J-103JE	1	435031034R1
PCB5	R206	C-CARBON R	RN72K1J-221JE	1	435032214R1
PCB5	R207	C-CARBON R	RN72K1J-221JE	1	435032214R1
PCB5	R208	C-CARBON R	RN72K1J-103JE	1	435031034R1
PCB5	R209	C-CARBON R	RN72K1J-470JE	1	435034704R1
PCB5	R210	C-R NET	RM7LJ330X04	1	43484733004R2
PCB5	R211	C-R NET	RM7LJ330X04	1	43484733004R2
PCB5	R212	C-R NET	RM7LJ330X04	1	43484733004R2
PCB5	R213	C-R NET	RM7LJ330X04	1	43484733004R2
PCB5	R214	C-R NET	RM7LJ330X04	1	43484733004R2
PCB5	R215	C-R NET	RM7LJ330X04	1	43484733004R2
PCB5	R216	C-R NET	RM7LJ330X04	1	43484733004R2
PCB5	R217	C-R NET	RM7LJ330X04	1	43484733004R2
PCB5	R218	C-R NET	RM7LJ330X04	1	43484733004R2
PCB5	R221	C-CARBON R	RN72K1J-750JE	1	435037504R1
PCB5	R230	C-CARBON R	RN72K1J-331JE	1	435033314R1
PCB5	R231	C-CARBON R	RN72K1J-331JE	1	435033314R1
PCB5	R232	C-CARBON R	RN72K1J-331JE	1	435033314R1
PCB5	R233	C-CARBON R	RN72K1J-470JE	1	435034704R1
PCB5	R234	C-CARBON R	RN72K1J-331JE	1	435033314R1
PCB5	R235	C-CARBON R	RN72K1J-331JE	1	435033314R1

PCB5	R236	C-CARBON R	RN72K1J-470JE	1	435034704R1
PCB5	R237	C-CARBON R	RN72K1J-331JE	1	435033314R1
PCB5	R238	C-CARBON R	RN72K1J-221JE	1	435032214R1
PCB5	R239	C-CARBON R	RN72K1J-470JE	1	435034704R1
PCB5	R240	C-CARBON R	RN72K1J-331JE	1	435033314R1
PCB5	R241	C-CARBON R	RN72K1J-331JE	1	435033314R1
PCB5	R242	C-CARBON R	RN72K1J-470JE	1	435034704R1
PCB5	R243	C-CARBON R	RN72K1J-221JE	1	435032214R1
PCB5	R244	C-CARBON R	RN72K1J-470JE	1	435034704R1
PCB5	R245	C-CARBON R	RN72K1J-103JE	1	435031034R1
PCB5	R250	C-CARBON R	RN72K1J-472JE	1	435034724R1
PCB5	R251	C-CARBON R	RN72K1J-221JE	1	435032214R1
PCB5	R252	C-CARBON R	RN72K1J-331JE	1	435033314R1
PCB5	R253	C-CARBON R	RN72K1J-470JE	1	435034704R1
PCB5	R254	C-CARBON R	RN72K1J-470JE	1	435034704R1
PCB5	R255	C-CARBON R	RN72K1J-470JE	1	435034704R1
PCB5	R256	C-CARBON R	RN72K1J-470JE	1	435034704R1
PCB5	R257	C-CARBON R	RN72K1J-470JE	1	435034704R1
PCB5	R258	C-CARBON R	RN72K1J-470JE	1	435034704R1
PCB5	R259	C-CARBON R	RN72K1J-331JE	1	435033314R1
PCB5	R260	C-CARBON R	RN72K1J-470JE	1	435034704R1
PCB5	R261	C-CARBON R	RN72K1J-470JE	1	435034704R1
PCB5	R262	C-CARBON R	RN72K1J-331JE	1	435033314R1
PCB5	R263	C-CARBON R	RN72K1J-331JE	1	435033314R1
PCB5	R264	C-CARBON R	RN72K1J-331JE	1	435033314R1
PCB5	R265	C-CARBON R	RN72K1J-331JE	1	435033314R1
PCB5	R266	C-CARBON R	RN72K1J-221JE	1	435032214R1
PCB5	R267	C-CARBON R	RN72K1J-331JE	1	435033314R1
PCB5	R268	C-CARBON R	RN72K1J-331JE	1	435033314R1
PCB5	R269	C-CARBON R	RN72K1J-331JE	1	435033314R1
PCB5	R270	C-CARBON R	RN72K1J-221JE	1	435032214R1
PCB5	R271	C-CARBON R	RN72K1J-105JE	1	435031054R1
PCB5	R272	C-CARBON R	RN72K1J-151JE	1	435031514R1

PCB5	R273	C-CARBON R	RN72K1J-470JE	1	435034704R1
PCB5	R274	C-CARBON R	RN72K1J-470JE	1	435034704R1
PCB5	R275	C-CARBON R	RN72K1J-470JE	1	435034704R1
PCB5	R279	C-CARBON R	RN72K1J-470JE	1	435034704R1
PCB5	R281	C-CARBON R	RN72K1J-103JE	1	435031034R1
PCB5	R282	C-CARBON R	RN72K1J-103JE	1	435031034R1
PCB5	R283	C-CARBON R	RN72K1J-103JE	1	435031034R1
PCB5	R284	C-CARBON R	RN72K1J-103JE	1	435031034R1
PCB5	R285	C-CARBON R	RN72K1J-103JE	1	435031034R1
PCB5	R286	C-CARBON R	RN72K1J-331JE	1	435033314R1
PCB5	R287	C-CARBON R	RN72K1J-103JE	1	435031034R1
PCB5	R288	C-CARBON R	RN72K1J-103JE	1	435031034R1
PCB5	R289	C-CARBON R	RN72K1J-472JE	1	435034724R1
PCB5	R290	C-CARBON R	RN72K1J-472JE	1	435034724R1
PCB5	R291	C-CARBON R	RN72K1J-332JE	1	435033324R1
PCB5	R292	C-CARBON R	RN72K1J-333JE	1	435033334R1
PCB5	R293	C-CARBON R	RN72K1J-152JE	1	435031524R1
PCB5	R294	C-CARBON R	RN72K1J-152JE	1	435031524R1
PCB5	R295	C-CARBON R	RN72K1J-333JE	1	435033334R1
PCB5	R296	C-CARBON R	RN72K1J-393JE	1	435033934R1
PCB5	R297	C-CARBON R	RN72K1J-393JE	1	435033934R1
PCB5	R8109	C-CARBON R	RN72K1J-473JE	1	435034734R1
PCB5	R8110	C-CARBON R	RN72K1J-472JE	1	435034724R1
PCB5	R8113	C-CARBON R	RN72K1J-103JE	1	435031034R1
PCB5	R8123	C-CARBON R	RN72K1J-103JE	1	435031034R1
PCB5	R8129	C-CARBON R	RN72K1J-473JE	1	435034734R1
PCB5	R8130	C-CARBON R	RN72K1J-472JE	1	435034724R1
PCB5	R8143	C-CARBON R	RN72K1J-103JE	1	435031034R1
PCB5	R8149	C-CARBON R	RN72K1J-473JE	1	435034734R1
PCB5	R8150	C-CARBON R	RN72K1J-472JE	1	435034724R1
PCB5	R8160	C-CARBON R	RN72K1J-103JE	1	435031034R1
PCB5	R8161	C-CARBON R	RN72K1J-681JE	1	435036814R1
PCB5	R8162	C-CARBON R	RN72K1J-101JE	1	435031014R1

PCB5	R8163	C-CARBON R	RN72K1J-222JE	1	435032224R1
PCB5	R8164	C-CARBON R	RN72K1J-222JE	1	435032224R1
PCB5	R8165	C-CARBON R	RN72K1J-103JE	1	435031034R1
PCB5	R8332	C-CARBON R	RN72K1J-102JE	1	435031024R1
PCB5	R8333	C-CARBON R	RN72K1J-103JE	1	435031034R1
PCB5	R8334	C-CARBON R	RN72K1J-182JE	1	435031824R1
PCB5	R8335	C-CARBON R	RN72K1J-182JE	1	435031824R1
PCB5	R8336	C-CARBON R	RN72K1J-472JE	1	435034724R1
PCB5	R8337	C-CARBON R	RN72K1J-473JE	1	435034734R1
PCB5	R8338	C-CARBON R	RN72K1J-473JE	1	435034734R1
PCB5	R8339	C-CARBON R	RN72K2E-470JE	1	435224704R1
PCB5	R8401	C-R NET	RM7LJ220X04	1	43484722004R2
PCB5	R8402	C-CARBON R	RN72K1J-220JE	1	435032204R1
PCB5	R8403	C-R NET	RM7LJ220X04	1	43484722004R2
PCB5	R8404	C-CARBON R	RN72K1J-220JE	1	435032204R1
PCB5	R8405	C-CARBON R	RN72K1J-220JE	1	435032204R1
PCB5	R8408	C-CARBON R	RN72K1J-220JE	1	435032204R1
PCB5	R8409	C-CARBON R	RN72K1J-101JE	1	435031014R1
PCB5	R8410	C-CARBON R	RN72K1J-681JE	1	435036814R1
PCB5	R8411	C-CARBON R	RN72K1J-472JE	1	435034724R1
PCB5	R8414	C-CARBON R	RN72K1J-472JE	1	435034724R1
PCB5	R8415	C-CARBON R	RN72K1J-472JE	1	435034724R1
PCB5	R8416	C-R NET	RM7LJ220X04	1	43484722004R2
PCB5	R8417	C-R NET	RM7LJ220X04	1	43484722004R2
PCB5	R8419	C-R NET	RM7LJ220X04	1	43484722004R2
PCB5	R8420	C-R NET	RM7LJ220X04	1	43484722004R2
PCB5	R8422	C-R NET	RM7LJ220X04	1	43484722004R2
PCB5	R8423	C-R NET	RM7LJ220X04	1	43484722004R2
PCB5	R8425	C-CARBON R	RN72K1J-220JE	1	435032204R1
PCB5	R8426	C-CARBON R	RN72K1J-103JE	1	435031034R1
PCB5	R8427	C-CARBON R	RN72K1J-103JE	1	435031034R1
PCB5	R8429	C-CARBON R	RN72K1J-220JE	1	435032204R1
PCB5	R8431	C-CARBON R	RN72K1J-472JE	1	435034724R1

PCB5	R8432	C-CARBON R	RN72K1J-220JE	1	435032204R1
PCB5	R8442	C-CARBON R	RN72K1J-102JE	1	435031024R1
PCB5	R8501	C-CARBON R	RN72K1J-330JE	1	435033304R1
PCB5	R8502	C-CARBON R	RN72K1J-330JE	1	435033304R1
PCB5	R8503	C-CARBON R	RN72K1J-330JE	1	435033304R1
PCB5	R8504	C-R NET	RM7LJ330X04	1	43484733004R2
PCB5	R8505	C-R NET	RM7LJ330X04	1	43484733004R2
PCB5	R8506	C-CARBON R	RN72K1J-120JE	1	435031204R1
PCB5	R8508	C-R NET	RM7LJ330X04	1	43484733004R2
PCB5	R8509	C-R NET	RM7LJ330X04	1	43484733004R2
PCB5	R8511	C-R NET	RM7LJ330X04	1	43484733004R2
PCB5	R8512	C-R NET	RM7LJ330X04	1	43484733004R2
PCB5	R8514	C-CARBON R	RN72K1J-472JE	1	435034724R1
PCB5	R8516	C-CARBON R	RN72K1J-101JE	1	435031014R1
PCB5	R8517	C-CARBON R	RN72K1J-101JE	1	435031014R1
PCB5	R8518	C-CARBON R	RN72K1J-472JE	1	435034724R1
PCB5	R8519	C-CARBON R	RN72K1J-470JE	1	435034704R1
PCB5	R8520	C-CARBON R	RN72K1J-330JE	1	435033304R1
PCB5	R8521	C-CARBON R	RN72K1J-330JE	1	435033304R1
PCB5	R8522	C-R NET	RM7LJ330X04	1	43484733004R2
PCB5	R8523	C-CARBON R	RN72K1J-330JE	1	435033304R1
PCB5	R8524	C-CARBON R	RN72K1J-330JE	1	435033304R1
PCB5	R8591	C-CARBON R	RN72K1J-332JE	1	435033324R1
PCB5	R8592	C-CARBON R	RN72K1J-333JE	1	435033334R1
PCB5	R8593	C-CARBON R	RN72K1J-152JE	1	435031524R1
PCB5	R8594	C-CARBON R	RN72K1J-152JE	1	435031524R1
PCB5	R8595	C-CARBON R	RN72K1J-000JE	1	435030004R1
PCB5	R8596	C-CARBON R	RN72K1J-000JE	1	435030004R1
PCB5	R8597	C-CARBON R	RN72K1J-101JE	1	435031014R1
PCB5	R8629	C-CARBON R	RN72K1J-562JE	1	435035624R1
PCB5	R8630	C-CARBON R	RN72K1J-562JE	1	435035624R1
PCB5	R8633	C-CARBON R	RN72K1J-102JE	1	435031024R1
PCB5	R8662	C-CARBON R	RN72K1J-105JE	1	435031054R1

PCB5	P8001B	SOCKET	IMSA-9111S-16L	1	25053258	
PCB5	P8002B	SOCKET	IMSA-9111S-16L	1	25053258	
PCB5	P8003B	SOCKET	IMSA-9111S-16L	1	25053258	
PCB5	P8101	SOCKET	YKF45-7037V	1	25053253R3	
PCB5	P8121	SOCKET	YKF45-7037V	1	25053253R3	
PCB5	P8141	SOCKET	YKF45-7037V	1	25053253R3	
PCB5	P8302	SOCKET	YKF45-7037V	1	25053253R3	
PCB5	JL8001B	WIRE TRAP	NPLG-5P588	1	25055626	

## TX-SR576

## PACKING PROCEDURE PARTS LIST

	REF. NO.	PART NAME	DESCRIPTION	Q'TY	PART NO. (SN)	REMARKS
PV	A601	PAD	L & R 1set	1	29092351A	
PV	A603	POLY BAG	w850 x d650	1	29100245	
PV	A604	POLY BAG	D250 x d300 x W300(t0.04)	1	29100256A	
PV	A605	TAPE	NITTO NO.29 yellow	(1)	29110149	
PV	A606	PP TAPE	W50 SBT-70	(1)	29110200	
PV	A607	SHEET	---	1	29095906	
PV	A608	POLY BAG	w250 x d350	1	29100250A	<PP, PA>
PV	A701	CARTON	TX-SR576	1	29054825	
PV	A702	UPC LABEL	TX-SR576(B)MDD	1	29390208	(B) <DD>
PV	A702	UPC LABEL	TX-SR576(B)MDC	1	29390147	(B) <DC>
PV	A702	EAN LABEL	TX-SR576(B)MPP	1	29390161	(B) <PP>
PV	A702	EAN LABEL	TX-SR576(B)MPA	1	29390162	(B) <PA>
PV	A702	UPC LABEL	TX-SR576(S)MDD	1	29390148	(S) <DD>
PV	A702	EAN LABEL	TX-SR576(S)MPP	1	29390163	(S) <PP>
PV	A702	EAN LABEL	TX-SR576(S)MPA	1	29390164	(S) <PA>
PV	A801	INS MANUAL	En(TX-SR506/576)	1	29344637B	
PV	A802	INS MANUAL	U2FrEs(TX-SR506/576)	1	29344638B	<DC, PP>
PV	A803	INS MANUAL	U2ItDe(TX-SR506/576)	1	29344639A	<PP>
PV	A804	INS MANUAL	U2NISv(TX-SR506/576)	1	29344640A	<PP>
PV	A805	INS MANUAL	En(QSS_TX-SR576)	1	29344649	



PV	A806	INS MANUAL	U9(RC707/708/709/710/711)	1	29344636	
PV	A807	INST SHEET	En(576 RIHD)US	1	29355701	<DD, DC>
PV	A808	INST SHEET	U2FrEs(576 RIHD)US	1	29355702	<DC>
PV	A809	INST SHEET	U7EnFrEsItDeNISv(576 RIHD)	1	29355703	<PP, PA>
PV	A810	INST SHEET	WEEE	1	29355537	
PV	A815	HANDBILL	(DS-A2X)US	1	29380150	<DD, DC>
PV	A815	HANDBILL	(DS-A2X)EU	1	29380151	<PP>
PV	A815	HANDBILL	(DS-A2X)AUS	1	29380152	<PA>
PV	A816	WRNTY CARD	(ONKYO)	1	29365102A	<DD, DC>
PV	A817	LABEL	(SPCABLE)	1	29390189	
PV	A821	REMO CON	RC-709M	1	24140709	
PV	A822	BATTERY	R6/AA(UM-3)	2	3010194	
PV	A822 or	BATTERY	R6/AA(UM-3)	(2)	3010054	
PV	A823	ANT COIL	NMA-3057	1	232140	
PV	A824	FM ANT AS	Type W	1	292191	
PV	A825	MIC (SETUP)	MIC-5001	1	245043	

**ONKYO CORPORATION**

Sales & Product Planning Div. : 2-1, Nisshin-cho, Neyagawa-shi, OSAKA 572-8540, JAPAN  
Tel: 072-831-8023 Fax: 072-831-8163

**ONKYO U.S.A. CORPORATION**

18 Park Way, Upper Saddle River, N.J. 07458, U.S.A.  
Tel: 201-785-2600 Fax: 201-785-2650 <http://www.us.onkyo.com/>

**ONKYO EUROPE ELECTRONICS GmbH**

Liegnitzerstrasse 6, 82194 Groebenzell, GERMANY  
Tel: +49-8142-4401-0 Fax: +49-8142-4401-555 <http://www.eu.onkyo.com/>

**ONKYO EUROPE UK Office**

Suite 1, Gregories Court, Gregories Road, Beaconsfield, Buckinghamshire, HP9 1HQ  
UNITED KINGDOM Tel: +44-(0)1494-681515 Fax: +44(0)-1494-680452

**ONKYO CHINA LIMITED**

Units 2102-2107, Metroplaza Tower I, 223 Hing Fong Road, Kwai Chung,  
N.T., HONG KONG Tel: 852-2429-3118 Fax: 852-2428-9039  
<http://www.ch.onkyo.com/>

