

ONKYO SERVICE MANUAL

AV Receiver MODEL TX-SR607(B/S/G)

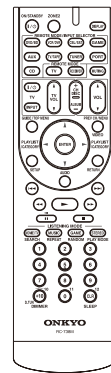
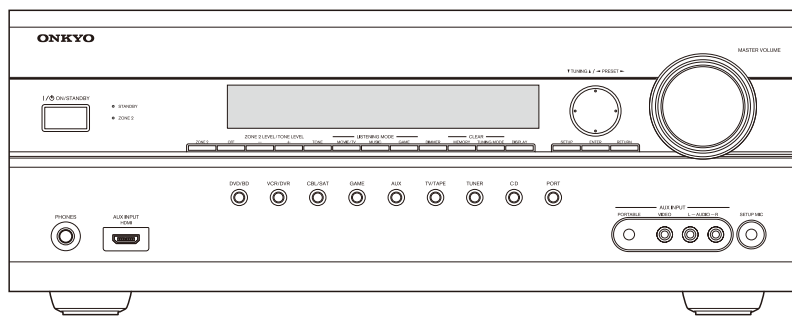

RC-738M

TX-SR607 Black, Silver and Golden models

B MDC, B MDD, S MDD, B MDF	120V AC, 60Hz
B MPP, B MPB, S MPP, S MPB B MPA, S MPA	230V AC, 50Hz
B MMO, S MMO, B MMQ, G MMR	220/230-240V AC, 50/60Hz

SAFETY-RELATED COMPONENT WARNING!!

COMPONENTS IDENTIFIED BY MARK  ON THE SCHEMATIC DIAGRAM AND IN THE PARTS LIST ARE CRITICAL FOR RISK OF FIRE AND ELECTRIC SHOCK. REPLACE THESE COMPONENTS WITH ONKYO PARTS WHOSE PART NUMBERS APPEAR AS SHOWN IN THIS MANUAL.

MAKE LEAKAGE-CURRENT OR RESISTANCE MEASUREMENTS TO DETERMINE THAT EXPOSED PARTS ARE ACCEPTABLY INSULATED FROM THE SUPPLY CIRCUIT BEFORE RETURNING THE APPLIANCE TO THE CUSTOMER.

EXPLODED VIEWS-1

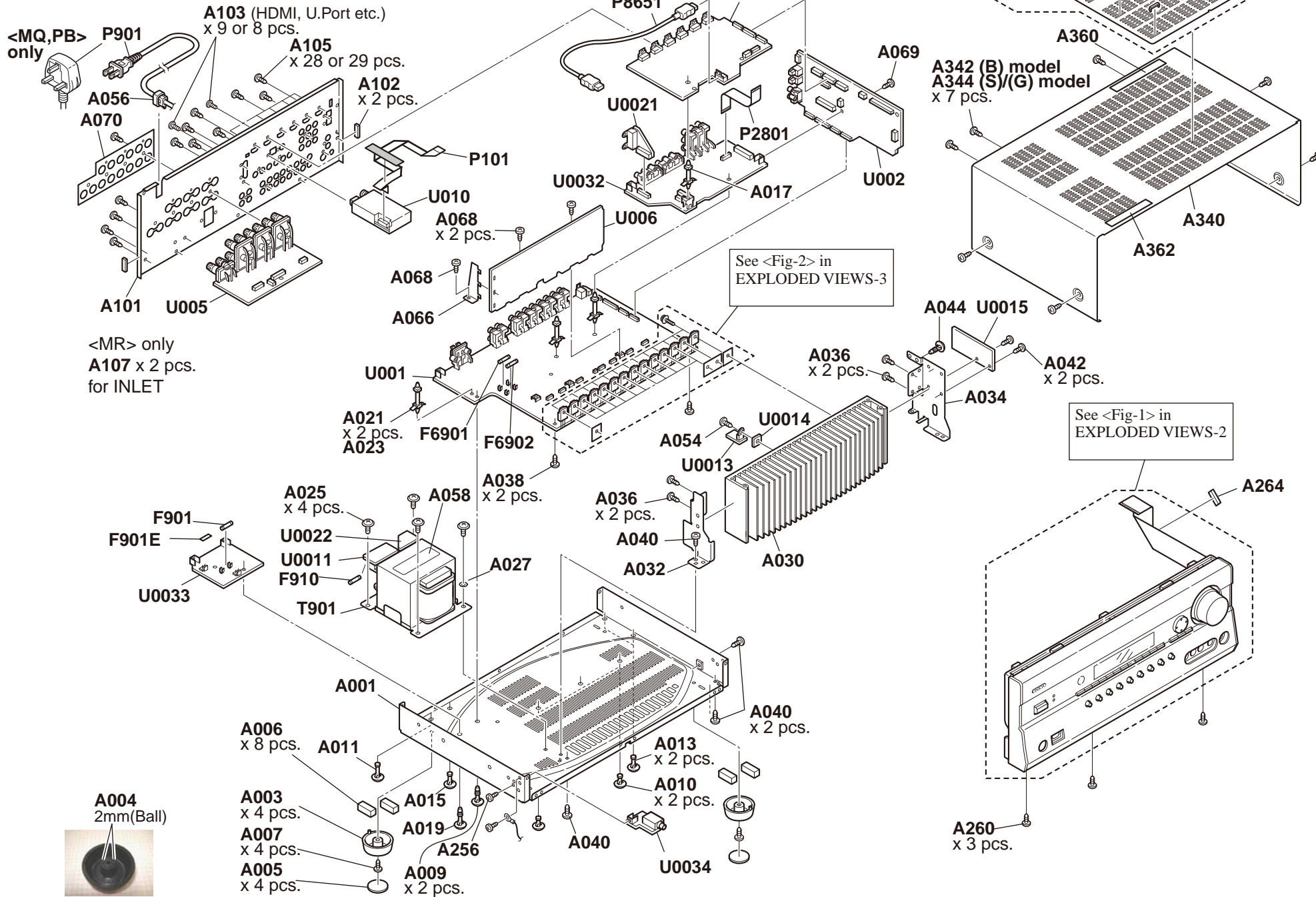

EXPLODED VIEWS-2

<Fig-1>

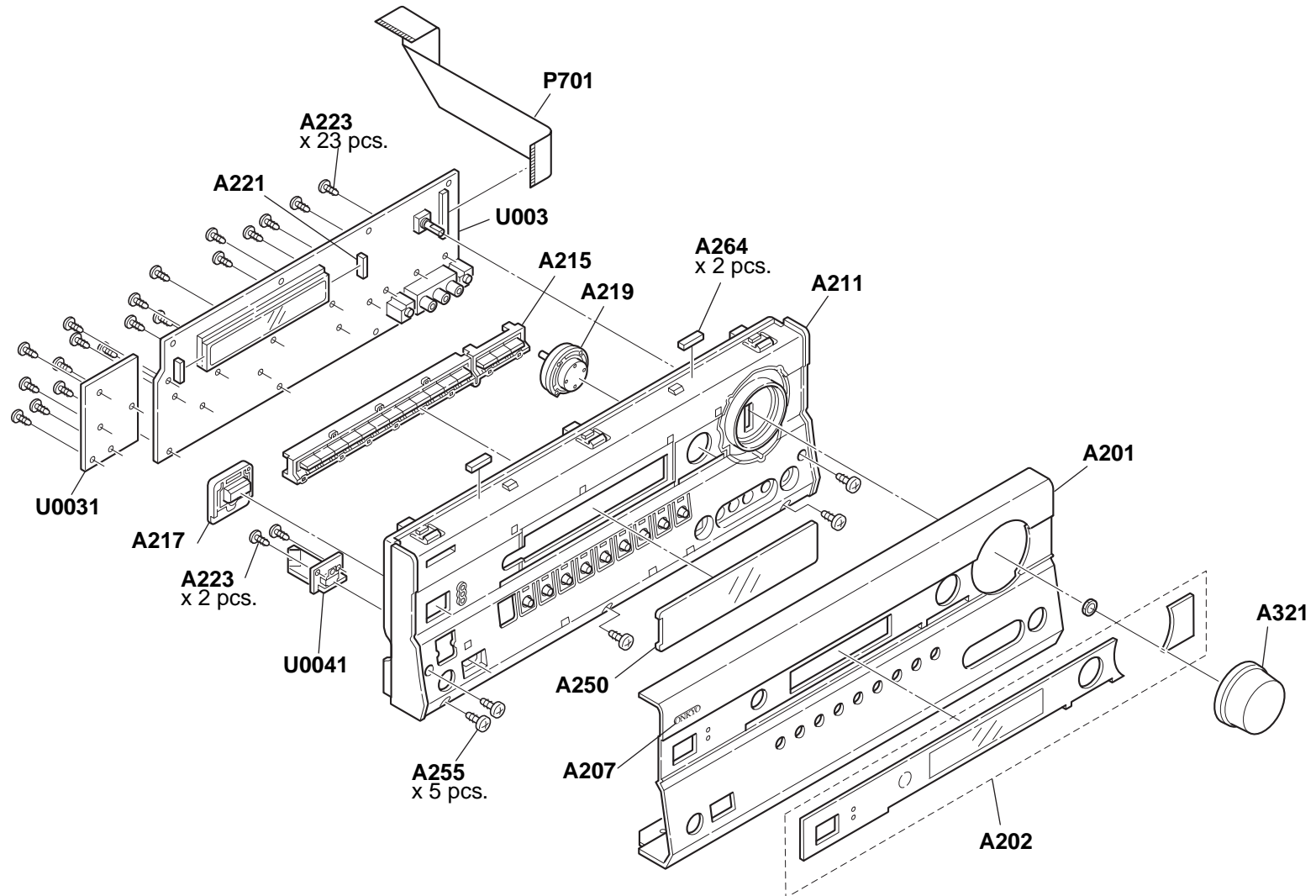

EXPLODED VIEWS-3

<Fig-2>

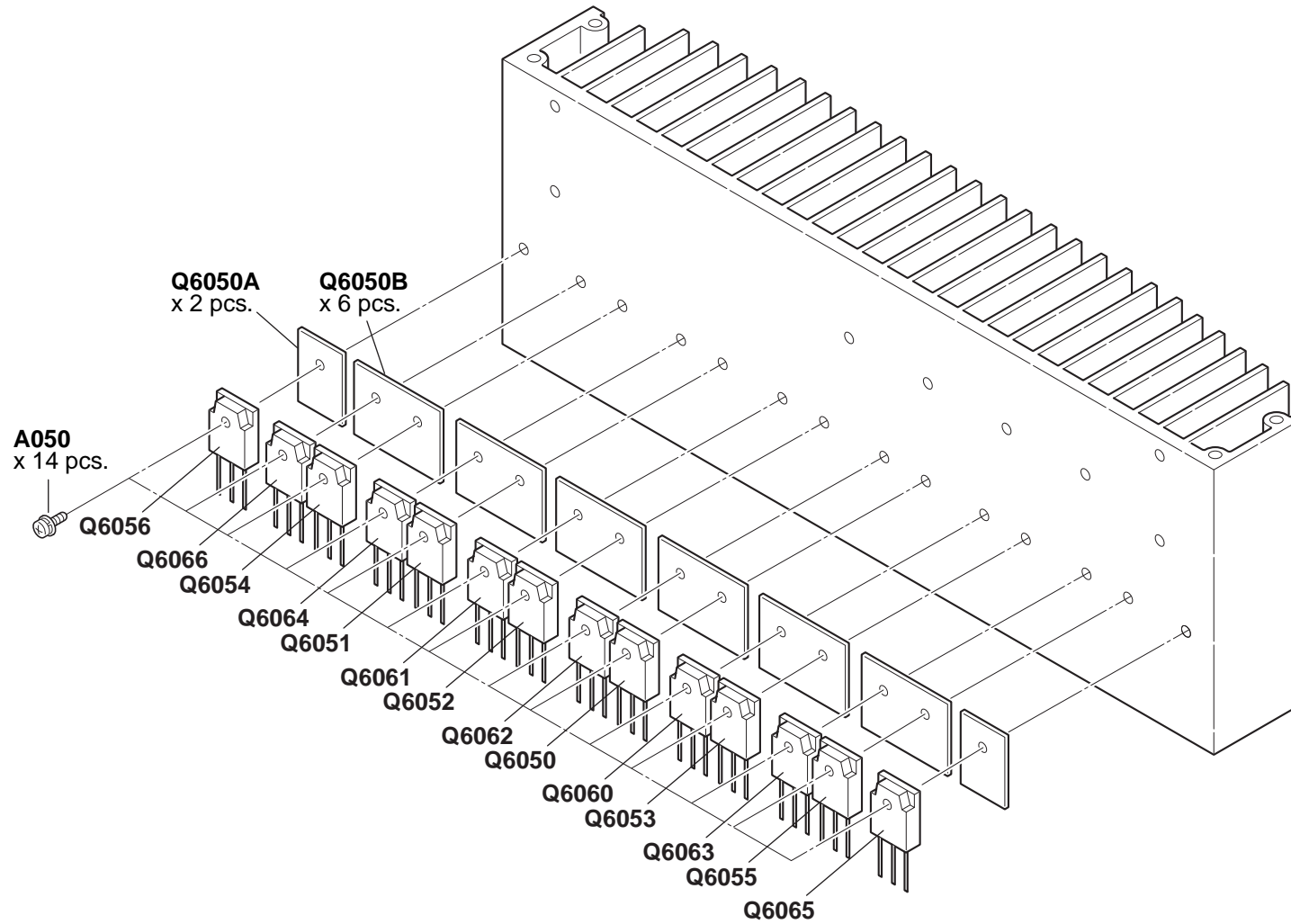

BLOCK DIAGRAMS-1 / PART-1
AUDIO SECTION

1
2
3
4
5
6
7
8

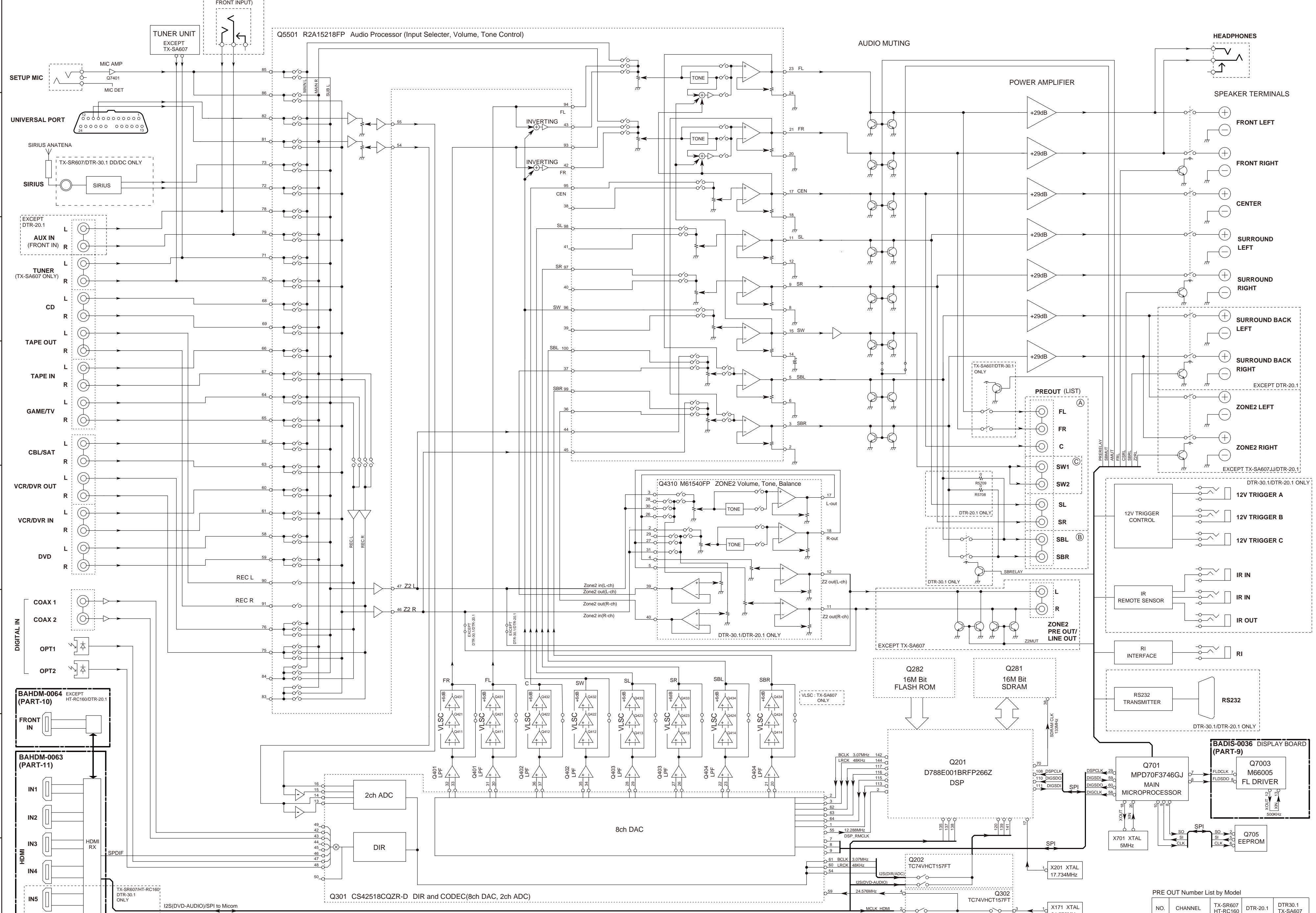

<Note>
Refer to SCHEMATIC DIAGRAM-3 / PART-5 and SCHEMATIC DIAGRAM-17 / PART-19
for digital audio signal waveforms.

PRE OUT Number List by Model

NO.	CHANNEL	TX-SR607 HT-RC160	DTR-20.1	DTR30.1 TX-SA607
(A)	FL/FR/C/SL/SR	NO	NO	YES
(B)	SBL/SBR	NO	YES	YES
(C)	SW1/SW2	YES	YES	YES

BLOCK DIAGRAMS-2 / PART-2
VIDEO SECTION

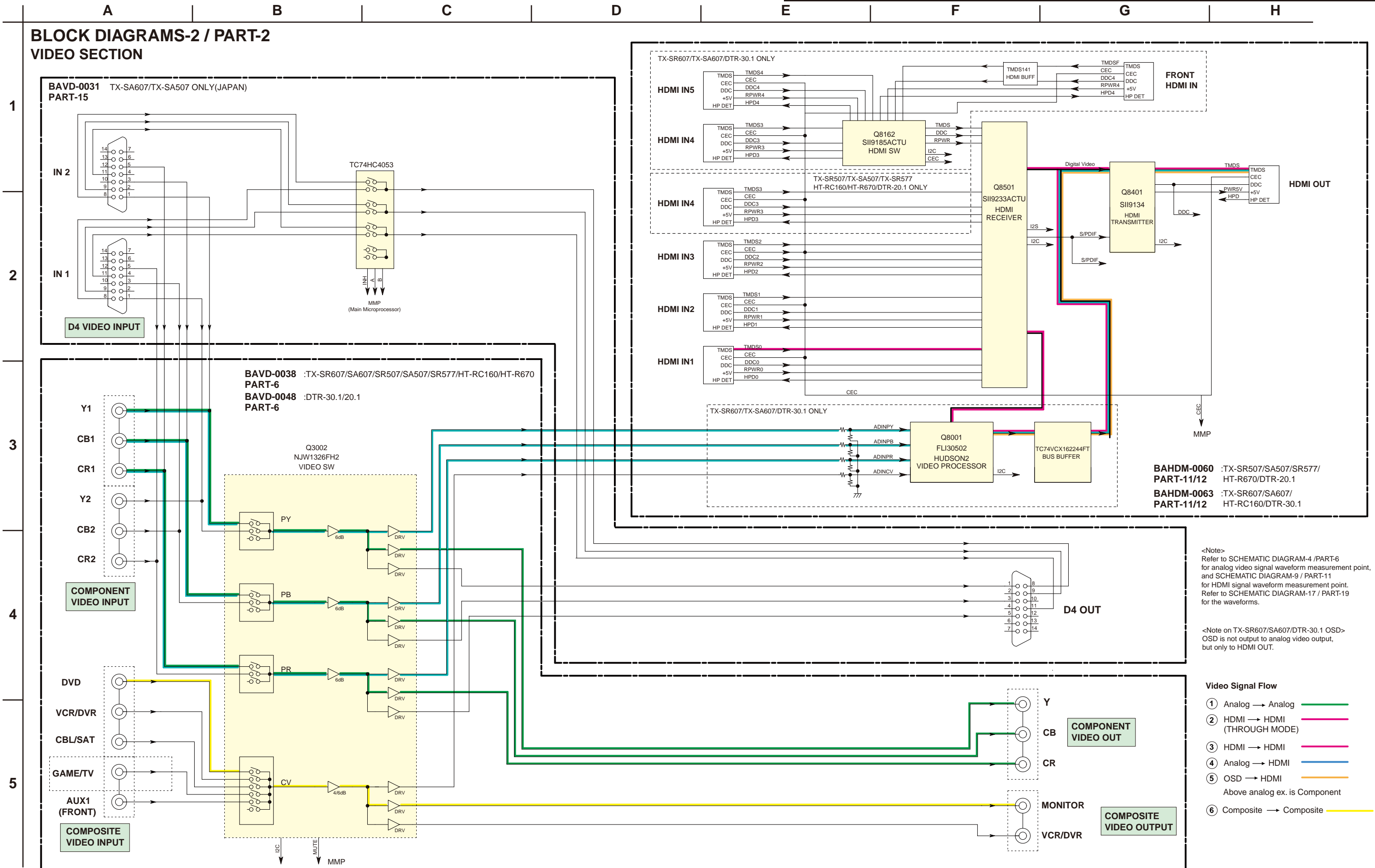

<Note>
Refer to SCHEMATIC DIAGRAM-4 /PART-6 for analog video signal waveform measurement point, and SCHEMATIC DIAGRAM-9 / PART-11 for HDMI signal waveform measurement point. Refer to SCHEMATIC DIAGRAM-17 / PART-19 for the waveforms.

<Note on TX-SR607/SA607/DTR-30.1 OSD>
OSD is not output to analog video output, but only to HDMI OUT.

BAHDM-0060 :TX-SR507/SA507/SR577/
PART-11/12 HT-R670/DTR-20.1
BAHDM-0063 :TX-SR607/SA607/
PART-11/12 HT-RC160/DTR-30.1

SCHEMATIC DIAGRAMS-1 / PART-3
AUDIO SECTION

NOTE:
XY in "SCHEMATIC-a / PART-b:XY" indicates the target location of the plug or socket, X=A to E/H/K, Y=1 to 4/5/8.

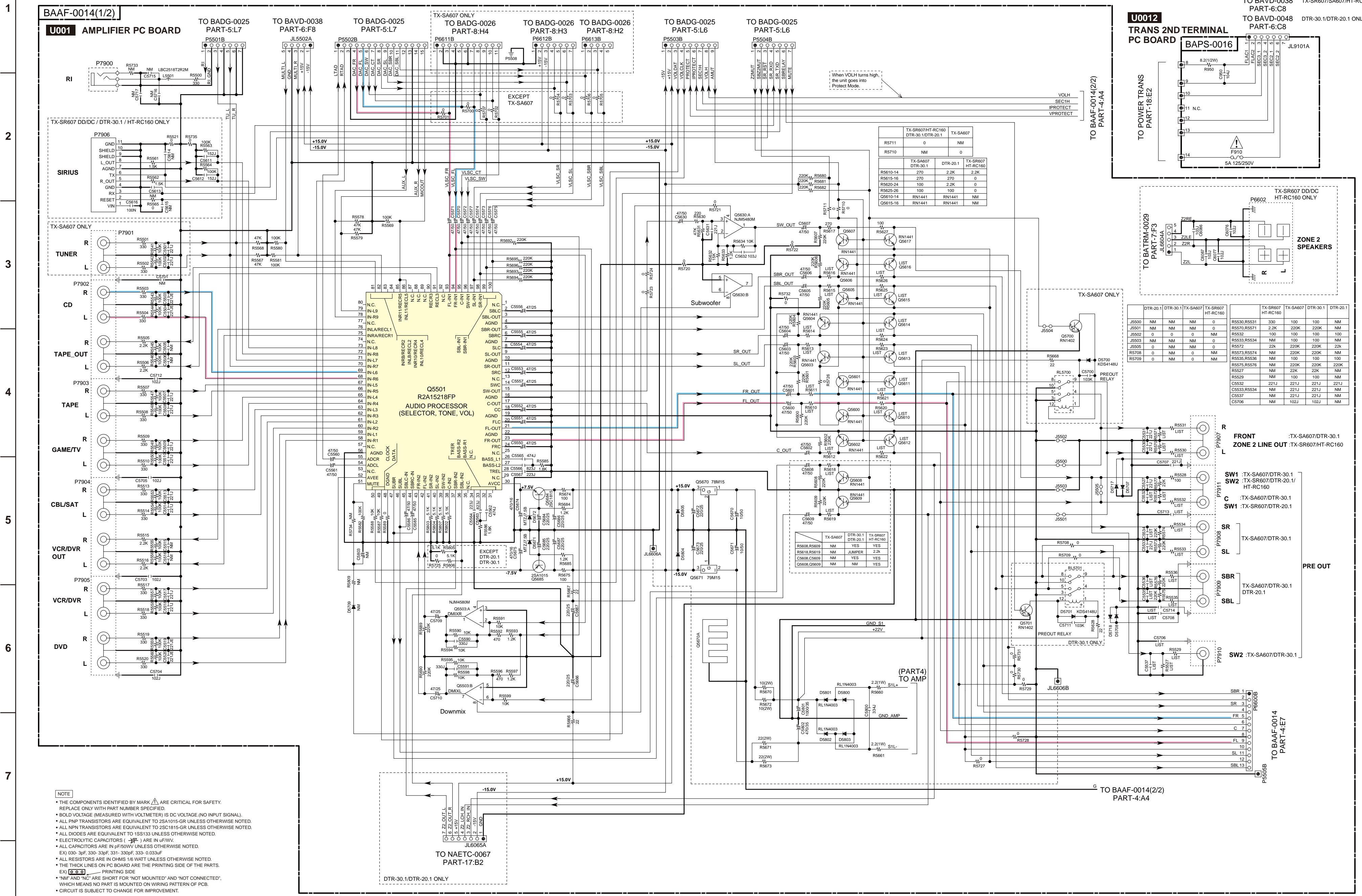

NOTE:
• THE COMPONENTS IDENTIFIED BY MARK ARE CRITICAL FOR SAFETY. REPLACE ONLY WITH PART NUMBER SPECIFIED.
• BOLD VOLTAGE (MEASURED WITH VOLTMETER) IS DC VOLTAGE (NO INPUT SIGNAL).
• ALL PNP TRANSISTORS ARE EQUIVALENT TO 2SA1015-GR UNLESS OTHERWISE NOTED.
• ALL NPN TRANSISTORS ARE EQUIVALENT TO 2SC1815-GR UNLESS OTHERWISE NOTED.
• ALL DIODES ARE EQUIVALENT TO 1SS133 UNLESS OTHERWISE NOTED.
• ELECTROLYTIC CAPACITORS () ARE IN uF/WV.
• ALL CAPACITORS ARE IN pF/50V UNLESS OTHERWISE NOTED.
EX) 030-3pF, 330-33pF, 331-330pF, 333-0.03uF
• ALL RESISTORS ARE IN OHMS 1/6 WATT UNLESS OTHERWISE NOTED.
• THE THICK LINES ON PC BOARD ARE THE PRINTING SIDE OF THE PARTS.
EX) PRINTING SIDE
• "NM" AND "NC" ARE SHORT FOR "NOT MOUNTED" AND "NOT CONNECTED", WHICH MEANS NO PART IS MOUNTED ON WIRING PATTERN OF PCB.
• CIRCUIT IS SUBJECT TO CHANGE FOR IMPROVEMENT.

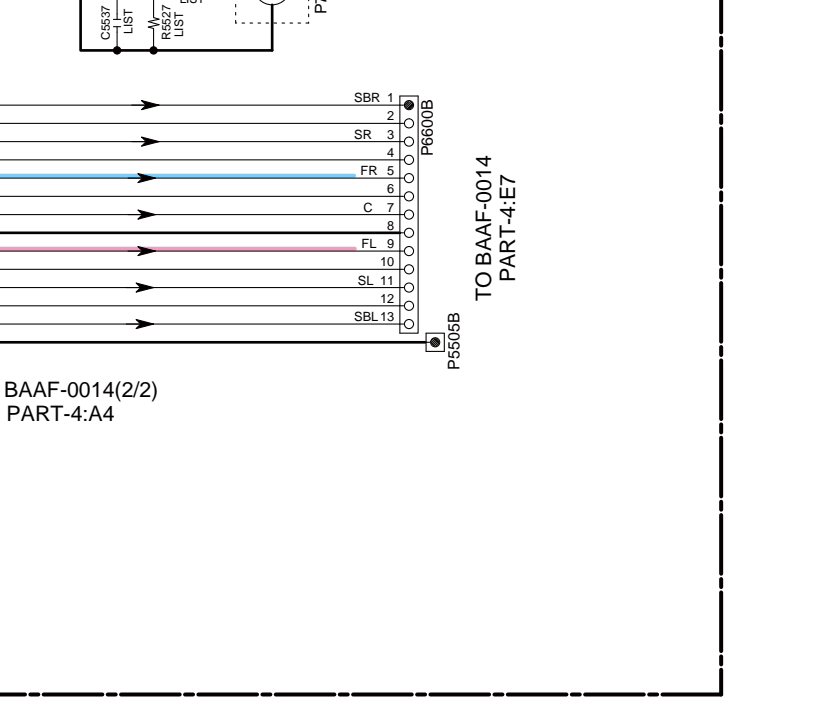
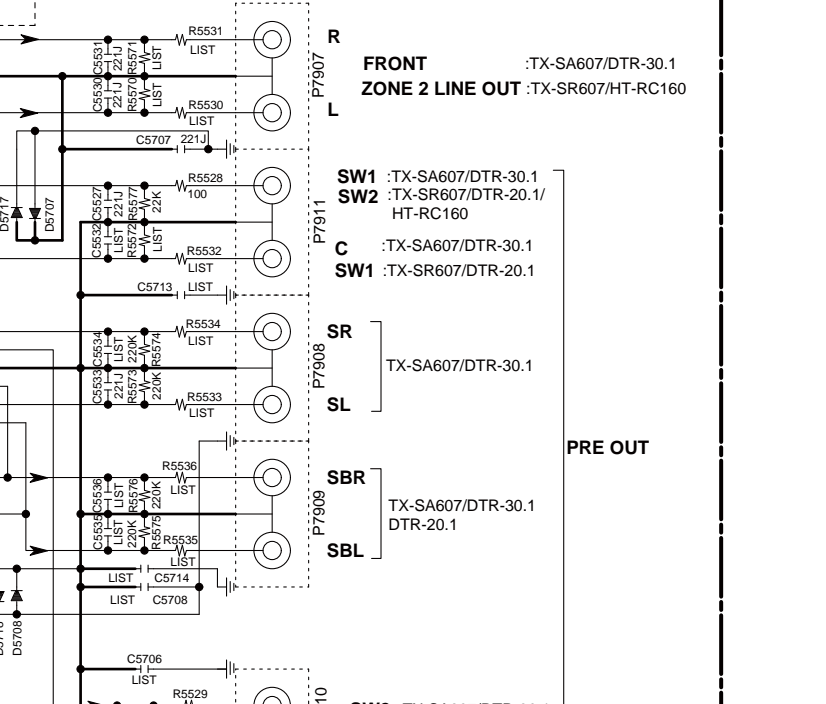
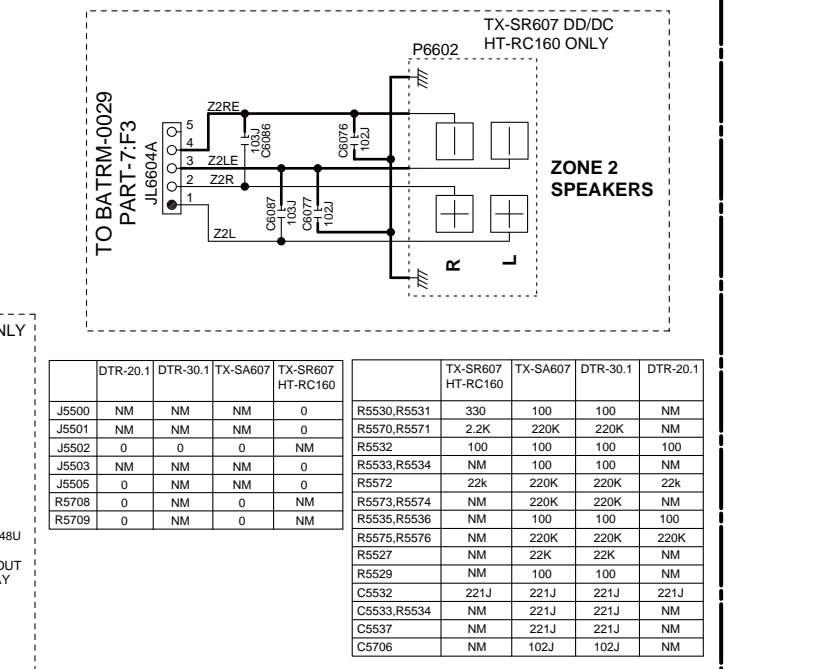
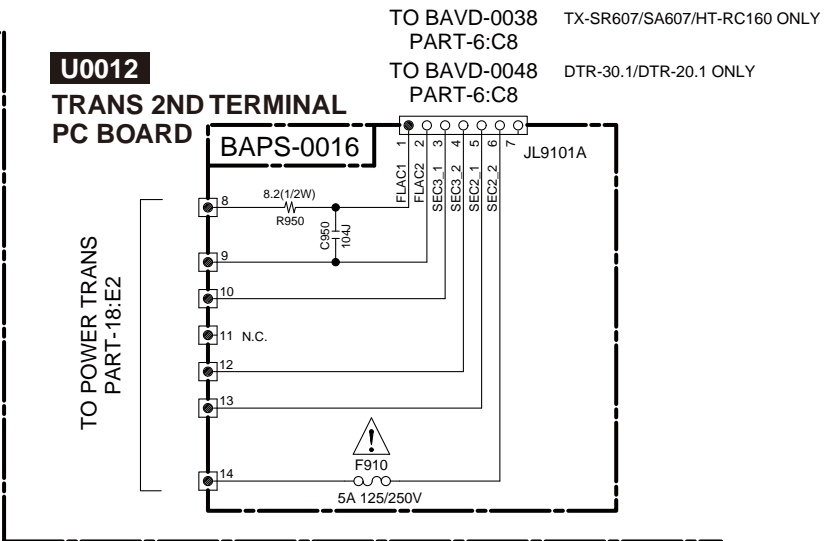

Component list tables for various models and parts.

Model	Part	Value	Notes
TX-SR607/DTR-30.1	R5711	0	NM
TX-SR607/DTR-20.1	R5710	NM	0
TX-SR607/HT-RC160	R5610-14	270	2.2K
TX-SR607/HT-RC160	R5615-16	270	270
TX-SR607/HT-RC160	R5620-24	100	2.2K
TX-SR607/HT-RC160	R5625-28	100	100
TX-SR607/HT-RC160	Q5610-14	RN1441	NM
TX-SR607/HT-RC160	Q5615-16	RN1441	NM

Model	Part	Value	Notes
TX-SR607/HT-RC160	R5500	NM	NM
TX-SR607/HT-RC160	R5501	NM	NM
TX-SR607/HT-RC160	R5502	0	0
TX-SR607/HT-RC160	R5503	NM	NM
TX-SR607/HT-RC160	R5504	NM	NM
TX-SR607/HT-RC160	R5505	NM	NM
TX-SR607/HT-RC160	R5506	NM	NM
TX-SR607/HT-RC160	R5507	NM	NM
TX-SR607/HT-RC160	R5508	NM	NM
TX-SR607/HT-RC160	R5509	0	0
TX-SR607/HT-RC160	R5570	NM	NM
TX-SR607/HT-RC160	R5571	NM	NM
TX-SR607/HT-RC160	R5572	22K	220K
TX-SR607/HT-RC160	R5573	22K	220K
TX-SR607/HT-RC160	R5574	22K	220K
TX-SR607/HT-RC160	R5575	NM	NM
TX-SR607/HT-RC160	R5576	NM	NM
TX-SR607/HT-RC160	R5577	NM	NM
TX-SR607/HT-RC160	R5578	NM	NM
TX-SR607/HT-RC160	R5579	100	100
TX-SR607/HT-RC160	C5823	221J	221J
TX-SR607/HT-RC160	C5833	221J	221J
TX-SR607/HT-RC160	C5837	NM	221J
TX-SR607/HT-RC160	C5798	NM	100J

SCHEMATIC DIAGRAMS-2 / PART-4
POWER AMP SECTION-1

NOTE:
XY in "SCHEMATIC-a / PART-b:XY" indicates the target location of the plug or socket, X=A to E/H/K, Y=1 to 4/5/8.

U001 AMPLIFIER PC BOARD

POWER TRANSISTOR LIST

	TX-SR607 HT-RC160	DTR-30.1	TX-SA607	TX-SR607PP	DTR-20.1
Q6050-Q6054	MN130S	MN130S	2SC5242	2SC5242	MN130S
Q6055, Q6056	MN130S	MN130S	2SC5242	2SC5242	NON
Q6060-Q6064	MP130S	MP130S	2SA1962	2SA1962	MP130S
Q6065, Q6066	MP130S	MP130S	2SA1962	2SA1962	NON

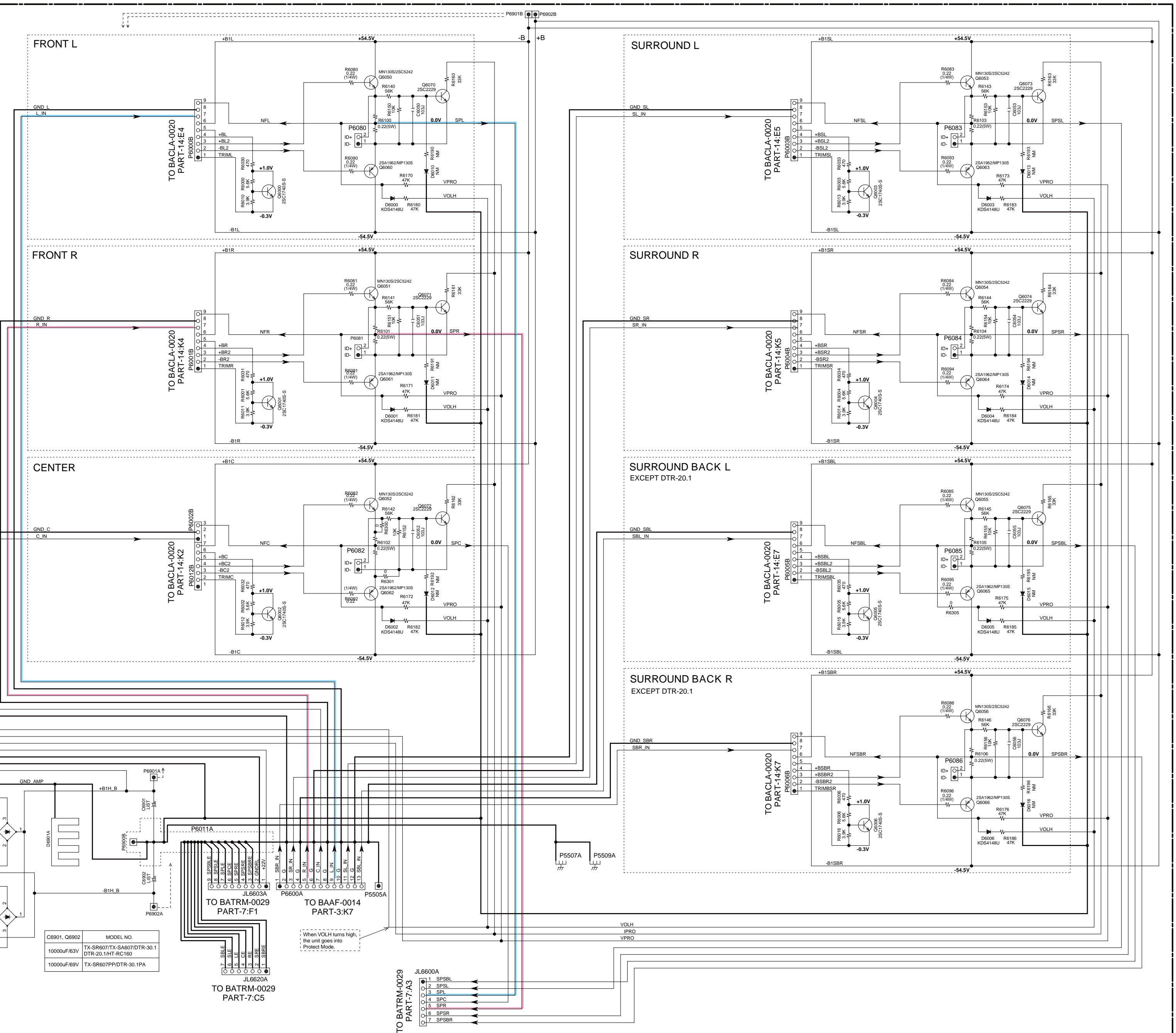
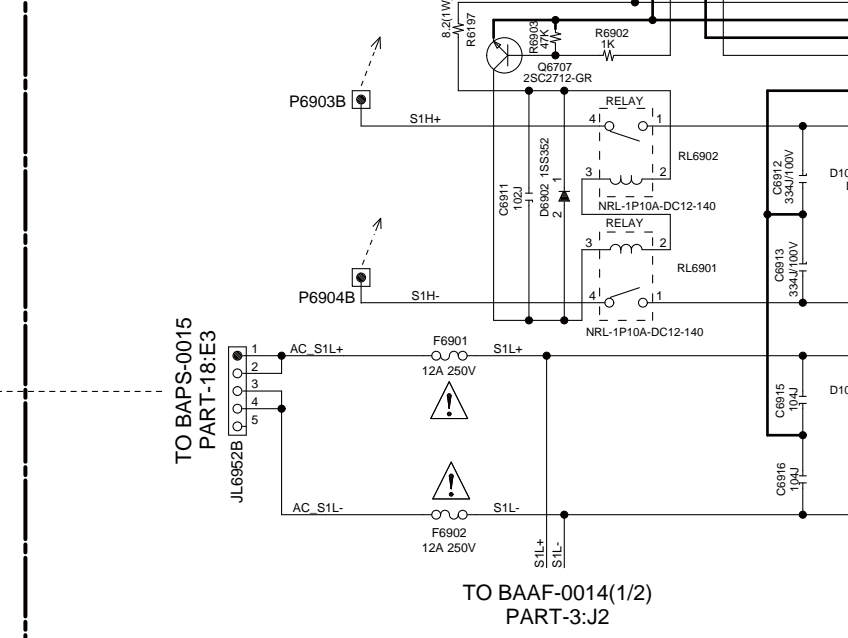
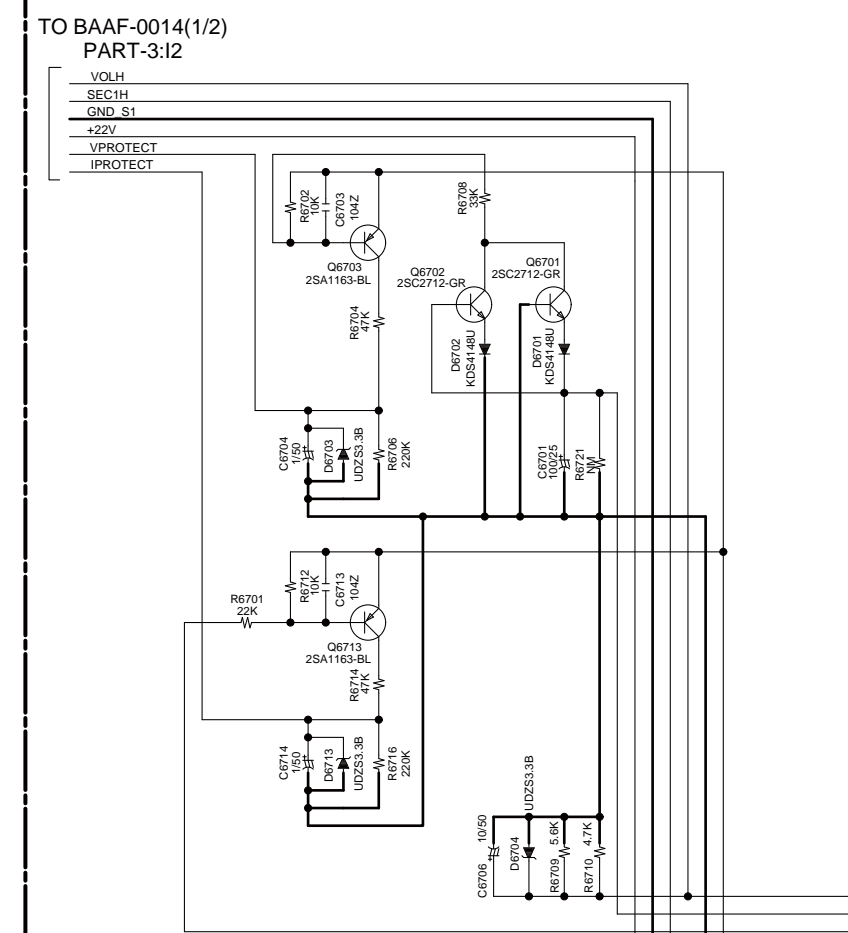
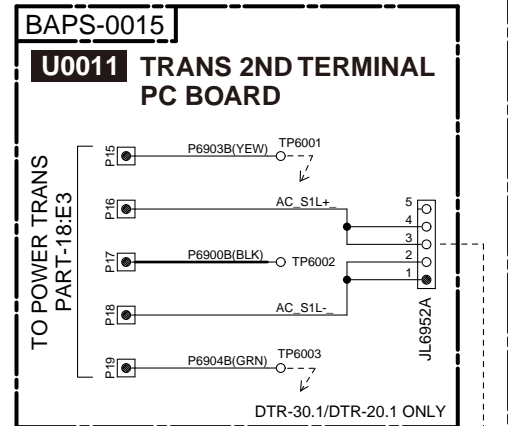
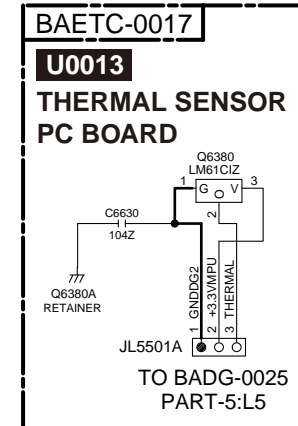

C6901, Q6902	MODEL NO.
10000uF/63V	TX-SR607/TX-SA607/DTR-30.1 DTR-20.1/HT-RC160
10000uF/69V	TX-SR607PP/DTR-30.1PA

When VOLH turns high the unit goes into Protect Mode.

- TO BATRM-0029 PART-7:A3**
- 1 SP5BL
 - 2 SP5L
 - 3 SPC
 - 4 SPC
 - 5 SPR
 - 6 SP5R
 - 7 SP5BR

1
2
3
4
5
6
7
8

SCHEMATIC DIAGRAMS-3 / PART-5
MICROPROCESSOR AND CODEC SECTION

NOTE:
XY in "SCHEMATIC-a / PART-b:XY" indicates the target location of the plug or socket, X=A to E/H/K, Y=1 to 4/5/8.

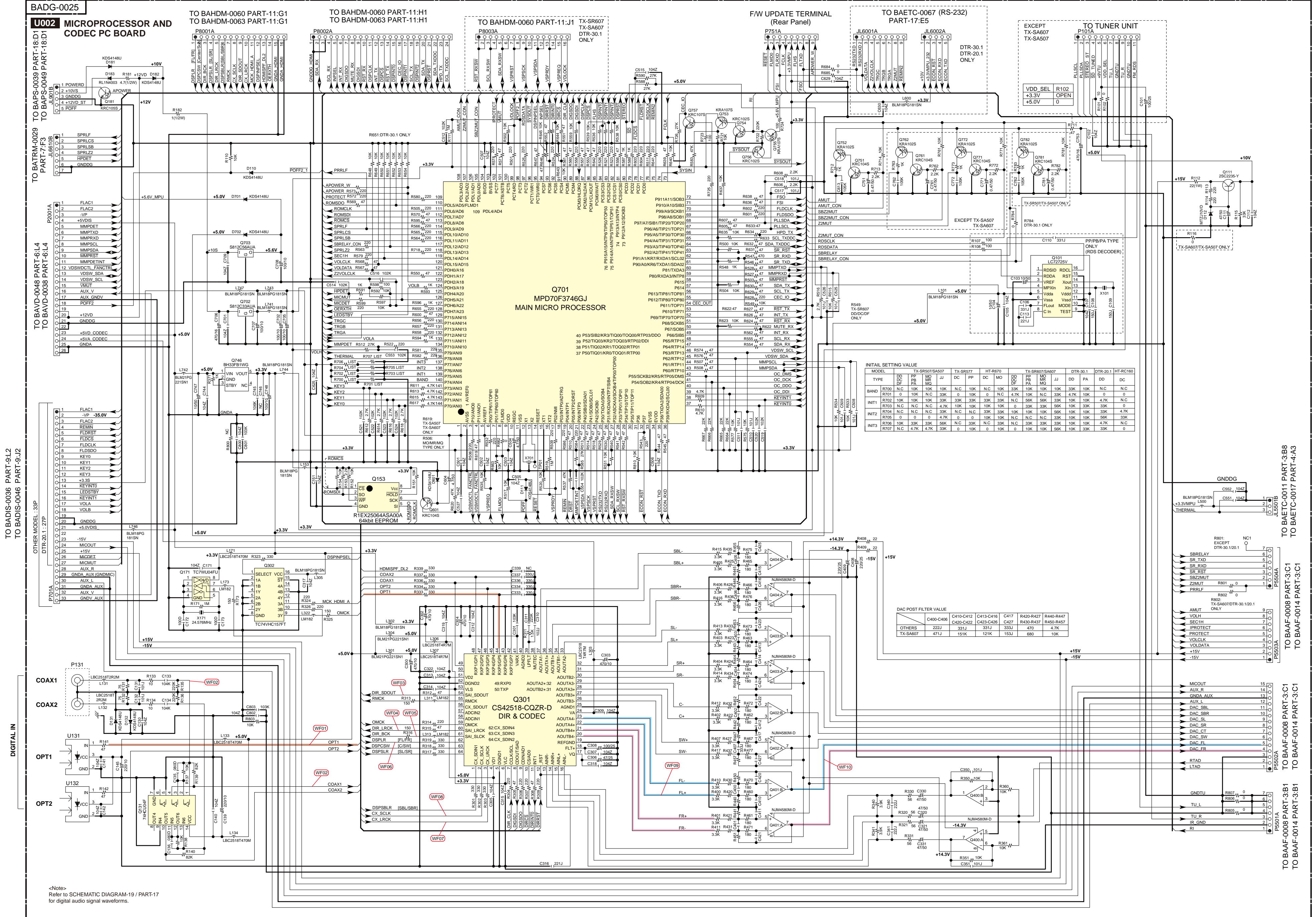

INITIAL SETTING VALUE

MODEL	SD	PP	MC	DC	PP	DC	MD	DD	DD	DD	DD	DD	DD	DD	DD	DD	DD
R700	N.C.	10K	10K	10K	N.C.	10K	33K	10K	10K	33K	10K	10K	N.C.	N.C.	N.C.	N.C.	N.C.
R701	0	10K	N.C.	33K	0	10K	0	N.C.	4.7K	10K	N.C.	33K	4.7K	10K	0	0	0
INT1	R702	10K	10K	10K	33K	33K	33K	33K	10K	33K	10K	10K	4.7K	N.C.	N.C.	N.C.	N.C.
INT2	R704	N.C.	N.C.	N.C.	33K	N.C.	33K	10K	10K	56K	10K	10K	33K	4.7K	4.7K	4.7K	4.7K
INT3	R705	0	0	0	4.7K	0	10K	10K	N.C.	N.C.	33K	10K	10K	56K	33K	33K	33K
	R706	10K	33K	33K	56K	N.C.	33K	N.C.	33K	N.C.	33K	33K	10K	10K	4.7K	N.C.	N.C.
	R707	N.C.	4.7K	4.7K	33K	0	10K	0	10K	0	10K	10K	56K	10K	33K	33K	33K

DAC POST FILTER VALUE

	C400-C406	C410-C412	C413-C416	C417	R420-R427	R440-R447
OTHERS	222J	331J	331J	333J	470	4.7K
TX-SA607	471J	151K	121K	153J	680	10K

<Note>
Refer to SCHEMATIC DIAGRAM-19 / PART-17
for digital audio signal waveforms.

SCHEMATIC DIAGRAMS-4 / PART-6
VIDEO SECTION

NOTE:
XY in "SCHEMATIC-a / PART-b:XY" indicates the target location of the plug or socket, X=A to E/H/K, Y=1 to 4/5/8.

1
2
3
4
5
6
7
8

BAVD-0038
U0032 VIDEO PC BOARD

- Video Signal Flow
- ① Analog → Analog
 - ② HDMI → HDMI (THROUGH MODE)
 - ③ HDMI → HDMI
 - ④ Analog → HDMI
 - ⑤ OSD → HDMI
 - ⑥ Composite → Composite
- Above analog ex. is Component

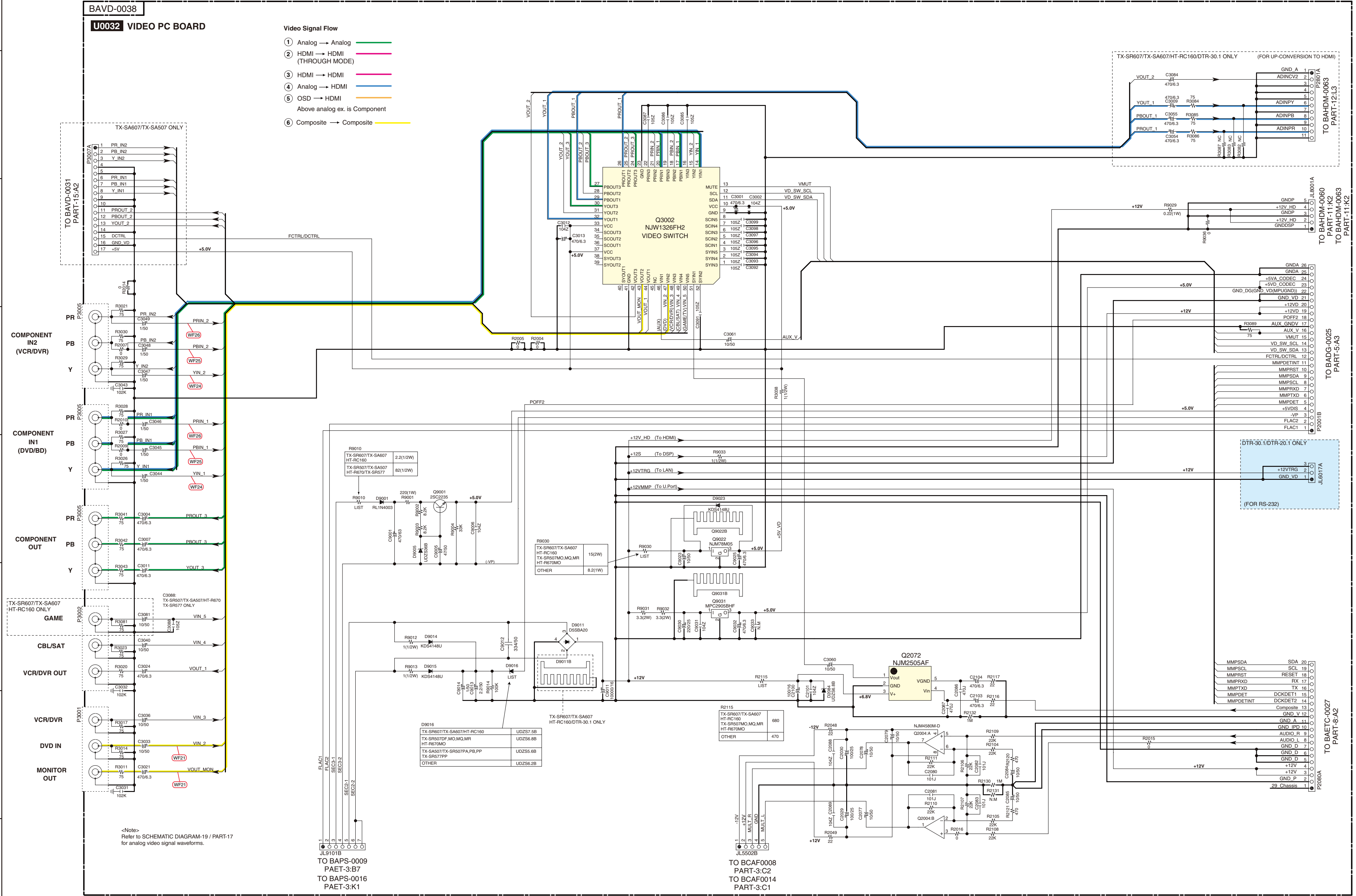

<Note>
Refer to SCHEMATIC DIAGRAM-19 / PART-17
for analog video signal waveforms.

TO BAPS-0009
PAET-3:B7
TO BAPS-0016
PAET-3:K1

TO BCAF0008
PART-3:C2
TO BCAF0014
PART-3:C1

TO BAETC-0027
PART-8:A2

TO BADG-0025
PART-5:A5

TO BAHDM-0060
PART-11:K2
TO BAHDM-0063
PART-11:K2

TO BAHDM-0063
PART-12:L3

SCHEMATIC DIAGRAMS-5 / PART-7
SP TERMINAL SECTION

NOTE:
XY in "SCHEMATIC-a / PART-b:XY" indicates the target location of the plug or socket, X=A to E/H/K, Y=1 to 4/5/8.

1

2

3

4

5

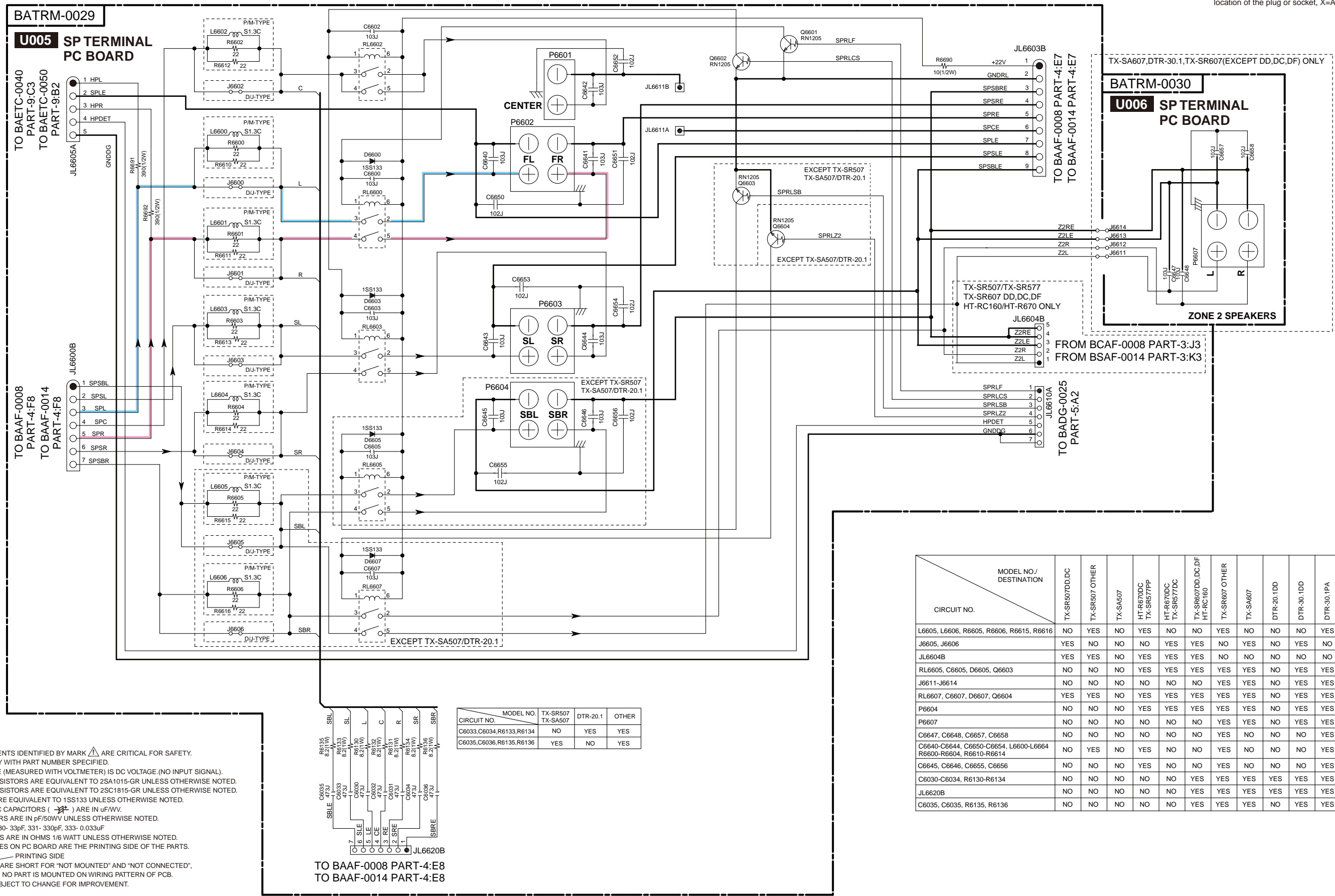

- NOTE**
- THE COMPONENTS IDENTIFIED BY MARK Δ ARE CRITICAL FOR SAFETY. REPLACE ONLY WITH PART NUMBER SPECIFIED.
 - BOLD VOLTAGE (MEASURED WITH VOLTMETER) IS DC VOLTAGE (NO INPUT SIGNAL).
 - ALL PNP TRANSISTORS ARE EQUIVALENT TO 2SA1015-GR UNLESS OTHERWISE NOTED.
 - ALL NPN TRANSISTORS ARE EQUIVALENT TO 2SC1815-GR UNLESS OTHERWISE NOTED.
 - ALL DIODES ARE EQUIVALENT TO 1SS133 UNLESS OTHERWISE NOTED.
 - ELECTROLYTIC CAPACITORS (---) ARE IN $\mu\text{F/WV}$.
 - ALL CAPACITORS ARE IN pF/50WV UNLESS OTHERWISE NOTED.
EX) 030-3pF, 330-33pF, 331-330pF, 333-0.033 μF
 - ALL RESISTORS ARE IN OHMS 1/6 WATT UNLESS OTHERWISE NOTED.
 - THE THICK LINES ON PC BOARD ARE THE PRINTING SIDE OF THE PARTS.
EX) --- PRINTING SIDE
 - "NM" AND "NC" ARE SHORT FOR "NOT MOUNTED" AND "NOT CONNECTED", WHICH MEANS NO PART IS MOUNTED ON WIRING PATTERN OF PCB.
 - CIRCUIT IS SUBJECT TO CHANGE FOR IMPROVEMENT.

CIRCUIT NO.	MODEL NO. TX-SR507 TX-SA507	DTR-20.1	OTHER
C6033,C6034,R6133,R6134	NO	YES	YES
C6035,C6036,R6135,R6136	YES	NO	YES

CIRCUIT NO.	MODEL NO. / DESTINATION		TX-SR507 DD,DC	TX-SR507 OTHER	TX-SA507	HT-R670DC TX-SR577PP	HT-R670DC TX-SR577DC	TX-SR607 DD,DC,DF HT-RC160	TX-SR607 OTHER	TX-SA607	DTR-20.1DD	DTR-30.1DD	DTR-30.1PA
	TX-SR507 DD,DC	TX-SR507 OTHER											
L6605, L6606, R6605, R6606, R6615, R6616	NO	YES	NO	YES	NO	NO	NO	NO	YES	NO	NO	NO	YES
J6605, J6606	YES	NO	NO	NO	NO	YES	YES	NO	YES	NO	NO	YES	NO
JL6604B	YES	YES	NO	YES	YES	YES	YES	NO	NO	NO	NO	NO	NO
RL6605, C6605, D6605, Q6603	NO	NO	NO	YES	YES	YES	YES	YES	YES	NO	NO	YES	YES
J6611-J6614	NO	NO	NO	NO	NO	NO	NO	NO	YES	YES	NO	YES	YES
RL6607, C6607, D6607, Q6604	YES	YES	NO	YES	YES	YES	YES	YES	YES	NO	YES	YES	YES
P6604	NO	NO	NO	YES	YES	YES	YES	YES	YES	NO	YES	YES	YES
P6607	NO	NO	NO	NO	NO	NO	NO	NO	YES	NO	NO	YES	YES
C6647, C6648, C6657, C6658	NO	NO	NO	NO	NO	NO	NO	NO	YES	NO	NO	NO	YES
C6640-C6644, C6650-C6654, L6600-L6664 R6600-R6604, R6610-R6614	NO	YES	NO	YES	NO	NO	NO	NO	YES	NO	NO	NO	YES
C6645, C6646, C6655, C6656	NO	NO	NO	YES	NO	NO	NO	NO	YES	NO	NO	NO	YES
C6030-C6034, R6130-R6134	NO	NO	NO	NO	NO	NO	YES	YES	YES	YES	YES	YES	YES
JL6620B	NO	NO	NO	NO	NO	NO	NO	YES	YES	YES	YES	YES	YES
C6035, C6036, R6135, R6136	NO	NO	NO	NO	NO	NO	NO	YES	YES	YES	NO	YES	YES

SCHEMATIC DIAGRAMS-6 / PART-8
U PORT AND VLSC SECTION

NOTE:
XY in "SCHEMATIC-a / PART-b:XY" indicates the target location of the plug or socket, X=A to E/H/K, Y=1 to 4/5/8.

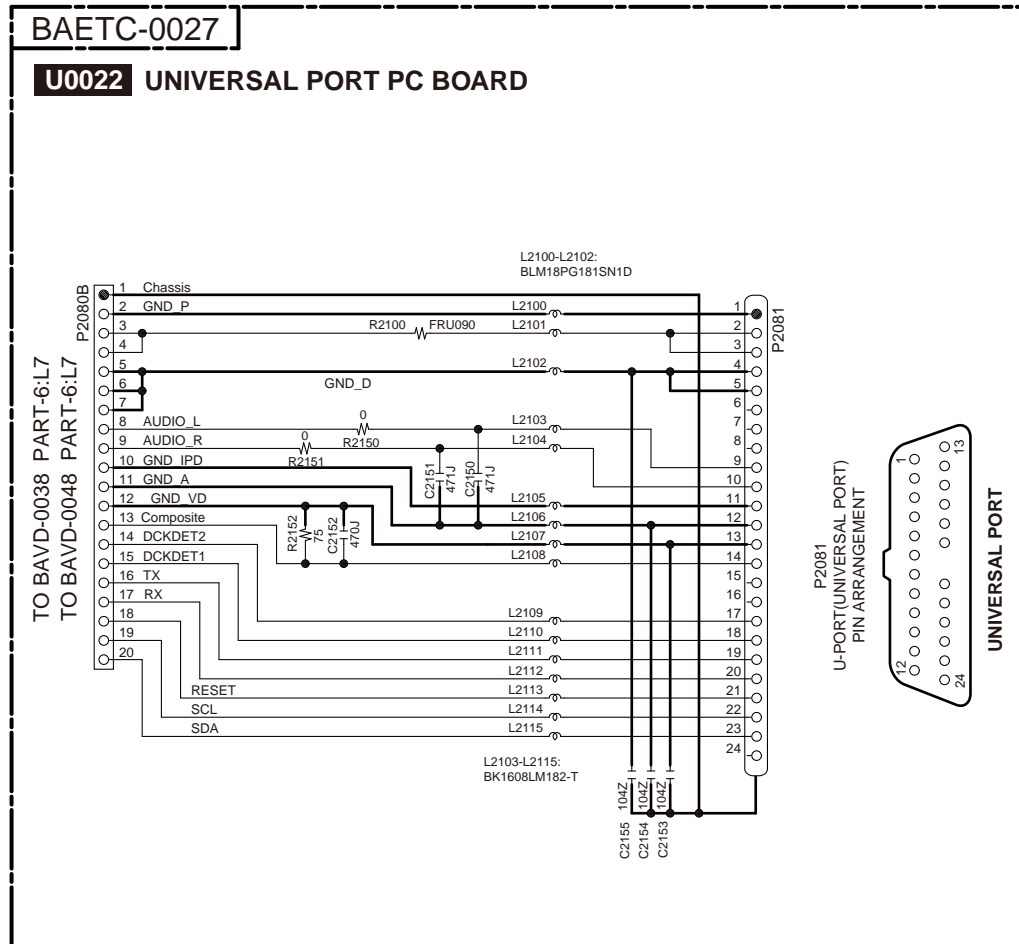

- NOTE**
- THE COMPONENTS IDENTIFIED BY MARK ARE CRITICAL FOR SAFETY. REPLACE ONLY WITH PART NUMBER SPECIFIED.
 - BOLD VOLTAGE (MEASURED WITH VOLTMETER) IS DC VOLTAGE.(NO INPUT SIGNAL).
 - ALL PNP TRANSISTORS ARE EQUIVALENT TO 2SA1015-GR UNLESS OTHERWISE NOTED.
 - ALL NPN TRANSISTORS ARE EQUIVALENT TO 2SC1815-GR UNLESS OTHERWISE NOTED.
 - ALL DIODES ARE EQUIVALENT TO 1SS133 UNLESS OTHERWISE NOTED.
 - ELECTROLYTIC CAPACITORS () ARE IN uF/MV.
 - ALL CAPACITORS ARE IN pF/50V/VV UNLESS OTHERWISE NOTED.
EX) 030- 3pF, 330- 33pF, 331- 330pF, 333- 0.033uF
 - ALL RESISTORS ARE IN OHMS 1/6 WATT UNLESS OTHERWISE NOTED.
 - THE THICK LINES ON PC BOARD ARE THE PRINTING SIDE OF THE PARTS.
EX) PRINTING SIDE
 - "NM" AND "NC" ARE SHORT FOR "NOT MOUNTED" AND "NOT CONNECTED", WHICH MEANS NO PART IS MOUNTED ON WIRING PATTERN OF PCB.
 - CIRCUIT IS SUBJECT TO CHANGE FOR IMPROVEMENT.

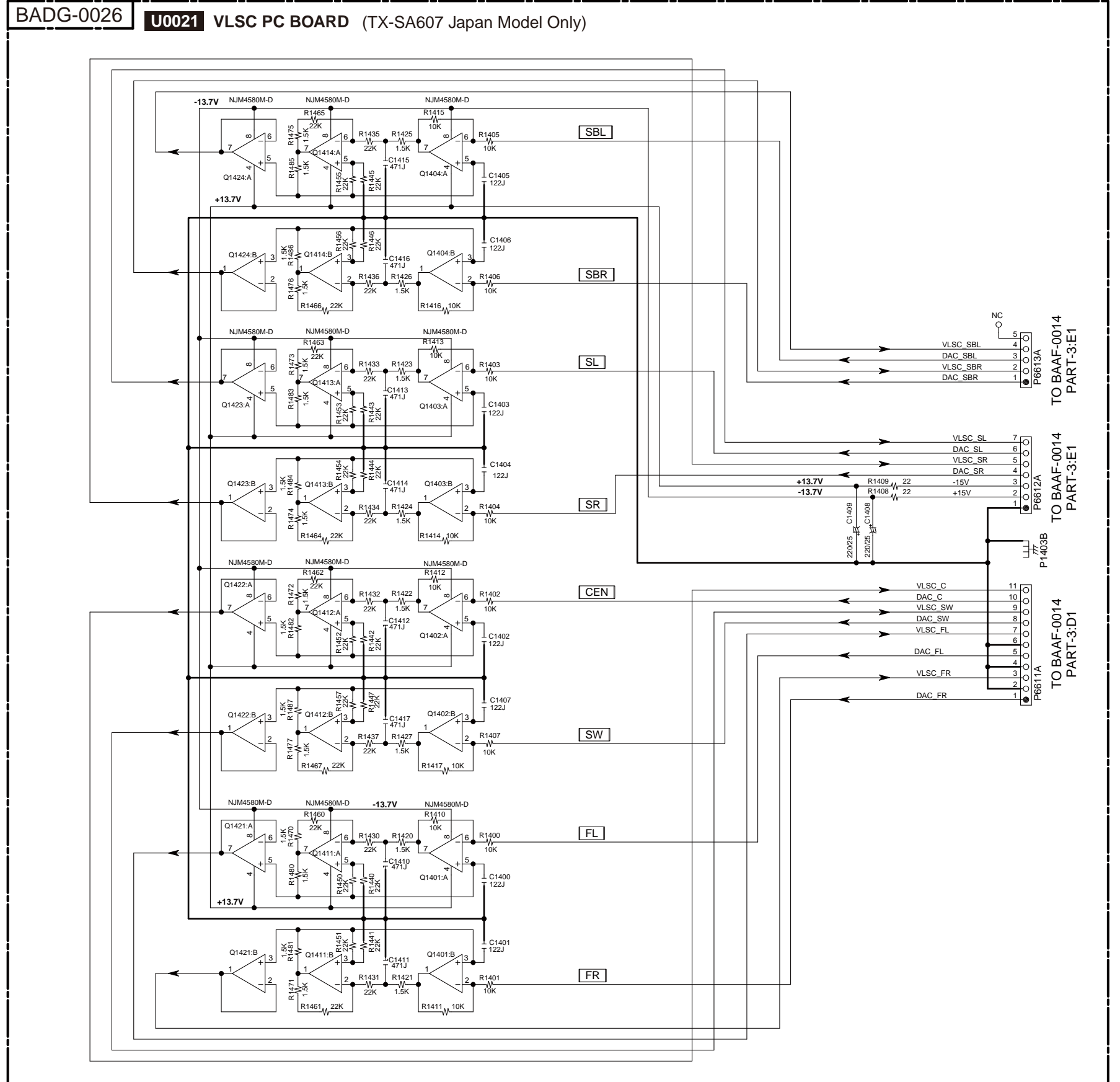

SCHEMATIC DIAGRAMS-7 / PART-9
DISPLAY SECTION

NOTE:
PART-10 is not used for TX-SR507/TX-SA507/TX-SR577.

NOTE:
XY in "SCHEMATIC-a / PART-b:XY" indicates the target
location of the plug or socket, X=A to E/H/K, Y=1 to 4/5/8.

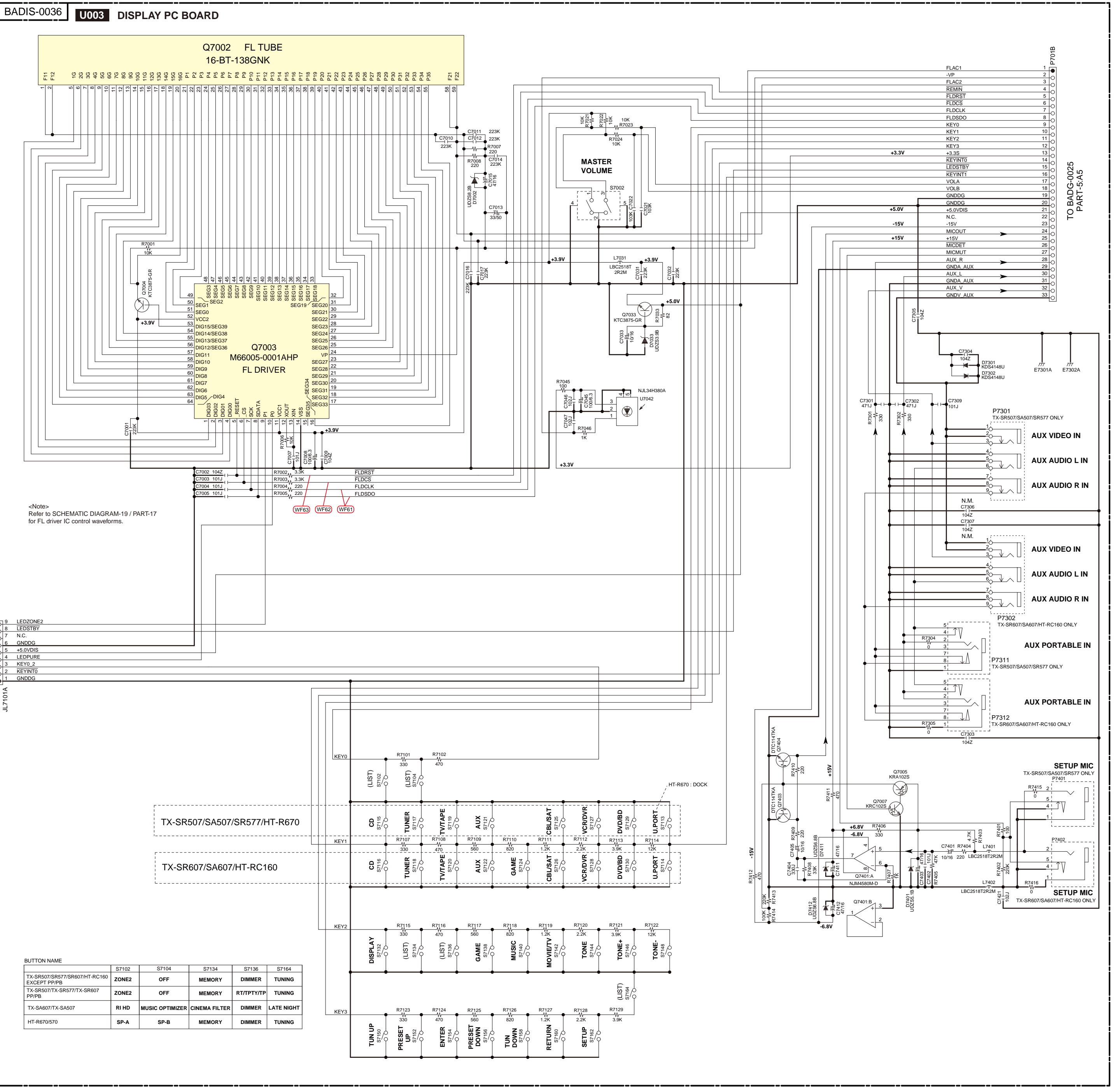
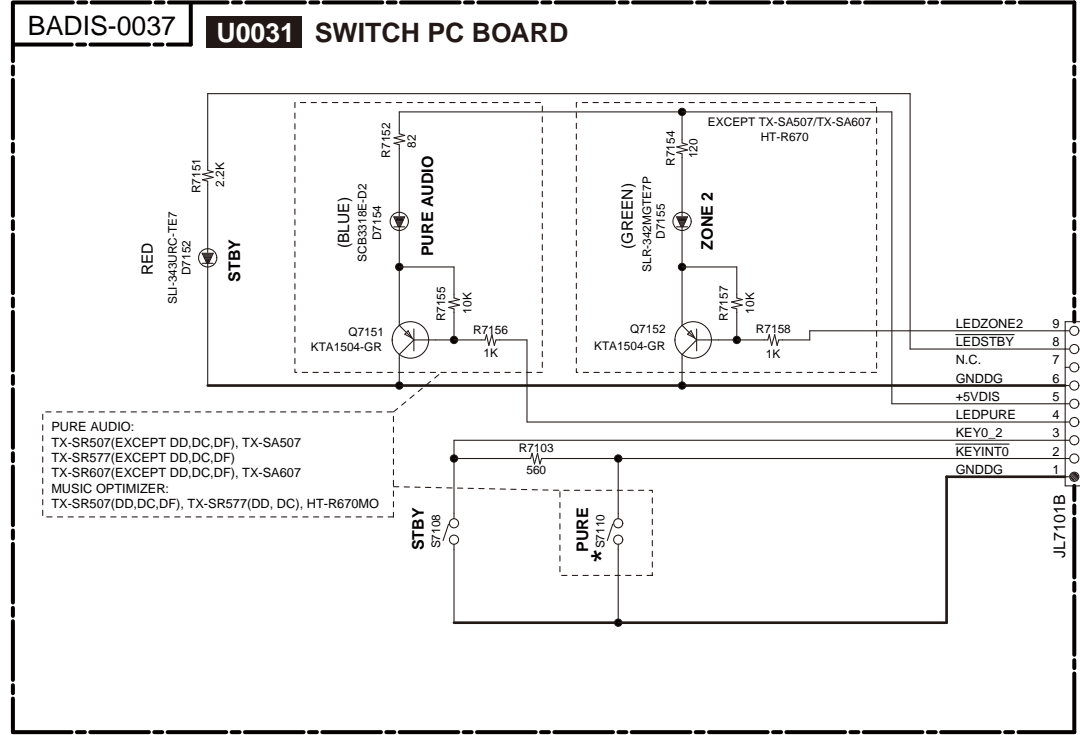
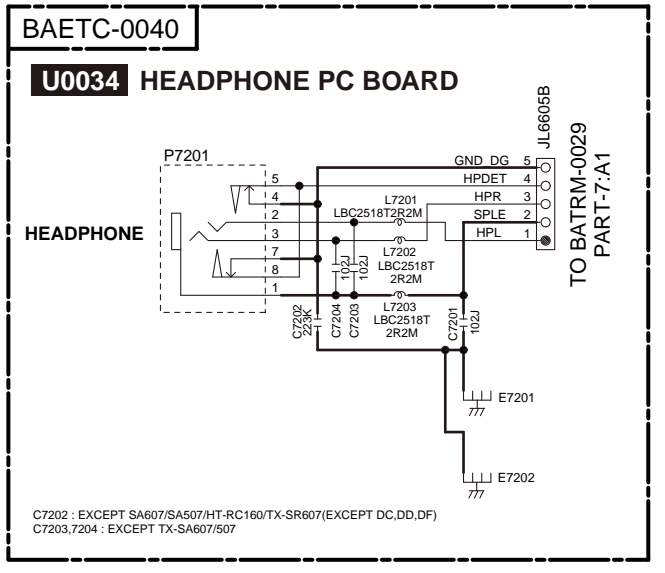

<Note>
Refer to SCHEMATIC DIAGRAM-19 / PART-17
for FL driver IC control waveforms.

BUTTON NAME

Model	S7102	S7104	S7134	S7136	S7164
TX-SR507/SR577/SR607/HT-RC160 EXCEPT PTP/B	ZONE2	OFF	MEMORY	DIMMER	TUNING
TX-SR507/TX-SR577/TX-SR607 PTP/B	ZONE2	OFF	MEMORY	R/T/TPT/TP	TUNING
TX-SA607/TX-SA507	RI HD	MUSIC OPTIMIZER	CINEMA FILTER	DIMMER	LATE NIGHT
HT-R670/570	SP-A	SP-B	MEMORY	DIMMER	TUNING

NOTE

- THE COMPONENTS IDENTIFIED BY MARK ARE CRITICAL FOR SAFETY. REPLACE ONLY WITH PART NUMBER SPECIFIED.
- BOLD VOLTAGE (MEASURED WITH VOLTMETER) IS DC VOLTAGE (NO INPUT SIGNAL).
- ALL PNP TRANSISTORS ARE EQUIVALENT TO 2SA1015-GR UNLESS OTHERWISE NOTED.
- ALL NPN TRANSISTORS ARE EQUIVALENT TO 2SC1815-GR UNLESS OTHERWISE NOTED.
- ALL DIODES ARE EQUIVALENT TO 1S5133 UNLESS OTHERWISE NOTED.
- ELECTROLYTIC CAPACITORS () ARE IN μ F/WV.
- ALL CAPACITORS ARE IN pF/50V UNLESS OTHERWISE NOTED.
- EX) 003: 3pF, 330-33kF, 331-330kF, 333-0.033uF
- ALL RESISTORS ARE IN OHMS 1/8 WATT UNLESS OTHERWISE NOTED.
- THE THICK LINES ON PC BOARD ARE THE PRINTING SIDE OF THE PARTS.
- EX) PRINTING SIDE
- "NM" AND "NC" ARE SHORT FOR "NOT MOUNTED" AND "NOT CONNECTED", WHICH MEANS NO PART IS MOUNTED OR WIRING PATTERN OF PCB.
- CIRCUIT IS SUBJECT TO CHANGE FOR IMPROVEMENT.

A

B

C

D

E

SCHEMATIC DIAGRAMS-8 / PART-10
FRONT HDMI SECTION

NOTE:
XY in "SCHEMATIC-a / PART-b:XY" indicates the target location of the plug or socket, X=A to E/H/K, Y=1 to 4/5/8.

BAHDM-0064 TX-SR607/TX-SA607/DTR-30.1 ONLY

U0041 FRONT HDMI PC BOARD

1
2
3
4

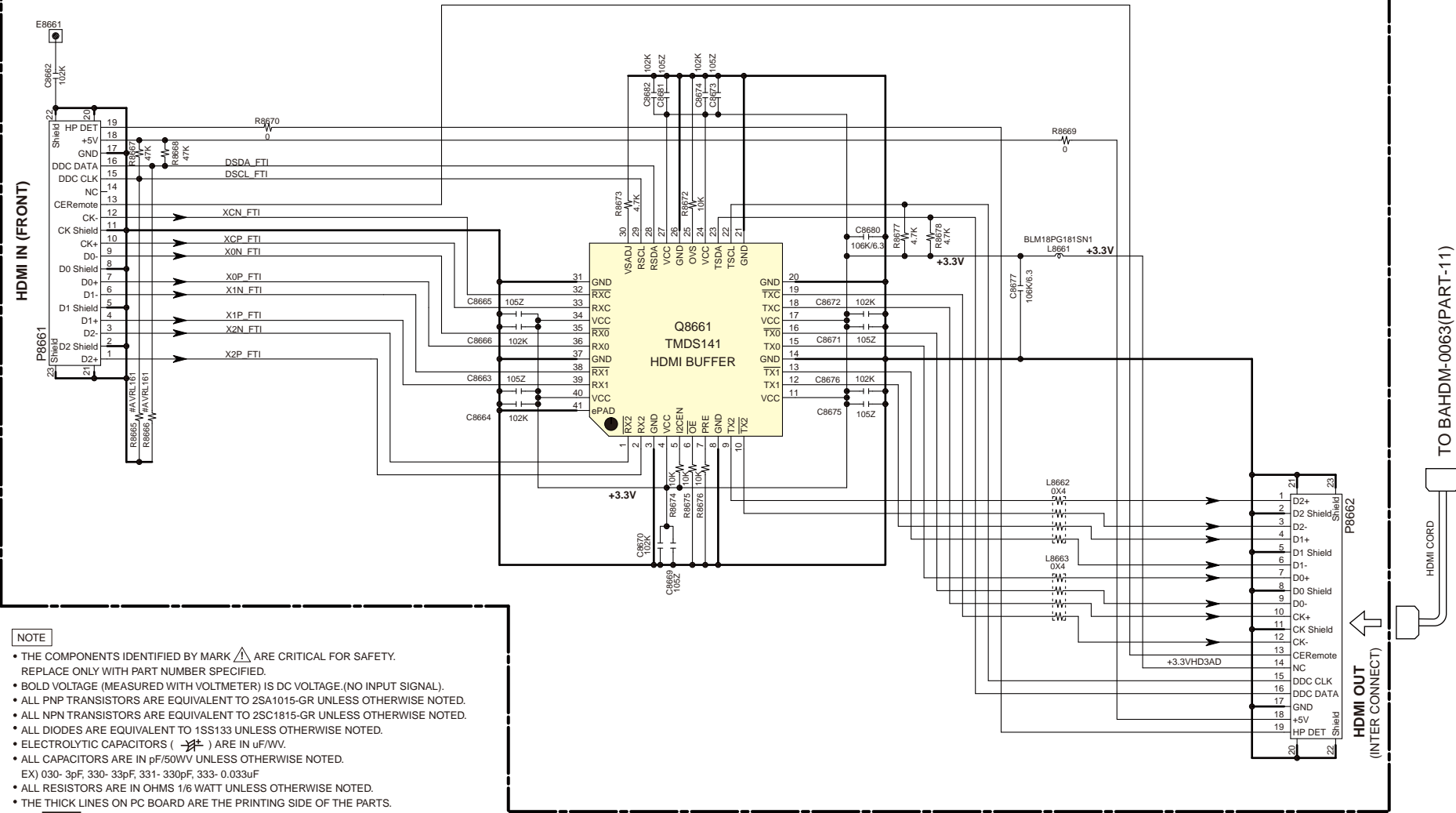

- NOTE**
- THE COMPONENTS IDENTIFIED BY MARK ARE CRITICAL FOR SAFETY. REPLACE ONLY WITH PART NUMBER SPECIFIED.
 - BOLD VOLTAGE (MEASURED WITH VOLTMETER) IS DC VOLTAGE.(NO INPUT SIGNAL).
 - ALL PNP TRANSISTORS ARE EQUIVALENT TO 2SA1015-GR UNLESS OTHERWISE NOTED.
 - ALL NPN TRANSISTORS ARE EQUIVALENT TO 2SC1815-GR UNLESS OTHERWISE NOTED.
 - ALL DIODES ARE EQUIVALENT TO 1SS133 UNLESS OTHERWISE NOTED.
 - ELECTROLYTIC CAPACITORS () ARE IN uF/WV.
 - ALL CAPACITORS ARE IN pF/50VWV UNLESS OTHERWISE NOTED.
EX) 030- 3pF, 330- 33pF, 331- 330pF, 333- 0.033uF
 - ALL RESISTORS ARE IN OHMS 1/6 WATT UNLESS OTHERWISE NOTED.
 - THE THICK LINES ON PC BOARD ARE THE PRINTING SIDE OF THE PARTS.
EX) PRINTING SIDE
 - "NM" AND "NC" ARE SHORT FOR "NOT MOUNTED" AND "NOT CONNECTED", WHICH MEANS NO PART IS MOUNTED ON WIRING PATTERN OF PCB.
 - CIRCUIT IS SUBJECT TO CHANGE FOR IMPROVEMENT.

TO BAHDM-0063(PART-11)



SCHEMATIC DIAGRAMS-9 / PART-11
HDMI SECTION

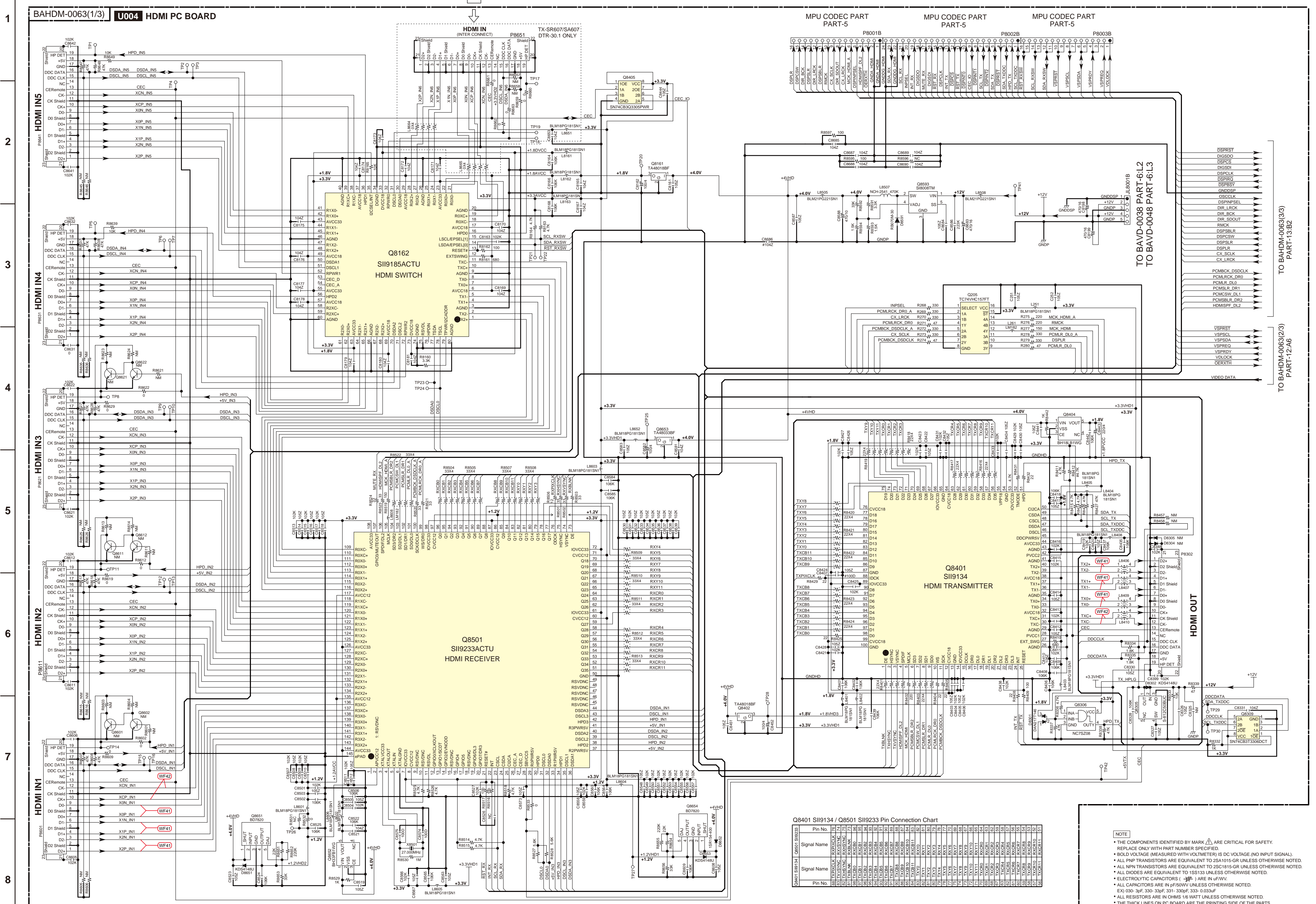

1
2
3
4
5
6
7
8

NOTE:
XY in "SCHEMATIC-a / PART-b:XY" indicates the target location of the plug or socket, X=a to E/H/K, Y=1 to 4/5/8.

<Note>
Refer to SCHEMATIC DIAGRAM-19 / PART-17 for HDMI signal waveforms.

Q8401 SI1934 / Q8501 SI1923 Pin Connection Chart

Pin No.	Signal Name	Pin No.	Signal Name
1	HPD	41	R1X0
2	HPD	42	R1X1
3	HPD	43	R1X2
4	HPD	44	R1X3
5	HPD	45	R1X4
6	HPD	46	R1X5
7	HPD	47	R1X6
8	HPD	48	R1X7
9	HPD	49	R1X8
10	HPD	50	R1X9
11	HPD	51	R1X10
12	HPD	52	R1X11
13	HPD	53	R1X12
14	HPD	54	R1X13
15	HPD	55	R1X14
16	HPD	56	R1X15
17	HPD	57	R1X16
18	HPD	58	R1X17
19	HPD	59	R1X18
20	HPD	60	R1X19

- NOTE**
- THE COMPONENTS IDENTIFIED BY MARK **▲** ARE CRITICAL FOR SAFETY. REPLACE ONLY WITH PART NUMBER SPECIFIED.
 - BOLD VOLTAGE (MEASURED WITH VOLTMETER) IS DC VOLTAGE (NO INPUT SIGNAL).
 - ALL PNIP TRANSISTORS ARE EQUIVALENT TO 2SA1015-GR UNLESS OTHERWISE NOTED.
 - ALL NPN TRANSISTORS ARE EQUIVALENT TO 2SC1815-GR UNLESS OTHERWISE NOTED.
 - ALL DIODES ARE EQUIVALENT TO 1S5133 UNLESS OTHERWISE NOTED.
 - ELECTROLYTIC CAPACITORS (**⇩**) ARE IN uF/μV.
 - ALL CAPACITORS ARE IN pF/500V UNLESS OTHERWISE NOTED.
 - EX) 100-20p, 30p, 30pF, 33p, 330pF, 333-0.033pF.
 - ALL RESISTORS ARE IN OHMS (Ω) UNLESS OTHERWISE NOTED.
 - THE THICK LINES ON PCB BOARD ARE THE PRINTING SIDE OF THE PARTS.
 - EX) **○ ○ ○ ○** PRINTING SIDE
 - *NM AND *NC ARE SHORT FOR "NOT MOUNTED" AND "NOT CONNECTED", WHICH MEANS NO PART IS MOUNTED ON WIRING PATTERN OF PCB.
 - CIRCUIT IS SUBJECT TO CHANGE FOR IMPROVEMENT.

SCHEMATIC DIAGRAMS-10 / PART-12
VIDEO SIGNAL PROCESSOR SECTION

NOTE:
XY in "SCHEMATIC-a / PART-b:XY" indicates the target location of the plug or socket, X=A to E/H/K, Y=1 to 4/5/8.

BAHDM-0063(2/3) TX-SR607/TX-SA607/DTR-30.1 ONLY

U004 HDMI PC BOARD

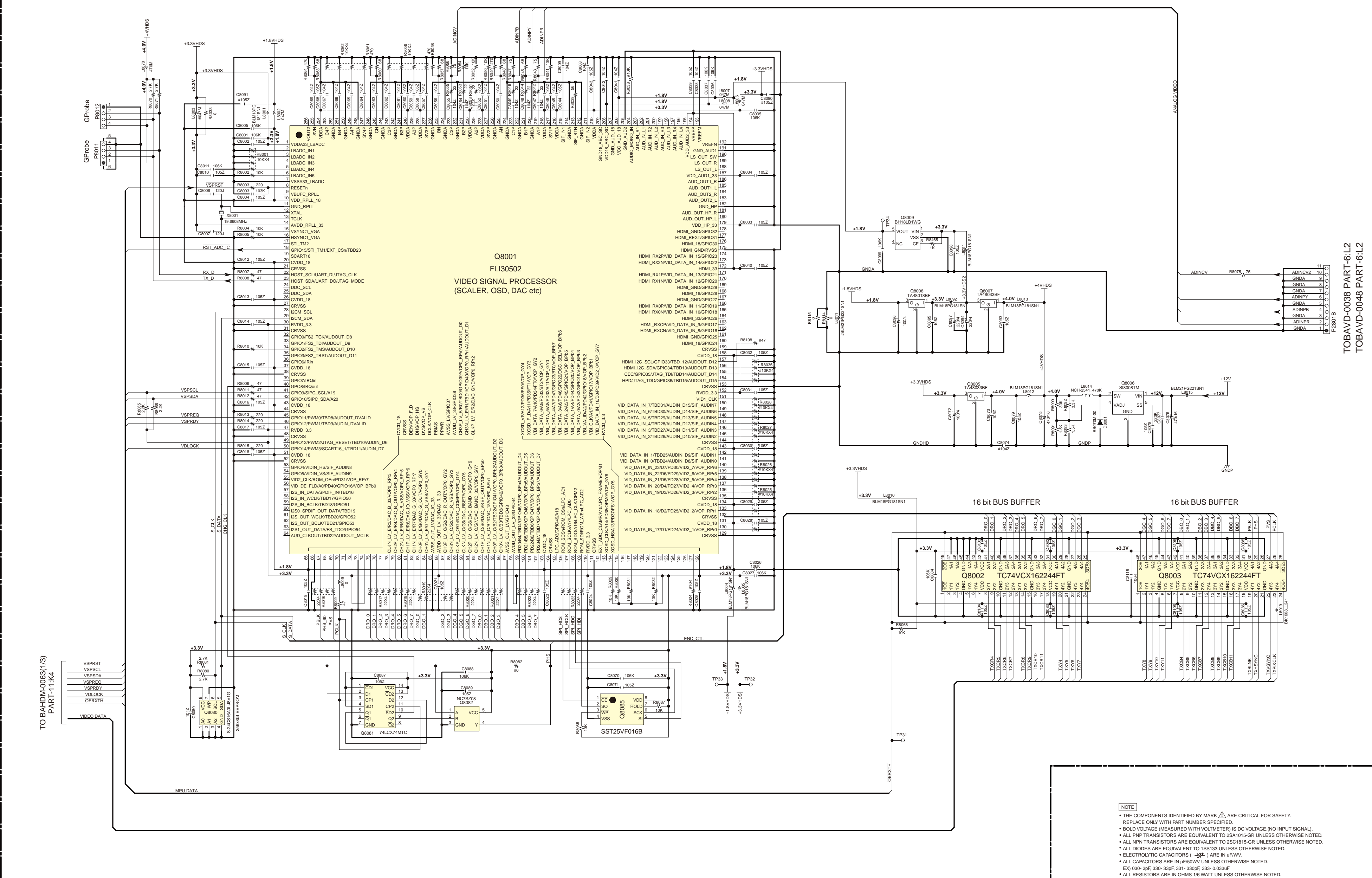

- NOTE
- THE COMPONENTS IDENTIFIED BY MARK ARE CRITICAL FOR SAFETY. REPLACE ONLY WITH PART NUMBER SPECIFIED.
 - BOLD VOLTAGE (MEASURED WITH VOLTMETER) IS DC VOLTAGE (NO INPUT SIGNAL).
 - ALL PNP TRANSISTORS ARE EQUIVALENT TO 2SA1015-OR UNLESS OTHERWISE NOTED.
 - ALL NPN TRANSISTORS ARE EQUIVALENT TO 2SC1815-GR UNLESS OTHERWISE NOTED.
 - ALL DIODES ARE EQUIVALENT TO 1SS133 UNLESS OTHERWISE NOTED.
 - ELECTROLYTIC CAPACITORS ARE IN uF/WV.
 - ALL CAPACITORS ARE IN pF/50V UNLESS OTHERWISE NOTED.
 - EX1 030-3pF, 33p-33pF, 331-330pF, 333-0.033uF.
 - ALL RESISTORS ARE IN OHMS 1/6 WATT UNLESS OTHERWISE NOTED.
 - THE THICK LINES ON PC BOARD ARE THE PRINTING SIDE OF THE PARTS.
 - PRINTING SIDE
 - *M AND *C ARE SHORT FOR "NOT MOUNTED" AND "NOT CONNECTED", WHICH MEANS NO PART IS MOUNTED ON WRITING PATTERN OF PCB.
 - CIRCUIT IS SUBJECT TO CHANGE FOR IMPROVEMENT.

TOBAVD-0038 PART-6L2
TOBAVD-0048 PART-6L2

SCHEMATIC DIAGRAMS-11 / PART-13
DSP SECTION

NOTE:
XY in "SCHEMATIC-a / PART-b:XY" indicates the target location of the plug or socket, X=A to E/H/K, Y=1 to 4/5/8.

1
2
3
4
5

BAHDM-0063(3/3) TX-SR607/TX-SA607/DTR-30.1 ONLY

U004 HDMI PC BOARD

TO BAHDM-0063(1/3)
PART-11:K3

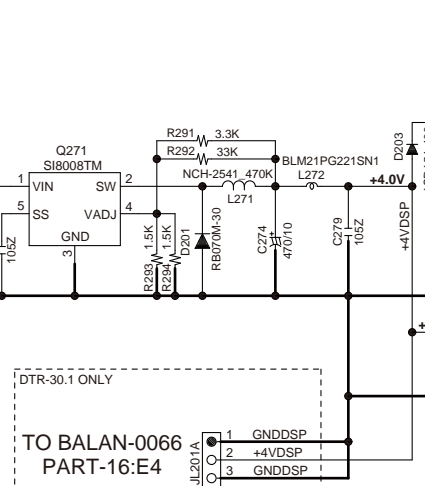
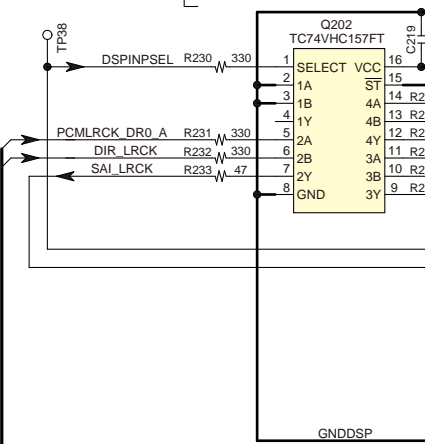
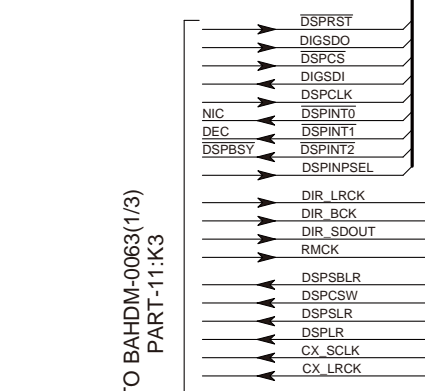

DTR-30.1 ONLY
TO BALAN-0066 PART-16:E4

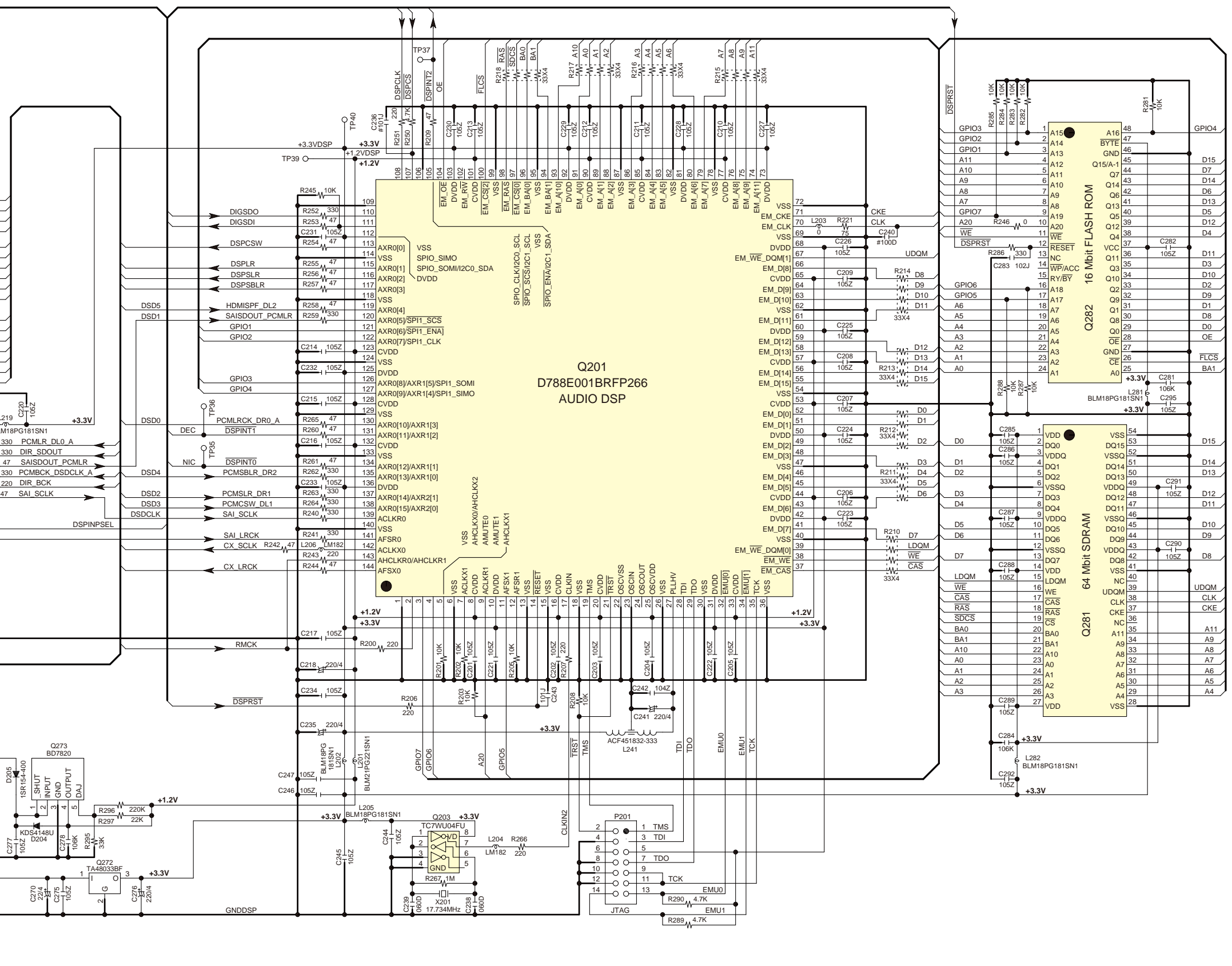

ES29LV160ET-70TG or S29AL016D70TFI010
K4S641632K-UC60 or K4S641632N-LC60 or EM638165TS-7G

SCHEMATIC DIAGRAMS-12 / PART-14
POWER AMP SECTION-2

NOTE:
PART-15 is used only for TX-SA607.
PART-16 and PART-17 are not used for TX-SR607/TX-SA607.

NOTE:
XY in "SCHEMATIC-a / PART-b.XY" indicates the target location of the plug or socket, X=A to E/H/K, Y=1 to 4/5/8.

- NOTE**
- THE COMPONENTS IDENTIFIED BY MARK Δ ARE CRITICAL FOR SAFETY. REPLACE ONLY WITH PART NUMBER SPECIFIED.
 - BOLD VOLTAGE (MEASURED WITH VOLTMETER) IS DC VOLTAGE (NO INPUT SIGNAL).
 - ALL PNP TRANSISTORS ARE EQUIVALENT TO 2SA1015-GR UNLESS OTHERWISE NOTED.
 - ALL NPN TRANSISTORS ARE EQUIVALENT TO 2SC1815-GR UNLESS OTHERWISE NOTED.
 - ALL DIODES ARE EQUIVALENT TO 1SS133 UNLESS OTHERWISE NOTED.
 - ELECTROLYTIC CAPACITORS (---) ARE IN μF UNLESS OTHERWISE NOTED.
 - ALL CAPACITORS ARE IN pF UNLESS OTHERWISE NOTED.
 - EX) 030-3pF, 330-33pF, 331-330pF, 333-0.033uF
 - ALL RESISTORS ARE IN OHMS Ω UNLESS OTHERWISE NOTED.
 - ALL DIODES ARE EQUIVALENT TO 1SS133 UNLESS OTHERWISE NOTED.
 - EX) \square \square \square PRINTING SIDE
 - "NM" AND "NC" ARE SHORT FOR "NOT MOUNTED" AND "NOT CONNECTED", WHICH MEANS NO PART IS MOUNTED ON WIRING PATTERN OF PCB.
 - CIRCUIT IS SUBJECT TO CHANGE FOR IMPROVEMENT.

IDLING CURRENT ADJUSTMENT

1. Wait for 4 - 6 minutes after power on. (Heat running)
2. Re-adjust the trimming resistors according to the following values.

Channel	Adjustment point	Measured value	Re-adjustment value
Front Left, Right and Center	R6040, R6041 and R6042	In case below 9 mV	→ 9 mV
		In case 9 - 11 mV	→ No re-adjustment
		In case over 11 mV	→ 11 mV
Surround Left	R6043, R6044	In case below 4 mV	→ 4 mV
Surround Right		In case 4 - 6 mV	→ No re-adjustment
Surround Back Left		In case over 6 mV	→ 6 mV

BACLA-0020

U006 POWER AMP PC BOARD (DRIVER AMP STAGE)

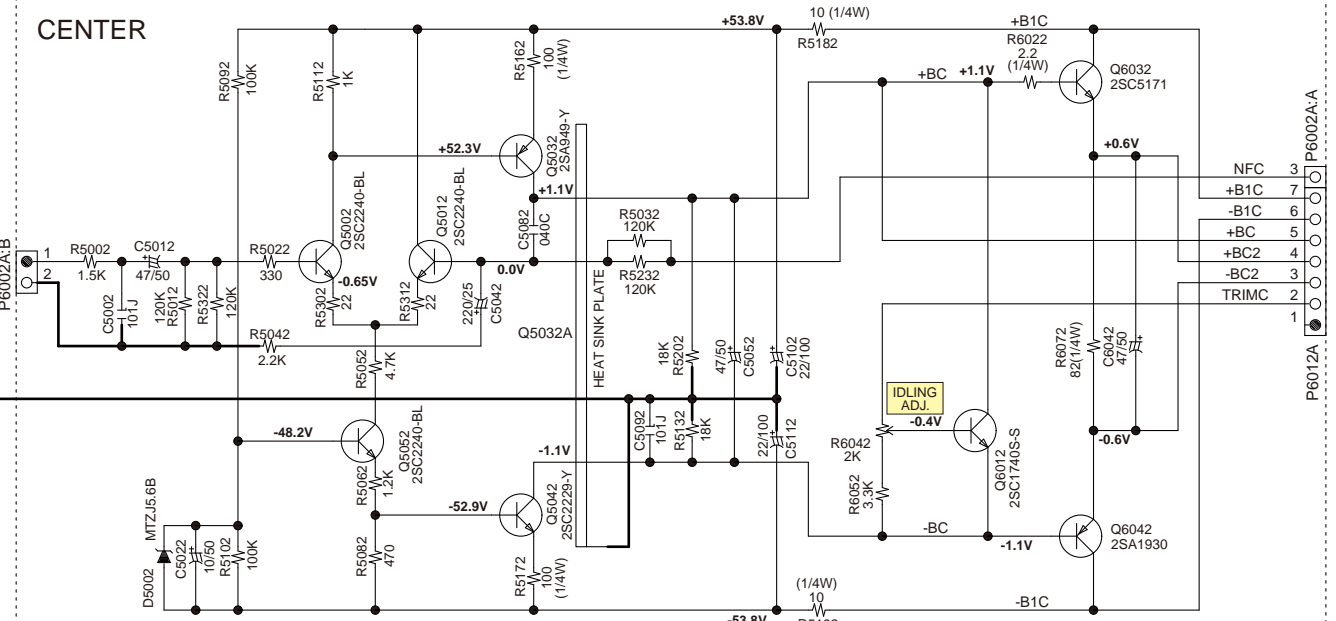
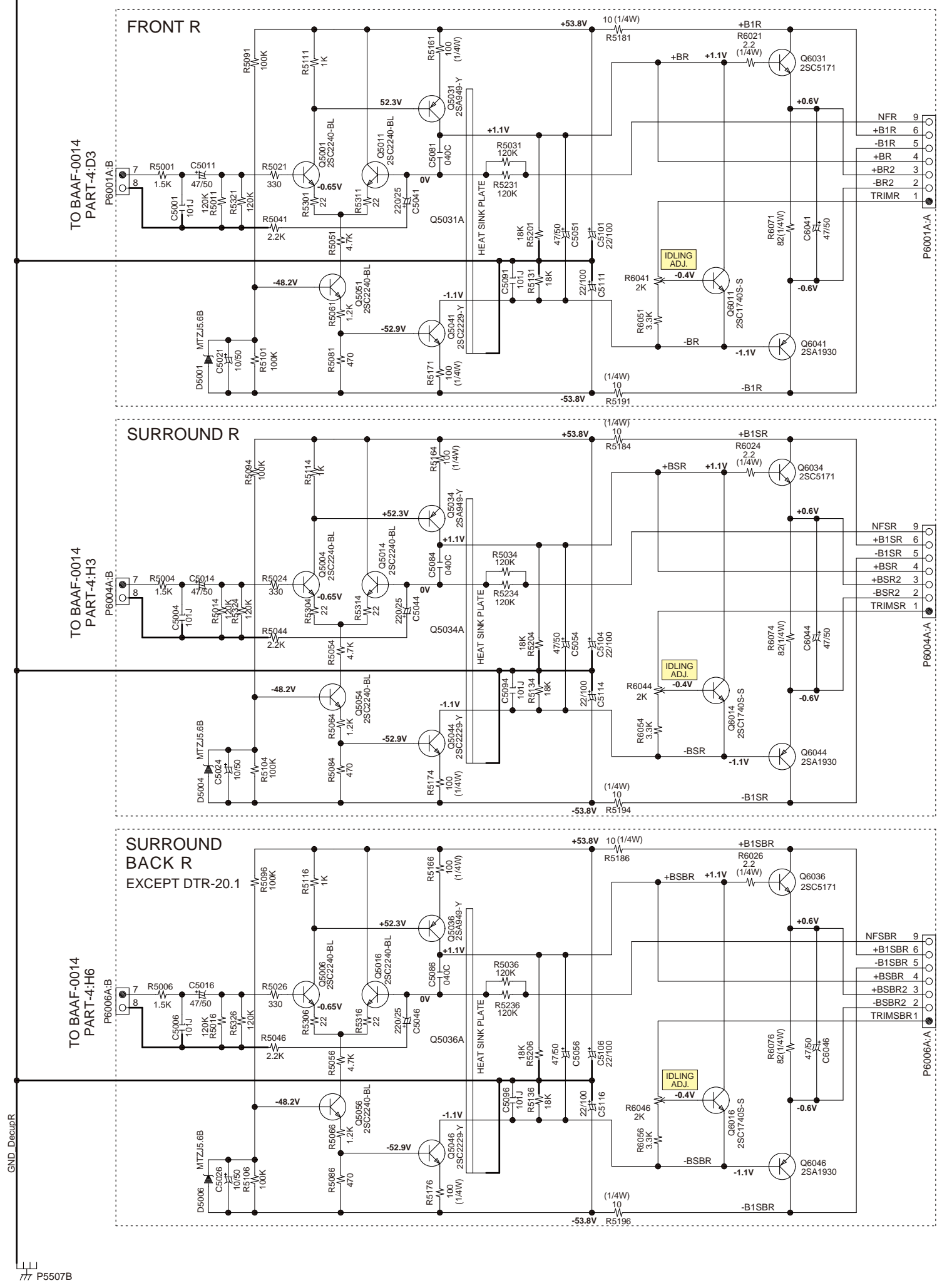
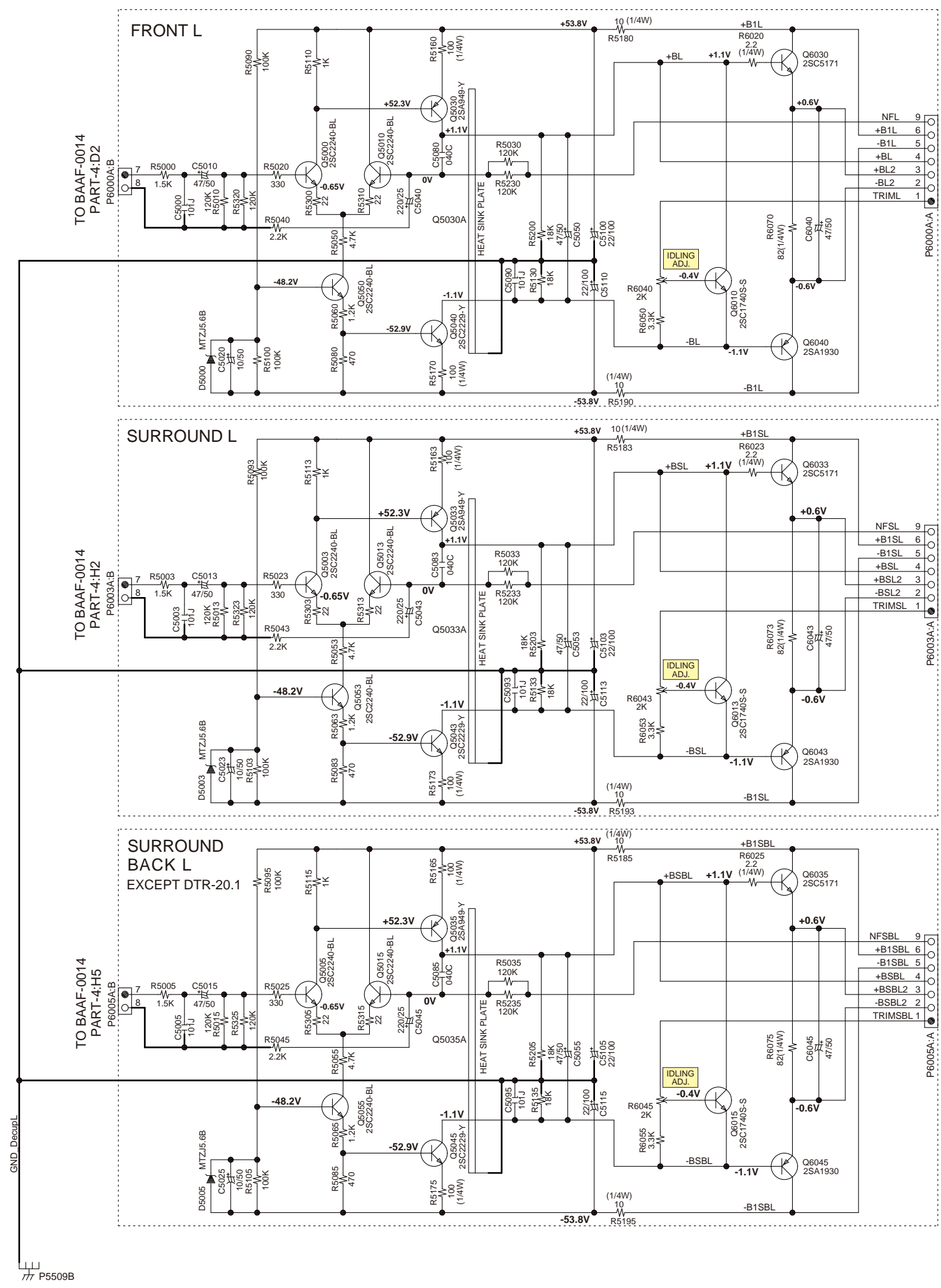

GND Decoupl
P5509B

GND Decoupl
P5507B

TO BAAF-0014 PART-4D5

TO BAAF-0014 PART-4D3

TO BAAF-0014 PART-4H3

TO BAAF-0014 PART-4H6

TO BAAF-0014 PART-4D2

TO BAAF-0014 PART-4H2

TO BAAF-0014 PART-4H5

A **B** **C** **D** **E**

SCHEMATIC DIAGRAMS-16 / PART-18
PWOER SUPPLY SECTION

NOTE:
SCHEMATIC-12/PART-14 is not used for TX-SR507/TX-SA507/TX-SR577.
SCHEMATIC-13/PART-15 is used only for TX-SA607/TX-SA507.
SCHEMATIC-14/PART-16 and SCHEMATIC-15/PART-17 are not used for TX-SR607/TX-SA607/TX-SR507/TX-SA507/TX-SR577.

NOTE:
XY in "SCHEMATIC-a / PART-b:XY" indicates the target location of the plug or socket, X=A to E/H/K, Y=1 to 4/5/8.

NOTE

- THE COMPONENTS IDENTIFIED BY MARK ARE CRITICAL FOR SAFETY. REPLACE ONLY WITH PART NUMBER SPECIFIED.
- VOLTAGE (MEASURED WITH VOLTMETER) IS DC VOLTAGE.(NO INPUT SIGNAL).
- ELECTROLYTIC CAPACITORS () ARE IN uF/MV.
- ALL CAPACITORS ARE IN pF/50WV UNLESS OTHERWISE NOTED.
EX) 030- 3pF 330- 33pF 331- 330pF 333- 0.033uF
- CIRCUIT IS SUBJECT TO CHANGE FOR IMPROVEMENT.

CAUTION



FOR CONTINUED PROTECTION AGAINST FIRE HAZARD, REPLACE ONLY WITH FUSE OF SAME TYPE AND RATING INDICATED.



ATTENTION
AFIN D'ASSURER UNE PROTECTION PERMANENTE CONTRE LES RISQUES D'INCENDIE, REMPLACER UNIQUEMENT PAR UN FUSIBLE DE MEME TYPE ET CALIBRATION COMME INDIQUE.

BAETC-0041

U0035 INLET PC BOARD



POWER SUPPLY

TYPE	VOLTAGE/FREQ.
DD DC DF	120V / 60HZ
PR PB PA MO MR MQ	230-240V / 50HZ
JJ	100V / 50/60HZ

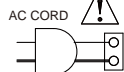

T902

TYPE	TX-SR507, TX-SR577 TX-SA507, HT-R670	TX-SA507 TX-SA607
DD DC DF	NPT-1520JQ	---
PP PB PA MO MR MQ	NPT-1520GQ	---
JJ	---	NPT-1520JQ

T901

TYPE	TX-SR507, TX-SR577 TX-SA507, HT-R670	TX-SR607 TX-SA607	HT-R160
DD DC DF	NPT-1516D	NPT-1552D	10A 125V
PA MO MR MQ	NPT-1516DQ	NPT-1552DQ	---
PB PP	NPT-1516P	NPT-1552P	---
JJ	NPT-1516J	NPT-1552J	---



THIS SYMBOL LOCATED NEAR THE FUSE INDICATES THAT THE FUSE USED IS SLOW OPERATING TYPE FOR CONTINUED PROTECTION AGAINST FIRE FUSE HAZARD,REPLACE WITH SAME TYPE FUSE. FOR FUSE RATING REFER TO THE MAKING ADJACENT TO THE SYMBOL.



CE SYMBOLE INDIQUE QUE LE FUSIBLE UTILISE EST A LENT, E POUR UNE PROTECTION PERMANENTE.N'UTILISER QUE DES FUSIBLES DE MEME TYPE. CE DARNIER EST INDIQUE LA QU LE PRESENT SYMBOLE EST APPOSE.

BAPS-0039

U0033 POWER SUPPLY PC BOARD

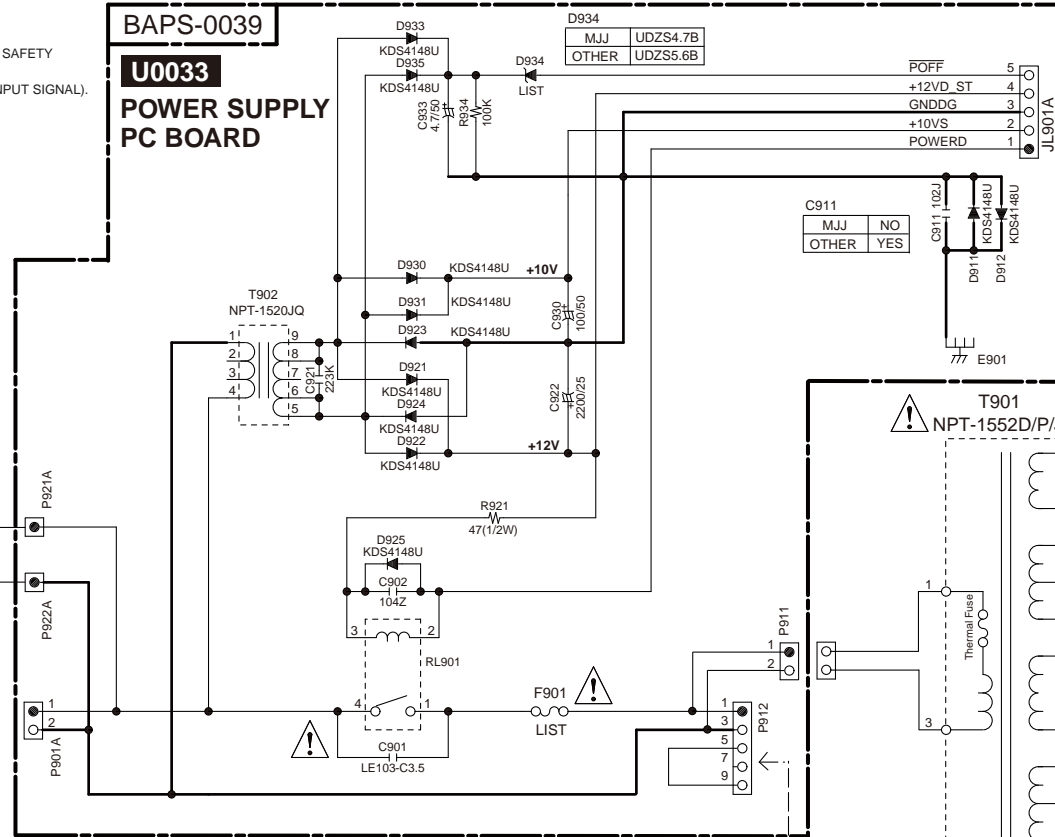

F901

TYPE	TX-SR507, TX-SR577 HT-R670	TX-SR607	TX-SA507	TX-SA607	HT-R160
DD DC DF	8A 125V	10A 125V	---	---	10A 125V
PP PB PA MO MR MQ	T4AL250V	T5AL250V	---	---	---
JJ	---	---	10A 125V	12A 125V	---

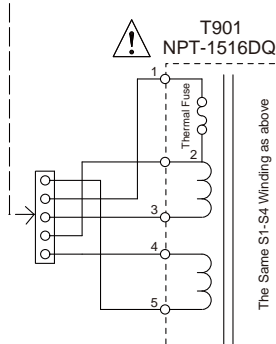

TO BADG-0025
PART-5:A2

	PWB	R951	F910
TXSR607/SA607/HT-RC160	BAPS-0016	NO	YES
TX-SR507/SA507/SR577	BAPS-0009	YES	NO

BAPS-0016

U0012 TRANS 2ND TERMINAL PC BOARD

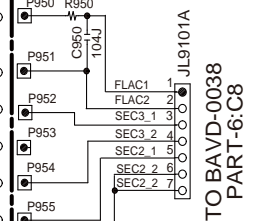

BAPS-0015

U0011 TRANS 2ND TERMINAL PC BOARD

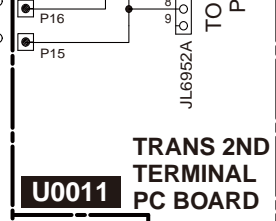

PWB

TX-SR607/TX-SA607	BAPS-0015
TX-SR507/SA507/SR577	BAPS-0010

1

2

3

4

SCHEMATIC DIAGRAMS-17 / PART-19
WAVEFORM SECTION

1

Digital Audio Waveform Part

NOTE:

1. (WF01) is short for (Waveform01)
2. Refer to SCHEMATIC DIAGRAM-3 / PART-5 for the location of each waveform in the circuit.
3. XY in "PART-b:XY" indicates each measurement point location, X=A to E/H/K, Y=1 to 4/5/8.

LR CLOCK (SAI_LRCK, CX_LRCK)
Fs=48kHz : DVD, Clock width=20.8us
Fs=44.1kHz : CD, Clock width=22.7us

BIT CLOCK (SAI_SLCK, CX_SLCK)
64Fs=3072kHz : DVD, Clock width=325ns
64Fs=2822.4kHz : CD, Clock width=354ns

(WF01) OPT1 (PART-5:C7)

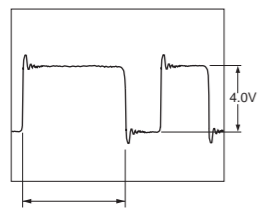

Duty varies according to audio data

(WF02) COAX1 (PART-5:B6,C7)

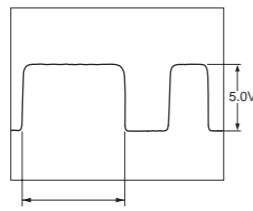

Duty always varies according to audio data

(WF03) SAI_SDOUT (PART-5:D7)

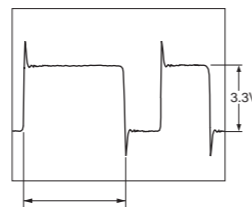

Duty varies according to audio data

(WF04) SAI_LRCK (PART-5:D7)

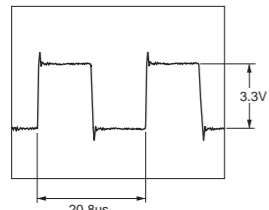

(WF05) SAI_SLCK (PART-5:D7)

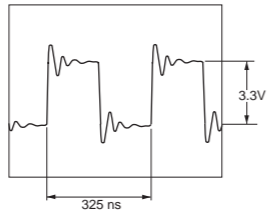

(WF06) DSPLR (PART-5:D7)

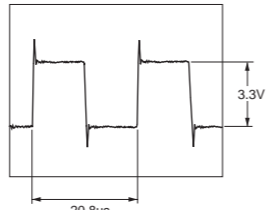

20.8us
Front L/R audio data

(WF07) CX_LRCK (PART-5:D8)

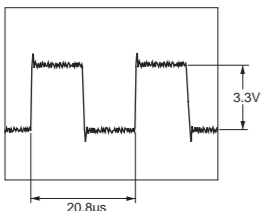

(WF08) CX_SCLK (PART-5:D8)

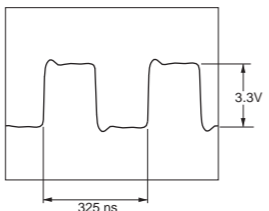

(WF09) FL+ (PART-5:F7)

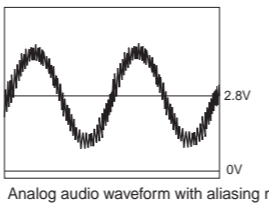

2.8V
0V
Analog audio waveform with aliasing noise

(WF10) DAC_FL (PART-5:G7)

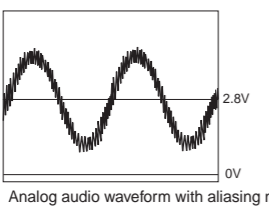

2.8V
0V
Analog audio waveform with aliasing noise

(WF10) DAC_FL (PART-5:G7)

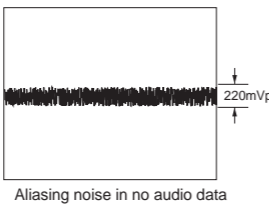

220mVp-p
Aliasing noise in no audio data

2

3

4

5

Video source color and pattern

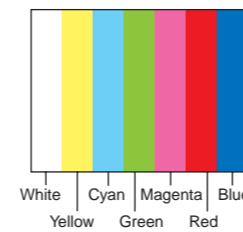

Composite waveform
(WF21) PART-6:B7

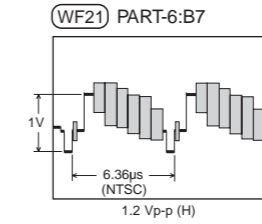

S-Video Y waveform
(WF22)

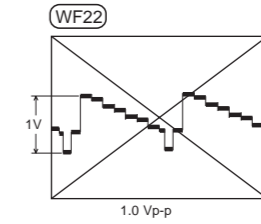

S-Video C waveform
(WF23)

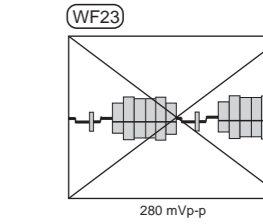

S-Video terminals are not installed for this model.

Component Y waveform
(WF24) PART-6:B4,B5

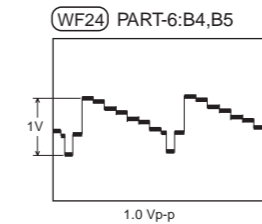

Component PB waveform
(WF25) PART-6:B4,B5

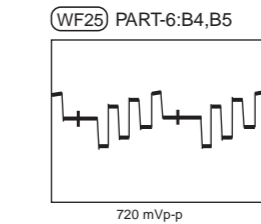

Component PR waveform
(WF26) PART-6:B4

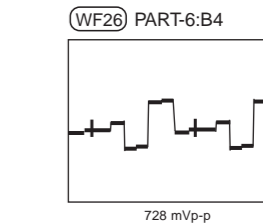

NOTE:

1. (WF21) is short for (Waveform21)
2. Refer to SCHEMATIC DIAGRAM-4/PART-6 for the location of each waveform on circuit.
3. XY in "PART-x:XY" indicates each socket's location, X=A to E/H/K, Y=1 to 4/5/8.
4. In the case that video outputs are not connected to video devices, video signal output levels are doubled.

HDMI Waveform Part

HDMI D0,D1,D2 waveform
(WF41) PART-11:B3, H4

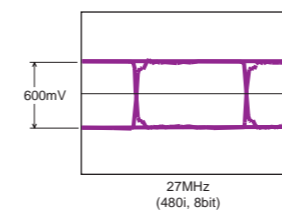
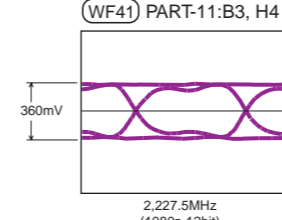

D0,D1,D2 Eye-pattern waveform, frequency and level vary according to video resolution, aspect and profile. Waveforms above are examples.

HDMI CK waveform
(WF42) PART-11:B3, H4

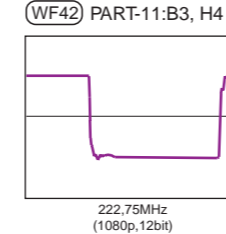

CK waveform, frequency and level differ according to video resolution, aspect and profile. D0,D1,D2 are just CK x10.

FL Driver IC Control Waveform Part

SCK/SDATA waveform
(WF61) PART-9:F4/D4

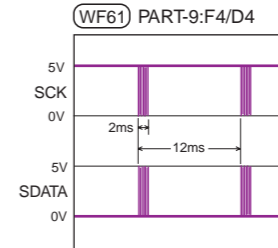

SCK/SDATA waveform
(WF61) PART-9:F4/D4

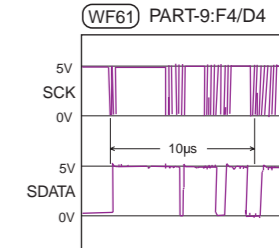

SDATA waveform varies according to the data content

SCK/CS waveform
(WF62) PART-9:F4/D4

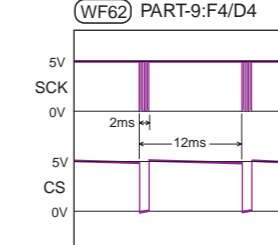

SCK/RESET waveform
(WF63) PART-9:F4/D4

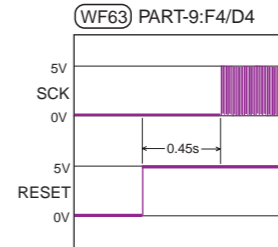

When power on

SCK/RESET waveform
(WF63) PART-9:F4/D4

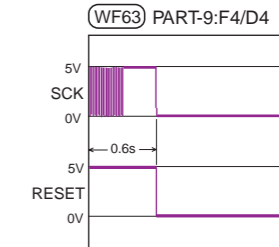

When power off

PRINTED CIRCUIT BOARD VIEWS-2 / U001

U001 INPUT SELECTOR / VOLUME / POWER AMP. PC BOARD
(BAAF-0014)

Component side

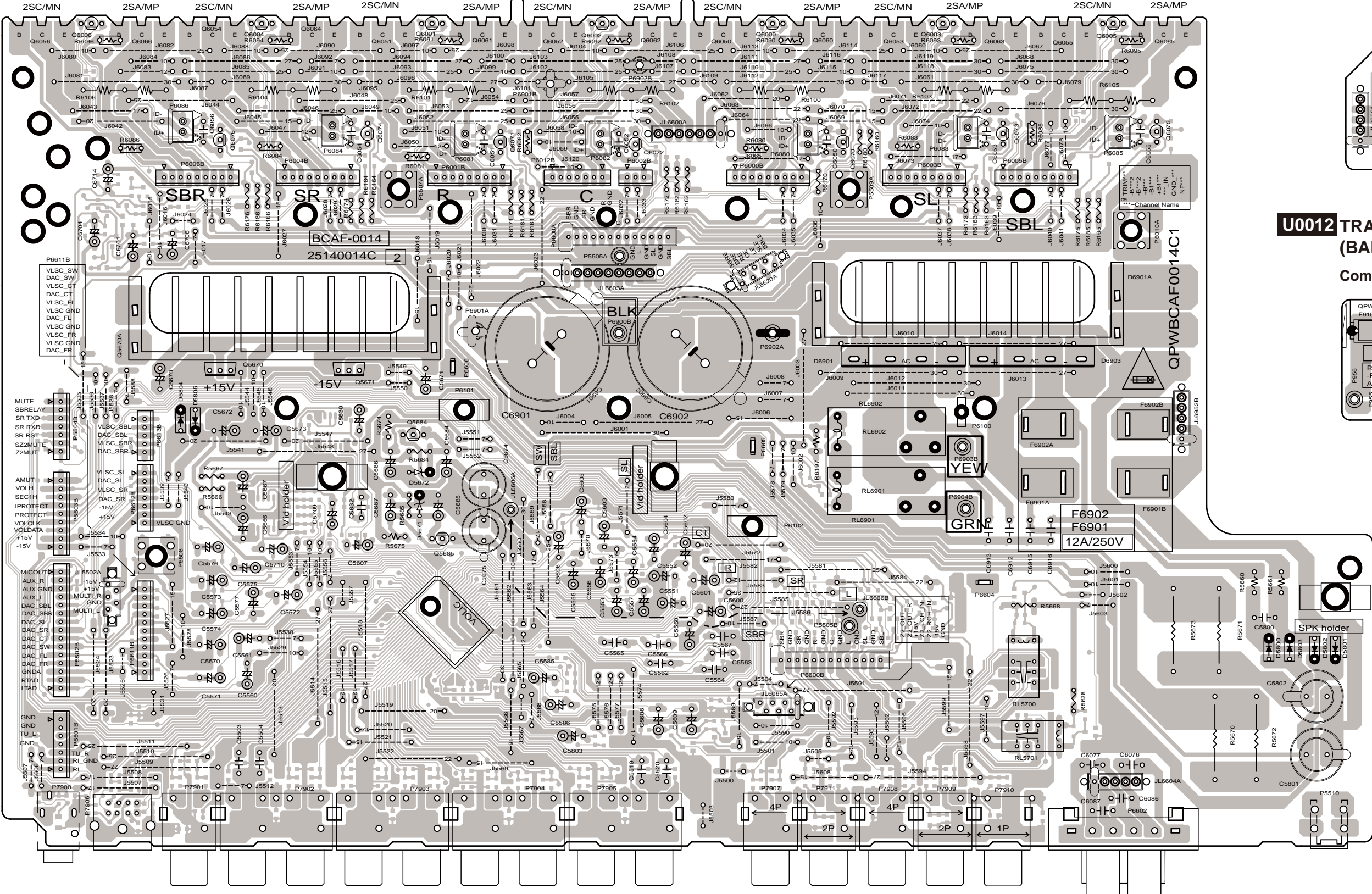

U0011 TRANS 2ND TERMINAL
(BAPS-0015)

Component side

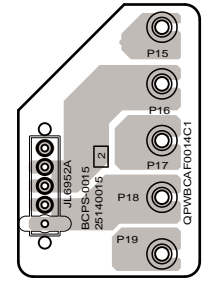

U0012 TRANS 2ND TERMINAL
(BAPS-0016)

Component side

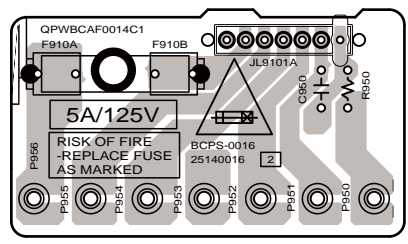

U0013 THERMAL SENSOR
(BAETC-0017)

Component side

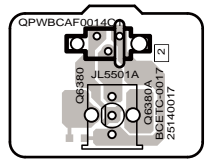

1

2

3

4

5

A B C D E F G H

PRINTED CIRCUIT BOARD VIEWS-3 / U001

U001 INPUT SELECTOR / VOLUME / POWER AMP. PC BOARD
(BAAF-0014)

Soldering side

U0017 THERMAL SENSOR
(BAETC-0017)

Soldering side

1

2

3

4

5

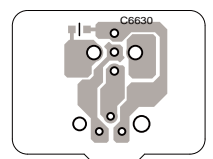
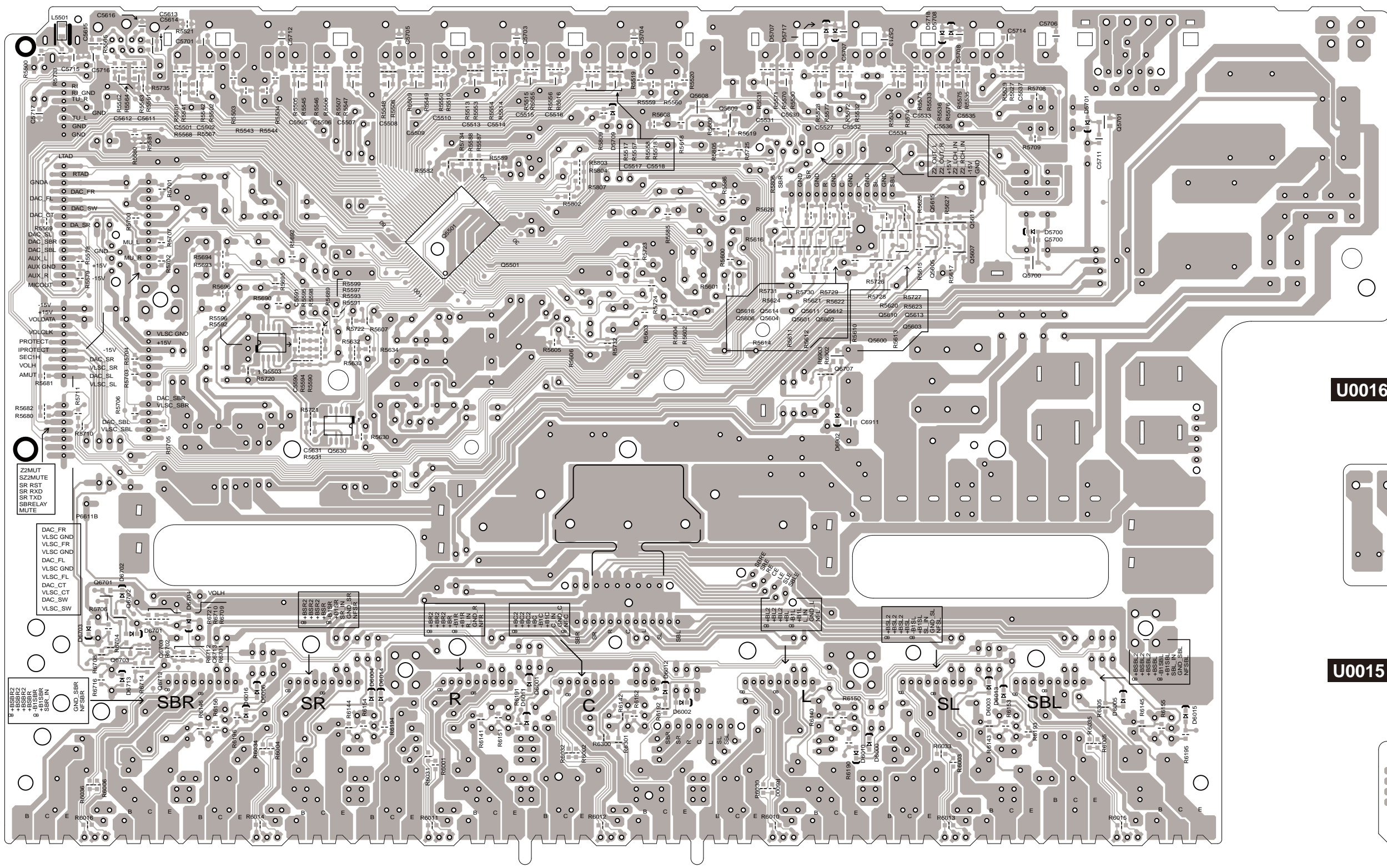

U0016 TRANS 2ND TERMINAL
(BAPS-0016)

Soldering side

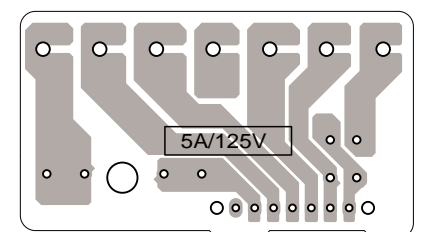

U0015 TRANS 2ND TERMINAL
(BAPS-0015)

Soldering side

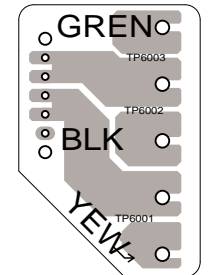

A B C D E F G H

PRINTED CIRCUIT BOARD VIEWS-5 / U002

U002 MPU / CODEC PC BOARD
(BADG-0025)

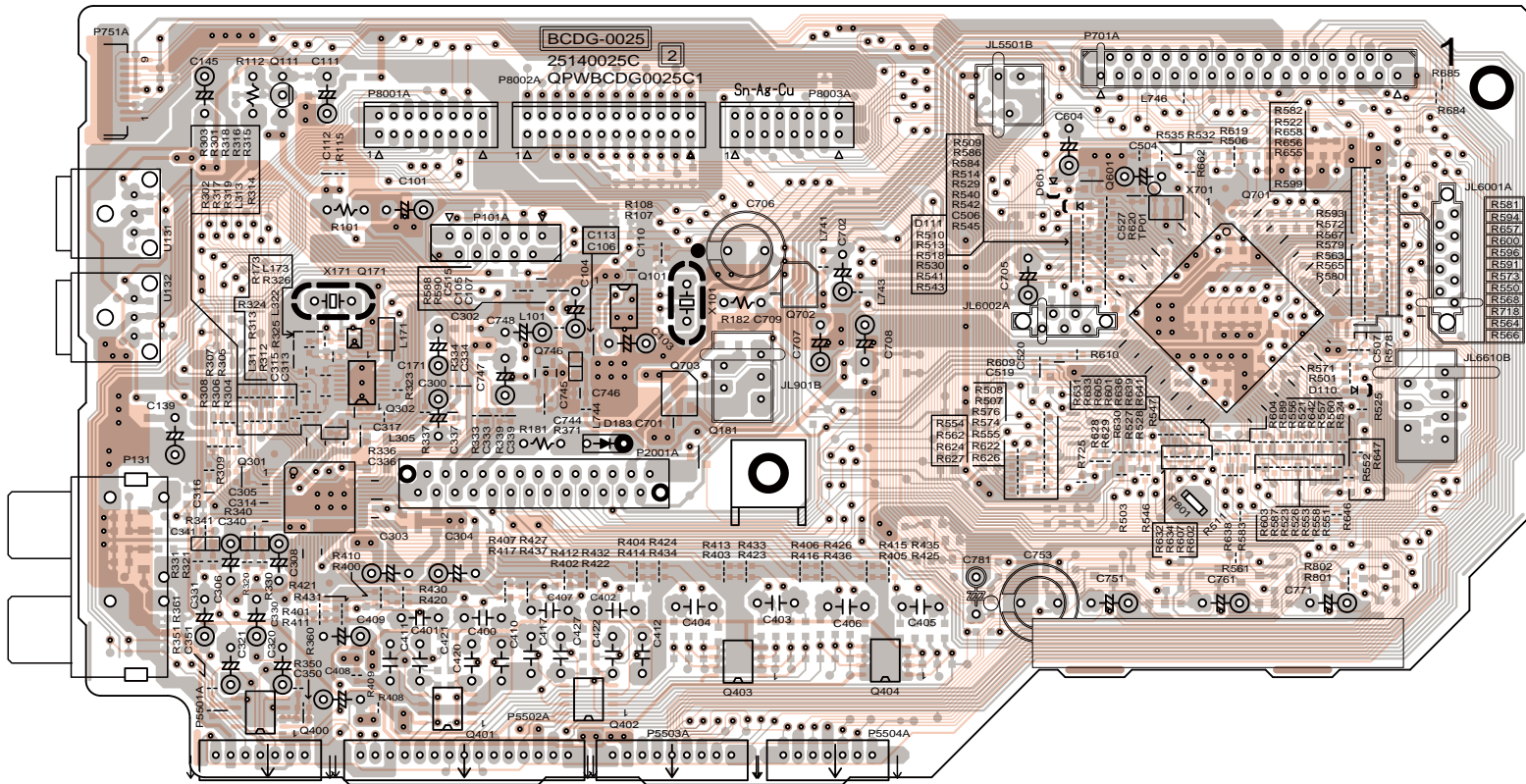

1

2

3

U002 MPU / CODEC PC BOARD
(BADG-0025)

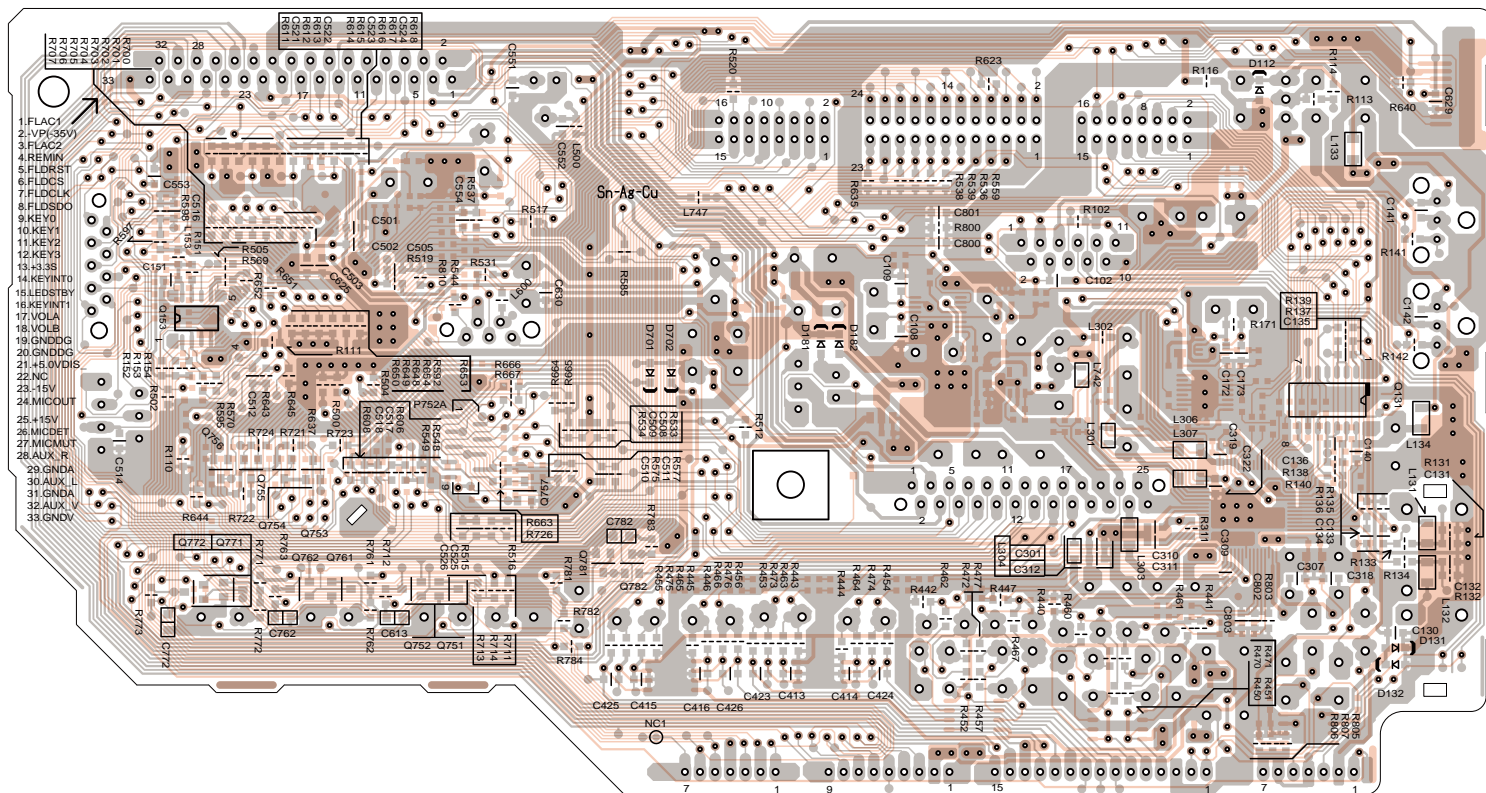

4

5

U0021 VLSC PC BOARD
(BADG-0026)
TX-SA607 only

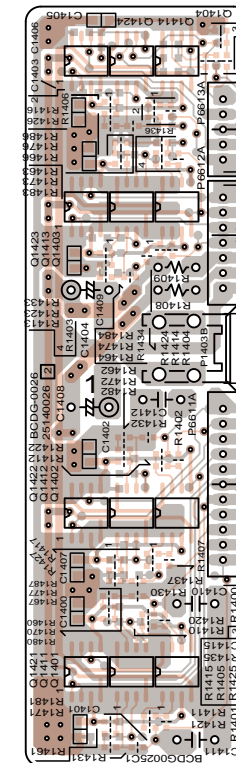

U0021 VLSC PC BOARD
(BADG-0026)
TX-SA607 only

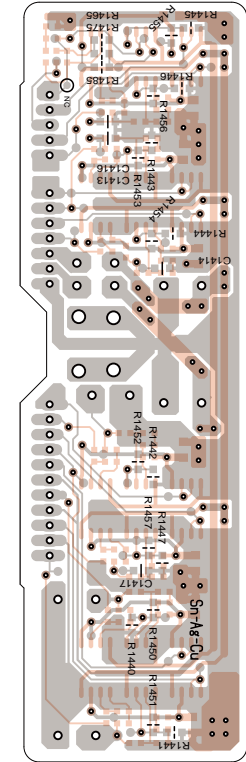

U0022 UNIVERSAL PORT PC BOARD
(BAETC-0027)

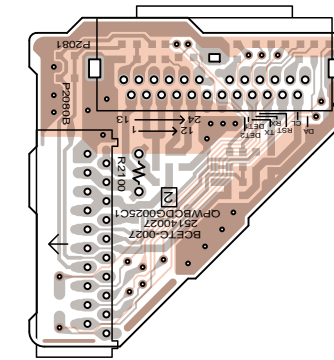

U0022 UNIVERSAL PORT PC BOARD
(BAETC-0027)

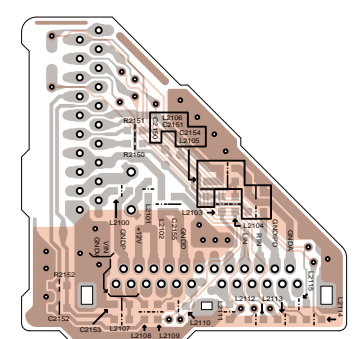

A B C D E F G H

PRINTED CIRCUIT BOARD VIEWS-7 / U003

U003 DISPLAY PC BOARD
(BADIS-0036)

Component side

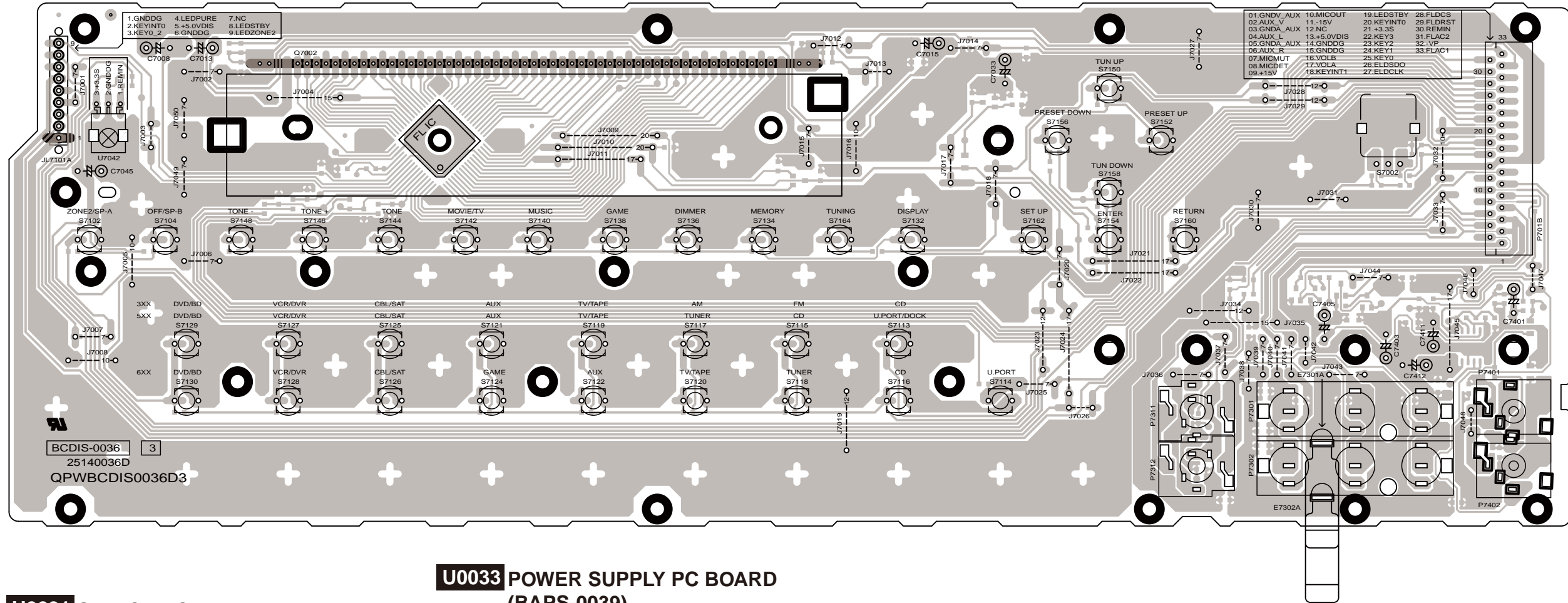

U0031 SWITCH PC BOARD
(BADIS-0037)

Component side

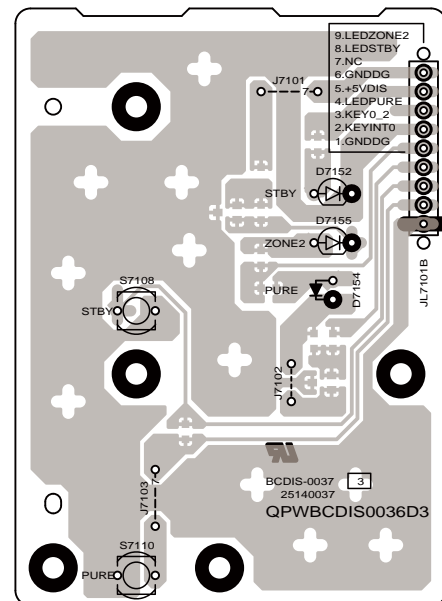

U0033 POWER SUPPLY PC BOARD
(BAPS-0039)

Component side

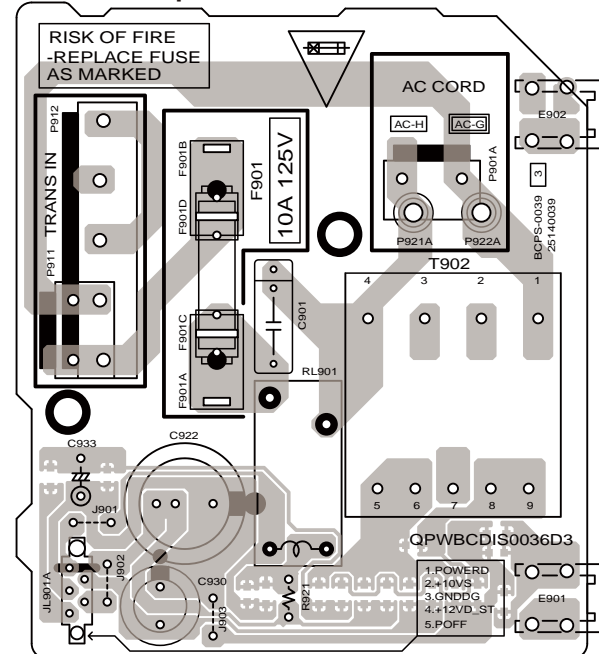

U0034 HEADPHONE PC BOARD
(BAETC-0040)

Component side

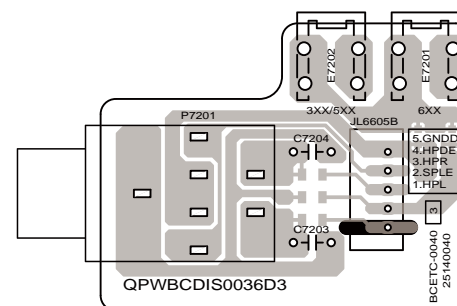

U0035 INLET PC BOARD
(BAETC-0041)

TX-SA507/607 and
TX-SR607<MR> only
Component side

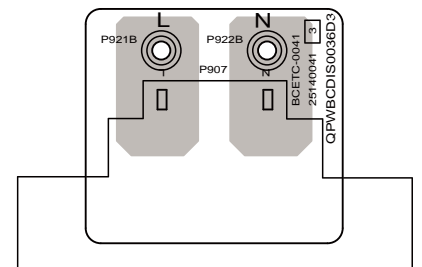

1

2

3

4

5

A B C D E F G H

PRINTED CIRCUIT BOARD VIEWS-8 / U003

U003 DISPLAY PC BOARD
(BADIS-0036)

Soldering side

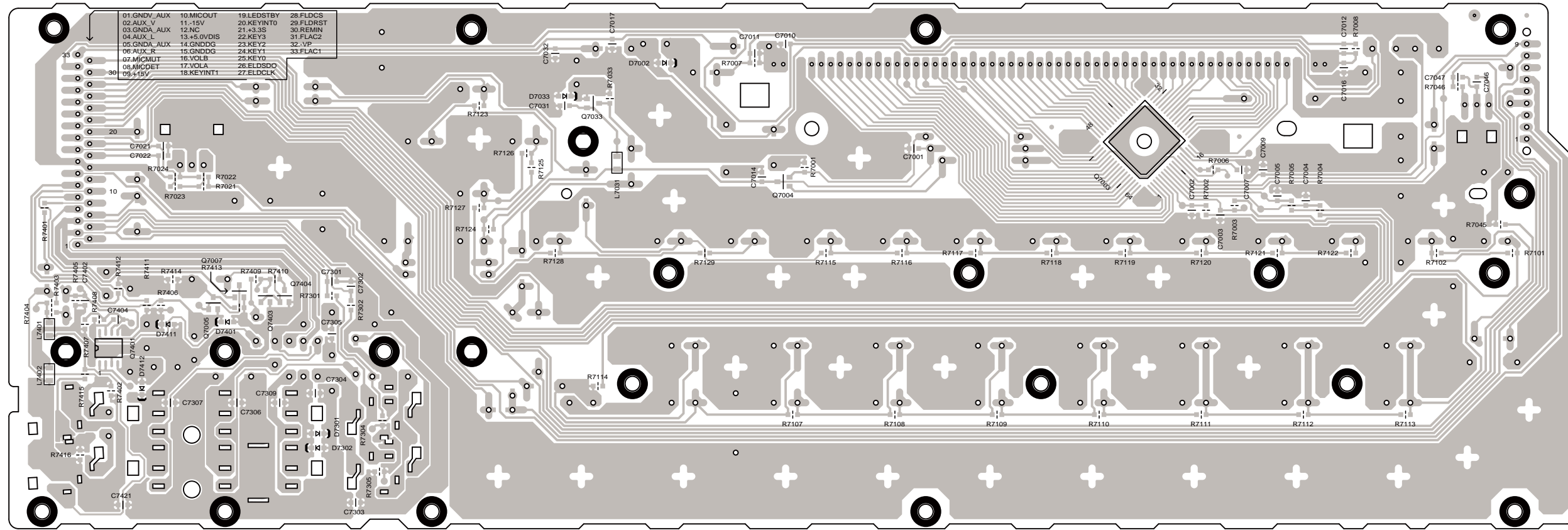

U0031 SWITCH PC BOARD
(BADIS-0037)

Soldering side

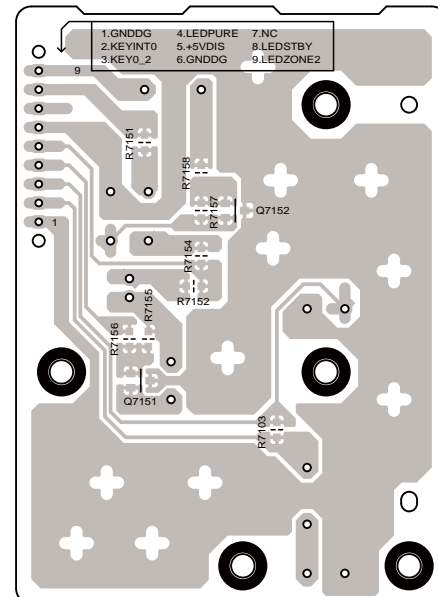

U0033 POWER SUPPLY PC BOARD
(BAPS-0039)

Soldering side

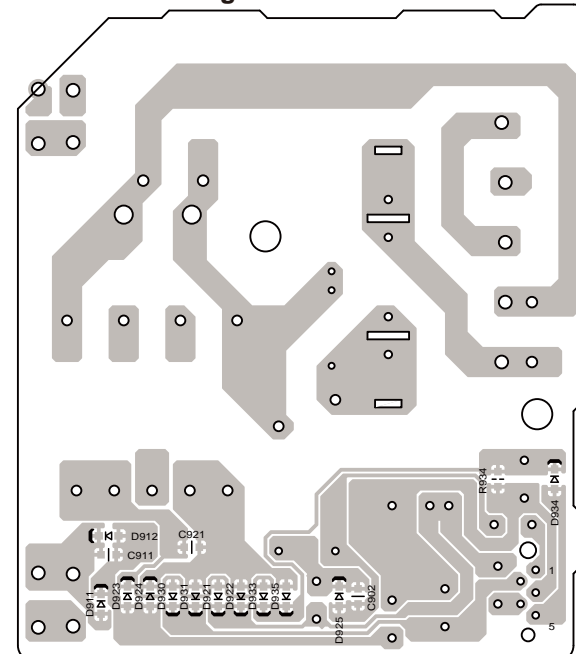

U0034 HEADPHONE PC BOARD
(BAETC-0040)

Soldering side

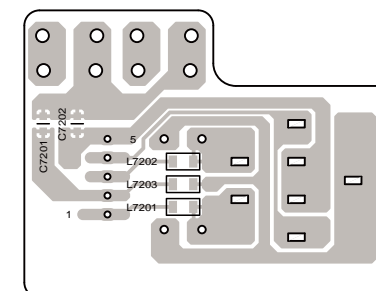

U0035 INLET PC BOARD
(BAETC-0041)

TX-SA507/607 and
TX-SR607<MR> only
Soldering side

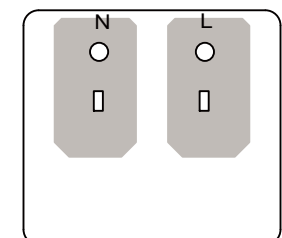

1

2

3

4

5

PRINTED CIRCUIT BOARD VIEWS-9 / U003

U0032 VIDEO PC BOARD
(BAVD-0038) Component side

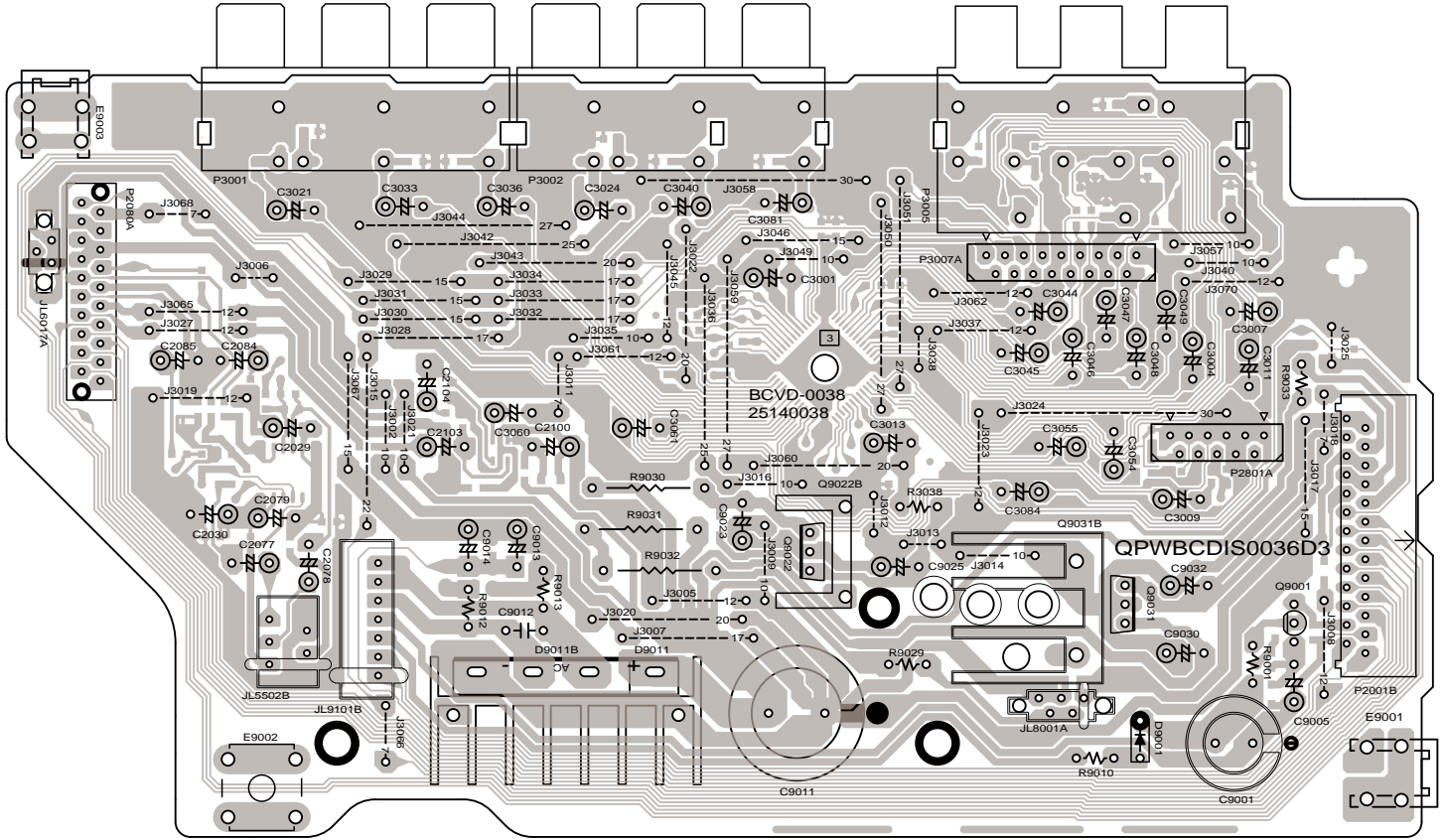

U0032 VIDEO PC BOARD
(BAVD-0038) Soldering side

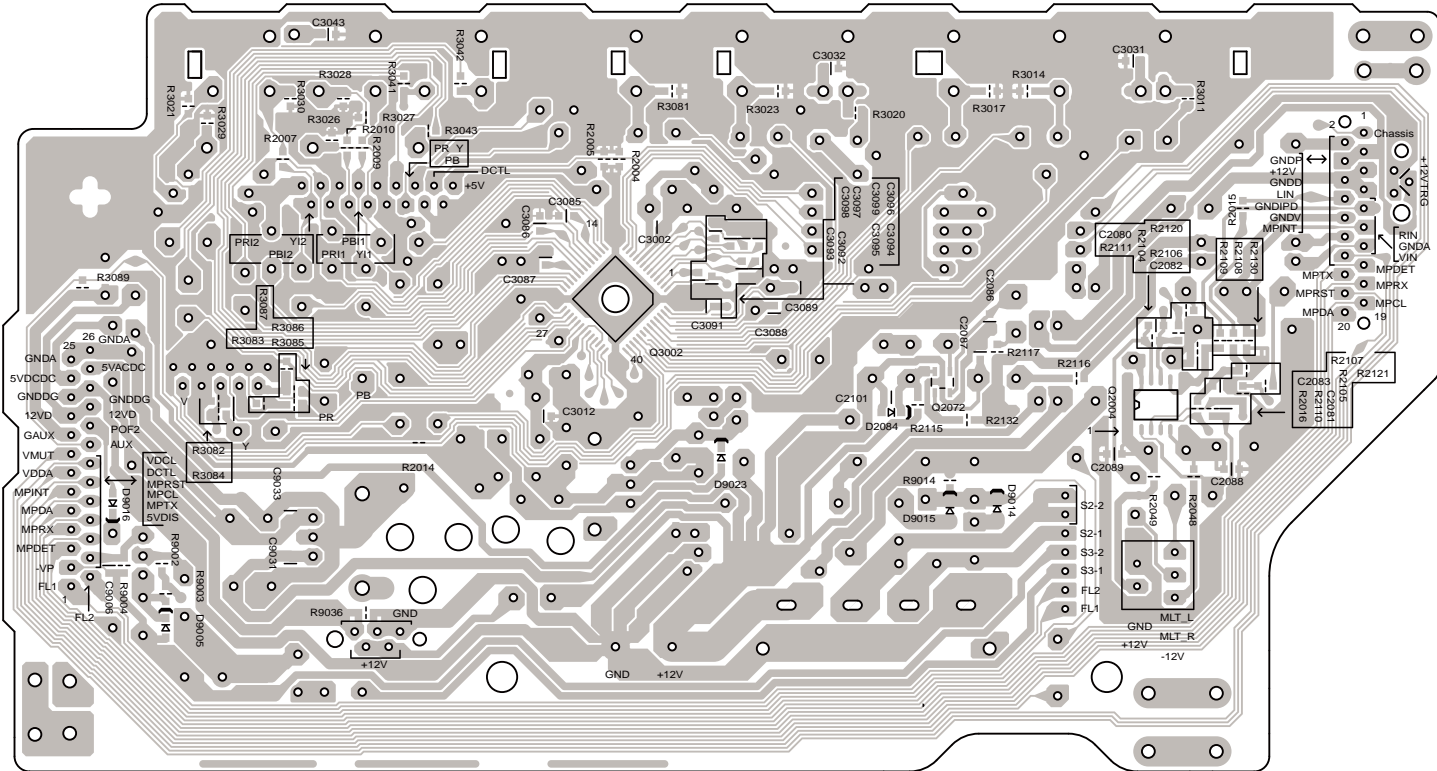

A B C D
PRINTED CIRCUIT BOARD VIEWS-11 / U004

**U004 HDMI / DSP PC BOARD
 (BAHDM-0063)**

1

2

3

4

5

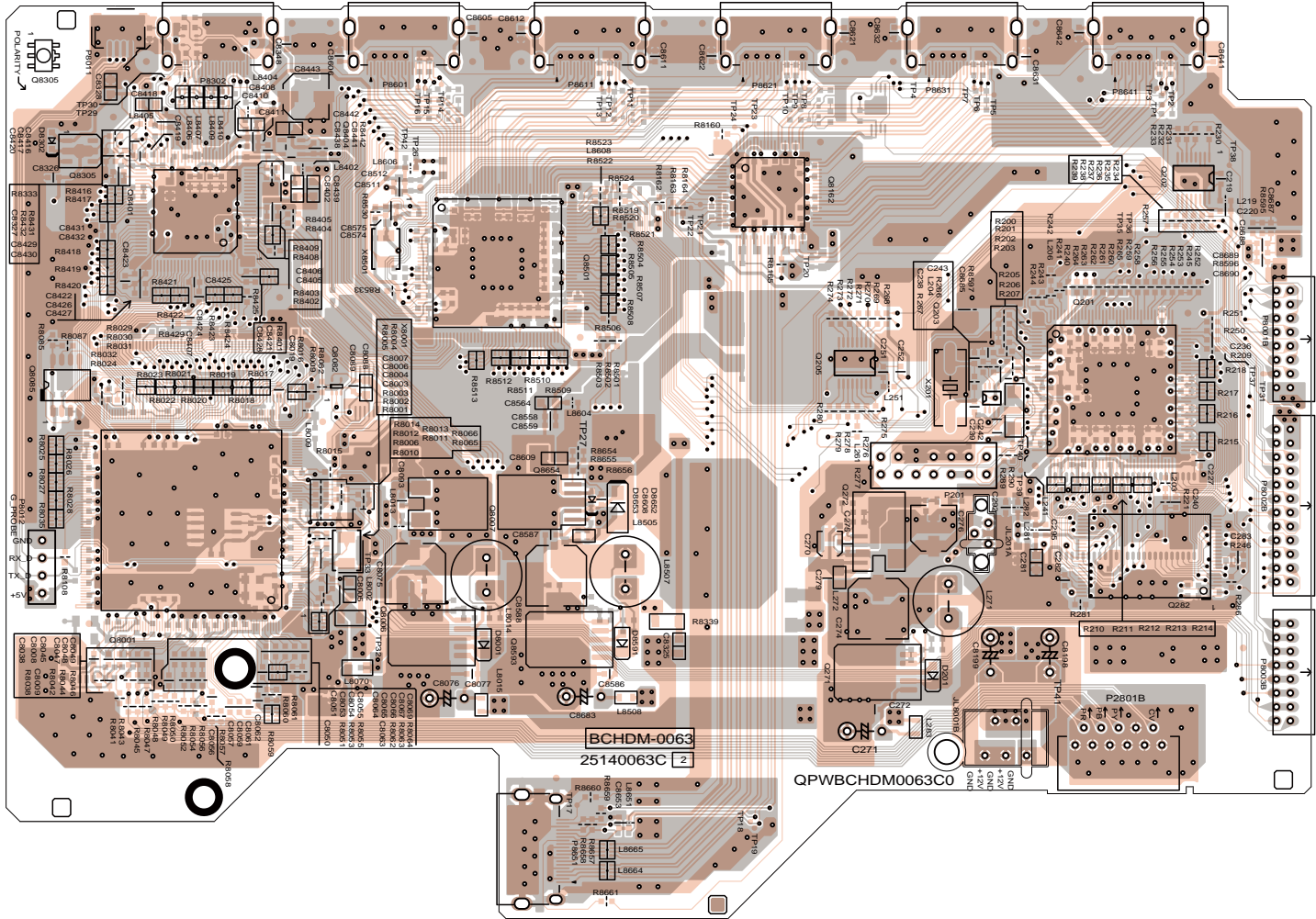

**U0041 FRONT HDMI PC BOARD
 (BAHDM-0064)**

**U0042 FRONT HDMI PC BOARD
 (BAETC-0065)**

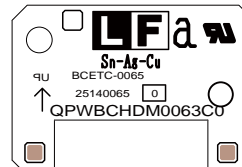
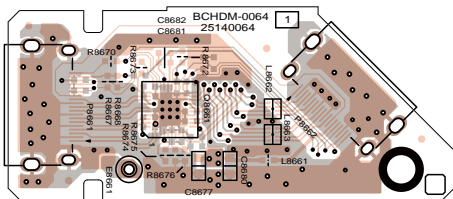

A B C D E F G H

PRINTED CIRCUIT BOARD VIEWS-14 / U005

U005 SP TERMINAL PC BOARD
(BATRM-0029)

Component side

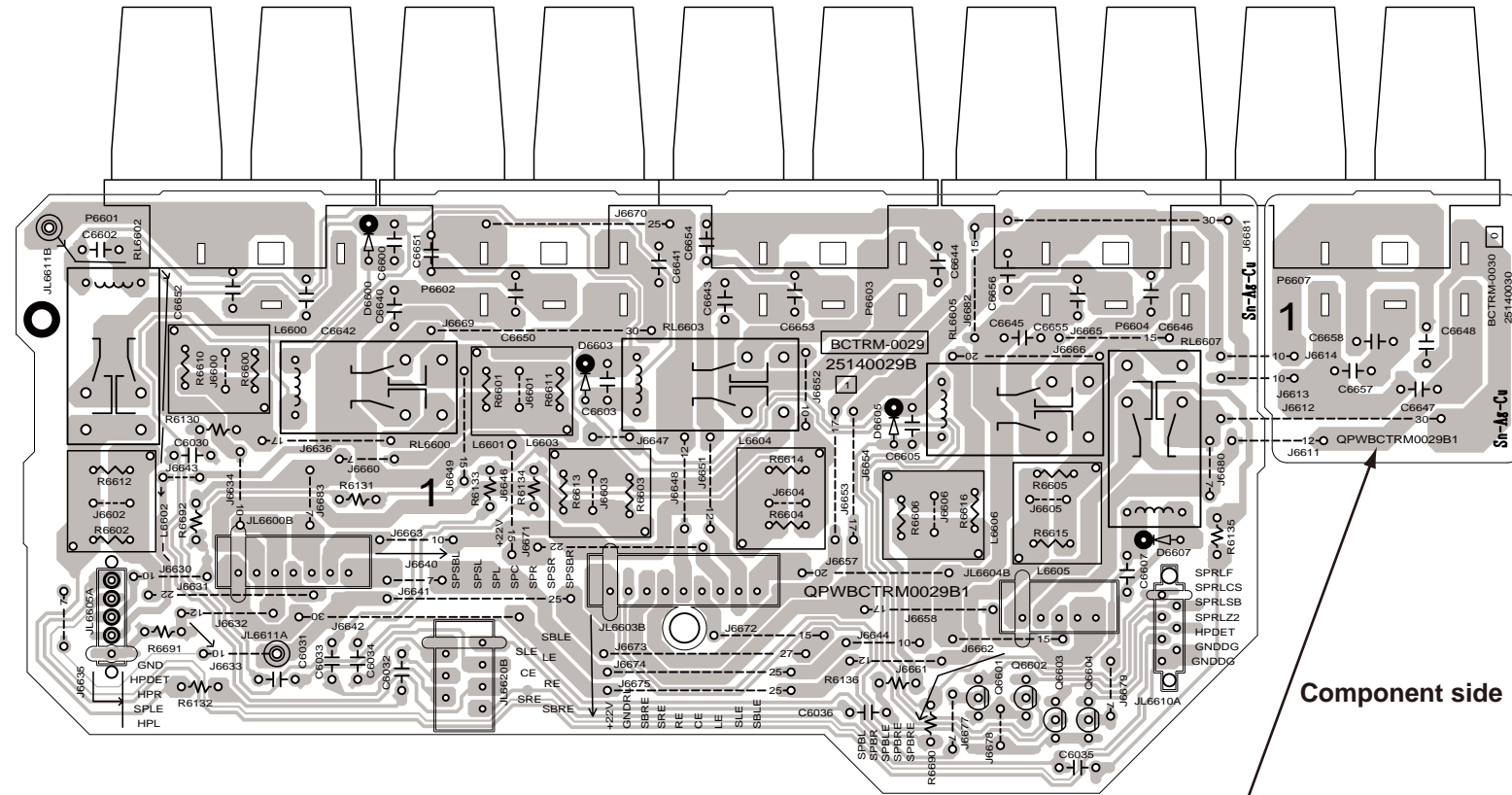

Component side

U0052 D4 TERMINAL PC BOARD
(BAVD-0031)

TX-SA507/607 only

Component side

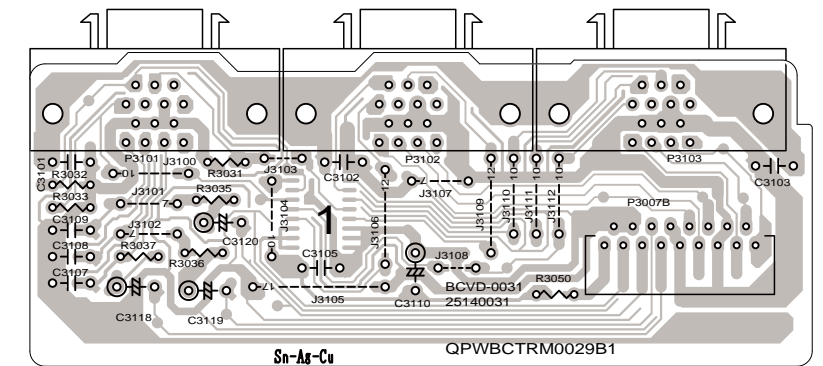

Sn-Ag-Cu

QPWBCTRM0029B1

U0052 D4 TERMINAL PC BOARD
(BAVD-0031)

TX-SA507/607 only

Soldering side

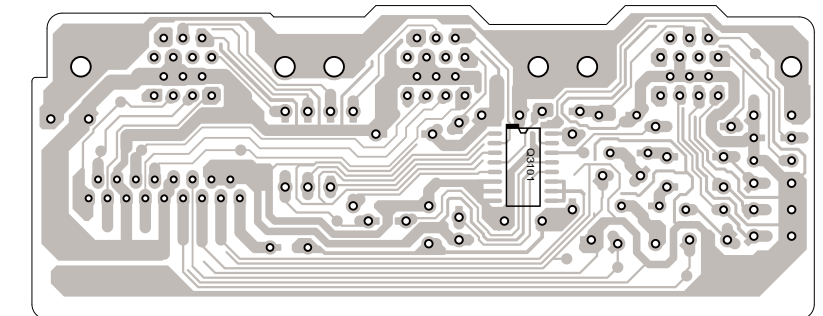

U005 SP TERMINAL PC BOARD
(BATRM-0029)

Soldering side

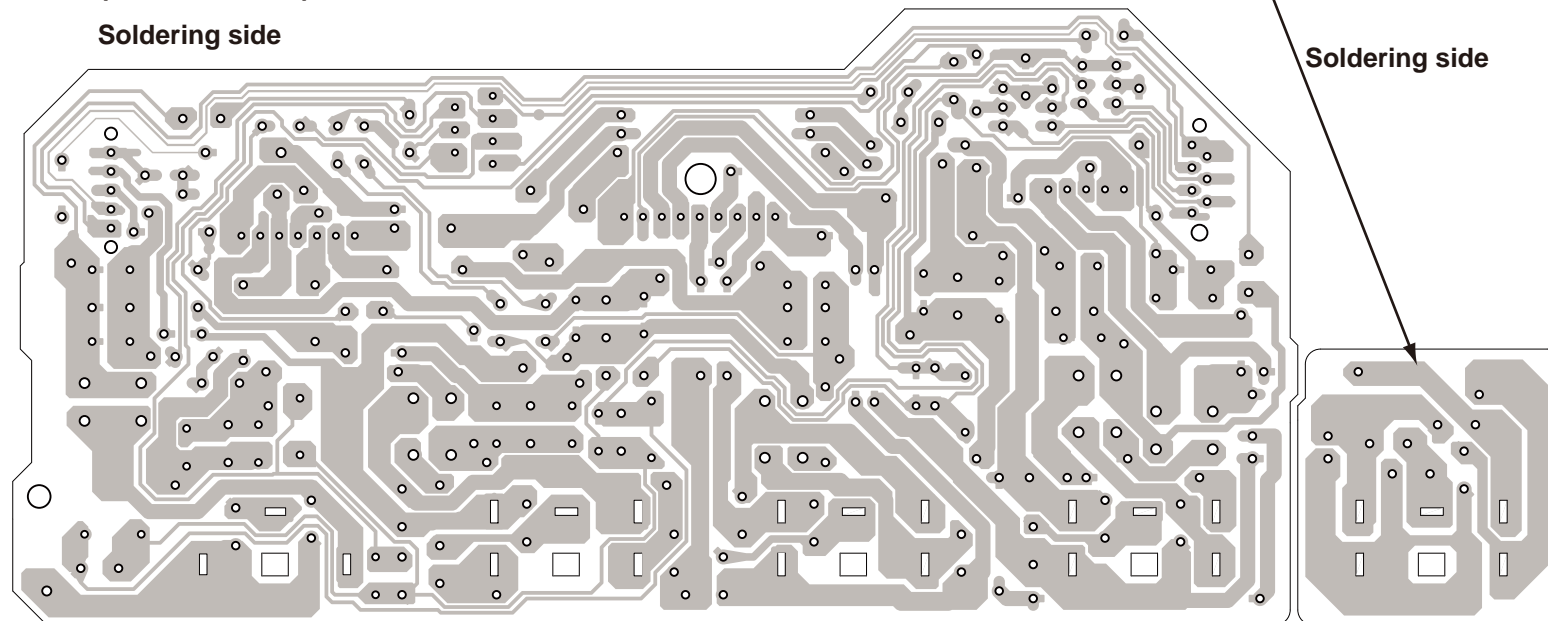

Soldering side

U0051 FRONT HIGH L/R SP TERMINAL PC BOARD
(BATRM-0030)

TX-SR607 <MO, MQ, PA, PB, PP, MR>, TX-SA607 only

1

2

3

4

5

A B C D
PRINTED CIRCUIT BOARD VIEWS-16 / U006

U006 DRIVER AMP. PC BOARD
(BACLA-0020)

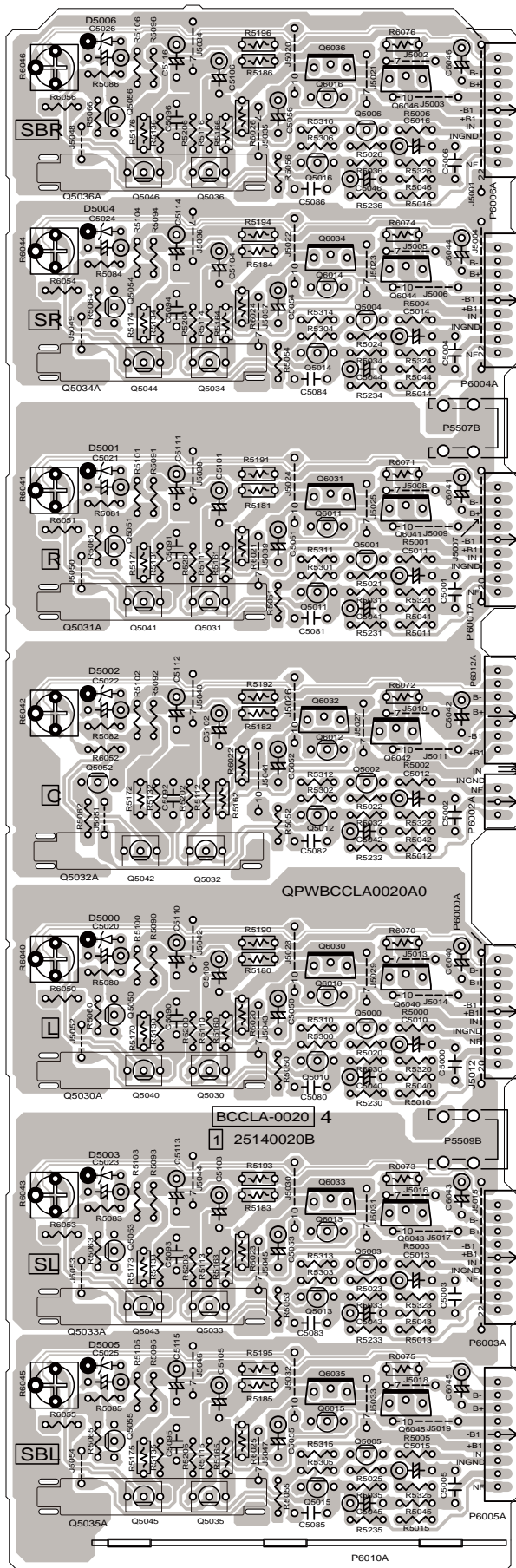
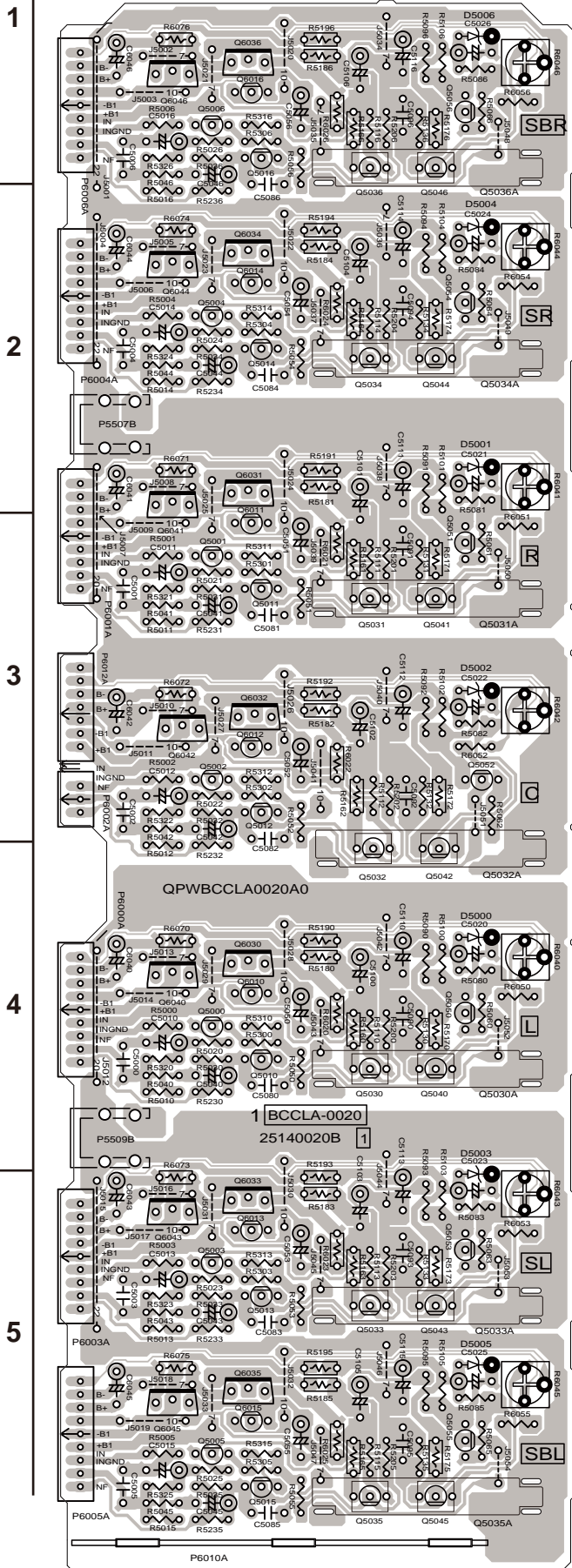

TX-SR607

<Note>

Parts marked by "NSP" are generally unavailable because they are not in our Master Spare Parts List.

NOTE : THE COMPONENTS IDENTIFIED BY THE MARK
! ARE CRITICAL FOR RISK OF FIRE AND
ELECTRIC SHOCK. REPLACE ONLY WITH PART
NUMBER SPECIFIED.

<Notes>

(B) : Black model

(S) : Silver model

(G) : Golden model

<DC> : 120V,Canadian model

<DD> : 120V,USA model

<DF> : 120V,Taiwanese model

<MO> : 220/230-240V,Saudi Arabian model

<MQ> : 220/230-240V,Hong kong model

<PA> : 230V,Australian model

<PB> : 230V,UK model

<PP> : 230V,CE(European) country model

<MR> : 220/230-240V,Chinese model

EXPLODED VIEW PARTS LIST

REF. NO.	PART NAME	DESCRIPTION	Q'TY	PART NO. (SN)	REMARKS
Q6050	TR	2SC4468-O	1	2202523	EXCEPT <MPB,MPP>
Q6050	TR	2SC5242-O	1	2202843	<MPB,MPP>
Q6050 or	TR	2SC4468-Y	(1)	2202524	EXCEPT <MPB,MPP>
Q6050 or	TR	2SC4468-P	(1)	2202526	EXCEPT <MPB,MPP>
Q6050 or	TR	2SC5242-R	(1)	2202842	<MPB,MPP>
Q6050 or	TR	MN130S-O	(1)	2203663	EXCEPT <MPB,MPP>
Q6050 or	TR	MN130S-Y	(1)	2203664	EXCEPT <MPB,MPP>
Q6050 or	TR	MN130S-P	(1)	2203666	EXCEPT <MPB,MPP>
Q6050A	ISO SHEET	AC238	2	223024	
Q6050B	ISO SHEET	ISO SHEET	6	223050	N
Q6051	TR	2SC4468-O	1	2202523	EXCEPT <MPB,MPP>
Q6051	TR	2SC5242-O	1	2202843	<MPB,MPP>

Q6051 or	TR	2SC4468-Y	(1)	2202524	EXCEPT <MPB,MPP>
Q6051 or	TR	2SC4468-P	(1)	2202526	EXCEPT <MPB,MPP>
Q6051 or	TR	2SC5242-R	(1)	2202842	<MPB,MPP>
Q6051 or	TR	MN130S-O	(1)	2203663	EXCEPT <MPB,MPP>
Q6051 or	TR	MN130S-Y	(1)	2203664	EXCEPT <MPB,MPP>
Q6051 or	TR	MN130S-P	(1)	2203666	EXCEPT <MPB,MPP>
Q6052	TR	2SC4468-O	1	2202523	EXCEPT <MPB,MPP>
Q6052	TR	2SC5242-O	1	2202843	<MPB,MPP>
Q6052 or	TR	2SC4468-Y	(1)	2202524	EXCEPT <MPB,MPP>
Q6052 or	TR	2SC4468-P	(1)	2202526	EXCEPT <MPB,MPP>
Q6052 or	TR	2SC5242-R	(1)	2202842	<MPB,MPP>
Q6052 or	TR	MN130S-O	(1)	2203663	EXCEPT <MPB,MPP>
Q6052 or	TR	MN130S-Y	(1)	2203664	EXCEPT <MPB,MPP>
Q6052 or	TR	MN130S-P	(1)	2203666	EXCEPT <MPB,MPP>
Q6053	TR	2SC4468-O	1	2202523	EXCEPT <MPB,MPP>
Q6053	TR	2SC5242-O	1	2202843	<MPB,MPP>
Q6053 or	TR	2SC4468-Y	(1)	2202524	EXCEPT <MPB,MPP>
Q6053 or	TR	2SC4468-P	(1)	2202526	EXCEPT <MPB,MPP>
Q6053 or	TR	2SC5242-R	(1)	2202842	<MPB,MPP>
Q6053 or	TR	MN130S-O	(1)	2203663	EXCEPT <MPB,MPP>
Q6053 or	TR	MN130S-Y	(1)	2203664	EXCEPT <MPB,MPP>
Q6053 or	TR	MN130S-P	(1)	2203666	EXCEPT <MPB,MPP>
Q6054	TR	2SC4468-O	1	2202523	EXCEPT <MPB,MPP>
Q6054	TR	2SC5242-O	1	2202843	<MPB,MPP>
Q6054 or	TR	2SC4468-Y	(1)	2202524	EXCEPT <MPB,MPP>
Q6054 or	TR	2SC4468-P	(1)	2202526	EXCEPT <MPB,MPP>
Q6054 or	TR	2SC5242-R	(1)	2202842	<MPB,MPP>
Q6054 or	TR	MN130S-O	(1)	2203663	EXCEPT <MPB,MPP>
Q6054 or	TR	MN130S-Y	(1)	2203664	EXCEPT <MPB,MPP>
Q6054 or	TR	MN130S-P	(1)	2203666	EXCEPT <MPB,MPP>
Q6055	TR	2SC4468-O	1	2202523	EXCEPT <MPB,MPP>
Q6055	TR	2SC5242-O	1	2202843	<MPB,MPP>
Q6055 or	TR	2SC4468-Y	(1)	2202524	EXCEPT <MPB,MPP>
Q6055 or	TR	2SC4468-P	(1)	2202526	EXCEPT <MPB,MPP>
Q6055 or	TR	2SC5242-R	(1)	2202842	<MPB,MPP>
Q6055 or	TR	MN130S-O	(1)	2203663	EXCEPT <MPB,MPP>
Q6055 or	TR	MN130S-Y	(1)	2203664	EXCEPT <MPB,MPP>
Q6055 or	TR	MN130S-P	(1)	2203666	EXCEPT <MPB,MPP>
Q6056	TR	2SC4468-O	1	2202523	EXCEPT <MPB,MPP>

Q6056	TR	2SC5242-O	1	2202843	<MPB,MPP>
Q6056 or	TR	2SC4468-Y	(1)	2202524	EXCEPT <MPB,MPP>
Q6056 or	TR	2SC4468-P	(1)	2202526	EXCEPT <MPB,MPP>
Q6056 or	TR	2SC5242-R	(1)	2202842	<MPB,MPP>
Q6056 or	TR	MN130S-O	(1)	2203663	EXCEPT <MPB,MPP>
Q6056 or	TR	MN130S-Y	(1)	2203664	EXCEPT <MPB,MPP>
Q6056 or	TR	MN130S-P	(1)	2203666	EXCEPT <MPB,MPP>
Q6060	TR	2SA1695-O	1	2202513	EXCEPT <MPB,MPP>
Q6060	TR	2SA1962-O	1	2202833	<MPB,MPP>
Q6060 or	TR	2SA1695-Y	(1)	2202514	EXCEPT <MPB,MPP>
Q6060 or	TR	2SA1695-P	(1)	2202516	EXCEPT <MPB,MPP>
Q6060 or	TR	2SA1962-R	(1)	2202832	<MPB,MPP>
Q6060 or	TR	MP130S-O	(1)	2203673	EXCEPT <MPB,MPP>
Q6060 or	TR	MP130S-Y	(1)	2203674	EXCEPT <MPB,MPP>
Q6060 or	TR	MP130S-P	(1)	2203676	EXCEPT <MPB,MPP>
Q6061	TR	2SA1695-O	1	2202513	EXCEPT <MPB,MPP>
Q6061	TR	2SA1962-O	1	2202833	<MPB,MPP>
Q6061 or	TR	2SA1695-Y	(1)	2202514	EXCEPT <MPB,MPP>
Q6061 or	TR	2SA1695-P	(1)	2202516	EXCEPT <MPB,MPP>
Q6061 or	TR	2SA1962-R	(1)	2202832	<MPB,MPP>
Q6061 or	TR	MP130S-O	(1)	2203673	EXCEPT <MPB,MPP>
Q6061 or	TR	MP130S-Y	(1)	2203674	EXCEPT <MPB,MPP>
Q6061 or	TR	MP130S-P	(1)	2203676	EXCEPT <MPB,MPP>
Q6062	TR	2SA1695-O	1	2202513	EXCEPT <MPB,MPP>
Q6062	TR	2SA1962-O	1	2202833	<MPB,MPP>
Q6062 or	TR	2SA1695-Y	(1)	2202514	EXCEPT <MPB,MPP>
Q6062 or	TR	2SA1695-P	(1)	2202516	EXCEPT <MPB,MPP>
Q6062 or	TR	2SA1962-R	(1)	2202832	<MPB,MPP>
Q6062 or	TR	MP130S-O	(1)	2203673	EXCEPT <MPB,MPP>
Q6062 or	TR	MP130S-Y	(1)	2203674	EXCEPT <MPB,MPP>
Q6062 or	TR	MP130S-P	(1)	2203676	EXCEPT <MPB,MPP>
Q6063	TR	2SA1695-O	1	2202513	EXCEPT <MPB,MPP>
Q6063	TR	2SA1962-O	1	2202833	<MPB,MPP>
Q6063 or	TR	2SA1695-Y	(1)	2202514	EXCEPT <MPB,MPP>
Q6063 or	TR	2SA1695-P	(1)	2202516	EXCEPT <MPB,MPP>
Q6063 or	TR	2SA1962-R	(1)	2202832	<MPB,MPP>
Q6063 or	TR	MP130S-O	(1)	2203673	EXCEPT <MPB,MPP>
Q6063 or	TR	MP130S-Y	(1)	2203674	EXCEPT <MPB,MPP>
Q6063 or	TR	MP130S-P	(1)	2203676	EXCEPT <MPB,MPP>

Q6064	TR	2SA1695-O	1	2202513	EXCEPT <MPB,MPP>
Q6064	TR	2SA1962-O	1	2202833	<MPB,MPP>
Q6064 or	TR	2SA1695-Y	(1)	2202514	EXCEPT <MPB,MPP>
Q6064 or	TR	2SA1695-P	(1)	2202516	EXCEPT <MPB,MPP>
Q6064 or	TR	2SA1962-R	(1)	2202832	<MPB,MPP>
Q6064 or	TR	MP130S-O	(1)	2203673	EXCEPT <MPB,MPP>
Q6064 or	TR	MP130S-Y	(1)	2203674	EXCEPT <MPB,MPP>
Q6064 or	TR	MP130S-P	(1)	2203676	EXCEPT <MPB,MPP>
Q6065	TR	2SA1695-O	1	2202513	EXCEPT <MPB,MPP>
Q6065	TR	2SA1962-O	1	2202833	<MPB,MPP>
Q6065 or	TR	2SA1695-Y	(1)	2202514	EXCEPT <MPB,MPP>
Q6065 or	TR	2SA1695-P	(1)	2202516	EXCEPT <MPB,MPP>
Q6065 or	TR	2SA1962-R	(1)	2202832	<MPB,MPP>
Q6065 or	TR	MP130S-O	(1)	2203673	EXCEPT <MPB,MPP>
Q6065 or	TR	MP130S-Y	(1)	2203674	EXCEPT <MPB,MPP>
Q6065 or	TR	MP130S-P	(1)	2203676	EXCEPT <MPB,MPP>
Q6066	TR	2SA1695-O	1	2202513	EXCEPT <MPB,MPP>
Q6066	TR	2SA1962-O	1	2202833	<MPB,MPP>
Q6066 or	TR	2SA1695-Y	(1)	2202514	EXCEPT <MPB,MPP>
Q6066 or	TR	2SA1695-P	(1)	2202516	EXCEPT <MPB,MPP>
Q6066 or	TR	2SA1962-R	(1)	2202832	<MPB,MPP>
Q6066 or	TR	MP130S-O	(1)	2203673	EXCEPT <MPB,MPP>
Q6066 or	TR	MP130S-Y	(1)	2203674	EXCEPT <MPB,MPP>
Q6066 or	TR	MP130S-P	(1)	2203676	EXCEPT <MPB,MPP>
<Note>					
Must use the same HFE rank mutually about the following parts.					
Ref. No. : Q6050-Q6060, Q6051-Q6061, Q6052-Q6062, Q6053-Q6063, Q6054-Q6064, Q6055-Q6065, Q6056-Q6066					
T901	P TRANS	NPT-1552D	1	2301888	! <MDC,MDD,MDF>
T901	P TRANS	NPT-1552P	1	2301889	! <MPA,MPB,MPP>
T901	P TRANS	NPT-1552DQ	1	2301890	! <MMO,MMQ,MMR>
F6901	FUSE	12A-TUL-250V	1	252301GR	!
F6902	FUSE	12A-TUL-250V	1	252301GR	!
F901	FUSE	5A-SE-EAK FUSE	1	252078GR	! <MMO,MMQ,MPA,MPB,MPP,MMR>
F901	FUSE	10A-UL/T-233	1	252330GR	! <MDC,MDD,MDF>
F901 or	FUSE	5A-SE-TL250V	(1)	252278GR	! <MMO,MMQ,MPA,MPB,MPP,MMR>
F901 or	FUSE	10A-T/UL-ST2	(1)	252333GR	! <MDC,MDD,MDF>
F910	FUSE	5A-UL/T-233	1	252326GR	!
F910 or	FUSE	5A-T/UL-ST2	(1)	252258GR	!
P101	FFC	NCFC7-112012	1	2047112012	

P2801	FFC	NCFC7-111012	1	2047111012	
P6601A	P RIVET	JB-407A-C	18	880052	<MMO,MMQ,MPA,MPB,MPP,MMR>
P701	FFC	NCFC7-332012	1	2047332012	
P8651	CORD AS	HDMI 0.55M	1	2010471	
P901	AC CORD	AS-BS	1	253198LTK	! <MMQ>
P901	AC CORD	AS-BS	1	253198VOL	! <MPB>
P901	AC CORD	AS-CEE-2	1	253306VOL	! <MMO,MPP>
P901	AC CORD	AS-CCC	1	253358VOL	! <GMMR>
P901	AC CORD	AS-UC-2	1	253368AYUN	! <MDC,MDD>
P901	AC CORD	AS-SAA	1	253388LTK	! <MPA>
P901	AC CORD	AS-CNS	1	253429VOL	! <MDF>
P901 or	AC CORD	AS-BS	(1)	253198LTK	! <MPB>
P901 or	AC CORD	AS-UC-2	(1)	253368BLTK	! <MDC,MDD>
P901 or	AC CORD	AS-CEE-2	(1)	253374YUN	! <MMO,MPP>
A001	CHASSIS	TX-SR507	1	27100533B	
A003	BOTTOM LEG	.	4	27175432C	
A004	CUSHION	(BUTYL)	4	28141748	
A005	CUSHION	.	4	28141664	
A007	SCREW	3TTB+8B(3CM)SR	4	801637	
A009	HOLDER	KGLS-8RT	2	27190503A	
A010	HOLDER	KGPS-8RF	2	27191044	
A011	HOLDER	KGLS-10RT	1	27190428A	
A013	HOLDER	KGPS-14RF	2	27190802	
A017	HOLDER	KGLS-16S	1	27190607	
A019	HOLDER	KGPS-16RF	1	27190991	
A021	HOLDER	KGLS-22S	2	27190369	
A023	HOLDER	KGLS-22S	1	27190369	
A025	SCREW	4TTC+8C(3BC)	4	830440089GR	
A027	SPACER	.	1	27270439	
A030	HEAT SINK	251	1	27160630	N
A032	RETAINER	(HL)	1	27142138A	
A034	RETAINER	(HR)	1	27142139A	
A036	SCREW	3TTB+8B(3CM)SR	4	801637	
A038	SCREW	3TTB+8B(3CM)SR	2	801637	
A040	SCREW	3TTB+8B(3CM)SR	4	801637	
A042	SCREW	3TTB+8B(3CM)SR	2	801637	
A044	HOLDER	KGLS-8RT	1	27190503A	
A050	SCREW	3SMS8W.SW+14B(CU)	14	801634	
A054	SCREW	3TTB+8B(3CM)SR	1	801637	

A056	BUSHING	S-RELIEF #2271	1	27300750	<B,S>
A058	LABEL	(PT)	1	29363379-1	
A060	WIRE TIE	BINDER(CLAMPER)UL	2	260258	
A062	WIRE TIE	BSK-1	3	260208	
A066	RETAINER	(B)	1	27142141	N
A068	SCREW	3TTB+8B(3CM)SR	3	801637	
A069	SCREW	3TTB+8B(3BC)	1	838430088GR	
A070	LABEL	(SP)	1	29390835	<MMO,MMQ,MPA,MPB,MPP,MMR>
A071	LABEL	(SP)570	1	29390690	<MDC,MDD,MDF>
A101	REAR PANEL	607DD	1	27123984B	N <MDC,MDD,MDF>
A101	REAR PANEL	607PP	1	27123985B	N <MPA,MPB,MPP>
A101	REAR PANEL	607MO	1	27123986B	N <MMO,MMQ>
A101	REAR PANEL	607MR	1	27123987B	N <MMR>
A102	CUSHION	.	2	28141799	
A103	SCREW	3P+6FN(3BC)	9	82143006GR	<BMDC,BMDD,BMDF>
A103	SCREW	3P+6FN(3BC)	8	82143006GR	<BMMO,BMMQ,BMPA,BMPB,BMPP,GMMR>
A103	SCREW	3P+6FN(3BC)	9	82143006GR	<SMDD>
A103	SCREW	3P+6FN(3BC)	8	82143006GR	<SMMO,SMPA,SMPB,SMPP>
A104	CUSHION	(BUTYL)	1	28141748	
A105	SCREW	3TTB+8B(3BC)	29	838430088GR	<BMDC,BMDD,BMDF>
A105	SCREW	3TTB+8B(3BC)	28	838430088GR	<BMMO,BMMQ,BMPA,BMPB,BMPP,GMMR>
A105	SCREW	3TTB+8B(3BC)	29	838430088GR	<SMDD>
A105	SCREW	3TTB+8B(3BC)	28	838430088GR	<SMMO,SMPA,SMPB,SMPP>
A107	SCREW	4TTB+10B(3BC)	2	838440108GR	<GMMR>
A108	HOLDER	Ac-Inlet	1	27191346	<G MMR>
A110	WASHER	B	2	24834018	<G MMR>
A201	F PANEL	(B)DD	1	27213189A	N <BMDC,BMDD,BMDF>
A201	F PANEL	(S)DC	1	27213190A	N <SMDD>
A201	F PANEL	(B)PP	1	27213191A	N <BMPB,BMPP>
A201	F PANEL	(S)PP	1	27213192A	N <SMPB,SMPP>
A201	F PANEL	(B)MO	1	27213193A	N <BMMO,BMMQ,BMPA>
A201	F PANEL	(S)MO	1	27213194A	N <SMMO,SMPA>
A201	F PANEL	(G)MR	1	27213195A	N <GMMR>
A202	CLEAR PLT	(AS)507/607P	1	28192255	N <MPB,MPP>
A202	CLEAR PLT	(AS)507/607O	1	28192256	N <MMO,MMQ,MPA,MMR>
A202	CLEAR PLT	(AS)507/607D	1	28192257	<MDC,MDD,MDF>
A207	BADGE	BADGE	1	28135244	
A207	BADGE	BADGE	1	28135245	<G>
A207	BADGE	.	1	28135298	<S>

A211	F BRACKET	(B)	1	27111530C	
A211	F BRACKET	(S)	1	27111531C	<S>
A211	F BRACKET	(G)	1	27111532C	N <G>
A215	KNOB	(SEL)	1	28326665	
A217	KNOB	(STNBY)	1	28326663	
A219	KNOB	(CUR)	1	28326664A	
A221	IB CUSHION	W15*3t TAPE	1	28141585	
A223	SCREW	2.6TTB+8B(3BC)	24	838426088GR	
A250	B PLATE	(B)	1	28133428	
A250	B PLATE	(S)	1	28133429	<G,S>
A254	WIRE TIE	BSK-1	8	260208	
A255	SCREW	3TTB+8B(3CM)SR	5	801637	
A256	SCREW	3TTB+8B(3CM)SR	1	801637	
A257	SCREW	3TTB+8B(3CM)SR	1	801637	
A260	SCREW	3TTB+8B(3BC)	3	838430088GR	
A262	TAPE	TAPE(CLOTH-16U)	1	29110083	
A263	TAPE	TAPE(CLOTH-8U)	1	29110082	
A264	CUSHION	.	3	28141681	
A267	SPACER	SPACER 8X3X0.188ボルト	1	27270147	
A321	KNOB	(VOL)(B)	1	28326670	N <BMDC,BMDD>
A321	KNOB	(VOL)(S)	1	28326671	N <SMDD>
A321	KNOB	(VOL)AS(B)	1	28326672	N <BMDF,BMMO,BMMQ,BMPA,BMPB,BMPP>
A321	KNOB	(VOL)AS(S)	1	28326673	N <SMMO,SMPA,SMPB,SMPP>
A321	KNOB	(VOL)AS(G)	1	28326674	N <GMMR>
A333	CUSHION	.	2	28141637	<MDF,MMO,MMQ,MPA,MPB,MPP,MMR>
A334	CUSHION	(BUTYL)	1	28141748	<MDC,MDD>
A340	COVER	(B) (Bent)	1	28210034	N
A340	COVER	(S) (Bent)	1	28210035	N <S>
A340	COVER	(G) (Bent)	1	28210036	N <G>
A340	COVER	(B) (Not Bent)	1	28210034Z	N
A340	COVER	(S) (Not Bent)	1	28210035Z	N <S>
A340	COVER	(G) (Not Bent)	1	28210036Z	N <G>
A342	SCREW	3TTB+8B(3BC)	7	838430088GR	
A344	SCREW	3TTB+8B(3CM)SR	7	801637	<G,S>
A350	PLATE	(COVER)	1	27262834A	<BMMO,BMMQ>
A350	PLATE	(COVER)	1	27262835A	<GMMR,SMMO>
A354	HOLDER	(PLATE)	8	27191337	<BMMO,BMMQ>
A354	HOLDER	(PLATE)	8	27191333A	<GMMR,SMMO>
A360	LABEL	(COVER)	1	29390767	

A362	LABEL	HOOKUP-ONKYO	1	29363194	<MDC,MDD>
U001	Input selector/Volume/Power amp. pc board AS	BAAF-0014-1A	1	1B232514-1A	N <MDC,MDD,MDF>
U0011	Trans 2nd terminal pc board AS	BAPS-0015-1A	{ 1}	Included in U001, BAAF-0014-1A	N <MDC,MDD,MDF>, NSP
U0012	Trans 2nd terminal pc board AS	BAPS-0016-1A	{ 1}	1B232516-1A	N <MDC,MDD,MDF>
U0013	Thermal sensor pc board AS	BAETC-0017-1A	{ 1}	1B232517-1A	N <MDC,MDD,MDF>
U0014	Holder pc board AS	BAETC-0018-1A	{ 1}	1B232518-1A	N <MDC,MDD,MDF>
U0015	Holder pc board AS	BAETC-0019-1A	{ 1}	1B232519-1A	N <MDC,MDD,MDF>
U001	Input selector/Volume/Power amp. pc board AS	BAAF-0014-1B	1	1B232514-1B	N <MPA,MPB,MPP>
U0011	Trans 2nd terminal pc board AS	BAPS-0015-1B	{ 1}	Included in U001, BAAF-0014-1B	N <MPA,MPB,MPP>, NSP
U0012	Trans 2nd terminal pc board AS	BAPS-0016-1B	{ 1}	1B232516-1B	N <MPA,MPB,MPP>
U0013	Thermal sensor pc board AS	BAETC-0017-1B	{ 1}	1B232517-1B	N <MPA,MPB,MPP>
U0014	Holder pc board AS	BAETC-0018-1B	{ 1}	1B232518-1B	N <MPA,MPB,MPP>
U0015	Holder pc board AS	BAETC-0019-1B	{ 1}	1B232519-1B	N <MPA,MPB,MPP>
U001	Input selector/Volume/Power amp. pc board AS	BAAF-0014-1C	1	1B232514-1C	N <MMO,MMQ,MMR>
U0011	Trans 2nd terminal pc board AS	BAPS-0015-1C	{ 1}	Included in U001, BAAF-0014-1C	N <MMO,MMQ,MMR>, NSP
U0012	Trans 2nd terminal pc board AS	BAPS-0016-1C	{ 1}	1B232516-1C	N <MMO,MMQ,MMR>
U0013	Thermal sensor pc board AS	BAETC-0017-1C	{ 1}	1B232517-1C	N <MMO,MMQ,MMR>
U0014	Holder pc board AS	BAETC-0018-1C	{ 1}	1B232518-1C	N <MMO,MMQ,MMR>
U0015	Holder pc board AS	BAETC-0019-1C	{ 1}	1B232519-1C	N <MMO,MMQ,MMR>
U002	MPU/CODEC pc board AS	BADG-0025-1H	1	1B232525-1H	N <MDC,MDD,MDF>
U0021	Universal port pc board AS	BAETC-0027-1H	{ 1}	1B232527-1H	N <MDC,MDD,MDF>
U002	MPU/CODEC pc board AS	BADG-0025-1J	1	1B232525-1J	N <MPB,MPP>
U0021	Universal port pc board AS	BAETC-0027-1J	{ 1}	1B232525-1J	N <MPB,MPP>
U002	MPU/CODEC pc board AS	BADG-0025-1K	1	1B232525-1K	N <MMO,MMQ,MPA,MMR>
U0021	Universal port pc board AS	BAETC-0027-1K	{ 1}	1B232527-1K	N <MMO,MMQ,MPA,MMR>
U003	Diplay pc board AS	BADIS-0036-1Q	1	1B232536-1Q	N <MDC,MDD,MDF>
U0031	Switch pc board AS	BADIS-0037-1Q	{ 1}	1B232537-1Q	N <MDC,MDD,MDF>
U0032	Video pc board AS	BAVD-0038-1Q	{ 1}	1B232538-1Q	N <MDC,MDD,MDF>
U0033	Power supply pc board AS	BAPS-0039-1Q	{ 1}	1B232539-1Q	N <MDC,MDD,MDF>
U0034	Headphone pc board AS	BAETC-0040-1Q	{ 1}	1B232540-1Q	N <MDC,MDD,MDF>
U003	Diplay pc board AS	BADIS-0036-1R	1	1B232536-1R	N <MPA,MPB,MPP>
U0031	Switch pc board AS	BADIS-0037-1R	{ 1}	1B232537-1R	N <MPA,MPB,MPP>
U0032	Video pc board AS	BAVD-0038-1R	{ 1}	1B232538-1R	N <MPA,MPB,MPP>
U0033	Power supply pc board AS	BAPS-0039-1R	{ 1}	1B232539-1R	N <MPA,MPB,MPP>
U0034	Headphone pc board AS	BAETC-0040-1R	{ 1}	1B232540-1R	N <MPA,MPB,MPP>
U003	Diplay pc board AS	BADIS-0036-1T	1	1B232536-1T	N <MMO,MMQ>
U0031	Switch pc board AS	BADIS-0037-1T	{ 1}	1B232537-1T	N <MMO,MMQ>
U0032	Video pc board AS	BAVD-0038-1T	{ 1}	1B232538-1T	N <MMO,MMQ>
U0033	Power supply pc board AS	BAPS-0039-1T	{ 1}	1B232539-1T	N <MMO,MMQ>

U0034	Headphone pc board AS	BAETC-0040-1T	{ 1}	1B232540-1T	N <MMO,MMQ>
U003	Diplay pc board AS	BADIS-0036-1U	1	1B232536-1U	N <MMR>
U0031	Switch pc board AS	BADIS-0037-1U	{ 1}	1B232537-1U	N <MMR>
U0032	Video pc board AS	BAVD-0038-1U	{ 1}	1B232538-1U	N <MMR>
U0033	Power supply pc board AS	BAPS-0039-1U	{ 1}	1B232539-1U	N <MMR>
U0034	Headphone pc board AS	BAETC-0040-1U	{ 1}	1B232540-1U	N <MMR>
U0035	Inlet pc board AS	BAETC-0041-1U	{ 1}	1B232541-1U	<MMR>
U004	HDMI,DSP pc board AS	BAHDM-0063-1A	1	1B232563-1A	N
U0041	Front HDMI pc board AS	BAHDM-0064-1A	{ 1}	1B232564-1A	N
U0042	Holder pc board AS	BAETC-0065-1A	{ 1}	1B232565-1A	N
U005	SP terminal pc board AS	BATRM-0029-1G	1	1B232529-1G	N <MDC,MDD,MDF>
U005	SP terminal pc board AS	BATRM-0029-1H	1	1B232529-1H	N <MMO,MMQ,MPA,MPB,MPP,MMR>
U0051	FRONT HIGH L/R SP terminal pc board AS	BATRM-0030-1H	{ 1}	1B232530-1H	<MMO,MMQ,MPA,MPB,MPP,MMR>
U006	Driver amp. Pc board AS	BACLA-0020-1A	1	1B232520-1A	N
U010	TUNER UNIT	FAEH06-E01EX	1	240165	<MMO,MMQ,MPA,MPB,MPP,MMR>
U010	TUNER UNIT	FAEH06-A01US	1	240166	<MDC,MDD,MDF>

TX-SR607

PC BOARD PARTS LIST

U001	Input selector/Volume/Power amp. pc board AS (BAAF-0014-1A/1B/1C)
U0011	Trans 2nd terminal pc board AS (BAPS-0015-1A/1B/1C)
U0012	Trans 2nd terminal pc board AS (BAPS-0016-1A/1B/1C)
U0013	Thermal sensor pc board AS (BAETC-0017-1A/1B/1C)
U0014	Holder pc board AS (BAETC-0018-1A/1B/1C)
U0015	Holder pc board AS (BAETC-0019-1A/1B/1C)

CIRCUIT NO.	PART NAME	DESCRIPTION	Q'TY	PART NO. (SN)	REMARKS
D5671	ZENER D	MTZJ7.5B	1	224470752T	
D5672	ZENER D	MTZJ7.5B	1	224470752T	
D5707	C-DIODE	KDS4148U	1	223283R2	
D5707 or	C-DIODE	1SS352	(1)	223234R2	
D5707 or	C-DIODE	MA2J111	(1)	223279R2	
D5717	C-DIODE	KDS4148U	1	223283R2	
D5717 or	C-DIODE	1SS352	(1)	223234R2	
D5717 or	C-DIODE	MA2J111	(1)	223279R2	
D5800	DIODE	RL1N4003	1	22380260T	
D5801	DIODE	RL1N4003	1	22380260T	
D5802	DIODE	RL1N4003	1	22380260T	
D5803	DIODE	RL1N4003	1	22380260T	
D5804	DIODE	RL1N4003	1	22380260T	
D5805	DIODE	RL1N4003	1	22380260T	
D6000	C-DIODE	KDS4148U	1	223283R2	
D6000 or	C-DIODE	1SS352	(1)	223234R2	
D6000 or	C-DIODE	MA2J111	(1)	223279R2	
D6001	C-DIODE	KDS4148U	1	223283R2	
D6001 or	C-DIODE	1SS352	(1)	223234R2	
D6001 or	C-DIODE	MA2J111	(1)	223279R2	
D6002	C-DIODE	KDS4148U	1	223283R2	
D6002 or	C-DIODE	1SS352	(1)	223234R2	
D6002 or	C-DIODE	MA2J111	(1)	223279R2	
D6003	C-DIODE	KDS4148U	1	223283R2	
D6003 or	C-DIODE	1SS352	(1)	223234R2	
D6003 or	C-DIODE	MA2J111	(1)	223279R2	
D6004	C-DIODE	KDS4148U	1	223283R2	
D6004 or	C-DIODE	1SS352	(1)	223234R2	

D6004 or	C-DIODE	MA2J111	(1)	223279R2
D6005	C-DIODE	KDS4148U	1	223283R2
D6005 or	C-DIODE	1SS352	(1)	223234R2
D6005 or	C-DIODE	MA2J111	(1)	223279R2
D6006	C-DIODE	KDS4148U	1	223283R2
D6006 or	C-DIODE	1SS352	(1)	223234R2
D6006 or	C-DIODE	MA2J111	(1)	223279R2
D6701	C-DIODE	KDS4148U	1	223283R2
D6701 or	C-DIODE	1SS352	(1)	223234R2
D6701 or	C-DIODE	MA2J111	(1)	223279R2
D6702	C-DIODE	KDS4148U	1	223283R2
D6702 or	C-DIODE	1SS352	(1)	223234R2
D6702 or	C-DIODE	MA2J111	(1)	223279R2
D6703	ZENER D	UDZS3.3B	1	224550330R2
D6704	ZENER D	UDZS3.3B	1	224550330R2
D6713	ZENER D	UDZS3.3B	1	224550330R2
D6901	DIODE	D10XB60H	1	22380337
D6901A	HEAT SINK	RAD-196	1	27160545
D6901C	SCREW	3P+10FN(3BC)	2	82143010GR
D6902	C-DIODE	KDS4148U	1	223283R2
D6902 or	C-DIODE	1SS352	(1)	223234R2
D6902 or	C-DIODE	MA2J111	(1)	223279R2
D6903	DIODE	D10XB60H	1	22380337
Q5501	IC	R2A15218FP	1	22242605R3
Q5503	IC	NJM4580M-D	1	22241448R2
Q5600	TR	RN1441	1	2215410R2
Q5601	TR	RN1441	1	2215410R2
Q5602	TR	RN1441	1	2215410R2
Q5603	TR	RN1441	1	2215410R2
Q5604	TR	RN1441	1	2215410R2
Q5605	TR	RN1441	1	2215410R2
Q5606	TR	RN1441	1	2215410R2
Q5607	TR	RN1441	1	2215410R2
Q5608	TR	RN1441	1	2215410R2
Q5609	TR	RN1441	1	2215410R2
Q5617	TR	RN1441	1	2215410R2
Q5630	IC	NJM4580M-D	1	22241448R2
Q5670	IC	78M15HF(NJM78M15FA)	1	222780155JRC
Q5670 or	IC	UPC78M15AHF-AZ	(1)	222780155NEC

Q5670A	HEAT SINK	RAD-196	1	27160545
Q5670B	SCREW	3P+10FN(3BC)	1	82143010GR
Q5671	IC	79M15HF(NJM79M15FA)	1	222790155JRC
Q5671 or	IC	UPC79M15HF-AZ	(1)	222790155NEC
Q5671B	SCREW	3P+10FN(3BC)	1	82143010GR
Q5684	TR	2SC1815-GR	1	2211255T
Q5685	TR	2SA1015-GR	1	2211455T
Q6000	TR	2SC1740S-S	1	2213285T
Q6001	TR	2SC1740S-S	1	2213285T
Q6002	TR	2SC1740S-S	1	2213285T
Q6003	TR	2SC1740S-S	1	2213285T
Q6004	TR	2SC1740S-S	1	2213285T
Q6005	TR	2SC1740S-S	1	2213285T
Q6006	TR	2SC1740S-S	1	2213285T
Q6070	TR	2SC2229-Y(TPE6_F)	1	2211634T
Q6071	TR	2SC2229-Y(TPE6_F)	1	2211634T
Q6072	TR	2SC2229-Y(TPE6_F)	1	2211634T
Q6073	TR	2SC2229-Y(TPE6_F)	1	2211634T
Q6074	TR	2SC2229-Y(TPE6_F)	1	2211634T
Q6075	TR	2SC2229-Y(TPE6_F)	1	2211634T
Q6076	TR	2SC2229-Y(TPE6_F)	1	2211634T
Q6380	IC	LM61CIZ	1	22242212
Q6380A	RETAINER	(PTH)	1	27141884-1
Q6701	TR	2SC2712-GR	1	2213145R2
Q6701 or	TR	KTC3875-GR	(1)	2216175R2
Q6702	TR	2SC2712-GR	1	2213145R2
Q6702 or	TR	KTC3875-GR	(1)	2216175R2
Q6703	TR	2SA1163-BL(TE85L_F)	1	2216756R2
Q6707	TR	2SC2712-GR	1	2213145R2
Q6707 or	TR	KTC3875-GR	(1)	2216175R2
Q6713	TR	2SA1163-BL(TE85L_F)	1	2216756R2
L5501	CHOKE COIL	LBC2518T2R2M	1	231364M022R2
C5503	UPZ C	2AUPZTF221JE	1	376332214T
C5504	UPZ C	2AUPZTF221JE	1	376332214T
C5507	C-CERA C	CC725CH1H-221J1	1	342102214R1
C5508	C-CERA C	CC725CH1H-221J1	1	342102214R1
C5509	C-CERA C	CC725CH1H-221J1	1	342102214R1
C5510	C-CERA C	CC725CH1H-221J1	1	342102214R1
C5513	C-CERA C	CC725CH1H-221J1	1	342102214R1

C5514	C-CERA C	CC725CH1H-221J1	1	342102214R1
C5517	C-CERA C	CC725CH1H-221J1	1	342102214R1
C5518	C-CERA C	CC725CH1H-221J1	1	342102214R1
C5519	UPZ C	2AUPZTF221JE	1	376332214T
C5520	UPZ C	2AUPZTF221JE	1	376332214T
C5527	C-CERA C	CC725CH1H-221J1	1	342102214R1
C5530	C-CERA C	CC725CH1H-221J1	1	342102214R1
C5531	C-CERA C	CC725CH1H-221J1	1	342102214R1
C5532	C-CERA C	CC725CH1H-221J1	1	342102214R1
C5550	UTSP C	CE04W10V-220M(UTSP)	1	397532217T
C5551	UTSP C	CE04W10V-220M(UTSP)	1	397532217T
C5552	UTSP C	CE04W10V-220M(UTSP)	1	397532217T
C5553	UTSP C	CE04W25V-47M(UTSP)	1	397554707T
C5554	UTSP C	CE04W25V-47M(UTSP)	1	397554707T
C5555	UTSP C	CE04W25V-47M(UTSP)	1	397554707T
C5556	UTSP C	CE04W25V-47M(UTSP)	1	397554707T
C5557	UTSP C	CE04W25V-47M(UTSP)	1	397554707T
C5560	UTSP C	CE04W50V 47M(UTSP)	1	397584707T
C5561	UTSP C	CE04W50V 47M(UTSP)	1	397584707T
C5562	TF C	ECQ-V50V-474J	1	374724744T
C5563	TF C	ECQ-V50V-823J	1	374728234T
C5564	TF C	ECQ-V50V-223J	1	374722234T
C5565	TF C	ECQ-V50V-474J	1	374724744T
C5566	TF C	ECQ-V50V-823J	1	374728234T
C5567	TF C	ECQ-V50V-223J	1	374722234T
C5570	UTSP C	CE04W50V 47M(UTSP)	1	397584707T
C5571	UTSP C	CE04W50V 47M(UTSP)	1	397584707T
C5572	UTSP C	CE04W50V 47M(UTSP)	1	397584707T
C5573	UTSP C	CE04W50V 47M(UTSP)	1	397584707T
C5574	UTSP C	CE04W50V 47M(UTSP)	1	397584707T
C5575	UTSP C	CE04W50V 47M(UTSP)	1	397584707T
C5576	UTSP C	CE04W50V 47M(UTSP)	1	397584707T
C5577	UTSP C	CE04W50V 47M(UTSP)	1	397584707T
C5585	UTSP C	CE04W50V 47M(UTSP)	1	397584707T
C5586	UTSP C	CE04W50V 47M(UTSP)	1	397584707T
C5590	C-CERA C	CC725CH1H-330J1	1	342103304R1
C5591	C-CERA C	CC725CH1H-330J1	1	342103304R1
C5600	UTSP C	CE04W50V 47M(UTSP)	1	397584707T
C5601	UTSP C	CE04W50V 47M(UTSP)	1	397584707T

C5602	UTSP C	CE04W50V 47M(UTSP)	1	397584707T	
C5603	UTSP C	CE04W50V 47M(UTSP)	1	397584707T	
C5604	UTSP C	CE04W50V 47M(UTSP)	1	397584707T	
C5605	UTSP C	CE04W50V 47M(UTSP)	1	397584707T	
C5606	UTSP C	CE04W50V 47M(UTSP)	1	397584707T	
C5607	UTSP C	CE04W50V 47M(UTSP)	1	397584707T	
C5608	UTSP C	CE04W50V 47M(UTSP)	1	397584707T	
C5609	UTSP C	CE04W50V 47M(UTSP)	1	397584707T	
C5611	C-CERA C	CC725CH1H-152J1	1	342101524R1	<MDC,MDD,MDF>
C5612	C-CERA C	CC725CH1H-152J1	1	342101524R1	<MDC,MDD,MDF>
C5616	C-CERA C	CK725F1E-104Z1	1	332161040R1	<MDC,MDD,MDF>
C5630	UTSP C	CE04W50V 47M(UTSP)	1	397584707T	
C5631	C-CERA C	CC725CH1H-221J1	1	342102214R1	
C5632	TF C	ECQ-V50V-103J	1	374721034T	
C5666	UTSP C	CE04W25V-220M(UTSP)	1	397552217T	
C5667	UTSP C	CE04W25V-220M(UTSP)	1	397552217T	
C5670	UTSP C	CE04W50V-10M(UTSP)	1	397581007T	
C5671	UTSP C	CE04W50V-10M(UTSP)	1	397581007T	
C5672	UTSP C	CE04W25V-220M(UTSP)	1	397552217T	
C5673	UTSP C	CE04W25V-220M(UTSP)	1	397552217T	
C5674	UTSP C	CE04W16V-470M(UTSP)	1	397544717T	
C5675	UTSP C	CE04W16V-470M(UTSP)	1	397544717T	
C5684	UTSP C	CE04W25V-220M(UTSP)	1	397552217T	
C5685	UTSP C	CE04W25V-220M(UTSP)	1	397552217T	
C5686	UTSP C	CE04W25V-220M(UTSP)	1	397552217T	
C5687	UTSP C	CE04W25V-220M(UTSP)	1	397552217T	
C5703	C-CERA C	CC725CH1H-102J1	1	342101024R1	
C5704	C-CERA C	CC725CH1H-102J1	1	342101024R1	
C5705	C-CERA C	CC725CH1H-102J1	1	342101024R1	
C5707	C-CERA C	CC725CH1H-221J1	1	342102214R1	
C5709	UTSP C	CE04W25V-47M(UTSP)	1	397554707T	
C5710	UTSP C	CE04W25V-47M(UTSP)	1	397554707T	
C5800	TF C	ECQ-V50V-334J	1	374723344T	
C5801	VR C	CE04W35V-1000M(VR)	1	394661027S	
C5802	VR C	CE04W35V-470M(VR)	1	394664717T	
C6050	TF C	ECQ-V50V-103J	1	374721034T	
C6051	TF C	ECQ-V50V-103J	1	374721034T	
C6052	TF C	ECQ-V50V-103J	1	374721034T	
C6053	TF C	ECQ-V50V-103J	1	374721034T	

C6054	TF C	ECQ-V50V-103J	1	374721034T	
C6055	TF C	ECQ-V50V-103J	1	374721034T	
C6056	TF C	ECQ-V50V-103J	1	374721034T	
C6630	C-CERA C	CK725F1E-104Z1	1	332161040R1	
C6701	UTSP C	CE04W25V-100M(UTSP)	1	397551017T	
C6703	C-CERA C	CK725F1H-104Z1	1	332151040R1	
C6704	UTSP C	CE04W50V-1M(UTSP)	1	397580107T	
C6706	UTSP C	CE04W50V-10M(UTSP)	1	397581007T	
C6713	C-CERA C	CK725F1H-104Z1	1	332151040R1	
C6714	UTSP C	CE04W50V-1M(UTSP)	1	397580107T	
C6901	ELECT C	CE69W63V-10000MA	1	3504417	<MDC,MDD,MDF>
C6901	ELECT C	CE69W69V-10000MA	1	3504425	<MMO,MMQ,MPA,MPB,MPP,MMR>
C6901A	IB CUSHION	W15*3t TAPE	1	28141585	
C6902	ELECT C	CE69W63V-10000MA	1	3504417	<MDC,MDD,MDF>
C6902	ELECT C	CE69W69V-10000MA	1	3504425	<MMO,MMQ,MPA,MPB,MPP,MMR>
C6911	C-CERA C	CC725CH1H-102J1	1	342101024R1	
C6912	TF C	ECQ-V100-334J	1	374733344T	
C6913	TF C	ECQ-V100-334J	1	374733344T	
C6915	TF C	ECQ-V50V-104J	1	374721044T	
C6916	TF C	ECQ-V50V-104J	1	374721044T	
C950	TF C	ECQ-V50V-104J	1	374721044T	
R5500	C-CARBON R	RN72K1J-331JE	1	435033314R1	
R5503	C-CARBON R	RN72K1J-331JE	1	435033314R1	
R5504	C-CARBON R	RN72K1J-331JE	1	435033314R1	
R5505	C-CARBON R	RN72K1J-222JE	1	435032224R1	
R5506	C-CARBON R	RN72K1J-222JE	1	435032224R1	
R5507	C-CARBON R	RN72K1J-331JE	1	435033314R1	
R5508	C-CARBON R	RN72K1J-331JE	1	435033314R1	
R5509	C-CARBON R	RN72K1J-331JE	1	435033314R1	
R5510	C-CARBON R	RN72K1J-331JE	1	435033314R1	
R5513	C-CARBON R	RN72K1J-331JE	1	435033314R1	
R5514	C-CARBON R	RN72K1J-331JE	1	435033314R1	
R5515	C-CARBON R	RN72K1J-222JE	1	435032224R1	
R5516	C-CARBON R	RN72K1J-222JE	1	435032224R1	
R5517	C-CARBON R	RN72K1J-331JE	1	435033314R1	
R5518	C-CARBON R	RN72K1J-331JE	1	435033314R1	
R5519	C-CARBON R	RN72K1J-331JE	1	435033314R1	
R5520	C-CARBON R	RN72K1J-331JE	1	435033314R1	
R5521	C-CARBON R	RN72K1J-000JE	1	435030004R1	<MDC,MDD,MDF>

R5528	C-CARBON R	RN72K1J-101JE	1	435031014R1	
R5530	C-CARBON R	RN72K1J-331JE	1	435033314R1	
R5531	C-CARBON R	RN72K1J-331JE	1	435033314R1	
R5532	C-CARBON R	RN72K1J-101JE	1	435031014R1	
R5543	C-CARBON R	RN72K1J-104JE	1	435031044R1	
R5544	C-CARBON R	RN72K1J-104JE	1	435031044R1	
R5545	C-CARBON R	RN72K1J-104JE	1	435031044R1	
R5546	C-CARBON R	RN72K1J-104JE	1	435031044R1	
R5547	C-CARBON R	RN72K1J-104JE	1	435031044R1	
R5548	C-CARBON R	RN72K1J-104JE	1	435031044R1	
R5549	C-CARBON R	RN72K1J-104JE	1	435031044R1	
R5550	C-CARBON R	RN72K1J-104JE	1	435031044R1	
R5553	C-CARBON R	RN72K1J-104JE	1	435031044R1	
R5554	C-CARBON R	RN72K1J-104JE	1	435031044R1	
R5555	C-CARBON R	RN72K1J-104JE	1	435031044R1	
R5556	C-CARBON R	RN72K1J-104JE	1	435031044R1	
R5557	C-CARBON R	RN72K1J-104JE	1	435031044R1	
R5558	C-CARBON R	RN72K1J-104JE	1	435031044R1	
R5559	C-CARBON R	RN72K1J-104JE	1	435031044R1	
R5560	C-CARBON R	RN72K1J-104JE	1	435031044R1	
R5561	C-CARBON R	RN72K1J-152JE	1	435031524R1	<MDC,MDD,MDF>
R5562	C-CARBON R	RN72K1J-152JE	1	435031524R1	<MDC,MDD,MDF>
R5563	C-CARBON R	RN72K1J-104JE	1	435031044R1	<MDC,MDD,MDF>
R5564	C-CARBON R	RN72K1J-104JE	1	435031044R1	<MDC,MDD,MDF>
R5565	C-CARBON R	RN72K1J-000JE	1	435030004R1	<MDC,MDD,MDF>
R5567	C-CARBON R	RN72K1J-473JE	1	435034734R1	
R5568	C-CARBON R	RN72K1J-473JE	1	435034734R1	
R5569	C-CARBON R	RN72K1J-104JE	1	435031044R1	
R5570	C-CARBON R	RN72K1J-222JE	1	435032224R1	
R5571	C-CARBON R	RN72K1J-222JE	1	435032224R1	
R5572	C-CARBON R	RN72K1J-222JE	1	435032224R1	
R5577	C-CARBON R	RN72K1J-223JE	1	435032234R1	
R5578	C-CARBON R	RN72K1J-473JE	1	435034734R1	
R5579	C-CARBON R	RN72K1J-473JE	1	435034734R1	
R5580	C-CARBON R	RN72K1J-104JE	1	435031044R1	
R5581	C-CARBON R	RN72K1J-104JE	1	435031044R1	
R5582	C-CARBON R	RN72K1J-104JE	1	435031044R1	
R5585	C-CARBON R	RN72K1J-182JE	1	435031824R1	
R5586	C-CARBON R	RN72K1J-182JE	1	435031824R1	

R5587	C-CARBON R	RN72K1J-103JE	1	435031034R1
R5588	C-CARBON R	RN72K1J-103JE	1	435031034R1
R5589	C-CARBON R	RN72K1J-000JE	1	435030004R1
R5590	C-CARBON R	RN72K1J-103JE	1	435031034R1
R5591	C-CARBON R	RN72K1J-103JE	1	435031034R1
R5592	C-CARBON R	RN72K1J-471JE	1	435034714R1
R5593	C-CARBON R	RN72K1J-122JE	1	435031224R1
R5594	C-CARBON R	RN72K1J-103JE	1	435031034R1
R5595	C-CARBON R	RN72K1J-103JE	1	435031034R1
R5596	C-CARBON R	RN72K1J-471JE	1	435034714R1
R5597	C-CARBON R	RN72K1J-122JE	1	435031224R1
R5598	C-CARBON R	RN72K1J-103JE	1	435031034R1
R5599	C-CARBON R	RN72K1J-103JE	1	435031034R1
R5600	C-CARBON R	RN72K1J-224JE	1	435032244R1
R5601	C-CARBON R	RN72K1J-224JE	1	435032244R1
R5602	C-CARBON R	RN72K1J-224JE	1	435032244R1
R5603	C-CARBON R	RN72K1J-224JE	1	435032244R1
R5604	C-CARBON R	RN72K1J-224JE	1	435032244R1
R5605	C-CARBON R	RN72K1J-224JE	1	435032244R1
R5606	C-CARBON R	RN72K1J-224JE	1	435032244R1
R5607	C-CARBON R	RN72K1J-224JE	1	435032244R1
R5608	C-CARBON R	RN72K1J-224JE	1	435032244R1
R5609	C-CARBON R	RN72K1J-224JE	1	435032244R1
R5610	C-CARBON R	RN72K1J-222JE	1	435032224R1
R5611	C-CARBON R	RN72K1J-222JE	1	435032224R1
R5612	C-CARBON R	RN72K1J-222JE	1	435032224R1
R5613	C-CARBON R	RN72K1J-222JE	1	435032224R1
R5614	C-CARBON R	RN72K1J-222JE	1	435032224R1
R5615	C-CARBON R	RN72K1J-222JE	1	435032224R1
R5616	C-CARBON R	RN72K1J-222JE	1	435032224R1
R5617	C-CARBON R	RN72K1J-271JE	1	435032714R1
R5618	C-CARBON R	RN72K1J-222JE	1	435032224R1
R5619	C-CARBON R	RN72K1J-222JE	1	435032224R1
R5620	C-CARBON R	RN72K1J-000JE	1	435030004R1
R5621	C-CARBON R	RN72K1J-000JE	1	435030004R1
R5622	C-CARBON R	RN72K1J-000JE	1	435030004R1
R5623	C-CARBON R	RN72K1J-000JE	1	435030004R1
R5624	C-CARBON R	RN72K1J-000JE	1	435030004R1
R5625	C-CARBON R	RN72K1J-000JE	1	435030004R1

R5626	C-CARBON R	RN72K1J-000JE	1	435030004R1	
R5627	C-CARBON R	RN72K1J-101JE	1	435031014R1	
R5630	C-CARBON R	RN72K1J-221JE	1	435032214R1	
R5631	C-CARBON R	RN72K1J-473JE	1	435034734R1	
R5632	C-CARBON R	RN72K1J-153JE	1	435031534R1	
R5633	C-CARBON R	RN72K1J-122JE	1	435031224R1	
R5634	C-CARBON R	RN72K1J-103JE	1	435031034R1	
R5660	METAL R	RNU1WCJ-2.2	1	453630224T	<MDC,MDD,MDF,MPA,MPB,MPP>
R5660	METAL R	RNU1WCJ-0.22	1	453632294T	<MMO,MMQ,MMR>
R5661	METAL R	RNU1WCJ-2.2	1	453630224T	<MDC,MDD,MDF,MPA,MPB,MPP>
R5661	METAL R	RNU1WCJ-0.22	1	453632294T	<MMO,MMQ,MMR>
R5666	CARBON R	R16J-22	1	417342204T	
R5667	CARBON R	R16J-22	1	417342204T	
R5670	METAL O R	RS2WBJ-10	1	441721004F	
R5671	METAL O R	RS2WBJ-22	1	441722204F	
R5672	METAL O R	RS2WBJ-10	1	441721004F	
R5673	METAL O R	RS2WBJ-22	1	441722204F	
R5674	METAL O R	RS1WBJ-100	1	443621014T	
R5675	METAL O R	RS1WBJ-100	1	443621014T	
R5680	C-CARBON R	RN72K1J-224JE	1	435032244R1	
R5681	C-CARBON R	RN72K1J-224JE	1	435032244R1	
R5682	C-CARBON R	RN72K1J-224JE	1	435032244R1	
R5684	CARBON R	R16J-1.2K	1	417341224T	
R5685	CARBON R	R16J-1.2K	1	417341224T	
R5689	C-CARBON R	RN72K1J-224JE	1	435032244R1	
R5690	C-CARBON R	RN72K1J-224JE	1	435032244R1	
R5692	C-CARBON R	RN72K1J-224JE	1	435032244R1	
R5693	C-CARBON R	RN72K1J-224JE	1	435032244R1	
R5694	C-CARBON R	RN72K1J-224JE	1	435032244R1	
R5695	C-CARBON R	RN72K1J-224JE	1	435032244R1	
R5696	C-CARBON R	RN72K1J-224JE	1	435032244R1	
R5700	C-CARBON R	RN72K1J-000JE	1	435030004R1	
R5701	C-CARBON R	RN72K1J-000JE	1	435030004R1	
R5702	C-CARBON R	RN72K1J-000JE	1	435030004R1	
R5703	C-CARBON R	RN72K1J-000JE	1	435030004R1	
R5704	C-CARBON R	RN72K1J-000JE	1	435030004R1	
R5705	C-CARBON R	RN72K1J-000JE	1	435030004R1	
R5706	C-CARBON R	RN72K1J-000JE	1	435030004R1	
R5707	C-CARBON R	RN72K1J-000JE	1	435030004R1	

R5711	C-CARBON R	RN72K1J-000JE	1	435030004R1	
R5720	C-CARBON R	RN72K1J-000JE	1	435030004R1	
R5721	C-CARBON R	RN72K1J-000JE	1	435030004R1	
R5722	C-CARBON R	RN72K1J-000JE	1	435030004R1	
R5723	C-CARBON R	RN72K1J-000JE	1	435030004R1	
R5724	C-CARBON R	RN72K1J-000JE	1	435030004R1	
R5725	C-CARBON R	RN72K1J-000JE	1	435030004R1	
R5726	C-CARBON R	RN72K1J-000JE	1	435030004R1	
R5727	C-CARBON R	RN72K1J-000JE	1	435030004R1	
R5728	C-CARBON R	RN72K1J-000JE	1	435030004R1	
R5729	C-CARBON R	RN72K1J-000JE	1	435030004R1	
R5730	C-CARBON R	RN72K1J-000JE	1	435030004R1	
R5731	C-CARBON R	RN72K1J-000JE	1	435030004R1	
R5732	C-CARBON R	RN72K1J-000JE	1	435030004R1	
R5735	C-CARBON R	RN72K1J-000JE	1	435030004R1	<MDC,MDD,MDF>
R5802	C-CARBON R	RN72K1J-512JE	1	435035124R1	
R5803	C-CARBON R	RN72K1J-512JE	1	435035124R1	
R5804	C-CARBON R	RN72K1J-512JE	1	435035124R1	
R5805	C-CARBON R	RN72K1J-512JE	1	435035124R1	
R5806	C-CARBON R	RN72K1J-512JE	1	435035124R1	
R5807	C-CARBON R	RN72K1J-512JE	1	435035124R1	
R6000	C-CARBON R	RN72K1J-562JE	1	435035624R1	
R6001	C-CARBON R	RN72K1J-562JE	1	435035624R1	
R6002	C-CARBON R	RN72K1J-562JE	1	435035624R1	
R6003	C-CARBON R	RN72K1J-562JE	1	435035624R1	
R6004	C-CARBON R	RN72K1J-562JE	1	435035624R1	
R6005	C-CARBON R	RN72K1J-562JE	1	435035624R1	
R6006	C-CARBON R	RN72K1J-562JE	1	435035624R1	
R6010	C-CARBON R	RN72K1J-392JE	1	435033924R1	
R6011	C-CARBON R	RN72K1J-392JE	1	435033924R1	
R6012	C-CARBON R	RN72K1J-392JE	1	435033924R1	
R6013	C-CARBON R	RN72K1J-392JE	1	435033924R1	
R6014	C-CARBON R	RN72K1J-392JE	1	435033924R1	
R6015	C-CARBON R	RN72K1J-392JE	1	435033924R1	
R6016	C-CARBON R	RN72K1J-392JE	1	435033924R1	
R6030	C-CARBON R	RN72K1J-471JE	1	435034714R1	
R6031	C-CARBON R	RN72K1J-471JE	1	435034714R1	
R6032	C-CARBON R	RN72K1J-471JE	1	435034714R1	
R6033	C-CARBON R	RN72K1J-471JE	1	435034714R1	

R6034	C-CARBON R	RN72K1J-471JE	1	435034714R1
R6035	C-CARBON R	RN72K1J-471JE	1	435034714R1
R6036	C-CARBON R	RN72K1J-471JE	1	435034714R1
R6080	NF CARBON R	R25J-0.22	1	415472294T
R6081	NF CARBON R	R25J-0.22	1	415472294T
R6082	NF CARBON R	R25J-0.22	1	415472294T
R6083	NF CARBON R	R25J-0.22	1	415472294T
R6084	NF CARBON R	R25J-0.22	1	415472294T
R6085	NF CARBON R	R25J-0.22	1	415472294T
R6086	NF CARBON R	R25J-0.22	1	415472294T
R6090	NF CARBON R	R25J-0.22	1	415472294T
R6091	NF CARBON R	R25J-0.22	1	415472294T
R6092	NF CARBON R	R25J-0.22	1	415472294T
R6093	NF CARBON R	R25J-0.22	1	415472294T
R6094	NF CARBON R	R25J-0.22	1	415472294T
R6095	NF CARBON R	R25J-0.22	1	415472294T
R6096	NF CARBON R	R25J-0.22	1	415472294T
R6100	METAL PR	MPR5W+5W 0R22	1	4000233
R6101	METAL PR	MPR5W+5W 0R22	1	4000233
R6102	METAL PR	MPR5W+5W 0R22	1	4000233
R6103	METAL PR	MPR5W+5W 0R22	1	4000233
R6104	METAL PR	MPR5W+5W 0R22	1	4000233
R6105	METAL PR	MPR5W+5W 0R22	1	4000233
R6106	METAL PR	MPR5W+5W 0R22	1	4000233
R6140	C-CARBON R	RN72K1J-563JE	1	435035634R1
R6141	C-CARBON R	RN72K1J-563JE	1	435035634R1
R6142	C-CARBON R	RN72K1J-563JE	1	435035634R1
R6143	C-CARBON R	RN72K1J-563JE	1	435035634R1
R6144	C-CARBON R	RN72K1J-563JE	1	435035634R1
R6145	C-CARBON R	RN72K1J-563JE	1	435035634R1
R6146	C-CARBON R	RN72K1J-563JE	1	435035634R1
R6150	C-CARBON R	RN72K1J-103JE	1	435031034R1
R6151	C-CARBON R	RN72K1J-103JE	1	435031034R1
R6152	C-CARBON R	RN72K1J-103JE	1	435031034R1
R6153	C-CARBON R	RN72K1J-103JE	1	435031034R1
R6154	C-CARBON R	RN72K1J-103JE	1	435031034R1
R6155	C-CARBON R	RN72K1J-103JE	1	435031034R1
R6156	C-CARBON R	RN72K1J-103JE	1	435031034R1
R6160	CARBON R	R16J-33K	1	417343334T

R6161	CARBON R	R16J-33K	1	417343334T
R6162	CARBON R	R16J-33K	1	417343334T
R6163	CARBON R	R16J-33K	1	417343334T
R6164	CARBON R	R16J-33K	1	417343334T
R6165	CARBON R	R16J-33K	1	417343334T
R6166	CARBON R	R16J-33K	1	417343334T
R6170	CARBON R	R16J-47K	1	417344734T
R6171	CARBON R	R16J-47K	1	417344734T
R6172	CARBON R	R16J-47K	1	417344734T
R6173	CARBON R	R16J-47K	1	417344734T
R6174	CARBON R	R16J-47K	1	417344734T
R6175	CARBON R	R16J-47K	1	417344734T
R6176	CARBON R	R16J-47K	1	417344734T
R6180	CARBON R	R16J-47K	1	417344734T
R6181	CARBON R	R16J-47K	1	417344734T
R6182	CARBON R	R16J-47K	1	417344734T
R6183	CARBON R	R16J-47K	1	417344734T
R6184	CARBON R	R16J-47K	1	417344734T
R6185	CARBON R	R16J-47K	1	417344734T
R6186	CARBON R	R16J-47K	1	417344734T
R6197	METAL R	RNU1WCJ-8.2	1	453630824T
R6300	C-CARBON R	RN72K1J-000JE	1	435030004R1
R6301	C-CARBON R	RN72K1J-000JE	1	435030004R1
R6305	C-CARBON R	RN72K1J-000JE	1	435030004R1
R6701	C-CARBON R	RN72K1J-223JE	1	435032234R1
R6702	C-CARBON R	RN72K1J-103JE	1	435031034R1
R6704	C-CARBON R	RN72K1J-473JE	1	435034734R1
R6706	C-CARBON R	RN72K1J-224JE	1	435032244R1
R6708	C-CARBON R	RN72K1J-333JE	1	435033334R1
R6709	C-CARBON R	RN72K1J-562JE	1	435035624R1
R6710	C-CARBON R	RN72K1J-472JE	1	435034724R1
R6712	C-CARBON R	RN72K1J-103JE	1	435031034R1
R6714	C-CARBON R	RN72K1J-473JE	1	435034734R1
R6716	C-CARBON R	RN72K1J-224JE	1	435032244R1
R6902	C-CARBON R	RN72K1J-102JE	1	435031024R1
R6903	C-CARBON R	RN72K1J-473JE	1	435034734R1
R950	METAL R	RNU1/2WCJ-8.2	1	453530824T
F6901A	FUSE HOLDER	SN5051	1	250113
F6901B	FUSE HOLDER	SN5051	1	250113

F6902A	FUSE HOLDER	SN5051	1	250113	
F6902B	FUSE HOLDER	SN5051	1	250113	
F910A	FUSE HOL	NSCT-1P2031	1	25052133T	
F910B	FUSE HOL	NSCT-1P2031	1	25052133T	
JL5501A	WIRE HOL	NSCT-3P874	1	25051087	
JL5502A	WIRE HOL	NSCT-5P876	1	25051089	
JL6600A	WIRE HOL	NSCT-7P898	1	25051111	
JL6603A	WIRE HOL	NSCT-9P900	1	25051113	
JL6604A	WIRE HOL	NSCT-5P896	1	25051109	<MDC,MDD,MDF>
JL6620A	WIRE HOL	NSCT-7P878	1	25051091	
JL6952A	WIRE HOL	NSCT-5P896	1	25051109	
JL6952B	WIRE HOL	NSCT-5P896	1	25051109	
JL9101A	WIRE HOL	NSCT-7P898	1	25051111	
P001	PWB	BCAF-0014	1	25140014C	N
P002	PWB	BCPS-0015	{ 1 }	25140015	N
P003	PWB	BCPS-0016	{ 1 }	25140016	N
P004	PWB	BCETC-0017	{ 1 }	25140017	N
P005	PWB	BCETC-0018	{ 1 }	25140018	N
P006	PWB	BCETC-0019	{ 1 }	25140019	N
P5501B	PLUG	NPLG-7P0962	1	25056012	
P5502B	PLUG	NPLG-15P0970	1	25056020	
P5503B	PLUG	NPLG-9P0964	1	25056014	
P5504B	PLUG	NPLG-7P0962	1	25056012	
P5505	CRIMP AS	CRIMP AS	1	2069955200UL	
P5507	TRM	NTM-1P232(M1700)	1	25060301	
P5509	TRM	NTM-1P232(M1700)	1	25060301	
P5510	TRM-423(SCREW)	NEJITANSI ST3	1	25060495	
P6000B	PLUG	NPLG-9P0964	1	25056014	
P6001B	PLUG	NPLG-9P0964	1	25056014	
P6002B	PLUG	NPLG-3P0958	1	25056008	
P6003B	PLUG	NPLG-9P0964	1	25056014	
P6004B	PLUG	NPLG-9P0964	1	25056014	
P6005B	PLUG	NPLG-9P0964	1	25056014	
P6006B	PLUG	NPLG-9P0964	1	25056014	
P6010	TRM	NTM-1P232(M1700)	1	25060301	
P6011A	RETAINER	(BUS-D)TX-SR606	1	27142100	
P6012B	PLUG	NPLG-7P0962	1	25056012	
P6080	PLUG	NPLG-2P29	1	25055038	
P6081	PLUG	NPLG-2P29	1	25055038	

P6082	PLUG	NPLG-2P29	1	25055038	
P6083	PLUG	NPLG-2P29	1	25055038	
P6084	PLUG	NPLG-2P29	1	25055038	
P6085	PLUG	NPLG-2P29	1	25055038	
P6086	PLUG	NPLG-2P29	1	25055038	
P6100	HOLDER	HOLDER(CLAMP)	1	27190540-1	
P6101	HOLDER	(CRAMP) UA-0 V0	1	27190608-1	
P6102	HOLDER	(CRAMP) UA-0 V0	1	27190608-1	
P6600A	SOCKET AS	NSAS-26P1775	1	2009991135UL	
P6602	TRM	NTM-4PDML422	1	25060494	<MDC,MDD,MDF>
P6605	WS CLAMP	CB-71683(L=50)	1	260261	
P6606	WS CLAMP	CB-71683(L=50)	1	260261	
P6900	CRIMP AS	UL1015#18SIN-SVH 300 BLK	1	20799177UL	
P6901	CRIMP AS	CRIMP AS	1	2069925119UL	
P6902	CRIMP AS	CRIMP AS	1	2069925188UL	
P6903	CRIMP AS	UL1015#18SIN-SVH 200 YEL	1	20799172UL	
P6904	CRIMP AS	UL1015#18SIN-SVH 200 GRN	1	20799173UL	
P7900	ST JACK	MSJ-035-22	1	25045887	
P7900 or	JACK	YKB21-5130	(1)	25045387	
P7902	PIN JACK	NPJ-4PDWR690	1	25045922	
P7903	PIN JACK	NPJ-4PDWWRR624	1	25045845	
P7903 or	PIN JACK	NPJ-4PDBL162	(1)	25045303	
P7904	PIN JACK	NPJ-4PDWWRR624	1	25045845	
P7904 or	PIN JACK	NPJ-4PDBL162	(1)	25045303	
P7905	PIN JACK	NPJ-4PDWWRR624	1	25045845	
P7905 or	PIN JACK	NPJ-4PDBL162	(1)	25045303	
P7906	SOCKET	2MJ-3516-002	1	25053355	<MDC,MDD,MDF>
P7907	PIN JACK	NPJ-4PDWRP682	1	25045914	N
RL.6901	RELAY	NRL-1P10A-DC12-140	1	25065584	
RL.6901 or	RELAY	NRL-1P10A-DC12-143	(1)	25065588	
RL.6902	RELAY	NRL-1P10A-DC12-140	1	25065584	
RL.6902 or	RELAY	NRL-1P10A-DC12-143	(1)	25065588	

U002 MPU/CODEC pc board AS (BADG-0025-1A/1B/1C)

U0021 Universal port pc board AS (BAETC-0027-1A/1B/1C)

CIRCUIT NO.	PART NAME	DESCRIPTION	Q'TY	PART NO. (SN)	REMARKS
U131	PHT CP	JSR1165-001recieving	1	24120143	
U131 or	PHT CP	GP1FAV51RK0F	(1)	24120129	

U132	PHT CP	JSR1165-001recieving	1	24120143	
U132 or	PHT CP	GP1FAV51RK0F	(1)	24120129	
D110	C-DIODE	KDS4148U	1	223283R2	
D110 or	C-DIODE	1SS352	(1)	223234R2	
D110 or	C-DIODE	MA2J111	(1)	223279R2	
D111	C-DIODE	KDS4148U	1	223283R2	
D111 or	C-DIODE	1SS352	(1)	223234R2	
D111 or	C-DIODE	MA2J111	(1)	223279R2	
D112	ZENER D	UDZS10B	1	224551000R2	
D131	C-DIODE	KDS4148U	1	223283R2	
D131 or	C-DIODE	1SS352	(1)	223234R2	
D131 or	C-DIODE	MA2J111	(1)	223279R2	
D132	C-DIODE	KDS4148U	1	223283R2	
D132 or	C-DIODE	1SS352	(1)	223234R2	
D132 or	C-DIODE	MA2J111	(1)	223279R2	
D181	C-DIODE	KDS4148U	1	223283R2	
D181 or	C-DIODE	1SS352	(1)	223234R2	
D181 or	C-DIODE	MA2J111	(1)	223279R2	
D182	C-DIODE	KDS4148U	1	223283R2	
D182 or	C-DIODE	1SS352	(1)	223234R2	
D182 or	C-DIODE	MA2J111	(1)	223279R2	
D183	DIODE	RL1N4003	1	22380260T	
D601	C-DIODE	KDS4148U	1	223283R2	
D601 or	C-DIODE	1SS352	(1)	223234R2	
D601 or	C-DIODE	MA2J111	(1)	223279R2	
D701	C-DIODE	KDS4148U	1	223283R2	
D701 or	C-DIODE	1SS352	(1)	223234R2	
D701 or	C-DIODE	MA2J111	(1)	223279R2	
D702	C-DIODE	KDS4148U	1	223283R2	
D702 or	C-DIODE	1SS352	(1)	223234R2	
D702 or	C-DIODE	MA2J111	(1)	223279R2	
Q101	IC	LC72725KV-TLM-E	1	22242584R2	<MPB,MPP>
Q111	TR	2SC2235-Y(TPE6_F)	1	2211654T	
Q131	IC	74HCU04F	1	222740046R2	
Q131 or	IC	TC74HCU04AF	(1)	222740046R2TO	
Q153	IC	R1EX25064ASA00A	1	22242581R2	N
Q171	IC	TC7WU04FU(TE12L_F)	1	22240935R2	
Q181	TR	KRC105S	1	2217290R2	
Q181 or	TR	RN1405	(1)	2214500R2	

Q301	IC	CS42518-CQZR-D	1	22242229R2
Q302	IC	TC74VHC157FT	1	22274157ER2TO
Q400	IC	NJM4580M-D	1	22241448R2
Q401	IC	NJM4580M-D	1	22241448R2
Q402	IC	NJM4580M-D	1	22241448R2
Q403	IC	NJM4580M-D	1	22241448R2
Q404	IC	NJM4580M-D	1	22241448R2
Q601	TR	KRC104S	1	2216210R2
Q601 or	TR	RN1404	(1)	2214490R2
Q701	IC (MAIN MICROPROCESSOR)	MPD70F3746GJ-GAE-AX(0301)	1	222W0079R303010
Q702	IC	S-812C33AUA-C2N	1	22242222R2
Q703	IC	S-812C56AUA-C3K	1	22242207R2
Q746	IC	BH33FB1WG-TR	1	22242585R2
Q751	TR	KRC104S	1	2216210R2
Q751 or	TR	RN1404	(1)	2214490R2
Q752	TR	KRA102S	1	2216220R2
Q752 or	TR	RN2402	(1)	2214530R2
Q753	TR	KRA107S	1	2216350R2
Q753 or	TR	RN2407(TE85L_F)	(1)	2216360R2
Q754	TR	KRC102S	1	2216190R2
Q754 or	TR	RN1402	(1)	2214470R2
Q755	TR	KRA107S	1	2216350R2
Q755 or	TR	RN2407(TE85L_F)	(1)	2216360R2
Q756	TR	KRC102S	1	2216190R2
Q756 or	TR	RN1402	(1)	2214470R2
Q757	TR	KRC107S	1	2216340R2
Q757 or	TR	RN1407	(1)	2216260R2
Q761	TR	KRC104S	1	2216210R2
Q761 or	TR	RN1404	(1)	2214490R2
Q762	TR	KRA102S	1	2216220R2
Q762 or	TR	RN2402	(1)	2214530R2
Q771	TR	KRC104S	1	2216210R2
Q771 or	TR	RN1404	(1)	2214490R2
Q772	TR	KRA102S	1	2216220R2
Q772 or	TR	RN2402	(1)	2214530R2
L101	CORE	BLM18PG181SN1D	1	2350005R1
L131	CHOKE COIL	LBC2518T2R2M	1	231364M022R2
L132	CHOKE COIL	LBC2518T2R2M	1	231364M022R2
L133	CHOKE COIL	LBC2518T470M	1	231364M470R2

L134	CHOKE COIL	LBC2518T470M	1	231364M470R2
L153	CORE	BLM18PG181SN1D	1	2350005R1
L171	CHOKE COIL	LBC2518T470M	1	231364M470R2
L173	EMIFIL	BK1608LM182-T	1	230958R1
L2100	CORE	BLM18PG181SN1D	1	2350005R1
L2101	CORE	BLM18PG181SN1D	1	2350005R1
L2102	CORE	BLM18PG181SN1D	1	2350005R1
L2103	EMIFIL	BK1608LM182-T	1	230958R1
L2104	EMIFIL	BK1608LM182-T	1	230958R1
L2105	EMIFIL	BK1608LM182-T	1	230958R1
L2106	EMIFIL	BK1608LM182-T	1	230958R1
L2107	EMIFIL	BK1608LM182-T	1	230958R1
L2108	EMIFIL	BK1608LM182-T	1	230958R1
L2109	EMIFIL	BK1608LM182-T	1	230958R1
L2110	EMIFIL	BK1608LM182-T	1	230958R1
L2111	EMIFIL	BK1608LM182-T	1	230958R1
L2112	EMIFIL	BK1608LM182-T	1	230958R1
L2113	EMIFIL	BK1608LM182-T	1	230958R1
L2114	EMIFIL	BK1608LM182-T	1	230958R1
L2115	EMIFIL	BK1608LM182-T	1	230958R1
L301	CHOKE COIL	BLM21PG221SN1	1	230949R2
L302	CORE	BLM18PG181SN1D	1	2350005R1
L303	CHOKE COIL	LBC2518T4R7M	1	231364M047R2
L304	CHOKE COIL	BLM21PG221SN1	1	230949R2
L305	CORE	BLM18PG181SN1D	1	2350005R1
L306	CHOKE COIL	LBC2518T4R7M	1	231364M047R2
L307	CHOKE COIL	LBC2518T4R7M	1	231364M047R2
L311	EMIFIL	BK1608LM182-T	1	230958R1
L313	EMIFIL	BK1608LM182-T	1	230958R1
L322	EMIFIL	BK1608LM182-T	1	230958R1
L500	CORE	BLM18PG181SN1D	1	2350005R1
L741	CORE	BLM18PG181SN1D	1	2350005R1
L742	CHOKE COIL	BLM21PG221SN1	1	230949R2
L743	CORE	BLM18PG181SN1D	1	2350005R1
L744	CORE	BLM18PG181SN1D	1	2350005R1
L746	CORE	BLM18PG181SN1D	1	2350005R1
L747	CORE	BLM18PG181SN1D	1	2350005R1
C101	UTSP C	CE04W25V-100M(UTSP)	1	397551017T
C102	C-CERA C	CK725F1E-104Z1	1	332161040R1

C103	UTSP C	CE04W50V-10M(UTSP)	1	397581007T	<MPB.MPP>
C104	UTSP C	CE04W50V-10M(UTSP)	1	397581007T	<MPB.MPP>
C105	C-CERA C	CK725F1E-104Z1	1	332161040R1	<MPB.MPP>
C106	C-CERA C	CC725CH1H-331J1	1	342103314R1	<MPB.MPP>
C107	C-CERA C	CK725F1E-104Z1	1	332161040R1	<MPB.MPP>
C108	C-CERA C	CC725CH1H-150J1	1	342101504R1	<MPB.MPP>
C109	C-CERA C	CC725CH1H-150J1	1	342101504R1	<MPB.MPP>
C110	C-CERA C	CC725CH1H-331J1	1	342103314R1	<MPB.MPP>
C111	UTSP C	CE04W50V-47M(UTSP)	1	397584707T	
C112	C-CERA C	CK725F1E-104Z1	1	332161040R1	
C113	C-CERA C	CC725CH1H-221J1	1	342102214R1	<MPB.MPP>
C130	C-CERA C	CK725F1E-104Z1	1	332161040R1	
C131	C-CERA C	CC725CH1H-101J1	1	342101014R1	
C132	C-CERA C	CC725CH1H-101J1	1	342101014R1	
C133	C-CERA C	CK725B1C-104K1	1	332121045R1	
C134	C-CERA C	CK725B1C-104K1	1	332121045R1	
C135	C-CERA C	CC725CH1H-080D1	1	342100802R1	
C136	C-CERA C	CC725CH1H-080D1	1	342100802R1	
C139	UTSP C	CE04W10V-220M(UTSP)	1	397532217T	
C140	C-CERA C	CK725F1E-104Z1	1	332161040R1	
C141	C-CERA C	CK725F1E-104Z1	1	332161040R1	
C142	C-CERA C	CK725F1E-104Z1	1	332161040R1	
C145	UTSP C	CE04W10V-220M(UTSP)	1	397532217T	
C151	C-CERA C	CK725F1E-104Z1	1	332161040R1	
C171	C-CERA C	CK725F1E-104Z1	1	332161040R1	
C172	C-CERA C	CC725CH1H-100D1	1	342101002R1	
C173	C-CERA C	CC725CH1H-100D1	1	342101002R1	
C2150	C-CERA C	CC725CH1H-471J1	1	342104714R1	
C2151	C-CERA C	CC725CH1H-471J1	1	342104714R1	
C2152	C-CERA C	CC725CH1H-470J1	1	342104704R1	
C2155	C-CERA C	CK725F1E-104Z1	1	332161040R1	
C300	UTSP C	CE04W10V-470M(UTSP)	1	397534717T	
C301	C-CERA C	CK725B1H-103K1	1	332101035R1	
C302	UTSP C	CE04W10V-470M(UTSP)	1	397534717T	
C303	UTSP C	CE04W10V-470M(UTSP)	1	397534717T	
C304	UTSP C	CE04W10V-470M(UTSP)	1	397534717T	
C305	C-CERA C	CK725F1E-104Z1	1	332161040R1	
C306	UTSJ C	CE04W25V-47M(UTSJ)	1	398054707T	
C307	C-CERA C	CK725F1E-104Z1	1	332161040R1	

C308	UTSP C	CE04W25V-100M(UTSP)	1	397551017T
C309	C-CERA C	CK725F1E-104Z1	1	332161040R1
C310	C-CERA C	CC725CH1H-102J1	1	342101024R1
C311	C-CERA C	CK725B1H-223K1	1	332102235R1
C312	C-CERA C	CK725F1E-104Z1	1	332161040R1
C313	C-CERA C	CK725F1E-104Z1	1	332161040R1
C314	C-CERA C	CK725F1E-104Z1	1	332161040R1
C315	C-CERA C	CK725F1E-104Z1	1	332161040R1
C316	C-CERA C	CC725CH1H-221J1	1	342102214R1
C317	C-CERA C	CK725F1E-104Z1	1	332161040R1
C318	C-CERA C	CK725F1E-104Z1	1	332161040R1
C319	C-CERA C	CK725F1E-104Z1	1	332161040R1
C320	UTSP C	CE04W50V 47M(UTSP)	1	397584707T
C321	UTSP C	CE04W50V 47M(UTSP)	1	397584707T
C322	C-CERA C	CK725F1E-104Z1	1	332161040R1
C330	UTSP C	CE04W50V 47M(UTSP)	1	397584707T
C331	UTSP C	CE04W50V 47M(UTSP)	1	397584707T
C333	C-CERA C	CC725CH1H-330J1	1	342103304R1
C334	C-CERA C	CC725CH1H-330J1	1	342103304R1
C336	C-CERA C	CC725CH1H-330J1	1	342103304R1
C337	C-CERA C	CC725CH1H-330J1	1	342103304R1
C340	C-CERA C	CC732CH1H-222J	1	347342224R2
C341	C-CERA C	CC732CH1H-222J	1	347342224R2
C350	C-CERA C	CC725CH1H-101J1	1	342101014R1
C351	C-CERA C	CC725CH1H-101J1	1	342101014R1
C400	MKT C	B32529C0222J289	1	376492224T
C401	MKT C	B32529C0222J289	1	376492224T
C402	MKT C	B32529C0222J289	1	376492224T
C403	MKT C	B32529C0222J289	1	376492224T
C404	MKT C	B32529C0222J289	1	376492224T
C405	MKT C	B32529C0222J289	1	376492224T
C406	MKT C	B32529C0222J289	1	376492224T
C407	TF C	ECQ-V50V-333J	1	374723334T
C408	UTSP C	CE04W25V-220M(UTSP)	1	397552217T
C409	UTSP C	CE04W25V-220M(UTSP)	1	397552217T
C410	UPZ C	2AUPZTF331JE	1	376333314T
C411	UPZ C	2AUPZTF331JE	1	376333314T
C412	UPZ C	2AUPZTF331JE	1	376333314T
C413	C-CERA C	CC725CH1H-331J1	1	342103314R1

C414	C-CERA C	CC725CH1H-331J1	1	342103314R1
C415	C-CERA C	CC725CH1H-331J1	1	342103314R1
C416	C-CERA C	CC725CH1H-331J1	1	342103314R1
C417	TF C	ECQ-V50V-333J	1	374723334T
C420	UPZ C	2AUPZTF331JE	1	376333314T
C421	UPZ C	2AUPZTF331JE	1	376333314T
C422	UPZ C	2AUPZTF331JE	1	376333314T
C423	C-CERA C	CC725CH1H-331J1	1	342103314R1
C424	C-CERA C	CC725CH1H-331J1	1	342103314R1
C425	C-CERA C	CC725CH1H-331J1	1	342103314R1
C426	C-CERA C	CC725CH1H-331J1	1	342103314R1
C427	TF C	ECQ-V50V-333J	1	374723334T
C501	C-CERA C	CK725F1E-104Z1	1	332161040R1
C502	C-CERA C	CK725F1E-104Z1	1	332161040R1
C503	C-CERA C	CK725F1E-104Z1	1	332161040R1
C504	UTSP C	CE04W50V-4.7M(UTSP)	1	397580477T
C505	C-CERA C	CK725F1E-104Z1	1	332161040R1
C506	C-CERA C	CK725F1E-104Z1	1	332161040R1
C507	C-CERA C	CK725F1E-104Z1	1	332161040R1
C508	C-CERA C	CC725CH1H-101J1	1	342101014R1
C509	C-CERA C	CC725CH1H-101J1	1	342101014R1
C510	C-CERA C	CC725CH1H-101J1	1	342101014R1
C511	C-CERA C	CC725CH1H-101J1	1	342101014R1
C512	C-CERA C	CK725B1H-102K1	1	332101025R1
C514	C-CERA C	CK725B1H-102K1	1	332101025R1
C515	C-CERA C	CK725F1E-104Z1	1	332161040R1
C516	C-CERA C	CK725B1H-102K1	1	332101025R1
C517	C-CERA C	CC725CH1H-101J1	1	342101014R1
C518	C-CERA C	CC725CH1H-101J1	1	342101014R1
C519	C-CERA C	CK725B1H-102K1	1	332101025R1
C520	C-CERA C	CK725B1H-102K1	1	332101025R1
C521	C-CERA C	CK725B1H-102K1	1	332101025R1
C522	C-CERA C	CK725B1H-102K1	1	332101025R1
C523	C-CERA C	CK725B1H-102K1	1	332101025R1
C524	C-CERA C	CK725B1H-102K1	1	332101025R1
C525	C-CERA C	CC725CH1H-101J1	1	342101014R1
C526	C-CERA C	CC725CH1H-101J1	1	342101014R1
C527	C-CERA C	CK725F1E-104Z1	1	332161040R1
C551	C-CERA C	CK725F1E-104Z1	1	332161040R1

C552	C-CERA C	CK725F1E-104Z1	1	332161040R1	
C553	C-CERA C	CK725B1H-102K1	1	332101025R1	
C554	C-CERA C	CK725B1H-102K1	1	332101025R1	
C604	UTSP C	CE04W50V-4.7M(UTSP)	1	397580477T	
C613	C-CERA C	CK732B1A-105K	1	337361055R2	
C625	C-CERA C	CK725F1E-104Z1	1	332161040R1	
C629	C-CERA C	CK725F1E-104Z1	1	332161040R1	
C701	C-CERA C	CK725F1E-104Z1	1	332161040R1	
C702	UTSP C	CE04W10V-100M(UTSP)	1	397531017T	
C705	UTSP C	CE04W10V-100M(UTSP)	1	397531017T	
C706	UTSP C	CE04W16V-470M(UTSP)	1	397544717T	
C707	UTSP C	CE04W10V-100M(UTSP)	1	397531017T	
C708	UTSP C	CE04W10V-100M(UTSP)	1	397531017T	
C709	C-CERA C	CK725F1E-104Z1	1	332161040R1	
C744	C-CERA C	CK725F1E-104Z1	1	332161040R1	
C745	C-CERA C	CK725B0J-106K	1	332091065R2	
C747	UTSP C	CE04W50V-10M(UTSP)	1	397581007T	
C751	UTSP C	CE04W50V-0.47M(UTSP)	1	397584797T	
C753	UTSP C	CE04W16V-470M(UTSP)	1	397544717T	
C761	UTSP C	CE04W50V-0.47M(UTSP)	1	397584797T	
C762	C-CERA C	CK732B1A-105K	1	337361055R2	
C771	UTSP C	CE04W50V-0.47M(UTSP)	1	397584797T	
C772	C-CERA C	CK732B1A-105K	1	337361055R2	
C800	C-CERA C	CK725F1E-104Z1	1	332161040R1	
C801	C-CERA C	CK725B1H-103K1	1	332101035R1	
C802	C-CERA C	CK725F1E-104Z1	1	332161040R1	
C803	C-CERA C	CK725B1H-103K1	1	332101035R1	
X101	CRYSTAL	HC-49S 4.332MHz	1	3010469T	<MPB,MPP>
X171	CRYSTAL	HC-49US24.576MHz	1	3010423T	
X171 or	CRYSTAL	HC-49/U03-24.576M	(1)	3010314T	
X171A	CUSHION	(BUTYL)	1	28141748	
X701	CERA LOCK	CSTCR5M00G53-B0	1	3010356R2	
R101	METAL O R	RS1/2WBJ-10	1	443521004T	
R107	C-CARBON R	RN72K1J-101JE	1	435031014R1	<MPB,MPP>
R108	C-CARBON R	RN72K1J-101JE	1	435031014R1	<MPB,MPP>
R110	C-CARBON R	RN72K1J-103JE	1	435031034R1	
R111	C-CARBON R	RN72K1J-105JE	1	435031054R1	
R112	METAL O R	RS1WBJ-22	1	443622204T	
R113	C-CARBON R	RN72K1J-221JE	1	435032214R1	

R114	C-CARBON R	RN72K1J-221JE	1	435032214R1	
R115	C-CARBON R	RN72K1J-333JE	1	435033334R1	
R131	C-CARBON R	RN72K1J-750JE	1	435037504R1	
R132	C-CARBON R	RN72K1J-750JE	1	435037504R1	
R133	C-CARBON R	RN72K1J-100JE	1	435031004R1	
R134	C-CARBON R	RN72K1J-100JE	1	435031004R1	
R135	C-CARBON R	RN72K1J-224JE	1	435032244R1	
R136	C-CARBON R	RN72K1J-224JE	1	435032244R1	
R137	C-CARBON R	RN72K1J-103JE	1	435031034R1	
R138	C-CARBON R	RN72K1J-103JE	1	435031034R1	
R139	C-CARBON R	RN72K1J-823JE	1	435038234R1	
R140	C-CARBON R	RN72K1J-823JE	1	435038234R1	
R141	C-CARBON R	RN72K1J-470JE	1	435034704R1	
R142	C-CARBON R	RN72K1J-470JE	1	435034704R1	
R151	C-CARBON R	RN72K1J-103JE	1	435031034R1	
R152	C-CARBON R	RN72K1J-103JE	1	435031034R1	
R153	C-CARBON R	RN72K1J-222JE	1	435032224R1	
R154	C-CARBON R	RN72K1J-103JE	1	435031034R1	
R171	C-CARBON R	RN72K1J-105JE	1	435031054R1	
R173	C-CARBON R	RN72K1J-151JE	1	435031514R1	
R181	METAL R	RNU1/2WCJ-4.7	1	453530474T	
R182	METAL R	RNU1/2WCJ-1	1	453530104T	
R2100	THERMISTOR	FUSB090F	1	4000252T	N
R2150	C-CARBON R	RN72K1J-000JE	1	435030004R1	
R2151	C-CARBON R	RN72K1J-000JE	1	435030004R1	
R2152	C-CARBON R	RN72K1J-750JE	1	435037504R1	
R301	C-CARBON R	RN72K1J-331JE	1	435033314R1	
R302	C-CARBON R	RN72K1J-331JE	1	435033314R1	
R303	C-CARBON R	RN72K1J-331JE	1	435033314R1	
R304	C-CARBON R	RN72K1J-221JE	1	435032214R1	
R305	C-CARBON R	RN72K1J-470JE	1	435034704R1	
R306	C-CARBON R	RN72K1J-221JE	1	435032214R1	
R307	C-CARBON R	RN72K1J-221JE	1	435032214R1	
R308	C-CARBON R	RN72K1J-470JE	1	435034704R1	
R309	C-CARBON R	RN72K1J-221JE	1	435032214R1	
R311	C-CARBON R	RN72K1J-152JE	1	435031524R1	
R312	C-CARBON R	RN72K1J-470JE	1	435034704R1	
R313	C-CARBON R	RN72K1J-151JE	1	435031514R1	
R314	C-CARBON R	RN72K1J-221JE	1	435032214R1	

R315	C-CARBON R	RN72K1J-470JE	1	435034704R1
R316	C-CARBON R	RN72K1J-151JE	1	435031514R1
R317	C-CARBON R	RN72K1J-331JE	1	435033314R1
R318	C-CARBON R	RN72K1J-331JE	1	435033314R1
R319	C-CARBON R	RN72K1J-331JE	1	435033314R1
R320	C-CARBON R	RN72K1J-560JE	1	435035604R1
R321	C-CARBON R	RN72K1J-560JE	1	435035604R1
R323	C-CARBON R	RN72K1J-331JE	1	435033314R1
R324	C-CARBON R	RN72K1J-221JE	1	435032214R1
R325	C-CARBON R	RN72K1J-151JE	1	435031514R1
R326	C-CARBON R	RN72K1J-221JE	1	435032214R1
R330	C-CARBON R	RN72K1J-560JE	1	435035604R1
R331	C-CARBON R	RN72K1J-560JE	1	435035604R1
R333	C-CARBON R	RN72K1J-331JE	1	435033314R1
R334	C-CARBON R	RN72K1J-331JE	1	435033314R1
R336	C-CARBON R	RN72K1J-331JE	1	435033314R1
R337	C-CARBON R	RN72K1J-331JE	1	435033314R1
R339	C-CARBON R	RN72K1J-331JE	1	435033314R1
R340	C-CARBON R	RN72K1J-392JE	1	435033924R1
R341	C-CARBON R	RN72K1J-392JE	1	435033924R1
R350	C-CARBON R	RN72K1J-103JE	1	435031034R1
R351	C-CARBON R	RN72K1J-103JE	1	435031034R1
R360	C-CARBON R	RN72K1J-103JE	1	435031034R1
R361	C-CARBON R	RN72K1J-103JE	1	435031034R1
R371	C-CARBON R	RN72K1J-102JE	1	435031024R1
R400	C-CARBON R	RN72K1J-332JE	1	435033324R1
R401	C-CARBON R	RN72K1J-332JE	1	435033324R1
R402	C-CARBON R	RN72K1J-332JE	1	435033324R1
R403	C-CARBON R	RN72K1J-332JE	1	435033324R1
R404	C-CARBON R	RN72K1J-332JE	1	435033324R1
R405	C-CARBON R	RN72K1J-332JE	1	435033324R1
R406	C-CARBON R	RN72K1J-332JE	1	435033324R1
R407	C-CARBON R	RN72K1J-332JE	1	435033324R1
R408	C-CARBON R	RN72K1J-220JE	1	435032204R1
R409	C-CARBON R	RN72K1J-220JE	1	435032204R1
R410	C-CARBON R	RN72K1J-332JE	1	435033324R1
R411	C-CARBON R	RN72K1J-332JE	1	435033324R1
R412	C-CARBON R	RN72K1J-332JE	1	435033324R1
R413	C-CARBON R	RN72K1J-332JE	1	435033324R1

R414	C-CARBON R	RN72K1J-332JE	1	435033324R1
R415	C-CARBON R	RN72K1J-332JE	1	435033324R1
R416	C-CARBON R	RN72K1J-332JE	1	435033324R1
R417	C-CARBON R	RN72K1J-332JE	1	435033324R1
R420	C-CARBON R	RN72K1J-471JE	1	435034714R1
R421	C-CARBON R	RN72K1J-471JE	1	435034714R1
R422	C-CARBON R	RN72K1J-471JE	1	435034714R1
R423	C-CARBON R	RN72K1J-471JE	1	435034714R1
R424	C-CARBON R	RN72K1J-471JE	1	435034714R1
R425	C-CARBON R	RN72K1J-471JE	1	435034714R1
R426	C-CARBON R	RN72K1J-471JE	1	435034714R1
R427	C-CARBON R	RN72K1J-471JE	1	435034714R1
R430	C-CARBON R	RN72K1J-471JE	1	435034714R1
R431	C-CARBON R	RN72K1J-471JE	1	435034714R1
R432	C-CARBON R	RN72K1J-471JE	1	435034714R1
R433	C-CARBON R	RN72K1J-471JE	1	435034714R1
R434	C-CARBON R	RN72K1J-471JE	1	435034714R1
R435	C-CARBON R	RN72K1J-471JE	1	435034714R1
R436	C-CARBON R	RN72K1J-471JE	1	435034714R1
R437	C-CARBON R	RN72K1J-471JE	1	435034714R1
R440	C-CARBON R	RN72K1J-472JE	1	435034724R1
R441	C-CARBON R	RN72K1J-472JE	1	435034724R1
R442	C-CARBON R	RN72K1J-472JE	1	435034724R1
R443	C-CARBON R	RN72K1J-472JE	1	435034724R1
R444	C-CARBON R	RN72K1J-472JE	1	435034724R1
R445	C-CARBON R	RN72K1J-472JE	1	435034724R1
R446	C-CARBON R	RN72K1J-472JE	1	435034724R1
R447	C-CARBON R	RN72K1J-472JE	1	435034724R1
R450	C-CARBON R	RN72K1J-472JE	1	435034724R1
R451	C-CARBON R	RN72K1J-472JE	1	435034724R1
R452	C-CARBON R	RN72K1J-472JE	1	435034724R1
R453	C-CARBON R	RN72K1J-472JE	1	435034724R1
R454	C-CARBON R	RN72K1J-472JE	1	435034724R1
R455	C-CARBON R	RN72K1J-472JE	1	435034724R1
R456	C-CARBON R	RN72K1J-472JE	1	435034724R1
R457	C-CARBON R	RN72K1J-472JE	1	435034724R1
R460	C-CARBON R	RN72K1J-181JE	1	435031814R1
R461	C-CARBON R	RN72K1J-181JE	1	435031814R1
R462	C-CARBON R	RN72K1J-181JE	1	435031814R1

R463	C-CARBON R	RN72K1J-181JE	1	435031814R1	
R464	C-CARBON R	RN72K1J-181JE	1	435031814R1	
R465	C-CARBON R	RN72K1J-181JE	1	435031814R1	
R466	C-CARBON R	RN72K1J-181JE	1	435031814R1	
R467	C-CARBON R	RN72K1J-181JE	1	435031814R1	
R470	C-CARBON R	RN72K1J-181JE	1	435031814R1	
R471	C-CARBON R	RN72K1J-181JE	1	435031814R1	
R472	C-CARBON R	RN72K1J-181JE	1	435031814R1	
R473	C-CARBON R	RN72K1J-181JE	1	435031814R1	
R474	C-CARBON R	RN72K1J-181JE	1	435031814R1	
R475	C-CARBON R	RN72K1J-181JE	1	435031814R1	
R476	C-CARBON R	RN72K1J-181JE	1	435031814R1	
R477	C-CARBON R	RN72K1J-181JE	1	435031814R1	
R500	C-CARBON R	RN72K1J-103JE	1	435031034R1	
R501	C-CARBON R	RN72K1J-221JE	1	435032214R1	
R502	C-CARBON R	RN72K1J-103JE	1	435031034R1	
R503	C-CARBON R	RN72K1J-470JE	1	435034704R1	
R504	C-CARBON R	RN72K1J-103JE	1	435031034R1	
R505	C-CARBON R	RN72K1J-221JE	1	435032214R1	
R506	C-CARBON R	RN72K1J-221JE	1	435032214R1	<MMO,MMQ,MMA,MMR>
R507	C-CARBON R	RN72K1J-470JE	1	435034704R1	
R508	C-CARBON R	RN72K1J-470JE	1	435034704R1	
R509	C-CARBON R	RN72K1J-221JE	1	435032214R1	
R510	C-CARBON R	RN72K1J-470JE	1	435034704R1	
R511	C-CARBON R	RN72K1J-221JE	1	435032214R1	
R512	C-CARBON R	RN72K1J-273JE	1	435032734R1	
R513	C-CARBON R	RN72K1J-470JE	1	435034704R1	
R514	C-CARBON R	RN72K1J-470JE	1	435034704R1	
R515	C-CARBON R	RN72K1J-103JE	1	435031034R1	
R516	C-CARBON R	RN72K1J-272JE	1	435032724R1	
R517	C-CARBON R	RN72K1J-103JE	1	435031034R1	
R518	C-CARBON R	RN72K1J-470JE	1	435034704R1	
R519	C-CARBON R	RN72K1J-105JE	1	435031054R1	
R520	C-CARBON R	RN72K1J-103JE	1	435031034R1	
R521	C-CARBON R	RN72K1J-221JE	1	435032214R1	
R522	C-CARBON R	RN72K1J-221JE	1	435032214R1	
R523	C-CARBON R	RN72K1J-221JE	1	435032214R1	
R524	C-CARBON R	RN72K1J-221JE	1	435032214R1	
R525	C-CARBON R	RN72K1J-221JE	1	435032214R1	

R526	C-CARBON R	RN72K1J-221JE	1	435032214R1	
R527	C-CARBON R	RN72K1J-470JE	1	435034704R1	
R528	C-CARBON R	RN72K1J-470JE	1	435034704R1	
R529	C-CARBON R	RN72K1J-470JE	1	435034704R1	
R530	C-CARBON R	RN72K1J-470JE	1	435034704R1	
R531	C-CARBON R	RN72K1J-103JE	1	435031034R1	
R532	C-CARBON R	RN72K1J-221JE	1	435032214R1	
R533	C-CARBON R	RN72K1J-103JE	1	435031034R1	
R534	C-CARBON R	RN72K1J-103JE	1	435031034R1	
R535	C-CARBON R	RN72K1J-103JE	1	435031034R1	
R536	C-CARBON R	RN72K1J-103JE	1	435031034R1	
R537	C-CARBON R	RN72K1J-473JE	1	435034734R1	
R538	C-CARBON R	RN72K1J-103JE	1	435031034R1	
R539	C-CARBON R	RN72K1J-103JE	1	435031034R1	
R540	C-CARBON R	RN72K1J-470JE	1	435034704R1	
R541	C-CARBON R	RN72K1J-470JE	1	435034704R1	
R542	C-CARBON R	RN72K1J-470JE	1	435034704R1	
R543	C-CARBON R	RN72K1J-221JE	1	435032214R1	
R544	C-CARBON R	RN72K1J-470JE	1	435034704R1	
R545	C-CARBON R	RN72K1J-470JE	1	435034704R1	
R546	C-CARBON R	RN72K1J-470JE	1	435034704R1	
R547	C-CARBON R	RN72K1J-471JE	1	435034714R1	
R548	C-CARBON R	RN72K1J-102JE	1	435031024R1	
R549	C-CARBON R	RN72K1J-103JE	1	435031034R1	<MDC,MDD,MDF>
R550	C-CARBON R	RN72K1J-470JE	1	435034704R1	
R551	C-CARBON R	RN72K1J-470JE	1	435034704R1	
R552	C-CARBON R	RN72K1J-470JE	1	435034704R1	
R553	C-CARBON R	RN72K1J-470JE	1	435034704R1	
R554	C-CARBON R	RN72K1J-470JE	1	435034704R1	
R555	C-CARBON R	RN72K1J-470JE	1	435034704R1	
R556	C-CARBON R	RN72K1J-470JE	1	435034704R1	
R557	C-CARBON R	RN72K1J-470JE	1	435034704R1	
R558	C-CARBON R	RN72K1J-221JE	1	435032214R1	
R559	C-CARBON R	RN72K1J-103JE	1	435031034R1	
R560	C-CARBON R	RN72K1J-470JE	1	435034704R1	
R561	C-CARBON R	RN72K1J-470JE	1	435034704R1	
R562	C-CARBON R	RN72K1J-470JE	1	435034704R1	
R563	C-CARBON R	RN72K1J-221JE	1	435032214R1	
R564	C-CARBON R	RN72K1J-221JE	1	435032214R1	

R565	C-CARBON R	RN72K1J-221JE	1	435032214R1
R566	C-CARBON R	RN72K1J-221JE	1	435032214R1
R567	C-CARBON R	RN72K1J-470JE	1	435034704R1
R568	C-CARBON R	RN72K1J-470JE	1	435034704R1
R569	C-CARBON R	RN72K1J-470JE	1	435034704R1
R570	C-CARBON R	RN72K1J-470JE	1	435034704R1
R571	C-CARBON R	RN72K1J-470JE	1	435034704R1
R572	C-CARBON R	RN72K1J-221JE	1	435032214R1
R573	C-CARBON R	RN72K1J-221JE	1	435032214R1
R574	C-CARBON R	RN72K1J-470JE	1	435034704R1
R575	C-CARBON R	RN72K1J-103JE	1	435031034R1
R576	C-CARBON R	RN72K1J-470JE	1	435034704R1
R577	C-CARBON R	RN72K1J-103JE	1	435031034R1
R578	C-CARBON R	RN72K1J-221JE	1	435032214R1
R579	C-CARBON R	RN72K1J-221JE	1	435032214R1
R580	C-CARBON R	RN72K1J-221JE	1	435032214R1
R581	C-CARBON R	RN72K1J-221JE	1	435032214R1
R582	C-CARBON R	RN72K1J-221JE	1	435032214R1
R583	C-CARBON R	RN72K1J-473JE	1	435034734R1
R584	C-CARBON R	RN72K1J-221JE	1	435032214R1
R585	C-CARBON R	RN72K1J-273JE	1	435032734R1
R586	C-CARBON R	RN72K1J-221JE	1	435032214R1
R587	C-CARBON R	RN72K1J-102JE	1	435031024R1
R588	C-CARBON R	RN72K1J-273JE	1	435032734R1
R589	C-CARBON R	RN72K1J-102JE	1	435031024R1
R590	C-CARBON R	RN72K1J-273JE	1	435032734R1
R591	C-CARBON R	RN72K1J-102JE	1	435031024R1
R592	C-CARBON R	RN72K1J-103JE	1	435031034R1
R593	C-CARBON R	RN72K1J-102JE	1	435031024R1
R594	C-CARBON R	RN72K1J-102JE	1	435031024R1
R595	C-CARBON R	RN72K1J-470JE	1	435034704R1
R596	C-CARBON R	RN72K1J-102JE	1	435031024R1
R597	C-CARBON R	RN72K1J-103JE	1	435031034R1
R599	C-CARBON R	RN72K1J-221JE	1	435032214R1
R600	C-CARBON R	RN72K1J-470JE	1	435034704R1
R601	C-CARBON R	RN72K1J-221JE	1	435032214R1
R602	C-CARBON R	RN72K1J-221JE	1	435032214R1
R603	C-CARBON R	RN72K1J-221JE	1	435032214R1
R604	C-CARBON R	RN72K1J-221JE	1	435032214R1

R605	C-CARBON R	RN72K1J-470JE	1	435034704R1
R606	C-CARBON R	RN72K1J-222JE	1	435032224R1
R607	C-CARBON R	RN72K1J-470JE	1	435034704R1
R608	C-CARBON R	RN72K1J-222JE	1	435032224R1
R609	C-CARBON R	RN72K1J-472JE	1	435034724R1
R610	C-CARBON R	RN72K1J-472JE	1	435034724R1
R611	C-CARBON R	RN72K1J-472JE	1	435034724R1
R612	C-CARBON R	RN72K1J-272JE	1	435032724R1
R613	C-CARBON R	RN72K1J-472JE	1	435034724R1
R614	C-CARBON R	RN72K1J-272JE	1	435032724R1
R615	C-CARBON R	RN72K1J-472JE	1	435034724R1
R616	C-CARBON R	RN72K1J-272JE	1	435032724R1
R617	C-CARBON R	RN72K1J-472JE	1	435034724R1
R618	C-CARBON R	RN72K1J-272JE	1	435032724R1
R620	C-CARBON R	RN72K1J-473JE	1	435034734R1
R622	C-CARBON R	RN72K1J-470JE	1	435034704R1
R623	C-CARBON R	RN72K1J-103JE	1	435031034R1
R624	C-CARBON R	RN72K1J-470JE	1	435034704R1
R626	C-CARBON R	RN72K1J-470JE	1	435034704R1
R627	C-CARBON R	RN72K1J-470JE	1	435034704R1
R628	C-CARBON R	RN72K1J-221JE	1	435032214R1
R629	C-CARBON R	RN72K1J-470JE	1	435034704R1
R630	C-CARBON R	RN72K1J-470JE	1	435034704R1
R631	C-CARBON R	RN72K1J-470JE	1	435034704R1
R632	C-CARBON R	RN72K1J-470JE	1	435034704R1
R633	C-CARBON R	RN72K1J-470JE	1	435034704R1
R634	C-CARBON R	RN72K1J-221JE	1	435032214R1
R635	C-CARBON R	RN72K1J-103JE	1	435031034R1
R636	C-CARBON R	RN72K1J-470JE	1	435034704R1
R637	C-CARBON R	RN72K1J-103JE	1	435031034R1
R638	C-CARBON R	RN72K1J-470JE	1	435034704R1
R639	C-CARBON R	RN72K1J-470JE	1	435034704R1
R640	C-CARBON R	RN72K1J-103JE	1	435031034R1
R641	C-CARBON R	RN72K1J-221JE	1	435032214R1
R642	C-CARBON R	RN72K1J-470JE	1	435034704R1
R643	C-CARBON R	RN72K1J-103JE	1	435031034R1
R644	C-CARBON R	RN72K1J-103JE	1	435031034R1
R645	C-CARBON R	RN72K1J-103JE	1	435031034R1
R646	C-CARBON R	RN72K1J-470JE	1	435034704R1

R647	C-CARBON R	RN72K1J-470JE	1	435034704R1	
R648	C-CARBON R	RN72K1J-103JE	1	435031034R1	
R649	C-CARBON R	RN72K1J-103JE	1	435031034R1	
R650	C-CARBON R	RN72K1J-103JE	1	435031034R1	
R652	C-CARBON R	RN72K1J-103JE	1	435031034R1	
R653	C-CARBON R	RN72K1J-103JE	1	435031034R1	
R654	C-CARBON R	RN72K1J-103JE	1	435031034R1	
R655	C-CARBON R	RN72K1J-221JE	1	435032214R1	
R656	C-CARBON R	RN72K1J-221JE	1	435032214R1	
R657	C-CARBON R	RN72K1J-221JE	1	435032214R1	
R658	C-CARBON R	RN72K1J-221JE	1	435032214R1	
R662	C-CARBON R	RN72K1J-000JE	1	435030004R1	
R663	C-CARBON R	RN72K1J-103JE	1	435031034R1	
R664	C-CARBON R	RN72K1J-223JE	1	435032234R1	
R665	C-CARBON R	RN72K1J-223JE	1	435032234R1	
R666	C-CARBON R	RN72K1J-223JE	1	435032234R1	
R667	C-CARBON R	RN72K1J-223JE	1	435032234R1	
R684	C-CARBON R	RN72K1J-000JE	1	435030004R1	
R685	C-CARBON R	RN72K1J-000JE	1	435030004R1	
R700	C-CARBON R	RN72K1J-103JE	1	435031034R1	<MMO,MMQ,MMA,MPB,MPP,MMR>
R700	C-CARBON R	RN72K1J-333JE	1	435033334R1	<MDC,MDD,MDF>
R701	C-CARBON R	RN72K1J-103JE	1	435031034R1	<MPB,MPP>
R701	C-CARBON R	RN72K1J-472JE	1	435034724R1	<MDC,MDD,MDF>
R702	C-CARBON R	RN72K1J-563JE	1	435035634R1	<MMO,MMQ,MMA,MPB,MPP,MMR>
R703	C-CARBON R	RN72K1J-000JE	1	435030004R1	<MDC,MDD,MDF>
R703	C-CARBON R	RN72K1J-333JE	1	435033334R1	<MMO,MMQ,MMA,MPB,MPP,MMR>
R704	C-CARBON R	RN72K1J-103JE	1	435031034R1	
R706	C-CARBON R	RN72K1J-333JE	1	435033334R1	<MMO,MMQ,MMA,MPB,MPP,MMR>
R707	C-CARBON R	RN72K1J-000JE	1	435030004R1	<MDC,MDD,MDF>
R707	C-CARBON R	RN72K1J-103JE	1	435031034R1	<MMO,MMQ,MMA,MPB,MPP,MMR>
R711	C-CARBON R	RN72K1J-470JE	1	435034704R1	
R712	C-CARBON R	RN72K1J-102JE	1	435031024R1	
R713	C-CARBON R	RN72K1J-222JE	1	435032224R1	
R714	C-CARBON R	RN72K1J-103JE	1	435031034R1	
R718	C-CARBON R	RN72K1J-221JE	1	435032214R1	
R721	C-CARBON R	RN72K1J-103JE	1	435031034R1	
R722	C-CARBON R	RN72K1J-224JE	1	435032244R1	
R723	C-CARBON R	RN72K1J-101JE	1	435031014R1	
R724	C-CARBON R	RN72K1J-101JE	1	435031014R1	

R725	C-CARBON R	RN72K1J-221JE	1	435032214R1	
R726	C-CARBON R	RN72K1J-273JE	1	435032734R1	
R761	C-CARBON R	RN72K1J-103JE	1	435031034R1	
R762	C-CARBON R	RN72K1J-222JE	1	435032224R1	
R763	C-CARBON R	RN72K1J-102JE	1	435031024R1	
R771	C-CARBON R	RN72K1J-103JE	1	435031034R1	
R772	C-CARBON R	RN72K1J-222JE	1	435032224R1	
R773	C-CARBON R	RN72K1J-102JE	1	435031024R1	
R801	C-CARBON R	RN72K1J-000JE	1	435030004R1	
R805	C-CARBON R	RN72K1J-000JE	1	435030004R1	
R806	C-CARBON R	RN72K1J-000JE	1	435030004R1	
R807	C-CARBON R	RN72K1J-000JE	1	435030004R1	
JL5501B	WIRE TRAP	NPLG-3P586	1	25055624	
JL6610B	WIRE TRAP	NPLG-7P590	1	25055628	
JL901B	WIRE TRAP	NPLG-5P588	1	25055626	
P002	PWB	BCDG-0025	1	25140025C	N
P004	PWB	BCETC-0027	{ 1 }	25140027	N
P101A	SOCKET	NSCT-11P2104	1	25052207	
P131	PIN JACK	NPJ-2PDO0626	1	25045847	
P131 or	PIN JACK	NPJ-2PDO445	(1)	25045640	
P2001A	SOCKET	IMSA-9142S-26A	1	25053235	
P2080B	PLUG	IMSA-9142B-20A	1	25056600	
P2081	SOCKET	NNA1-01-006	1	25053357	
P5501A	SOCKET	NSCT-7P2187	1	25052290	
P5502A	SOCKET	NSCT-15P2195	1	25052298	
P5503A	SOCKET	NSCT-9P2189	1	25052292	
P5504A	SOCKET	NSCT-7P2187	1	25052290	
P701A	SOCKET	NSCT-33P2126	1	25052229	
P751A	SOCKET	IMSA-9618S-09A	1	25053334R2	N
P8001A	PLUG	IMSA-9111B-16	1	25056620	
P8002A	PLUG	IMSA-9111B-24	1	25056625	
P8003A	PLUG	IMSA-9111B-16	1	25056620	
P801	WS CLAMP	CB-71683(L=50)	1	260261	

U003 Diplay pc board AS (BADIS-0036-1Q/R/T/U)

U0031 Switch pc board AS (BADIS-0037-1Q/R/T/U)

U0032 Video pc board AS (BAVD-0038-1Q/R/T/U)

U0033 Power supply pc board AS (BAPS-0039-1Q/R/T/U)

U0034 Headphone pc board AS (BAETC-0040-1Q/R/T/U)

U0035 Inlet pc board AS (BAETC-0041-1U)

CIRCUIT NO.	PART NAME	DESCRIPTION	Q'TY	PART NO. (SN)	REMARKS
U7042	REMO SENS	NJL34H380A	1	241365	
D2084	ZENER D	UDZS6.8B	1	224550680R2	
D7002	ZENER D	UDZS8.2B	1	224550820R2	
D7033	ZENER D	UDZS3.9B	1	224550390R2	
D7152	LED	SLI-343URC-TE7	1	225449T	
D7154	LED	SCB3318E-D2	1	225487	<MPA,MPB,MPP,MMO,MMQ,MMR>
D7155	LED	SLR-342MGTE7P	1	225455T	
D7301	C-DIODE	KDS4148U	1	223283R2	
D7301 or	C-DIODE	1SS352	(1)	223234R2	
D7301 or	C-DIODE	MA2J111	(1)	223279R2	
D7302	C-DIODE	KDS4148U	1	223283R2	
D7302 or	C-DIODE	1SS352	(1)	223234R2	
D7302 or	C-DIODE	MA2J111	(1)	223279R2	
D7401	ZENER D	UDZS5.1B	1	224550510R2	
D7411	ZENER D	UDZS6.8B	1	224550680R2	
D7412	ZENER D	UDZS6.8B	1	224550680R2	
D9001	DIODE	RL1N4003	1	22380260T	
D9005	ZENER D	UDZS36B	1	224553600R2	
D9011	DIODE	D5SBA20	1	22380130	<MPA,MPB,MPP,MMO,MMQ,MMR>
D9011	DIODE	D5SBA20	1	22380130F	<MDC,MDD,MDF>
D9011A	SCREW	3P+10FN(3BC)	1	82143010GR	<MPA,MPB,MPP,MMO,MMQ,MMR>
D9011B	HEAT SINK	RAD-083	1	27160271	<MPA,MPB,MPP,MMO,MMQ,MMR>
D9014	C-DIODE	KDS4148U	1	223283R2	
D9014 or	C-DIODE	1SS352	(1)	223234R2	
D9014 or	C-DIODE	MA2J111	(1)	223279R2	
D9015	C-DIODE	KDS4148U	1	223283R2	
D9015 or	C-DIODE	1SS352	(1)	223234R2	
D9015 or	C-DIODE	MA2J111	(1)	223279R2	
D9016	ZENER D	UDZS6.2B	1	224550620R2	<MDC,MDD,MDF>
D9016	ZENER D	UDZS7.5B	1	224550750R2	<MPA,MPB,MPP,MMO,MMQ,MMR>
D9023	C-DIODE	KDS4148U	1	223283R2	
D9023 or	C-DIODE	1SS352	(1)	223234R2	
D9023 or	C-DIODE	MA2J111	(1)	223279R2	
D911	C-DIODE	KDS4148U	1	223283R2	
D911 or	C-DIODE	1SS352	(1)	223234R2	
D911 or	C-DIODE	MA2J111	(1)	223279R2	

D912	C-DIODE	KDS4148U	1	223283R2	
D912 or	C-DIODE	1SS352	(1)	223234R2	
D912 or	C-DIODE	MA2J111	(1)	223279R2	
D921	C-DIODE	KDS4148U	1	223283R2	
D921 or	C-DIODE	1SS352	(1)	223234R2	
D921 or	C-DIODE	MA2J111	(1)	223279R2	
D922	C-DIODE	KDS4148U	1	223283R2	
D922 or	C-DIODE	1SS352	(1)	223234R2	
D922 or	C-DIODE	MA2J111	(1)	223279R2	
D923	C-DIODE	KDS4148U	1	223283R2	
D923 or	C-DIODE	1SS352	(1)	223234R2	
D923 or	C-DIODE	MA2J111	(1)	223279R2	
D924	C-DIODE	KDS4148U	1	223283R2	
D924 or	C-DIODE	1SS352	(1)	223234R2	
D924 or	C-DIODE	MA2J111	(1)	223279R2	
D925	C-DIODE	KDS4148U	1	223283R2	
D925 or	C-DIODE	1SS352	(1)	223234R2	
D925 or	C-DIODE	MA2J111	(1)	223279R2	
D930	C-DIODE	KDS4148U	1	223283R2	
D930 or	C-DIODE	1SS352	(1)	223234R2	
D930 or	C-DIODE	MA2J111	(1)	223279R2	
D931	C-DIODE	KDS4148U	1	223283R2	
D931 or	C-DIODE	1SS352	(1)	223234R2	
D931 or	C-DIODE	MA2J111	(1)	223279R2	
D933	C-DIODE	KDS4148U	1	223283R2	
D933 or	C-DIODE	1SS352	(1)	223234R2	
D933 or	C-DIODE	MA2J111	(1)	223279R2	
D934	ZENER D	UDZS5.6B	1	224550560R2	
D935	C-DIODE	KDS4148U	1	223283R2	
D935 or	C-DIODE	1SS352	(1)	223234R2	
D935 or	C-DIODE	MA2J111	(1)	223279R2	
Q2004	IC	NJM4580M-D	1	22241448R2	
Q2072	IC	NJM2505AF	1	22242490R2	
Q3002	IC	NJW1326FH2	1	22242583R3	N
Q7002	FL TUBE	16-BT-138GNK	1	212268	
Q7002A	HOLDER	(FL)	1	27191222C	
Q7003	IC	M66005-0001AHP	1	22242208R3	
Q7004	TR	KTC3875-GR	1	2216175R2	
Q7005	TR	KRA102S	1	2216220R2	

Q7007	TR	KRC102S	1	2216190R2	
Q7033	TR	KTC3875-GR	1	2216175R2	
Q7151	TR	KTA1504-GR	1	2216185R2	<MPA,MPB,MPP,MMO,MMQ,MMR>
Q7152	TR	KTA1504-GR	1	2216185R2	
Q7401	IC	NJM4580M-D	1	22241448R2	
Q7403	TR	DTC114TKA	1	2216670R2	
Q7404	TR	DTC114TKA	1	2216670R2	
Q9001	TR	2SC2235-Y(TPE6_F)	1	2211654T	
Q9001 or	TR	2SC2235-O(TPE6_F)	(1)	2211653T	
Q9022	IC	78M05(NJM78M05FA)	1	222780055JRC	
Q9022 or	IC	78M05AHF(MPC78M05AHF)	(1)	222780055NEC	
Q9022A	SCREW	3P+10FN(3BC)	1	82143010GR	
Q9022B	HEAT SINK	RAD-157	1	27160491	
Q9031	IC	MPC2905BHF	1	22278005DBNE	
Q9031A	SCREW	3P+10FN(3BC)	1	82143010GR	
Q9031B	HEAT SINK	RAD-140	1	27160471	
L7031	CHOKE COIL	LBC2518T2R2M	1	231364M022R2	
L7201	CHOKE COIL	LBC2518T2R2M	1	231364M022R2	
L7202	CHOKE COIL	LBC2518T2R2M	1	231364M022R2	
L7203	CHOKE COIL	LBC2518T2R2M	1	231364M022R2	
L7401	CHOKE COIL	LBC2518T2R2M	1	231364M022R2	
L7402	CHOKE COIL	LBC2518T2R2M	1	231364M022R2	
T902	P TRANS	NPT-1520JQ	1	2301812A	! <MDC,MDD,MDF>
T902	P TRANS	NPT-1520GQ	1	2301813A	! <MPA,MPB,MPP,MMO,MMQ,MMR>
C2029	UTSP C	CE04W25V-100M(UTSP)	1	397551017T	
C2030	UTSP C	CE04W25V-100M(UTSP)	1	397551017T	
C2077	UTSP C	CE04W50V-10M(UTSP)	1	397581007T	
C2078	UTSP C	CE04W50V-10M(UTSP)	1	397581007T	
C2079	UTSP C	CE04W50V-10M(UTSP)	1	397581007T	
C2080	C-CERA C	CC725CH1H-101J1	1	342101014R1	
C2081	C-CERA C	CC725CH1H-101J1	1	342101014R1	
C2082	C-CERA C	CC725CH1H-101J1	1	342101014R1	
C2083	C-CERA C	CC725CH1H-101J1	1	342101014R1	
C2084	UTSP C	CE04W50V-10M(UTSP)	1	397581007T	
C2085	UTSP C	CE04W50V-10M(UTSP)	1	397581007T	
C2086	C-CERA C	CC725CH1H-470J1	1	342104704R1	
C2087	C-CERA C	CC725CH1H-470J1	1	342104704R1	
C2088	C-CERA C	CK725F1E-104Z1	1	332161040R1	
C2089	C-CERA C	CK725F1E-104Z1	1	332161040R1	

C2100	VR C	CE04W16V-100M(VR)	1	394641017T	
C2101	C-CERA C	CK725F1E-104Z1	1	332161040R1	
C2103	VR C	CE04W6.3V-470M(VR)	1	394624717T	
C2104	VR C	CE04W6.3V-470M(VR)	1	394624717T	
C3001	VR C	CE04W6.3V-470M(VR)	1	394624717T	
C3002	C-CERA C	CK725F1E-104Z1	1	332161040R1	
C3004	VR C	CE04W6.3V-470M(VR)	1	394624717T	
C3007	VR C	CE04W6.3V-470M(VR)	1	394624717T	
C3009	VR C	CE04W6.3V-470M(VR)	1	394624717T	<MPA,MPB,MPP,MMO,MMQ,MMR>
C3011	VR C	CE04W6.3V-470M(VR)	1	394624717T	
C3012	C-CERA C	CK725F1E-104Z1	1	332161040R1	
C3013	VR C	CE04W6.3V-470M(VR)	1	394624717T	
C3021	VR C	CE04W6.3V-470M(VR)	1	394624717T	
C3024	VR C	CE04W6.3V-470M(VR)	1	394624717T	
C3031	C-CERA C	CK725B1H-102K1	1	332101025R1	
C3032	C-CERA C	CK725B1H-102K1	1	332101025R1	
C3033	VR C	CE04W50V-10M(VR)	1	394681007T	
C3036	VR C	CE04W50V-10M(VR)	1	394681007T	
C3040	VR C	CE04W50V-10M(VR)	1	394681007T	
C3043	C-CERA C	CK725B1H-102K1	1	332101025R1	
C3044	VR C	CE04W50V-1M(VR)	1	394680107T	
C3045	VR C	CE04W50V-1M(VR)	1	394680107T	
C3046	VR C	CE04W50V-1M(VR)	1	394680107T	
C3047	VR C	CE04W50V-1M(VR)	1	394680107T	
C3048	VR C	CE04W50V-1M(VR)	1	394680107T	
C3049	VR C	CE04W50V-1M(VR)	1	394680107T	
C3054	VR C	CE04W6.3V-470M(VR)	1	394624717T	<MPA,MPB,MPP,MMO,MMQ,MMR>
C3055	VR C	CE04W6.3V-470M(VR)	1	394624717T	<MPA,MPB,MPP,MMO,MMQ,MMR>
C3060	VR C	CE04W50V-10M(VR)	1	394681007T	
C3061	VR C	CE04W50V-10M(VR)	1	394681007T	
C3081	VR C	CE04W50V-10M(VR)	1	394681007T	<MPA,MPB,MPP,MMO,MMQ,MMR>
C3084	VR C	CE04W6.3V-470M(VR)	1	394624717T	<MPA,MPB,MPP,MMO,MMQ,MMR>
C3085	C-CERA C	CK725F1A-105Z1	1	332181050R1	
C3086	C-CERA C	CK725F1A-105Z1	1	332181050R1	
C3087	C-CERA C	CK725F1A-105Z1	1	332181050R1	
C3088	C-CERA C	CK725F1A-105Z1	1	332181050R1	<MDC,MDD,MDF>
C3091	C-CERA C	CK725F1A-105Z1	1	332181050R1	
C3092	C-CERA C	CK725F1A-105Z1	1	332181050R1	
C3093	C-CERA C	CK725F1A-105Z1	1	332181050R1	

C3094	C-CERA C	CK725F1A-105Z1	1	332181050R1	
C3095	C-CERA C	CK725F1A-105Z1	1	332181050R1	
C3096	C-CERA C	CK725F1A-105Z1	1	332181050R1	
C3097	C-CERA C	CK725F1A-105Z1	1	332181050R1	
C3098	C-CERA C	CK725F1A-105Z1	1	332181050R1	
C3099	C-CERA C	CK725F1A-105Z1	1	332181050R1	
C7001	C-CERA C	CK725B1H-223K1	1	332102235R1	
C7002	C-CERA C	CK725F1E-104Z1	1	332161040R1	
C7003	C-CERA C	CC725CH1H-101J1	1	342101014R1	
C7004	C-CERA C	CC725CH1H-101J1	1	342101014R1	
C7005	C-CERA C	CC725CH1H-101J1	1	342101014R1	
C7007	C-CERA C	CC725CH1H-101J1	1	342101014R1	
C7008	ELECT C	CE04W6.3V-100M	1	355721019T	
C7009	C-CERA C	CK725F1E-104Z1	1	332161040R1	
C7010	C-CERA C	CK725B1H-223K1	1	332102235R1	
C7011	C-CERA C	CK725B1H-223K1	1	332102235R1	
C7012	C-CERA C	CK725B1H-223K1	1	332102235R1	
C7013	ELECT C	CE04W50V-33M	1	355783309T	
C7014	C-CERA C	CK725B1H-223K1	1	332102235R1	
C7015	ELECT C	CE04W16V-47M(S)	1	353744709T	
C7016	C-CERA C	CK725B1H-223K1	1	332102235R1	
C7017	C-CERA C	CK725B1H-223K1	1	332102235R1	
C7021	C-CERA C	CK725B1H-103K1	1	332101035R1	
C7022	C-CERA C	CK725B1H-103K1	1	332101035R1	
C7031	C-CERA C	CK725B1H-223K1	1	332102235R1	
C7032	C-CERA C	CK725B1H-223K1	1	332102235R1	
C7033	ELECT C	CE04W16V-10M(S)	1	353741009T	
C7045	ELECT C	CE04W6.3V-100M(S)	1	353721019T	
C7046	C-CERA C	CC725CH1H-102J1	1	342101024R1	
C7047	C-CERA C	CC725CH1H-102J1	1	342101024R1	
C7201	C-CERA C	CC725CH1H-102J1	1	342101024R1	
C7202	C-CERA C	CK725B1H-223K1	1	332102235R1	<MDC,MDD,MDF>
C7203	MKT C	B32529C0102J289	1	376491024T	
C7204	MKT C	B32529C0102J289	1	376491024T	
C7301	C-CERA C	CC725CH1H-471J1	1	342104714R1	
C7302	C-CERA C	CC725CH1H-471J1	1	342104714R1	
C7303	C-CERA C	CK725F1E-104Z1	1	332161040R1	
C7304	C-CERA C	CK725F1E-104Z1	1	332161040R1	
C7305	C-CERA C	CK725F1E-104Z1	1	332161040R1	

C7309	C-CERA C	CC725CH1H-101J1	1	342101014R1	
C7401	ELECT C	CE04W16V-10M(S)	1	353741009T	
C7402	C-CERA C	CC725CH1H-101J1	1	342101014R1	
C7403	ELECT C	CE04W16V-47M(S)	1	353744709T	
C7404	C-CERA C	CC725CH1H-330J1	1	342103304R1	
C7405	ELECT C	CE04W16V-10M(S)	1	353741009T	
C7411	ELECT C	CE04W16V-47M(S)	1	353744709T	
C7412	ELECT C	CE04W16V-47M(S)	1	353744709T	
C7421	C-CERA C	CC725CH1H-102J1	1	342101024R1	
C9001	VR C	CE04W63V-470M(VR)	1	394674717S	
C9005	VR C	CE04W50V-47M(VR)	1	394684707T	
C9006	C-CERA C	CK725F1E-104Z1	1	332161040R1	
C901	IS C	LE103-C3.5	1	3800042S	!
C901 or	IS C	ECQU2A103MLC	(1)	3800039S	!
C9011	VR C	CE04W16V-10000M(VR)	1	394641037S	
C9012	TF C	ECQ-V50V-334J	1	374723344T	
C9013	VR C	CE04W50V-2.2M(VR)	1	394680227T	
C9014	VR C	CE04W50V-1M(VR)	1	394680107T	
C902	C-CERA C	CK725F1E-104Z1	1	332161040R1	
C9023	VR C	CE04W50V-10M(VR)	1	394681007T	
C9025	VR C	CE04W6.3V-470M(VR)	1	394624717T	
C9030	VR C	CE04W25V-220M(VR)	1	394652217T	
C9031	C-CERA C	CK725F1E-104Z1	1	332161040R1	
C9032	VR C	CE04W6.3V-470M(VR)	1	394624717T	
C911	C-CERA C	CC725CH1H-102J1	1	342101024R1	
C921	C-CERA C	CK725B1H-223K1	1	332102235R1	
C922	VR C	CE04W25V-2200M(VR)	1	394652227S	
C930	UTSP C	CE04W50V-100M(UTSP)	1	397581017T	
C933	UTSP C	CE04W50V-4.7M(UTSP)	1	397580477T	
R2004	C-CARBON R	RN72K1J-000JE	1	435030004R1	
R2005	C-CARBON R	RN72K1J-000JE	1	435030004R1	
R2007	C-CARBON R	RN72K1J-000JE	1	435030004R1	
R2009	C-CARBON R	RN72K1J-000JE	1	435030004R1	
R2010	C-CARBON R	RN72K1J-000JE	1	435030004R1	
R2014	C-CARBON R	RN72K1J-000JE	1	435030004R1	
R2015	C-CARBON R	RN72K1J-000JE	1	435030004R1	
R2016	C-CARBON R	RN72K1J-000JE	1	435030004R1	
R2048	C-CARBON R	RN72K1J-220JE	1	435032204R1	
R2049	C-CARBON R	RN72K1J-220JE	1	435032204R1	

R2104	C-CARBON R	RN72K1J-223JE	1	435032234R1	
R2105	C-CARBON R	RN72K1J-223JE	1	435032234R1	
R2106	C-CARBON R	RN72K1J-223JE	1	435032234R1	
R2107	C-CARBON R	RN72K1J-223JE	1	435032234R1	
R2108	C-CARBON R	RN72K1J-223JE	1	435032234R1	
R2109	C-CARBON R	RN72K1J-223JE	1	435032234R1	
R2110	C-CARBON R	RN72K1J-223JE	1	435032234R1	
R2111	C-CARBON R	RN72K1J-223JE	1	435032234R1	
R2115	C-CARBON R	RN72K1J-471JE	1	435034714R1	<MDC,MDD,MDF>
R2115	C-CARBON R	RN72K1J-681JE	1	435036814R1	<MPA,MPB,MPP,MMO,MMQ,MMR>
R2116	C-CARBON R	RN72K1J-220JE	1	435032204R1	
R2117	C-CARBON R	RN72K1J-220JE	1	435032204R1	
R2120	C-CARBON R	RN72K1J-471JE	1	435034714R1	
R2121	C-CARBON R	RN72K1J-471JE	1	435034714R1	
R2130	C-CARBON R	RN72K1J-105JE	1	435031054R1	
R2132	C-CARBON R	RN72K1J-105JE	1	435031054R1	
R3011	C-CARBON R	RN72K1J-750JE	1	435037504R1	
R3014	C-CARBON R	RN72K1J-750JE	1	435037504R1	
R3017	C-CARBON R	RN72K1J-750JE	1	435037504R1	
R3020	C-CARBON R	RN72K1J-750JE	1	435037504R1	
R3021	C-CARBON R	RN72K1J-750JE	1	435037504R1	
R3023	C-CARBON R	RN72K1J-750JE	1	435037504R1	
R3026	C-CARBON R	RN72K1J-750JE	1	435037504R1	
R3027	C-CARBON R	RN72K1J-750JE	1	435037504R1	
R3028	C-CARBON R	RN72K1J-750JE	1	435037504R1	
R3029	C-CARBON R	RN72K1J-750JE	1	435037504R1	
R3030	C-CARBON R	RN72K1J-750JE	1	435037504R1	
R3038	METAL R	RNU1/2WCJ-1	1	453530104T	
R3041	C-CARBON R	RN72K1J-750JE	1	435037504R1	
R3042	C-CARBON R	RN72K1J-750JE	1	435037504R1	
R3043	C-CARBON R	RN72K1J-750JE	1	435037504R1	
R3081	C-CARBON R	RN72K1J-750JE	1	435037504R1	<MPA,MPB,MPP,MMO,MMQ,MMR>
R3084	C-CARBON R	RN72K1J-750JE	1	435037504R1	<MPA,MPB,MPP,MMO,MMQ,MMR>
R3085	C-CARBON R	RN72K1J-750JE	1	435037504R1	<MPA,MPB,MPP,MMO,MMQ,MMR>
R3086	C-CARBON R	RN72K1J-750JE	1	435037504R1	<MPA,MPB,MPP,MMO,MMQ,MMR>
R3089	C-CARBON R	RN72K1J-750JE	1	435037504R1	
R7001	C-CARBON R	RN72K1J-103JE	1	435031034R1	
R7002	C-CARBON R	RN72K1J-332JE	1	435033324R1	
R7003	C-CARBON R	RN72K1J-332JE	1	435033324R1	

R7004	C-CARBON R	RN72K1J-221JE	1	435032214R1
R7005	C-CARBON R	RN72K1J-221JE	1	435032214R1
R7006	C-CARBON R	RN72K1J-103JE	1	435031034R1
R7007	C-CARBON R	RN72K1J-221JE	1	435032214R1
R7008	C-CARBON R	RN72K1J-221JE	1	435032214R1
R7021	C-CARBON R	RN72K1J-103JE	1	435031034R1
R7022	C-CARBON R	RN72K1J-103JE	1	435031034R1
R7023	C-CARBON R	RN72K1J-103JE	1	435031034R1
R7024	C-CARBON R	RN72K1J-103JE	1	435031034R1
R7033	C-CARBON R	RN72K1J-820JE	1	435038204R1
R7045	C-CARBON R	RN72K1J-101JE	1	435031014R1
R7046	C-CARBON R	RN72K1J-102JE	1	435031024R1
R7101	C-CARBON R	RN72K1J-331JE	1	435033314R1
R7102	C-CARBON R	RN72K1J-471JE	1	435034714R1
R7103	C-CARBON R	RN72K1J-561JE	1	435035614R1
R7107	C-CARBON R	RN72K1J-331JE	1	435033314R1
R7108	C-CARBON R	RN72K1J-471JE	1	435034714R1
R7109	C-CARBON R	RN72K1J-561JE	1	435035614R1
R7110	C-CARBON R	RN72K1J-821JE	1	435038214R1
R7111	C-CARBON R	RN72K1J-122JE	1	435031224R1
R7112	C-CARBON R	RN72K1J-222JE	1	435032224R1
R7113	C-CARBON R	RN72K1J-392JE	1	435033924R1
R7114	C-CARBON R	RN72K1J-123JE	1	435031234R1
R7115	C-CARBON R	RN72K1J-331JE	1	435033314R1
R7116	C-CARBON R	RN72K1J-471JE	1	435034714R1
R7117	C-CARBON R	RN72K1J-561JE	1	435035614R1
R7118	C-CARBON R	RN72K1J-821JE	1	435038214R1
R7119	C-CARBON R	RN72K1J-122JE	1	435031224R1
R7120	C-CARBON R	RN72K1J-222JE	1	435032224R1
R7121	C-CARBON R	RN72K1J-392JE	1	435033924R1
R7122	C-CARBON R	RN72K1J-123JE	1	435031234R1
R7123	C-CARBON R	RN72K1J-331JE	1	435033314R1
R7124	C-CARBON R	RN72K1J-471JE	1	435034714R1
R7125	C-CARBON R	RN72K1J-561JE	1	435035614R1
R7126	C-CARBON R	RN72K1J-821JE	1	435038214R1
R7127	C-CARBON R	RN72K1J-122JE	1	435031224R1
R7128	C-CARBON R	RN72K1J-222JE	1	435032224R1
R7129	C-CARBON R	RN72K1J-392JE	1	435033924R1
R7151	C-CARBON R	RN72K1J-222JE	1	435032224R1

R7152	C-CARBON R	RN72K1J-820JE	1	435038204R1	<MPA,MPB,MPP,MMO,MMQ,MMR>
R7154	C-CARBON R	RN72K1J-121JE	1	435031214R1	
R7155	C-CARBON R	RN72K1J-103JE	1	435031034R1	<MPA,MPB,MPP,MMO,MMQ,MMR>
R7156	C-CARBON R	RN72K1J-102JE	1	435031024R1	<MPA,MPB,MPP,MMO,MMQ,MMR>
R7157	C-CARBON R	RN72K1J-103JE	1	435031034R1	
R7158	C-CARBON R	RN72K1J-102JE	1	435031024R1	
R7301	C-CARBON R	RN72K1J-331JE	1	435033314R1	
R7302	C-CARBON R	RN72K1J-331JE	1	435033314R1	
R7304	C-CARBON R	RN72K1J-000JE	1	435030004R1	<MDC,MDD,MDF>
R7305	C-CARBON R	RN72K1J-000JE	1	435030004R1	<MPA,MPB,MPP,MMO,MMQ,MMR>
R7401	C-CARBON R	RN72K1J-101JE	1	435031014R1	
R7402	C-CARBON R	RN72K1J-224JE	1	435032244R1	
R7403	C-CARBON R	RN72K1J-472JE	1	435034724R1	
R7404	C-CARBON R	RN72K1J-221JE	1	435032214R1	
R7405	C-CARBON R	RN72K1J-473JE	1	435034734R1	
R7406	C-CARBON R	RN72K1J-331JE	1	435033314R1	
R7407	C-CARBON R	RN72K1J-102JE	1	435031024R1	
R7408	C-CARBON R	RN72K1J-333JE	1	435033334R1	
R7409	C-CARBON R	RN72K1J-221JE	1	435032214R1	
R7410	C-CARBON R	RN72K1J-221JE	1	435032214R1	
R7411	C-CARBON R	RN72K1J-471JE	1	435034714R1	
R7412	C-CARBON R	RN72K1J-471JE	1	435034714R1	
R7413	C-CARBON R	RN72K1J-224JE	1	435032244R1	
R7414	C-CARBON R	RN72K1J-104JE	1	435031044R1	
R7415	C-CARBON R	RN72K1J-000JE	1	435030004R1	<MDC,MDD,MDF>
R7416	C-CARBON R	RN72K1J-000JE	1	435030004R1	<MPA,MPB,MPP,MMO,MMQ,MMR>
R9001	METAL O R	RS1WBJ-220	1	443622214T	
R9002	C-CARBON R	RN72K1J-822JE	1	435038224R1	
R9003	C-CARBON R	RN72K1J-822JE	1	435038224R1	
R9004	C-CARBON R	RN72K1J-333JE	1	435033334R1	
R9010	METAL O R	RS1/2WBJ-82	1	443528204T	<MDC,MDD,MDF>
R9010	METAL R	RNU1/2WCJ-2.2	1	453530224T	<MPA,MPB,MPP,MMO,MMQ,MMR>
R9012	METAL R	RNU1/2WCJ-1	1	453530104T	
R9013	METAL R	RNU1/2WCJ-1	1	453530104T	
R9014	C-CARBON R	RN72K1J-104JE	1	435031044R1	
R9029	METAL R	RNU1WCJ-0.22	1	453632294T	
R9030	METAL O R	RS1WBJ-8.2	1	441620824F	<MDC,MDD,MDF>
R9030	METAL O R	RS2WBJ-15	1	442721504F	<MPA,MPB,MPP,MMO,MMQ,MMR>
R9031	METAL R	RNU2WCJ-3.3	1	452730334F	

R9032	METAL R	RNU2WCJ-3.3	1	452730334F	
R9033	METAL R	RNU1/2WCJ-1	1	453530104T	
R9036	C-CARBON R	RN72K1J-000JE	1	435030004R1	
R921	METAL O R	RS1/2WBJ-47	1	443524704T	
R934	C-CARBON R	RN72K1J-104JE	1	435031044R1	
E7201	TRM-423(SCREW)	NEJITANSI ST3	1	25060495	<MPA,MPB,MPP,MMO,MMQ,MMR>
E7202	TRM-423(SCREW)	NEJITANSI ST3	1	25060495	<MDC,MDD,MDF>
E7301A	RETAINER	(EARTH)	1	27142136A	<MDC,MDD,MDF>
E7302A	RETAINER	(EARTH)	1	27142136A	<MPA,MPB,MPP,MMO,MMQ,MMR>
E9001	TRM-423(SCREW)	NEJITANSI ST3	1	25060495	
E9002	RETAINER	(JOINT)	1	27142069	
E9003	TRM-423(SCREW)	NEJITANSI ST3	1	25060495	
E901	TRM-423(SCREW)	NEJITANSI ST3	1	25060495	
E902	TRM-423(SCREW)	NEJITANSI ST3	1	25060495	
F901C	FUSE HOL	NSCT-1P2031	1	25052133T	
F901D	FUSE HOL	NSCT-1P2031	1	25052133T	
F901E	LABEL	LABEL	1	29360842	<MDC,MDD,MDF>
F901E	LABEL	T5AL250V	1	29361938	<MPA,MPB,MPP,MMO,MMQ,MMR>
JL5502B	WIRE TRAP	NPLG-5P588	1	25055626	
JL6605B	SOCKET	NSCT-5P97	1	25050269	
JL7101A	WIRE HOL	NSCT-9P900	1	25051113	
JL7101B	WIRE HOL	NSCT-9P900	1	25051113	
JL8001A	WIRE HOL	NSCT-5P876	1	25051089	
JL901A	WIRE HOL	NSCT-5P876	1	25051089	
JL9101B	SOCKET	NSCT-7P99	1	25050271	
P002	PWB	BCDIS-0036	1	25140036C	N
P003	PWB	BCDIS-0037	{ 1 }	25140037	N
P004	PWB	BCVD-0038	{ 1 }	25140038	N
P005	PWB	BCPS-0039	{ 1 }	25140039	N
P006	PWB	BCETC-0040	{ 1 }	25140040	N
P007	PWB	BCETC-0041	{ 1 }	25140041	<MMR>
P2001B	PLUG	IMSA-9142B-26A	1	25056603	
P2080A	SOCKET	IMSA-9142S-20A	1	25053232	
P2801A	SOCKET	NSCT-11P2104	1	25052207	<MPA,MPB,MPP,MMO,MMQ,MMR>
P3001	PIN JACK	NPJ-3PDYYY560	1	25045778	
P3002	PIN JACK	NPJ-3PDYYY560	1	25045778	<MPA,MPB,MPP,MMO,MMQ,MMR>
P3002	PIN JACK	NPJ-2PDYY679	1	25045911	<MDC,MDD,MDF>
P3005	PIN JACK	NPJ-9PDGLRGLRGLR563	1	25045781	
P3005 or	PIN JACK	NPJ-9PDGLR519	(1)	25045731	

P701B	SOCKET	NSCT-33P2163	1	25052266	
P7201	ST JACK	MSJ-064-05A SR	1	25045783	
P7201 or	ST JACK	YKB21-5005	(1)	25045724	
P7301	PIN JACK	NPJ-3PDB693	1	25045925	<MDC,MDD,MDF>
P7302	PIN JACK	NPJ-3PDB693	1	25045925	<MPA,MPB,MPP,MMO,MMQ,MMR>
P7311	ST JACK	MSJ-035-05A BAG SR LF	1	25045927	<MDC,MDD,MDF>
P7312	ST JACK	MSJ-035-05A BAG SR LF	1	25045927	<MPA,MPB,MPP,MMO,MMQ,MMR>
P7401	ST JACK	MSJ-035-05C B AG SR type	1	25045879	<MDC,MDD,MDF>
P7402	ST JACK	MSJ-035-05C B AG SR type	1	25045879	<MPA,MPB,MPP,MMO,MMQ,MMR>
P901A	PLUG	NPLG-2P631	1	25055675	<MDC,MDD,MDF,MPA,MPB,MPP,MMO,MMQ>
P901Aor	PLUG	1-1123724-2	(1)	25056402	<MDC,MDD,MDF,MPA,MPB,MPP,MMO,MMQ>
P907	AC INLET	NPLG-2P913	1	25055960	<MMR>
P911	PLUG	NPLG-2P631	1	25055675	<MDC,MDD,MDF,MPA,MPB,MPP>
P911 or	PLUG	1-1123724-2	(1)	25056402	<MDC,MDD,MDF,MPA,MPB,MPP>
P912	PLUG	B5P9-VH	1	25056568	<MMO,MMQ,MMR>
P912 or	PLUG	1-1123724-5	(1)	25056579	<MMO,MMQ,MMR>
P921	CRIMP AS	CRIMP AS	1	206CC45150UL	<MMR>
P922	CRIMP AS	CRIMP AS	1	206CC45159UL	<MMR>
RL901	RELAY	NRL-1P5A-DC9-179	1	25065669	!
S7002	R ENCODE	EC12E2425WITH WASHER	1	25065655W	
S7102	PUSH SW	NPS-111-S681	1	25035718T	
S7104	PUSH SW	NPS-111-S681	1	25035718T	
S7108	PUSH SW	NPS-111-S681	1	25035718T	
S7110	PUSH SW	NPS-111-S681	1	25035718T	
S7113	PUSH SW	NPS-111-S681	1	25035718T	<MDC,MDD,MDF>
S7114	PUSH SW	NPS-111-S681	1	25035718T	<MPA,MPB,MPP,MMO,MMQ,MMR>
S7115	PUSH SW	NPS-111-S681	1	25035718T	<MDC,MDD,MDF>
S7116	PUSH SW	NPS-111-S681	1	25035718T	<MPA,MPB,MPP,MMO,MMQ,MMR>
S7117	PUSH SW	NPS-111-S681	1	25035718T	<MDC,MDD,MDF>
S7118	PUSH SW	NPS-111-S681	1	25035718T	<MPA,MPB,MPP,MMO,MMQ,MMR>
S7119	PUSH SW	NPS-111-S681	1	25035718T	<MDC,MDD,MDF>
S7120	PUSH SW	NPS-111-S681	1	25035718T	<MPA,MPB,MPP,MMO,MMQ,MMR>
S7121	PUSH SW	NPS-111-S681	1	25035718T	<MDC,MDD,MDF>
S7122	PUSH SW	NPS-111-S681	1	25035718T	<MPA,MPB,MPP,MMO,MMQ,MMR>
S7124	PUSH SW	NPS-111-S681	1	25035718T	<MPA,MPB,MPP,MMO,MMQ,MMR>
S7125	PUSH SW	NPS-111-S681	1	25035718T	<MDC,MDD,MDF>
S7126	PUSH SW	NPS-111-S681	1	25035718T	<MPA,MPB,MPP,MMO,MMQ,MMR>
S7127	PUSH SW	NPS-111-S681	1	25035718T	<MDC,MDD,MDF>
S7128	PUSH SW	NPS-111-S681	1	25035718T	<MPA,MPB,MPP,MMO,MMQ,MMR>

S7129	PUSH SW	NPS-111-S681	1	25035718T	<MDC,MDD,MDF>
S7130	PUSH SW	NPS-111-S681	1	25035718T	<MPA,MPB,MPP,MMO,MMQ,MMR>
S7132	PUSH SW	NPS-111-S681	1	25035718T	
S7134	PUSH SW	NPS-111-S681	1	25035718T	
S7136	PUSH SW	NPS-111-S681	1	25035718T	
S7138	PUSH SW	NPS-111-S681	1	25035718T	
S7140	PUSH SW	NPS-111-S681	1	25035718T	
S7142	PUSH SW	NPS-111-S681	1	25035718T	
S7144	PUSH SW	NPS-111-S681	1	25035718T	
S7146	PUSH SW	NPS-111-S681	1	25035718T	
S7148	PUSH SW	NPS-111-S681	1	25035718T	
S7150	PUSH SW	NPS-111-S681	1	25035718T	
S7152	PUSH SW	NPS-111-S681	1	25035718T	
S7154	PUSH SW	NPS-111-S681	1	25035718T	
S7156	PUSH SW	NPS-111-S681	1	25035718T	
S7158	PUSH SW	NPS-111-S681	1	25035718T	
S7160	PUSH SW	NPS-111-S681	1	25035718T	
S7162	PUSH SW	NPS-111-S681	1	25035718T	
S7164	PUSH SW	NPS-111-S681	1	25035718T	

U004 HDMI / DSP pc board AS (BAHDM-0063-1A)

U0041 Front HDMI pc board AS (BAHDM-0064-1A)

U0042 Holder pc board AS (BAETC-0065-1A)

CIRCUIT NO.	PART NAME	DESCRIPTION	Q'TY	PART NO. (SN)	REMARKS
D201	DIODE	RB070M-30	1	22380361R2	
D201 or	C-DIODE	CRS09(TE85L_Q)	(1)	223274R2	
D203	C-DIODE	1SR154-400	1	22380284R2	
D204	C-DIODE	KDS4148U	1	223283R2	
D204 or	C-DIODE	1SS352	(1)	223234R2	
D204 or	C-DIODE	MA2J111	(1)	223279R2	
D204 or	C-DIODE	MA2J1110GL	(1)	223302R2	
D205	C-DIODE	1SR154-400	1	22380284R2	
D8001	DIODE	RB070M-30	1	22380361R2	
D8001 or	C-DIODE	CRS09(TE85L_Q)	(1)	223274R2	
D8301	DIODE	DAN217T146	1	223285R2	
D8301 or	C-DIODE	1SS226(TE85L_F)	(1)	223266R2	
D8302	C-DIODE	KDS4148U	1	223283R2	
D8302 or	C-DIODE	1SS352	(1)	223234R2	

D8302 or	C-DIODE	MA2J111	(1)	223279R2	
D8302 or	C-DIODE	MA2J1110GL	(1)	223302R2	
D8591	DIODE	RB070M-30	1	22380361R2	
D8591 or	C-DIODE	CRS09(TE85L_Q)	(1)	223274R2	
D8651	C-DIODE	KDS4148U	1	223283R2	
D8651 or	C-DIODE	1SS352	(1)	223234R2	
D8651 or	C-DIODE	MA2J111	(1)	223279R2	
D8651 or	C-DIODE	MA2J1110GL	(1)	223302R2	
D8652	C-DIODE	1SR154-400	1	22380284R2	
D8653	C-DIODE	KDS4148U	1	223283R2	
D8653 or	C-DIODE	1SS352	(1)	223234R2	
D8653 or	C-DIODE	MA2J111	(1)	223279R2	
D8653 or	C-DIODE	MA2J1110GL	(1)	223302R2	
Q201	IC	D788E001BRFP266Z	1	22242502R3	
Q202	IC	TC74VHC157FT	1	22274157ER2TO	
Q203	IC	TC7WU04FU(TE12L_F)	1	22240935R2	
Q205	IC	TC74VHC157FT	1	22274157ER2TO	
Q271	IC	SI8008TM	1	22242323R2	
Q272	IC	TA48033BF(TE16L_NQ)	1	22278033DBR2TO	
Q273	IC	BD7820	1	22242300R2	
Q281	IC	K4S641632K-UC60	1	22242462R2	
Q281 or	IC	K4S641632N-LC60	(1)	22242603R2	N
Q281 or	IC	EM638165TS-7G	(1)	22242607R2	
Q282	IC (DSP PROGRAM)	S29AL016D70TFI010(0313)	1	222W0063R303136	
Q282 or	IC (DSP PROGRAM)	ES29LV160ET-70TG(0313)	(1)	222W0069R303136	
Q8001	IC	FLI30502	1	22242481R3	
Q8002	IC	TC74VCX162244FT(EL_F)	1	2227C244DR2TO	
Q8003	IC	TC74VCX162244FT(EL_F)	1	2227C244DR2TO	
Q8005	IC	TA48033BF(TE16L_NQ)	1	22278033DBR2TO	
Q8006	IC	SI8008TM	1	22242323R2	
Q8007	IC	TA48033BF(TE16L_NQ)	1	22278033DBR2TO	
Q8008	IC	TA48018BF(TE16L_NQ)	1	22278018DBR2TO	N
Q8009	IC	BH18LB1WG-TR	1	22242562R2	
Q8080	IC	S-24CS16A0I-J8V1G	1	22242326R2	
Q8081	IC	74LCX74MTCX_F40	1	22242483R2	
Q8082	IC	NC7SZ08P5X_F042	1	22242482R2	
Q8085	IC (VIDEO PROGRAM)	SST25VF016B(0310)	1	222W0081R20310A	
Q8161	IC	TA48018BF(TE16L_NQ)	1	22278018DBR2TO	N
Q8162	IC	SI19185ACTU	1	22242471R3	

Q8305	IC	S-812C50BUC-C5ET2G	1	22242407R2	
Q8306	IC	NC7SZ08P5X_F042	1	22242482R2	
Q8306 or	IC	TC7SZ08FU(TE85L_F)	(1)	22242071R2TO	
Q8309	IC	SN74CB3T3306DCT	1	22242454R2	
Q8401	IC	SI9134CTU	1	22242394R3	
Q8402	IC	TA48018BF(TE16L_NQ)	1	22278018DBR2TO	N
Q8404	IC	BH18LB1WG-TR	1	22242562R2	
Q8405	IC	SN74CB3Q3305PWR	1	22242258R2	
Q8501	IC	SI9233ACTU	1	22242582R3	
Q8593	IC	SI8008TM	1	22242323R2	
Q8651	IC	BD7820	1	22242300R2	
Q8652	IC	BH33FB1WG-TR	1	22242585R2	
Q8653	IC	TA48033BF(TE16L_NQ)	1	22278033DBR2TO	
Q8654	IC	BD7820	1	22242300R2	
Q8661	IC	TMDS141RHARG4	1	22242586R2	N
L201	CHOKE COIL	BLM21PG221SN1	1	230949R2	
L202	CORE	BLM18PG181SN1D	1	2350005R1	
L203	C-CARBON R	RN72K1J-000JE	1	435030004R1	
L204	EMIFIL	BK1608LM182-T	1	230958R1	
L205	CORE	BLM18PG181SN1D	1	2350005R1	
L206	EMIFIL	BK1608LM182-T	1	230958R1	
L219	CORE	BLM18PG181SN1D	1	2350005R1	
L241	EMIFIL	ACF451832-333-T	1	230978R2	
L251	CORE	BLM18PG181SN1D	1	2350005R1	
L261	EMIFIL	BK1608LM182-T	1	230958R1	
L271	CHOKE COIL	NCH-2541	1	231363K470A	
L271 or	COIL	0182-7310-470K-RB	(1)	231389	
L272	CHOKE COIL	BLM21PG221SN1	1	230949R2	
L281	CORE	BLM18PG181SN1D	1	2350005R1	
L282	CORE	BLM18PG181SN1D	1	2350005R1	
L283	CHOKE COIL	BLM21PG221SN1	1	230949R2	
L8001	CORE	BLM18PG181SN1D	1	2350005R1	
L8002	CHOKE COIL	LBC2518T4R7M	1	231364M047R2	
L8004	CORE	BLM18PG181SN1D	1	2350005R1	
L8005	CORE	BLM18PG181SN1D	1	2350005R1	
L8006	CHOKE COIL	LBC2518T4R7M	1	231364M047R2	
L8007	CHOKE COIL	LBC2518T4R7M	1	231364M047R2	
L8008	CHOKE COIL	LBC2518T4R7M	1	231364M047R2	
L8009	C-CARBON R	RN72K1J-000JE	1	435030004R1	

L8010	CORE	BLM18PG181SN1D	1	2350005R1
L8012	CORE	BLM18PG181SN1D	1	2350005R1
L8013	CORE	BLM18PG181SN1D	1	2350005R1
L8014	CHOKE COIL	NCH-2541	1	231363K470A
L8014 or	COIL	0182-7310-470K-RB	(1)	231389
L8015	CHOKE COIL	BLM21PG221SN1	1	230949R2
L8019	EMIFIL	BK1608LL241-T	1	230959R1
L8070	CHOKE COIL	LBC2518T470M	1	231364M470R2
L8091	CORE	BLM18PG181SN1D	1	2350005R1
L8092	CORE	BLM18PG181SN1D	1	2350005R1
L8161	CORE	BLM18PG181SN1D	1	2350005R1
L8162	CORE	BLM18PG181SN1D	1	2350005R1
L8163	CORE	BLM18PG181SN1D	1	2350005R1
L8401	CORE	BLM18PG181SN1D	1	2350005R1
L8402	CORE	BLM18PG181SN1D	1	2350005R1
L8403	CORE	BLM18PG181SN1D	1	2350005R1
L8404	CORE	BLM18PG181SN1D	1	2350005R1
L8405	CORE	BLM18PG181SN1D	1	2350005R1
L8406	C-R NET	MNR12E0APJ000	1	43464900002R2
L8407	C-R NET	MNR12E0APJ000	1	43464900002R2
L8408	CORE	BLM18PG181SN1D	1	2350005R1
L8409	C-R NET	MNR12E0APJ000	1	43464900002R2
L8410	C-R NET	MNR12E0APJ000	1	43464900002R2
L8505	CHOKE COIL	BLM21PG221SN1	1	230949R2
L8507	CHOKE COIL	NCH-2541	1	231363K470A
L8507 or	COIL	0182-7310-470K-RB	(1)	231389
L8508	CHOKE COIL	BLM21PG221SN1	1	230949R2
L8601	CORE	BLM18PG181SN1D	1	2350005R1
L8602	CORE	BLM18PG181SN1D	1	2350005R1
L8603	CORE	BLM18PG181SN1D	1	2350005R1
L8604	CORE	BLM18PG181SN1D	1	2350005R1
L8605	CORE	BLM18PG181SN1D	1	2350005R1
L8606	CORE	BLM18PG181SN1D	1	2350005R1
L8608	EMIFIL	BK1608LM182-T	1	230958R1
L8651	CORE	BLM18PG181SN1D	1	2350005R1
L8652	CORE	BLM18PG181SN1D	1	2350005R1
L8661	CORE	BLM18PG181SN1D	1	2350005R1
L8662	C-R NET	RM7LJ000X04	1	43484700004R2
L8663	C-R NET	RM7LJ000X04	1	43484700004R2

L8664	C-R NET	RM7LJ000X04	1	43484700004R2	
L8665	C-R NET	RM7LJ000X04	1	43484700004R2	
X201	CRYSTAL	HC-49USSMD17.734MHz	1	3010442R2	
X8001	CRYSTAL	FCX-03-19.6608M	1	3010439R2	
X8501	CRYSTAL	FCX-03-27.000MMHz	1	3010473R2	N
C201	C-CERA C	CK725F1A-105Z1	1	332181050R1	
C202	C-CERA C	CK725F1A-105Z1	1	332181050R1	
C203	C-CERA C	CK725F1A-105Z1	1	332181050R1	
C204	C-CERA C	CK725F1A-105Z1	1	332181050R1	
C205	C-CERA C	CK725F1A-105Z1	1	332181050R1	
C206	C-CERA C	CK725F1A-105Z1	1	332181050R1	
C207	C-CERA C	CK725F1A-105Z1	1	332181050R1	
C208	C-CERA C	CK725F1A-105Z1	1	332181050R1	
C209	C-CERA C	CK725F1A-105Z1	1	332181050R1	
C210	C-CERA C	CK725F1A-105Z1	1	332181050R1	
C211	C-CERA C	CK725F1A-105Z1	1	332181050R1	
C212	C-CERA C	CK725F1A-105Z1	1	332181050R1	
C213	C-CERA C	CK725F1A-105Z1	1	332181050R1	
C214	C-CERA C	CK725F1A-105Z1	1	332181050R1	
C215	C-CERA C	CK725F1A-105Z1	1	332181050R1	
C216	C-CERA C	CK725F1A-105Z1	1	332181050R1	
C217	C-CERA C	CK725F1A-105Z1	1	332181050R1	
C218	CHIP ELECT C	CEWX4V-220M	1	3981G2217R2	
C219	C-CERA C	CK725F1A-105Z1	1	332181050R1	
C220	C-CERA C	CK725F1A-105Z1	1	332181050R1	
C221	C-CERA C	CK725F1A-105Z1	1	332181050R1	
C222	C-CERA C	CK725F1A-105Z1	1	332181050R1	
C223	C-CERA C	CK725F1A-105Z1	1	332181050R1	
C224	C-CERA C	CK725F1A-105Z1	1	332181050R1	
C225	C-CERA C	CK725F1A-105Z1	1	332181050R1	
C226	C-CERA C	CK725F1A-105Z1	1	332181050R1	
C227	C-CERA C	CK725F1A-105Z1	1	332181050R1	
C228	C-CERA C	CK725F1A-105Z1	1	332181050R1	
C229	C-CERA C	CK725F1A-105Z1	1	332181050R1	
C230	C-CERA C	CK725F1A-105Z1	1	332181050R1	
C231	C-CERA C	CK725F1A-105Z1	1	332181050R1	
C232	C-CERA C	CK725F1A-105Z1	1	332181050R1	
C233	C-CERA C	CK725F1A-105Z1	1	332181050R1	
C234	C-CERA C	CK725F1A-105Z1	1	332181050R1	

C235	CHIP ELECT C	CEWX4V-220M	1	3981G2217R2
C238	C-CERA C	CC725CH1H-060D1	1	342100602R1
C239	C-CERA C	CC725CH1H-060D1	1	342100602R1
C241	CHIP ELECT C	CEWX4V-220M	1	3981G2217R2
C242	C-CERA C	CK725F1E-104Z1	1	332161040R1
C243	C-CERA C	CC725CH1H-101J1	1	342101014R1
C244	C-CERA C	CK725F1A-105Z1	1	332181050R1
C245	C-CERA C	CK725F1A-105Z1	1	332181050R1
C246	C-CERA C	CK725F1A-105Z1	1	332181050R1
C247	C-CERA C	CK725F1A-105Z1	1	332181050R1
C251	C-CERA C	CK725F1A-105Z1	1	332181050R1
C252	C-CERA C	CK725F1A-105Z1	1	332181050R1
C270	CHIP ELECT C	CEWX4V-22M	1	3981G2207R2
C271	VR C	CE04W16V-470M(VR)	1	394644717T
C272	C-CERA C	CK725B1H-223K1	1	332102235R1
C273	C-CERA C	CK725F1A-105Z1	1	332181050R1
C274	CD C	UCD1A471MNL1GS	1	396634717R2
C275	C-CERA C	CK725F1A-105Z1	1	332181050R1
C276	CHIP ELECT C	CEWX4V-220M	1	3981G2217R2
C277	C-CERA C	CK725F1A-105Z1	1	332181050R1
C278	C-CERA C	CK725B0J-106K	1	332091065R2
C279	C-CERA C	CK725F1A-105Z1	1	332181050R1
C281	C-CERA C	CK725B0J-106K	1	332091065R2
C282	C-CERA C	CK725F1A-105Z1	1	332181050R1
C283	C-CERA C	CC725CH1H-102J1	1	342101024R1
C284	C-CERA C	CK725B0J-106K	1	332091065R2
C285	C-CERA C	CK725F1A-105Z1	1	332181050R1
C286	C-CERA C	CK725F1A-105Z1	1	332181050R1
C287	C-CERA C	CK725F1A-105Z1	1	332181050R1
C288	C-CERA C	CK725F1A-105Z1	1	332181050R1
C289	C-CERA C	CK725F1A-105Z1	1	332181050R1
C290	C-CERA C	CK725F1A-105Z1	1	332181050R1
C291	C-CERA C	CK725F1A-105Z1	1	332181050R1
C292	C-CERA C	CK725F1A-105Z1	1	332181050R1
C295	C-CERA C	CK725F1A-105Z1	1	332181050R1
C8001	C-CERA C	CK725B0J-106K	1	332091065R2
C8002	C-CERA C	CK725F1A-105Z1	1	332181050R1
C8003	C-CERA C	CK725B1H-103K1	1	332101035R1
C8004	C-CERA C	CK725F1A-105Z1	1	332181050R1

C8005	C-CERA C	CK725B0J-106K	1	332091065R2
C8006	C-CERA C	CC725CH1H-120J1	1	342101204R1
C8007	C-CERA C	CC725CH1H-120J1	1	342101204R1
C8008	C-CERA C	CK725F1E-104Z1	1	332161040R1
C8009	C-CERA C	CK725F1E-104Z1	1	332161040R1
C8010	C-CERA C	CK725F1A-105Z1	1	332181050R1
C8011	C-CERA C	CK725B0J-106K	1	332091065R2
C8012	C-CERA C	CK725F1A-105Z1	1	332181050R1
C8013	C-CERA C	CK725F1A-105Z1	1	332181050R1
C8014	C-CERA C	CK725F1A-105Z1	1	332181050R1
C8015	C-CERA C	CK725F1A-105Z1	1	332181050R1
C8016	C-CERA C	CK725F1A-105Z1	1	332181050R1
C8017	C-CERA C	CK725F1A-105Z1	1	332181050R1
C8018	C-CERA C	CK725F1A-105Z1	1	332181050R1
C8019	C-CERA C	CK725F1A-105Z1	1	332181050R1
C8021	C-CERA C	CK725F1A-105Z1	1	332181050R1
C8023	C-CERA C	CK725F1A-105Z1	1	332181050R1
C8024	C-CERA C	CK725F1A-105Z1	1	332181050R1
C8025	C-CERA C	CK725F1A-105Z1	1	332181050R1
C8026	C-CERA C	CK725B0J-106K	1	332091065R2
C8027	C-CERA C	CK725B0J-106K	1	332091065R2
C8028	C-CERA C	CK725F1A-105Z1	1	332181050R1
C8029	C-CERA C	CK725F1A-105Z1	1	332181050R1
C8030	C-CERA C	CK725F1A-105Z1	1	332181050R1
C8031	C-CERA C	CK725F1A-105Z1	1	332181050R1
C8032	C-CERA C	CK725F1A-105Z1	1	332181050R1
C8033	C-CERA C	CK725F1A-105Z1	1	332181050R1
C8034	C-CERA C	CK725F1A-105Z1	1	332181050R1
C8035	C-CERA C	CK725B0J-106K	1	332091065R2
C8036	C-CERA C	CK725B0J-106K	1	332091065R2
C8037	C-CERA C	CK725B0J-106K	1	332091065R2
C8038	C-CERA C	CK725F1E-104Z1	1	332161040R1
C8039	C-CERA C	CK725F1A-105Z1	1	332181050R1
C8040	C-CERA C	CK725F1A-105Z1	1	332181050R1
C8041	C-CERA C	CK725F1E-104Z1	1	332161040R1
C8042	C-CERA C	CK725F1E-104Z1	1	332161040R1
C8043	C-CERA C	CK725F1A-105Z1	1	332181050R1
C8044	C-CERA C	CK725F1A-105Z1	1	332181050R1
C8045	C-CERA C	CK725F1E-104Z1	1	332161040R1

C8046	C-CERA C	CK725F1A-105Z1	1	332181050R1
C8047	C-CERA C	CK725F1E-104Z1	1	332161040R1
C8048	C-CERA C	CK725F1E-104Z1	1	332161040R1
C8049	C-CERA C	CK725F1E-104Z1	1	332161040R1
C8050	C-CERA C	CK725F1E-104Z1	1	332161040R1
C8051	C-CERA C	CK725F1E-104Z1	1	332161040R1
C8052	C-CERA C	CK725F1A-105Z1	1	332181050R1
C8053	C-CERA C	CK725F1E-104Z1	1	332161040R1
C8054	C-CERA C	CK725F1E-104Z1	1	332161040R1
C8055	C-CERA C	CK725F1E-104Z1	1	332161040R1
C8056	C-CERA C	CK725F1E-104Z1	1	332161040R1
C8057	C-CERA C	CK725F1E-104Z1	1	332161040R1
C8058	C-CERA C	CK725F1A-105Z1	1	332181050R1
C8059	C-CERA C	CK725F1E-104Z1	1	332161040R1
C8060	C-CERA C	CK725F1A-105Z1	1	332181050R1
C8061	C-CERA C	CK725F1E-104Z1	1	332161040R1
C8062	C-CERA C	CK725F1E-104Z1	1	332161040R1
C8063	C-CERA C	CK725F1E-104Z1	1	332161040R1
C8064	C-CERA C	CK725F1E-104Z1	1	332161040R1
C8065	C-CERA C	CK725F1E-104Z1	1	332161040R1
C8066	C-CERA C	CK725F1E-104Z1	1	332161040R1
C8067	C-CERA C	CK725F1E-104Z1	1	332161040R1
C8068	C-CERA C	CK725F1A-105Z1	1	332181050R1
C8069	C-CERA C	CK725F1E-104Z1	1	332161040R1
C8070	C-CERA C	CK725B0J-106K	1	332091065R2
C8071	C-CERA C	CK725F1A-105Z1	1	332181050R1
C8072	CHIP ELECT C	CEWX4V-100M	1	3981G1017R2
C8073	C-CERA C	CK725F1A-105Z1	1	332181050R1
C8075	CD C	UCD1A471MNL1GS	1	396634717R2
C8076	VR C	CE04W16V-470M(VR)	1	394644717T
C8077	C-CERA C	CK725B1H-223K1	1	332102235R1
C8078	C-CERA C	CK725F1A-105Z1	1	332181050R1
C8079	C-CERA C	CK725F1A-105Z1	1	332181050R1
C8080	C-CERA C	CK725F1E-104Z1	1	332161040R1
C8082	C-CERA C	CK725F1A-105Z1	1	332181050R1
C8083	C-CERA C	CK725F1A-105Z1	1	332181050R1
C8084	C-CERA C	CK725B0J-106K	1	332091065R2
C8085	C-CERA C	CK725F1A-105Z1	1	332181050R1
C8086	C-CERA C	CK725F1A-105Z1	1	332181050R1

C8087	C-CERA C	CK725F1A-105Z1	1	332181050R1
C8088	C-CERA C	CK725B0J-106K	1	332091065R2
C8089	C-CERA C	CK725F1A-105Z1	1	332181050R1
C8093	C-CERA C	CK725F1A-105Z1	1	332181050R1
C8094	CHIP ELECT C	CEWX4V-220M	1	3981G2217R2
C8095	C-CERA C	CK725F1A-105Z1	1	332181050R1
C8096	CHIP ELECT C	CEWX4V-100M	1	3981G1017R2
C8097	CHIP ELECT C	CEWX4V-220M	1	3981G2217R2
C8098	C-CERA C	CK725F1A-105Z1	1	332181050R1
C8099	C-CERA C	CK725B0J-106K	1	332091065R2
C8103	C-CERA C	CK725F1A-105Z1	1	332181050R1
C8104	C-CERA C	CK725F1A-105Z1	1	332181050R1
C8105	C-CERA C	CK725F1A-105Z1	1	332181050R1
C8106	C-CERA C	CK725F1A-105Z1	1	332181050R1
C8115	C-CERA C	CK725B0J-106K	1	332091065R2
C8161	C-CERA C	CK725F1A-105Z1	1	332181050R1
C8162	CHIP ELECT C	CEWX4V-100M	1	3981G1017R2
C8163	C-CERA C	CK725B1H-102K1	1	332101025R1
C8164	C-CERA C	CK725B0J-106K	1	332091065R2
C8165	C-CERA C	CK725F1E-104Z1	1	332161040R1
C8166	C-CERA C	CK725B0J-106K	1	332091065R2
C8167	C-CERA C	CK725F1E-104Z1	1	332161040R1
C8168	C-CERA C	CK725B0J-106K	1	332091065R2
C8169	C-CERA C	CK725F1E-104Z1	1	332161040R1
C8170	C-CERA C	CK725F1E-104Z1	1	332161040R1
C8171	C-CERA C	CK725F1E-104Z1	1	332161040R1
C8172	C-CERA C	CK725F1E-104Z1	1	332161040R1
C8173	C-CERA C	CK725F1E-104Z1	1	332161040R1
C8174	C-CERA C	CK725F1E-104Z1	1	332161040R1
C8175	C-CERA C	CK725F1E-104Z1	1	332161040R1
C8176	C-CERA C	CK725F1E-104Z1	1	332161040R1
C8177	C-CERA C	CK725F1E-104Z1	1	332161040R1
C8178	C-CERA C	CK725F1E-104Z1	1	332161040R1
C8179	C-CERA C	CK725F1E-104Z1	1	332161040R1
C8180	C-CERA C	CK725F1E-104Z1	1	332161040R1
C8181	C-CERA C	CK725F1E-104Z1	1	332161040R1
C8198	VR C	CE04W16V-470M(VR)	1	394644717T
C8199	VR C	CE04W16V-470M(VR)	1	394644717T
C8326	C-CERA C	CK725F1A-105Z1	1	332181050R1

C8327	C-CERA C	CK725F1A-105Z1	1	332181050R1
C8328	C-CERA C	CK725B0J-106K	1	332091065R2
C8330	C-CERA C	CK725F1A-105Z1	1	332181050R1
C8331	C-CERA C	CK725F1E-104Z1	1	332161040R1
C8348	C-CERA C	CK725B1H-102K1	1	332101025R1
C8399	C-CERA C	CK725B1H-102K1	1	332101025R1
C8401	C-CERA C	CK725B0J-106K	1	332091065R2
C8402	C-CERA C	CK725B0J-106K	1	332091065R2
C8403	C-CERA C	CK725F1A-105Z1	1	332181050R1
C8404	C-CERA C	CK725B1H-102K1	1	332101025R1
C8405	C-CERA C	CK725F1A-105Z1	1	332181050R1
C8406	C-CERA C	CK725B1H-102K1	1	332101025R1
C8408	C-CERA C	CK725B0J-106K	1	332091065R2
C8409	C-CERA C	CK725B0J-106K	1	332091065R2
C8410	C-CERA C	CK725F1A-105Z1	1	332181050R1
C8411	C-CERA C	CK725B1H-102K1	1	332101025R1
C8412	C-CERA C	CK725F1A-105Z1	1	332181050R1
C8413	C-CERA C	CK725B1H-102K1	1	332101025R1
C8414	C-CERA C	CK725F1A-105Z1	1	332181050R1
C8415	C-CERA C	CK725B1H-102K1	1	332101025R1
C8416	C-CERA C	CK725B1H-102K1	1	332101025R1
C8417	C-CERA C	CK725F1A-105Z1	1	332181050R1
C8418	C-CERA C	CK725B0J-106K	1	332091065R2
C8419	C-CERA C	CK725B1H-102K1	1	332101025R1
C8420	C-CERA C	CK725F1A-105Z1	1	332181050R1
C8421	C-CERA C	CK725B1H-102K1	1	332101025R1
C8422	C-CERA C	CK725F1A-105Z1	1	332181050R1
C8423	C-CERA C	CK725B1H-102K1	1	332101025R1
C8424	C-CERA C	CK725F1A-105Z1	1	332181050R1
C8425	C-CERA C	CK725B1H-102K1	1	332101025R1
C8426	C-CERA C	CK725F1A-105Z1	1	332181050R1
C8427	C-CERA C	CK725B1H-102K1	1	332101025R1
C8428	C-CERA C	CK725F1A-105Z1	1	332181050R1
C8429	C-CERA C	CK725B1H-102K1	1	332101025R1
C8430	C-CERA C	CK725F1A-105Z1	1	332181050R1
C8431	C-CERA C	CK725B1H-102K1	1	332101025R1
C8432	C-CERA C	CK725F1A-105Z1	1	332181050R1
C8433	C-CERA C	CK725B1H-102K1	1	332101025R1
C8434	C-CERA C	CK725F1A-105Z1	1	332181050R1

C8435	C-CERA C	CK725B0J-106K	1	332091065R2
C8436	C-CERA C	CK725B0J-106K	1	332091065R2
C8437	C-CERA C	CK725B0J-106K	1	332091065R2
C8438	C-CERA C	CK725B1H-102K1	1	332101025R1
C8439	C-CERA C	CK725B0J-106K	1	332091065R2
C8441	C-CERA C	CK725F1A-105Z1	1	332181050R1
C8442	C-CERA C	CK725B0J-106K	1	332091065R2
C8443	CHIP ELECT C	CEWX4V-220M	1	3981G2217R2
C8444	C-CERA C	CK725F1A-105Z1	1	332181050R1
C8451	C-CERA C	CK725F1A-105Z1	1	332181050R1
C8452	CHIP ELECT C	CEWX4V-100M	1	3981G1017R2
C8501	C-CERA C	CK725B1H-102K1	1	332101025R1
C8502	C-CERA C	CK725B0J-106K	1	332091065R2
C8503	C-CERA C	CK725F1A-105Z1	1	332181050R1
C8504	C-CERA C	CK725B1H-102K1	1	332101025R1
C8505	C-CERA C	CK725F1A-105Z1	1	332181050R1
C8506	C-CERA C	CK725B0J-106K	1	332091065R2
C8507	C-CERA C	CK725B1H-102K1	1	332101025R1
C8508	C-CERA C	CK725F1A-105Z1	1	332181050R1
C8509	C-CERA C	CK725B1H-102K1	1	332101025R1
C8510	C-CERA C	CK725F1A-105Z1	1	332181050R1
C8511	C-CERA C	CK725B1H-102K1	1	332101025R1
C8512	C-CERA C	CK725F1A-105Z1	1	332181050R1
C8513	C-CERA C	CK725B1H-102K1	1	332101025R1
C8514	C-CERA C	CK725F1A-105Z1	1	332181050R1
C8515	C-CERA C	CK725B1H-102K1	1	332101025R1
C8516	C-CERA C	CK725F1A-105Z1	1	332181050R1
C8517	C-CERA C	CK725B1H-102K1	1	332101025R1
C8518	C-CERA C	CK725F1A-105Z1	1	332181050R1
C8519	C-CERA C	CK725F1A-105Z1	1	332181050R1
C8521	C-CERA C	CK725F1E-104Z1	1	332161040R1
C8522	C-CERA C	CK725B0J-106K	1	332091065R2
C8523	C-CERA C	CK725F1A-105Z1	1	332181050R1
C8524	C-CERA C	CK725B0J-106K	1	332091065R2
C8525	C-CERA C	CK725B0J-106K	1	332091065R2
C8527	C-CERA C	CK725B1H-102K1	1	332101025R1
C8530	C-CERA C	CK725F1A-105Z1	1	332181050R1
C8531	C-CERA C	CK725B1H-102K1	1	332101025R1
C8532	C-CERA C	CK725F1A-105Z1	1	332181050R1

C8533	C-CERA C	CK725B1H-102K1	1	332101025R1
C8534	C-CERA C	CK725F1A-105Z1	1	332181050R1
C8535	C-CERA C	CK725B1H-102K1	1	332101025R1
C8536	C-CERA C	CK725F1A-105Z1	1	332181050R1
C8537	C-CERA C	CK725B1H-102K1	1	332101025R1
C8538	C-CERA C	CK725F1A-105Z1	1	332181050R1
C8539	C-CERA C	CK725B1H-102K1	1	332101025R1
C8548	C-CERA C	CK725F1A-105Z1	1	332181050R1
C8549	C-CERA C	CK725B1H-102K1	1	332101025R1
C8550	C-CERA C	CK725F1A-105Z1	1	332181050R1
C8551	C-CERA C	CK725B1H-102K1	1	332101025R1
C8552	C-CERA C	CK725F1A-105Z1	1	332181050R1
C8553	C-CERA C	CK725B1H-102K1	1	332101025R1
C8554	C-CERA C	CK725F1A-105Z1	1	332181050R1
C8555	C-CERA C	CK725B1H-102K1	1	332101025R1
C8556	C-CERA C	CK725F1A-105Z1	1	332181050R1
C8557	C-CERA C	CK725B1H-102K1	1	332101025R1
C8558	C-CERA C	CK725F1A-105Z1	1	332181050R1
C8559	C-CERA C	CK725B1H-102K1	1	332101025R1
C8560	C-CERA C	CK725B0J-106K	1	332091065R2
C8563	C-CERA C	CK725F1A-105Z1	1	332181050R1
C8564	C-CERA C	CK725B0J-106K	1	332091065R2
C8565	C-CERA C	CK725B0J-106K	1	332091065R2
C8566	C-CERA C	CK725B1H-102K1	1	332101025R1
C8567	C-CERA C	CK725F1A-105Z1	1	332181050R1
C8573	C-CERA C	CK725F1A-105Z1	1	332181050R1
C8574	C-CERA C	CC725CH1H-100D1	1	342101002R1
C8575	C-CERA C	CC725CH1H-100D1	1	342101002R1
C8581	C-CERA C	CK725F1E-104Z1	1	332161040R1
C8582	CHIP ELECT C	CEWX4V-100M	1	3981G1017R2
C8583	C-CERA C	CK725F1A-105Z1	1	332181050R1
C8584	C-CERA C	CK725B0J-106K	1	332091065R2
C8585	C-CERA C	CK725B0J-106K	1	332091065R2
C8586	C-CERA C	CK725B1H-223K1	1	332102235R1
C8587	C-CERA C	CK725F1A-105Z1	1	332181050R1
C8588	CD C	UCD1A471MNL1GS	1	396634717R2
C8605	C-CERA C	CK725B1H-102K1	1	332101025R1
C8606	C-CERA C	CK725B1H-102K1	1	332101025R1
C8608	C-CERA C	CK725F1A-105Z1	1	332181050R1

C8609	C-CERA C	CK725B0J-106K	1	332091065R2
C8611	C-CERA C	CK725B1H-102K1	1	332101025R1
C8612	C-CERA C	CK725B1H-102K1	1	332101025R1
C8621	C-CERA C	CK725B1H-102K1	1	332101025R1
C8622	C-CERA C	CK725B1H-102K1	1	332101025R1
C8631	C-CARBON R	RN72K1J-000JE	1	435030004R1
C8632	C-CERA C	CK725B1H-102K1	1	332101025R1
C8641	C-CERA C	CK725B1H-102K1	1	332101025R1
C8642	C-CERA C	CK725B1H-102K1	1	332101025R1
C8653	C-CERA C	CK725F1E-104Z1	1	332161040R1
C8662	C-CERA C	CK725B1H-102K1	1	332101025R1
C8663	C-CERA C	CK725F1A-105Z1	1	332181050R1
C8664	C-CERA C	CK725B1H-102K1	1	332101025R1
C8665	C-CERA C	CK725F1A-105Z1	1	332181050R1
C8666	C-CERA C	CK725B1H-102K1	1	332101025R1
C8669	C-CERA C	CK725F1A-105Z1	1	332181050R1
C8670	C-CERA C	CK725B1H-102K1	1	332101025R1
C8671	C-CERA C	CK725F1A-105Z1	1	332181050R1
C8672	C-CERA C	CK725B1H-102K1	1	332101025R1
C8673	C-CERA C	CK725F1A-105Z1	1	332181050R1
C8674	C-CERA C	CK725B1H-102K1	1	332101025R1
C8675	C-CERA C	CK725F1A-105Z1	1	332181050R1
C8676	C-CERA C	CK725B1H-102K1	1	332101025R1
C8677	C-CERA C	CK725B0J-106K	1	332091065R2
C8680	C-CERA C	CK725B0J-106K	1	332091065R2
C8681	C-CERA C	CK725F1A-105Z1	1	332181050R1
C8682	C-CERA C	CK725B1H-102K1	1	332101025R1
C8683	VR C	CE04W16V-470M(VR)	1	394644717T
C8684	C-CERA C	CK725F1A-105Z1	1	332181050R1
C8685	C-CERA C	CK725F1E-104Z1	1	332161040R1
C8687	C-CERA C	CK725F1E-104Z1	1	332161040R1
C8688	C-CERA C	CK725F1E-104Z1	1	332161040R1
C8689	C-CERA C	CK725F1E-104Z1	1	332161040R1
C8690	C-CERA C	CK725F1E-104Z1	1	332161040R1
R200	C-CARBON R	RN72K1J-221JE	1	435032214R1
R201	C-CARBON R	RN72K1J-103JE	1	435031034R1
R202	C-CARBON R	RN72K1J-103JE	1	435031034R1
R203	C-CARBON R	RN72K1J-103JE	1	435031034R1
R205	C-CARBON R	RN72K1J-103JE	1	435031034R1

R206	C-CARBON R	RN72K1J-221JE	1	435032214R1
R207	C-CARBON R	RN72K1J-221JE	1	435032214R1
R208	C-CARBON R	RN72K1J-103JE	1	435031034R1
R209	C-CARBON R	RN72K1J-470JE	1	435034704R1
R210	C-R NET	RM7LJ330X04	1	43484733004R2
R211	C-R NET	RM7LJ330X04	1	43484733004R2
R212	C-R NET	RM7LJ330X04	1	43484733004R2
R213	C-R NET	RM7LJ330X04	1	43484733004R2
R214	C-R NET	RM7LJ330X04	1	43484733004R2
R215	C-R NET	RM7LJ330X04	1	43484733004R2
R216	C-R NET	RM7LJ330X04	1	43484733004R2
R217	C-R NET	RM7LJ330X04	1	43484733004R2
R218	C-R NET	RM7LJ330X04	1	43484733004R2
R221	C-CARBON R	RN72K1J-750JE	1	435037504R1
R230	C-CARBON R	RN72K1J-331JE	1	435033314R1
R231	C-CARBON R	RN72K1J-331JE	1	435033314R1
R232	C-CARBON R	RN72K1J-331JE	1	435033314R1
R233	C-CARBON R	RN72K1J-470JE	1	435034704R1
R234	C-CARBON R	RN72K1J-331JE	1	435033314R1
R235	C-CARBON R	RN72K1J-331JE	1	435033314R1
R236	C-CARBON R	RN72K1J-470JE	1	435034704R1
R237	C-CARBON R	RN72K1J-331JE	1	435033314R1
R238	C-CARBON R	RN72K1J-221JE	1	435032214R1
R239	C-CARBON R	RN72K1J-470JE	1	435034704R1
R240	C-CARBON R	RN72K1J-331JE	1	435033314R1
R241	C-CARBON R	RN72K1J-331JE	1	435033314R1
R242	C-CARBON R	RN72K1J-470JE	1	435034704R1
R243	C-CARBON R	RN72K1J-221JE	1	435032214R1
R244	C-CARBON R	RN72K1J-470JE	1	435034704R1
R245	C-CARBON R	RN72K1J-103JE	1	435031034R1
R246	C-CARBON R	RN72K1J-000JE	1	435030004R1
R250	C-CARBON R	RN72K1J-472JE	1	435034724R1
R251	C-CARBON R	RN72K1J-221JE	1	435032214R1
R252	C-CARBON R	RN72K1J-331JE	1	435033314R1
R253	C-CARBON R	RN72K1J-470JE	1	435034704R1
R254	C-CARBON R	RN72K1J-470JE	1	435034704R1
R255	C-CARBON R	RN72K1J-470JE	1	435034704R1
R256	C-CARBON R	RN72K1J-470JE	1	435034704R1
R257	C-CARBON R	RN72K1J-470JE	1	435034704R1

R258	C-CARBON R	RN72K1J-470JE	1	435034704R1
R259	C-CARBON R	RN72K1J-331JE	1	435033314R1
R260	C-CARBON R	RN72K1J-470JE	1	435034704R1
R261	C-CARBON R	RN72K1J-470JE	1	435034704R1
R262	C-CARBON R	RN72K1J-331JE	1	435033314R1
R263	C-CARBON R	RN72K1J-331JE	1	435033314R1
R264	C-CARBON R	RN72K1J-331JE	1	435033314R1
R265	C-CARBON R	RN72K1J-470JE	1	435034704R1
R266	C-CARBON R	RN72K1J-221JE	1	435032214R1
R267	C-CARBON R	RN72K1J-105JE	1	435031054R1
R268	C-CARBON R	RN72K1J-331JE	1	435033314R1
R269	C-CARBON R	RN72K1J-331JE	1	435033314R1
R270	C-CARBON R	RN72K1J-331JE	1	435033314R1
R271	C-CARBON R	RN72K1J-470JE	1	435034704R1
R272	C-CARBON R	RN72K1J-331JE	1	435033314R1
R273	C-CARBON R	RN72K1J-331JE	1	435033314R1
R274	C-CARBON R	RN72K1J-470JE	1	435034704R1
R275	C-CARBON R	RN72K1J-221JE	1	435032214R1
R276	C-CARBON R	RN72K1J-221JE	1	435032214R1
R277	C-CARBON R	RN72K1J-151JE	1	435031514R1
R278	C-CARBON R	RN72K1J-331JE	1	435033314R1
R279	C-CARBON R	RN72K1J-331JE	1	435033314R1
R280	C-CARBON R	RN72K1J-470JE	1	435034704R1
R281	C-CARBON R	RN72K1J-103JE	1	435031034R1
R282	C-CARBON R	RN72K1J-103JE	1	435031034R1
R283	C-CARBON R	RN72K1J-103JE	1	435031034R1
R284	C-CARBON R	RN72K1J-103JE	1	435031034R1
R285	C-CARBON R	RN72K1J-103JE	1	435031034R1
R286	C-CARBON R	RN72K1J-331JE	1	435033314R1
R287	C-CARBON R	RN72K1J-103JE	1	435031034R1
R288	C-CARBON R	RN72K1J-103JE	1	435031034R1
R289	C-CARBON R	RN72K1J-472JE	1	435034724R1
R290	C-CARBON R	RN72K1J-472JE	1	435034724R1
R291	C-CARBON R	RN72K1J-332JE	1	435033324R1
R292	C-CARBON R	RN72K1J-333JE	1	435033334R1
R293	C-CARBON R	RN72K1J-152JE	1	435031524R1
R294	C-CARBON R	RN72K1J-152JE	1	435031524R1
R295	C-CARBON R	RN72K1J-333JE	1	435033334R1
R296	C-CARBON R	RN72K1J-224JE	1	435032244R1

R297	C-CARBON R	RN72K1J-223JE	1	435032234R1
R8001	C-R NET	RM7LJ103X04	1	43484710304R2
R8002	C-CARBON R	RN72K1J-103JE	1	435031034R1
R8003	C-CARBON R	RN72K1J-221JE	1	435032214R1
R8004	C-CARBON R	RN72K1J-103JE	1	435031034R1
R8005	C-CARBON R	RN72K1J-103JE	1	435031034R1
R8006	C-CARBON R	RN72K1J-470JE	1	435034704R1
R8007	C-CARBON R	RN72K1J-470JE	1	435034704R1
R8008	C-CARBON R	RN72K1J-470JE	1	435034704R1
R8009	C-CARBON R	RN72K1J-470JE	1	435034704R1
R8010	C-CARBON R	RN72K1J-103JE	1	435031034R1
R8011	C-CARBON R	RN72K1J-470JE	1	435034704R1
R8012	C-CARBON R	RN72K1J-470JE	1	435034704R1
R8013	C-CARBON R	RN72K1J-221JE	1	435032214R1
R8014	C-CARBON R	RN72K1J-221JE	1	435032214R1
R8015	C-CARBON R	RN72K1J-221JE	1	435032214R1
R8016	C-R NET	RM7LJ220X04	1	43484722004R2
R8017	C-R NET	RM7LJ220X04	1	43484722004R2
R8018	C-R NET	RM7LJ220X04	1	43484722004R2
R8019	C-R NET	RM7LJ220X04	1	43484722004R2
R8020	C-R NET	RM7LJ220X04	1	43484722004R2
R8021	C-R NET	RM7LJ220X04	1	43484722004R2
R8022	C-R NET	RM7LJ220X04	1	43484722004R2
R8023	C-R NET	RM7LJ220X04	1	43484722004R2
R8029	C-CARBON R	RN72K1J-103JE	1	435031034R1
R8030	C-CARBON R	RN72K1J-103JE	1	435031034R1
R8031	C-CARBON R	RN72K1J-103JE	1	435031034R1
R8032	C-CARBON R	RN72K1J-103JE	1	435031034R1
R8033	C-CARBON R	RN72K1J-000JE	1	435030004R1
R8039	C-CARBON R	RN72K1J-560JE	1	435035604R1
R8041	C-CARBON R	RN72K1J-103JE	1	435031034R1
R8042	C-CARBON R	RN72K1J-220JE	1	435032204R1
R8043	C-CARBON R	RN72K1J-750JE	1	435037504R1
R8044	C-CARBON R	RN72K1J-220JE	1	435032204R1
R8045	C-CARBON R	RN72K1J-680JE	1	435036804R1
R8046	C-CARBON R	RN72K1J-220JE	1	435032204R1
R8047	C-CARBON R	RN72K1J-750JE	1	435037504R1
R8048	C-CARBON R	RN72K1J-680JE	1	435036804R1
R8049	C-CARBON R	RN72K1J-471JE	1	435034714R1

R8050	C-CARBON R	RN72K1J-103JE	1	435031034R1
R8051	C-CARBON R	RN72K1J-220JE	1	435032204R1
R8052	C-CARBON R	RN72K1J-103JE	1	435031034R1
R8053	C-CARBON R	RN72K1J-220JE	1	435032204R1
R8054	C-CARBON R	RN72K1J-103JE	1	435031034R1
R8055	C-CARBON R	RN72K1J-220JE	1	435032204R1
R8056	C-CARBON R	RN72K1J-750JE	1	435037504R1
R8057	C-CARBON R	RN72K1J-680JE	1	435036804R1
R8058	C-CARBON R	RN72K1J-471JE	1	435034714R1
R8059	C-R NET	RM7LJ103X04	1	43484710304R2
R8060	C-CARBON R	RN72K1J-680JE	1	435036804R1
R8061	C-CARBON R	RN72K1J-471JE	1	435034714R1
R8062	C-R NET	RM7LJ103X04	1	43484710304R2
R8063	C-CARBON R	RN72K1J-680JE	1	435036804R1
R8064	C-CARBON R	RN72K1J-471JE	1	435034714R1
R8065	C-CARBON R	RN72K1J-222JE	1	435032224R1
R8066	C-CARBON R	RN72K1J-222JE	1	435032224R1
R8068	C-CARBON R	RN72K1J-103JE	1	435031034R1
R8070	C-CARBON R	RN72K1J-272JE	1	435032724R1
R8071	C-CARBON R	RN72K1J-272JE	1	435032724R1
R8075	C-CARBON R	RN72K1J-750JE	1	435037504R1
R8080	C-CARBON R	RN72K1J-272JE	1	435032724R1
R8081	C-CARBON R	RN72K1J-272JE	1	435032724R1
R8085	C-CARBON R	RN72K1J-103JE	1	435031034R1
R8087	C-CARBON R	RN72K1J-103JE	1	435031034R1
R8090	C-CARBON R	RN72K1J-333JE	1	435033334R1
R8091	C-CARBON R	RN72K1J-152JE	1	435031524R1
R8092	C-CARBON R	RN72K1J-332JE	1	435033324R1
R8093	C-CARBON R	RN72K1J-152JE	1	435031524R1
R8114	C-CARBON R	RN72K1J-000JE	1	435030004R1
R8115	C-CARBON R	RN72K1J-000JE	1	435030004R1
R8160	C-CARBON R	RN72K1J-332JE	1	435033324R1
R8161	C-CARBON R	RN72K1J-681JE	1	435036814R1
R8162	C-CARBON R	RN72K1J-101JE	1	435031014R1
R8163	C-CARBON R	RN72K1J-472JE	1	435034724R1
R8164	C-CARBON R	RN72K1J-472JE	1	435034724R1
R8165	C-CARBON R	RN72K1J-103JE	1	435031034R1
R8332	C-CARBON R	RN72K1J-102JE	1	435031024R1
R8333	C-CARBON R	RN72K1J-103JE	1	435031034R1

R8334	C-CARBON R	RN72K1J-182JE	1	435031824R1
R8335	C-CARBON R	RN72K1J-182JE	1	435031824R1
R8336	C-CARBON R	RN72K1J-472JE	1	435034724R1
R8337	C-CARBON R	RN72K1J-473JE	1	435034734R1
R8338	C-CARBON R	RN72K1J-473JE	1	435034734R1
R8339	C-CARBON R	RN72K2E-470JE	1	435224704R1
R8401	C-R NET	RM7LJ220X04	1	43484722004R2
R8402	C-CARBON R	RN72K1J-221JE	1	435032214R1
R8403	C-R NET	RM7LJ220X04	1	43484722004R2
R8404	C-CARBON R	RN72K1J-220JE	1	435032204R1
R8405	C-CARBON R	RN72K1J-220JE	1	435032204R1
R8408	C-CARBON R	RN72K1J-220JE	1	435032204R1
R8409	C-CARBON R	RN72K1J-101JE	1	435031014R1
R8410	C-CARBON R	RN72K1J-681JE	1	435036814R1
R8411	C-CARBON R	RN72K1J-472JE	1	435034724R1
R8414	C-CARBON R	RN72K1J-472JE	1	435034724R1
R8415	C-CARBON R	RN72K1J-472JE	1	435034724R1
R8416	C-R NET	RM7LJ220X04	1	43484722004R2
R8417	C-R NET	RM7LJ220X04	1	43484722004R2
R8418	C-R NET	RM7LJ220X04	1	43484722004R2
R8419	C-R NET	RM7LJ220X04	1	43484722004R2
R8420	C-R NET	RM7LJ220X04	1	43484722004R2
R8421	C-R NET	RM7LJ220X04	1	43484722004R2
R8422	C-R NET	RM7LJ220X04	1	43484722004R2
R8423	C-R NET	RM7LJ220X04	1	43484722004R2
R8424	C-R NET	RM7LJ220X04	1	43484722004R2
R8425	C-CARBON R	RN72K1J-220JE	1	435032204R1
R8426	C-CARBON R	RN72K1J-473JE	1	435034734R1
R8427	C-CARBON R	RN72K1J-473JE	1	435034734R1
R8429	C-CARBON R	RN72K1J-220JE	1	435032204R1
R8431	C-CARBON R	RN72K1J-472JE	1	435034724R1
R8432	C-CARBON R	RN72K1J-220JE	1	435032204R1
R8442	C-CARBON R	RN72K1J-102JE	1	435031024R1
R8465	C-CARBON R	RN72K1J-102JE	1	435031024R1
R8501	C-CARBON R	RN72K1J-330JE	1	435033304R1
R8502	C-CARBON R	RN72K1J-330JE	1	435033304R1
R8503	C-CARBON R	RN72K1J-330JE	1	435033304R1
R8504	C-R NET	RM7LJ330X04	1	43484733004R2
R8505	C-R NET	RM7LJ330X04	1	43484733004R2

R8506	C-CARBON R	RN72K1J-120JE	1	435031204R1
R8507	C-R NET	RM7LJ330X04	1	43484733004R2
R8508	C-R NET	RM7LJ330X04	1	43484733004R2
R8509	C-R NET	RM7LJ330X04	1	43484733004R2
R8510	C-R NET	RM7LJ330X04	1	43484733004R2
R8511	C-R NET	RM7LJ330X04	1	43484733004R2
R8512	C-R NET	RM7LJ330X04	1	43484733004R2
R8513	C-R NET	RM7LJ330X04	1	43484733004R2
R8514	C-CARBON R	RN72K1J-472JE	1	435034724R1
R8515	C-CARBON R	RN72K1J-472JE	1	435034724R1
R8516	C-CARBON R	RN72K1J-101JE	1	435031014R1
R8517	C-CARBON R	RN72K1J-101JE	1	435031014R1
R8518	C-CARBON R	RN72K1J-472JE	1	435034724R1
R8519	C-CARBON R	RN72K1J-151JE	1	435031514R1
R8520	C-CARBON R	RN72K1J-330JE	1	435033304R1
R8521	C-CARBON R	RN72K1J-330JE	1	435033304R1
R8522	C-R NET	RM7LJ330X04	1	43484733004R2
R8523	C-CARBON R	RN72K1J-330JE	1	435033304R1
R8524	C-CARBON R	RN72K1J-330JE	1	435033304R1
R8525	C-CARBON R	RN72K1J-472JE	1	435034724R1
R8526	C-CARBON R	RN72K1J-472JE	1	435034724R1
R8527	C-CARBON R	RN72K1J-562JE	1	435035624R1
R8528	C-CARBON R	RN72K1J-562JE	1	435035624R1
R8529	C-CARBON R	RN72K1J-102JE	1	435031024R1
R8530	C-CARBON R	RN72K1J-105JE	1	435031054R1
R8532	C-CARBON R	RN72K1J-000JE	1	435030004R1
R8533	C-CARBON R	RN72K1J-000JE	1	435030004R1
R8591	C-CARBON R	RN72K1J-332JE	1	435033324R1
R8592	C-CARBON R	RN72K1J-333JE	1	435033334R1
R8593	C-CARBON R	RN72K1J-152JE	1	435031524R1
R8594	C-CARBON R	RN72K1J-152JE	1	435031524R1
R8595	C-CARBON R	RN72K1J-101JE	1	435031014R1
R8597	C-CARBON R	RN72K1J-101JE	1	435031014R1
R8602	C-CARBON R	RN72K1J-000JE	1	435030004R1
R8607	C-CARBON R	RN72K1J-473JE	1	435034734R1
R8608	C-CARBON R	RN72K1J-473JE	1	435034734R1
R8609	C-CARBON R	RN72K1J-000JE	1	435030004R1
R8612	C-CARBON R	RN72K1J-000JE	1	435030004R1
R8617	C-CARBON R	RN72K1J-473JE	1	435034734R1

R8618	C-CARBON R	RN72K1J-473JE	1	435034734R1	
R8619	C-CARBON R	RN72K1J-000JE	1	435030004R1	
R8622	C-CARBON R	RN72K1J-000JE	1	435030004R1	
R8627	C-CARBON R	RN72K1J-473JE	1	435034734R1	
R8628	C-CARBON R	RN72K1J-473JE	1	435034734R1	
R8629	C-CARBON R	RN72K1J-000JE	1	435030004R1	
R8637	C-CARBON R	RN72K1J-473JE	1	435034734R1	
R8638	C-CARBON R	RN72K1J-473JE	1	435034734R1	
R8639	C-CARBON R	RN72K1J-103JE	1	435031034R1	
R8647	C-CARBON R	RN72K1J-473JE	1	435034734R1	
R8648	C-CARBON R	RN72K1J-473JE	1	435034734R1	
R8649	C-CARBON R	RN72K1J-103JE	1	435031034R1	
R8651	C-CARBON R	RN72K1J-223JE	1	435032234R1	
R8652	C-CARBON R	RN72K1J-224JE	1	435032244R1	
R8653	C-CARBON R	RN72K1J-333JE	1	435033334R1	
R8654	C-CARBON R	RN72K1J-223JE	1	435032234R1	
R8655	C-CARBON R	RN72K1J-224JE	1	435032244R1	
R8656	C-CARBON R	RN72K1J-333JE	1	435033334R1	
R8659	C-CARBON R	RN72K1J-000JE	1	435030004R1	
R8660	C-CARBON R	RN72K1J-000JE	1	435030004R1	
R8661	C-CARBON R	RN72K1J-000JE	1	435030004R1	
R8662	C-CARBON R	RN72K1J-000JE	1	435030004R1	
R8663	C-CARBON R	RN72K1J-000JE	1	435030004R1	
R8667	C-CARBON R	RN72K1J-473JE	1	435034734R1	
R8668	C-CARBON R	RN72K1J-473JE	1	435034734R1	
R8669	C-CARBON R	RN72K1J-000JE	1	435030004R1	
R8670	C-CARBON R	RN72K1J-000JE	1	435030004R1	
R8672	C-CARBON R	RN72K1J-103JE	1	435031034R1	
R8673	C-CARBON R	RN72K1J-472JE	1	435034724R1	
R8674	C-CARBON R	RN72K1J-103JE	1	435031034R1	
R8675	C-CARBON R	RN72K1J-103JE	1	435031034R1	
R8676	C-CARBON R	RN72K1J-103JE	1	435031034R1	
R8677	C-CARBON R	RN72K1J-472JE	1	435034724R1	
R8678	C-CARBON R	RN72K1J-472JE	1	435034724R1	
E8661	CRIMP AS	.	1	2061712080UL	
JL8001B	WIRE TRAP	NPLG-5P588	1	25055626	
P001	PWB	BCHDM-0063	1	25140063C	N
P005	PWB	BCHDM-0064	{ 1 }	25140064	N
P006	PWB	BCETC-0065	{ 1 }	25140065	N

P2801B	SOCKET	NSCT-11P2141	1	25052244	
P8001B	SOCKET	IMSA-9111S-16L	1	25053258	
P8002B	SOCKET	IMSA-9111S-24L	1	25053259	
P8003B	SOCKET	IMSA-9111S-16L	1	25053258	
P8011	SOCKET	IMSA-9618S-04A	1	25053329R2	N
P8302	SOCKET	YKF45-7037V	1	25053253R3	
P8601	SOCKET	YKF45-7037V	1	25053253R3	
P8611	SOCKET	YKF45-7037V	1	25053253R3	
P8621	SOCKET	YKF45-7037V	1	25053253R3	
P8631	SOCKET	YKF45-7037V	1	25053253R3	
P8641	SOCKET	YKF45-7037V	1	25053253R3	
P8651	SOCKET	YKF45-7037V	1	25053253R3	
P8661	SOCKET	YKF45-7037V	1	25053253R3	
P8662	SOCKET	YKF45-7037V	1	25053253R3	

U005 SP terminal pc board AS (BATRM-0029-1G/1H)

U0051 FRONT HIGH L/R SP terminal pc board AS (BATRM-0030-1G/1H)

CIRCUIT NO.	PART NAME	DESCRIPTION	Q'TY	PART NO. (SN)	REMARKS
D6600	DIODE	ISS133	1	223163T	
D6603	DIODE	ISS133	1	223163T	
D6605	DIODE	ISS133	1	223163T	
D6607	DIODE	ISS133	1	223163T	
Q6601	TR	KRC105M	1	2215830T	
Q6601 or	TR	RN1205	(1)	2214660T	
Q6602	TR	KRC105M	1	2215830T	
Q6602 or	TR	RN1205	(1)	2214660T	
Q6603	TR	KRC105M	1	2215830T	
Q6603 or	TR	RN1205	(1)	2214660T	
Q6604	TR	KRC105M	1	2215830T	
Q6604 or	TR	RN1205	(1)	2214660T	
L6600	S COIL	S-1.3C	1	231176S	<EXCEPT MDC,MDD,MDF>
L6600 or	S COIL	SC-0.8X11.5X12.5T-6.5L	(1)	231393S	<EXCEPT MDC,MDD,MDF>
L6601	S COIL	S-1.3C	1	231176S	<EXCEPT MDC,MDD,MDF>
L6601 or	S COIL	SC-0.8X11.5X12.5T-6.5L	(1)	231393S	<EXCEPT MDC,MDD,MDF>
L6602	S COIL	S-1.3C	1	231176S	<EXCEPT MDC,MDD,MDF>
L6602 or	S COIL	SC-0.8X11.5X12.5T-6.5L	(1)	231393S	<EXCEPT MDC,MDD,MDF>
L6603	S COIL	S-1.3C	1	231176S	<EXCEPT MDC,MDD,MDF>
L6603 or	S COIL	SC-0.8X11.5X12.5T-6.5L	(1)	231393S	<EXCEPT MDC,MDD,MDF>

L6604	S COIL	S-1.3C	1	231176S	<EXCEPT MDC,MDD,MDF>
L6604 or	S COIL	SC-0.8X11.5X12.5T-6.5L	(1)	231393S	<EXCEPT MDC,MDD,MDF>
L6605	S COIL	S-1.3C	1	231176S	<EXCEPT MDC,MDD,MDF>
L6605 or	S COIL	SC-0.8X11.5X12.5T-6.5L	(1)	231393S	<EXCEPT MDC,MDD,MDF>
L6606	S COIL	S-1.3C	1	231176S	<EXCEPT MDC,MDD,MDF>
L6606 or	S COIL	SC-0.8X11.5X12.5T-6.5L	(1)	231393S	<EXCEPT MDC,MDD,MDF>
C6030	TF C	ECQ-V50V-473J	1	374724734T	
C6031	TF C	ECQ-V50V-473J	1	374724734T	
C6032	TF C	ECQ-V50V-473J	1	374724734T	
C6033	TF C	ECQ-V50V-473J	1	374724734T	
C6034	TF C	ECQ-V50V-473J	1	374724734T	
C6035	TF C	ECQ-V50V-473J	1	374724734T	
C6036	TF C	ECQ-V50V-473J	1	374724734T	
C6600	TF C	ECQ-V50V-103J	1	374721034T	
C6602	TF C	ECQ-V50V-103J	1	374721034T	
C6603	TF C	ECQ-V50V-103J	1	374721034T	
C6605	TF C	ECQ-V50V-103J	1	374721034T	
C6607	TF C	ECQ-V50V-103J	1	374721034T	
C6640	TF C	ECQ-V50V-103J	1	374721034T	<EXCEPT MDC,MDD,MDF>
C6641	TF C	ECQ-V50V-103J	1	374721034T	<EXCEPT MDC,MDD,MDF>
C6642	TF C	ECQ-V50V-103J	1	374721034T	<EXCEPT MDC,MDD,MDF>
C6643	TF C	ECQ-V50V-103J	1	374721034T	<EXCEPT MDC,MDD,MDF>
C6644	TF C	ECQ-V50V-103J	1	374721034T	<EXCEPT MDC,MDD,MDF>
C6645	TF C	ECQ-V50V-103J	1	374721034T	<EXCEPT MDC,MDD,MDF>
C6646	TF C	ECQ-V50V-103J	1	374721034T	<EXCEPT MDC,MDD,MDF>
C6647	TF C	ECQ-V50V-103J	1	374721034T	<EXCEPT MDC,MDD,MDF>
C6648	TF C	ECQ-V50V-103J	1	374721034T	<EXCEPT MDC,MDD,MDF>
C6650	MKT C	B32529C0102J289	1	376491024T	<EXCEPT MDC,MDD,MDF>
C6651	MKT C	B32529C0102J289	1	376491024T	<EXCEPT MDC,MDD,MDF>
C6652	MKT C	B32529C0102J289	1	376491024T	<EXCEPT MDC,MDD,MDF>
C6653	MKT C	B32529C0102J289	1	376491024T	<EXCEPT MDC,MDD,MDF>
C6654	MKT C	B32529C0102J289	1	376491024T	<EXCEPT MDC,MDD,MDF>
C6655	MKT C	B32529C0102J289	1	376491024T	<EXCEPT MDC,MDD,MDF>
C6656	MKT C	B32529C0102J289	1	376491024T	<EXCEPT MDC,MDD,MDF>
C6657	MKT C	B32529C0102J289	1	376491024T	<EXCEPT MDC,MDD,MDF>
C6658	MKT C	B32529C0102J289	1	376491024T	<EXCEPT MDC,MDD,MDF>
R6130	METAL R	RNU1WCJ-8.2	1	453630824T	
R6131	METAL R	RNU1WCJ-8.2	1	453630824T	
R6132	METAL R	RNU1WCJ-8.2	1	453630824T	

R6133	METAL R	RNU1WCJ-8.2	1	453630824T	
R6134	METAL R	RNU1WCJ-8.2	1	453630824T	
R6135	METAL R	RNU1WCJ-8.2	1	453630824T	
R6136	METAL R	RNU1WCJ-8.2	1	453630824T	
R6600	CARBON R	R16J-22	1	417342204T	<EXCEPT MDC,MDD,MDF>
R6601	CARBON R	R16J-22	1	417342204T	<EXCEPT MDC,MDD,MDF>
R6602	CARBON R	R16J-22	1	417342204T	<EXCEPT MDC,MDD,MDF>
R6603	CARBON R	R16J-22	1	417342204T	<EXCEPT MDC,MDD,MDF>
R6604	CARBON R	R16J-22	1	417342204T	<EXCEPT MDC,MDD,MDF>
R6605	CARBON R	R16J-22	1	417342204T	<EXCEPT MDC,MDD,MDF>
R6606	CARBON R	R16J-22	1	417342204T	<EXCEPT MDC,MDD,MDF>
R6610	CARBON R	R16J-22	1	417342204T	<EXCEPT MDC,MDD,MDF>
R6611	CARBON R	R16J-22	1	417342204T	<EXCEPT MDC,MDD,MDF>
R6612	CARBON R	R16J-22	1	417342204T	<EXCEPT MDC,MDD,MDF>
R6613	CARBON R	R16J-22	1	417342204T	<EXCEPT MDC,MDD,MDF>
R6614	CARBON R	R16J-22	1	417342204T	<EXCEPT MDC,MDD,MDF>
R6615	CARBON R	R16J-22	1	417342204T	<EXCEPT MDC,MDD,MDF>
R6616	CARBON R	R16J-22	1	417342204T	<EXCEPT MDC,MDD,MDF>
R6690	METAL O R	RS1/2WBJ-10	1	443521004T	
R6691	METAL O R	RS1/2WBJ-390	1	443523914T	
R6692	METAL O R	RS1/2WBJ-390	1	443523914T	
JL6600B	SOCKET	NSCT-7P99	1	25050271	
JL6603B	SOCKET	NSCT-9P101	1	25050273	
JL6604B	SOCKET	NSCT-5P97	1	25050269	<MDC,MDD,MDF>
JL6605A	WIRE HOL	NSCT-5P896	1	25051109	
JL6610A	WIRE HOL	NSCT-7P878	1	25051091	
JL6620B	WIRE TRAP	NPLG-7P590	1	25055628	
P003	PWB	BCTRM-0029	1	25140029B	N
P004	PWB	BCTRM-0030	{ 1 }	25140030	<EXCEPT MDC,MDD,MDF>
P6601	TRM	NTM-2PDMCR400	1	25060472	
P6602	TRM	NTM-4PDMNRR420	1	25060492	
P6603	TRM	NTM-4PDMNRR420	1	25060492	
P6604	TRM	NTM-4PDMNRR420	1	25060492	
P6607	TRM	NTM-4PDMNRR420	1	25060492	<EXCEPT MDC,MDD,MDF>
RL6600	RELAY	NRL-2P5A-DC24-129	1	25065563A	
RL6600 or	RELAY	NRL-2P5A-DC24-193	(1)	25065703	
RL6602	RELAY	NRL-2P5A-DC24-129	1	25065563A	
RL6602 or	RELAY	NRL-2P5A-DC24-193	(1)	25065703	
RL6603	RELAY	NRL-2P5A-DC24-129	1	25065563A	

RL6603 or	RELAY	NRL-2P5A-DC24-193	(1)	25065703
RL6605	RELAY	NRL-2P5A-DC24-129	1	25065563A
RL6605 or	RELAY	NRL-2P5A-DC24-193	(1)	25065703
RL6607	RELAY	NRL-2P5A-DC24-129	1	25065563A
RL6607 or	RELAY	NRL-2P5A-DC24-193	(1)	25065703

U006 Driver amp. pc board AS (BACLA-0020-1A)

CIRCUIT NO.	PART NAME	DESCRIPTION	Q'TY	PART NO. (SN)	REMARKS
D5000	ZENER D	MTZJ5.6B	1	224470562T	
D5001	ZENER D	MTZJ5.6B	1	224470562T	
D5002	ZENER D	MTZJ5.6B	1	224470562T	
D5003	ZENER D	MTZJ5.6B	1	224470562T	
D5004	ZENER D	MTZJ5.6B	1	224470562T	
D5005	ZENER D	MTZJ5.6B	1	224470562T	
D5006	ZENER D	MTZJ5.6B	1	224470562T	
Q5000	TR	2SC2240-BL(TPE2_F)	1	2211406T	
Q5001	TR	2SC2240-BL(TPE2_F)	1	2211406T	
Q5002	TR	2SC2240-BL(TPE2_F)	1	2211406T	
Q5003	TR	2SC2240-BL(TPE2_F)	1	2211406T	
Q5004	TR	2SC2240-BL(TPE2_F)	1	2211406T	
Q5005	TR	2SC2240-BL(TPE2_F)	1	2211406T	
Q5006	TR	2SC2240-BL(TPE2_F)	1	2211406T	
Q5010	TR	2SC2240-BL(TPE2_F)	1	2211406T	
Q5011	TR	2SC2240-BL(TPE2_F)	1	2211406T	
Q5012	TR	2SC2240-BL(TPE2_F)	1	2211406T	
Q5013	TR	2SC2240-BL(TPE2_F)	1	2211406T	
Q5014	TR	2SC2240-BL(TPE2_F)	1	2211406T	
Q5015	TR	2SC2240-BL(TPE2_F)	1	2211406T	
Q5016	TR	2SC2240-BL(TPE2_F)	1	2211406T	
Q5030	TR	2SA949-Y(TPE6_F)	1	2211354T	
Q5030A	RETAINER	(CLA2)	1	27142140	N
Q5031	TR	2SA949-Y(TPE6_F)	1	2211354T	
Q5031A	RETAINER	(CLA2)	1	27142140	N
Q5032	TR	2SA949-Y(TPE6_F)	1	2211354T	
Q5032A	RETAINER	(CLA2)	1	27142140	N
Q5033	TR	2SA949-Y(TPE6_F)	1	2211354T	
Q5033A	RETAINER	(CLA2)	1	27142140	N
Q5034	TR	2SA949-Y(TPE6_F)	1	2211354T	

Q5034A	RETAINER	(CLA2)	1	27142140	N
Q5035	TR	2SA949-Y(TPE6_F)	1	2211354T	
Q5035A	RETAINER	(CLA2)	1	27142140	N
Q5036	TR	2SA949-Y(TPE6_F)	1	2211354T	
Q5036A	RETAINER	(CLA2)	1	27142140	N
Q5040	TR	2SC2229-Y(TPE6_F)	1	2211634T	
Q5041	TR	2SC2229-Y(TPE6_F)	1	2211634T	
Q5042	TR	2SC2229-Y(TPE6_F)	1	2211634T	
Q5043	TR	2SC2229-Y(TPE6_F)	1	2211634T	
Q5044	TR	2SC2229-Y(TPE6_F)	1	2211634T	
Q5045	TR	2SC2229-Y(TPE6_F)	1	2211634T	
Q5046	TR	2SC2229-Y(TPE6_F)	1	2211634T	
Q5050	TR	2SC2240-BL(TPE2_F)	1	2211406T	
Q5051	TR	2SC2240-BL(TPE2_F)	1	2211406T	
Q5052	TR	2SC2240-BL(TPE2_F)	1	2211406T	
Q5053	TR	2SC2240-BL(TPE2_F)	1	2211406T	
Q5054	TR	2SC2240-BL(TPE2_F)	1	2211406T	
Q5055	TR	2SC2240-BL(TPE2_F)	1	2211406T	
Q5056	TR	2SC2240-BL(TPE2_F)	1	2211406T	
Q6010	TR	2SC1740S-S	1	2213285T	
Q6011	TR	2SC1740S-S	1	2213285T	
Q6012	TR	2SC1740S-S	1	2213285T	
Q6013	TR	2SC1740S-S	1	2213285T	
Q6014	TR	2SC1740S-S	1	2213285T	
Q6015	TR	2SC1740S-S	1	2213285T	
Q6016	TR	2SC1740S-S	1	2213285T	
Q6030	TR	2SC5171(ONK_Q)	1	2203010	
Q6030 or	TR	2SC5993-Q_P	(1)	2217161	
Q6031	TR	2SC5171(ONK_Q)	1	2203010	
Q6031 or	TR	2SC5993-Q_P	(1)	2217161	
Q6032	TR	2SC5171(ONK_Q)	1	2203010	
Q6032 or	TR	2SC5993-Q_P	(1)	2217161	
Q6033	TR	2SC5171(ONK_Q)	1	2203010	
Q6033 or	TR	2SC5993-Q_P	(1)	2217161	
Q6034	TR	2SC5171(ONK_Q)	1	2203010	
Q6034 or	TR	2SC5993-Q_P	(1)	2217161	
Q6035	TR	2SC5171(ONK_Q)	1	2203010	
Q6035 or	TR	2SC5993-Q_P	(1)	2217161	
Q6036	TR	2SC5171(ONK_Q)	1	2203010	

Q6036 or	TR	2SC5993-Q_P	(1)	2217161
Q6040	TR	2SA1930(ONK_Q)	1	2203000
Q6040 or	TR	2SA2140-Q_P	(1)	2217151
Q6041	TR	2SA1930(ONK_Q)	1	2203000
Q6041 or	TR	2SA2140-Q_P	(1)	2217151
Q6042	TR	2SA1930(ONK_Q)	1	2203000
Q6042 or	TR	2SA2140-Q_P	(1)	2217151
Q6043	TR	2SA1930(ONK_Q)	1	2203000
Q6043 or	TR	2SA2140-Q_P	(1)	2217151
Q6044	TR	2SA1930(ONK_Q)	1	2203000
Q6044 or	TR	2SA2140-Q_P	(1)	2217151
Q6045	TR	2SA1930(ONK_Q)	1	2203000
Q6045 or	TR	2SA2140-Q_P	(1)	2217151
Q6046	TR	2SA1930(ONK_Q)	1	2203000
Q6046 or	TR	2SA2140-Q_P	(1)	2217151
C5000	UPZ C	2AUPZTF10IJE	1	376331014T
C5001	UPZ C	2AUPZTF10IJE	1	376331014T
C5002	UPZ C	2AUPZTF10IJE	1	376331014T
C5003	UPZ C	2AUPZTF10IJE	1	376331014T
C5004	UPZ C	2AUPZTF10IJE	1	376331014T
C5005	UPZ C	2AUPZTF10IJE	1	376331014T
C5006	UPZ C	2AUPZTF10IJE	1	376331014T
C5010	UTSP C	CE04W50V-47M(UTSP)	1	397584707T
C5011	UTSP C	CE04W50V-47M(UTSP)	1	397584707T
C5012	UTSP C	CE04W50V-47M(UTSP)	1	397584707T
C5013	UTSP C	CE04W50V-47M(UTSP)	1	397584707T
C5014	UTSP C	CE04W50V-47M(UTSP)	1	397584707T
C5015	UTSP C	CE04W50V-47M(UTSP)	1	397584707T
C5016	UTSP C	CE04W50V-47M(UTSP)	1	397584707T
C5020	UTSP C	CE04W50V-10M(UTSP)	1	397581007T
C5021	UTSP C	CE04W50V-10M(UTSP)	1	397581007T
C5022	UTSP C	CE04W50V-10M(UTSP)	1	397581007T
C5023	UTSP C	CE04W50V-10M(UTSP)	1	397581007T
C5024	UTSP C	CE04W50V-10M(UTSP)	1	397581007T
C5025	UTSP C	CE04W50V-10M(UTSP)	1	397581007T
C5026	UTSP C	CE04W50V-10M(UTSP)	1	397581007T
C5040	UTSP C	CE04W25V-220M(UTSP)	1	397552217T
C5041	UTSP C	CE04W25V-220M(UTSP)	1	397552217T
C5042	UTSP C	CE04W25V-220M(UTSP)	1	397552217T

C5043	UTSP C	CE04W25V-220M(UTSP)	1	397552217T
C5044	UTSP C	CE04W25V-220M(UTSP)	1	397552217T
C5045	UTSP C	CE04W25V-220M(UTSP)	1	397552217T
C5046	UTSP C	CE04W25V-220M(UTSP)	1	397552217T
C5050	UTSP C	CE04W50V 47M(UTSP)	1	397584707T
C5051	UTSP C	CE04W50V 47M(UTSP)	1	397584707T
C5052	UTSP C	CE04W50V 47M(UTSP)	1	397584707T
C5053	UTSP C	CE04W50V 47M(UTSP)	1	397584707T
C5054	UTSP C	CE04W50V 47M(UTSP)	1	397584707T
C5055	UTSP C	CE04W50V 47M(UTSP)	1	397584707T
C5056	UTSP C	CE04W50V 47M(UTSP)	1	397584707T
C5080	CERA C	CC45SL50V-040C	1	345020401T
C5081	CERA C	CC45SL50V-040C	1	345020401T
C5082	CERA C	CC45SL50V-040C	1	345020401T
C5083	CERA C	CC45SL50V-040C	1	345020401T
C5084	CERA C	CC45SL50V-040C	1	345020401T
C5085	CERA C	CC45SL50V-040C	1	345020401T
C5086	CERA C	CC45SL50V-040C	1	345020401T
C5090	UPZ C	2AUPZTF101JE	1	376331014T
C5091	UPZ C	2AUPZTF101JE	1	376331014T
C5092	UPZ C	2AUPZTF101JE	1	376331014T
C5093	UPZ C	2AUPZTF101JE	1	376331014T
C5094	UPZ C	2AUPZTF101JE	1	376331014T
C5095	UPZ C	2AUPZTF101JE	1	376331014T
C5096	UPZ C	2AUPZTF101JE	1	376331014T
C5100	VR C	CE04W100V-22M(VR)	1	394692207T
C5101	VR C	CE04W100V-22M(VR)	1	394692207T
C5102	VR C	CE04W100V-22M(VR)	1	394692207T
C5103	VR C	CE04W100V-22M(VR)	1	394692207T
C5104	VR C	CE04W100V-22M(VR)	1	394692207T
C5105	VR C	CE04W100V-22M(VR)	1	394692207T
C5106	VR C	CE04W100V-22M(VR)	1	394692207T
C5110	VR C	CE04W100V-22M(VR)	1	394692207T
C5111	VR C	CE04W100V-22M(VR)	1	394692207T
C5112	VR C	CE04W100V-22M(VR)	1	394692207T
C5113	VR C	CE04W100V-22M(VR)	1	394692207T
C5114	VR C	CE04W100V-22M(VR)	1	394692207T
C5115	VR C	CE04W100V-22M(VR)	1	394692207T
C5116	VR C	CE04W100V-22M(VR)	1	394692207T

C6040	UTSP C	CE04W50V 47M(UTSP)	1	397584707T
C6041	UTSP C	CE04W50V 47M(UTSP)	1	397584707T
C6042	UTSP C	CE04W50V 47M(UTSP)	1	397584707T
C6043	UTSP C	CE04W50V 47M(UTSP)	1	397584707T
C6044	UTSP C	CE04W50V 47M(UTSP)	1	397584707T
C6045	UTSP C	CE04W50V 47M(UTSP)	1	397584707T
C6046	UTSP C	CE04W50V 47M(UTSP)	1	397584707T
R5000	CARBON R	R16J-1.5K	1	417341524T
R5001	CARBON R	R16J-1.5K	1	417341524T
R5002	CARBON R	R16J-1.5K	1	417341524T
R5003	CARBON R	R16J-1.5K	1	417341524T
R5004	CARBON R	R16J-1.5K	1	417341524T
R5005	CARBON R	R16J-1.5K	1	417341524T
R5006	CARBON R	R16J-1.5K	1	417341524T
R5010	CARBON R	R16J-120K	1	417341244T
R5011	CARBON R	R16J-120K	1	417341244T
R5012	CARBON R	R16J-120K	1	417341244T
R5013	CARBON R	R16J-120K	1	417341244T
R5014	CARBON R	R16J-120K	1	417341244T
R5015	CARBON R	R16J-120K	1	417341244T
R5016	CARBON R	R16J-120K	1	417341244T
R5020	CARBON R	R16J-330	1	417343314T
R5021	CARBON R	R16J-330	1	417343314T
R5022	CARBON R	R16J-330	1	417343314T
R5023	CARBON R	R16J-330	1	417343314T
R5024	CARBON R	R16J-330	1	417343314T
R5025	CARBON R	R16J-330	1	417343314T
R5026	CARBON R	R16J-330	1	417343314T
R5030	CARBON R	R16J-120K	1	417341244T
R5031	CARBON R	R16J-120K	1	417341244T
R5032	CARBON R	R16J-120K	1	417341244T
R5033	CARBON R	R16J-120K	1	417341244T
R5034	CARBON R	R16J-120K	1	417341244T
R5035	CARBON R	R16J-120K	1	417341244T
R5036	CARBON R	R16J-120K	1	417341244T
R5040	CARBON R	R16J-2.2K	1	417342224T
R5041	CARBON R	R16J-2.2K	1	417342224T
R5042	CARBON R	R16J-2.2K	1	417342224T
R5043	CARBON R	R16J-2.2K	1	417342224T

R5044	CARBON R	R16J-2.2K	1	417342224T
R5045	CARBON R	R16J-2.2K	1	417342224T
R5046	CARBON R	R16J-2.2K	1	417342224T
R5050	CARBON R	R16J-4.7K	1	417344724T
R5051	CARBON R	R16J-4.7K	1	417344724T
R5052	CARBON R	R16J-4.7K	1	417344724T
R5053	CARBON R	R16J-4.7K	1	417344724T
R5054	CARBON R	R16J-4.7K	1	417344724T
R5055	CARBON R	R16J-4.7K	1	417344724T
R5056	CARBON R	R16J-4.7K	1	417344724T
R5060	CARBON R	R16J-1.2K	1	417341224T
R5061	CARBON R	R16J-1.2K	1	417341224T
R5062	CARBON R	R16J-1.2K	1	417341224T
R5063	CARBON R	R16J-1.2K	1	417341224T
R5064	CARBON R	R16J-1.2K	1	417341224T
R5065	CARBON R	R16J-1.2K	1	417341224T
R5066	CARBON R	R16J-1.2K	1	417341224T
R5080	CARBON R	R16J-470	1	417344714T
R5081	CARBON R	R16J-470	1	417344714T
R5082	CARBON R	R16J-470	1	417344714T
R5083	CARBON R	R16J-470	1	417344714T
R5084	CARBON R	R16J-470	1	417344714T
R5085	CARBON R	R16J-470	1	417344714T
R5086	CARBON R	R16J-470	1	417344714T
R5090	CARBON R	R16J-100K	1	417341044T
R5091	CARBON R	R16J-100K	1	417341044T
R5092	CARBON R	R16J-100K	1	417341044T
R5093	CARBON R	R16J-100K	1	417341044T
R5094	CARBON R	R16J-100K	1	417341044T
R5095	CARBON R	R16J-100K	1	417341044T
R5096	CARBON R	R16J-100K	1	417341044T
R5100	CARBON R	R16J-100K	1	417341044T
R5101	CARBON R	R16J-100K	1	417341044T
R5102	CARBON R	R16J-100K	1	417341044T
R5103	CARBON R	R16J-100K	1	417341044T
R5104	CARBON R	R16J-100K	1	417341044T
R5105	CARBON R	R16J-100K	1	417341044T
R5106	CARBON R	R16J-100K	1	417341044T
R5110	CARBON R	R16J-1K	1	417341024T

R5111	CARBON R	R16J-1K	1	417341024T
R5112	CARBON R	R16J-1K	1	417341024T
R5113	CARBON R	R16J-1K	1	417341024T
R5114	CARBON R	R16J-1K	1	417341024T
R5115	CARBON R	R16J-1K	1	417341024T
R5116	CARBON R	R16J-1K	1	417341024T
R5130	CARBON R	R16J-18K	1	417341834T
R5131	CARBON R	R16J-18K	1	417341834T
R5132	CARBON R	R16J-18K	1	417341834T
R5133	CARBON R	R16J-18K	1	417341834T
R5134	CARBON R	R16J-18K	1	417341834T
R5135	CARBON R	R16J-18K	1	417341834T
R5136	CARBON R	R16J-18K	1	417341834T
R5160	NF CARBON R	R25J-100	1	415471014T
R5161	NF CARBON R	R25J-100	1	415471014T
R5162	NF CARBON R	R25J-100	1	415471014T
R5163	NF CARBON R	R25J-100	1	415471014T
R5164	NF CARBON R	R25J-100	1	415471014T
R5165	NF CARBON R	R25J-100	1	415471014T
R5166	NF CARBON R	R25J-100	1	415471014T
R5170	NF CARBON R	R25J-100	1	415471014T
R5171	NF CARBON R	R25J-100	1	415471014T
R5172	NF CARBON R	R25J-100	1	415471014T
R5173	NF CARBON R	R25J-100	1	415471014T
R5174	NF CARBON R	R25J-100	1	415471014T
R5175	NF CARBON R	R25J-100	1	415471014T
R5176	NF CARBON R	R25J-100	1	415471014T
R5180	NF CARBON R	R25J-10	1	415471004T
R5181	NF CARBON R	R25J-10	1	415471004T
R5182	NF CARBON R	R25J-10	1	415471004T
R5183	NF CARBON R	R25J-10	1	415471004T
R5184	NF CARBON R	R25J-10	1	415471004T
R5185	NF CARBON R	R25J-10	1	415471004T
R5186	NF CARBON R	R25J-10	1	415471004T
R5190	NF CARBON R	R25J-10	1	415471004T
R5191	NF CARBON R	R25J-10	1	415471004T
R5192	NF CARBON R	R25J-10	1	415471004T
R5193	NF CARBON R	R25J-10	1	415471004T
R5194	NF CARBON R	R25J-10	1	415471004T

R5195	NF CARBON R	R25J-10	1	415471004T
R5196	NF CARBON R	R25J-10	1	415471004T
R5200	CARBON R	R16J-18K	1	417341834T
R5201	CARBON R	R16J-18K	1	417341834T
R5202	CARBON R	R16J-18K	1	417341834T
R5203	CARBON R	R16J-18K	1	417341834T
R5204	CARBON R	R16J-18K	1	417341834T
R5205	CARBON R	R16J-18K	1	417341834T
R5206	CARBON R	R16J-18K	1	417341834T
R5230	CARBON R	R16J-120K	1	417341244T
R5231	CARBON R	R16J-120K	1	417341244T
R5232	CARBON R	R16J-120K	1	417341244T
R5233	CARBON R	R16J-120K	1	417341244T
R5234	CARBON R	R16J-120K	1	417341244T
R5235	CARBON R	R16J-120K	1	417341244T
R5236	CARBON R	R16J-120K	1	417341244T
R5300	CARBON R	R16J-22	1	417342204T
R5301	CARBON R	R16J-22	1	417342204T
R5302	CARBON R	R16J-22	1	417342204T
R5303	CARBON R	R16J-22	1	417342204T
R5304	CARBON R	R16J-22	1	417342204T
R5305	CARBON R	R16J-22	1	417342204T
R5306	CARBON R	R16J-22	1	417342204T
R5310	CARBON R	R16J-22	1	417342204T
R5311	CARBON R	R16J-22	1	417342204T
R5312	CARBON R	R16J-22	1	417342204T
R5313	CARBON R	R16J-22	1	417342204T
R5314	CARBON R	R16J-22	1	417342204T
R5315	CARBON R	R16J-22	1	417342204T
R5316	CARBON R	R16J-22	1	417342204T
R5320	CARBON R	R16J-120K	1	417341244T
R5321	CARBON R	R16J-120K	1	417341244T
R5322	CARBON R	R16J-120K	1	417341244T
R5323	CARBON R	R16J-120K	1	417341244T
R5324	CARBON R	R16J-120K	1	417341244T
R5325	CARBON R	R16J-120K	1	417341244T
R5326	CARBON R	R16J-120K	1	417341244T
R6020	NF CARBON R	R25J-2.2	1	415470224T
R6021	NF CARBON R	R25J-2.2	1	415470224T

R6022	NF CARBON R	R25J-2.2	1	415470224T	
R6023	NF CARBON R	R25J-2.2	1	415470224T	
R6024	NF CARBON R	R25J-2.2	1	415470224T	
R6025	NF CARBON R	R25J-2.2	1	415470224T	
R6026	NF CARBON R	R25J-2.2	1	415470224T	
R6040	TRIM R	N06HR2KBB	1	5211402T	
R6041	TRIM R	N06HR2KBB	1	5211402T	
R6042	TRIM R	N06HR2KBB	1	5211402T	
R6043	TRIM R	N06HR2KBB	1	5211402T	
R6044	TRIM R	N06HR2KBB	1	5211402T	
R6045	TRIM R	N06HR2KBB	1	5211402T	
R6046	TRIM R	N06HR2KBB	1	5211402T	
R6050	CARBON R	R16J-3.3K	1	417343324T	
R6051	CARBON R	R16J-3.3K	1	417343324T	
R6052	CARBON R	R16J-3.3K	1	417343324T	
R6053	CARBON R	R16J-3.3K	1	417343324T	
R6054	CARBON R	R16J-3.3K	1	417343324T	
R6055	CARBON R	R16J-3.3K	1	417343324T	
R6056	CARBON R	R16J-3.3K	1	417343324T	
R6070	NF CARBON R	R25J-82	1	415478204T	
R6071	NF CARBON R	R25J-82	1	415478204T	
R6072	NF CARBON R	R25J-82	1	415478204T	
R6073	NF CARBON R	R25J-82	1	415478204T	
R6074	NF CARBON R	R25J-82	1	415478204T	
R6075	NF CARBON R	R25J-82	1	415478204T	
R6076	NF CARBON R	R25J-82	1	415478204T	
P001	PWB	BCCLA-0020	1	25140020B	N
P5507B	TRM	NTM-1P233(M1969)	1	25060302	
P5509B	TRM	NTM-1P233(M1969)	1	25060302	
P6000A	SOCKET	NSCT-9P2189	1	25052292	
P6001A	SOCKET	NSCT-9P2189	1	25052292	
P6002A	SOCKET	NSCT-3P2183	1	25052286	
P6003A	SOCKET	NSCT-9P2189	1	25052292	
P6004A	SOCKET	NSCT-9P2189	1	25052292	
P6005A	SOCKET	NSCT-9P2189	1	25052292	
P6006A	SOCKET	NSCT-9P2189	1	25052292	
P6012A	SOCKET	NSCT-7P2187	1	25052290	

PACKING PROCEDURES PARTS LIST

REF. NO.	PART NAME	DESCRIPTION	Q'TY	PART NO. (SN)	REMARKS
A601	PAD	(AS)607	1	29092458A	
A605	POLY BAG	w850xd650	1	29100245	
A606	TAPE	(SEROHAN)NITTO NO.29	1	29110149	
A610	SHEET	(PAD)	1	29096095	<MDC,MDD,MDF,MPA,MPB,MPP>
A610	SHEET	(PAD)	1	29096099	N <MMO,MMQ,MMR>
A701	CARTON	.607DD	1	29054998	N <MDC,MDD,MDF>
A701	CARTON	.607	1	29054995A	N <MMO,MMQ,MPA,MPB,MPP,MMR>
A704A	UPC LABEL	607BDD	{ 1}	29390704	N <BMDD>
A704A	UPC LABEL	607BDC	{ 1}	29390705	N <BMDC>
A704A	UPC LABEL	607SDC	{ 1}	29390706	N <SMDD>
A704A	EAN LABEL	607BPB	{ 1}	29390727	N <BMPB>
A704A	EAN LABEL	607SPB	{ 1}	29390728	N <SMPB>
A704A	EAN LABEL	607GMR	{ 1}	29390732	N <GMMR>
A704A	EAN LABEL	607BMA	{ 1}	29390733	N <BMPA>
A704A	EAN LABEL	607SMA	{ 1}	29390734	N <SMPA>
A704A	EAN LABEL	607BMQ	{ 1}	29390735	N <BMMQ>
A704A	EAN LABEL	607BPP	{ 1}	29390725A	N <BMPP>
A704A	EAN LABEL	607SPP	{ 1}	29390726A	N <SMPP>
A704A	EAN LABEL	607BDF	{ 1}	29390729A	N <BMDF>
A704A	EAN LABEL	607BMO	{ 1}	29390730A	N <BMMO>
A704A	EAN LABEL	607SMO	{ 1}	29390731A	N <SMMO>
A707	LABEL	(CHINA)	1	29390370	<GMMR>
A750	LABEL	(KS)TX-SR607	1	29390762	<MMO>
A751	LABEL	(TWN)TX-SR607(B)	2	29390766	N <BMDF>
A755	LABEL	(CCC)	1	29364396	<MMR>
A760	PP TAPE	W50 SBT-70	1	29110200	
A670	POLY BAG	w250xd350	1	29100250A	<MMR>
A672	POLY BAG	w250xd350	1	29100250A	<MMO,MMQ,MPA,MPB,MPP>
A673	POLY BAG	.	1	29100225A	<MMO>
A674	POLY BAG	D250xd300xW300(t0.04)	1	29100256A	
A676	TAPE	(SEROHAN)NITTO NO.29	1	29110149	
A801	INS MANUAL	En(TX-SR607)	1	29344951	N
A802	INS MANUAL	U2FrEs(TX-SR607)	1	29344952	N <MDC,MPP>
A803	INS MANUAL	U2ItDe(TX-SR607)	1	29344953	N <MPP>
A804	INS MANUAL	U2NISv(TX-SR607)	1	29344954	N <MPP>
A805	INS MANUAL	Ct(TX-SR607)	1	29344955	N <MDF,MMO,MMQ>

A806	INS MANUAL	Cs(TX-SR607)	1	29344956	N <MMR>
A807	INS MANUAL	Ar(TX-SR607)	1	29344957	N <MMO>
A809	INS MANUAL	(QC ImportantSheet)	1	29344267A	<MMO>
A811	INS MANUAL	U9(RC736/737/738/739)	1	29344962	N
A816	INS MANUAL	En(QSS TX-SR607)	1	29344959	N
A817	INS MANUAL	Cs(QSS TX-SR607)	1	29344960	N <MMR>
A819	INS MANUAL	En(SIRIUS607)	1	29344963	N <MDC,MDD>
A820	INS MANUAL	U2FrEs(Sirius607)	1	29400098	N <MDC>
A820	INST SHEET	WEEE	1	29355537A	<MPB,MPP>
A821	INST SHEET	En(2009E_RIHD)	1	29355745	N
A822	INST SHEET	U2FrEs(2009E_RIHD)	1	29355746	N <MDC>
A823	INST SHEET	U8(2009E_RIHD)	1	29355747	N <MDF,MMO,MMQ,MPP,MMR>
A825	INST SHEET	Ct(CHUISI_MDF)	1	29355749	N <MDF>
A831	HANDBILL	(SIRIUS)	1	29380149	<MDC,MDD>
A835	HANDBILL	(UP-A1)US	1	29380155	<MDC,MDD>
A835	HANDBILL	(UP-A1)EU	1	29380156	<MPB,MPP>
A855	REMO CON	RC-738M	1	24140738	N
A856	MIC	MIC-7000	1	245044	
A857	CV PLUG	SCP-13A-BLK(UK)	1	25056591	<MMO>
A858	ANT COIL	NMA-3057	1	232140	
A859	FM ANT AS	Type W	1	292191	
A860	LABEL	(SPCABLE)2009	1	29390881	
A861	BATTERY	R6/AA(UM-3)	2	3010194	EXCEPT <MMR>
A861 or	BATTERY	R6/AA(UM-3)	(2)	3010054	EXCEPT <MMR>
A883	WRNTY CARD	(ONKYO-CH)	1	29365098B	<MMR>
A884	WRNTY CARD	MGQ	1	29365099A	<MMQ>
A885	WRNTY CARD	(ONKYO)	1	29365135	<MDC,MDD>
A888	LABEL	(APV)	1	29390190	<MMR>
A901	INST SHEET	EnCs(Del_Battery_China)	1	29355760	<MMR>

ONKYO CORPORATION

Service Dept. Technical Support : 2-1, Nisshin-cho, Neyagawa-shi, OSAKA 572-8540, JAPAN
Tel: 072-831-8023 Fax: 072-831-8163

ONKYO U.S.A. CORPORATION

18 Park Way, Upper Saddle River, N.J. 07458, U.S.A.
Tel: 201-785-2600 Fax: 201-785-2650 <http://www.us.onkyo.com/>

ONKYO EUROPE ELECTRONICS GmbH (DUISBURG OFFICE)

Hafennr.7602, Logport Office-Center, Bliersheimerstr.80B, 47229 Duisburg, Germany
Tel: +49-2065-90198-00 Fax: +49-2065-90198-40 <http://www.eu.onkyo.com/>

ONKYO EUROPE UK Office

Suite 1, Gregories Court, Gregories Road, Beaconsfield, Buckinghamshire, HP9 1HQ
UNITED KINGDOM Tel: +44-(0)1494-681515 Fax: +44(0)-1494-680452

ONKYO CHINA LIMITED

Units 2102-2107, Metroplaza Tower I, 223 Hing Fong Road, Kwai Chung,
N.T., HONG KONG Tel: 852-2429-3118 Fax: 852-2428-9039
<http://www.ch.onkyo.com/>

