

SCHEMATIC DIAGRAM (for operation circuit) (Parts list on page 22~28.)

A OPERATION SWITCH CIRCUIT

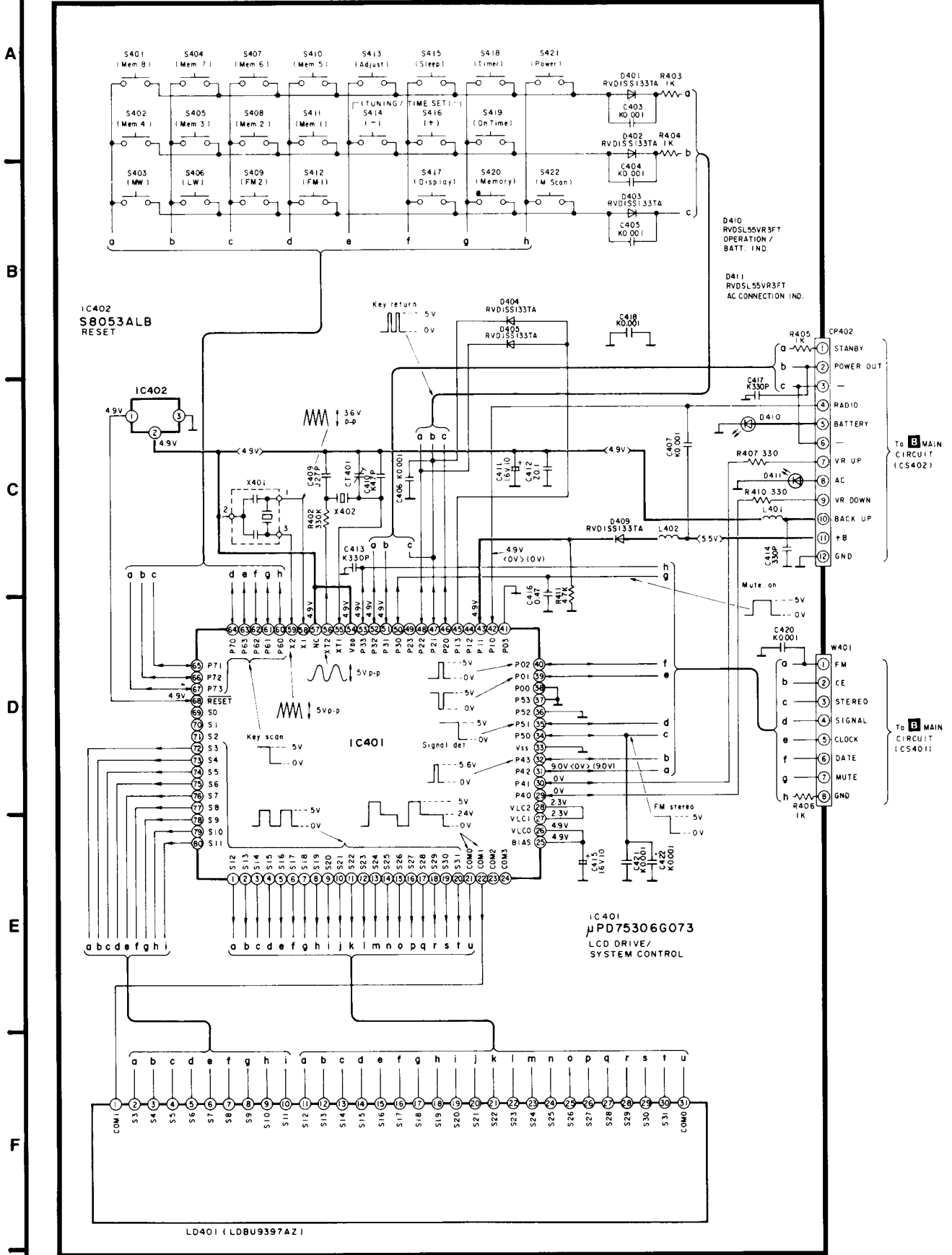

SCHEMATIC DIAGRAM (for Main/Mechanism/LED/Graphic E.Q./Batter/ Power Supp

1 | 2 | 3 | 4 | 5

B MAIN CIRCUIT

A

B

C

D

E

F

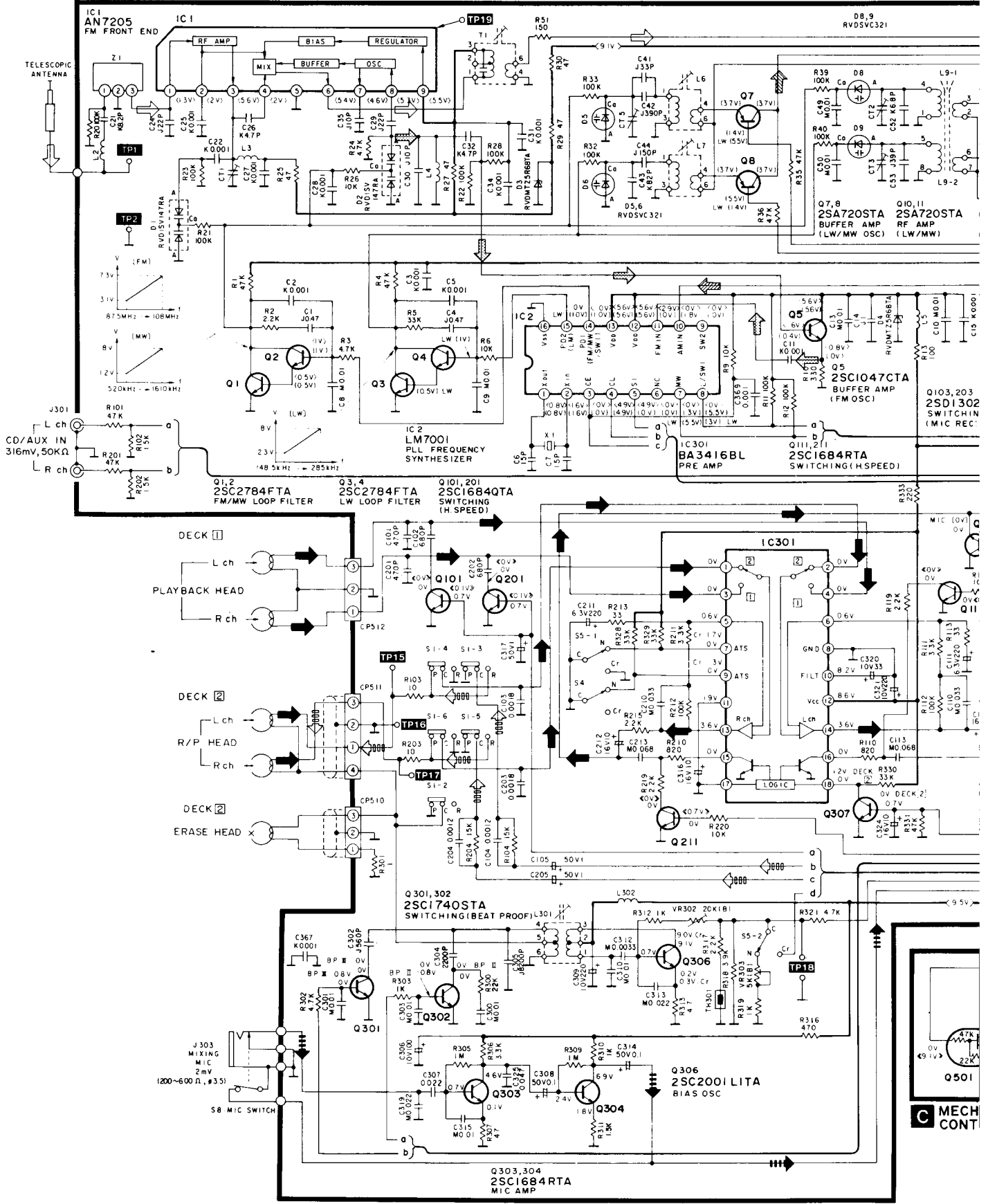

C MECH CONT

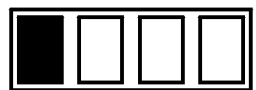

Supply Circuit (Parts list on page 22~28.)

6

7

8

9

10

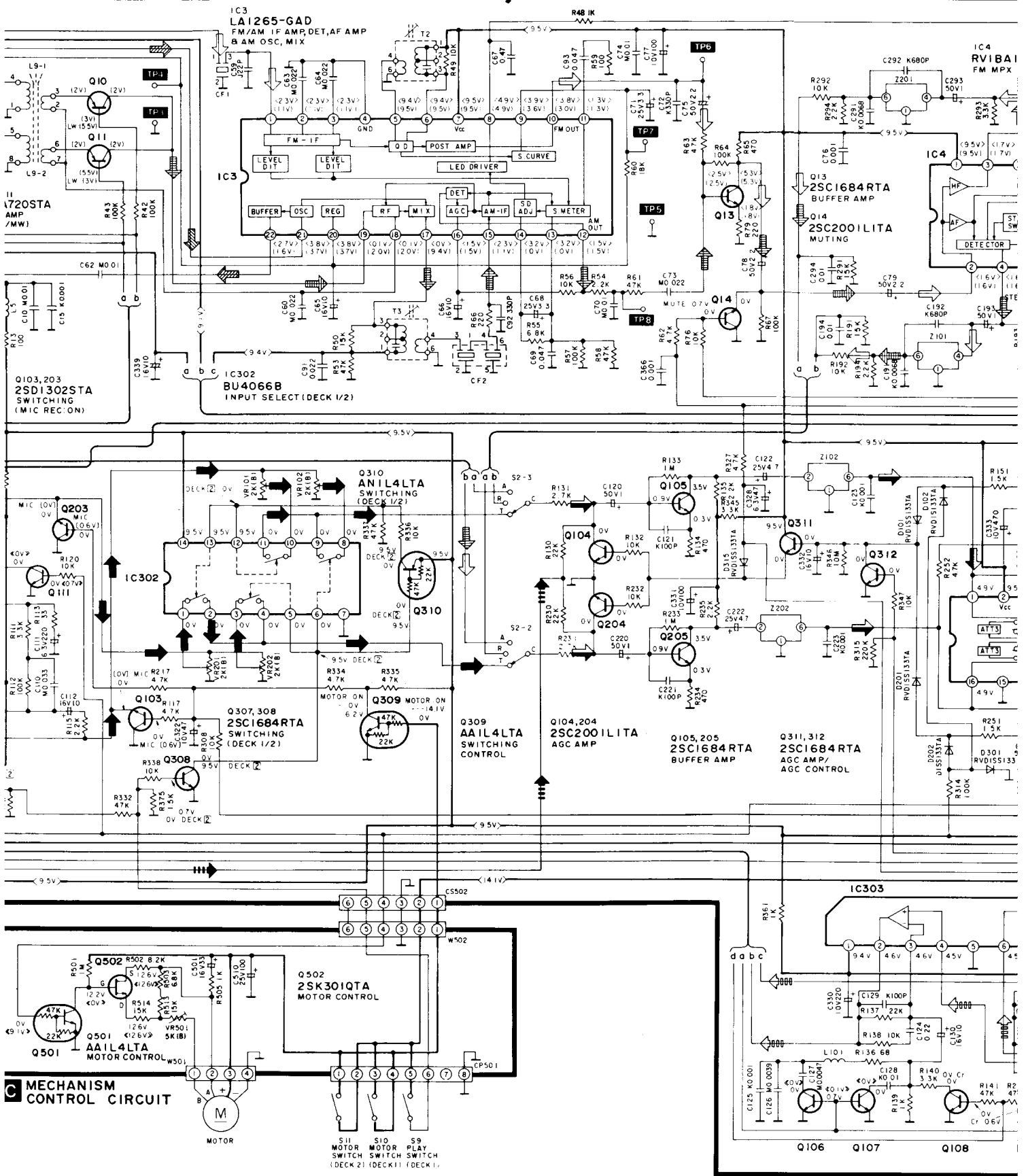

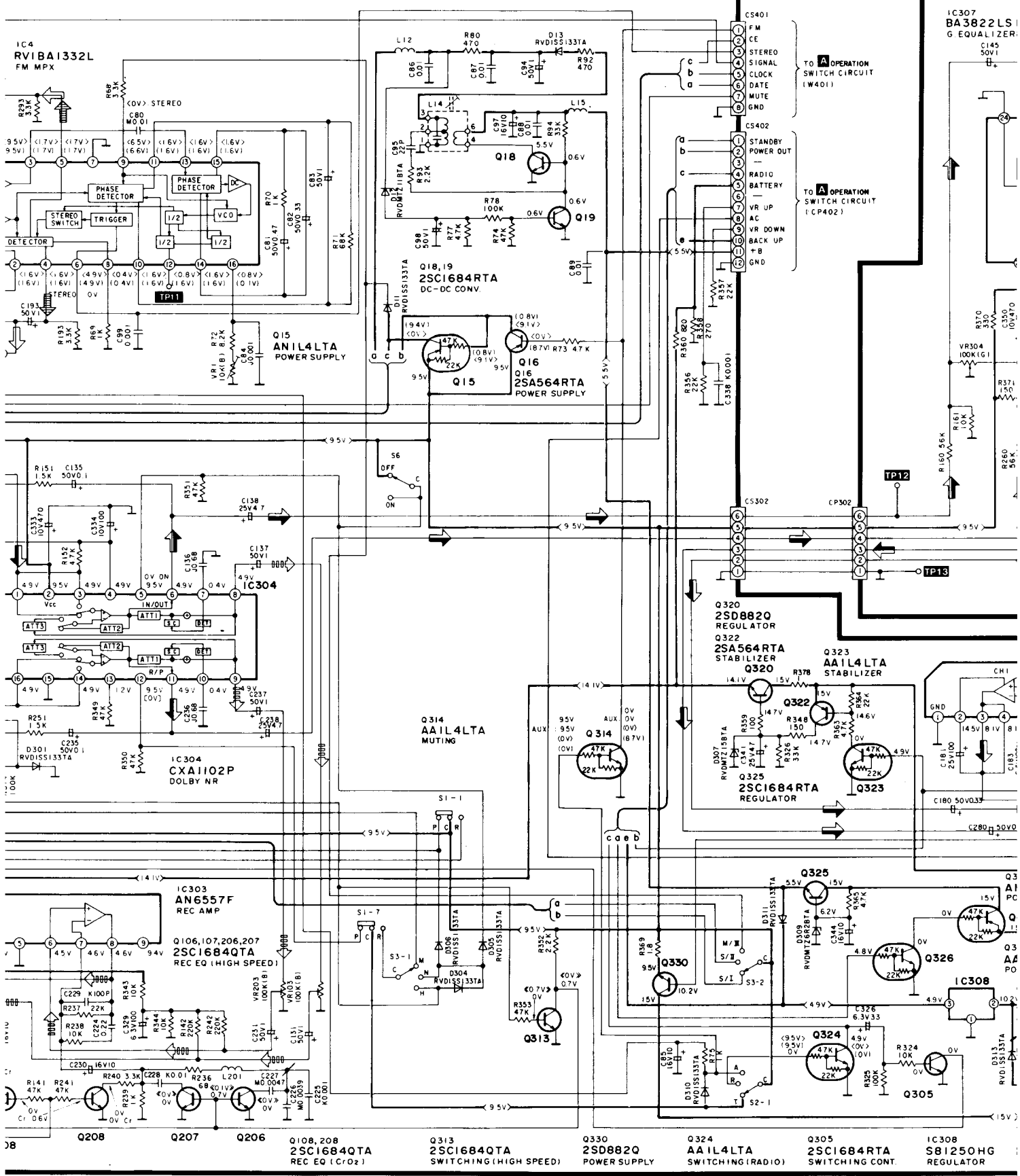

D GRAPHIC EQUALIZER AMP/XBS AMP CIRCUIT

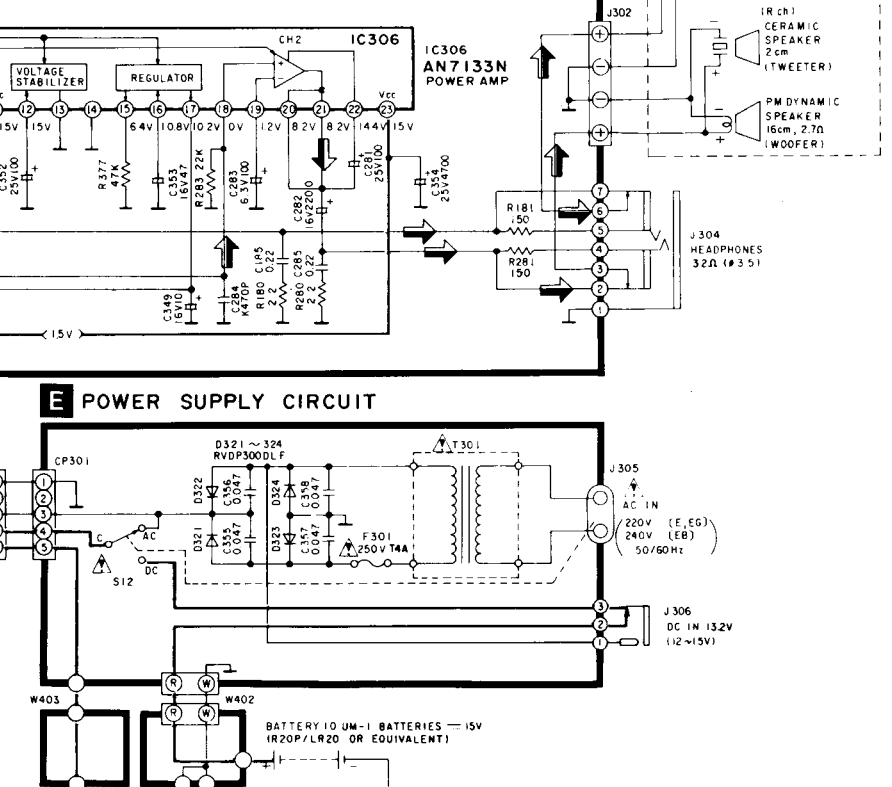
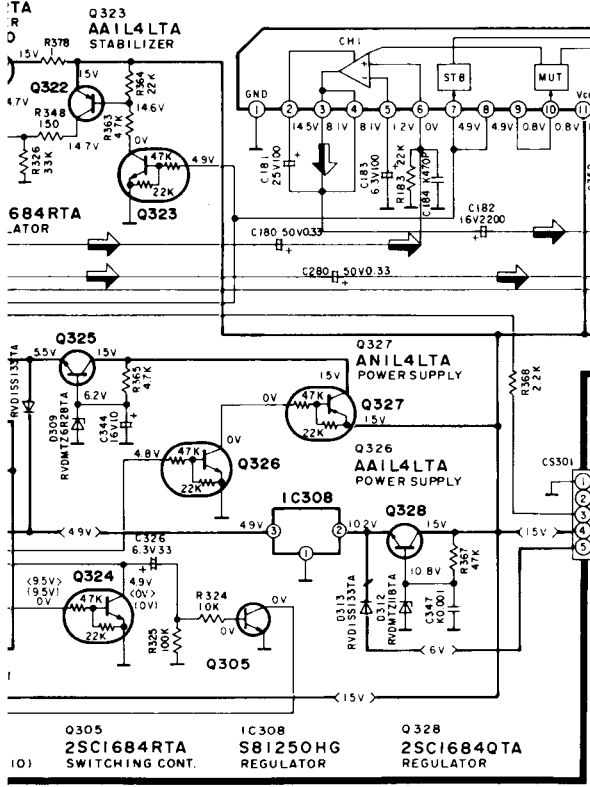
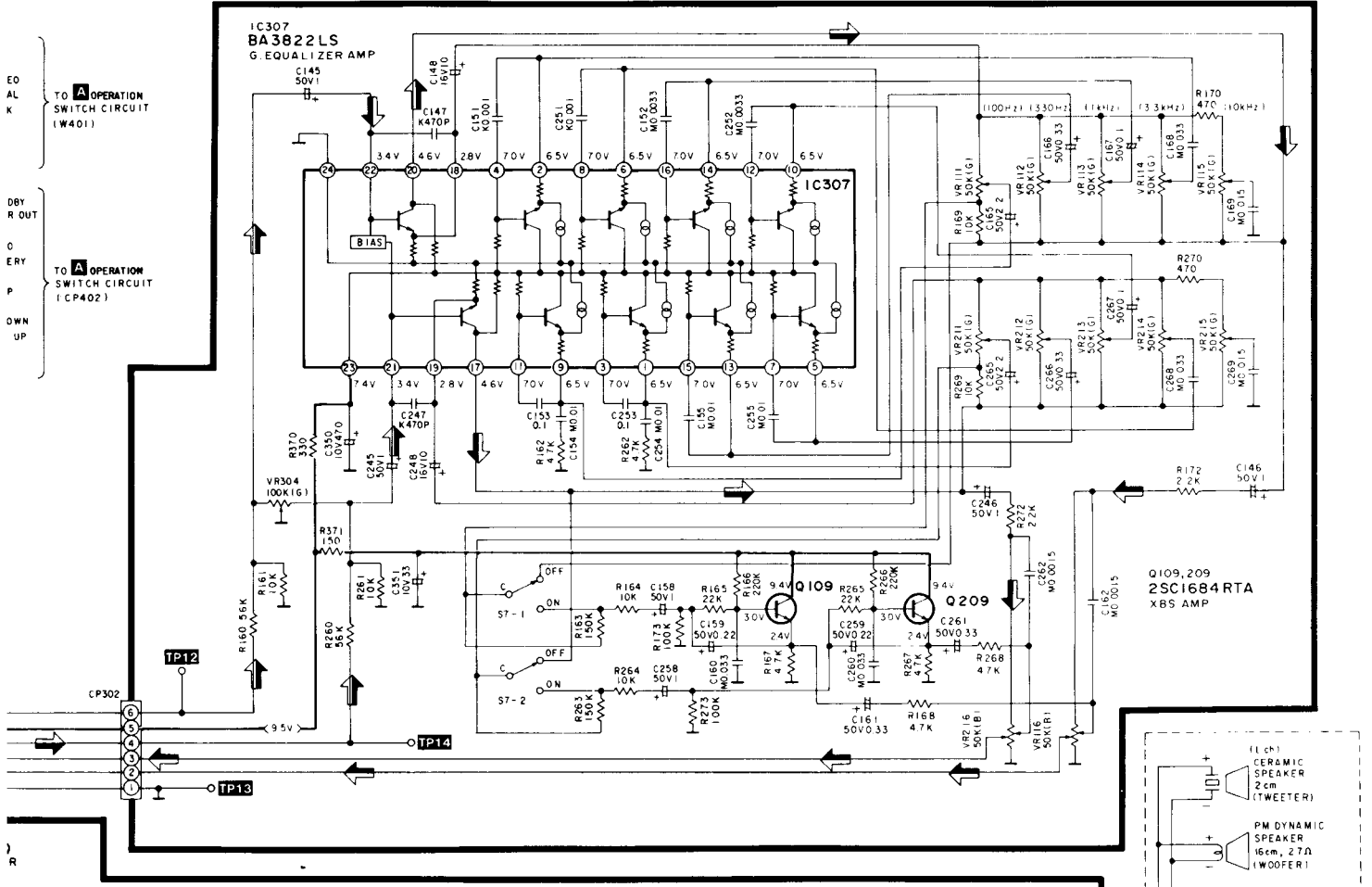

Q305 2SC1684RTA SWITCHING CONT.
 IC308 S81250HG REGULATOR
 Q326 AN14LTA POWER SUPPLY
 Q327 AN14LTA POWER SUPPLY
 Q328 2SC1684QTA REGULATOR

IC306 AN7133N POWER AMP
 IC307 BA3822LS G EQUALIZER AMP
 Q109, Q209 2SC1684RTA XBS AMP
 BATTERY 10 UM-1 BATTERIES — 15V (R20P/LR20 OR EQUIVALENT)
 BATTERY 4 UM-3 BATTERIES — 6V (R6P/LR6 OR EQUIVALENT)

