

Portable Compact Disc Player

Service Service Service

AX5200 AX5201 AX5202 AX5203
AX5210 AX5211 AX5212 AX5215
AX5219
all versions



PRODUCT FAMILY FOCUS – TARGET-5 SERIES

Service Manual



TABLE OF CONTENTS

Technical specification	1-1
Features and Accessories	1-2
Connections and controls	1-3
Instruction for use	1-4..1-6
Safety & Warnings	1-7
Service hints	
Repair positions	2-1
Dismantling CD-door	2-1
Handling chip components	2-2
Service tools	2-2
Pin description of ICs	3-1..3-5
Start-up procedure	3-6
Service Test Program	3-7..3-8
Blockdiagram	3-9

Circuit diagrams

Control/support part	4-1
Audio part	4-2
CD part	4-3

Layout diagrams

Componentside view	4-4
Copperside view	4-5
Exploded view	5-1
Mechanical partslist	5-1
Electrical partslist	6-1..6-4

© Copyright 2001 Philips Consumer Electronics B.V. Eindhoven, The Netherlands
All rights reserved. No part of this publication may be reproduced, stored in a retrieval
system or transmitted, in any form or by any means, electronic, mechanical, photocopying,
or otherwise without the prior permission of Philips.

Published by LX 0307 Service Audio Printed in The Netherlands Subject to modification

GB 3140 785 32460

**CLASS 1
LASER PRODUCT**



PHILIPS

TECHNICAL SPECIFICATION

General

Dimensions (HxD)	:22.8x137.5 mm
Weight without batteries	:187g

Power supply modes

DC-in socket	: 2.5 - 6.0V
Primary batteries (2xLR6)	: 2.0 - 3.6V
Rechargeable batteries	: 2.0 - 3.6V

Battery lifetime

BATTERY TYPE	ESP=ON	PSM
Primary Batteries 2 x LR6	≥ 15h (20h typ.)	≥ 28h (32h typ.)
Primary Batteries 2 x AAA	≥ 7h (9h typ.)	≥ 13h (15h typ.)
Rechargeable Batteries AY3363(1200mAh)	≥ 4h (6h typ.)	≥ 10h (12h typ.)

Battery level detection

DETECTION LEVEL	Primary bateries	Rechargeable batteries
Battery empty	1.8V +100/-50mV	1.8V +100/-50mV
Battery weak 1	battery empty level + 0.75V ±100mV	battery empty level + 0.7V ±100mV
Battery weak 2	battery empty level + 0.45V ±100mV	battery empty level + 0.5V ±100mV
Battery weak 3	battery empty level + 0.3V ±100mV	battery empty level + 0.3V ±100mV

Current consumption CDDA-playback

OPERATION MODE	DC-IN SUPPLY (4.5V)		BATT. SUPPLY (2.25V)	
	Powersave	ESP=ON	Powersave	ESP=ON
Play-mode	90mA typ.	110mA typ.	80mA typ.	120mA typ.
Charge-mode	220mA typ.		n/a	
Jump-mode	400mA typ.		400mA typ.	
Stand-by	60 mA typ.		350 μA typ.	

Shock resistance

+X/-X direction	: ≥2.5 g
+Y/-Y direction	: ≥2.5 g
+Z/-Z direction	: ≥2 g

Headphone out (measured with 16Ω load, DBB/ESP off)

Output power (THD=10%)	
/17 version only	: 2x8mW (+1/-3dB)
all other versions	: 2x4mW (+2/-2dB)
Frequency response (1mW)	: 100Hz-20kHz within 6dB
S/N ratio (unwght)	: ≥80dB (82dB typ.)
S/N ratio (A-wght)	: ≥82dB (84dB typ.)
THD+N (1kHz, 1mW)	: ≤1% (0.2% typ.)
Channel crosstalk (1kHz, no load)	: ≤-65dB (-75dB typ.)
Channel unbalance (-40dB)	: ≤5dB
Volume attenuation (1kHz)	: ≥60dB

Dynamic Bass Boost DBB

DBB STAGE	Frequency response		
	63Hz	1kHz	10kHz
DBB	+8dB ± 2dB	0dB ± 2dB	0dB ± 2dB

Laser

Output power	: <5mW (3mW typ.)
Wavelength	: 780nm

Measurement setup

Use Audio Signal disc SBC429 4822 397 30184

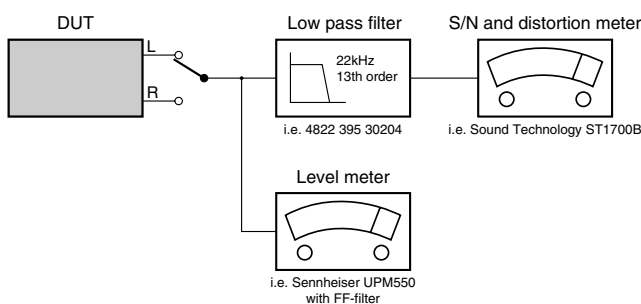

FEATURES

FEATURES OF CD-PORTABLE	AX5200/00C	AX5201/00C	AX5201/05Z	AX5202/00C	AX5202/01	AX5202/10	AX5203/00C	AX5203/05Z	AX5210/17	AX5211/17	AX5212/17	AX5215/17	AX5219/17
CD-RW COMPATIBILITY	●	●	●	●	●	●	●	●	●	●	●	●	●
ELECTRONIC SKIP PROTECTION	45s	45s	45s	45s	45s	45s	45s	45s	45s	45s	45s	45s	45s
ESP DRAM SIZE [Mbit]	16	16	16	16	16	16	16	16	16	16	16	16	16
HOLD / RESUME FUNCTION	●/●	●/●	●/●	●/●	●/●	●/●	●/●	●/●	●/●	●/●	●/●	●/●	●/●
DBB STAGES	1	1	1	1	1	1	1	1	1	1	1	1	1
ACOUSTIC FEEDBACK	●	●	●	●	●	●	●	●	●	●	●	●	●
PROGRAM MEMORY	30	30	30	30	30	30	30	30	30	30	30	30	30
RECHARGE NiCd / NiMH	--/--	--/--	--/--	--/--	--/--	--/--	●/●	●/●	--/--	--/--	--/--	--/--	--/--
BELT-CLIP	--	--	--	--	--	--	--	--	--	--	--	--	--
CORD REMOTE CONTROL	●	●	●	●	●	●	●	●	--	--	--	●	●
LINE / OPT. DIGITAL OUTPUT	--/--	--/--	--/--	--/--	--/--	--/--	--/--	--/--	--/--	--/--	--/--	--/--	--/--

ACCESSORIES

ACCESSORIES FOR CD-PORTABLE		AX5200	AX5201		AX5202		AX5203		AX5210	AX5211	AX5212	AX5215	AX5219
		/00c	/00c	/05z	/00c	/01	/10	/00c	/05z	/17	/17	/17	/17
AY3170/00 AC/DC Adaptor	4822 219 10617	O	X		X		X						
AY3170/02 AC/DC Adaptor	4822 219 10676				X								
AY3170/05 AC/DC Adaptor	4822 219 10672			X			X						
AY3170/10 AC/DC Adaptor	4822 219 10681					X							
AY3170/12 AC/DC Adaptor	4822 219 10671												
AY3273 Pouch	3140 113 10651	O	O	O	O	O	O	O	O	O	O	O	X
AY3363 Rechargeable Batt. NiMH	3103 308 84542						X	X					
AY3464 HiFi Cord (3.5mm L-plug→cinch)	4822 320 11881	O	O	O	O	O	O	O	O	O	O	O	O
AY3501/00 Car Adaptor Cassette	4822 397 10059	O	O	O	O	O	O	O	O	O	O	X	O
AY3545/17 Car DC/DC Converter	4822 219 10033	O	O	O	O	O	O	O	O	O	O	X	O
AY3548/17 Car DC/DC Converter	3140 118 71890											X	O
AY3778/00 Cord Remote Control	3140 118 51490	X	X	X	X	X	X	X				X	X
HE570/77s Headphone	9082 100 01724	X	X	X	X	X	X	X					
HS383/77 Headphone	9082 100 02026								X	X	X		
HS383/77s Headphone (S-plug)	9082 100 01821											X	X

X...supplied with the set, O...optional available

CONNECTIONS AND CONTROLS

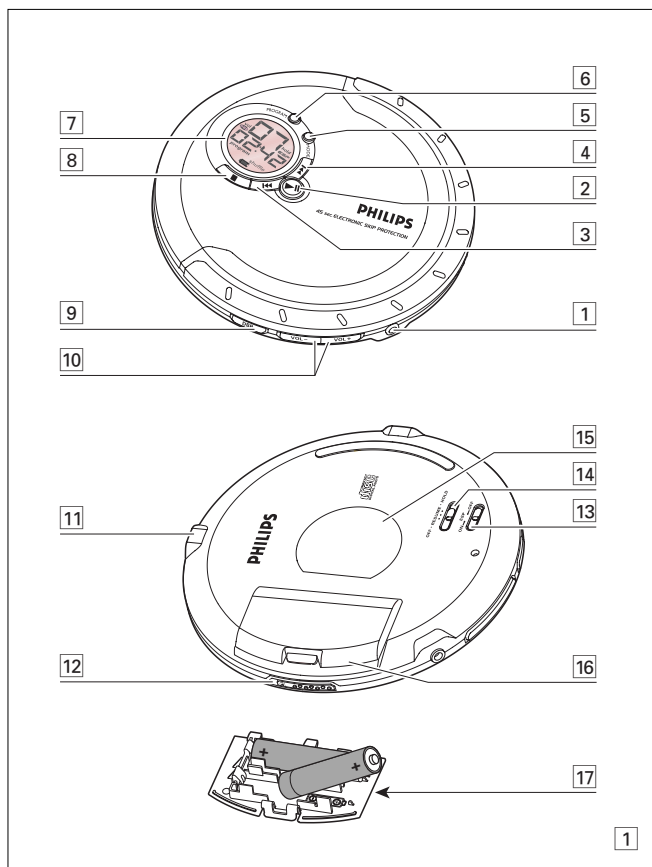

QUICK START

MISE EN SERVICE RAPIDE

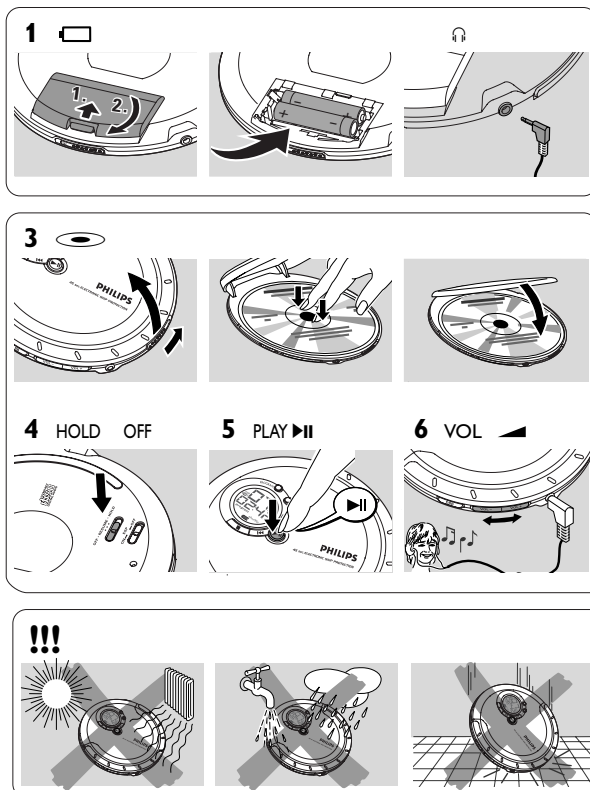

English

CONTROLS / POWER SUPPLY

CONTROLS (see figure 1)

- 1 LINE OUT/.....3.5 mm headphone socket, socket to connect the player to another audio input of an additional appliance, remote control socket (not on all versions)
- 2 ►||.....switches the player on, starts or pauses CD play
- 3 ◀◀.....skips and searches CD tracks backwards
- 4 ▶▶.....skips and searches CD tracks forwards
- 5 MODEselects the different playing possibilities: **shuffle**, **shuffle repeat all**, **repeat**, **repeat all** and **SCAN**
- 6 PROGRAMprograms tracks and reviews the program
- 7display
- 8 ■.....stops CD play, clears a program or switches the player off
- 9 DBB.....switches the bass enhancement on and off. This button also switches acoustic feedback (the beep) on/off when it is pressed for more than 2 seconds
- 10 VOL +/-.....adjusts the volume
- 11 4.5V DC.....socket for external power supply
- 12 OPEN ►.....opens the CD lid
- 13 ESP ON / OFF**ELECTRONIC SKIP PROTECTION** ensures continuous CD playback regardless of vibrations and shocks
- 14 OFF.....switches RESUME and HOLD off
RESUMEstores the last position of a CD track played
HOLD.....locks all buttons
- 15typeplate
- 16battery compartment
- 17AAA battery door

POWER SUPPLY / GENERAL INFORMATION

Average playing time of batteries under normal conditions

Battery type	ESPOn	PowerSave
Normal AA	5 hours	9 hours
Normal AAA	3 hours	5 hours
Alkaline AA	18 hours	33 hours
Alkaline AAA	8 hours	15 hours
Rechargeable ECO-PLUS NiMH battery	7 hours	12 hours

Batteries contain chemical substances, so they should be disposed of properly.

ECO-PLUS NiMH battery information (for versions supplied with the rechargeable ECO-PLUS NiMH battery AY 3363)

Recharging works only on players supplied with the rechargeable ECO-PLUS NiMH battery AY 3363.

Recharging the ECO-PLUS NiMH battery on board

- 1 Insert the rechargeable ECO-PLUS NiMH battery AY 3363.
- 2 Connect the mains adapter to the 4.5V DC socket of the player and then to the wall socket.
→ is pulsing.
- Recharging stops after a maximum of 7 hours, or when you start playback.
- 3 When the battery is fully recharged, and **FULL** appears in the display.

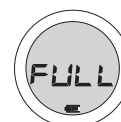

Notes: – It is normal for the batteries to become warm during recharging.
– If the batteries become too warm, recharging will be interrupted for approximately 30 minutes.
– To ensure proper recharging on board, take care that contacts are clean.
– Use only the ECO-PLUS NiMH battery AY 3363.

INSTRUCTION FOR USE

GENERAL INFORMATION

CD player and CD handling

- Do not touch the lens (A) of the CD player.
- Do not expose the unit, batteries or CDs to humidity, rain, sand or excessive heat (caused by heating equipment or direct sunlight).
- You can clean the CD player with a soft, slightly dampened, lint-free cloth. Do not use any cleaning agents as they may have a corrosive effect.
- To clean the CD, wipe it in a straight line from the center toward the edge using a soft, lint-free cloth. A cleaning agent may damage the disc! Never write on a CD or attach a sticker to it.
- The lens may cloud over when the unit is moved suddenly from cold to warm surroundings. Playing a CD is not possible then. Leave the CD player in a warm environment until the moisture has evaporated.
- Active mobile phones in the vicinity of the CD player may cause malfunctions.
- Avoid dropping the unit as this may cause damage.

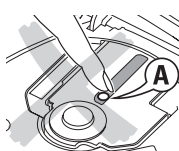

Headphones HE570

- Connect the supplied headphones to the LINE OUT/ear socket of the player.

Note: LINE OUT/ear can also be used for connecting this set to your HiFi system. To adjust the sound and volume, use the controls on the connected audio equipment and on the CD player.

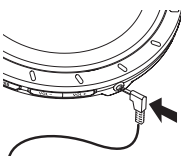

IMPORTANT!

Hearing safety: Do not play your headphones at a high volume. Hearing experts advise that continuous use at high volume can permanently damage your hearing.

Traffic safety: Do not use headphones while driving a vehicle. It may create a hazard and it is illegal in many countries. Even if your headphones are an open-air type designed to let you hear outside sounds, do not turn up the volume so high that you cannot hear what is going on around you.

In-car use (connections supplied or optionally available)

Only use the AY 3545 (4822 219 10033) or AY 3548 (3140 118 71890) car voltage converter (4.5 V DC, positive pole to the centre pin) and the AY 3501 car cassette adapter. Any other product may damage the set.

- 1 Put the set on a horizontal, vibration-free and stable surface. Make sure it is in a safe place, where the set is neither a danger nor an obstacle to the driver and the passengers.
 - 2 Plug the voltage converter into the cigarette lighter socket (**only for 12 V car battery, negative grounding**), then connect the wired end with 4.5V DC input socket on the set.
 - 3 If necessary, clean the cigarette lighter socket to obtain a good electrical contact.
 - 4 Turn down the volume and connect the cassette adapter plug to LINE OUT/ear on the set.
 - 5 Carefully insert the cassette adapter into the car radio's cassette compartment.
 - 6 Make sure the cord does not hinder your driving.
 - 7 Decrease the volume on the set if necessary. Start playback on the set and adjust the sound with the car radio controls.
- **Always remove the voltage converter from the cigarette lighter socket when the set is not in use.**

Note: If your car radio has a LINE IN socket, it is better to use it for the car radio connection instead of the adapter cassette. Connect the signal lead to this LINE IN socket and to LINE OUT/ear on the set.

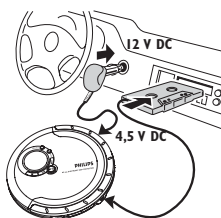

CD PLAY

Playing a CD

This CD-player can play all kinds of **Audio Discs** such as CD-Recordables and CD-Rewritables. Do not try to play a CD-ROM, CDi, VCD, DVD or computer CD.

- 1 Push the OPEN ► slider to open the player.
- 2 Insert an audio CD, printed side up, by pressing the CD onto the hub.
- 3 Close the player by pressing the lid down.
- 4 Press ►► to switch the player on and start playback.
 - The current track number and elapsed playing time are displayed.
- You can pause playback by pressing ►►.
 - The time at which playback was paused starts flashing.
- You can continue playback by pressing ►► again.
- 5 Press ■ to stop playback.
 - The total number of tracks and the total playing time of the CD are displayed.
- 6 Press ■ again to switch the player off.

Note: If there is no activity, the set will automatically switch off after a while to save energy.

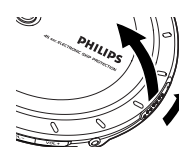

Playback information

- If a CD-Recordable (CD-R) or a CD-Rewritable (CD-RW) is not recorded properly, **FF d 15C** is displayed, indicating that the CD has not been finalized. In that case, use FINALIZE on your CD recorder to complete the recording.
- When playing a CD-Rewritable (CD-RW), please note that it takes 3–15 seconds after pressing ►► for sound reproduction to start.
- Playback will stop if you open the CD lid.
- While the CD is read, **---** flashes in the display.



Volume and bass

Volume adjustment

- Adjust the volume by using VOL +/-.

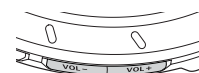

Bass adjustment

- Press DBB to switch the bass enhancement on or off.
 - **DBB** is shown if the bass enhancement is activated.

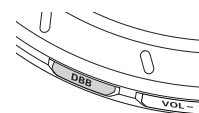

Remote control (for some versions only)

Use the AY 3768 / AY3778 cord remote control. The buttons on the remote control have the same functions as the corresponding buttons on the set.

- 1 Press ■ twice to switch off the set.
- 2 Firmly connect the remote control to LINE OUT/ear on the set.
- 3 Adjust the volume on the CD player and remote control.



INSTRUCTION FOR USE

FEATURES

Selecting a track and searching

Selecting a track during playback

- Briefly press ◀◀ or ▶▶ once or several times to skip to the current, previous or next track.
 - ▶ Playback continues with the selected track, and the track's number is displayed.



Selecting a track when playback is stopped

- Briefly press ◀◀ or ▶▶ once or several times to select the desired track. The track number is displayed.
- Press ▶▶ to start CD play.
 - ▶ Playback starts with the selected track.

Searching for a passage during playback

- Keep ◀◀ or ▶▶ pressed to find a particular passage in a backward or forward direction.
 - ▶ Searching starts while playback continues at low volume. After 2 seconds the search speeds up.
- Release the button when you reach the desired passage.
 - ▶ Playback continues from this position.

Notes: – If the player is in SCAN mode (see MODE chapter), searching is not possible.
 – In shuffle, shuffle repeat all or repeat mode (see MODE chapter), or while playing a program, searching is only possible within the particular track.

Programming track numbers

You can store up to 30 tracks to play in a program. A single track may be stored more than once in the program.

- While playback is stopped, select a track with ◀◀ or ▶▶.
 - Press PROGRAM to store the track.
 - ▶ **program** lights up; the track number programmed and P with the total number of stored tracks are displayed.
 - Select and store all desired tracks in this way.
 - Press ▶▶ to start playback of your selected tracks.
 - ▶ **program** is shown and playback starts.
- You can review the program by pressing PROGRAM for more than 2 seconds.
 - ▶ The display shows all the stored tracks in sequence.



Notes: – If you press PROGRAM and there is no track selected, 5 E L is displayed.
 – If you try to store more than 30 tracks, F U L L is displayed.

Clearing the program

- While playback is stopped, press ■ to clear program.
 - ▶ E L F is displayed once, **program** goes off, and the program is cleared.



Note: The program will also be cleared if the power supply is interrupted, or if the CD-player lid is opened, or if the set switches off automatically.

FEATURES

Selecting different playing possibilities MODE

It is possible to play tracks in random order, to repeat a single track or the entire CD, and to play the first few seconds of each track.

- Press MODE during playback as often as required in order to activate one of the following 'modes'. The active mode is shown in the display.
 - ▶ **shuffle**: All tracks of the CD are played in random order until all of them have been played once.
 - ▶ **shuffle repeat all**: All tracks of the CD are played repeatedly in random order.
 - ▶ **repeat**: The current track is played repeatedly.
 - ▶ **repeat all**: The entire CD is played repeatedly.
 - ▶ **5 S E C**: The first 10 seconds of each of the remaining tracks are played in sequence.
- Playback starts in the chosen mode after 2 seconds.



- To return to normal playback, press MODE repeatedly until the display shows no active modes.

ESP / Power Save Mode

With a conventional portable CD-player you might have experienced that the music stopped e.g. when you were jogging. The **ELECTRONIC SKIP PROTECTION** prevents loss of sound caused by light vibrations and shocks. Continuous playback is ensured. However ESP does not prevent playback interruptions during vigorous running. It also does not protect the unit against any **damage** caused by **dropping!**

- Switch the slider to ESP ON during playback to activate the shock protection.
 - ▶ **ESP** is shown and the protection is activated.
- To deactivate the shock protection, switch the slider to OFF.
 - ▶ **ESP** goes off and the protection is deactivated.

ESP on → Power Save → ESP on

RESUME and HOLD

You can interrupt playback and continue (even after an extended period of time) from the position where playback stopped (RESUME) and you can lock all buttons of the set so that no action will be executed (HOLD). Use the OFF-RESUME-HOLD slider for these functions.

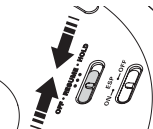

RESUME – continuing from where you have stopped

- Switch the slider to RESUME during playback to activate RESUME.
 - ▶ **resume** is shown.
- Press ■ whenever you want to stop playback.
- Press ▶▶ whenever you want to resume playback.
 - ▶ **resume** is shown and playback continues from where you have stopped.



- To deactivate RESUME, switch the slider to OFF.
 - ▶ **resume** goes off.

HOLD – locking all buttons

You can lock the buttons of the set by switching the slider to HOLD. Now, when a key is pressed, no action will be executed. This is of use, for example, when transporting the player in a bag. With HOLD activated, you can avoid accidental activation of other functions.

- Switch the slider to HOLD to activate HOLD.
 - ▶ All buttons are locked **HOLD** is shown when you press any button. If the set is switched off, **HOLD** will be shown only when ▶▶ is pressed.
- To deactivate HOLD, switch the slider to OFF.



Note: If you deactivate HOLD by switching the slider to RESUME, you will be activating the RESUME function.

INSTRUCTION FOR USE

Batteries (supplied or optionally available)

You can use the following batteries with this CD-player:

- alkaline batteries type **AAA (LR03, UM4)** or **AA (LR6, UM3)** preferably Philips.

Notes:— Old and new or different types of batteries should not be combined.

— Remove batteries if they are empty or if the player is not going to be used for a long time.

Inserting AAA (LR03, UM4) or AY 3363 batteries

- Open the **AAA** battery door.
- Insert **AAA** batteries as shown onto the back of the door.
- Replace the battery-loaded **AAA** door back onto the set.

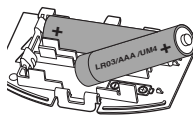

AAA (LR03, UM4)

Inserting AA (LR6, UM3) batteries

To double playback time, insert **AA** batteries into the battery compartment and use the **AA** marked battery door.

- Open the battery compartment and insert either 2 normal or alkaline batteries.

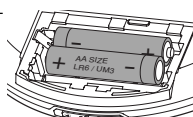

AA (LR6, UM3)

Battery indication

The approximate power level of your batteries is shown in the display.

- Battery full
- Battery two-thirds full
- Battery one-third full
- Battery dead or empty. When the batteries are dead or empty, the symbol flashes, *NO BATT* is displayed, and the beep tone sounds repeatedly.



TROUBLESHOOTING

Troubleshooting

WARNING: Under no circumstances should you try to repair the set yourself as this will invalidate the warranty. If a fault occurs, first check the points listed, before taking the unit for repair. If you are unable to solve a problem by following these hints, consult your dealer or service center.

The CD player has no power, or playback does not start

- Check that your batteries are not dead or empty, that they are inserted correctly, that the contact pins are clean.
- Your adapter connection may be loose. Connect it securely.
- For *in-car use*, check that the car ignition is on. Also check player's batteries.

The indication *NO d 15 C* is displayed

- Check that the CD is clean and correctly inserted (label-side upward).
- If your lens has steamed up, wait a few minutes for this to clear.

The indication *RF d 15 C* is displayed

- CD-RW (CD-R) was not recorded properly. Use FINALIZE on your CD-recorder.

The indication **HOLD** is on and/or there is no reaction to controls

- If **HOLD** is activated, then deactivate it.
- Electrostatic discharge. Disconnect power or remove batteries for a few seconds.

The CD skips tracks

- The CD is damaged or dirty. Replace or clean the CD.
- RESUME, SHUFFLE or PROGRAM is active. Switch off whichever is on.

Handling instructions

- Recharging already charged or half-charged batteries will shorten their lifetime. We therefore recommend that you let the rechargeable ECO-PLUS NiMH battery run till it is completely empty before you recharge it.
- To avoid a short circuit, do not let the battery touch any metal object.
- If the battery becomes empty soon after recharging, then either its contacts are dirty or it has reached the end of its lifetime.

Mains adapter (supplied or optionally available)

Use only the AY 3170 adapter (4.5 V / 300 mA direct current, positive pole to the center pin). Any other product may damage the player.

- Make sure the local voltage corresponds to the power adapter's voltage.
- Connect the power adapter to the 4.5V DC socket of the player and to the wall socket.

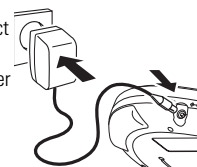

Note: Always disconnect the adapter when you are not using it.

Environmental information

- All redundant packing material has been omitted. We have done our utmost to make the packaging easily separable into two mono materials: cardboard (box) and polyethylene (bags, protective foam sheet).
- Your set consists of materials which can be recycled if disassembled by a specialized company. Please observe the local regulations regarding the disposal of packing materials, exhausted batteries and old equipment.

Troubleshooting

No sound or bad sound quality.

- PAUSE might be active. Press **||**.
- Loose, wrong or dirty connections. Check and clean connections.
- Volume might not be appropriately adjusted. Adjust the volume.
- Strong magnetic fields. Check player's position and connections. Also keep away from active mobile phones.
- For *in-car use*, check that the cassette adapter is inserted correctly, that the car cassette player's playback direction is correct (press autoreverse to change), and that the cigarette lighter jack is clean. Allow time for temperature change.

CAUTION

Use of controls or adjustments or performance of procedures other than herein may result in hazardous radiation exposure or other unsafe operation.

SAFETY & WARNINGS

Ⓒ **WARNING**

All ICs and many other semiconductors are susceptible to electrostatic discharges (ESD). Careless handling during repair can reduce life drastically.

When repairing, make sure that you are connected with the same potential as the mass of the set via a wristband with resistance. Keep components and tools at this potential.

Ⓕ **ATTENTION**

Tous les IC et beaucoup d'autres semi-conducteurs sont sensibles aux décharges statiques (ESD). Leur longévité pourrait être considérablement écourtée par le fait qu'aucune précaution n'est prise à leur manipulation.

Lors de réparations, s'assurer de bien être relié au même potentiel que la masse de l'appareil et enfilez le bracelet sertit d'une résistance de sécurité

Veiller à ce que les composants ainsi que les outils que l'on utilise soient également à ce potentiel.

ESD



Ⓓ **WARNUNG**

Alle ICs und viele andere Halbleiter sind empfindlich gegenüber elektrostatischen Entladungen (ESD).

Unvorsichtige Behandlung im Reparaturfall kann die Lebensdauer drastisch reduzieren.

Sorgen Sie dafür, daß Sie im Reparaturfall über ein Pulsarmband mit Widerstand mit dem Massepotential des Gerätes verbunden sind.

Halten Sie Bauteile und Hilfsmittel ebenfalls auf diesem Potential.

Ⓖ **WAARSCHUWING**

Alle IC's en vele andere halfgeleiders zijn gevoelig voor electrostatische ontladingen (ESD).

Onzorgvuldig behandelen tijdens reparatie kan de levensduur drastisch doen verminderen. Zorg ervoor dat u tijdens reparatie via een polsband met weerstand verbonden bent met hetzelfde potentiaal als de massa van het apparaat.

Houd componenten en hulpmiddelen ook op ditzelfde potentiaal.

Ⓘ **AVVERTIMENTO**

Tutti IC e parecchi semi-conduttori sono sensibili alle scariche statiche (ESD).

La loro longevità potrebbe essere fortemente ridotta in caso di non osservazione della più grande cauzione alla loro manipolazione. Durante le riparazioni occorre quindi essere collegato allo stesso potenziale che quello della massa del apparecchio tramite un braccialetto a resistenza.

Assicurarsi che i componenti e anche gli utensili con quali si lavora siano anche a questo potenziale.

Ⓒ **AVAILABLE ESD PROTECTION EQUIPMENT :**

anti-static table mat large 1200x650x1.25mm
small 600x650x1.25mm

anti-static wristband

connection box (3 press stud connections, 1MΩ)

extendible cable (2m, 2MΩ, to connect wristband to connection box)

connecting cable (3m, 2MΩ, to connect table mat to connection box)

earth cable (1MΩ, to connect any product to mat or to connection box)

KIT ESD3 (combining all 6 prior products - small table mat)

wristband tester

4822 466 10953

4822 466 10958

4822 395 10223

4822 320 11307

4822 320 11305

4822 320 11306

4822 320 11308

4822 310 10671

4822 344 13999

Ⓒ **WARNING**

Safety regulations require that the set be restored to its original condition and that parts which are identical with those specified be used.

Safety components are marked by the symbol

Ⓕ **ATTENTION**

Les normes de sécurité exigent que l'appareil soit remis à l'état d'origine et que soient utilisées les pièces de rechange identiques à celles spécifiées.

Les composants de sécurité sont marqués

SAFETY



Ⓓ **WARNUNG**

Bei jeder Reparatur sind die geltenden Sicherheitsvorschriften zu beachten. Der Originalzustand des Gerätes darf nicht verändert werden. Für Reparaturen sind Originalersatzteile zu verwenden.

Sicherheitsbauteile sind durch das Symbol

Ⓖ **WAARSCHUWING**

Veiligheidsbepalingen vereisen, dat het apparaat in zijn oorspronkelijke toestand wordt teruggebracht en dat onderdelen, identiek aan de gespecificeerde, worden toegepast. De Veiligheidsonderdelen zijn aangeduid met het symbool

Ⓘ **AVVERTIMENTO**

Le norme di sicurezza estigono che l'apparecchio venga rimesso nelle condizioni originali e che siano utilizzati i pezzi di ricambio identici a quelli specificati.

Componenti di sicurezza sono marcati con

Ⓒ **DANGER**

DANGER: Invisible laser radiation when open. AVOID DIRECT EXPOSURE TO BEAM.



Ⓔ **Varning !**

Osynlig laserstrålning när apparaten är öppnad och spårren är urkopplad. Betrakta ej strålen.

Ⓓ **Advarsel !**

Usynlig laserstrålning ved åbning når sikkerhedsafbrydere er ude af funktion. Undgå udsættelse for strålning.

Ⓕ **Varoitus !**

Avatussa laitteessa ja suojalukituksen ohitettaessa olet alttiina näkymättömälle laserisäteilylle. Älä katso säteeseen !

Ⓒ **WARNING**

After servicing and before returning the set to customer perform a leakage current measurement test from all exposed metal parts to earth ground, to assure no shock hazard exists.

The leakage current must not exceed 0.5mA.

Ⓕ **ATTENTION**

"Pour votre sécurité, ces documents doivent être utilisés par des spécialistes agréés, seuls habilités à réparer votre appareil en panne".

SERVICE HINTS

REPAIR POSITION COPPERSIDE

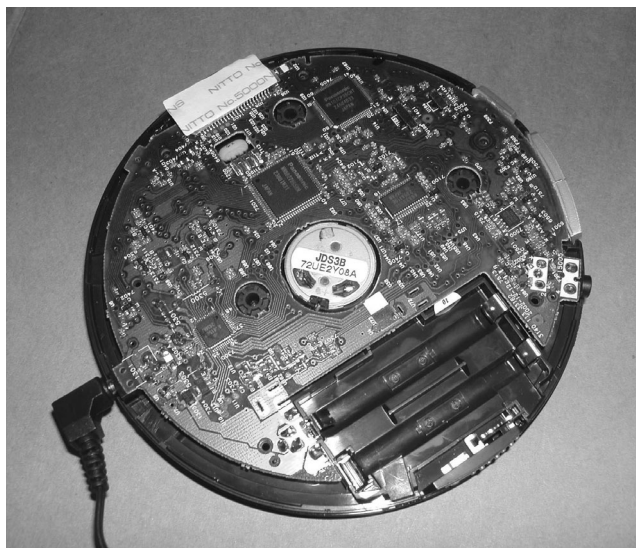

To get access to the copperside of the printed board assembly proceed as follows:

1. Remove the bottom (3x) screws (2x of them under the rubber-foot) and the up (2x) screws (in the CD-door)
2. Lift the bottom -cabinet
3. Supply the unit via external DC-socket
4. Take care that the door switch is closed during measurements

DISMANTLING THE CD-DOOR



To dismantle the CD-door proceed as follows:

1. Dismantle bottom and printed board/drive assembly
2. Disconnect the sticker (flex-foil connector on the membrane keyboard)
3. Disconnect membrane keyboard (flex-foil connector on copperside of printed board)

REPAIR POSITION COMPONENTSIDE



To get access to the componentside of the printed board assembly proceed as followed:

1. Remove the bottom (3x) screws (2x of them under the rubber-foot) and the up (2x) screws (in the CD-door)
2. Open the CD-door
3. Lift the top-cabinet and put it backwards on the table
4. Supply the unit via the external DC-socket
5. Take care that the door switch is closed during measurements

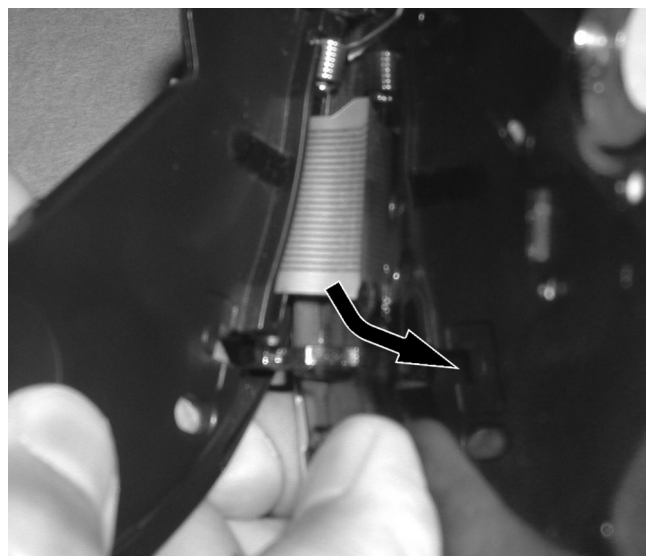

4. Bend the cabinet rightwards downwards as indicated in the picture above

Remark: Do not use screwdrivers or tools .
Sharp edges could damage hinge or cabinet part.

HANDLING CHIP COMPONENTS

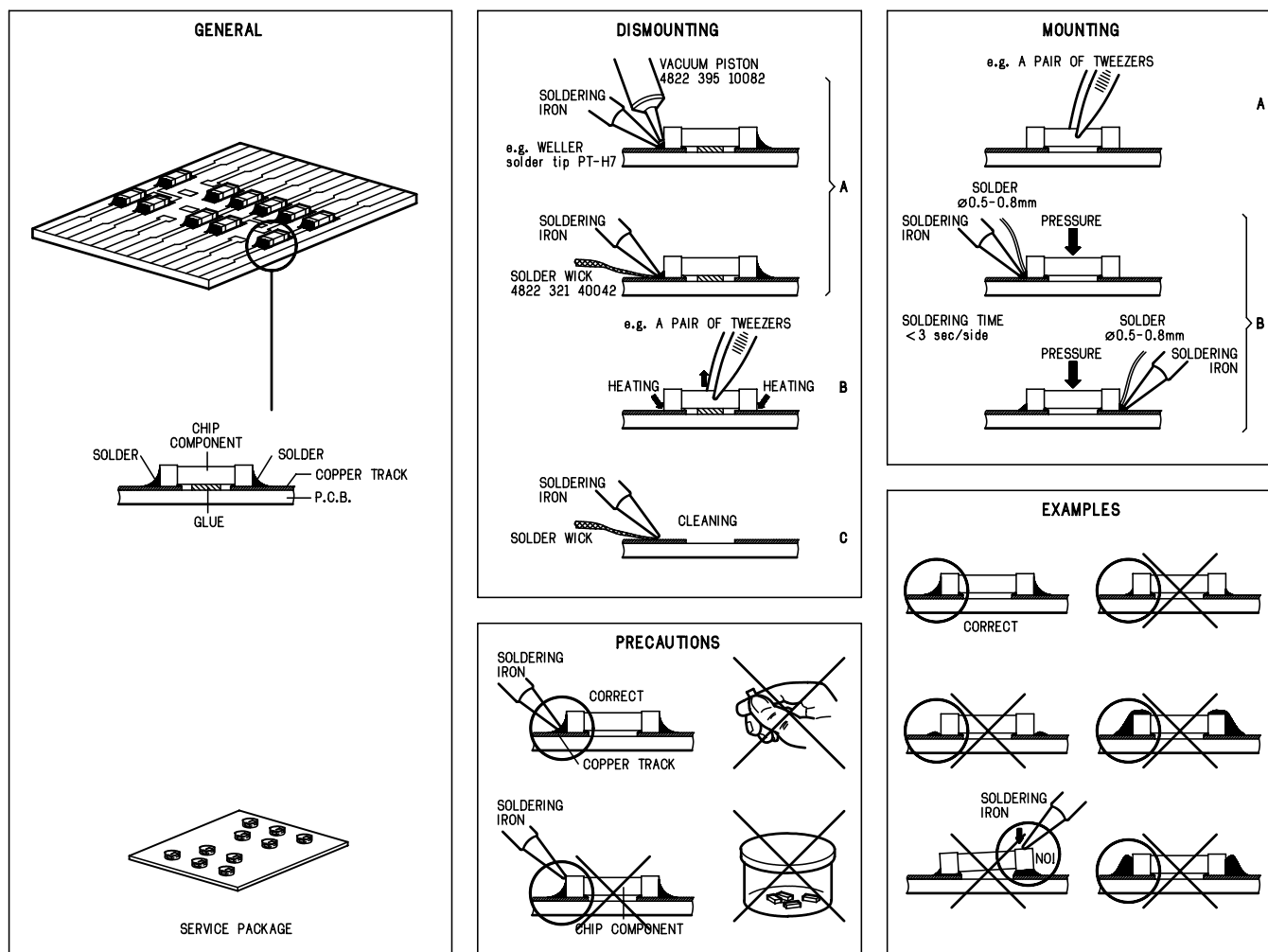

SERVICE TOOLS

Audio signal disc SBC429

4822 397 30184

Playability test disc SBC444

4822 397 30245

Test disc 5 (disc without errors) + **Test disc 5A** (disc with dropout errors
black spots and fingerprints) **SBC426/ SBC426A**

4822 397 30096

ESD PROTECTION EQUIPMENT

Anti-static table mat large 1200x650x1.25mm
small 600x650x1.25mm

4822 466 10953

4822 466 10958

Anti-static wristband

4822 395 10223

Connection box (3press stud connections, 1M Ω)

4822 320 11307

Extendible cable (2m, 2M Ω , to connect wristband to connection box)

4822 320 11305

Connecting cable (3m, 2M Ω , to connect table mat to connection box)

4822 320 11306

Earth cable (1M Ω , to connect any product to mat or to connection box)

4822 320 11308

KIT ESD3 (combining all 6 prior products - small table mat)

4822 310 10671

Wristband tester

4822 344 13999

PIN DESCRIPTION OF INTEGRATED CIRCUITS

MN662786SB – SIGNAL PROCESSING IC

Pin	Name	I/O	Description
1	DRVDD	I	Power supply for DRAM interface (Pin 2 to 19, and 80)
2	D0	I/O	DRAM data I/O signal 0
3	D1	I/O	DRAM data I/O signal 1
4	NWE	O	DRAM write enable signal
5	NRAS	O	DRAM RAS control signal
6	D2	I/O	DRAM data I/O signal 2
7	D3	I/O	DRAM data I/O signal 3
8	NCAS0	O	DRAM CAS control signal 0
9	NCAS1	O	DRAM CAS control signal 1
10	A8	O	DRAM address signal 8
11	A7	O	DRAM address signal 7
12	A6	O	DRAM address signal 6
13	A5	O	DRAM address signal 5
14	A4	O	DRAM address signal 4
15	A9	O	DRAM address signal 9
16	A0	O	DRAM address signal 0
17	A1	O	DRAM address signal 1
18	A2	O	DRAM address signal 2
19	A3	O	DRAM address signal 3
20	DVSS2	I	Ground for digital circuits
21	DVDD2	I	Power supply for digital circuits
22	SPOUT	O	Spindle motor drive signal output (Absolute value output)
23	TRVP	O	Traverse drive output (+side output)
24	TRVM	O	Traverse drive output (-side output)
25	TRP	O	Traverse drive output (+side output)
26	TRM	O	Traverse drive output (-side output)
27	FOP	O	Focus drive output (+side output)
28	FOM	O	Focus drive output (-side output)
29	IOVDD1	I	I/O power supply
30	TBAL	O	Tracking balance adjustment output
31	FBAL	O	Focus balance adjustment output
32	FE	I	Focus error signal input (Analog input)
33	TE	I	Tracking error signal input (Analog input)
34	RFENV	I	RF envelope signal input (Analog input)
35	OFT	I	Off-track signal input H: Off track
36	NRFDET	I	RF detection signal input L: Detect
37	BDO	I	Dropout signal input H: Dropout
38	LDON	O	Laser ON signal output H: ON
39	ARF	I	RF signal input
40	IREF	I	Reference current input
41	ADPVCC	I	A/D converter reference voltage input (Analog input)
42	DSLFL	O	DSL loop filter
43	DRFL	I	DSL bias
44	PLLFL	O	PLL loop filter
45	VCOFL	O	Jitter-free VCO loop filter
46	AVDD2	I	Power supply for analog circuits (For DSL, PLL, VCOFL, A/D converter, and D/A converter)
47	AVSS2	I	Ground for analog circuits (For DSL, PLL, VCOFL, A/D converter, and D/A converter)
48	OUTL	O	L-ch audio output
49	AVSS1	I	Ground for analog circuit (For audio output stage)
50	OUTR	O	R-ch audio output
51	AVDD1	I	Power supply for analog circuits (For audio output stage)
52	FSEL	I	Noise filter for microcontroller interface ON/OFF selection input L:ON H:OFF
53	TMOD1	I	Test input pin Normal: L
54	TMOD2	I	Test input pin Normal: L
55	*FLAG	O	Flag signal output
56	*IPFLAG	O	Interpolation flag signal output H: Interpolation
57	*EXT0	I/O	Expansion I/O port 0
58	*EXT1	I/O	Expansion I/O port 1
59	IOVDD2	I	I/O power supply
60	TX	O	Digital audio interface signal output
61	MCLK	I	Microcontroller command clock signal input (Latches the data at a rising edge)
62	MDATA	I	Microcontroller command data signal input
63	MLD	I	Microcontroller command load signal input L: Load
64	*BLKCK	O	Subcode block clock signal output f=75 Hz (Normal-speed playback)
65	PWMSEL	I/O	PWM output mode selection input L: Direct H: 3-state
66	SMCK	O	4.236-MHz/8.4672-MHz clock signal output
67	DMUTE	I/O	Muting input H: Mute
68	STAT	O	Status signal output
69	NRST	I	Reset input L: Reset

<i>Pin</i>	<i>Name</i>	<i>I/O</i>	<i>Description</i>
70	*SPPOL	O	Spindle motor drive signal output (Polarity output)
71	PMCK	O	88.2-KHz clock signal output
72	*NCLDCK	O	Frame sync signal output f=7.35kHz (Normal-speed playback)
73	*SUBC	O	Subcode serial output
74	*SBCK	I	Subcode serial output clock input
75	NTEST	I	Test input pin Normal: H
76	X2	O	Crystal oscillator output pin f=16.9344 MHz
77	X1	I	Crystal oscillator input pin f=16.9344 MHz
78	DVSS1	I	Ground for digital circuits
79	DVDD1	I	Power supply for digital circuits
80	*EXT2	I	Expansion I/O part 2

AN41502 – DC-DC CONVERTER AND 4-CHANNEL PWM DRIVER

<i>Pin</i>	<i>Name</i>	<i>Description</i>
1	EMP	Low battery detection output
2	RESET	Reset output
3	OFF	DDC turning off
4	PREGND	Ground for control circuit block
5	EO	Step-up/down DDC error amplifier output
6	EI	Step-up/down DDC error amplifier input
7	SVcc	Step-up/down DDC error supply output
8	CRP	Ripple filter capacitor output
9	AVcc	Ripple filter connection
10	VSUBIN	Sub DDC error amplifier input
11	VSUB	Sub DDC power supply output
12	SSW	Sub DDC coil drive
13	SVccF	Step-up/down DDC power supply
14	USW	Step-up/down DDC coil drive 2
15	PGND1	Ground for power supply block1
16	DSW	Step-up/down DDC coil derive 1
17	PVcc1	Battery power supply input
18	VSEN	Battery voltage detection input
19	START	DDC startup
20	LG	VG voltage step-up coil drive
21	VG	Gate drive power supply
22	REGB	REG transistor drive
23	PVcc2	AC adapter power supply input
24	VCNT	Setting PVcc1 for charging
25	FO4	Ch.4 forward output
26	RO4	Ch.4 reverse output
27	DRGND2	Motor ground 2
28	FO3	Ch.3 forward output
29	RO3	Ch.3 reverse output
30	Vm	Motor power supply
31	RO2	Ch.2 reverse output
32	FO2	Ch.2 forward output
33	DRGND1	Motor ground 1
34	RO1	Ch.1 reverse output
35	FO1	Ch.1 forward output
36	MON	Vm monitoring
37	FI1	Ch.1 forward input
38	RI1	Ch.1 reverse input
39	FI2	Ch.2 forward input
40	RI2	Ch.2 reverse input
41	FI3	Ch.3 forward input
42	RI3	Ch.3 reverse input
43	FI4	Ch.4 forward input
44	RI4	Ch.4 reverse input
45	CLK	DDC external clock input
46	SOFT	Soft start setting
47	CT	Triangular wave output
48	SPRT	Power off time constant setting

MN101C39C-399 - MICROCOMPUTER BLOCK DIAGRAM

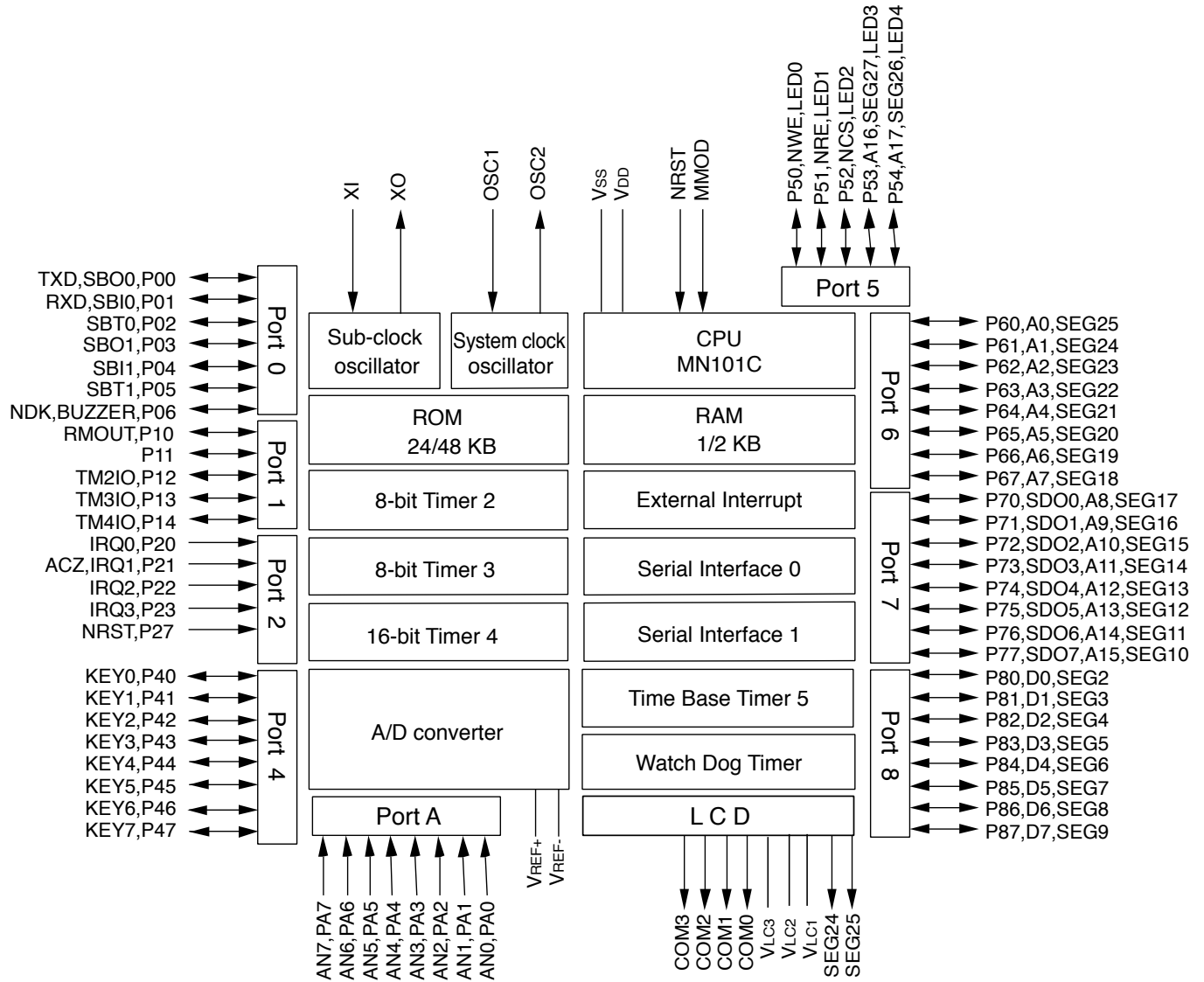

PIN DESCRIPTION OF MN101C39C-399

Pin Specification (1/2)

Pins	Special Functions	I/O	Direction Control	Pin Control	Functions Description
P00	SBO0 TXD	in/out	P0DIR0	P0PLU0	SBO0 : Serial Interface 0 transmission data output TXD : UART transmission data output
P01	SBI0 RXD	in/out	P0DIR1	P0PLU1	SBI0 : Serial Interface 0 reception data input RXD : UART reception data input
P02	SBT0	in/out	P0DIR2	P0PLU2	SBT0 : Serial Interface 0 clock I/O
P03	SBO1	in/out	P0DIR3	P0PLU3	SBO1 : Serial Interface 1 transmission data output
P04	SBI1	in/out	P0DIR4	P0PLU4	SBI1 : Serial Interface 1 reception data input
P05	SBT1	in/out	P0DIR5	P0PLU5	SBT1 : Serial Interface 1 clock I/O
P06	NDK BUZZER	in/out	P0DIR6	P0PLU6	NDK : Data acknowledgement signal BUZZER : Buzzer output
P10	RMOUT	in/out	P1DIR0	P1PLU0	RMOUT : Remote control carrier output
P11		in/out	P1DIR1	P1PLU1	
P12	TM2IO	in/out	P1DIR2	P1PLU2	TM2IO : Timer 2 I/O
P13	TM3IO	in/out	P1DIR3	P1PLU3	TM3IO : Timer 3 I/O
P14	TM4IO	in/out	P1DIR4	P1PLU4	TM4IO : Timer 4 I/O
P20	IRQ0	in	-	P2PLU0	IRQ0 : External interrupt 0
P21	IRQ1 ACZ	in	-	P2PLU1	IRQ1 : External interrupt 1 ACZ : Zero-cross input
P22	IRQ2	in	-	P2PLU2	IRQ2 : External interrupt 2
P23	IRQ3	in	-	P2PLU3	IRQ3 : External interrupt 3
P27	NRST	in	-	-	NRST : Reset
P40	KEY 0	in/out	P4DIR0	P4PLU0	KEY0 : KEY interrupt input 0
P41	KEY 1	in/out	P4DIR1	P4PLU1	KEY1 : KEY interrupt input 1
P42	KEY 2	in/out	P4DIR2	P4PLU2	KEY2 : KEY interrupt input 2
P43	KEY 3	in/out	P4DIR3	P4PLU3	KEY3 : KEY interrupt input 3
P44	KEY 4	in/out	P4DIR4	P4PLU4	KEY4 : KEY interrupt input 4
P45	KEY 5	in/out	P4DIR5	P4PLU5	KEY5 : KEY interrupt input 5
P46	KEY 6	in/out	P4DIR6	P4PLU6	KEY6 : KEY interrupt input 6
P47	KEY 7	in/out	P4DIR7	P4PLU7	KEY7 : KEY interrupt input 7
P50	NWE LED0	in/out	P5DIR0	P5PLU0	NWE : Write enable signal LED0 : LED driving pin 0
P51	NRE LED1	in/out	P5DIR1	P5PLU1	NRE : Read enable signal LED1 : LED driving pin 1
P52	NCS LED2	in/out	P5DIR2	P5PLU2	NCS : Chip select signal LED2 : LED driving pin 2
P53	A16 LED3	in/out	P5DIR3	P5PLU3	A16 : Address output (bp16) LED3 : LED driving pin 3
P54	SEG27 LED4	in/out	P5DIR4	P5PLU4	SEG27 : LCD segment output 27 LED : LED driving pin 4
	SEG26				SEG26 : LCD segment output 26
P60	A0 SEG25	in/out	P6DIR0	P6PLU0	A0 : Address output (bp0) SEG25 : LCD segment output 25
P61	A1 SEG24	in/out	P6DIR1	P6PLU1	A1 : Address output (bp1) SEG24 : LCD segment output 24
P62	A2 SEG23	in/out	P6DIR2	P6PLU2	A2 : Address output (bp2) SEG23 : LCD segment output 23
P63	A3 SEG22	in/out	P6DIR3	P6PLU3	A3 : Address output (bp3) SEG22 : LCD segment output 22
P64	A4 SEG21	in/out	P6DIR4	P6PLU4	A4 : Address output (bp4) SEG21 : LCD segment output 21
P65	A5 SEG20	in/out	P6DIR5	P6PLU5	A5 : Address output (bp5) SEG20 : LCD segment output 20
P66	A6 SEG19	in/out	P6DIR6	P6PLU6	A6 : Address output (bp6) SEG19 : LCD segment output 19
P67	A7 SEG18	in/out	P6DIR7	P6PLU7	A7 : Address output (bp7) SEG18 : LCD segment output 18

Pin Specification (2/2)

Pins	Special Functions	I/O	Direction Control	Pin Control	Functions Description
P70	A8 SEG17 SDO0	in/out	P7DIR0	P7PLUD0	A8 : Address output (bp8) SEG17 : LCD segment output 17 SDO0 : Synchronous output 0
P71	A9 SEG16 SDO1	in/out	P7DIR1	P7PLUD1	A9 : Address output (bp9) SEG16 : LCD segment output 16 SDO1 : Synchronous output 1
P72	A10 SEG15 SDO2	in/out	P7DIR2	P7PLUD2	A10 : Address output (bp10) SEG15 : LCD segment output 15 SDO2 : Synchronous output 2
P73	A11 SEG14 SDO3	in/out	P7DIR3	P7PLUD3	A11 : Address output (bp11) SEG14 : LCD segment output 14 SDO3 : Synchronous output 3
P74	A12 SEG13 SDO4	in/out	P7DIR4	P7PLUD4	A12 : Address output (bp12) SEG13 : LCD segment output 13 SDO4 : Synchronous output 4
P75	A13 SEG12 SDO5	in/out	P7DIR5	P7PLUD5	A13 : Address output (bp13) SEG12 : LCD segment output 12 SDO5 : Synchronous output 5
P76	A14 SEG11 SDO6	in/out	P7DIR6	P7PLUD6	A14 : Address output (bp14) SEG11 : LCD segment output 11 SDO6 : Synchronous output 6
P77	A15 SEG10 SDO7	in/out	P7DIR7	P7PLUD7	A15 : Address output (bp15) SEG10 : LCD segment output 10 SDO7 : Synchronous output 7
P80	D0 SEG2	in/out	P8DIR0	P8PLU0	D0 : Data I/O (bp0) SEG2 : LCD segment output 2
P81	D1 SEG3	in/out	P8DIR1	P8PLU1	D1 : Data I/O (bp1) SEG3 : LCD segment output 3
P82	D2 SEG4	in/out	P8DIR2	P8PLU2	D2 : Data I/O (bp2) SEG4 : LCD segment output 4
P83	D3 SEG5	in/out	P8DIR3	P8PLU3	D3 : Data I/O (bp3) SEG5 : LCD segment output 5
P84	D4 SEG6	in/out	P8DIR4	P8PLU4	D4 : Data I/O (bp4) SEG6 : LCD segment output 6
P85	D5 SEG7	in/out	P8DIR5	P8PLU5	D5 : Data I/O (bp5) SEG7 : LCD segment output 7
P86	D6 SEG8	in/out	P8DIR6	P8PLU6	D6 : Data I/O (bp6) SEG8 : LCD segment output 8
P87	D7 SEG9	in/out	P8DIR7	P8PLU7	D7 : Data I/O (bp7) SEG9 : LCD segment output 9
PA0	AN0	in	-	PAPLUD0	AN0 : Analog 0 input
PA1	AN1	in	-	PAPLUD1	AN1 : Analog 1 input
PA2	AN2	in	-	PAPLUD2	AN2 : Analog 2 input
PA3	AN3	in	-	PAPLUD3	AN3 : Analog 3 input
PA4	AN4	in	-	PAPLUD4	AN4 : Analog 4 input
PA5	AN5	in	-	PAPLUD5	AN5 : Analog 5 input
PA6	AN6	in	-	PAPLUD6	AN6 : Analog 6 input
PA7	AN7	in	-	PAPLUD7	AN7 : Analog 7 input
SEG0	SEG0	out	-	-	SEG0 : LCD segment output 0
SEG1	SEG1	out	-	-	SEG1 : LCD segment output 1
COM0	COM0	out	-	-	COM0 : LCD common output 0
COM1	COM1	out	-	-	COM1 : LCD common output 1
COM2	COM2	out	-	-	COM2 : LCD common output 2
COM3	COM3	out	-	-	COM3 : LCD common output 3

START-UP PROCEDURE -CHART

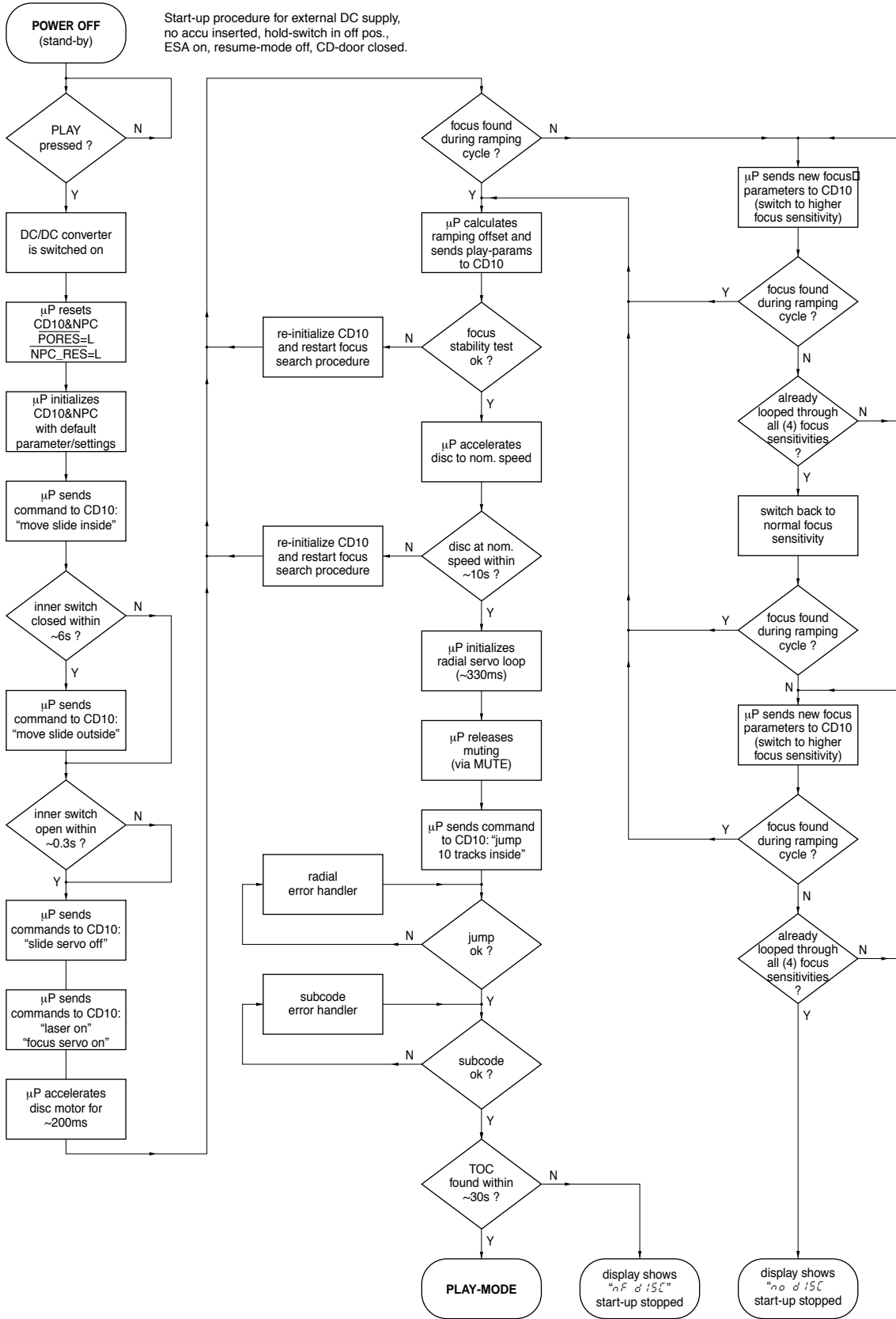

SERVICE TEST PROGRAM

1. PRELIMINARY SETUP

- To enter the service test program disconnect the AC/DC adaptor and remove batteries, open the CD-door and hold the buttons "PLAY" & "VOL+" depressed while turning power on (i.e. connecting the AC/DC adaptor).
- The display shows the software version of the built-in μP (i.e. "5-28"). Versions are counted from "00" onwards; that means the higher the number the newer the software.
- The program is now in the main menu – various tests can be entered by pressing the corresponding buttons (see flow chart on next page or detailed description of available tests below).
- To exit the service test program press the "STOP" button or disconnect the set from the power source.

2. DISPLAY TEST

Purpose: Check functionality of display and display driver.

- To enter the display test start the service test program and press the "NEXT" button.
- The display shows test pattern1. All segments are activated for finding open circuits (see flow chart on next page).
- To jump to the next pattern press the "NEXT" button.
- The display shows test pattern2. All alternate pins (2, 4, ...) are activated for finding short circuits (see flow chart on next page).
- To jump back to test pattern1 press the "NEXT" button, to exit the display test and return to the main menu press the "STOP" button.

3. KEY TEST

Purpose: Check operation of keys and cord remote control.

- To enter the key test start the service test program and press the "MODE" button.
- The display shows "--".
- Hold key depressed and check corresponding key code on the display. Key codes can be found in table1 (see flow chart on next page).
- To exit the key test and return to the main menu press the "STOP" button.

4. PLAYBACK TEST WITH ERROR ANALYSIS

Purpose: Analyze errors that occur during playback and search for intermittent failures.

- To enter the playback test start the service test program and press the "BASS" button.
- To start the error analysis press the "PLAY" button. Note that the playback test can only be entered if the CD-door is closed.
- The set will read the TOC and start playback.

As long as the playback is free of errors the display shows track and time information like in normal play-mode. In case of errors corresponding error codes will be displayed. The meaning of these error codes can be found in table2 (see flow chart on next page).

Note: Errors can either be "fatal" or "non fatal". Fatal errors always stop the playback, non fatal errors only cause a short interruption of the music. Fatal errors are displayed as long as the set is connected to the power source, non fatal errors are displayed until a new error occurs or a button is pressed.

- To stop the playback test disconnect the set from the power source.

5. SERVO TEST

Purpose: Check door switch, inner switch of CD-drive, movement of slide and acceleration of discmotor.

- To enter the servo test start the service test program and press the "PLAY" button.
- The display shows "x y".
"x" indicates state of door switch;
"y" indicates state of inner switch.
x,y = "0" means switch is closed; "1" means switch is open.
- To move slide outside hold the "NEXT" button depressed.
- To move slide inside hold the "PREV" button depressed.
- To accelerate the discmotor clockwise hold the "MODE" button depressed.
- To accelerate the discmotor counter-clockwise hold the "PROG" button depressed.
- To enter the focus test press the "PLAY" button, to exit the servo test and return to the main menu press the "STOP" button.

6. FOCUS TEST

Purpose: Check movement of lens and operation of focus servo for CDDA and CDRW discs.

Since the CDRW reflects much less light than an ordinary CDDA, the gain of the HF-amplifier stage and the sensitivity of the ADC inside the Decoder&Digital Servo IC "CD10" must be adapted accordingly. The gain is switched via the CDRW input of the HF-preamplifier. The ADC-sensitivity is set via software parameters (sent from μP to "CD10"). In total, there are 4 sensitivity modes available: 1 for CDDA and 3 for CDRW. The modes are listed in table3 (see next page). In normal play-mode, the correct focus sensitivity is chosen automatically during start-up (see "Start-up procedure" on previous page). In the service test program, the sensitivity can be chosen manually in order to allow individual measurements in several modes.

- The focus servo loop is switched on and the set starts searching the focus ("focus ramping"). As soon as the focus has been found the focus servo loop is closed and the state of the focus is monitored continuously.
- If the focus is OK the display shows "F x", else "-F x".
"x" indicates the sensitivity mode. Details can be found in table3 (see flow chart on next page).
- To toggle between sensitivity modes press the "BASS" button.
- To move slide outside hold the "NEXT" button depressed.
- To move slide inside hold the "PREV" button depressed.
- To accelerate the discmotor clockwise hold the "MODE" button depressed.
- To accelerate the discmotor counter-clockwise hold the "PROG" button depressed.
- In case the focus is OK the discmotor test can be entered by pressing the "PLAY" button, to exit the focus test and return to the main menu press the "STOP" button.

7. DISCMOTOR TEST

Purpose: Check speed regulation of discmotor.

- The speed regulation is switched on and the discmotor starts rotating. If the speed reaches 75% of the nom. speed the display shows "d", else "-d".
- In parallel also the state of the focus is monitored continuously (display "F x" or "-F x").
- In case the disc speed is OK and the focus is OK the radial test can be entered by pressing the "PLAY" button, to exit the discmotor test and return to the main menu press the "STOP" button.

8. RADIAL TEST

Purpose: Check if radial loop locks and an audio signal is audible at the headphone output.

- The radial servo loop is switched on, mute is released and the audio signal is audible. If the system is on track the display shows "r", else "-r".
- In parallel also the disc speed (display "d" or "-d") and the state of the focus (display "F x" or "-F x") are monitored continuously. Note: In case of radial errors the audio output is muted and muting is not released automatically when the systems recovers from the error. "-r" remains on the display.
To open mute again press the "NEXT" or "PREV" button.
- To jump 16 tracks outside press the "NEXT" button.
- To jump 16 tracks inside press the "PREV" button.
- To exit the radial test and return to the main menu press the "STOP" button, to exit the service test program disconnect the set from the power source.

Important remark:

In radial test mode data to the DRAM is written at 1.2 times the nominal speed, and read from the DRAM at nominal speed. Because writing is done faster than reading the DRAM gets full after a certain time.

In normal play mode the system would now wait until the DRAM is partly emptied again, jump backwards and resume filling at the last written position. However, in radial test mode the jumps would disturb measurements on the radial servo loop. Therefore this function has been disabled and filling restarts immediately from the current position of the pick-up unit. As a result "jumps" are audible during playback.

SERVICE TEST PROGRAM - FLOW CHART

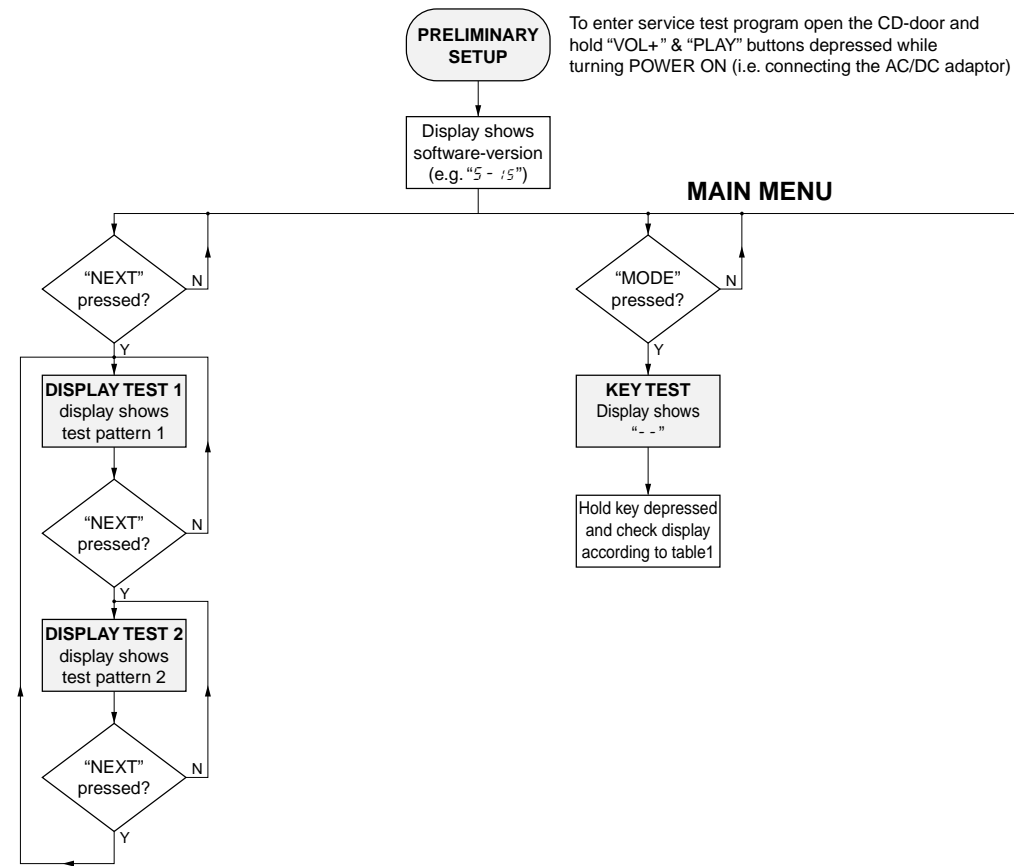

test pattern 1 (all segments activated)

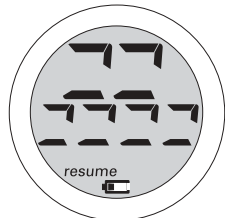

test pattern 2 (alternate segments activated)



table1 - key test

KEY	DISPLAY
DBB	0 1
PROGRAM	0 2
MODE	0 3
PLAY	0 5
NEXT	0 6
PREVIOUS	0 7

Press "STOP" on the CD-player to exit the key test.

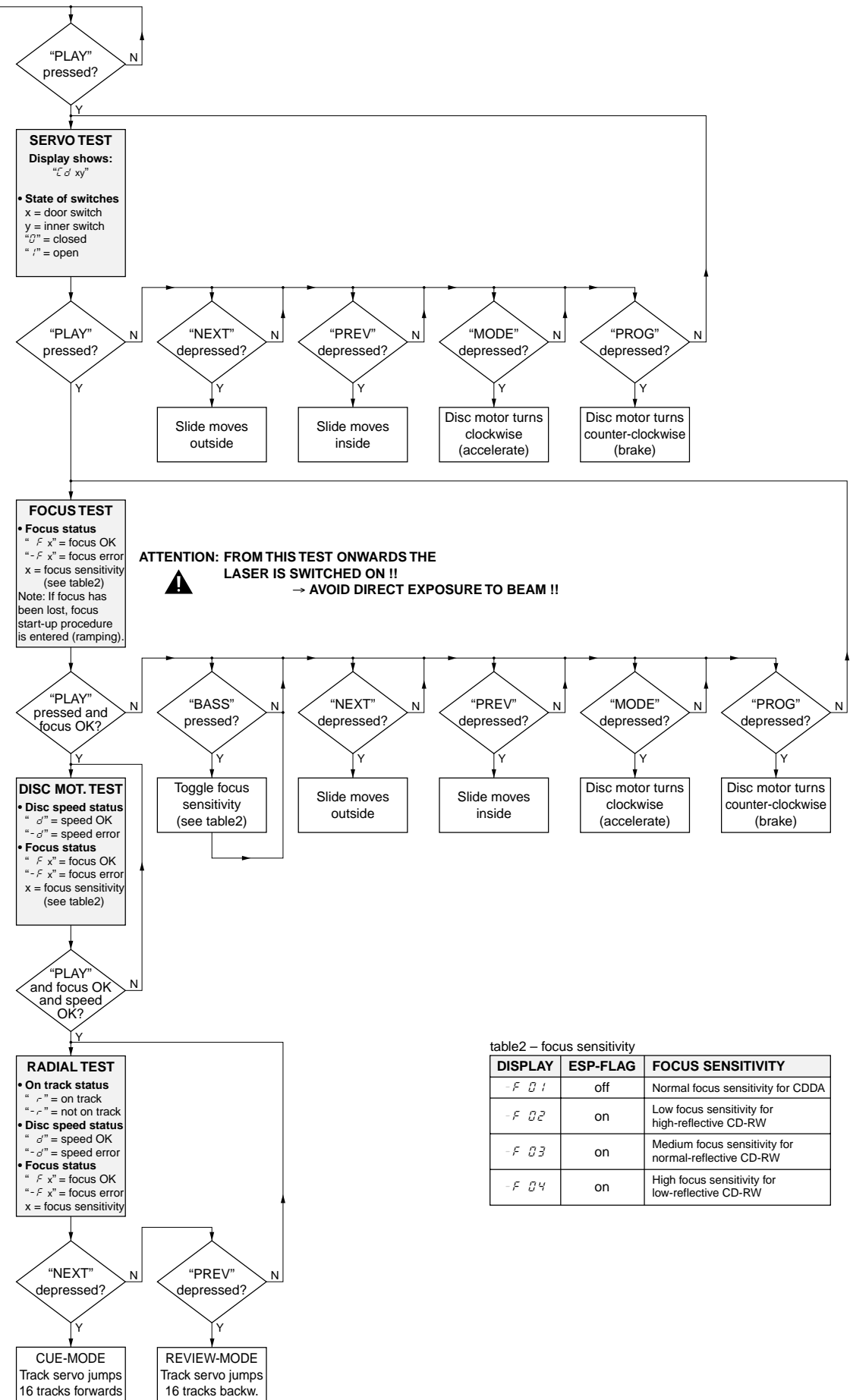

ATTENTION: FROM THIS TEST ONWARDS THE LASER IS SWITCHED ON !!
 → AVOID DIRECT EXPOSURE TO BEAM !!

table2 - focus sensitivity

DISPLAY	ESP-FLAG	FOCUS SENSITIVITY
- F 0 1	off	Normal focus sensitivity for CDDA
- F 0 2	on	Low focus sensitivity for high-reflective CD-RW
- F 0 3	on	Medium focus sensitivity for normal-reflective CD-RW
- F 0 4	on	High focus sensitivity for low-reflective CD-RW

BLOCKDIAGRAM

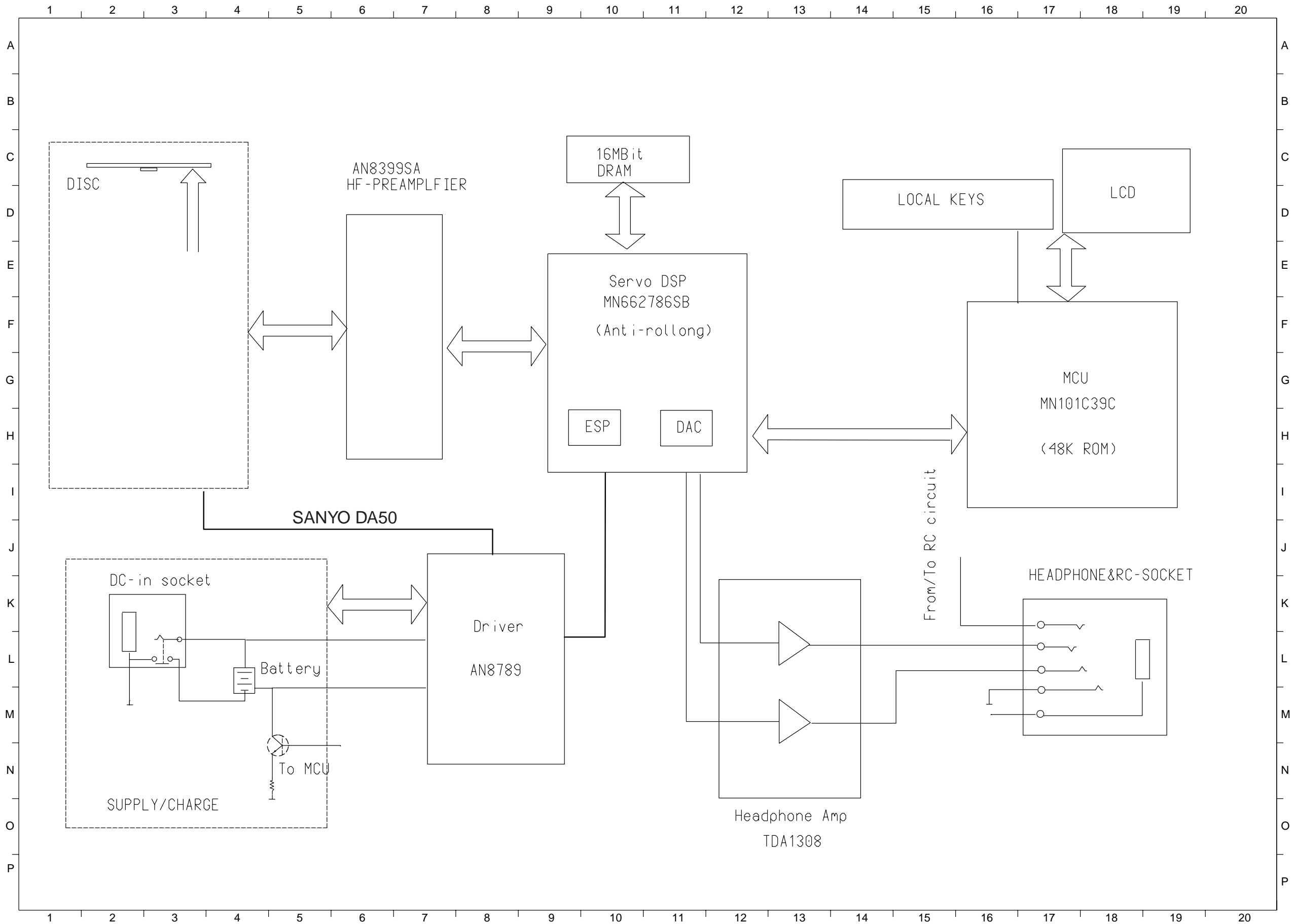

CIRCUIT DIAGRAM - CONTROL / SUPPLY PART

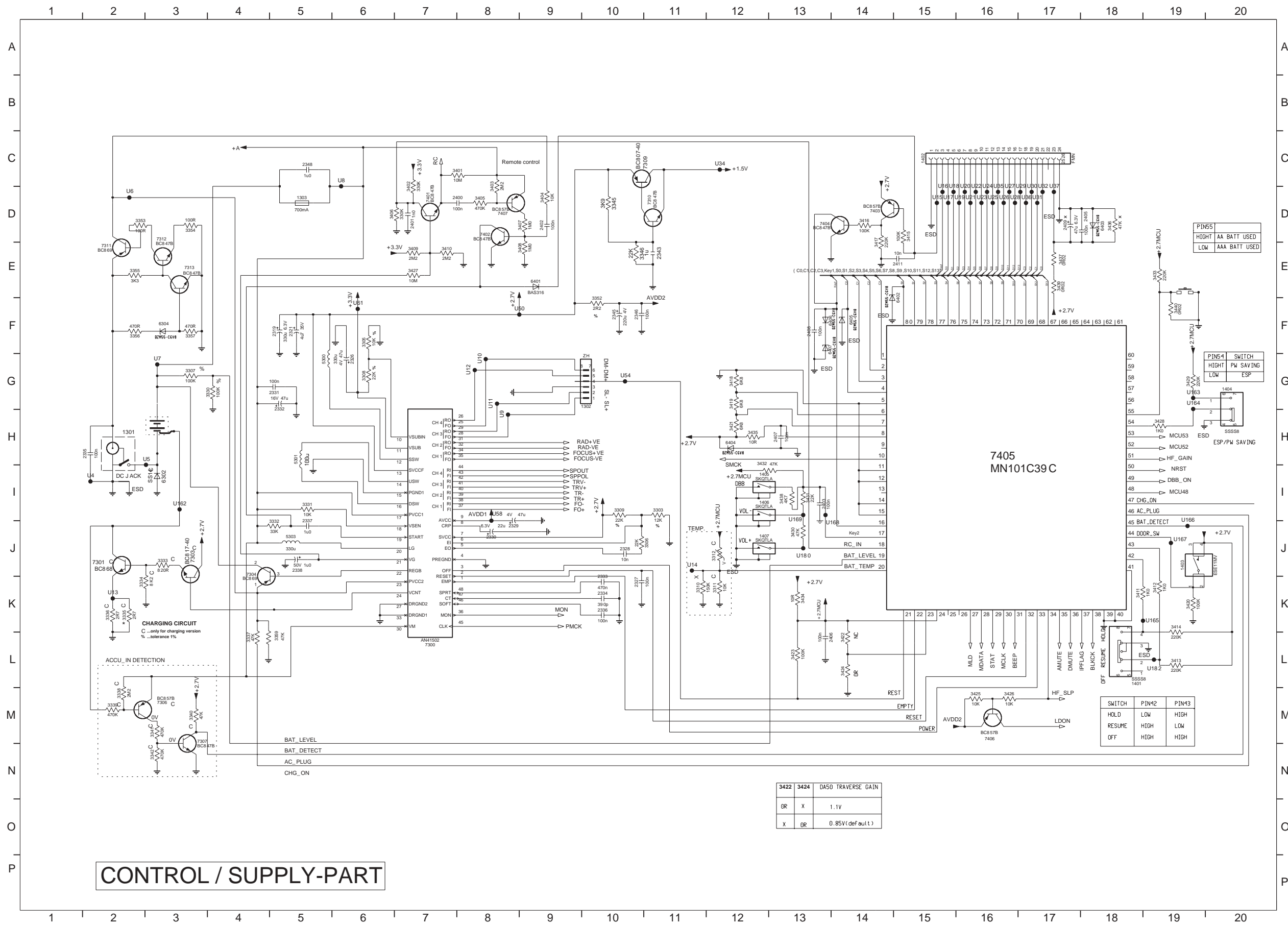

CONTROL / SUPPLY-PART

3422	3424	DA50 TRAVERSE GAIN
OR	X	1.1V
X	OR	0.85V (default)

- U4 G2 3439 D14
- U5 F3 3440 D16
- U6 C2 5300 E5
- U7 E3 5301 F5
- U8 C5 5303 G5
- U9 F7 6302 G3
- U10 E7 6304 E3
- U11 F7 6401 D8
- U12 E7 6402 D12
- U13 H2 6403 C15
- U14 H10 6404 F10
- U15 C13 6405 E12
- U16 C13 6406 E11
- U17 C13 6407 E11
- U18 C13 7300 I6
- U19 C13 7301 H2
- U20 C13 7303 H3
- U21 C13 7304 H4
- U22 C13 7306 J3
- U23 C13 7307 J3
- U24 C13 7309 C9
- U25 C14 7310 C9
- U26 C14 7311 D2
- U27 C14 7312 D3
- U28 C14 7313 D3
- U29 C14 7401 C6
- U30 C14 7402 D7
- U31 C14 7403 C12
- U32 C14 7404 C11
- U34 C10 7405 F14
- U35 C14 7406 J13
- U36 C14 7407 C7
- U37 C14 7408 G3
- U50 E7 U163 F16
- U54 E9 U164 F16
- U58 G7 U165 H16
- U61 D5 U166 G16
- U62 F2 U167 G16
- U63 C5 U168 G12
- U64 H5 U169 G11
- U65 H11 U180 H11
- U66 H16 U182 H16
- U67 H16 U182 H16
- U68 H16 U182 H16
- U69 H16 U182 H16
- U70 H16 U182 H16
- U71 H16 U182 H16
- U72 H16 U182 H16
- U73 H16 U182 H16
- U74 H16 U182 H16
- U75 H16 U182 H16
- U76 H16 U182 H16
- U77 H16 U182 H16
- U78 H16 U182 H16
- U79 H16 U182 H16
- U80 H16 U182 H16
- U81 H16 U182 H16
- U82 H16 U182 H16
- U83 H16 U182 H16
- U84 H16 U182 H16
- U85 H16 U182 H16
- U86 H16 U182 H16
- U87 H16 U182 H16
- U88 H16 U182 H16
- U89 H16 U182 H16
- U90 H16 U182 H16
- U91 H16 U182 H16
- U92 H16 U182 H16
- U93 H16 U182 H16
- U94 H16 U182 H16
- U95 H16 U182 H16
- U96 H16 U182 H16
- U97 H16 U182 H16
- U98 H16 U182 H16
- U99 H16 U182 H16
- U100 H16 U182 H16

CIRCUIT DIAGRAM - AUDIO PART

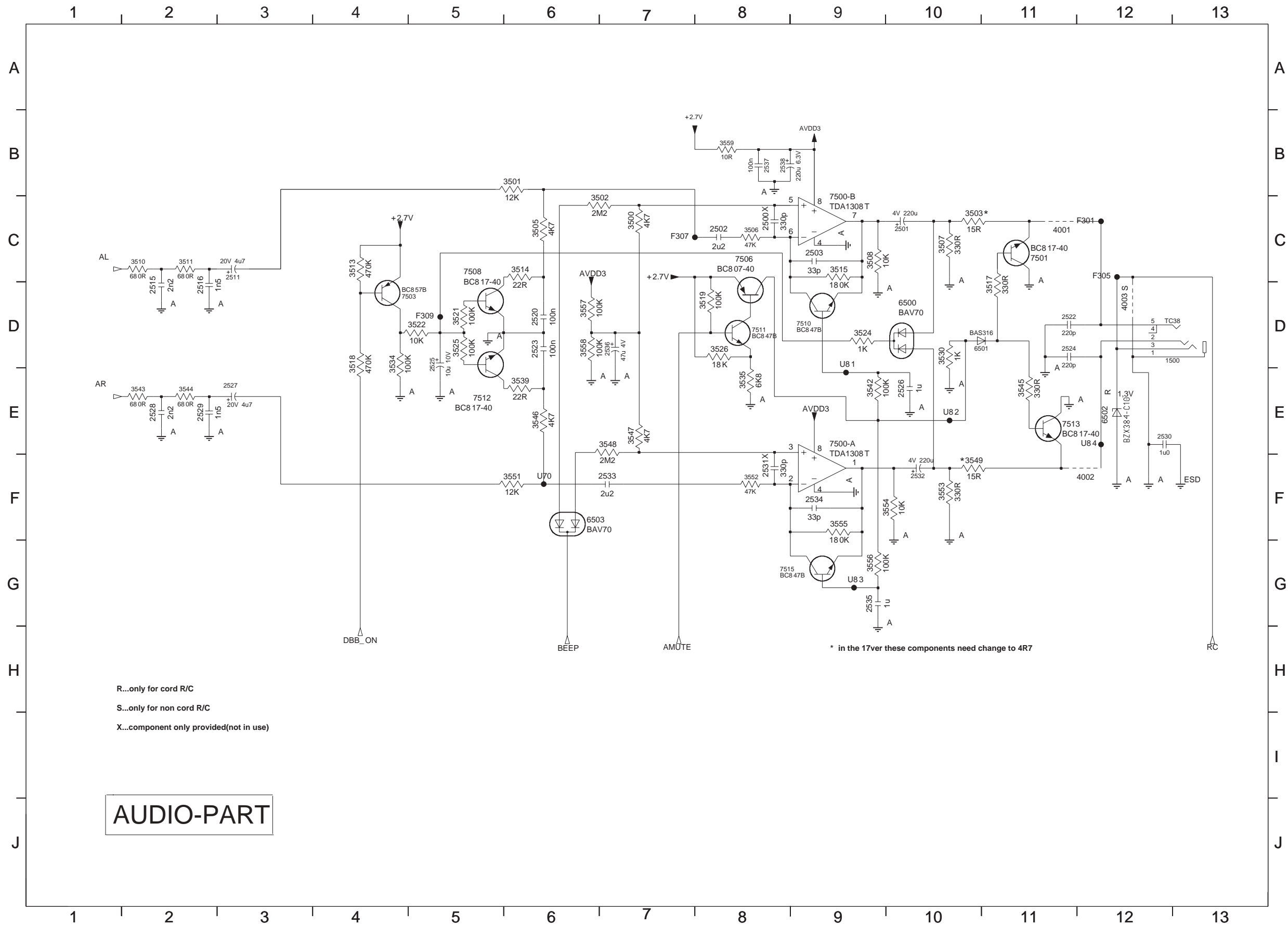

- U70 E6
- U81 D8
- U82 D9
- U83 F9
- U84 D11
- 1500 D11
- 2500 B8
- 2501 B9
- 2502 B7
- 2503 C8
- 2511 C3
- 2515 C2
- 2516 C3
- 2520 C6
- 2522 C10
- 2523 C6
- 2524 C10
- 2525 D5
- 2526 D9
- 2527 D3
- 2528 D2
- 2529 D3
- 2530 D11
- 2531 E8
- 2532 E9
- 2533 E6
- 2534 E8
- 2535 F9
- 2536 C6
- 2537 B8
- 2538 B8
- 3500 B7
- 3501 B5
- 3502 B6
- 3503 B10
- 3505 B6
- 3506 B8
- 3507 C9
- 3508 C9
- 3510 C2
- 3511 C3
- 3512 C4
- 3513 C4
- 3514 C6
- 3515 C8
- 3517 C10
- 3518 D4
- 3519 C7
- 3521 C5
- 3522 C5
- 3523 C5
- 3524 C9
- 3525 C5
- 3526 C7
- 3530 D9
- 3534 D4
- 3535 D8
- 3539 D6
- 3542 D9
- 3543 D2
- 3544 D3
- 3545 D10
- 3546 D6
- 3547 D7
- 3548 D6
- 3549 D10
- 3551 E5
- 3552 E8
- 3553 E9
- 3554 E9
- 3555 E8
- 3556 E9
- 3557 C6
- 3558 C6
- 3559 B7
- 4001 B10
- 4002 E11
- 4003 C11
- 6500 C9
- 6501 C10
- 6502 D11
- 6503 E6
- 7500-A D8
- 7500-B B8
- 7501 C10
- 7503 C4
- 7506 C8
- 7508 C5
- 7510 C8
- 7511 C8
- 7512 D5
- 7513 D10
- 7515 E8
- F301 B11
- F305 C11
- F307 B7
- F309 C5

R...only for cord R/C
 S...only for non cord R/C
 X...component only provided(not in use)

AUDIO-PART

CIRCUIT DIAGRAM - CD PART

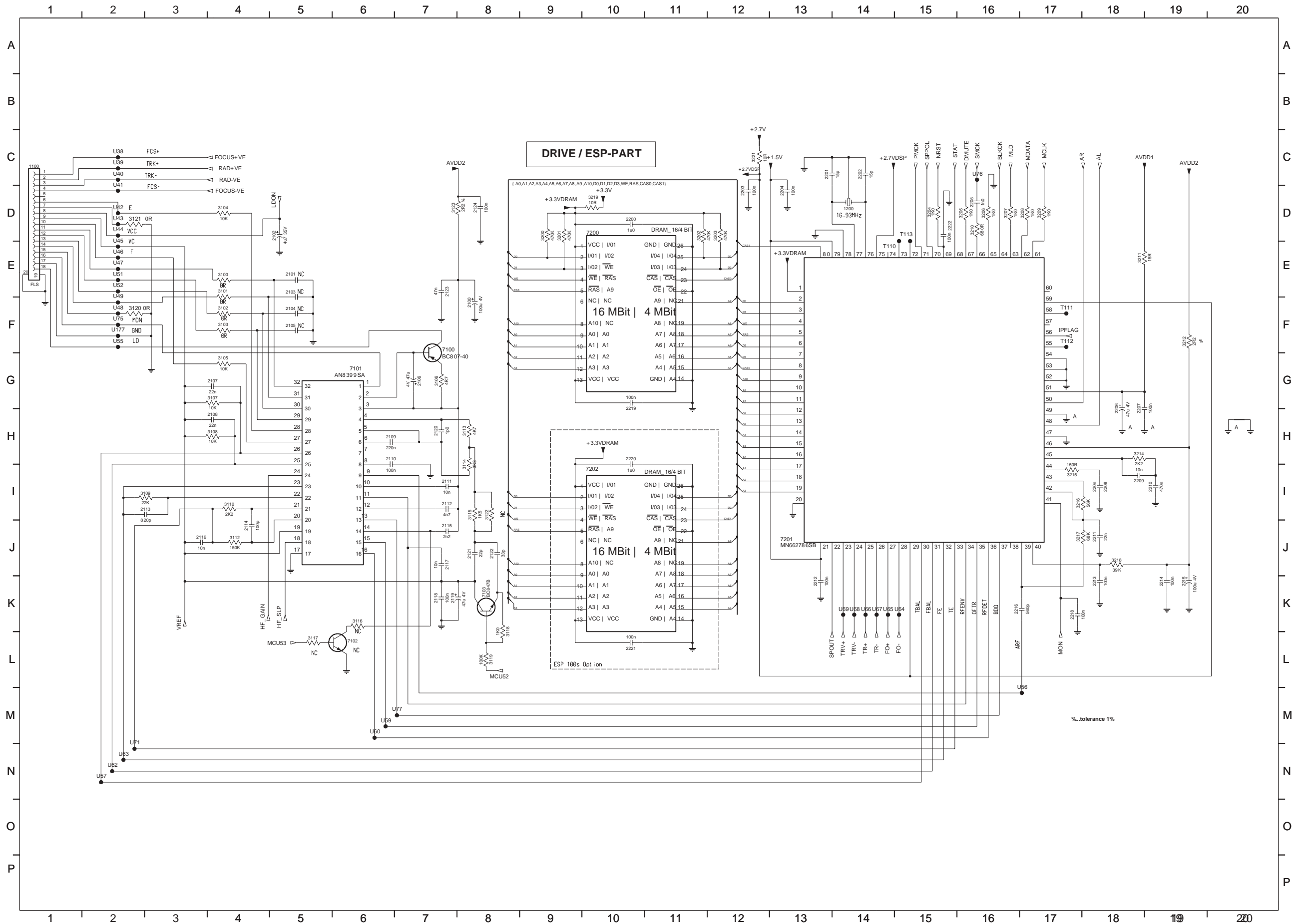

- U38 C2
- U39 C2
- U40 C2
- U41 C2
- U42 C2
- U43 C2
- U44 D2
- U45 D2
- U46 D2
- U47 D2
- U48 E2
- U49 D2
- U51 D2
- U52 D2
- U55 E2
- U56 I14
- U57 K2
- U59 J6
- U60 J6
- U62 J2
- U63 J2
- U64 H12
- U65 H12
- U66 H12
- U67 H12
- U68 H12
- U69 H12
- U71 J3
- U75 E2
- U76 C13
- U77 J6
- 1100 C1
- 1200 C12
- 2100 D7
- 2101 D5
- 2102 D4
- 2103 D5
- 2104 D5
- 2105 E5
- 2106 E6
- 2107 E4
- 2108 F4
- 2109 G6
- 2110 F6
- 2111 G7
- 2112 G7
- 2113 G3
- 2114 G4
- 2115 G7
- 2116 G3
- 2117 H7
- 2118 H6
- 2119 H7
- 2120 F6
- 2121 H7
- 2122 H7
- 2123 D7
- 2124 C7
- 2200 C9
- 2201 C11
- 2202 C12
- 2203 C10
- 2204 C11
- 2205 C13
- 2206 F15
- 2207 F15
- 2208 G15
- 2209 G15
- 2210 G16
- 2211 G15
- 2212 H11
- 2213 H15
- 2214 H16
- 2215 H16
- 2216 H14
- 2218 H15
- 2219 F9
- 2220 F9
- 2221 I9
- 2222 C13
- 3100 D4
- 3101 D4
- 3102 E4
- 3103 E4
- 3104 C4
- 3105 E4
- 3106 E6
- 3107 F4
- 3108 F4
- 3109 G3
- 3110 G4
- 3112 G4
- 3113 F7
- 3114 F7
- 3115 G7
- 3116 I5
- 3117 I5
- 3118 I7
- 3119 I7
- 3120 E3
- 3121 C3
- 3122 G7
- 3123 C7
- 3200 D8
- 3201 D8
- 3202 D10
- 3203 D10
- 3204 C13
- 3205 C13
- 3206 C13
- 3207 C14
- 3208 C14
- 3209 C14
- 3210 C13
- 3211 D15
- 3212 E16
- 3214 F15
- 3215 G15
- 3216 G15
- 3217 G15
- 3218 H15
- 3219 C8
- 3221 C10
- 7100 E6
- 7101 E5
- 7102 I5
- 7103 H7
- 7200 D8
- 7201 G11
- 7202 G8
- T110 D12
- T111 E14
- T112 E14
- T113 D12
- U177 E2

LAYOUT DIAGRAM - Component Side

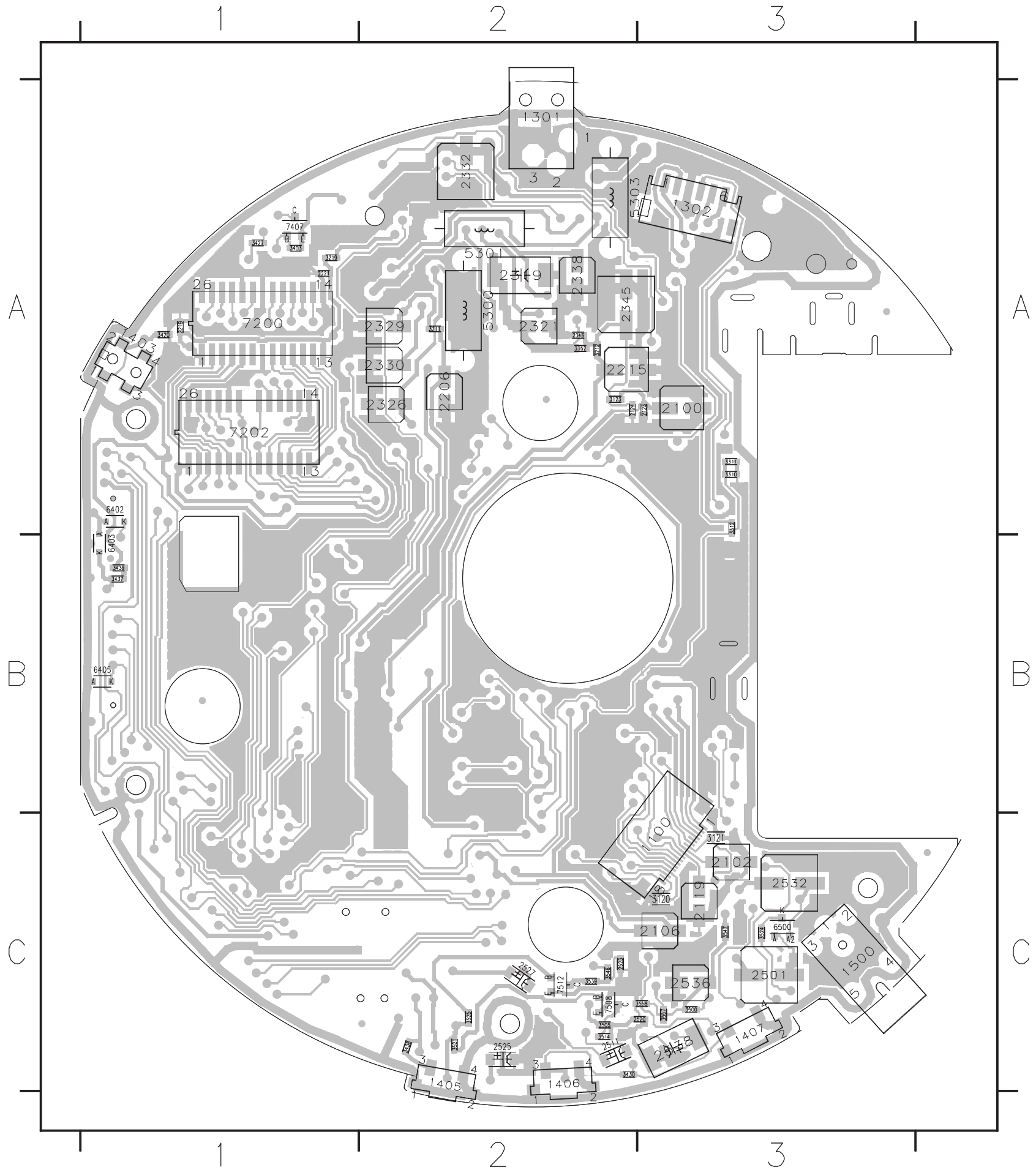

111	C3
113	A2
114	A3
116	A1
117	A3
118	C2
119	C3
120	C3
121	C3
122	A3
123	A3
124	A3
125	A3
126	A3
127	A3
128	A3
129	A3
130	A3
131	A3
132	A3
133	A3
134	A3
135	A3
136	A3
137	A3
138	A3
139	A3
140	A3
141	A3
142	A3
143	A3
144	A3
145	A3
146	A3
147	A3
148	A3
149	A3
150	A3
151	A3
152	A3
153	A3
154	A3
155	A3
156	A3
157	A3
158	A3
159	A3
160	A3
161	A3
162	A3
163	A3
164	A3
165	A3
166	A3
167	A3
168	A3
169	A3
170	A3
171	A3
172	A3
173	A3
174	A3
175	A3
176	A3
177	A3
178	A3
179	A3
180	A3
181	A3
182	A3
183	A3
184	A3
185	A3
186	A3
187	A3
188	A3
189	A3
190	A3
191	A3
192	A3
193	A3
194	A3
195	A3
196	A3
197	A3
198	A3
199	A3
200	A3
201	A3
202	A3
203	A3
204	A3
205	A3
206	A3
207	A3
208	A3
209	A3
210	A3
211	A3
212	A3
213	A3
214	A3
215	A3
216	A3
217	A3
218	A3
219	A3
220	A3
221	A3
222	A3
223	A3
224	A3
225	A3
226	A3
227	A3
228	A3
229	A3
230	A3
231	A3
232	A3
233	A3
234	A3
235	A3
236	A3
237	A3
238	A3
239	A3
240	A3
241	A3
242	A3
243	A3
244	A3
245	A3
246	A3
247	A3
248	A3
249	A3
250	A3
251	A3
252	A3
253	A3
254	A3
255	A3
256	A3
257	A3
258	A3
259	A3
260	A3
261	A3
262	A3
263	A3
264	A3
265	A3
266	A3
267	A3
268	A3
269	A3
270	A3
271	A3
272	A3
273	A3
274	A3
275	A3
276	A3
277	A3
278	A3
279	A3
280	A3
281	A3
282	A3
283	A3
284	A3
285	A3
286	A3
287	A3
288	A3
289	A3
290	A3
291	A3
292	A3
293	A3
294	A3
295	A3
296	A3
297	A3
298	A3
299	A3
300	A3

EXPLODED VIEW DIAGRAM

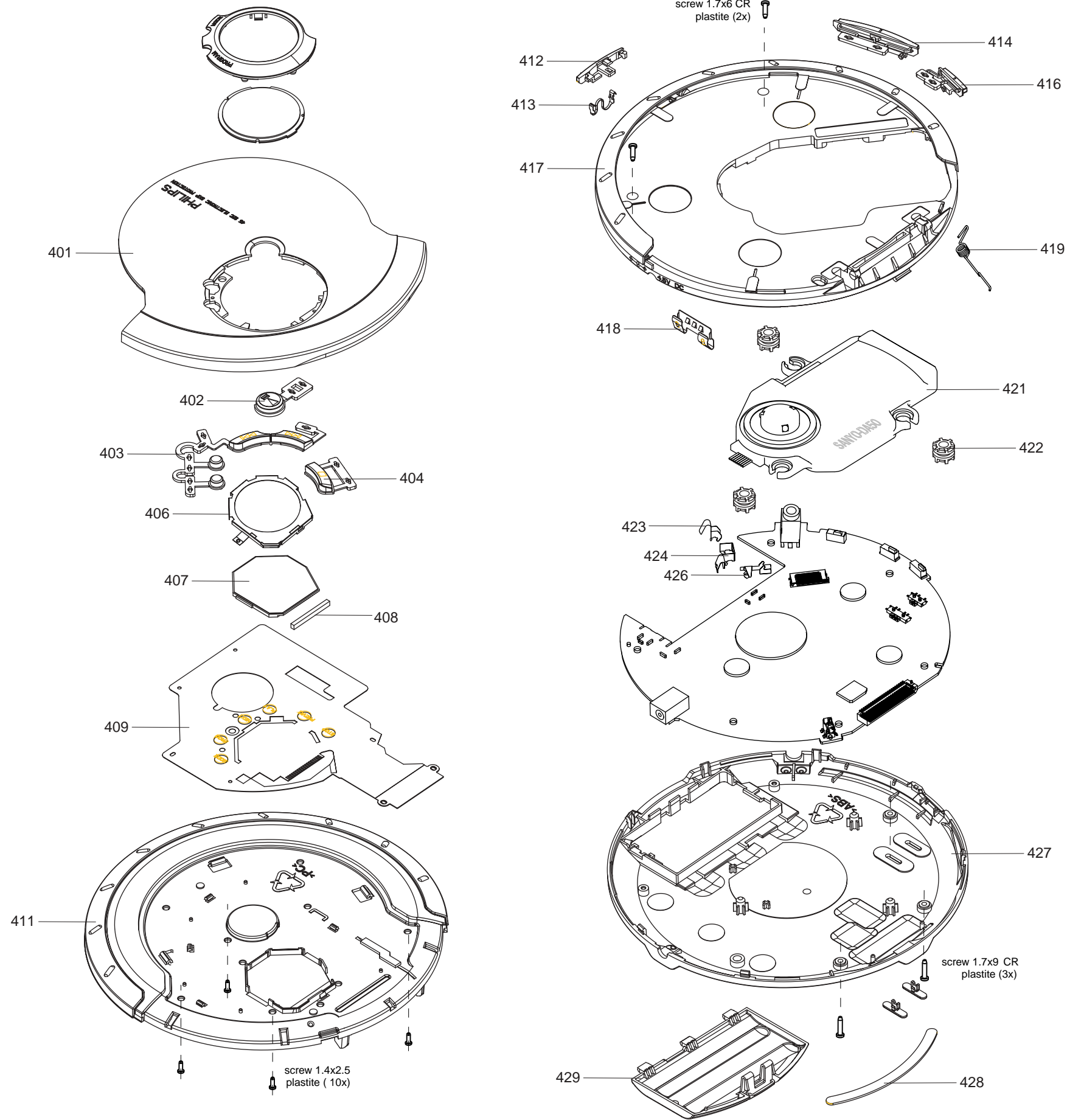

MECHANICAL PARTSLIST - CABINET

401	3140 117 67260	PANEL-ASSY-1 (red)
401	3140 117 64340	PANEL-ASSY-1 (grey)
401	3140 117 669 30	PANEL-ASSY-1 (blue)
402	3140 117 67310	KEY-PLAY
402	3140 117 669 80	KEY-PLAY (only for blue)
403	3140 117 64390	CD KEYSSET
404	3140 117 66480	CDKEY-STOP
406	3140 111 22560	FRAME-LCD
407	3140 110 51740	LCD
408	3140 11447480	ZEBRASTRIP
409	3140 11333150	MEMBRANE KEYBOARD
411	3140 117 67250	DOOR-CD-ASSY-1 (red)
411	3140 117 64330	DOOR-CD-ASSY-1 (grey)
411	3140 117 669 20	DOOR-CD-ASSY-1 (blue)
412	3140 117 669 90	SLIDER-DOOR-OPEN
412	3140 117 64410	SLIDER-DOOR-OPEN (only for grey)
413	3140 111 22610	SPRING-SLIDER-OPEN
414	3140 117 67000	KNOB-VOLUME
414	3140 117 64420	KNOB-VOLUME (only for grey)
416	3140 117 67010	KNOB-DBB
416	3140 117 64430	KNOB-DBB (only for grey)
417	3140 117 669 40	CABINET-ASSY-1
417	3140 117 64350	CABINET-ASSY-1 (only for grey)
418	3140 111 22620	SPRING-BATTERY-SET, +/-
419	3140 111 22640	SPRING-DOOR-OPEN
421	2422 549 45374	CD DRIVE DA50
422	3140 114 47580	DAMPER-AX5203
423	3140 111 22580	SPRING BATTERY, -VE
424	3140 111 22570	SPRING BATTERY, +VE
426	3140 111 22600	SPRING BATTERY CHARGE
427	3140 117 67350	BOTTOM-ASSY-1
427	3140 117 64360	BOTTOM-ASSY-1 (only for grey)
428	3140 11449 360	RUBBER-FOOT
429	3140 117669 10	DOOR-BATTERY-2A
429	3140 11766470	DOOR-BATTERY-2A (only for grey)

Note: Only these parts mentioned in the list are normal service parts.

ELECTRICAL PARTSLIST - COMBI BOARD**- MISCELLANEOUS -**

1100	2422 025 17486	SOCKET FFC 18P
1200	4822 242 81865	CST16,93MXW0C3-TF01
1301	2422 026 05086	CONNECTOR H 1P
1303	2422 086 11012	FUSE 0,7A 50V
1401	2422 127 00547	SWITCH-SLID 1P
1402	4822 265 11248	CONNECTOR 24P
1403	2422 129 16818	SWITCH-DET 1P
1404	2422 127 00543	SWITCH-SLID 1P
1405	2422 128 02968	SWITCH-TACT 1P
1406	2422 128 02968	SWITCH-TACT 1P
1407	2422 128 02968	SWITCH-TACT 1P
1500	2422 026 05401	SOCKET PHONE H 1P

- CAPACITORS -

2100	4822 124 12108	100µF 20% 4V
2102	3198 030 74780	4,7µF 20% 35V
2106	4822 124 81058	47µF 20% 4V
2107	4822 126 14494	22nF 10% X7R 25V
2108	4822 126 14494	22nF 10% X7R 25V
2109	4822 126 13879	220nF +80-20% 16V
2110	2238 586 59812	100nF +80-20% Y5V 50V
2111	5322 126 11583	10nF 10% X7R 50V
2112	4822 126 13193	4,7nF 10% X7R 63V
2113	3198 016 38210	820pF NP0 25V
2114	2020 552 94427	100pF 5% NP0 50V
2115	4822 126 14238	2,2nF X7R 50V
2116	5322 126 11583	10nF 10% X7R 50V
2117	5322 126 11583	10nF 10% X7R 50V
2118	2238 586 59812	100nF +80-20% Y5V 50V
2119	4822 124 81058	47µF 20% 4V
2121	4822 122 33761	22pF 5% NP0 50V
2122	2222 867 15339	33pF 5% NP0 50V
2123	3198 024 44730	47nF Y5V 50V
2124	2238 586 59812	100nF +80-20% Y5V 50V
2200	3198 017 41050	1µF Y5V 10V
2201	4822 122 33752	15pF 5% NP0 50V
2202	4822 122 33752	15pF 5% NP0 50V
2203	2238 586 59812	100nF +80-20% Y5V 50V
2204	2238 586 59812	100nF +80-20% Y5V 50V
2205	5322 126 11578	1nF 10% X7R 50V
2206	4822 124 81058	47µF 20% 4V
2207	2238 586 59812	100nF +80-20% Y5V 50V
2208	4822 126 13879	220nF +80-20% 16V
2209	5322 126 11583	10nF 10% X7R 50V
2210	3198 017 44740	470nF Y5V 10V
2211	4822 126 14494	22nF 10% X7R 25V
2212	2238 586 59812	100nF +80-20% Y5V 50V
2213	2238 586 59812	100nF +80-20% Y5V 50V
2214	2238 586 59812	100nF +80-20% Y5V 50V

- CAPACITORS -

2215	4822 124 12108	100µF 20% 4V
2216	4822 126 14249	560pF 10% X7R 50V
2218	2238 586 59812	100nF +80-20% Y5V 50V
2219	2238 586 59812	100nF +80-20% Y5V 50V
2220	3198 017 41050	1µF Y5V 10V
2221	2238 586 59812	100nF +80-20% Y5V 50V
2222	2238 586 59812	100nF +80-20% Y5V 50V
2319	2022 029 00632	330µF 20% 6,3V
2321	3198 030 74780	4,7µF 20% 35V
2326	4822 124 81058	47µF 20% 4V
2327	2238 586 59812	100nF +80-20% Y5V 50V
2328	5322 126 11583	10nF 10% X7R 50V
2329	4822 124 81058	47µF 20% 4V
2330	4822 124 23237	22µF 6,3V
2331	2238 586 59812	100nF +80-20% Y5V 50V
2332	4822 124 80151	47µF 16V
2333	3198 017 44740	470nF Y5V 10V
2334	4822 126 14315	390pF 5% NP0 50V
2335	2238 586 59812	100nF +80-20% Y5V 50V
2336	2238 586 59812	100nF +80-20% Y5V 50V
2337	3198 017 41050	1µF Y5V 10V
2338	4822 124 12084	1µF 20% 50V
2343	3198 017 41050	1µF Y5V 10V
2345	4822 124 81059	220µF 20% 4V
2346	2238 586 59812	100nF +80-20% Y5V 50V
2348	3198 017 41050	1µF Y5V 10V
2400	2238 586 59812	100nF +80-20% Y5V 50V
2401	5322 126 11578	1nF 10% X7R 50V
2402	2238 586 59812	100nF +80-20% Y5V 50V
2403	2238 586 59812	100nF +80-20% Y5V 50V
2405	2238 586 59812	100nF +80-20% Y5V 50V
2406	2238 586 59812	100nF +80-20% Y5V 50V
2407	2238 586 59812	100nF +80-20% Y5V 50V
2408	2238 586 59812	100nF +80-20% Y5V 50V
2411	5322 126 11583	10nF 10% X7R 50V
2500	4822 126 14241	330pF NP0 50V
2501	4822 124 81059	220µF 20% 4V
2502	4822 126 14491	2,2µF 10V
2503	2222 867 15339	33pF 5% NP0 50V
2511	3198 032 54110	4,7µF 20% 20V
2515	4822 126 14238	2,2nF X7R 50V
2516	4822 126 14247	1,5nF X7R 50V
2520	2238 586 59812	100nF +80-20% Y5V 50V
2522	4822 126 13883	220pF 5% 50V
2523	2238 586 59812	100nF +80-20% Y5V 50V
2524	4822 126 13883	220pF 5% 50V
2525	2020 004 90283	10µF 20% 10V
2526	3198 017 41050	1µF Y5V 10V
2527	3198 032 54110	4,7µF 20% 20V
2528	4822 126 14238	2,2nF X7R 50V

ELECTRICAL PARTSLIST - COMBI BOARD**- CAPACITORS -**

2529	4822 126 14247	1,5nF X7R 50V
2530	3198 017 41050	1µF Y5V 10V
2531	4822 126 14241	330pF NP0 50V
2532	4822 124 81059	220µF 20% 4V
2533	4822 126 14491	2,2µF 10V
2534	2222 867 15339	33pF 5% NP0 50V
2535	3198 017 41050	1µF Y5V 10V
2536	4822 124 81058	47µF 20% 4V
2537	2238 586 59812	100nF +80-20% Y5V 50V
2538	3198 032 28210	220µF 20% 6,3V

- RESISTORS -

3100	4822 051 30008	0R JUMPER
3101	4822 051 30008	0R JUMPER
3102	4822 051 30008	0R JUMPER
3103	4822 051 30008	0R JUMPER
3104	4822 051 30103	10K 5% 0,062W
3105	4822 051 30103	10K 5% 0,062W
3106	4822 117 13608	4,7R 5% 0,0016W
3107	4822 051 30103	10K 5% 0,062W
3108	4822 051 30103	10K 5% 0,062W
3109	4822 051 30223	22K 5% 0,062W
3110	4822 051 30222	2,2K 5% 0,062W
3112	4822 051 30154	150K 5% 0,062W
3113	4822 051 30472	4,7K 5% 0,062W
3114	4822 051 30332	3,3K 5% 0,062W
3115	4822 051 30152	1,5K 5% 0,062W
3118	4822 051 30102	1K 5% 0,062W
3119	4822 117 13632	100K 1% 0,62W
3120	4822 051 30008	0R JUMPER
3121	4822 051 30008	0R JUMPER
3123	2322 704 62208	2,2R 1%
3200	4822 051 30474	470K 5% 0,062W
3201	4822 051 30474	470K 5% 0,062W
3202	4822 051 30474	470K 5% 0,062W
3203	4822 051 30474	470K 5% 0,062W
3204	4822 051 30102	1K 5% 0,062W
3205	4822 051 30102	1K 5% 0,062W
3206	4822 051 30102	1K 5% 0,062W
3207	4822 051 30102	1K 5% 0,062W
3208	4822 051 30102	1K 5% 0,062W
3209	4822 051 30102	1K 5% 0,062W
3210	4822 051 30681	680R 5% 0,062W
3211	4822 117 12971	15R 5% 0,62W
3212	2322 704 62208	2,2R 1%
3214	4822 051 30222	2,2K 5% 0,062W
3215	4822 051 30151	150R 5% 0,062W

- RESISTORS -

3216	4822 051 30563	56K 5% 0,062W
3217	4822 051 30683	68K 5% 0,062W
3218	4822 051 30393	39K 5% 0,062W
3219	4822 051 30109	10R 5% 0,062W
3221	4822 051 30109	10R 5% 0,062W
3303	5322 117 13028	12K 1% 0,063W
3305	4822 117 12706	10K 1% 0,063W
3306	4822 051 30223	22K 5% 0,062W
3307	4822 117 13632	100K 1% 0,62W
3308	5322 117 13022	22K 1% 0,063W
3309	5322 117 13022	22K 1% 0,063W
3310	4822 051 30154	150K 5% 0,062W
3311	4822 051 30103	10K 5% 0,062W
3312	2122 551 00033	VDR 1MA/5V5 MAX 19V
3330	4822 117 13632	100K 1% 0,62W
3331	4822 051 30103	10K 5% 0,062W
3332	4822 051 30333	33K 5% 0,062W
3333	4822 117 12968	820R 5% 0,62W
3334	4822 117 12902	8,2K 1% 0,063W
3335	2322 702 70278	2,7R 5%
3336	2322 702 70278	2,7R 5%
3337	4822 117 12925	47K 1% 0,063W
3338	3198 021 32250	2,2M 5%
3339	4822 051 30474	470K 5% 0,062W
3340	4822 117 12925	47K 1% 0,063W
3341	4822 051 30474	470K 5% 0,062W
3342	4822 051 30474	470K 5% 0,062W
3345	4822 051 30392	3,9K 5% 0,063W
3346	4822 051 30223	22K 5% 0,062W
3352	2322 704 62208	2,2R 1% RC22H
3353	4822 051 30101	100R 5% 0,062W
3354	4822 051 30101	100R 5% 0,062W
3355	4822 051 30332	3,3K 5% 0,062W
3356	4822 051 30471	470R 5% 0,062W
3357	4822 051 30471	470R 5% 0,062W
3359	4822 117 12925	47K 1% 0,063W
3402	4822 051 30334	330K 5% 0,062W
3403	3198 021 32250	2,2M 5%
3404	4822 051 30103	10K 5% 0,062W
3405	4822 051 30474	470K 5% 0,062W
3406	4822 051 30334	330K 5% 0,062W
3407	4822 051 30105	1M 5% 0,062W
3408	4822 051 30105	1M 5% 0,062W
3409	3198 021 32250	2,2M 5%
3410	3198 021 32250	2,2M 5%
3411	4822 051 30102	1K 5% 0,062W
3412	4822 051 30102	1K 5% 0,062W
3413	4822 117 12891	220K 1%
3414	4822 117 12891	220K 1%
3415	4822 117 13632	100K 1% 0,62W

ELECTRICAL PARTSLIST - COMBI BOARD**- RESISTORS -**

3416	4822 117 13632	100K 1% 0,62W
3417	4822 117 12891	220K 1%
3418	4822 051 30682	6,8K 5% 0,062W
3419	4822 051 30682	6,8K 5% 0,062W
3420	4822 117 13632	100K 1% 0,62W
3421	4822 051 30682	6,8K 5% 0,062W
3423	4822 117 13632	100K 1% 0,62W
3424	4822 051 30008	OR JUMPER
3425	4822 051 30103	10K 5% 0,062W
3426	4822 051 30103	10K 5% 0,062W
3428	4822 051 30102	1K 5% 0,062W
3429	4822 117 12891	220K 1%
3430	4822 117 12925	47K 1% 0,063W
3431	4822 051 30223	22K 5% 0,062W
3432	4822 117 12925	47K 1% 0,063W
3433	4822 117 12891	220K 1%
3434	4822 051 30109	10R 5% 0,062W
3435	4822 051 30109	10R 5% 0,062W
3437	4822 051 30008	OR JUMPER
3438	4822 051 30472	4,7K 5% 0,062W
3439	4822 051 30008	OR JUMPER
3440	4822 051 30008	OR JUMPER
3500	4822 051 30472	4,7K 5% 0,062W
3501	4822 051 30123	12K 5% 0,062W
3502	3198 021 32250	2,2M 5%
3503	4822 117 12971	15R 5% 0,62W
3505	4822 051 30472	4,7K 5% 0,062W
3506	4822 051 30683	68K 5% 0,062W
3507	4822 051 30331	330R 5% 0,062W
3508	4822 051 30103	10K 5% 0,062W
3510	4822 051 30681	680R 5% 0,062W
3511	4822 051 30681	680R 5% 0,062W
3513	4822 051 30474	470K 5% 0,062W
3514	4822 117 12139	22R 5% 0,062W
3515	2322 702 60184	180K 5%
3517	4822 051 30331	330R 5% 0,062W
3518	4822 051 30474	470K 5% 0,062W
3519	4822 117 13632	100K 1% 0,62W
3521	4822 117 13632	100K 1% 0,62W
3522	4822 051 30103	10K 5% 0,062W
3524	4822 051 30102	1K 5% 0,062W
3525	4822 117 13632	100K 1% 0,62W
3526	4822 051 30183	18K 5% 0,062W
3530	4822 051 30102	1K 5% 0,062W
3534	4822 117 13632	100K 1% 0,62W
3535	4822 051 30682	6,8K 5% 0,062W
3539	4822 117 12139	22R 5% 0,062W
3542	4822 117 13632	100K 1% 0,62W
3543	4822 051 30681	680R 5% 0,062W
3544	4822 051 30681	680R 5% 0,062W

- RESISTORS -

3545	4822 051 30331	330R 5% 0,062W
3546	4822 051 30472	4,7K 5% 0,062W
3547	4822 051 30472	4,7K 5% 0,062W
3548	3198 021 32250	2,2M 5%
3549	4822 117 12971	15R 5% 0,62W
3551	4822 051 30123	12K 5% 0,062W
3552	4822 051 30683	68K 5% 0,062W
3553	4822 051 30331	330R 5% 0,062W
3554	4822 051 30103	10K 5% 0,062W
3555	2322 702 60184	180K 5%
3556	4822 117 13632	100K 1% 0,62W
3557	4822 117 13632	100K 1% 0,62W
3558	4822 117 13632	100K 1% 0,62W
3559	4822 051 30109	10R 5% 0,062W
4001	4822 051 30008	OR JUMPER
4002	4822 051 30008	OR JUMPER

- COILS & FILTERS -

5300	4822 158 10525	LAL 04T 331K
5301	4822 157 50964	100M μ H
5303	4822 158 10525	LAL 04T 331K

- DIODES -

6302	9322 128 70685	DIO REC SM SS14 (GI00) R
6304	4822 130 11416	PDZ6,8B
6401	4822 130 11397	BAS316
6402	4822 130 11416	PDZ6,8B
6403	4822 130 11416	PDZ6,8B
6404	4822 130 11416	PDZ6,8B
6405	4822 130 11416	PDZ6,8B
6406	4822 130 11416	PDZ6,8B
6407	4822 130 11416	PDZ6,8B
6500	5322 130 34331	BAV70
6501	4822 130 11397	BAS316
6502	4822 130 11551	UDZS10B
6503	5322 130 34331	BAV70

- IC & TRANSISTORS -

7100	5322 130 60123	BC807-40
7101	9322 182 66671	AN8399SA
7103	5322 130 60159	BC846B
7200	9322 175 89668	MSM51V17405F-60SJ
7201	9322 182 62671	MN662786SB
7202	9322 175 89668	MSM51V17405F-60SJ
7300	9322 186 76671	AN41502
7301	5322 130 61569	BC868
7303	4822 130 42615	BC817-40
7304	4822 130 60142	BC869

ELECTRICAL PARTSLIST - COMBI BOARD**- IC & TRANSISTORS -**

7306	4822 130 60373	BC856B
7307	5322 130 60159	BC846B
7309	5322 130 60123	BC807-40
7310	5322 130 60159	BC846B
7311	4822 130 60142	BC869
7312	5322 130 60159	BC846B
7313	5322 130 60159	BC846B
7401	5322 130 60159	BC846B
7402	5322 130 60159	BC846B
7403	4822 130 60373	BC856B
7404	5322 130 60159	BC846B
7405	3140 110 51730	MCU MN101C39C
7406	4822 130 60373	BC856B
7407	4822 130 60373	BC856B
7500	4822 209 33165	TDA1308T/N1
7501	4822 130 42615	BC817-40
7503	4822 130 60373	BC856B
7506	5322 130 60123	BC807-40
7508	4822 130 42615	BC817-40
7510	5322 130 60159	BC846B
7511	5322 130 60159	BC846B
7512	4822 130 42615	BC817-40
7513	4822 130 42615	BC817-40
7515	5322 130 60159	BC846B

Note: Only these parts mentioned in the list are normal service parts.