

Service
Service
Service



Service Manual

TABLE OF CONTENTS

Technical specification 1-1
 Features 1-1
 Accessories 1-1

Instruction For Use 1-2.. 1-8
 Safety & Warnings 1-9

Service hints
 Repair positions 2-1
 Dismantling CD-door 2-1
 Handling chip components 2-2
 Service tools 2-2

Blockdiagram 3-1



COMBI BOARD

Circuit diagrams

Part 1 4-1
 Part 2 4-2
 Part 3 4-3

Layout diagrams

Component side view 4-4
 Copper side view 4-5

Exploded view 5-1
 Mechanical partslist 5-1

Electrical partslist 6-1



© Copyright 2001 Philips Consumer Electronics B.V. Eindhoven, The Netherlands
 All rights reserved. No part of this publication may be reproduced, stored in a retrieval system or transmitted, in any form or by any means, electronic, mechanical, photocopying, or otherwise without the prior permission of Philips.

Published by LX 0348 Service Audio Printed in The Netherlands Subject to modification

GB 3140 785 32870



TECHNICAL SPECIFICATION

General

Dimensions (W x H x D) : 128 x 30 x 137.5mm
 Weight without batteries : 220g

Shock resistance

+X/-X direction : $\geq 5g$
 +Y/-Y direction : $\geq 5g$
 +Z/-Z direction : $\geq 5g$

Power supply modes

SUPPLY MODE	Voltage range
	CD/MP3/VCD
DC-IN socket	3.5 - 6.0V
Primary batteries	2.2 - 3.0V

Battery lifetime

BATTERY TYPE	CD ESP=on	VCD ESP=on	MP3 ESP=on
Alkaline batteries (2x AA)	≥ 2.8 h (3h typ.)	≥ 7 h (8h typ.)	≥ 8 h (9h typ.)

Battery level detection

DETECTION LEVEL	Primary batteries
Battery empty	2.2V +100/-50mV
Difference btw.level 1 and battery empty	0.3V \pm 100mV
Difference btw.level 2 and battery empty	0.6V \pm 100mV
Difference btw.level 3 and battery empty	0.9V \pm 100mV

Current consumption

OPERATION MODE	DC-IN SUPPLY (4.5V)					BATT. SUPPLY (2.25V)				
	CD ESP=on	CD ESP=off	MP3 ESP=on	VCD ESP=on	VCD ESP=off	CD ESP=on	CD ESP=off	MP3 ESP=on	VCD ESP=on	VCD ESP=off
Play	210mA	200mA	200mA	400mA	370mA	270mA	240mA	260mA	450mA	440mA
Jump	<500mA	n/a	n/a	<650mA	n/a	<500mA	n/a	n/a	<650mA	n/a

Headphone out

Output power (THD=10%) : 7mW (-1dB)
 Frequency response (1mW) : 100Hz-20kHz within 6dB
 S/N ratio CD (unwght) : 78dB (81dB typ.)
 S/N ratio CD (unw.),incl.muting : 85dB
 S/N ratio CD (A-wght) : ≥ 82 dB (84dB typ.)
 S/N ratio CD (A-wght),incl.muting : 85dB
 THD+N (1kHz, 1mW) : 1.0% (0.2% typ.)
 Crosstalk (1kHz) : ≤ -24 dB (-44dB typ.)
 Channel unbalance (-40dB) : 4dB
 Volume attenuation (1kHz) : >60dB

Dynamic Bass Boost DBB

DBB STAGE	Frequency response		
	100 Hz	1 kHz	10 kHz
DBB 1	+6dB \pm 2dB	+0dB \pm 2dB	+0dB \pm 2dB

Measurement setup CD

Use Audio Signal disc SBC429

4822 397 30184

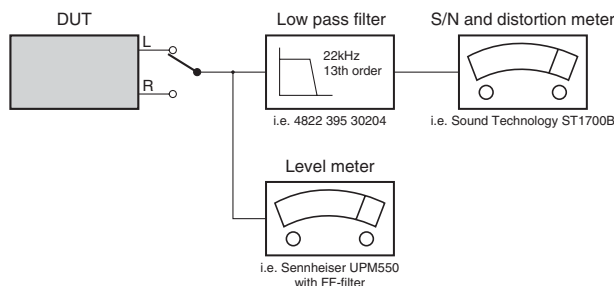

FEATURES

FEATURES OF CD-PORTABLE/MP3	AX6301 (all versions)
TUNER FM / MW	- / -
CD-REWRITABLE COMPATIBILITY	●
ELECTRONIC SKIP PROTECTION CDDA / MP3/VCD	120s / 400s / 30s
ESP DRAM SIZE	16 Mbit
HOLD / RESUME FUNCTION	● / ●
DBB STAGES	1
ACOUSTIC FEEDBACK	-
PROGRAM MEMORY	20
RECHARGE FUNCTION NiCd / NiMH	- / ●
CORD REMOTE CONTROL PREPARED	●

ACCESSORIES

ACCESSORIES FOR CD/VCD PORTABLE	AX6301
	/01
AY 3193/02 AC/DC Adaptor 9965 000 22594	X
SBC HE035/77s Stereo Headphone 9965 000 11492	X
AY3788 Remote Control 9965 000 22593	X
AV Cinch Cable 9965 000 22595	X

INSTRUCTION FOR USE

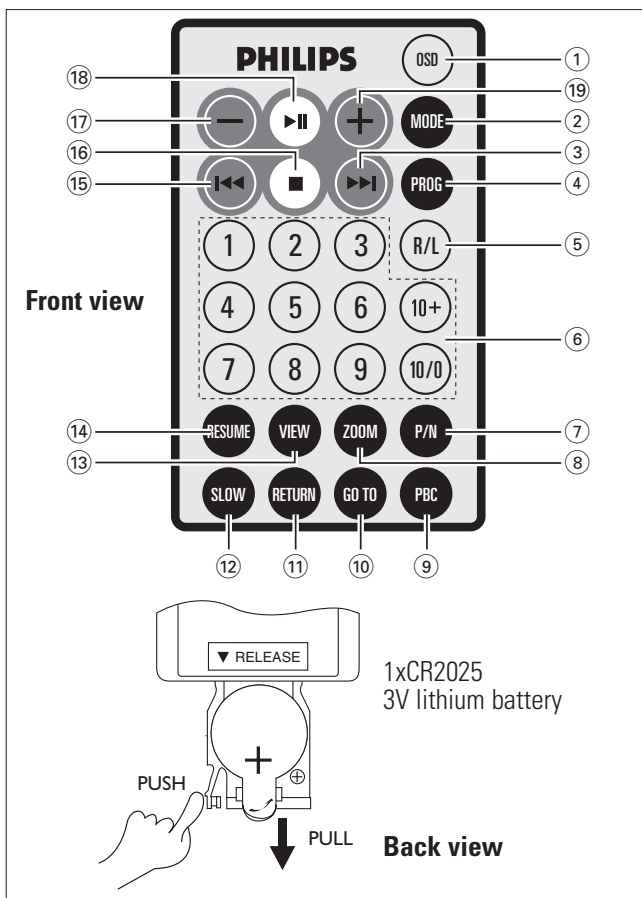
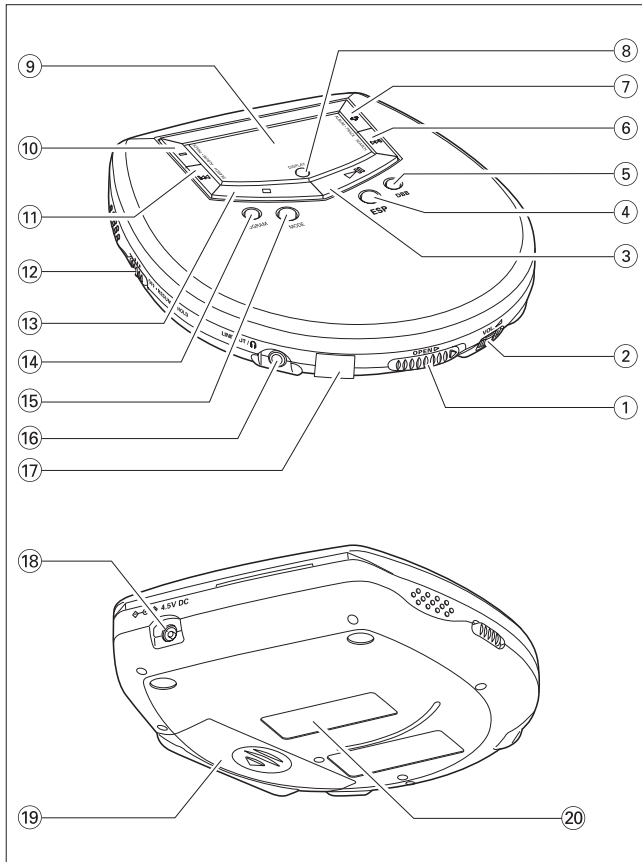

English

CONTROLS

Controls

- 1 **OPEN** ▶ to open the VCD MP3 CD lid
- 2 **VOL** ▲ to adjust the volume
- 3 **▶||** to switch the player on, start playback and interrupt playback
- 4 **ESP** to switch on /off ESP function
- 5 **DBB** to select bass enhancement
- 6 **▶▶** to skip forward and search forward for CD and MP3-CD
..... to skip forward for VCD
- 7 **+** to select the desired album up for MP3-CD playback
..... to fast forward during VCD playback
- 8 **DISPLAY** (for CD and VCD) to display the current track number and remaining / elapsed playing time. (for MP3-CD) to display the current album number, track number, remaining/elapsed playing time.
- 9 Display
- 10 - to select the desired album down for MP3-CD playback
..... to fast rewind during VCD playback
- 11 **◀◀** to skip backward and search backward for CD and MP3-CD
..... to skip backward for VCD
- 12 **OFF · RESUME · HOLD**
 - **OFF** switches RESUME and HOLD off
 - **RESUME** stores and starts at the last position played
 - **HOLD** locks all buttons on the set except the volume control slider
- 13 **■ (STOP)** to stop playback, clear a program and switch the set off
- 14 **PROGRAM** to program tracks
- 15 **MODE** to select playback options - **REPEAT 1, REPEAT ALL, SCAN** and **SHUFFLE**
- 16 **LINE OUT** / to connect
- headphones
- the set to the audio/video input of your stereo equipment
- 17 infrared sensor for the remote control
- 18 4.5V DC to connect the mains adapter

- 19 Battery compartment
- 20 Type plate

Remote Control

- 1 **OSD** (for CD and VCD) to display the current track number and remaining / elapsed playing time. (for MP3-CD) to display the current album number, track number, remaining/elapsed playing time.
- 2 **MODE** to select the playback options: **REPEAT 1, REPEAT ALL, SCAN** and **SHUFFLE**
- 3 **▶▶** to skip forward for CD, VCD and MP3-CD
- 4 **PROG** for CD/VCD/MP3-CD, to program disc tracks
- 5 **R/L** to toggle between left/right channels and stereo
- 6 **Number buttons** to select your desired tracks
- 7 **P/N** to toggle between PAL and NTSC
- 8 **ZOOM** to view pictures in an enlarged mode
- 9 **PBC** to toggle between MENU Play and SEQUENCE PLAY
- 10 **GO TO** to set the time from which playback starts
- 11 **RETURN** to return to MENU PLAY from SEQUENCE PLAY
- 12 **SLOW** to view VCDs at a slower speed
- 13 **VIEW** to scan VCD segments
- 14 **RESUME** to resume playback in stop mode
- 15 **◀◀** to skip backward for CD, VCD and MP3-CD
- 16 **■ (STOP)** to stop playback or clear a program
- 17 - to select the desired album down for MP3-CD playback
..... to fast rewind during VCD playback
- 18 **▶||** to start /pause playback / return to normal playback
- 19 **+** to select the desired album up for MP3-CD playback
..... to fast forward during VCD playback

INSTRUCTION FOR USE

POWER SUPPLY/GENERAL INFORMATION

Batteries (not included)

Inserting batteries

- Open the battery compartment and insert 2 alkaline batteries of type **AA (LR6, UM3)**.
- When using the remote control for the first time, please remove the clear protective tab from the battery.
- Do not mix old and new or different types of batteries.

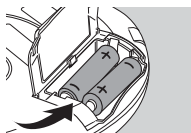

Indication of empty batteries

- Replace the batteries or connect the mains adapter as soon as  blinks.
- Remove batteries if they are empty or the set will not be used for a long time.

Average playing time of batteries under normal conditions

Alkaline battery	ESP on	ESP off
VCD	3 hours	3.5 hours
CD	7 hours	7.5 hours
MP3-CD	9.5 hours	

Batteries contain chemical substances, so they should be disposed of properly.

Mains adapter (supplied AY3193)

Use only the AY3193 adapter (DC: 4.5V/800mA; AC: 110V/220V and 50/60Hz). Any other product may damage the player.

- 1 Make sure the mains voltage matches the voltage requirement of the mains adapter.
- 2 Connect the mains adapter to the 4.5V DC socket of the player and to the wall socket.

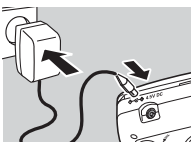
 **TIP:**

- Always disconnect the adapter when you are not using it.
- Once the mains adapter is connected, the power supply from batteries will be switched off automatically.

TV connection

Connecting to your TV System

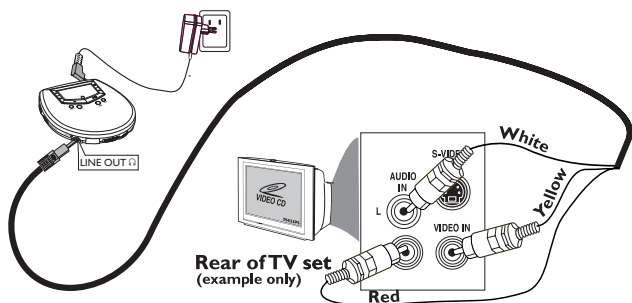

Use the supplied AV cable to connect the player to your TV system. To ensure uninterrupted viewing, we recommend you use AC mains power for your player during VCD operation.

- 1 Insert the yellow video cable pin into the VIDEO IN jack on the rear of your TV. Insert the white and red audio cable pins respectively into the left and right AUDIO IN jacks of your TV.
- 2 Insert the pin on the other end of the AV cable into the LINE OUT jack on your player.
- 3 Connect the mains adapter to the 4.5V DC socket of the player and to the wall socket.

PLAYBACK



Playing a disc

With this set, you can play

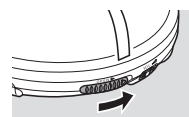
- Video discs
- audio discs (pre-recorded audio CDs, finalized audio CDs and CD-RWs)
- MP3-CDs (CD-ROMs with MP3 files)



For VCD playback, you need to connect the player to your TV (see Connecting to your TV system)

- 1 Push the OPEN  slider to open the disc lid.
- 2 Insert a disc, printed side up, by pressing the CD onto the hub. Close the lid by pressing the lid down.
- 3 Press  on the set to start playback.

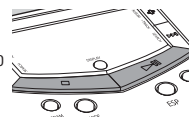

Playback starts.

Video disc:  appears. The current track number and the elapsed time are displayed.



Audio disc: The current track number and the elapsed playing time are displayed.

MP3-CD: MP3 appears. The current album number, track number and the elapsed playing time are displayed.



- 4 To stop playback, press .
- Video disc:** The number of tracks and the total playing time of the disc are displayed.
- Audio disc:** The number of tracks and the total playing time of the disc are displayed.
- MP3-CD:** The number of albums and the number of tracks are displayed.

Playing a disc

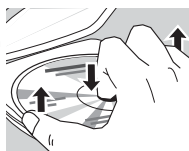

- 5 Press  again to switch off the player.

- To remove the disc, hold it by its edge and press the hub gently while lifting the disc.

 **TIP:**

- You can only press  on the set to start playback.
- if there is no activity, the player will automatically switch off in 30 seconds to save energy.
- After pressing , you may need to wait for 10 seconds or more until the first MP3 track is played.

Pause

- 1 Press  to interrupt playback.
The track number and the elapsed playing time are displayed.
- 2 Press  again to resume playback

 **TIP:**

- If the set stays in the PAUSE mode for more than 90 seconds, it will enter the STOP mode automatically. After 30 seconds or more in the STOP mode, your set automatically powers down.

INSTRUCTION FOR USE

FEATURES

Special features for VCD playback only

Adjusting your TV System

Before viewing the Video CD, ensure that the set is switched to the corresponding PAL or NTSC system of your TV set (except multi-system TV).

- 1 Connect the audio/video output cable to the corresponding ports of the TV set.
- 2 Turn on your TV system and adjust the input mode to AV
- 3 On the remote control, press P/N to toggle between PAL and NTSC TV systems.

OSD - On Screen Display

If you insert a VCD, your TV screen will serve as an additional display for messages (e.g. PLAY, STOP) and information stored in the VCD.

- Press **OSD** on the remote control or **DISPLAY** on the set repeatedly to switch OSD on or off. When OSD is switched on, your TV screen may for example display the following **XX-MM:SS** - where:
 - "XX" is the current track
 - "MM" is for minute.
 - "SS" is for second.



DISPLAY features for VCD, CD and MP3-CD

- During normal playback, you can press **OSD** on the remote control or **DISPLAY** on the set repeatedly to select your desired display.

Press OSD or DISPLAY	Display
1x	Track number + track's remaining playing time
2x	Normal display

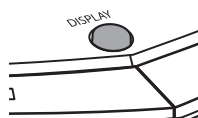

FEATURES

Return

If you want to return to MENU PLAY (the main menu at the beginning of your VCD) during SEQUENCE PLAY, press **RETURN**.



Go to

- 1 Press **GO TO** on the remote control. **GO TO--:--** appears on the TV screen. Enter the desired time from which you want to start playback.
- 2 Press **GO TO** again to deactivate **GO TO**. **GO TO CANCEL** appears.



View

This feature allows you to scan through your VCD in 9 segments.

- 1 Press **VIEW** to divide the whole movie of the video into 9 segments. The 7-second of each segment is played. After the last segment, playback starts from the first segment.
- 2 Select your desired segment using the number buttons on the remote control. Playback continues from the selected segment.
- 3 Press **VIEW** again or **▶II** to resume normal playback.



Zoom

- 1 Press **ZOOM** on the remote control once to enlarge the picture by 2 times. **ZOOM 2"** appears.
- 2 Press **ZOOM** again to quit the zoom feature. **RESTORE** appears and normal playback resumes.



Slow

Select from 4 speeds to capture action in slow motion: 1/2, 1/4, 1/8, and 1/16.

- 1 Press **SLOW** on the remote control once or more for playback at slow speed. Sound is muted and **SLOW1/2**, **SLOW1/4**, **SLOW1/8** or **SLOW1/16** is displayed.
- 2 To resume normal playback, press **▶II**.



Playing a VCD V2.0 with PBC

PBC is a predefined play sequence stored in the CD. **SEQUENCE PLAY** is by default on when VCD playback starts.

Before viewing your VCD, make sure the set is switched to the corresponding PAL or NTSC system of your TV set (except multi-system TVs).

- 1 Press **P/N** repeatedly to select PAL or NTSC.  is displayed when you load a VCD with PBC (Playback Control) into your player.
- 2 You can press **PBC** to toggle between MENU PLAY and SEQUENCE PLAY.



If SEQUENCE PLAY is selected, the playback starts from the beginning of the first track. If MENU PLAY is selected, a list of tracks is displayed on the TV screen.



TIP: This function is not available for discs without Table Of Contents.

INSTRUCTION FOR USE

GENERAL INFORMATION

Maintenance

- Do not touch the lens (A) of the player.
- Do not expose the unit, batteries or discs to humidity, rain, sand or excessive heat (caused by heating equipment, or direct sunshine).
- You can clean the player with soft, slightly dampened and lint-free cloth. Do not use any cleaning agents, as they may be corrosive.
- To clean the CD, wipe it in a straight line from the center toward the edge using soft, lint-free cloth.
- Never write on a disc or attach a sticker to it.
- Discs and lens may cloud over when the unit is moved suddenly from cold to warm surroundings. Leave the player in a warm environment until the moisture has evaporated.
- Active mobile phones in the vicinity may cause malfunctions.
- Avoid dropping the unit as this may cause damage.

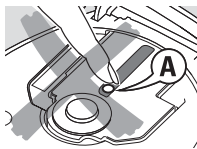

Environmental information

- We have done our best to make the packaging easily separable into mono materials. Cardboard (box) and polyethylene (bags, protective foam sheet).
- Your set consists of materials which can be recycled if disassembled by a specialized company. Please observe the local regulations regarding the disposal of packing material, exhausted batteries and old equipment.

Accessories

Headphones, HE035
 Mains adapter, AY3193
 Wireless remote control, AY3788
 AV cable, AY3484

Headphones (HE035)

- Connect the supplied headphones to LINE OUT/🔊.



TIP:

LINE OUT/🔊 can also be used to connect this set to your HiFi or TV system.

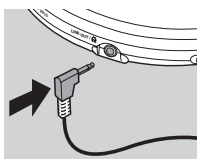

Take care when using headphones

Hearing safety

Do not play your headphones at a high volume. Hearing experts advise that continuous use at high volume can permanently damage your hearing.

Traffic safety

Do not use your headphones while driving a vehicle. It may create a hazard and it is illegal in many countries.

GENERAL INFORMATION

General MP3 information

How to get music files

The music compression technology MP3 (MPEG Audio Layer 3) reduces the digital data of an audio CD significantly while maintaining CD-like sound quality. With MP3 you can record up to 10 hours of CD-like music on a single CD-RW.

How to organize music files

Either download legal music files from the Internet to your computer hard disc or create them from your own audio CDs. For this, insert an audio CD into your computer's CD-ROM drive and convert the music using appropriate encoder software. To achieve good sound quality, a bit rate of 128 kbps or higher is recommended for MP3 music files.

How to make a CD-ROM with MP3 files

In order to easily handle the large number of music files on a CD-ROM, you can organize them in folders ("albums").

The tracks of an album will be played in alphabetical order. If you want to arrange them in a certain order, let the file names start with numbers.

For example:

001-E-WORLD.MP3

002-FIRESTARTER.MP3

003-DEEP.MP3

Albums will be arranged in alphabetical order, but subfolders (albums within another album) will be played immediately after the album in which they are located. Albums without MP3 files will be skipped.

If there are MP3 files which you did not put into an album, you will find them in the album *VARIOUS* with album number 0. *VARIOUS* is the first album that will be played.

General MP3 information

How to make a CD-ROM with MP3 files

Use your computer's CD burner to record ("burn") music files from your hard disc on a CD-ROM. Use ISO9660 disc format.

Make sure that the file names of the MP3 files end with .mp3

Note: Data compression in UDF is not supported.

Supported formats

This set supports:

- Video CD V1.0, Video CD V2.0
- DVCD
- ISO-9660, ISO-9660+Joliet, Joliet, Packet writing
- MP3 bit rate: 32-320 kbps and variable bit rate (VBR)
- Maximum number of tracks per disc: 400
- Maximum number of albums per disc: 99



TIP:

- When the system reads a mixed mode MP3-CD, only the number of total CDDA tracks is displayed.

INSTRUCTION FOR USE

GENERAL INFORMATION/FEATURE

Volume and sound

Volume adjustment

- Adjust the volume by using the volume control VOL .

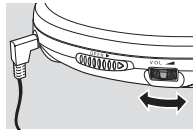

Sound adjustment

- Press **DBB** for a moderate bass enhancement. **DBB** appears.

Press **DBB** again to switch off the bass enhancement.

DBB disappears.

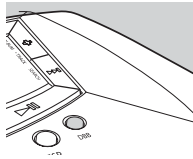

R/L : Channel and stereo sound selection

It is possible to select the right channel or left channel or stereo from a multi-channel disc when you connect your player to your TV or Hi-Fi system.

- For VCDs**, make sure you connect the player correctly to your TV system first.
- For music discs**, make sure you connect the player to your Hi-Fi system first.
- On the remote, press **R/L** once or more to select your sound output option.



Selecting tracks using the number digits

- Press number buttons **0-9** on the remote control to select your desired track.
- If more than 10 tracks are stored in a disc, you can use **10+**:*
- Press **10+** first, and then the last number.
- Press **10+** once for 10+, twice for 20+, and three times for 30+, and so on.

Searching VCDs at different fast / slow speeds during playback

- Press **+** once or several times to select your desired forwarding speed:

Press	Times of normal speed
1x	FORWARD x1
2x	FORWARD x2
3x	FORWARD x3
4x	FORWARD x4
5x	Normal Play



- Press **-** once or several times to select your desired rewinding speed:

Press	Times of normal speed
1x	BACKWARD x1
2x	BACKWARD x2
3x	BACKWARD x3
4x	BACKWARD x4
5x	Normal Play



FEATURES

Selecting and searching on all discs

Selecting a track during playback

- Briefly press **◀** or **▶** once or several times to skip to the beginning of the previous or subsequent track. Playback continues with the selected track.

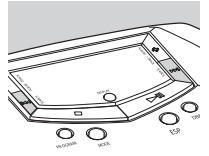

Search for a passage during CD playback

- Keep **◀** or **▶** pressed to find a particular passage in a backward or forward direction. Searching is started.
- Release the button at the desired passage. Normal playback continues.

Selecting albums and tracks on MP3-CDs

Selecting an album during playback

- Briefly press **-** or **+** once or several times to skip to the first track of the current, previous or subsequent album. Playback starts from the first track of the selected album.

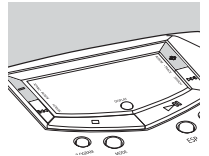

Selecting a track during playback

- Briefly press **◀** or **▶** once or several times to select previous or subsequent tracks within the current album.
- Release the button at the desired track. Playback continues with the selected track.

Playing tracks repeatedly or in a random order - MODE

Press **MODE** once or several times to select the desired playback possibility.

- REPEAT 1:** The current track is played repeatedly.
- REPEAT ALL:** The entire disc is played repeatedly. But for MP3-CDs, only all the tracks in the current album are played repeatedly.
- SHUFFLE:** All tracks are played in a random order.
- SCAN :** The first 10 seconds of each track is played in sequence.

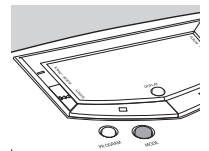

INSTRUCTION FOR USE

FEATURES

RESUME and HOLD

You can interrupt playback and continue (after a short while at the stop position only) from the position where playback has stopped (RESUME). You can also lock all buttons of the set so that no action will be executed (HOLD). Use the OFF – RESUME – HOLD slider for these functions.

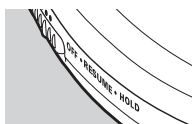

RESUME – continuing from where you have stopped

- 1 Switch the slider to RESUME during playback to activate RESUME.
→ RESUME is shown.

- 2 Press ■.

- 3 Press ►► on the set or press ►► or RESUME on the remote control to resume playback.
→ RESUME is shown and playback continues from where you have stopped.



- To deactivate RESUME, switch the slider to OFF.
→ RESUME goes off.



TIP:

– Resume is also cancelled if you have opened the disc lid or disconnected your player from the power supply.

HOLD - locking all buttons

- Switch the slider to HOLD to activate HOLD.
HOLD appears and all buttons are locked.
When any key is pressed, HOLD is displayed.
- To deactivate HOLD, switch the slider to OFF.
HOLD disappears.



ESP - Electronic Skip Protection

The ESP duration is 120 seconds for CD playback,
400 seconds for MP3 disc playback and
30 seconds for VCD playback.

The **ELECTRONIC SKIP PROTECTION** system prevents sound loss or unstable playback caused by light vibrations and shocks. Continuous playback is thus ensured. **ESP does not prevent playback interruptions during vigorous running. It does not protect the unit against any damage caused by dropping!**

Press **ESP** repeatedly during playback to toggle between ESP ON and ESP OFF.

- When **ESP** appears, ESP is activated.
- When **ESP** disappears, ESP is deactivated



FEATURES

Programming track numbers

You can select up to 20 tracks and store them in the memory in a desired sequence. You can store any track more than once.

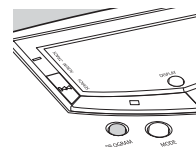

- 1 In the stop mode, press **PROGRAM** on the set or **PROG** on the remote control.
PROGRAM appears and P with the number of stored tracks is displayed.
- 2 Select a track with ◀◀ or ▶▶.
- 3 Press **PROGRAM** on the set or **PROG** on the remote control to store the track.
- 4 Select and store all desired tracks in this way.
- 5 Press ►► to start playback of the program
Playback starts.



TIP:

– **P-FULL** appears when the program memory is full.

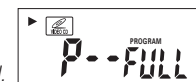

Clearing the program

You can clear the program by

- pressing ■ again in the stop mode;
- powering off the player;
- opening the disc lid;
- pressing and holding **PROGRAM** during playback
- pressing PROG on the remote control during playback.



TIP:

– **P-CLEAR** appears on the display of the player for VCD, CD and MP3-CD.
– PROGRAM CANCEL appears on the TV screen for VCD.

INSTRUCTION FOR USE

TROUBLESHOOTING

WARNING: Under no circumstances should you try to repair the set yourself as this will invalidate the guarantee.

If a fault occurs, first check the points listed below before taking the set for repair. If you are unable to solve a problem by following these hints, consult your dealer or service centre.

Problems

No sound/power

- Check if the player is connected securely.
- Check volume on the player.
- Disconnect headphones when not using headphones.
- Make sure you operate the TV or amplifier correctly.
- Make sure you have selected VCD player position on the amplifier.
- The power circuit in your player is designed with a power shutdown mode. This is activated only during battery power operation of the player when the battery becomes completely drained. When this happens:
 - 1 Connect your player to AC power with the supplied mains adapter.
 - 2 Let the player stand idle for 30 seconds **before** switching on again to resume disc operation on AC power supply.

Loud noise when operating the player

- This is normal and due to mechanical parts. Playback is not affected.

The player feels very warm

- When the player is in use for a long period of time, the surface will be heated. This is normal.

No picture / No color on TV screen

- Connect the cable between the systems and the TV.
- Change the system to the respective PAL or NTSC setting.

My disc cannot play

- Check you have loaded a disc in the player if empty.
- Check you have loaded a disc properly with the label side up.
- Disc dirty/damaged. Clean the disc properly.
- Moisture has condensed in the player.
Remove the disc and leave the player to adjust to the surrounding temperature. Some audio CDs available on the market are copy protected. These discs will not play on this set. See your retailer for options regarding non-protected audio CDs.
- Make sure the MP3-CD was recorded within 32-320kbps (128kbps preferably) with sampling frequencies at 8-48KHz (44.1KHz preferably).

Remote control does not work

- Remove obstacle between the remote control and the player, and point directly instead of at a wide angle at the infrared sensor on the player.
- The battery may be exhausted. Replace the battery with a new one.
- Try using the remote control with a maximum distance of 3 meters from the sensor on the player.
- Try using the remote control within a maximum angle of 30°

Picture CD cannot be played

- Make sure that the picture CD is JPEG VGA format (640x480 pixels)

CAUTION

Use of controls or adjustments or performance of procedures other than herein may result in hazardous radiation exposure or other unsafe operation.

SAFETY & WARNINGS

Ⓒ WARNING

All ICs and many other semiconductors are susceptible to electrostatic discharges (ESD). Careless handling during repair can reduce life drastically.

When repairing, make sure that you are connected with the same potential as the mass of the set via a wristband with resistance. Keep components and tools at this potential.

Ⓕ ATTENTION

Tous les IC et beaucoup d'autres semi-conducteurs sont sensibles aux décharges statiques (ESD). Leur longévité pourrait être considérablement écourtée par le fait qu'aucune précaution n'est prise à leur manipulation.

Lors de réparations, s'assurer de bien être relié au même potentiel que la masse de l'appareil et enfiler le braceleterti d'une résistance de sécurité.

Veiller à ce que les composants ainsi que les outils que l'on utilise soient également à ce potentiel.

ESD



Ⓓ WARNING

Alle ICs und viele andere Halbleiter sind empfindlich gegenüber elektrostatischen Entladungen (ESD). Unvorsichtige Behandlung im Reparaturfall kann die Lebensdauer drastisch reduzieren.

Sorgen Sie dafür, daß Sie im Reparaturfall über ein Pulsarmband mit Widerstand mit dem Massepotential des Gerätes verbunden sind.

Halten Sie Bauteile und Hilfsmittel ebenfalls auf diesem Potential.

Ⓖ WAARSCHUWING

Alle IC's en vele andere halfgeleiders zijn gevoelig voor electrostatische ontladingen (ESD).

Onzorgvuldig behandelen tijdens reparatie kan de levensduur drastisch doen verminderen. Zorg ervoor dat u tijdens reparatie via een polsband met weerstand verbonden bent met hetzelfde potentiaal als de massa van het apparaat.

Houd componenten en hulpmiddelen ook op ditzelfde potentiaal.

Ⓘ AVVERTIMENTO

Tutti IC e parecchi semi-conduttori sono sensibili alle scariche statiche (ESD).

La loro longevità potrebbe essere fortemente ridotta in caso di non osservazione della più grande cauzione alla loro manipolazione. Durante le riparazioni occorre quindi essere collegato allo stesso potenziale che quello della massa del apparecchio tramite un braccialetto a resistenza.

Assicurarsi che i componenti e anche gli utensili con quali si lavora siano anche a questo potenziale.

Ⓒ AVAILABLE ESD PROTECTION EQUIPMENT :

anti-static table mat	large 1200x650x1.25mm	4822 466 10953
	small 600x650x1.25mm	4822 466 10958
anti-static wristband		4822 395 10223
connection box (3 press stud connections, 1MΩ)		4822 320 11307
extendible cable (2m, 2MΩ, to connect wristband to connection box)		4822 320 11305
connecting cable (3m, 2MΩ, to connect table mat to connection box)		4822 320 11306
earth cable (1MΩ, to connect any product to mat or to connection box)		4822 320 11308
KIT ESD3 (combining all 6 prior products - small table mat)		4822 310 10671
wristband tester		4822 344 13999

Ⓒ

Safety regulations require that the set be restored to its original condition and that parts which are identical with those specified be used.

Safety components are marked by the symbol

Ⓕ

Les normes de sécurité exigent que l'appareil soit remis à l'état d'origine et que soient utilisées les pièces de rechange identiques à celles spécifiées.

Les composants de sécurité sont marqués

SAFETY



Ⓓ

Bei jeder Reparatur sind die geltenden Sicherheitsvorschriften zu beachten. Der Originalzustand des Gerätes darf nicht verändert werden. Für Reparaturen sind Originalersatzteile zu verwenden.

Sicherheitsbauteile sind durch das Symbol

Ⓖ

Veiligheidsbepalingen vereisen, dat het apparaat in zijn oorspronkelijke toestand wordt teruggebracht en dat onderdelen, identiek aan de gespecificeerde, worden toegepast. De Veiligheidsonderdelen zijn aangeduid met het symbool

Ⓘ

Le norme di sicurezza estigono che l'apparecchio venga rimesso nelle condizioni originali e che siano utilizzati i pezzi di ricambio identici a quelli specificati.

Componenti di sicurezza sono marcati con

Ⓒ

DANGER: Invisible laser radiation when open. AVOID DIRECT EXPOSURE TO BEAM.



Ⓔ Warning !

Osynlig laserstråling når apparaten är öppnad och spårren är urkopplad. Betrakta ej strålen.

ⒹK Advarsel !

Usynlig laserstråling ved åbning når sikkerhedsafbrydere er ude af funktion. Undgå udsættelse for stråling.

Ⓕ Varoitus !

Avatussa laitteessa ja suojalukituksen ohitettaessa olet alttiina näkymättömälle laserisäteilylle. Älä katso säteeseen !

Ⓒ

After servicing and before returning the set to customer perform a leakage current measurement test from all exposed metal parts to earth ground, to assure no shock hazard exists.

The leakage current must not exceed 0.5mA.

Ⓕ

"Pour votre sécurité, ces documents doivent être utilisés par des spécialistes agréés, seuls habilités à réparer votre appareil en panne".

SERVICE HINTS

REPAIR POSITION COPPERSIDE



To get access to the copperside of the printed board assembly proceed as follows:

- 1.Remove bottom screws (3x)
- 2.Lift the bottom-assy-1
- 3.Supply the unit via external DC-socket
- 4.Take care that the door switch is closed during measurements

DISMANTLING THE CD-DOOR



To dismantle the CD-door proceed as follows:

- 1.Dismantle bottom and printed board/drive assembly
- 2.Disconnect the sticker
(flex-foil connector on the membrane keyboard)
- 3.Disconnect membrane keyboard
(flex-foil connector on copperside of printed board)

REPAIR POSITION COMPONENTSIDE



To get access to the compomentside of the printed board assembly proceed as follows:

- 1.Remove the bottom screws(3x)
- 2.Open the CD-door
- 3.Lift the cabinet-assy-2 and put it backwards on the table
- 4.Supply the unit via the external DC-socket
- 5.Take care that the door switch is closed during measurements

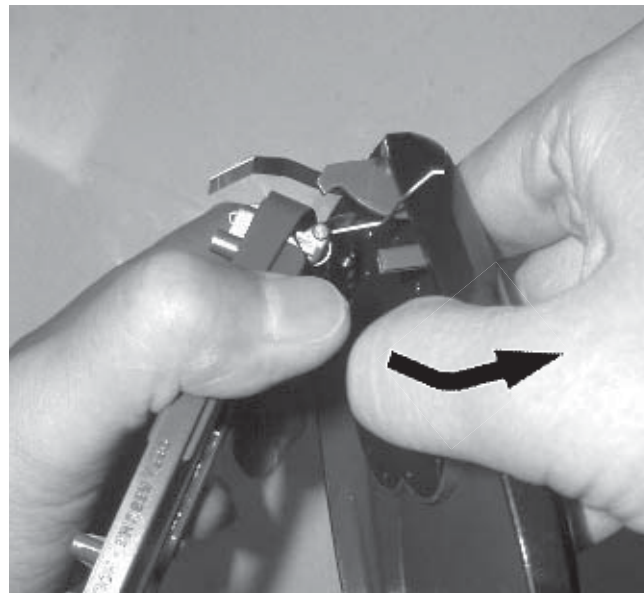

- 4.Bend the CD-door rightwards downwards as indicated in the picture above

Remark:Do not use screwdrivers or tools.
Sharp edges could damage hinge or cabinet part.

HANDLING CHIP COMPONENTS

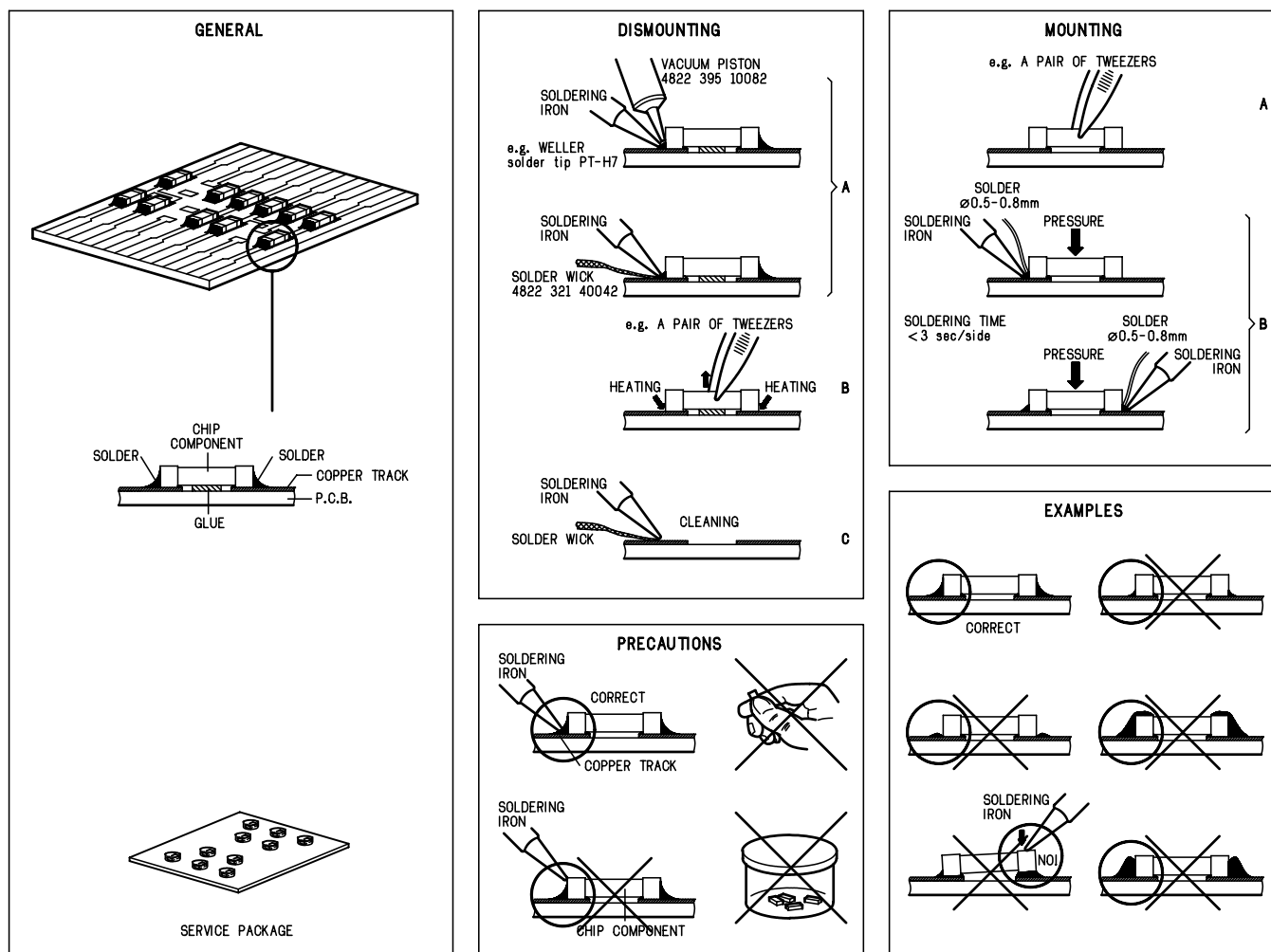

SERVICE TOOLS

Audio signal disc **SBC429**

Playability test disc **SBC444**

Test disc **5** (disc without errors) + Test disc **5A** (disc with dropout errors
black spots and fingerprints) **SBC426/ SBC426A**

4822 397 30184

4822 397 30245

4822 397 30096

ESD PROTECTION EQUIPMENT

Anti-static table mat large 1200x650x1.25mm

small 600x650x1.25mm

4822 466 10953

4822 466 10958

Anti-static wristband

4822 395 10223

Connection box (3press stud connections, 1MΩ)

4822 320 11307

Extendible cable (2m, 2MΩ, to connect wristband to connection box)

4822 320 11305

Connecting cable (3m, 2MΩ, to connect table mat to connection box)

4822 320 11306

Earth cable (1MΩ, to connect any product to mat or to connection box)

4822 320 11308

KIT ESD3 (combining all 6 prior products - small table mat)

4822 310 10671

Wristband tester

4822 344 13999

BLOCK DIAGRAM

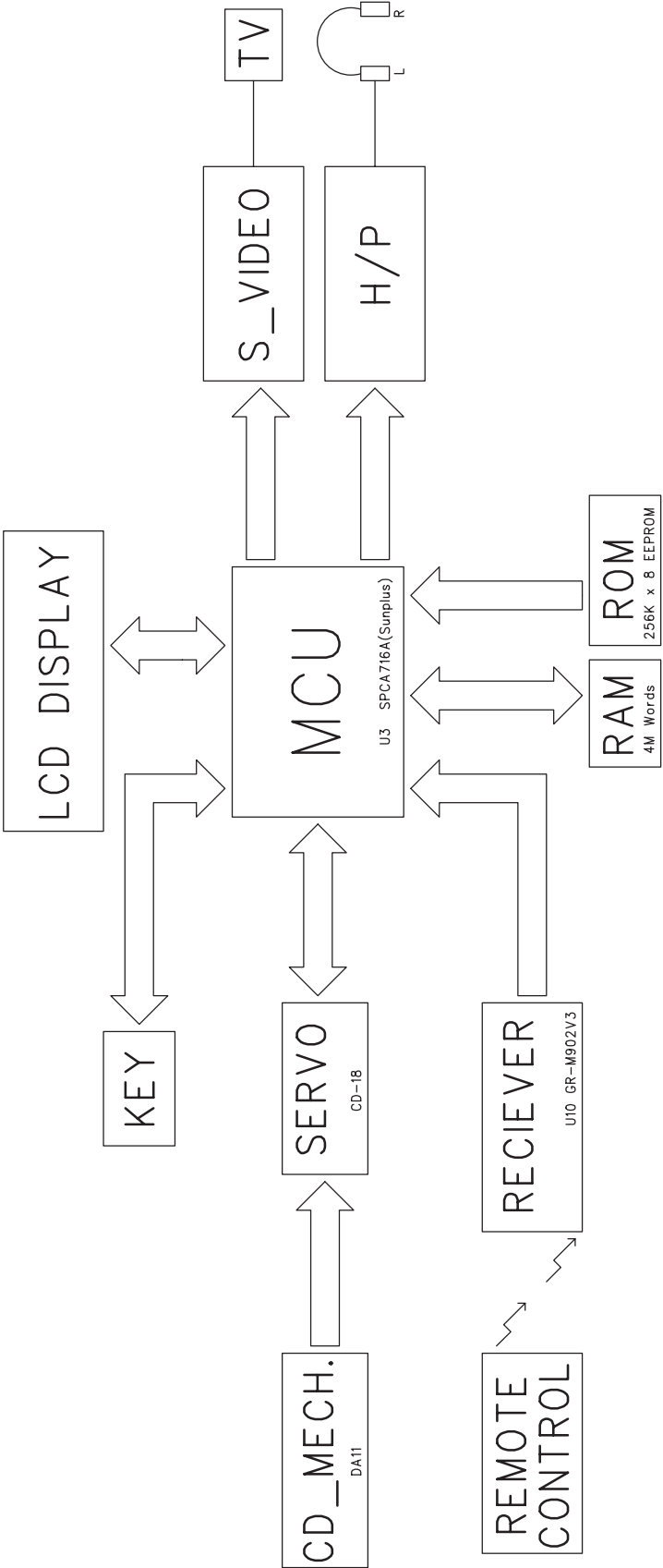

COMBI BOARD - CIRCUIT DIAGRAM PART 1

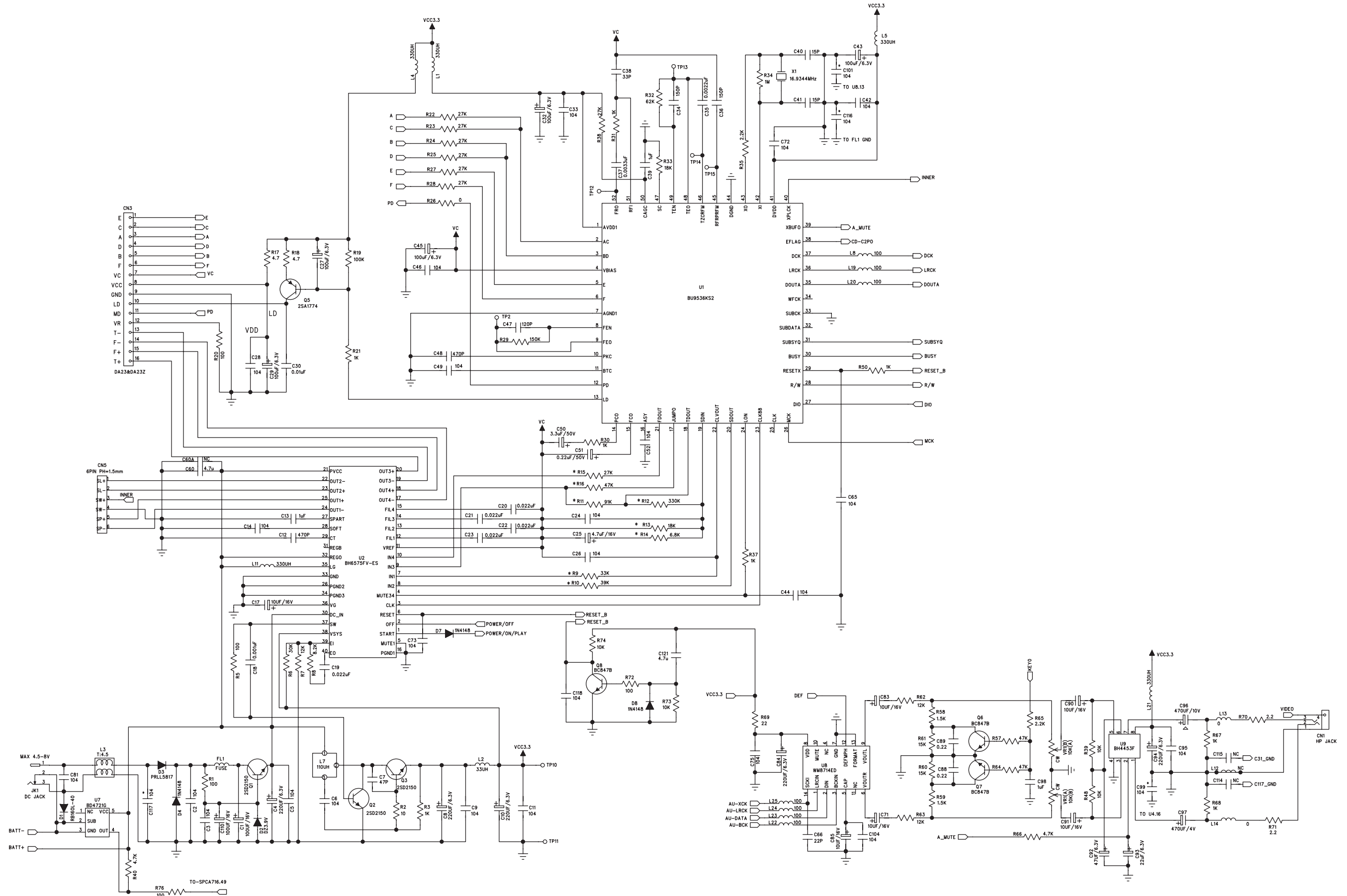

COMBI BOARD - CIRCUIT DIAGRAM PART 2

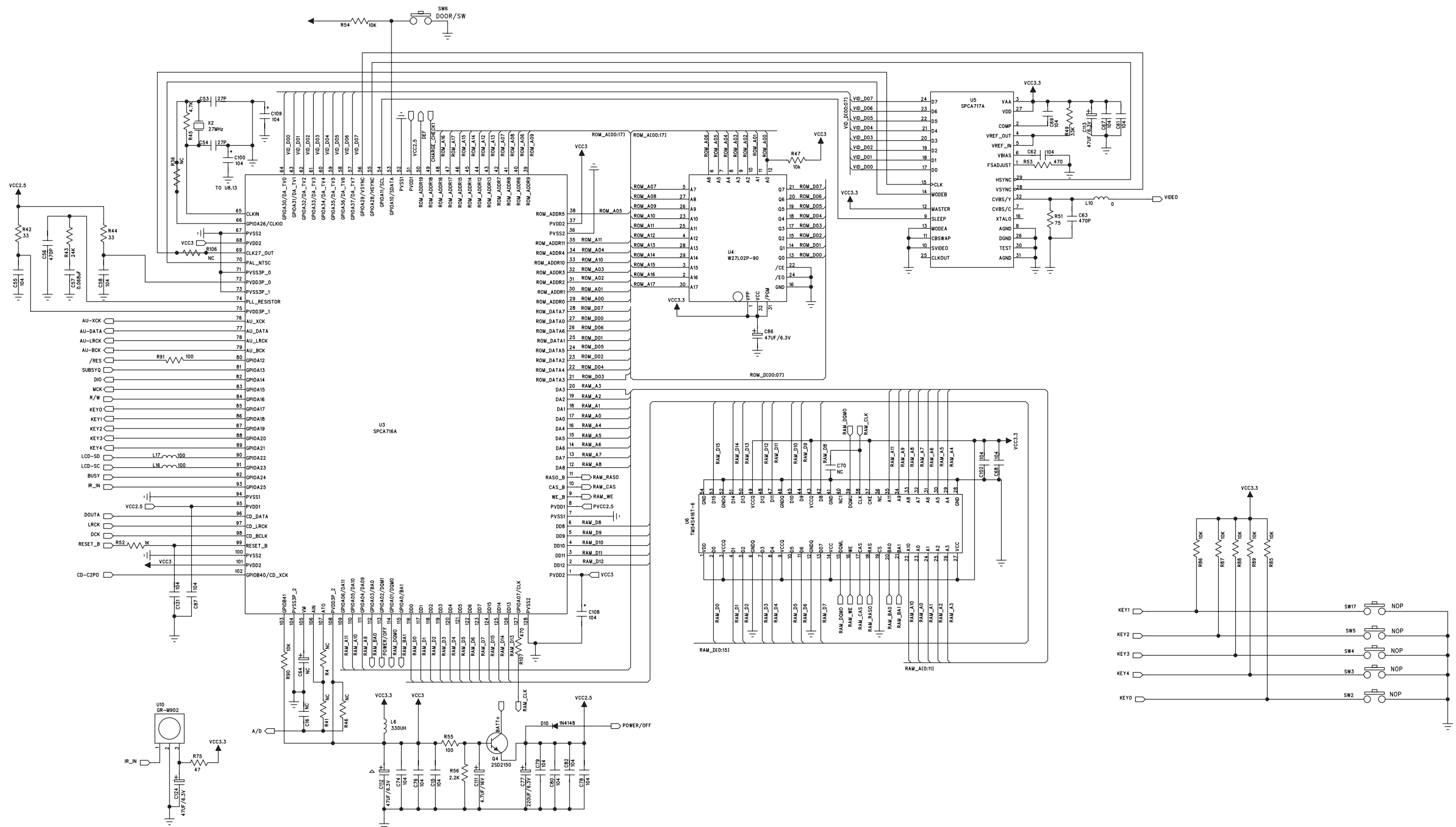

COMBI BOARD - CIRCUIT DIAGRAM PART 3

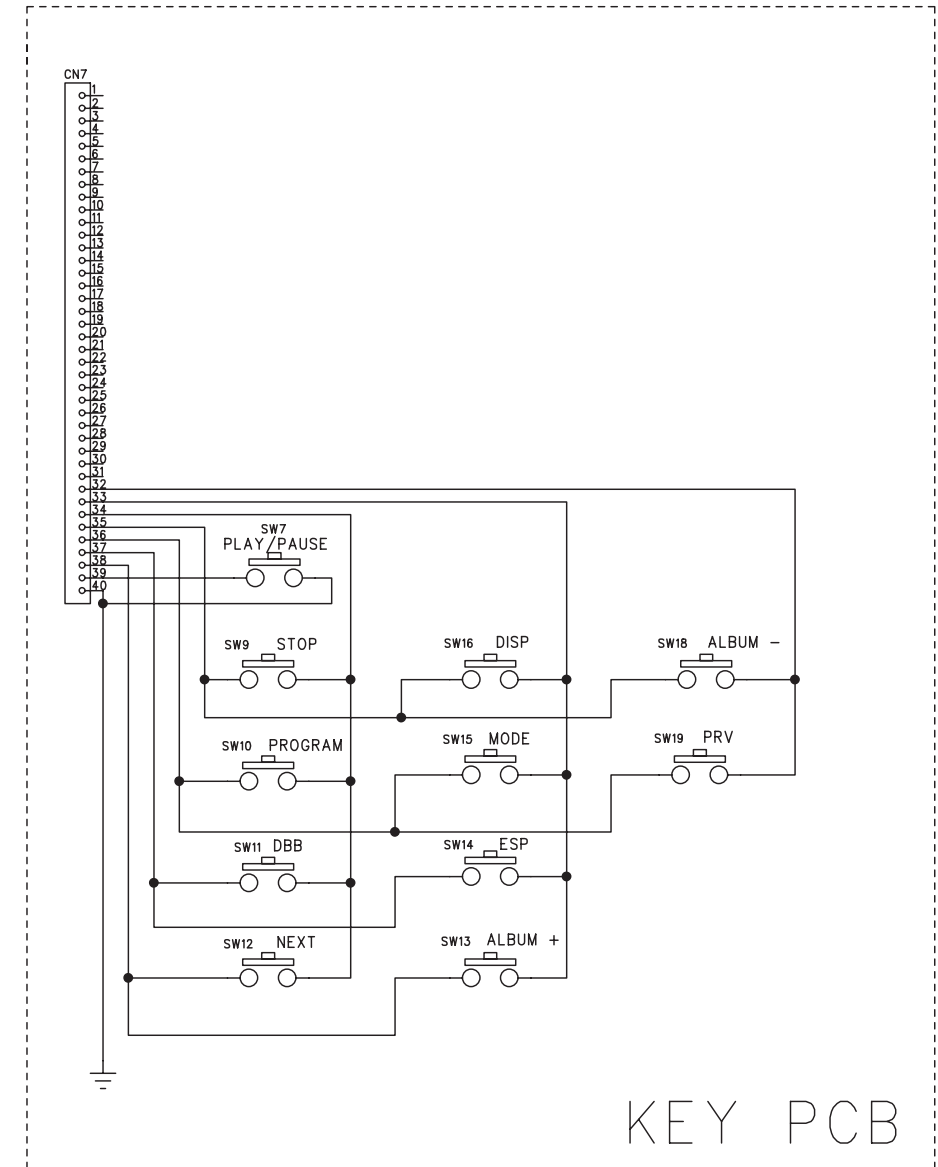
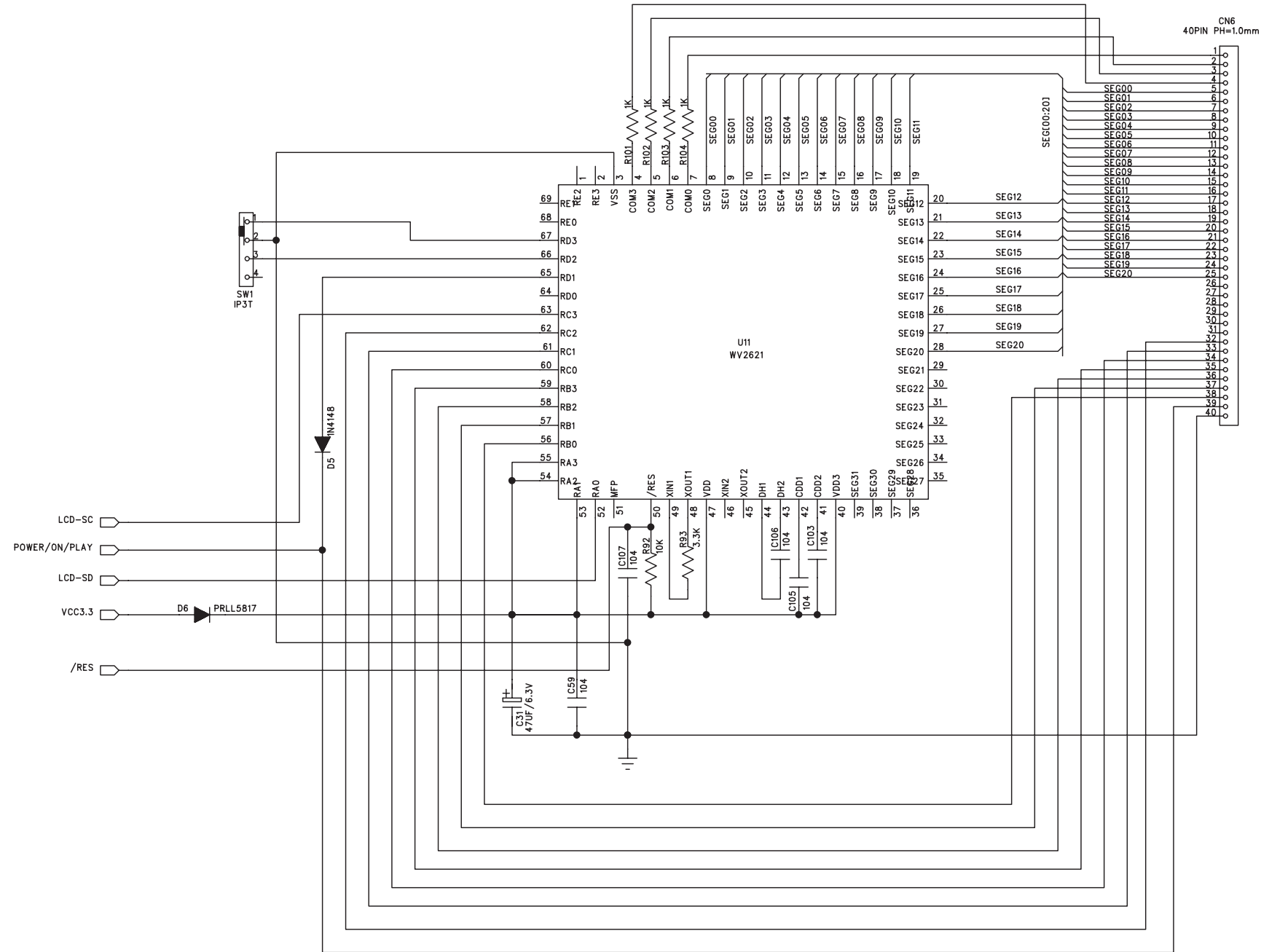

KEY PCB

COMBI BOARD - LAYOUT DIAGRAM COMPONENT SIDE VIEW

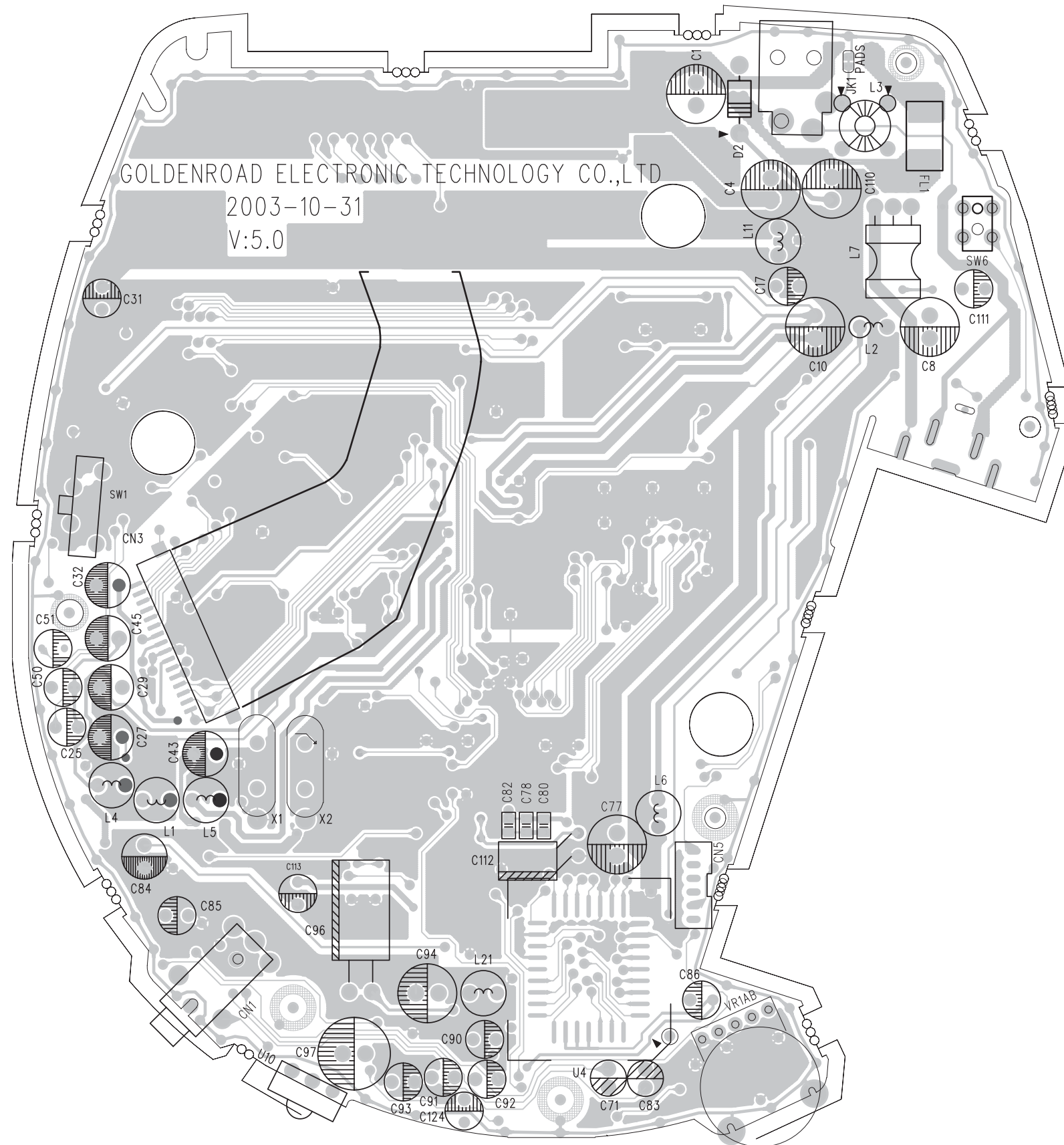

COMBI BOARD - LAYOUT DIAGRAM COPPER SIDE VIEW

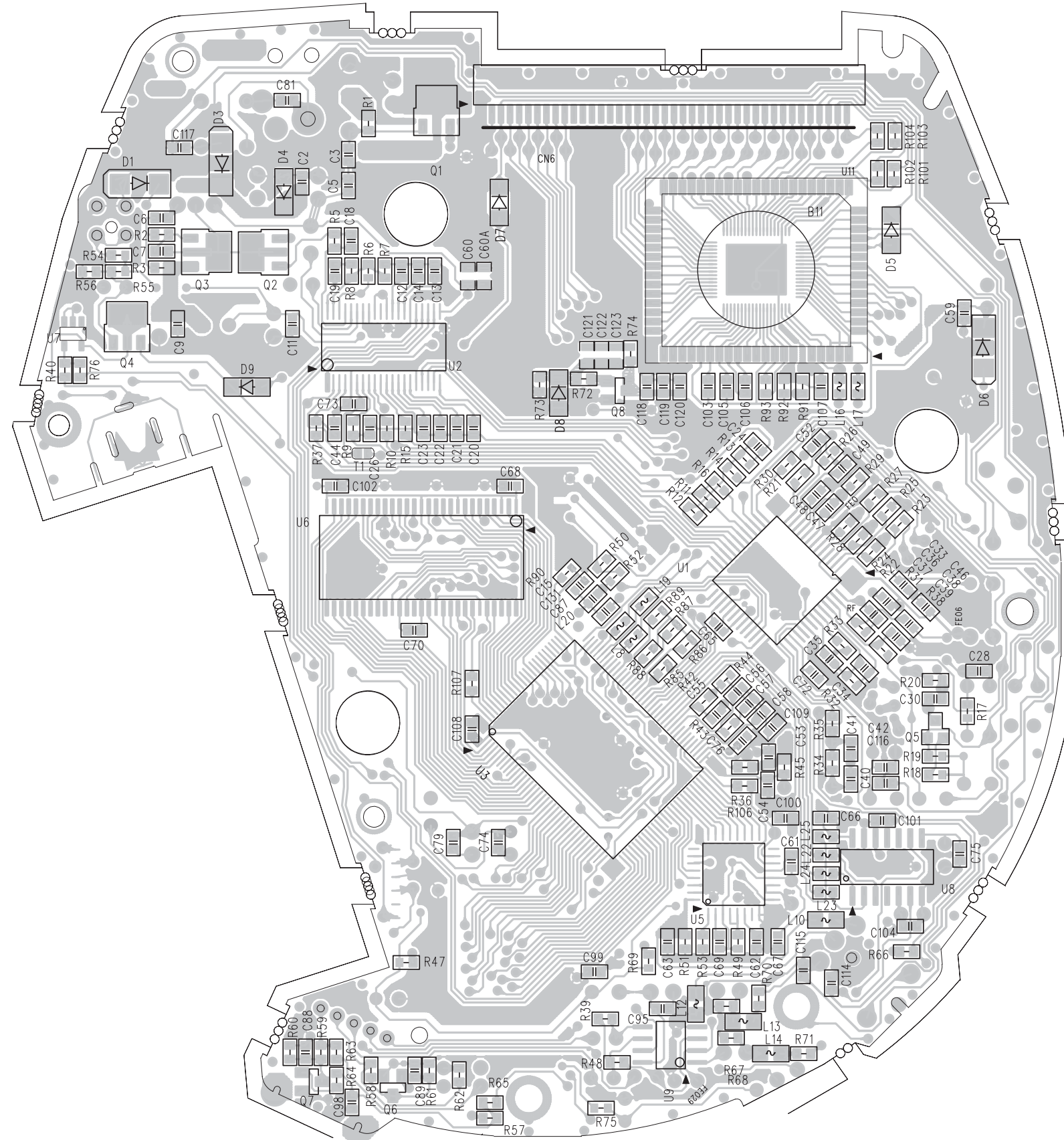

EXPLODED VIEW DIAGRAM

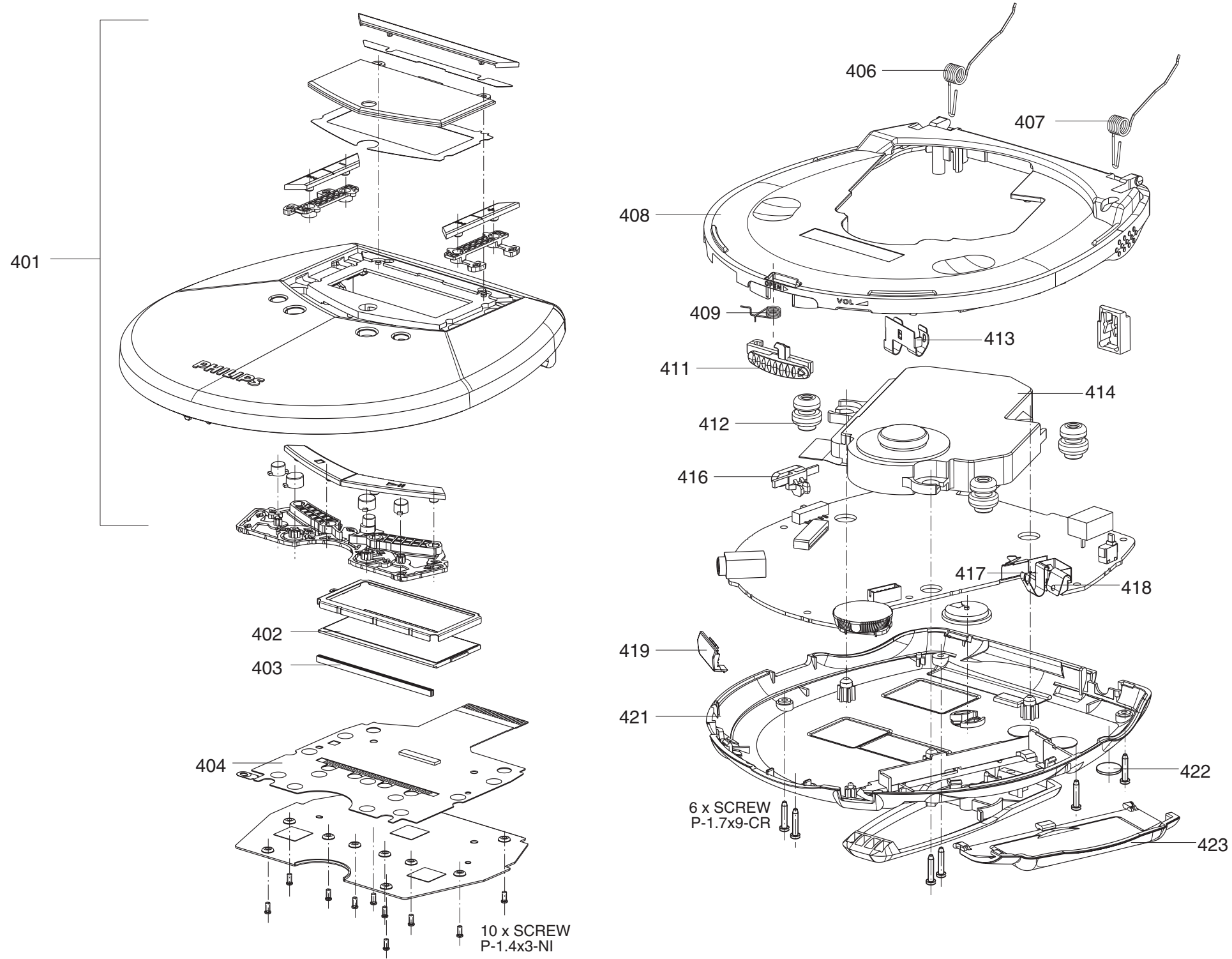

MECHANICAL PARTSLIST

401	9965 000 22605	CD DOOR ASSY
402	9965 000 22612	LCD DISPLAY
403	9965 000 22610	JOINT RUBBER
404	9940 000 00035	MEMBRANCE PCB
406	9965 000 22600	CD DOOR SPRING LEFT
407	9965 000 22601	CD DOOR SPRING RIGHT
408	9965 000 22606	MIDDLE CAB
409	9965 000 22599	OPEN KNOB SPRING
411	9965 000 22604	SLIDE KNOB-OPEN
412	9965 000 22609	CD DAMPER
413	9965 000 22598	BATTERY SPRING(+)
414	3103 309 05480	CD DA23ZPH
416	9965 000 22603	SLIDE KNOB-HOLD
417	9965 000 22597	BATTERY SPRING PLATE(-)
418	9965 000 22596	BATTERY SPRING PLATE(+)
419	9965 000 22608	REMOTE LENS
421	9965 000 22607	BOTTOM CAB
422	9965 000 22611	RUBBER FOOT
423	9965 000 22602	BATTERY DOOR

Note: Only these parts mentioned in the list are normal service parts.

ELECTRICAL PARTSLIST - COMBI BOARD**- MISCELLANEOUS -**

U10	9965 000 22613	IR RECEIVER GR-M902
SW1	9965 000 16227	SLIDE SWITCH 1P3T
SW6	9965 000 16226	CD DOOR SWITCH DTS-03
JK1	9965 000 11404	DC JACK TC18-099-03
CN1	9965 000 22614	STEREO PHONE JACK
VR1AB	9965 000 22615	ROTARY VOLUME

- IC & TRANSISTORS -

Q6	5322 130 42755	BC847B
Q7	5322 130 42755	BC847B
Q8	5322 130 42755	BC847B

Note: Only these parts mentioned in the list are normal service parts.

- COILS & FILTERS -

X1	9965 000 22616	CRYSTAL 16,9344MHZ 20PF
X2	9965 000 22617	CRYSTAL 27MHZ 20PF
L1	9965 000 22618	MICRO INDUCTOR 330 μ H-K
L2	9965 000 16232	FXD INDUCTOR 33 μ H
L4	9965 000 22618	MICRO INDUCTOR 330 μ H-K
L5	9965 000 22618	MICRO INDUCTOR 330 μ H-K
L6	9965 000 22618	MICRO INDUCTOR 330 μ H-K
L7	9965 000 22619	DC-CD OSC COIL
L11	9965 000 22618	MICRO INDUCTOR 330 μ H-K
L21	9965 000 22618	MICRO INDUCTOR 330 μ H-K

- DIODES -

D2	9965 000 22620	ZENER DIODE3V9 1/2W
D3	4822 130 83918	PRLL5817
D4	4822 130 30621	1N4148
D5	4822 130 30621	1N4148
D6	4822 130 83918	PRLL5817
D7	4822 130 30621	1N4148
D8	4822 130 30621	1N4148
D9	4822 130 30621	1N4148

- IC & TRANSISTORS -

U1	9965 000 22627	IC BU9536KS2
U2	9965 000 21011	IC BH6575FV-E2
U3	9965 000 22622	IC SPCA716A
U4	9965 000 22623	IC W27L02P-90
U5	9965 000 22628	IC SPCA717A
U6	9965 000 22624	IC TM54S416T-6
U7	9965 000 22625	IC BD4721G
U8	9965 000 22630	IC WM8714ED
U9	9965 000 22626	IC BH4453F
U11	9965 000 22629	IC WV2621
Q1	9965 000 22631	2SD2150
Q2	9965 000 22631	2SD2150
Q3	9965 000 22631	2SD2150
Q4	9965 000 22631	2SD2150
Q5	9965 000 22632	2SA1774TLQ