

CD Stereo Radio Recorder

Service
Service
Service

AZ1050
AZ1055
all versions



Service Manual



TABLE OF CONTENTS

	chapter		chapter
Handling chip components and safety	1 - 1	FRONT BOARD	
Technical Specification & Service Tools	2 - 1	circuit diagram	7 - 4
Service Measurement	2 - 2	layout diagram	7 - 4
Connections & Controls	3 - 1	EXPLODED VIEWS DIAGRAM	
Instructions for use	3 - 2 to 3 - 5	cabinet	8 - 1
Disassembly Diagram	4 - 1	tape deck	8 - 2
CD Service Test Program	4 - 2 to 4 - 3	Mechanical partslist	8 - 2
Block Diagram	5 - 1	Electrical partslist	9 - 1 to 9 - 4
Wiring Diagram	5 - 2		
TUNER BOARD			
circuit diagram	6 - 1		
layout diagram	6 - 2		
COMBI BOARD			
circuit diagram	7 - 1, 7 - 3, 7 - 5		
layout diagram	7 - 2, 7 - 6		

Safety regulations require that the set be restored to its original condition and that parts which are identical with those specified be used.

© Copyright 1995 Philips Consumer Electronics B.V. Eindhoven, The Netherlands
All rights reserved. No part of this publication may be reproduced, stored in a retrieval system or transmitted, in any form or by any means, electronic, mechanical, photocopying, or otherwise without the prior permission of Philips.

**CLASS 1
LASER PRODUCT**



PHILIPS

HANDLING CHIP COMPONENTS

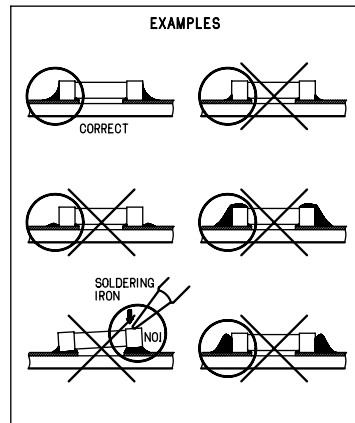
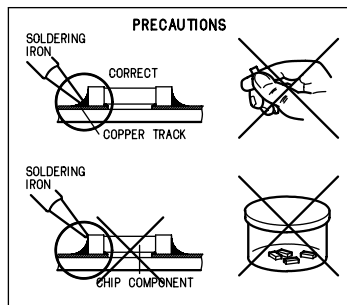
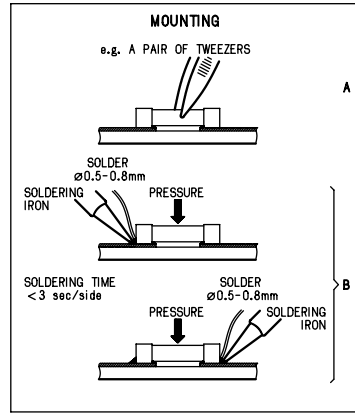
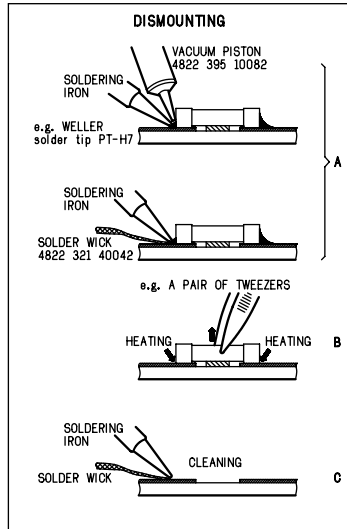
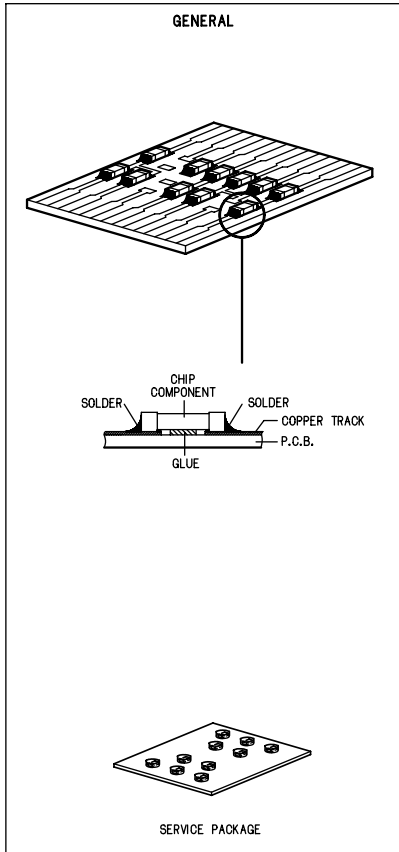

© WARNING

All ICs and many other semiconductors are susceptible to electrostatic discharges (ESD). Careless handling during repair can reduce life drastically. When repairing, make sure that you are connected with the same potential as the mass of the set via a wristband with resistance. Keep components and tools at this potential.



ñ WAARSCHUWING

Alle IC's en vele andere halfgeleiders zijn gevoelig voor electrostatische ontladingen (ESD). Onzorgvuldig behandelen tijdens reparatie kan de levensduur drastisch doen verminderen. Zorg ervoor dat u tijdens reparatie via een polsband met weerstand verbonden bent met hetzelfde potentiaal als de massa van het apparaat. Houd componenten en hulpmiddelen ook op ditzelfde potentiaal.

f ATTENTION

Tous les IC et beaucoup d'autres semi-conducteurs sont sensibles aux décharges statiques (ESD). Leur longévité pourrait être considérablement écourtée par le fait qu'aucune précaution n'est prise à leur manipulation. Lors de réparations, s'assurer de bien être relié au même potentiel que la masse de l'appareil et enfilez le bracelet sert d'une résistance de sécurité. Veiller à ce que les composants ainsi que les outils que l'on utilise soient également à ce potentiel.

d WARNUNG

Alle ICs und viele andere Halbleiter sind empfindlich gegenüber elektrostatischen Entladungen (ESD). Unvorsichtige Behandlung im Reparaturfall kann die Lebensdauer drastisch reduzieren. Sorgen Sie dafür, daß Sie im Reparaturfall über ein Pulsarmband mit Widerstand mit dem Massepotential des Gerätes verbunden sind. Halten Sie Bauteile und Hilfsmittel ebenfalls auf diesem Potential.

i AVVERTIMENTO

Tutti IC e parecchi semi-conduttori sono sensibili alle scariche statiche (ESD). La loro longevità potrebbe essere fortemente ridotta in caso di non osservazione della più grande cautela alla loro manipolazione. Durante le riparazioni occorre quindi essere collegato allo stesso potenziale che quello della massa dell'apparecchio tramite un bracciale a resistenza. Assicurarsi che i componenti e anche gli utensili con quali si lavora siano anche a questo potenziale.

©

Safety regulations require that the set be restored to its original condition and that parts which are identical with those specified be used. Safety components are marked by the symbol ▲

f

Les normes de sécurité exigent que l'appareil soit remis à l'état d'origine et que soient utilisées les pièces de rechange identiques à celles spécifiées. Les composants de sécurité sont marqués ▲

d

Bei jeder Reparatur sind die geltenden Sicherheitsvorschriften zu beachten. Der Originalzustand des Gerätes darf nicht verändert werden. Für Reparaturen sind Originalersatzteile zu verwenden. Sicherheitsbauteile sind durch das Symbol ▲ markiert.

ñ

Veiligheidsbepalingen vereisen, dat het apparaat in zijn oorspronkelijke toestand wordt teruggebracht en dat onderdelen, identiek aan de gespecificeerde, worden toegepast. De Veiligheidsonderdelen zijn aangeduid met het symbool ▲

i

Le norme di sicurezza estigono che l'apparecchio venga rimesso nelle condizioni originali e che siano utilizzati i pezzi di ricambio identici a quelli specificati. Componenti di sicurezza sono marcati con ▲

SAFETY



© DANGER: Invisible laser radiation when open. AVOID DIRECT EXPOSURE TO BEAM.

S Varning !

Osynlig laserstrålning när apparaten är öppnad och spårren är urkopplad. Betrakta ej strålen.

Advarsel !

Usynlig laserstrålning ved åbning når sikkerhedsafbrydere er ude af funktion. Undgå udsættelse for strålning.



β Varoitus !

Avatussa laitteessa ja suojalukituksen ohitettaessa olet alltiina näkymättömälle laserisäteilylle. Älä katso säteeseen !

©

After servicing and before returning the set to customer perform a leakage current measurement test from all exposed metal parts to earth ground, to assure no shock hazard exists. The leakage current must not exceed 0.5mA.

f

"Pour votre sécurité, ces documents doivent être utilisés par des spécialistes agréés, seuls habilités à réparer votre appareil en panne".

TECHNICAL SPECIFICATIONS

GENERAL

Mains voltage	-/00/05/10/14 : 230 V
	-/01/11 : 120 / 230 V
	-/17 : 120 V
Mains frequency	-/00/05/10/14 : 50 Hz
	-/01/11 : 50 / 60 Hz
	-/17 : 60 Hz
Battery	mains : 9 V (R20 x 6)
	Remote : 3V (R6 x 2)
Power consumption	: 5 W
Dimension (W x H x D)	: 435 x 252 x 170 mm
Weight	: 3.4 Kg

AMPLIFIER

Output power	mains : 2 x 1.4 W
	battery : 2 x 1.6 W
Speaker impedance	: 2 x 4 ohm
Frequency response	: 100 Hz - 10 kHz (± 3 dB)

TUNER - FM SECTION

Tuning range	: 87.5 - 108 MHz
IF frequency	: 10.7 MHz \pm 0.2 MHz
Sensitivity	: 14 dBf at 26dB S/N
Selectivity	: 45 dB at 300kHz
IF rejection	: 65 dB
Image rejection	: 26 dB

TUNER - AM SECTION

Tuning range	MW : 522 - 1607 kHz
	-/17 : 520 - 1730 kHz
IF frequency	: 468 kHz \pm 3 kHz
Sensitivity	MW : 1500 μ V/m at 26dB S/N
Selectivity	MW : 20 dB
IF rejection	MW : 60 dB
Image rejection	MW : 32 dB

AUDIO CASSETTE RECORDER

Number of tracks	: 2 stereo
Tape speed	: 4.76 cm/sec \pm 3%
Wow & flutter	: < 0.48 JIS UWTD
Fast wind/rewind C60	: < 120 sec.
Frequency response	P/B : 125 - 8000 Hz
S/N ratio	: 40 dB

COMPACT DISC

Frequency response	: 100 Hz - 10 kHz
S/N ratio	: 60 dB
Channel difference	1 kHz : < 3 dB
Channel crosstalk	1 kHz : 40 dB
Laser wavelength	: 780 \pm 20 nm
Laser light power	: < 0.5 mW

SERVICE TOOLS

TORX T10 screwdriver with shaftlength 150mm.....	4822 395 50423
TORX screwdriver set SBC 163.....	4822 295 50145
Audio signal disc SBC 429.....	4822 397 30184
Playability test disc SBC 444.....	4822 397 30245
Test disc 5 (disc without errors) +	
Test disc 5A (disc with dropout errors, black spots and fingerprints)	
SBC 426/426A.....	4822 397 30096
Burn in test disc (65 min. 1kHz signal at -30 dB level without "pause").....	4822 397 30155
Universal test cassette Fe SBC 420.....	4822 397 30071

SERVICE MEASUREMENTS

Tuner FM

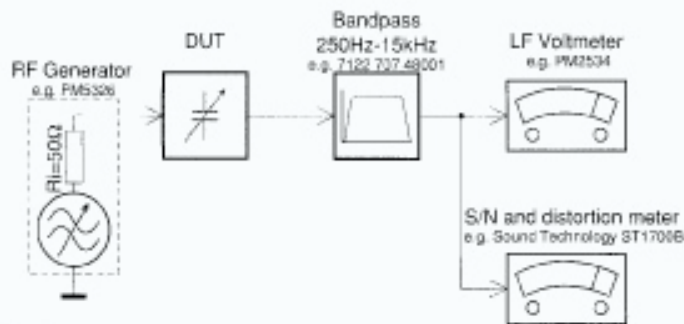

Use a bandpass filter to eliminate hum (50Hz, 100Hz) and disturbance from the pilotone (19kHz, 38kHz).

Tuner AM (MW,LW)

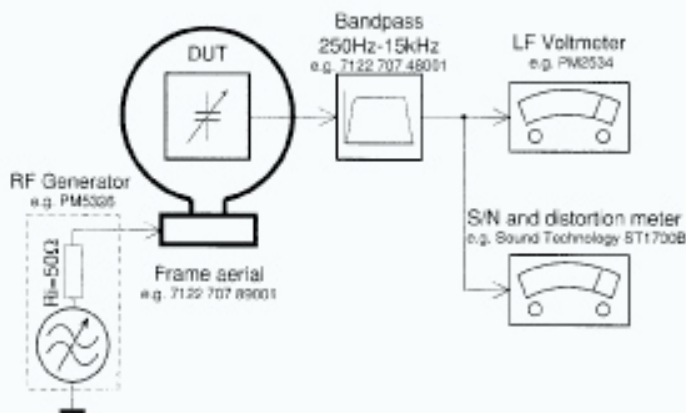

To avoid atmospheric interference all AM-measurements have to be carried out in a Faraday's cage.
Use a bandpass filter (or at least a high pass filter with 250Hz) to eliminate hum (50Hz, 100Hz).

CD

Use Audio Signal Disc SBC429 4822 397 30184
(replaces test disc 3)

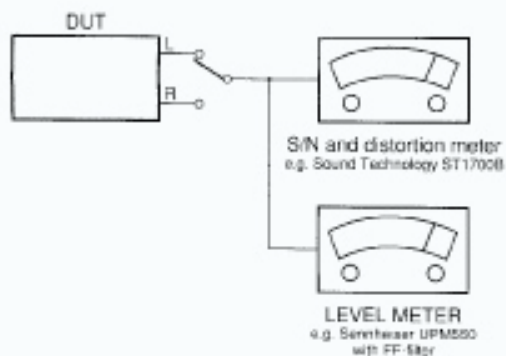

RECORDER

Use Universal Test Cassette Fe SBC420 4822 397 30071

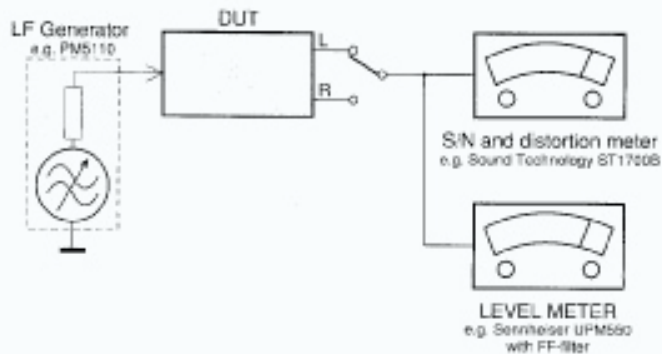

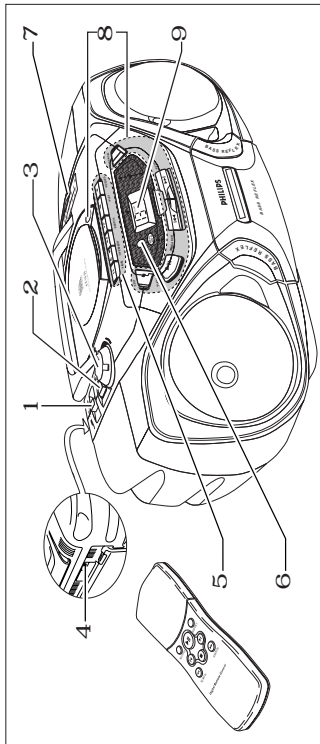

BASIC FUNCTIONS

- 1 POWER: CD, TAPE, BAND ...selects the sound source
- 2 DBB.....enhances the bass
- 3 VOLUMEadjusts the volume level
- 4 P3.5mm headphone socket (back of the set)

Note: Connecting the headphones will switch off the speakers.

5 CASSETTE RECORDER

- PAUSE ;interrupts recording or playback
- OPEN-STOP / 9 ..stops the tape and opens the cassette compartment
- SEARCH 6rewinds the tape
- SEARCH 5fast forwards the tape
- PLAY 1starts playback
- RECORD Ostarts recording

- 6Sensor for the infrared remote control

RADIO

- 7 TUNINGtunes to radio stations
- 1 BAND: FM, MW ...selects the wave band

8 CD PLAYER

- OPEN • CLOSEopens the CD compartment
- 9stops CD play and erases the program
- 2;starts and interrupts CD play
- Sskips and searches forward
-skips and searches backward
- CD MODE.....selects the different CD playing modes and programs tracks

- 9Display

REMOTE CONTROL

- SHUFFLEplays CD tracks in random order
- REPEATrepeats a track, the entire CD or the program
- 2;starts and interrupts CD play
- iTMselects the beginning of the current, a previous or a subsequent track of a CD
- 9stops CD play and erases the program
- 5 6 SEARCH.....searches backward/forward in a CD track

Batteries

For the set (optional)

Open the battery compartment of the set and insert 6 batteries, type R20, UM-1 or D-cells (preferably alkaline).

For the remote control (optional)

Open the battery compartment of the remote control and insert 2 batteries, type R03, UM-4 or AAA-cells (preferably alkaline).

Remove batteries if they are flat or if the set is not going to be used for a long time.

Batteries contain chemical substances, so they should be disposed of properly.

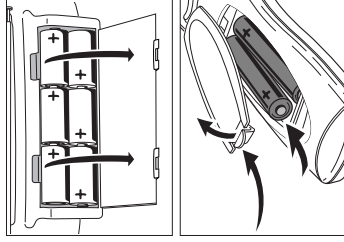

Mains

- 1 Check whether the mains voltage as shown on the type plate corresponds to your local mains voltage. If it does not, consult your dealer or service organisation. **The type plate is located on the bottom of the set.**
- 2 If the set is equipped with a VOLTAGE selector A, set this selector to the local mains voltage.

- 3 Connect the mains cable to the AC MAINS socket and the wall socket. This switches on the mains supply. **The mains cable is inside the battery compartment.**

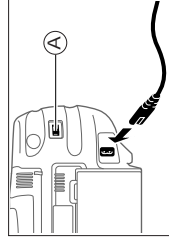

The battery supply will be switched off when the set is connected to the mains. To change over to battery supply, pull out the plug from the unit's AC-MAINS socket.

To disconnect the set from the mains completely, remove the mains plug from the wall socket.

Switching the set on and off

Set the POWER slider to the desired sound source: CD, TAPE, or BAND (for radio).

The set is switched off when the POWER slider is set to **OFF**/TAPE and the keys of the tape deck are released.

Note: If you use batteries, switch the set off after use. This will avoid unnecessary power consumption.

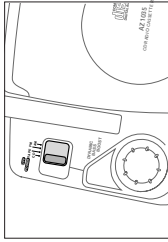

Adjusting volume and sound

Adjust the volume using the VOLUME control.

Increase and decrease the bass level by pressing DBB.

The bass level can also be emphasised if you place the set against wall or shelf. Do not cover any vents; leave sufficient room around the unit for ventilation.

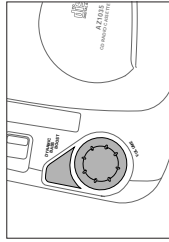

Radio – tuning to radio stations

1 Set the POWER slider to FM or MW to select the desired wave band.

2 Tune to the desired radio station by using the TUNING wheel.

Improving RADIO reception

For **FM** stations, pull out the telescopic antenna. To improve the signal, incline and turn the antenna. Reduce its length if the signal is too strong (very close to a transmitter).

For **MW** stations, direct the built-in antenna by turning the whole set. The telescopic antenna is not needed.

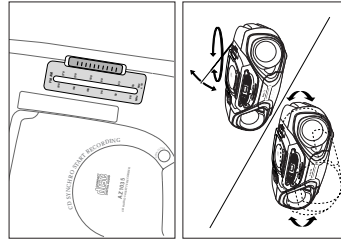

Playing a CD

1 Set the POWER slider to CD.

2 Press / OPEN to open the CD compartment.

3 Insert an audio CD (printed side up) and close the CD compartment.

™ The CD player starts and scans the contents list of the CD. Then, the CD player stops. Display indication: the total number of tracks.

4 Press the 2; button to start CD play.

™ Display indication: the current track number.

5 Press the 9 button to stop CD play.

™ Display indication: the total number of tracks.

You can interrupt CD play by pressing 2; . Continue CD play by pressing the button again.

™ Display indication: the current track number (flashing).

Note: CD play will also stop if:

- you open the CD compartment,
- the end of the CD is reached, or
- you move the POWER slider.

If you make a mistake when operating the CD player, or if the CD player cannot read the CD, the display shows **E** or **no**. (See "TROUBLESHOOTING".)

If you press 2; and there is no CD inserted, the display shows **no**.

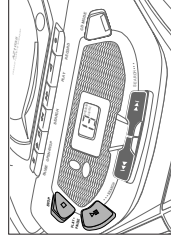
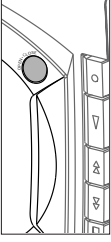

Environmental information

All redundant packing material has been omitted. We have done our utmost to make the packaging easily separable into three mono materials: cardboard (box), polystyrene foam (buffer) and polyethylene (bags, protective foam sheet).

Your set consists of materials which can be recycled if disassembled by a specialized company. Please observe the local regulations regarding the disposal of packing materials, exhausted batteries and old equipment.

Search backward and forward S

Selecting another track

Briefly press the **or S** button once/several times to skip to the beginning of the current, previous or subsequent track(s).

During CD play:

CD play continues automatically with the selected track.

When CD play is stopped:

Press **2**; to start CD play.

TM Display indication: the selected track number.

Searching for a passage during CD play

1 Hold down the **or S** button to find a particular passage in a forward or backward direction.

TM CD play continues at a low volume.

2 Release the button when you have reached the desired passage.

Note: In the different CD modes or when playing a program, searching is only possible within the particular track.

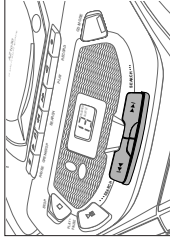

CD MODE: Shuffle and Repeat

1 During CD play press CD MODE repeatedly to cause the display to show the different playing modes.

TM **SHUFFLE**: All tracks of the CD (or program) are played in random order.

TM **SHUFFLE REPEAT ALL**: All tracks of the CD (or program) are played repeatedly in random order.

TM **REPEAT**: The current track is played repeatedly.

TM **REPEAT ALL**: The entire CD (or program) is played repeatedly.

2 After 2 seconds of flashing display indication, CD play starts in the chosen mode.

3 To return to normal CD play, press CD MODE until the display indication disappears.

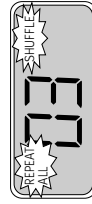
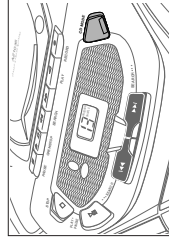

CD MODE: Programming track numbers

You can select a number of tracks and store these in the memory in the desired sequence. You can store any track more than once. A maximum of 20 tracks can be stored in the memory.

1 When CD play is stopped, select the desired track with **or S**.

2 As soon as the number of the desired track is displayed, press CD MODE to store the track in the memory.

TM **PROGRAM** appears on the display, **P** lights up briefly, then the number of the stored track is shown.

3 Select and store all desired tracks in this way.

4 You can review your settings by pressing and holding CD MODE for more than 1 second.

TM The display shows all stored track numbers in sequence.

If you try to store more than 20 tracks, the display shows **F**.

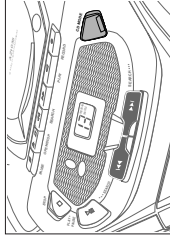

Playing the program

Press **2**; to play the program.

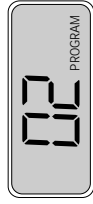

Erasing the program

From the stop position, press **9**.

TM **no** lights up briefly, **PROGRAM** disappears and your program is erased.

Note: The program will also be erased if you:

- interrupt the power supply,
- open the CD compartment, or
- move the POWER slider.



Playing a cassette

- 1 Set the POWER slider to TAPE.
- 2 Press OPEN-STOP / 9 to open the cassette compartment.
- 3 Insert a recorded cassette with the open side upwards and close the cassette compartment.
- 4 Press PLAY 1 to start playback.
- 5 Press 6 or 5 to rewind or fast forward the tape.
- 6 To stop the tape press OPEN-STOP / 9.

Note: The keys are released at the end of the tape.

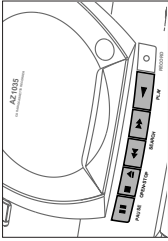

General information on recording

Recording is permissible insofar as copyright or other rights of third parties are not infringed upon.

For recording on this set you should use a cassette of the type NORMAL (IEC type I). This deck is not suitable for recording on cassettes of the type CHROME (IEC type II) or METAL (IEC type IV).

The recording level is set automatically. The controls VOLUME and DBB do not affect the recording.

At the very beginning and end of the tape, no recording will take place in the 7 seconds during which the leader tape passes the recorder heads.

Protecting tapes from accidental erasure

Keep the cassette side to be protected in front of you and snap off the left tab. Now, recording on this side is no longer possible.

To record again on this side of the cassette, cover the opening with a piece of adhesive tape.

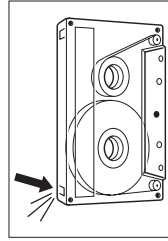

Recording from the CD player – CD synchro start

- 1 Set the POWER slider to CD.
- 2 Insert a CD and, if desired, program the track numbers.
- 3 Press OPEN-STOP / 9 to open the cassette compartment.
- 4 Insert a blank, unprotected, cassette and close the cassette compartment.
- 5 Press RECORD O to start recording.
™ Playing of the CD or program starts automatically.
- 6 For brief interruptions press PAUSE ; . Press the PAUSE ; key again to resume recording.
- 7 To stop recording, press OPEN-STOP / 9.

Note: the recording can be started from different positions:
 – if the CD player is in pause mode, recording will start from this very position (use or S);
 – if the CD player is in stop mode, recording will start from the beginning of the CD or program.

Recording from the radio

- 1 Tune to the desired radio station (see "RADIO").
- 2 Press OPEN-STOP / 9 to open the cassette compartment.
- 3 Insert a blank, unprotected, cassette and close the cassette compartment.
- 4 Press RECORD O to start recording.
- 5 For brief interruptions press PAUSE ; . To resume recording press the PAUSE ; key again.
- 6 To stop recording, press OPEN-STOP / 9.

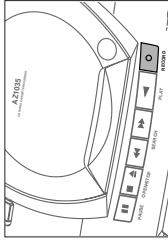

WARNING

If a fault occurs, first check the points listed below before taking the set for repair.

If you are unable to solve a problem by following these hints, consult your dealer or service center.



Under no circumstance should you try to repair the set yourself as this will invalidate the guarantee.

General maintenance

Do not expose the set, batteries, CDs, or tapes to humidity, rain, sand, or excessive heat (caused by heating equipment or direct sunlight).

The mechanical parts of the set contain self-lubricating bearings and must not be oiled or lubricated!

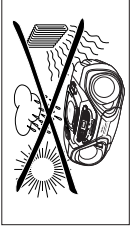
You can clean the set with a soft, slightly dampened, lint-free cloth. Do not use any cleaning agents as they may have a corrosive effect.

Tape deck maintenance

To ensure proper recording and playback quality, clean parts **A**, **B**, and **C** after approximately 50 hours of operation. Use a cotton swab slightly moistened with alcohol or head-cleaner fluid.

Press **PLAY 1** and clean the rubber pressure roller **A**.

Press **PAUSE** ; and clean the capstan **B** and the heads **C**.

Note: Cleaning of the heads **C** can also be done by playing a cleaning tape once.

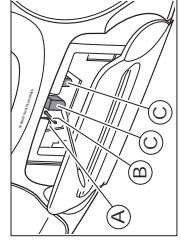

CD player and CD handling

The lens **X** of the CD player should never be touched. Always keep the CD compartment closed to avoid dust on the lens.

The lens may cloud over when the set is suddenly moved from cold to warm surroundings. Playing a CD is not possible then. Leave the CD player in a warm environment until the moisture evaporates.

To take the CD out of its box easily, press the centre spindle while lifting the CD. Always pick up the CD by the edge and put it back in its box after use.

To clean the CD, wipe it in a straight line from the center toward the edge using a soft, lint-free cloth. A cleaning agent may damage the disc!

Never write on a CD or attach a sticker to it.

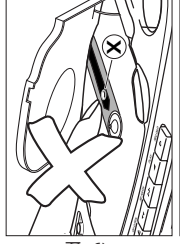
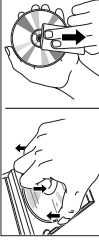
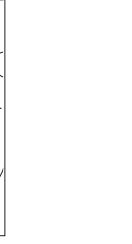



Problem	Possible cause	Solution
No sound, no power	VOLUME is not adjusted. Headphones are connected. Mains cable is not securely connected. Batteries are flat.	Adjust volume. Disconnect headphones. Connect mains cable properly. Insert fresh batteries.
No reaction to operation of any keys	Batteries are inserted incorrectly. Trying to change over from mains to battery supply without removing the plug.	Insert batteries correctly. Remove the mains plug from the unit's AC MAINS socket.
Poor radio reception	Electrostatic discharge. Weak radio signal.	Disconnect the set from power supply, reconnect after a few seconds. Direct the antenna for optimum reception.
no or E indication	Interference caused by electrical equipment like TVs, computers, engines, etc. The CD is badly scratched or dirty. No CD is inserted.	Keep the radio away from electrical equipment. Replace or clean the CD. Insert a CD.
The CD skips tracks	The CD is inserted upside down. The laser lens is steamed up. The CD is damaged or dirty.	Insert CD with label facing up. Wait until the lens has cleared. Replace or clean the CD.
Poor cassette sound quality	SHUFFLE or PROGRAM is active. Dust and dirt on the heads, capstans or pressure rollers. Use of unsuitable cassette types (METAL or CHROME) for recording.	Switch off SHUFFLE or PROGRAM. Clean heads, capstans, and pressure rollers. Only use NORMAL type cassettes for recording.
Recording does not work	Cassette tab(s) may be snapped off.	Apply a piece of adhesive tape over the opening.
Remote control does not function properly	Batteries are inserted incorrectly. Batteries are flat. Distance to the set is too large.	Insert batteries correctly. Insert fresh batteries. Reduce distance.

This set complies with the radio interference requirements of the European Community

DISASSEMBLY DIAGRAM

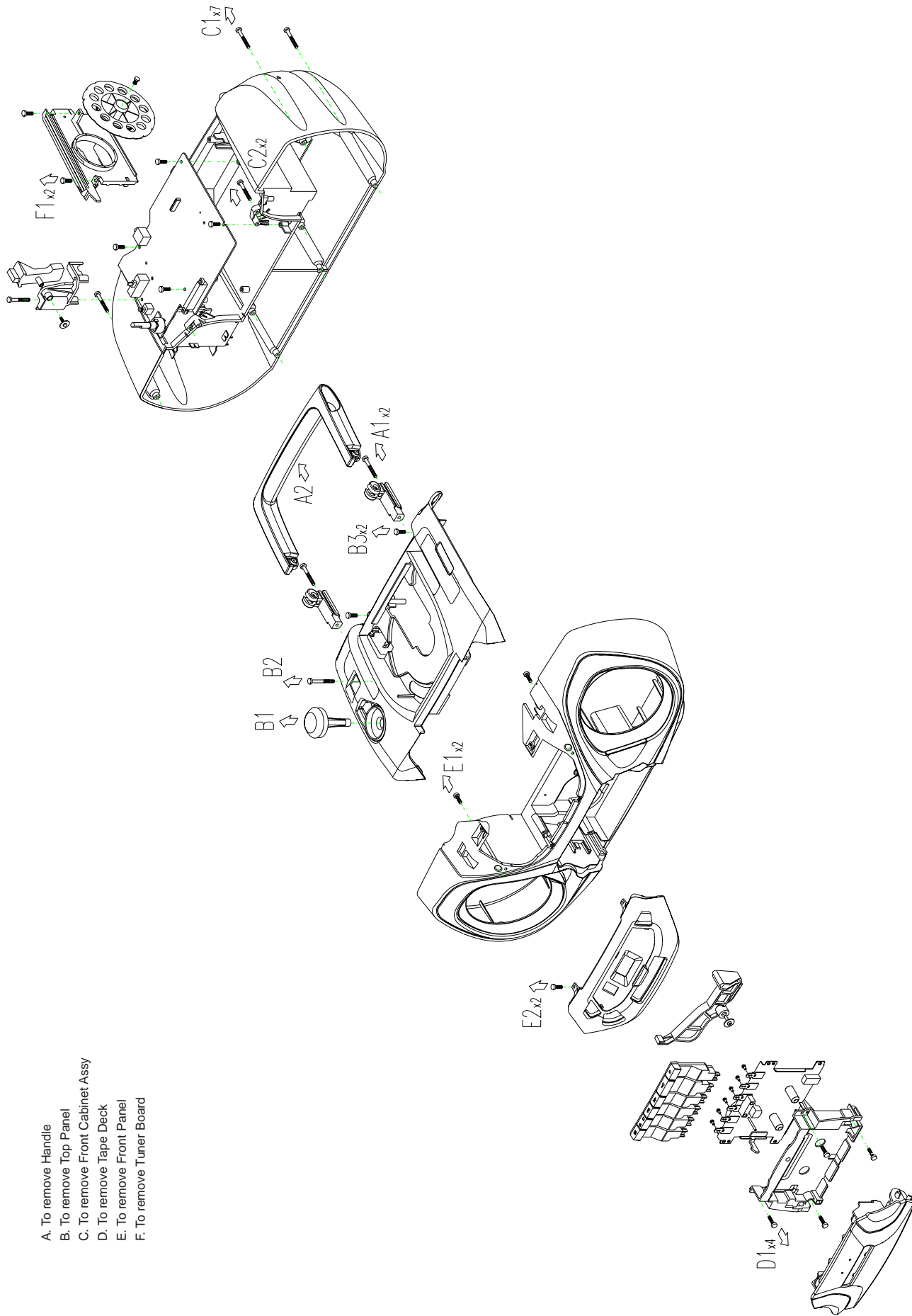
- A. To remove Handle
- B. To remove Top Panel
- C. To remove Front Cabinet Assy
- D. To remove Tape Deck
- E. To remove Front Panel
- F. To remove Tuner Board



SERVICE TESTPROGRAM

- To enter Service Testprogram hold **PLAY** button pressed in any step returns to begin of Service Testprogram.
- Slide servo, Radial servo, Focus servo, Disc motor Mute is switched on via decoder IC.
- * To enter Service Testprogram hold **PLAY** button pressed in any step returns to begin of Service Testprogram.
- CD door can be opened.
- CD mode on.

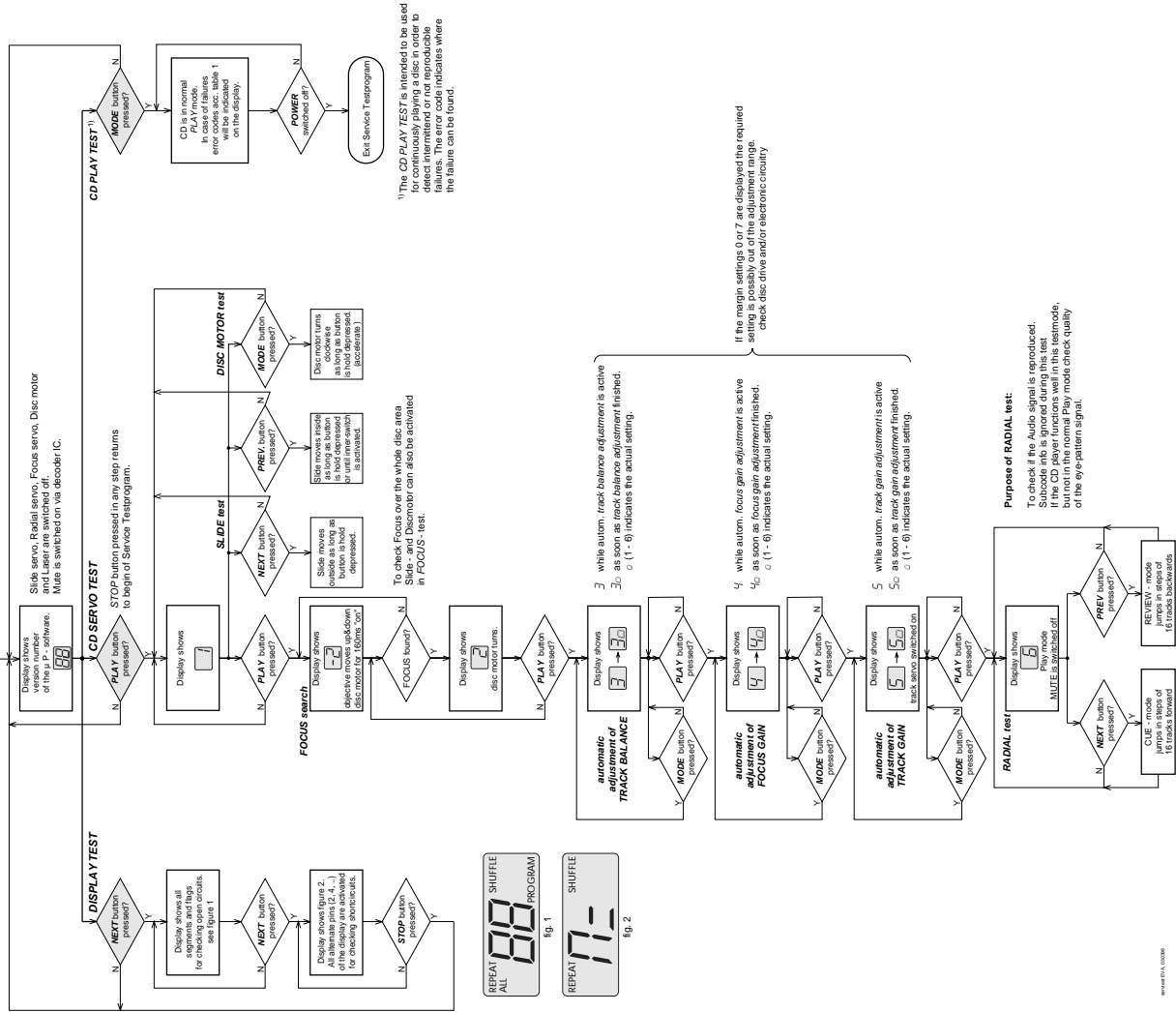

*) The CD PLAY TEST is intended to be used for the test of the CD player. It is not intended to detect intermittent or not reproducible failures. The error code indicates where the failure can be found.

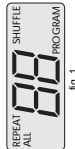

CD ERROR CODES

Error number	Error description	Error type
E0	Focus Error Triggered when the focus is lost for more than 250ms during playing the CD.	W
E2	Slide-in error Generated when the inner-switch did not close within approx. 4s when the pick up is moved inside. Inner-switch or slide motor problems.	W
E3	Slide-out error Generated when the inner-switch did not open within approx. 250ms when the pick up is moved from the inner position outside. Inner-switch or slide motor problems.	W
E5	Jump error. Triggered when the servo processor counts too less tracks in a defined time during JUMPS. This can be caused by a disturbed HF-signal (the tracks cannot be recognized exactly), slide motor problems, track servo problems or scratched discs.	W
E6	Subcode Error No valid subcode for 300ms during PLAY.	W
E7	PLL lock error. When the PLL did not lock after 10 retries then this warning message is generated and the servo is stopped and restarted (as if the user would have pressed STOP and then PLAY immediately) to recover.	W
F0	Focus Search Error Triggered when the focus could not be found within 3s when starting up the CD.	F
F2	Fatal Subcode Error No valid subcode for more than 4s during PLAY.	F

Table 1

Error type: W = Warning
 set continues operation, message remains on the display until next error occurs or any key is pressed.
 F = Fatal Error
 set stops operation, message remains on the display.
 (The set can only be operated again via a reset)

CD STARTUP PROCEDURE

Remark: To check focus servo, slide servo, track servo and turntable use service test program

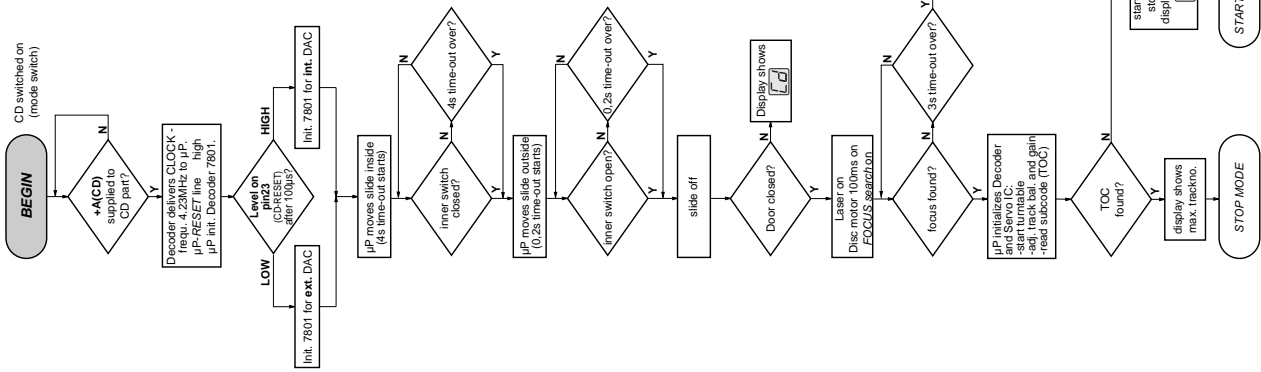

Copyright © 1998

Abbreviations and Pin-descriptions of CD ICs

SERVO PROCESSOR M62475FP

Pin	Name	Direction	Description
1-3	A, B, C	Servo processor	Current input (central photo diode signal input)
4-5	E, F	Servo processor	Signal generator output to track servo, sends 1700Hz for adjustment procedure
6	TGT	Servo processor	Tracking error amplifier
7	TEGain		Gain control input of tracking error amplifier
8	TG		Track Error amplifier output
9	TGIn		Track Gain 1 - switch, controls the gain of the track servo amplifier
10	TE out		Track Error amplifier output
11	TC/Shock		Track Cross/Shock detector input
12	TS +	not connected	Non inverting input of track servo amplifier
13	TG2		Track Gain 2 - switch, controls the gain of the track servo amplifier
14	TS -	Servo processor	Inverting input of slide servo amplifier
15	TS out		Output of track servo amplifier
16	SS +		Non inverting input of slide servo amplifier
17	SS -		Inverting input of slide servo amplifier
18	Slide out	Servo processor	Output of slide servo amplifier
19	DET. FILTER	Servo processor	Pin for connection of DETECTION FILTER capacitor of ADJUST LOGIC
20	BIAS	external electronic	Reference Voltage output Vcc2 of internal BIAS-generator
21	GND		Ground connection pin (negative supply)
22	MILADIS	p	Serial interface Microprocessor Latch control/DI/Charge control for adjustment
23	JPI/SG	p	Serial interface Jump control line/Signal Generator input line for adjustment
24	MICK	p	Serial interface Clock input line
25	MSD	p	Serial interface Data output line
26	Dout	Servo processor	Serial interface Data output line
27	Cu/PF		Pin for connection of Low Pass Filter capacitor of ADJUST LOGIC
28	IREF		Reference current input
29	Vcc		Positive supply connection pin (4V - 5.5V)
30	FSout	Servo processor	Output of focus servo amplifier
31	FS -		Inverting input of focus servo amplifier
32	FEGain		Gain control pin of focus error amplifier
33	FE		Output of focus error amplifier
34	SGF	Servo processor	Signal generator output to focus servo, sends 1300Hz for adjustment procedure
35	CS		Charge pump control input of focus servo
36	ALPC+		Non inverting input of Automatic Laser Power amplifier
37	ALPC-		Inverting input of Automatic Laser Power amplifier
38	ALPCout	Servo processor	Output of Automatic Laser Power Control amplifier
39	MRC		Connection pin for capacitor of Mirror detector
40	HF	Servo processor	Output of HF amplifier
41	HFI		Inverting input of HF amplifier
42	ABC		Sum output of amplified A, B and C input (central photo diode signal input) to external ac-coupling capacitor

SERVO PROCESSOR M65824FP

Pin	Name	Direction	Description
1	Analog Vss	not connected	Analog system ground
2	ADJCLK	not connected	Clock output for servo adjustment, f=88.2kHz
3	LOCK	not connected	Lock monitor / low disc rotation output
4	CKSEL		System clock selection. Low=8.4672MHz, High=16.9344MHz
5	RESET	p	System reset (low level = active)
6	C-423	Signal processor	4.23MHz clock output
7	C-846	p	8.4672MHz clock output
8	XI	X-Tal	Crystal oscillator input
9	DVSS	Signal processor	Digital system ground
10	XO	X-Tal	Crystal oscillator output
11	TEST	not connected	Normal / Test selection input. Testmode = high
12	SBCO		Subcode serial output
13	SCK		Shift clock input for subcode data read
14	STCLK	not connected	Frame lock status output. Lock = high
15	HFRK	not connected	EPH frame clock output. Duty = 50%
16	KTLB	not connected	Digital reference mode output. Digital zero = low
17	ESTL	not connected	Error monitor output 1
18	EST2	not connected	Error monitor output 2
19	HF	Signal processor	HF signal input
20	TLC		Size level control signal output
21	LPF		PLL loop filter
22	Dig. VDD		Digital interface power supply
23	DSPS		Digital system power supply
24	SBO5	not connected	Interrupt signal to read out subcode Q data. Read = low
25	CRCF	not connected	Subcode Q-channel Cyclic Redundance Check Flag output. CRC o.k. = high level
26	SCAND	not connected	Subcode sync signal detection. Sync = high
27	PWM	Signal processor	Disc motor driving (Pulse Width Modulation) output
28	DVDD2		Digital interface power supply 2
29	DVSS2		Digital system ground 2
30	MCK	p	p interface Shift Clock input
31	MSD	p	p interface Serial Data I/O line
32	MILAB	p	Interface Latch clock input (internal 22k pull up resistor)
33	EXP1	Signal processor	Versatile input pin (internal 4.7k pull up resistor)
34	EXP2	Signal processor	Versatile input pin (internal 4.7k pull up resistor)
35	CGREF	Signal processor	Charge-pump for LFP reference current input
36	OUTREF	Signal processor	Op-amp for LFP reference voltage setting
37	LDOUT	Signal processor	Audio signal output (left channel) / Ext. DAC mode: Wordclock output
38	LINEG	Signal processor	Audio signal output (right channel) / Ext. DAC mode: Data shift clock output
39	ROUTPSCK	Signal processor	Charge pump output (right channel) / Ext. DAC mode: L/R clock output
40	RNEG/LRCK	Signal processor	Current reference
41	IREF		Analog system power supply
42	Analog VDD		Analog system power supply

BLOCK DIAGRAM

5-1

5-1

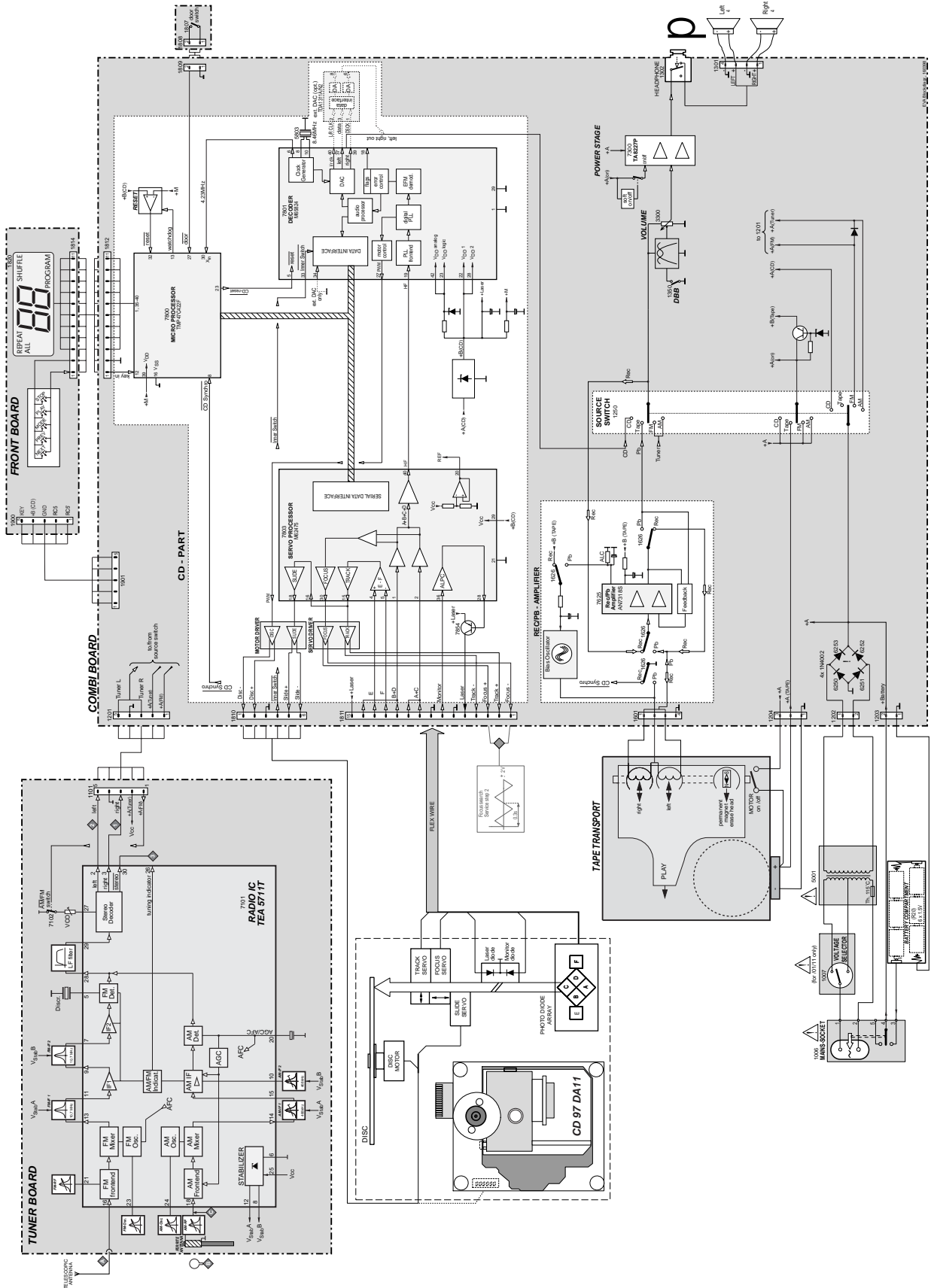

WIRING DIAGRAM

5-2

5-2

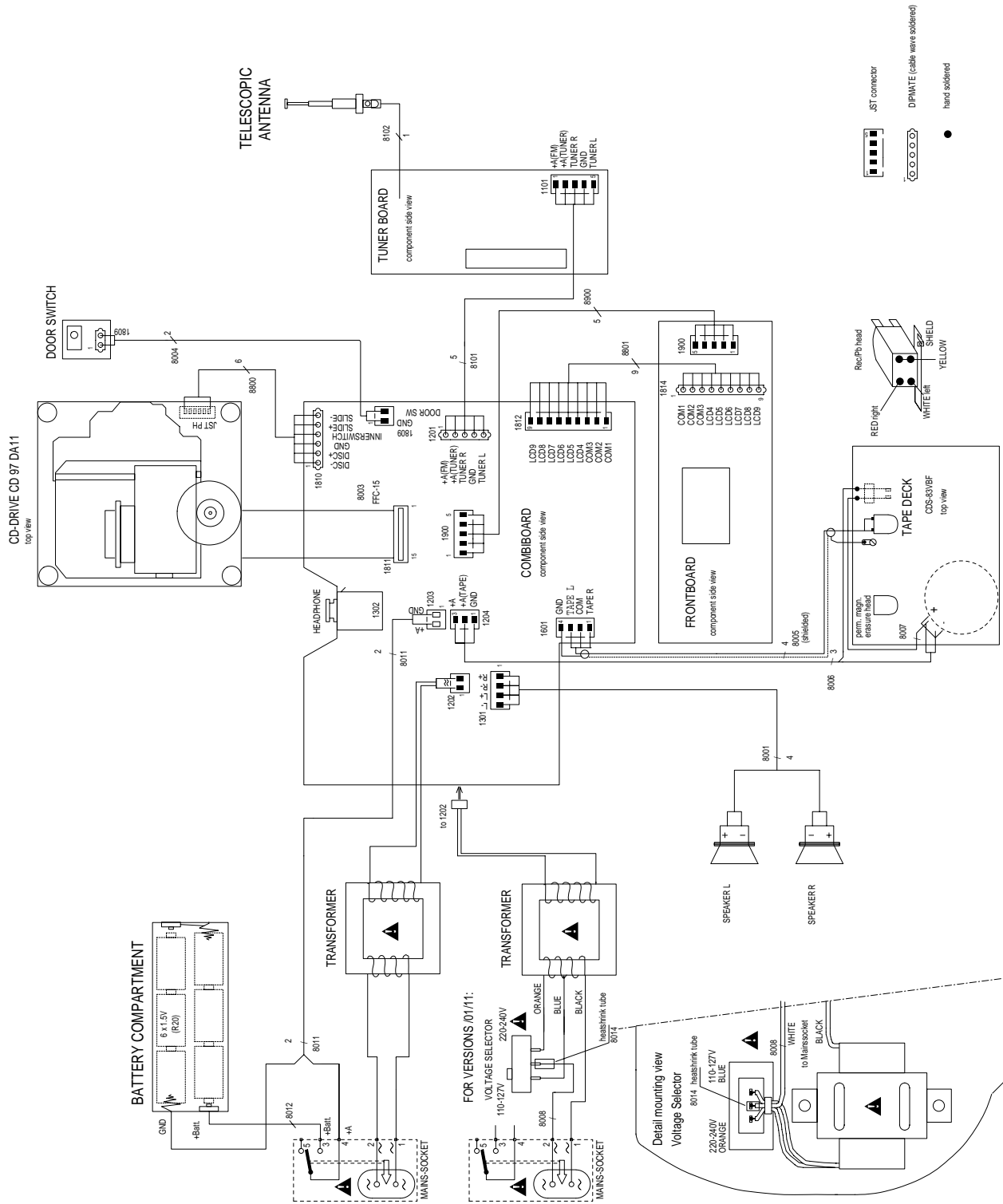

TUNER BOARD - CIRCUIT DIAGRAM

6-1

6-1

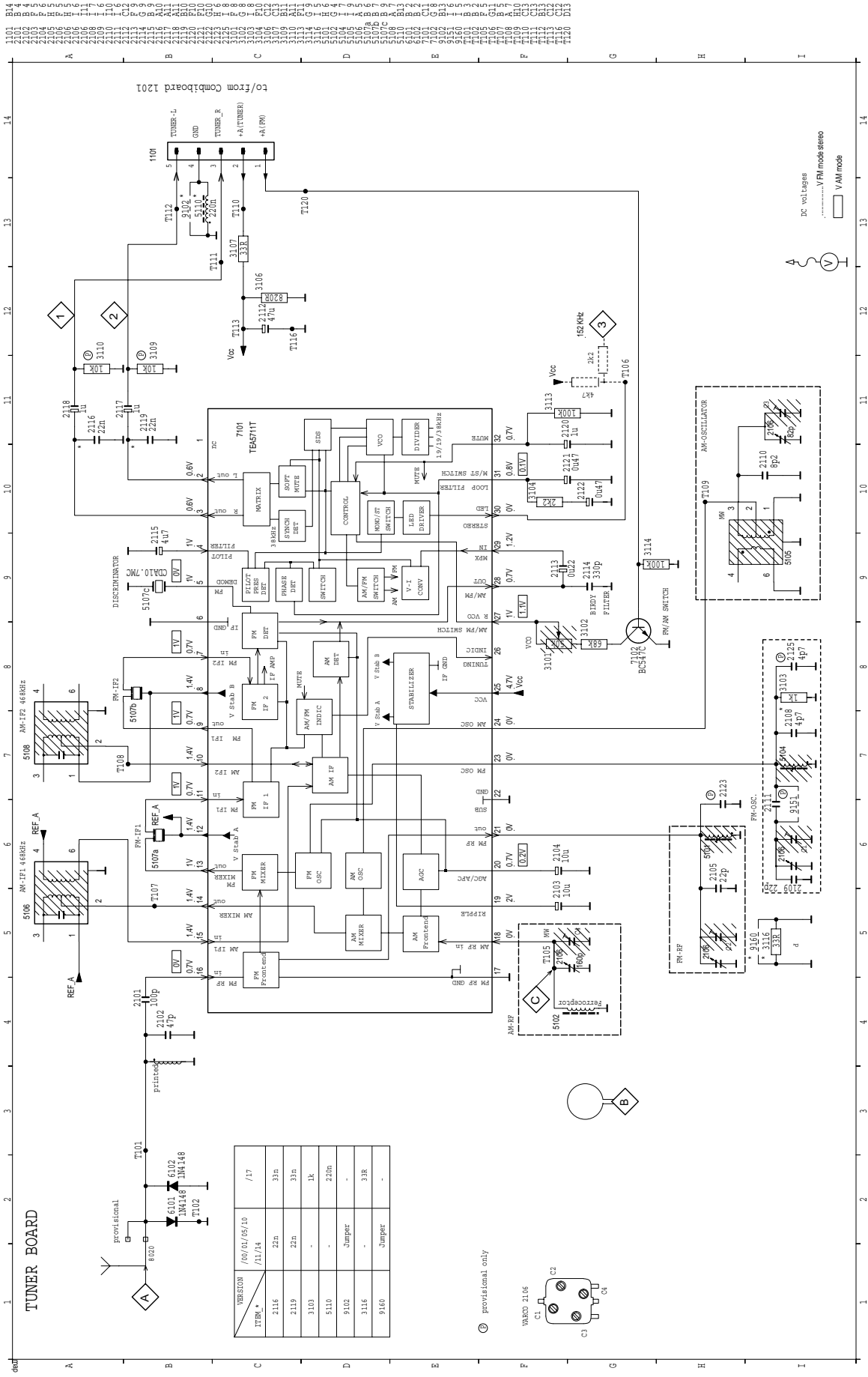

TUNER BOARD - LAYOUT DIAGRAM

- 1101 A 4 2106 A 3 2113 B 2 2119 B 4 3101 B 4 5104 B 2 5108 A 1 9101 B 2
- 2101 A 1 2108 B 3 2114 B 1 2120 B 1 3102 A 4 5105 B 3 5110 A 4 9102 A 4
- 2102 A 2 2109 A 3 2115 A 1 2121 B 1 3103 B 2 5106 A 1 6101 A 1 9150 A 1
- 2103 A 2 2110 B 3 2116 B 4 2122 B 1 3104 B 1 5107a A 1 6102 A 1 9151 B 3
- 2104 A 2 2111 B 3 2117 A 4 2123 A 2 3106 B 1 5107b A 1 7102 A 4
- 2105 A 2 2112 B 1 2118 A 4 2125 A 2 3107 B 4 5101 A 2 5107c B 1 8100 A 1

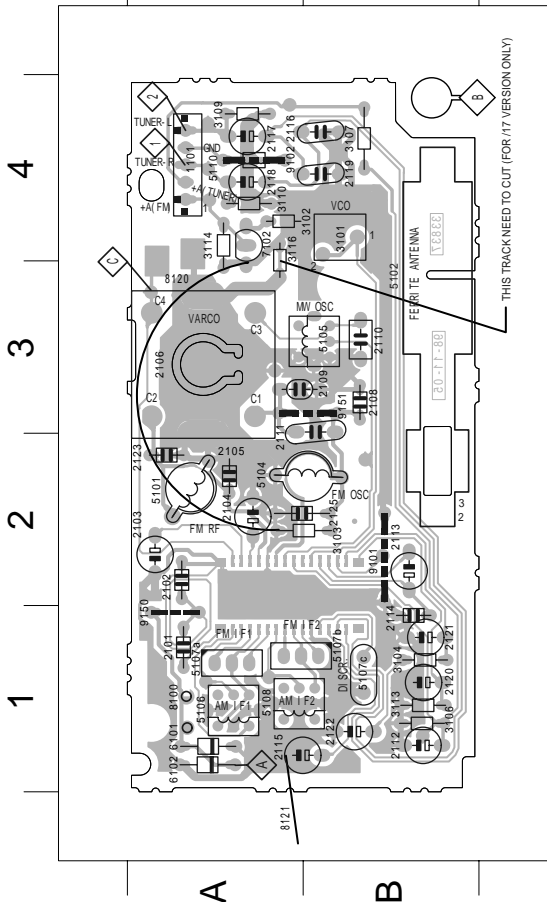

7101 A 2

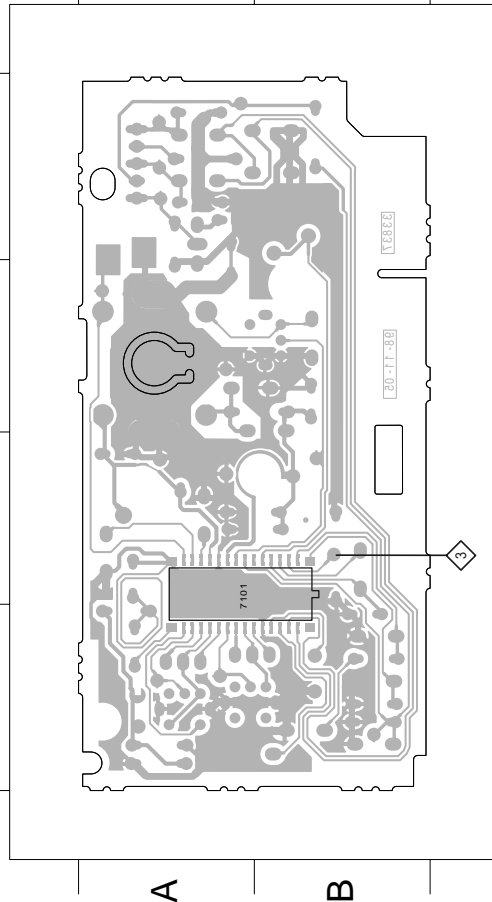

TUNER ADJUSTMENT TABLE

Waverange	Input Frequency	Input	Set tuned to	Adjust	Measure on	Scope / Counter
OSCILLATOR						
FM 87.5 - 108 MHz	87.35 MHz	A	lower band end	5104	1 or 2	
	108.25 MHz	f = ±500kHz V _{RF} = 100µV	upper band end	2106 C1	1 or 2	
MW 525 - 1607 kHz (530 - 1710 kHz) ¹⁾	512 kHz (520 kHz)	C	lower band end	5105	1 or 2	
	1635 kHz (1730 kHz)	f = ±30kHz V _{RF} = 100µV	upper band end	2106 C3	1 or 2	
FM - RF						
FM 87.5 - 108 MHz	87.5 MHz	A	87.5 MHz	5101	1 or 2	
	108 MHz	f = ±500kHz V _{RF} = 10µV	108 MHz	2106 C2	1 or 2	
VCO						
FM	98 MHz	A	98 MHz	3101	3	152 ±1 kHz
		continuous wave V _{RF} = 1 mV				
AM - IF						
AM	468 kHz	C	connect pin 24 of IC 7101 (AM Osc) with short wire to ground	5106	1 or 2	
		f = ±15kHz V _{RF} = 10mV		5108	1 or 2	
AM - RF						
MW	560 kHz	B	560 kHz	5102 (interceptor coil)	1 or 2	
	1500 kHz	f = ±30kHz V _{RF} as low as possible	1500 kHz	2106 C4	1 or 2	

repeat
¹⁾for USA /17
²⁾R-C-network serves for damping the IF-filter while adjusting the other one.

COMBI BOARD - CIRCUIT DIAGRAM
RECORDER / AMPLIFIER PART

7-1

7-1

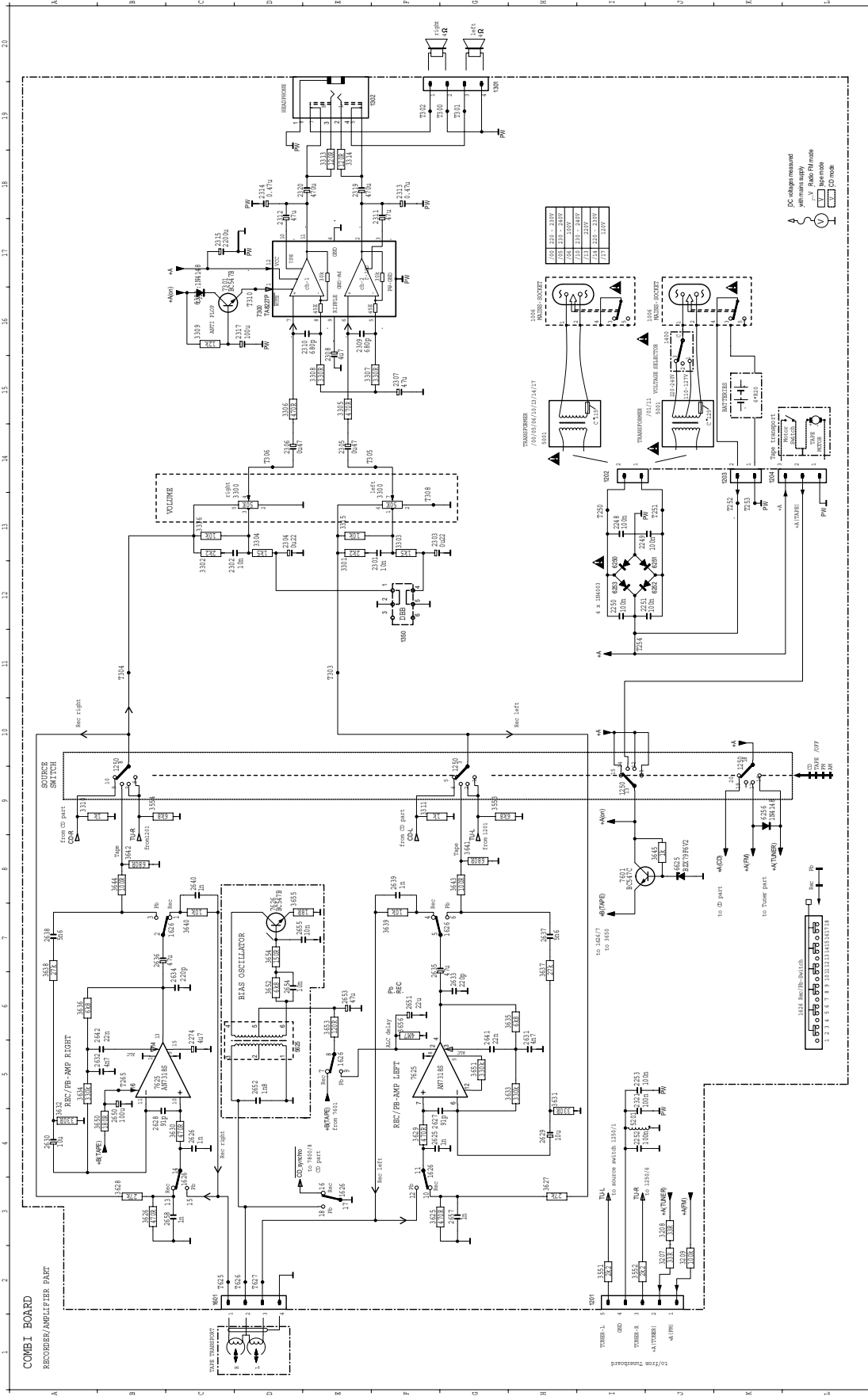

7-2
COMBI BOARD (AZ1050) - LAYOUT DIAGRAM

1 2 3 4 5 6 7

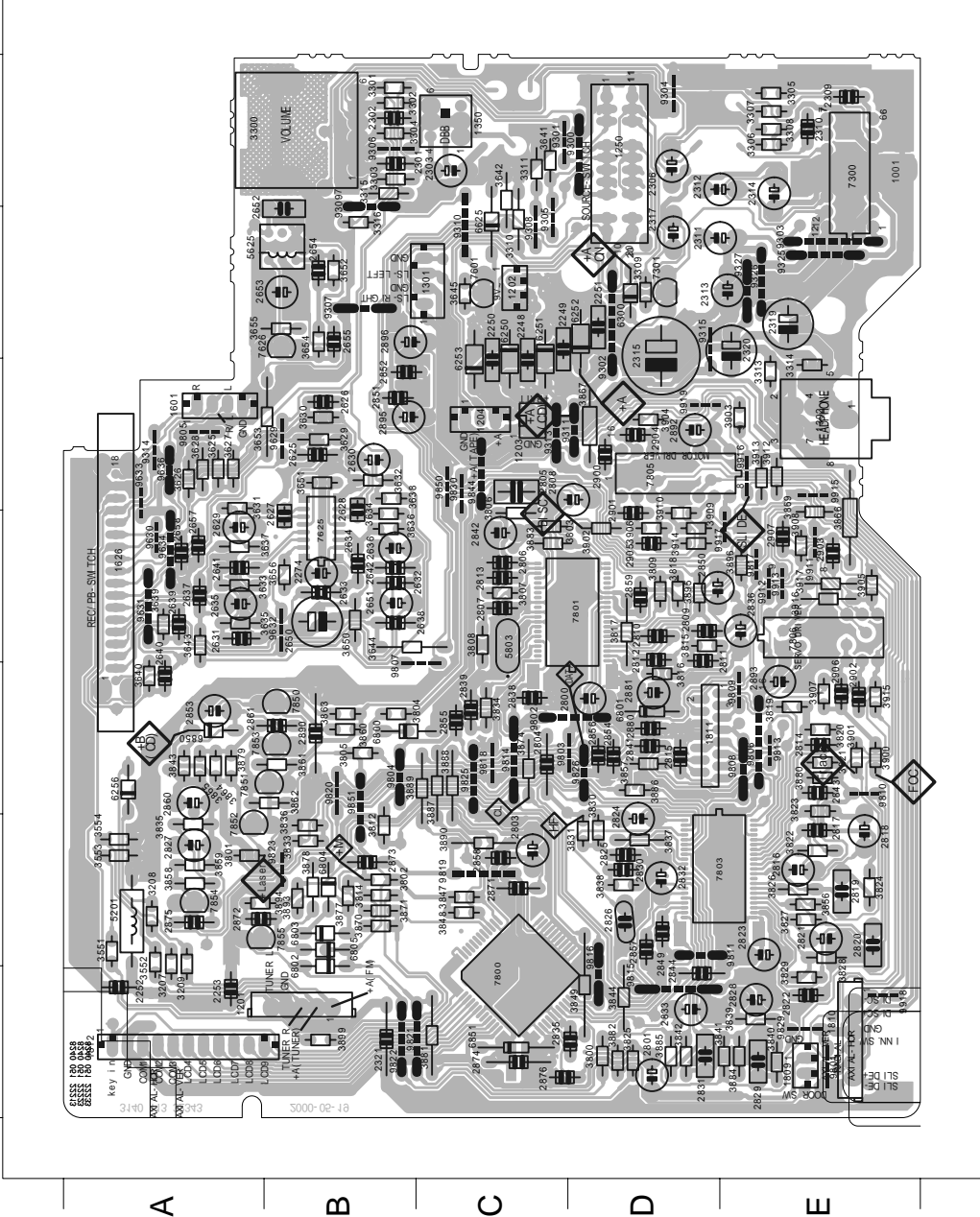

6250, 6251, 6252, 6253
 Mounted raised by
 silicon rubber sleeves



This assembly drawing shows a summary
 of all possible versions.
 For components used in a specific version
 see schematic diagram respectively partlist.

7-3
COMBI BOARD (AZ1050) - CIRCUIT DIAGRAM
 CD PART

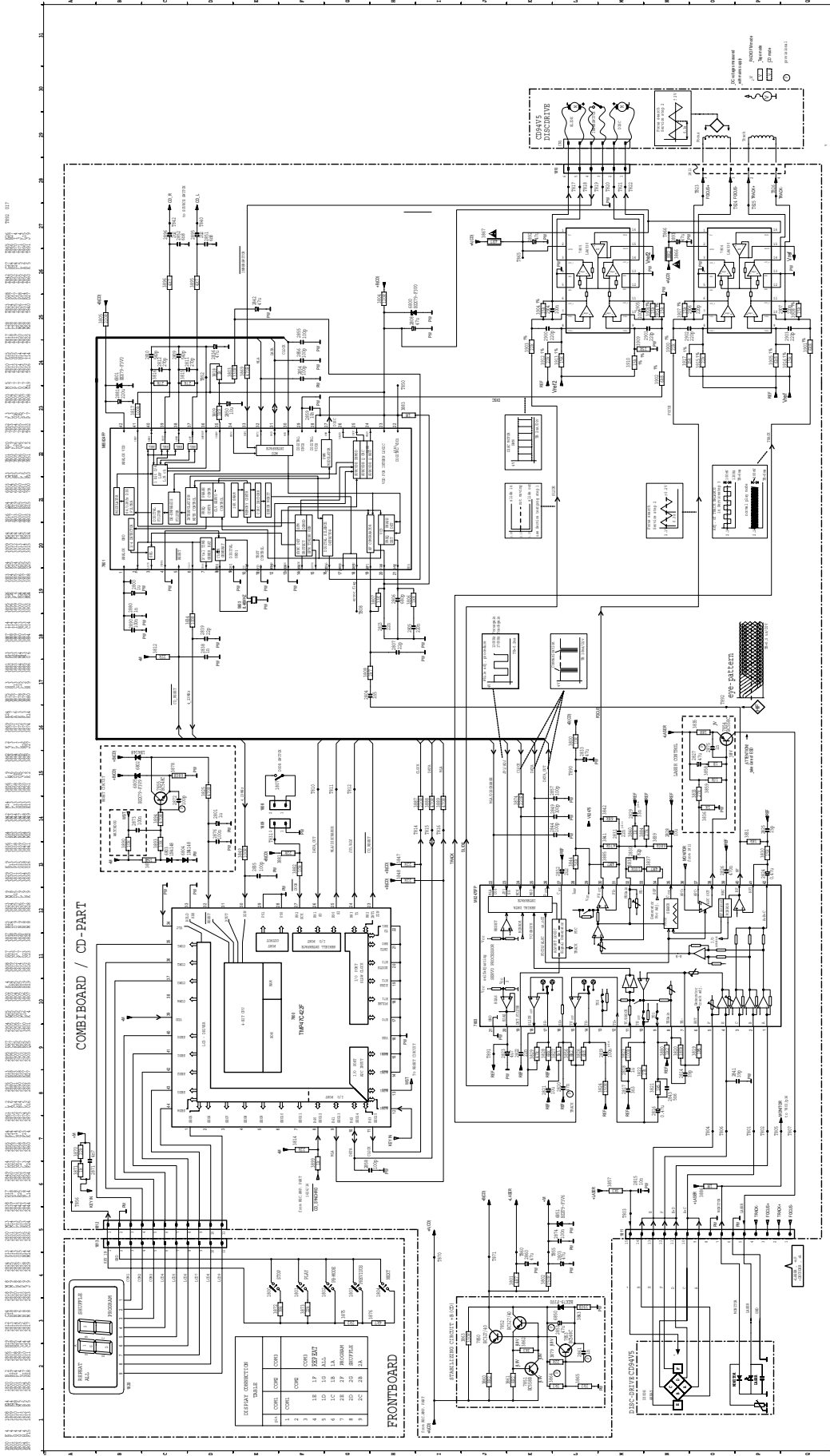

FRONT BOARD - CIRCUIT DIAGRAM

- | | | | | | | | |
|---------|---------|---------|---------|-----------|---------|---------|---------|
| 1800 E3 | 1813 A4 | 2903 D4 | 3873 E2 | 7901-A C1 | T401 A3 | T406 B3 | T411 C4 |
| 1801 E2 | 1814 C4 | 2904 C3 | 3875 E2 | 7901-B D1 | T402 A3 | T407 B3 | T412 C4 |
| 1802 E2 | 1900 C4 | 2905 D3 | 3876 E2 | 7901-C D3 | T403 B3 | T408 B3 | T413 C4 |
| 1803 E2 | 2901 C1 | 2906 D4 | 3901 C1 | 7901-D C2 | T404 B3 | T409 B3 | T414 D4 |
| 1804 E2 | 2902 C2 | 3872 E3 | 3902 D2 | 7902 A1 | T405 B3 | T410 C4 | T415 D4 |

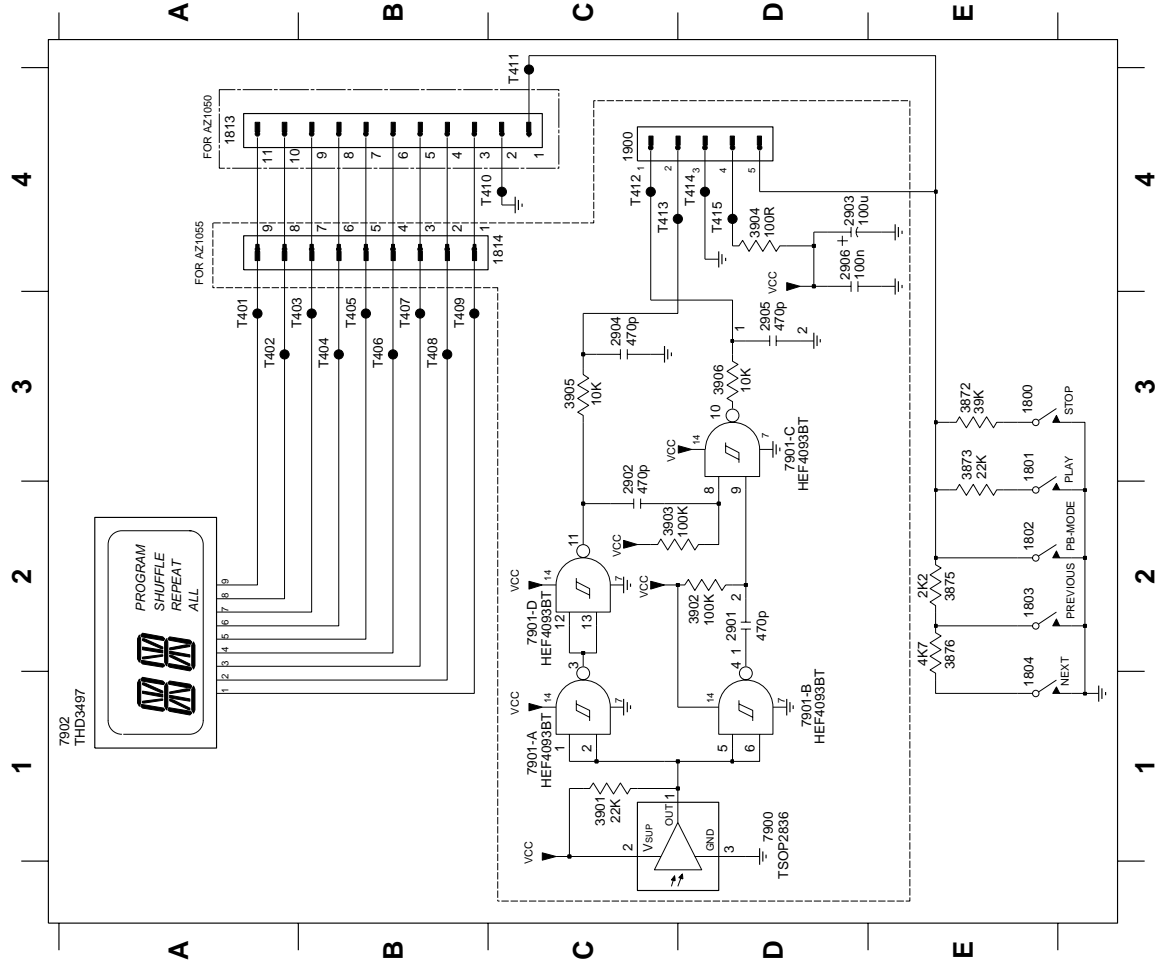

FRONT BOARD - LAYOUT DIAGRAM

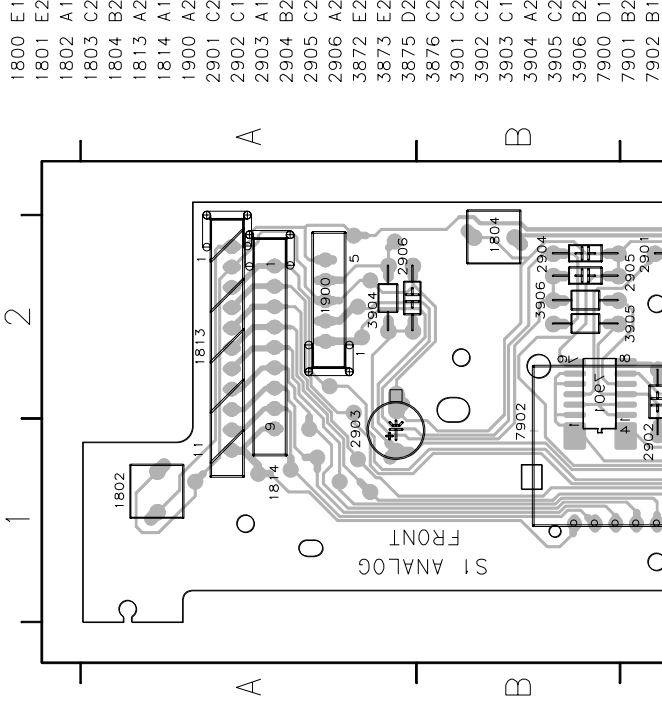

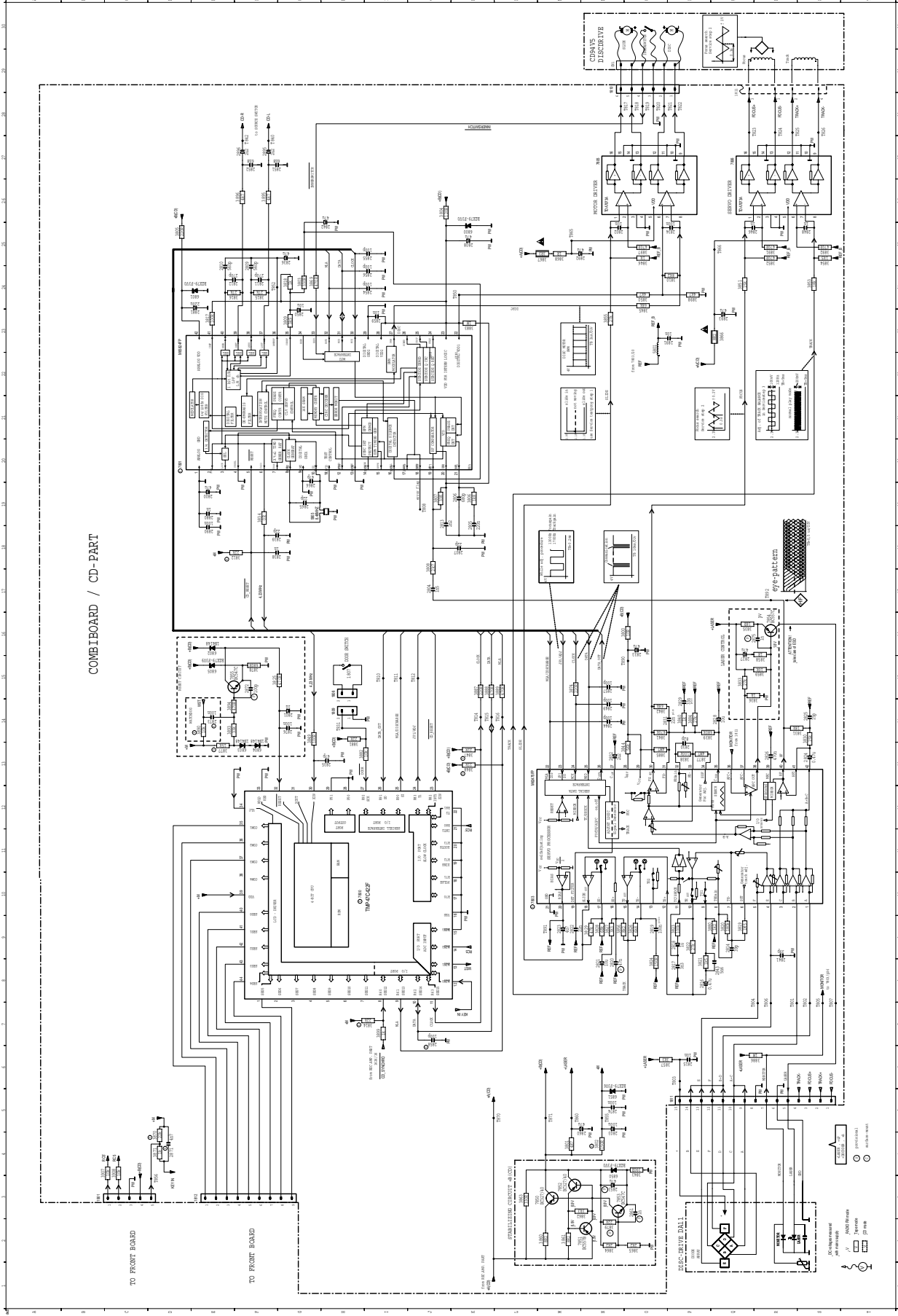

COMBI BOARD (AZ1055) - LAYOUT DIAGRAM

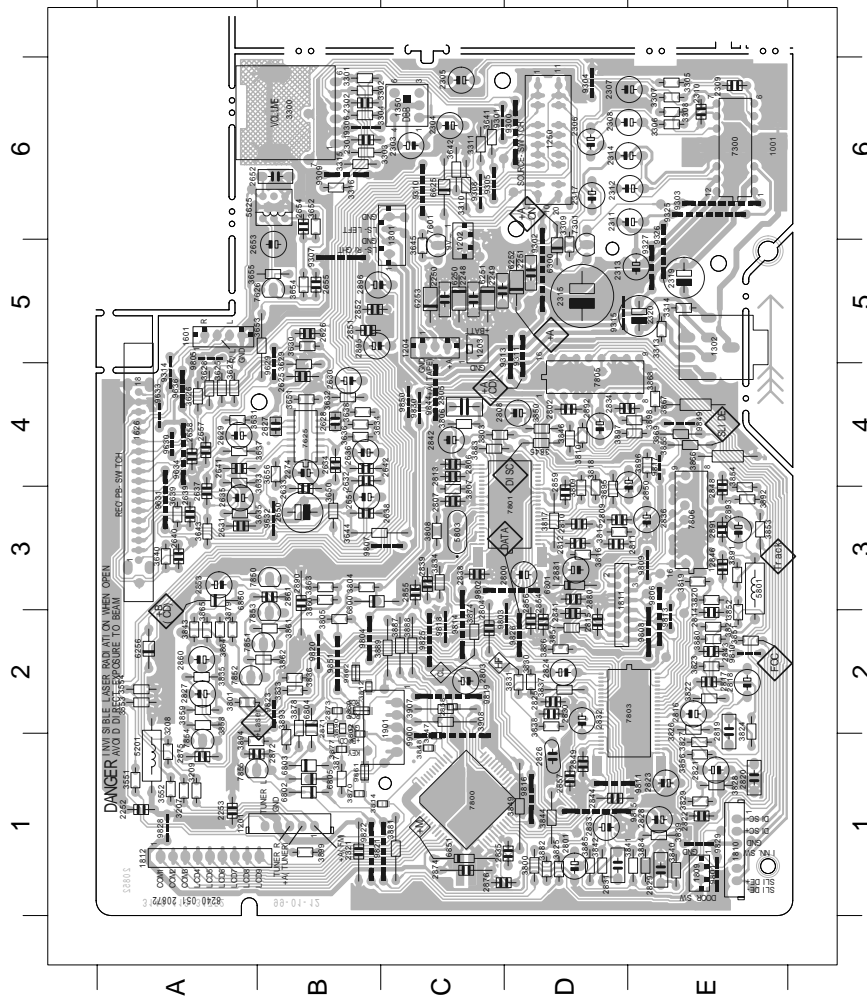

1201 B 1	2600 D 3	2891 E 3	3812 B 2	3854 D 1	9326 E 6
1202 C 5	2601 D 1	2892 D 4	3814 C 1	3856 D 2	9328 E 5
1203 C 5	2602 D 4	2893 D 3	3815 D 3	3858 C 2	9327 E 5
1204 C 5	2603 D 2	2894 E 3	3816 D 3	3860 C 2	9329 E 5
1205 D 6	2604 C 2	2895 B 2	3817 D 3	3862 C 2	9330 A 4
1301 C 6	2605 C 4	3207 A 1	3818 D 3	3863 B 2	9631 A 3
1302 E 5	2606 C 4	3208 A 1	3819 E 3	3864 E 3	9632 B 3
1303 E 5	2607 C 4	3209 E 3	3820 A 1	3865 E 3	9633 B 3
1304 E 5	2608 C 4	3210 E 3	3821 E 2	3866 B 1	9634 A 4
1601 A 5	2609 D 3	3301 B 6	3822 E 2	3868 A 1	9636 A 4
1626 A 4	2609 D 3	3302 B 6	3823 C 2	3868 D 3	9638 A 1
1609 E 1	2610 D 3	3302 B 6	3823 C 2	3869 D 3	9638 A 1
1610 E 1	2611 D 3	3303 B 6	3824 C 2	3870 D 3	9639 E 1
1811 D 3	2612 D 3	3304 B 6	3825 D 1	3871 E 4	9640 D 2
1812 A 1	2613 C 4	3305 E 6	3826 E 2	3898 E 4	9804 B 2
1813 D 3	2614 C 2	3306 E 6	3827 E 1	3899 E 4	9805 E 2
1901 C 2	2614 E 2	3306 E 6	3827 E 1	3899 E 4	9805 E 2
1902 C 2	2614 E 2	3306 E 6	3827 E 1	3899 E 4	9805 E 2
2249 C 5	2616 E 2	3308 E 6	3829 E 1	3904 C 2	9807 C 3
2250 C 5	2617 E 2	3309 D 5	3830 D 2	5201 A 1	9808 E 2
2251 A 1	2618 E 2	3310 E 6	3831 D 2	5201 A 1	9808 E 2
2252 A 1	2619 E 2	3311 E 6	3832 C 2	5201 A 1	9808 E 2
2253 A 1	2620 E 1	3313 E 5	3834 C 2	5603 C 3	9811 D 1
2274 B 4	2621 E 1	3314 E 5	3835 A 2	6250 C 5	9813 E 2
2275 B 4	2622 E 1	3315 E 5	3836 A 2	6250 C 5	9813 E 2
2276 B 4	2623 E 1	3316 E 6	3837 D 2	6252 C 5	9814 D 1
2302 B 6	2623 E 1	3316 E 6	3837 D 2	6252 C 5	9814 D 1
2303 C 6	2624 D 2	3551 A 1	3838 D 2	6253 C 5	9816 D 1
2304 C 6	2625 D 2	3552 A 1	3839 E 1	6254 A 2	9817 E 4
2305 C 6	2626 E 1	3552 A 1	3839 E 1	6254 A 2	9817 E 4
2306 D 6	2627 A 2	3554 A 2	3841 E 1	6252 C 6	9819 C 2
2307 E 6	2628 E 1	3625 A 4	3842 D 1	6600 B 3	9820 B 2
2308 E 6	2629 E 1	3626 A 4	3843 A 2	6601 D 3	9821 C 1
2309 E 6	2630 E 1	3627 A 4	3844 A 2	6602 D 3	9822 B 1
2310 E 6	2631 D 1	3628 A 4	3845 D 4	6603 B 1	9823 B 2
2311 E 6	2632 D 2	3629 B 4	3846 D 4	6604 B 2	9824 C 2
2312 E 6	2633 D 2	3630 B 4	3847 D 4	6605 B 2	9825 C 2
2313 E 5	2634 D 1	3631 C 4	3848 C 1	6651 C 1	9825 E 1
2314 E 6	2635 D 1	3632 B 4	3849 D 1	6651 C 1	9825 E 1
2315 D 5	2636 E 3	3633 A 4	3850 D 4	7500 E 6	9830 C 4
2316 D 5	2637 E 3	3634 A 4	3851 D 4	7501 C 5	9830 C 4
2317 E 5	2638 C 3	3635 B 3	3852 E 2	7601 C 5	9848 E 4
2320 E 5	2641 D 2	3636 B 4	3853 E 3	7624 B 4	9849 C 4
2321 B 1	2642 C 4	3637 A 4	3854 E 3	7624 B 4	9849 C 4
2322 B 1	2643 C 4	3638 A 4	3855 E 3	7624 B 4	9849 C 4
2605 B 5	2644 D 1	3639 C 3	3856 E 1	7601 D 3	9851 B 1
2627 B 4	2648 E 3	3640 A 3	3857 D 2	7603 E 2	9852 B 2
2628 B 4	2648 E 3	3641 C 3	3858 A 2	7605 D 4	9852 B 2
2629 B 4	2648 E 3	3642 C 3	3859 A 2	7605 D 4	9852 B 2
2630 B 4	2650 E 4	3643 A 3	3860 B 3	7650 B 3	9856 B 2
2631 A 3	2651 B 5	3644 B 3	3861 B 2	7651 B 2	9856 B 2
2632 B 5	2652 A 5	3645 B 3	3862 B 2	7652 B 2	9856 B 2
2633 B 5	2653 A 5	3646 B 3	3863 B 2	7653 B 2	9856 B 2
2634 B 4	2654 D 2	3651 B 4	3864 A 2	7654 A 1	9856 B 2
2635 A 3	2655 C 3	3652 B 6	3865 A 2	7655 A 1	9856 B 2
2636 B 3	2656 C 3	3653 B 6	3866 A 2	7656 A 1	9856 B 2
2637 A 3	2657 D 2	3654 B 5	3867 E 4	8300 C 6	9856 B 2
2638 B 3	2658 C 2	3655 B 5	3868 E 4	8302 D 5	9856 B 2
2639 A 3	2659 D 3	3656 B 4	3869 A 4	9003 E 6	9856 B 2
2640 A 3	2660 D 3	3657 B 4	3870 A 4	9003 E 6	9856 B 2
2641 A 4	2661 B 3	3801 A 2	3871 D 1	9003 E 6	9856 B 2
2642 B 4	2671 B 2	3802 B 1	3874 C 2	9006 B 6	9856 B 2
2643 B 4	2672 A 1	3803 C 4	3877 B 1	9007 D 5	9856 B 2
2644 B 4	2673 A 1	3804 C 4	3878 B 1	9007 D 5	9856 B 2
2645 B 4	2674 C 1	3805 B 2	3879 A 2	9009 B 6	9856 B 2
2653 B 5	2675 A 1	3806 C 4	3880 E 2	9310 C 6	9856 B 2
2654 B 5	2676 A 1	3807 C 4	3881 D 5	9311 D 5	9856 B 2
2655 B 5	2680 D 1	3809 C 3	3882 D 1	9314 A 4	9856 B 2
2657 A 4	2681 D 3	3809 D 3	3883 C 4	9314 A 4	9856 B 2
2658 A 4	2680 B 3	3810 D 4	3884 E 1	9315 D 5	9856 B 2

SCREW LIST

1. M2 x 5.5
2. M2.5 x 6
3. Torx 2 x 8
4. Torx 3 x 10
5. Torx 3 x 12
6. Torx 3 x 25
7. Torx 3 x 30
8. T P/W 3 x 16
9. Plus 2.6 x 10

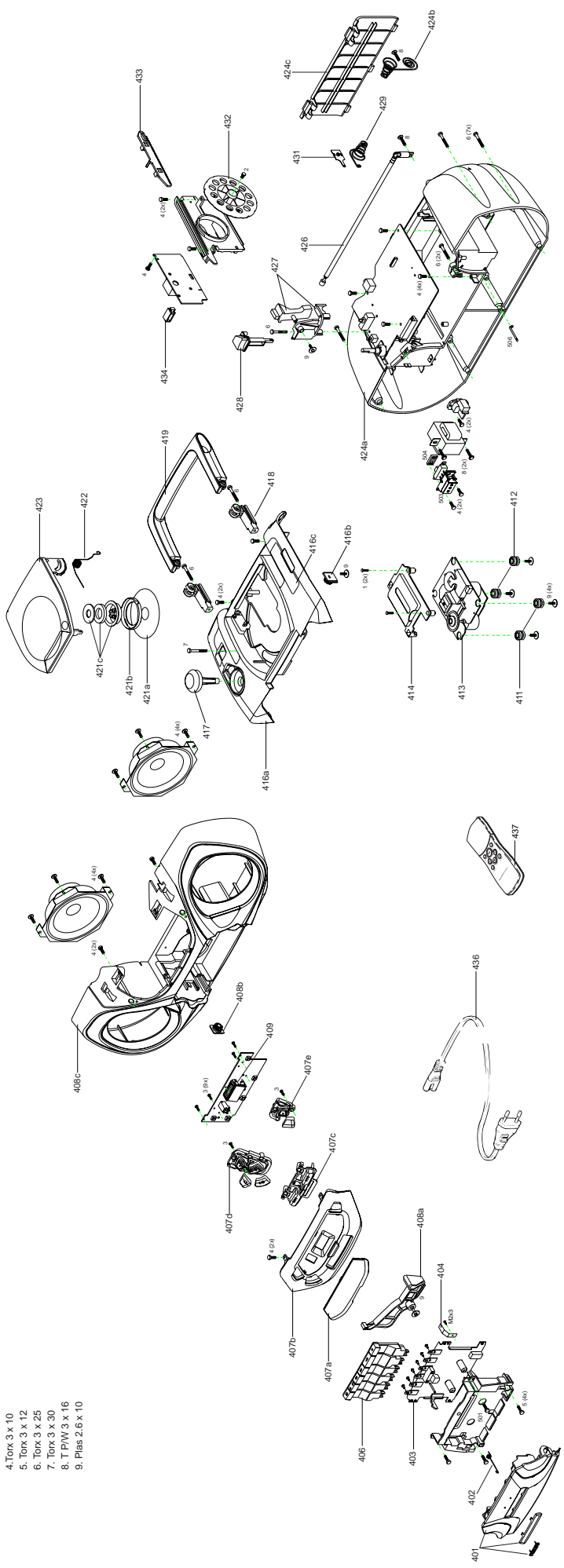

MECHANICAL PARTSLIST - CABINET

- 401 3140 117 60730 Cass Door Assy (For AZ1050)
- 401 3140 117 60800 Cass Door Assy (For AZ1055)
- 402 4822 492 42709 Cass Door Spring
- 403 4822 691 10612 Tape Deck Mechanism
- 404 4822 492 11061 Spring Recording
- 406 3140 114 36770 Keyset Cass
- 407 3140 117 60770 Front Panel Assy (For AZ1050)
- 407 3140 117 60810 Front Panel Assy (For AZ1055)
- 408 3140 117 60920 Front Cab Assy (For AZ1050)
- 408 3140 117 60700 Front Cab Assy (For AZ1055)
- 409 3140 114 30280 Bracket/LCD
- 411 4822 529 10387 Damper Rubber (40 DEG)
- 412 4822 529 10386 Damper Rubber (30 DEG)
- 413 3103 309 05290 CD/DA11N Drive Assy
- 414 4822 442 01096 Cover CD
- 416 3140 117 60860 Top Cabinet Assy (Not for -/17)
- 416 3140 117 60720 Top Cabinet Assy (For -/17)
- 417 3140 114 36780 Knob Volume
- 418 4822 402 10856 Bracket/Handle
- 419 3140 114 36790 Handle
- 421 3140 117 59800 Clamper Ring Assy
- 422 3140 111 00750 Spring CD
- 423 3140 114 37140 Door CD (For AZ1050)
- 423 3140 114 37220 Door CD (For AZ1055)
- 424 3140 117 60750 Rear Cabinet Assy
- 426 4822 303 14038 Telescopic Aerial
- 427 3140 117 60740 Knob Mode Assy
- 428 3140 117 60760 Knob DBB Assy
- 429 4822 492 51961 Spring Compression
- 431 3140 111 21360 Contact Plate
- 432 3140 114 36800 Wheel Tuning
- 433 3140 114 29800 Pointer
- 434 4822 256 90463 Ferrite Bar Holder
- 436 4822 321 10249 Mains Cord (For -/00/01/11/14)
- 436 2422 070 98148 Mains Cord (For -/10)
- 436 2422 070 98152 Mains Cord (For -/17)
- 437 3139 228 87280 Remote Control (For AZ1055)
- 3140 115 28230 Instr Manual (For AZ1055/00)
- 3140 115 28280 Instr Manual (For AZ1050/01/10/11)
- 3140 115 28240 Instr Manual (For AZ1050/14)
- 3140 115 28170 Instr Manual (For AZ1050/17)
- 3140 115 28250 Instr Manual (For AZ1055/00)
- 3140 115 28291 Instr Manual (For AZ1055/11)
- 3140 115 28260 Instr Manual (For AZ1055/14)
- 3140 115 28180 Instr Manual (For AZ1055/17)

Note: Only these parts mentioned in the list are normal service parts.

MECHANICAL PARTSLIST - TAPE DECK

- 10 4822 528 70849 Pinch Roller Arm (B)
- 11 4822 528 70695 Pinch Roller Assy
- 74 4822 403 70968 Eject Hook (A)
- 106 4822 358 31325 Main Belt 45.2 x 1.2
- 107 4822 358 31124 Sub Belt 44.7 x 1.2
- 110 4822 278 90721 Leaf Switch
- 111 4822 249 30218 MS18R-AKONI
- 112 4822 249 40306 E. Head
- 115 4822 361 21565 Motor EG-530AD-9B
- 116 4822 528 81497 Motor Pulley

Note: Only these parts mentioned in the list are normal service parts.

EXPLODED VIEW DIAGRAM - TAPE DECK

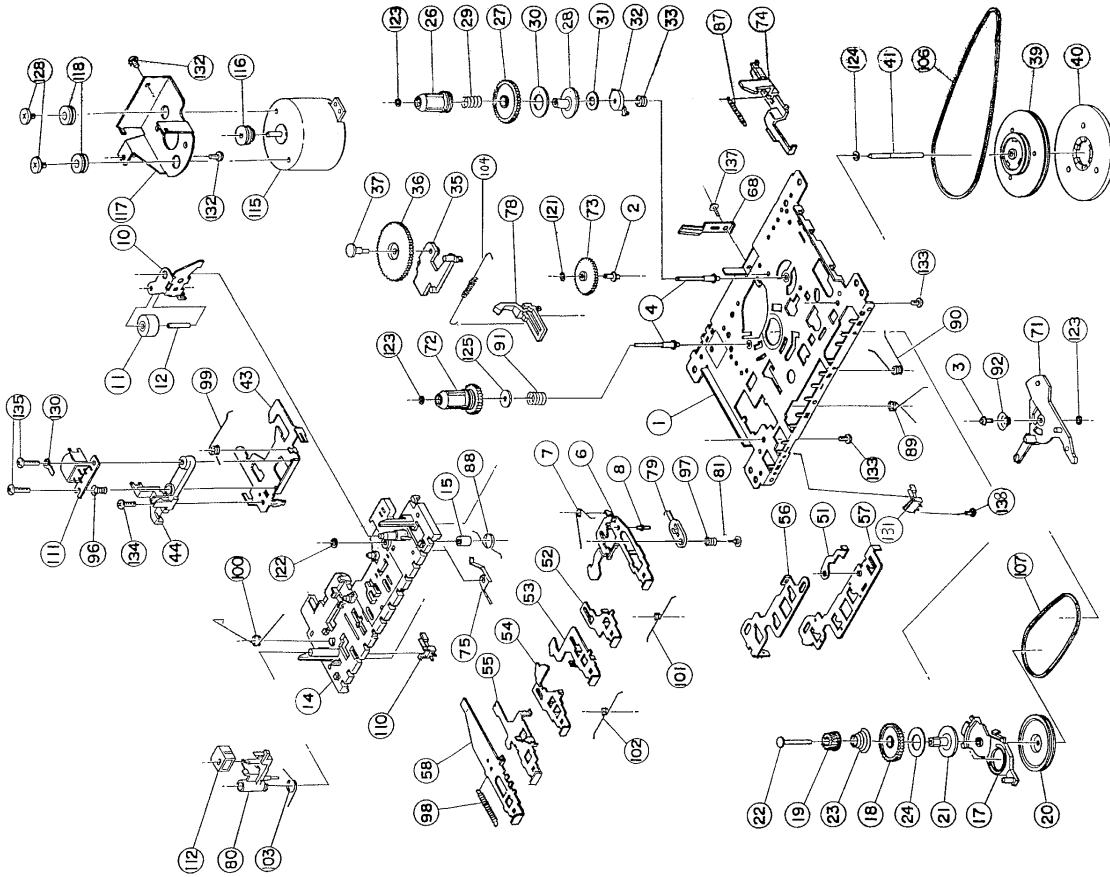

9-1
ELECTRICAL PARTSLIST - COMBI BOARD

- CAPACITORS -		- CAPACITORS -	
2101	4822 122 33195 100pF 10% 50V	2628	4822 126 13507 91pF 5% 50V
2102	4822 122 33848 47pF 5%SL 50V	2629	4822 124 40248 10uF 20% 63V
2103	4822 124 40248 10uF 20% 63V	2630	4822 124 40248 10uF 20% 63V
2104	4822 124 40248 10uF 20% 63V	2631	4822 121 43856 4.7nF 5% 250V
2105	4822 122 33191 22pF 5% 50V	2632	4822 121 43856 4.7nF 5% 250V
2106	4822 125 50681 Var Capacitor	2633	4822 122 10466 220pF 10% 50V
2108	4822 122 10465 4.7pF 10% 50V	2634	4822 122 10466 220pF 10% 50V
2109	4822 122 32147 22pF 2% N470 100V	2635	4822 124 40433 47uF 20% 25V
2110	4822 126 12229 8.2pF N750 50V	2636	4822 124 40433 47uF 20% 25V
2112	4822 124 40433 47uF 20% 25V	2637	4822 121 42469 5.6nF 5% 250V
2113	4822 124 40746 0.22uF 20% 63V	2638	4822 121 42469 5.6nF 5% 250V
2114	4822 126 12787 330pF 10% Y5V 50V	2639	4822 122 33197 1nF 10% 50V
2115	4822 124 40769 4.7uF 20% 100V	2640	4822 122 33197 1nF 10% 50V
2116	4822 121 41856 22nF 5% 250V	2641	4822 126 11585 22nF +80-20% Y5V 25V
2117	4822 124 21913 1uF 20% 63V	2642	4822 126 11585 22nF +80-20% Y5V 25V
2118	4822 124 21913 1uF 20% 63V	2650	4822 124 41584 100uF 20% 10V
2119	4822 121 41856 22nF 5% 250V	2651	4822 124 81151 22uF 50V
2120	4822 124 21913 1uF 20% 63V	2652	4822 121 10685 1.8nF 10% 50V
2121	4822 124 41407 0.47uF 20% 63V	2653	4822 124 40433 47uF 20% 25V
2122	4822 124 41407 0.47uF 20% 63V	2654	4822 121 51387 10nF 20% 16V
2125	2020 561 90063 2.2pF 10% 50V	2655	4822 121 51387 10nF 20% 16V
2248	5322 121 42386 100nF 5% 63V	2657	4822 122 33197 1nF 10% 50V
2249	5322 121 42386 100nF 5% 63V	2658	4822 122 33197 1nF 10% 50V
2250	5322 121 42386 100nF 5% 63V	2800	4822 124 21913 1uF 20% 63V
2251	5322 121 42386 100nF 5% 63V	2801	4822 124 21913 1uF 20% 63V
2252	2020 561 90365 100nF +80-20% 50V	2802	4822 121 51387 10nF 20% 16V
2253	2020 561 90365 100nF +80-20% 50V	2803	4822 124 40433 47uF 20% 25V (For Z1050)
2274	4822 124 40769 4.7uF 20% 100V	2803	4822 124 41584 100uF 20% 10V (For AZ1055)
2301	4822 121 51387 10nF 20% 16V	2804	4822 126 12878 1.5nF 10% 16V
2302	4822 121 51387 10nF 20% 16V	2805	4822 121 42408 220nF 5% 63V
2303	4822 124 40746 0.22uF 20% 63V	2806	4822 126 14316 680pF 10% 50V Y5P
2304	4822 124 40746 0.22uF 20% 63V	2807	4822 122 33191 22pF 5% 50V
2305	4822 124 41407 0.47uF 20% 63V	2808	4822 124 40433 47uF 20% 25V
2306	4822 124 41407 0.47uF 20% 63V	2809	4822 122 10459 560pF 10% 50V
2307	4822 124 40433 47uF 20% 25V	2810	4822 122 10459 560pF 10% 50V
2308	4822 124 40769 4.7uF 20% 100V	2811	4822 126 12702 270pF 10% Y5P 50V
2309	4822 126 14316 680pF 10% 50V Y5P	2812	4822 126 12702 270pF 10% Y5P 50V
2310	4822 126 14316 680pF 10% 50V Y5P	2813	4822 126 12339 2.2nF 10% Y5R
2311	4822 124 40433 47uF 20% 25V	2814	4822 126 13677 39pF 5% 50V
2312	4822 124 40433 47uF 20% 25V	2815	4822 121 51387 10nF 20% 16V
2313	4822 124 41407 0.47uF 20% 63V	2816	4822 124 41407 0.47uF 20% 63V
2314	4822 124 41407 0.47uF 20% 63V	2817	4822 122 10577 3.3nF 10% 16V
2315	4822 123 14025 2200uF 20% 16V	2818	4822 124 21913 1uF 20% 63V
2317	4822 124 40207 100uF 20% 25V	2819	5322 121 42386 100nF 5% 63V
2319	4822 124 80195 470uF 20% 10V	2821	4822 124 40248 10uF 20% 63V
2320	4822 124 80195 470uF 20% 10V	2822	4822 126 11585 22nF +80-20% Y5V 25V
2321	2020 561 90365 100nF +80-20% 50V	2823	4822 124 40769 4.7uF 20% 100V
2625	4822 122 33197 1nF 10% 50V	2824	4822 124 41407 0.47uF 20% 63V
2626	4822 122 33197 1nF 10% 50V	2825	4822 122 10462 15pF 5% NPO
2627	4822 126 13507 91pF 5% 50V	2826	4822 121 51252 470nF 5% 63V

9-1
ELECTRICAL PARTSLIST - COMBI BOARD

- CAPACITORS -		- RESISTORS -	
2827	4822 124 40433 47uF 20% 25V	3101	4822 100 20167 VR 50K 30% 0.1W
2828	4822 124 40248 10uF 20% 63V	3102	4822 116 52297 68K 5% 0.5W
2829	5322 121 42489 33nF 5% 250V	3104	4822 116 52256 2K2 5% 0.5W
2830	4822 122 10319 82pF 5% 50V	3106	4822 116 52231 820R 5% 0.5W
2831	4822 121 41856 22nF 5% 250V	3107	4822 116 52191 33R 5% 0.5W
2832	4822 124 22652 2.2uF 20% 50V	3113	4822 116 52234 100K 5% 0.5W
2833	4822 124 40433 47uF 20% 25V	3114	4822 116 52234 100K 5% 0.5W
2834	2020 561 90365 100nF +80-20% 50V	3207	4822 116 52191 33R 5% 0.5W
2835	4822 122 33195 100pF 10% 50V	3208	4822 116 52191 33R 5% 0.5W
2836	4822 124 40433 47uF 20% 25V	3209	4822 116 52234 100K 5% 0.5W
2838	4822 122 33197 1nF 10% 50V	3300	4822 101 11826 VR 50K 20% 0.025W
2839	4822 122 33191 22pF 5% 50V	3301	4822 116 52256 2K2 5% 0.5W
2841	4822 126 13677 39pF 5% 50V	3302	4822 116 52256 2K2 5% 0.5W
2842	4822 124 40433 47uF 20% 25V	3303	4822 116 52243 1K5 5% 0.5W
2843	4822 126 13098 5.6nF 20% 16V	3304	4822 116 52243 1K5 5% 0.5W
2844	4822 122 33195 100pF 10% 50V	3305	4822 116 83883 470R 5% 0.5W
2846	4822 122 33197 1nF 10% 50V	3306	4822 116 83883 470R 5% 0.5W
2848	4822 122 33197 1nF 10% 50V	3307	4822 116 52219 330R 5% 0.5W
2849	4822 122 33195 100pF 10% 50V	3308	4822 116 52219 330R 5% 0.5W
2850	4822 124 40248 10uF 20% 63V	3309	4822 116 52238 12K 5% 0.5W
2851	4822 126 13312 6.8nF 20% Y5R 16V	3310	4822 050 11002 1K 1% 0.4W
2852	4822 126 13312 6.8nF 20% Y5R 16V	3311	4822 050 11002 1K 1% 0.4W
2854	4822 122 33195 100pF 10% 50V	3313	4822 116 52206 120R 5% 0.5W
2855	4822 122 33195 100pF 10% 50V	3314	4822 116 52206 120R 5% 0.5W
2856	4822 122 33195 100pF 10% 50V	3315	4822 050 21003 10K 1% 0.6W
2857	4822 122 33195 100pF 10% 50V	3316	4822 050 21003 10K 1% 0.6W
2858	4822 122 33195 100pF 10% 50V	3551	4822 116 52256 2K2 5% 0.5W
2859	4822 121 51387 10nF 20% 16V	3552	4822 116 52256 2K2 5% 0.5W
2860	4822 124 40433 47uF 20% 25V	3553	4822 116 83961 6K8 5%
2871	4822 126 11714 4.7nF 20%	3554	4822 116 83961 6K8 5%
2873	2020 561 90365 100nF +80-20% 50V	3625	4822 116 83883 470R 5% 0.5W
2874	2020 561 90365 100nF +80-20% 50V	3626	4822 116 83883 470R 5% 0.5W
2876	2020 561 90365 100nF +80-20% 50V	3627	4822 116 52264 27K 5% 0.5W
2880	4822 122 33197 1nF 10% 50V	3628	4822 116 52264 27K 5% 0.5W
2881	4822 124 11912 220uF 20% 6.3V	3629	4822 116 83883 470R 5% 0.5W
2890	2020 561 90365 100nF +80-20% 50V	3630	4822 116 83883 470R 5% 0.5W
2891	4822 121 51387 10nF 20% 16V	3631	4822 116 52219 330R 5% 0.5W
2892	4822 124 40433 47uF 20% 25V	3632	4822 116 52219 330R 5% 0.5W
2893	4822 124 40433 47uF 20% 25V	3633	4822 116 52272 330K 5% 0.5W
2895	4822 124 22652 2.2uF 20% 50V	3634	4822 116 52272 330K 5% 0.5W
2896	4822 124 22652 2.2uF 20% 50V	3635	4822 116 83961 6K8 5%
2900	4822 122 10466 220pF 10% 50V	3636	4822 116 83961 6K8 5%
2901	4822 122 10466 220pF 10% 50V	3637	4822 116 52264 27K 5% 0.5W
2902	4822 122 10466 220pF 10% 50V	3638	4822 116 52264 27K 5% 0.5W
2903	4822 122 10466 220pF 10% 50V	3639	4822 050 21003 10K 1% 0.6W
2904	2020 561 90365 100nF +80-20% 50V	3640	4822 050 21003 10K 1% 0.6W
2905	2020 561 90365 100nF +80-20% 50V	3641	4822 116 52228 680R 5% 0.5W
2906	4822 122 10466 220pF 10% 50V	3642	4822 116 52228 680R 5% 0.5W
2907	4822 122 10466 220pF 10% 50V	3643	4822 116 52175 100R 5% 0.5W
		3644	4822 116 52175 100R 5% 0.5W

ELECTRICAL PARTSLIST - COMBI BOARD**- RESISTORS -**

3645	4822 050 11002	1K	1%	0,4W
3650	4822 116 52213	180R	5%	0,5W
3651	4822 116 52272	330K	5%	0,5W
3652	4822 116 83961	6K8	5%	
3653	4822 116 52206	120R	5%	0,5W
3654	4822 116 83868	150R	5%	0,5W
3655	4822 116 52184	18R	5%	0,5W
3656	4822 111 30893	4M7	5%	0,2W
3800	4822 116 52176	10R	5%	0,5W
3801	4822 050 24708	4R7	1%	0,6W
3802	4822 116 83868	150R	5%	0,5W
3803	4822 116 52219	330R	5%	0,5W
3804	4822 116 52206	120R	5%	0,5W
3805	4822 116 83872	220R	5%	0,5W
3806	4822 116 52249	1K8	5%	0,5W
3807	4822 050 23303	33K	1%	0,6W
3808	4822 116 52263	2K7	5%	0,5W
3809	4822 116 52276	3K9	5%	0,5W
3810	4822 116 52303	8K2	5%	0,5W
3812	4822 116 52257	22K	5%	0,5W
3814	4822 116 52257	22K	5%	0,5W
3815	4822 116 52264	27K	5%	0,5W
3816	4822 116 52264	27K	5%	0,5W
3817	4822 116 52234	100K	5%	0,5W
3818	4822 050 11002	1K	1%	0,4W
3819	4822 117 11825	1M5	5%	
3820	4822 116 52252	180K	5%	0,5W
3821	4822 116 52243	1K5	5%	0,5W
3822	4822 116 52264	27K	5%	0,5W
3823	4822 116 52234	100K	5%	0,5W
3824	4822 116 83868	150R	5%	0,5W
3825	4822 116 83883	470R	5%	0,5W
3826	4822 116 83961	6K8	5%	
3827	4822 116 52269	3K3	5%	0,5W
3828	4822 116 52297	68K	5%	0,5W
3829	4822 116 83884	47K	5%	0,5W
3830	4822 116 52244	15K	5%	0,5W
3831	4822 116 52251	18K	5%	0,5W
3833	4822 116 52264	27K	5%	0,5W
3834	4822 116 52175	100R	5%	0,5W
3835	4822 116 52184	18R	5%	0,5W
3836	4822 050 11002	1K	1%	0,4W
3837	4822 111 30893	4M7	5%	0,2W
3838	4822 116 52234	100K	5%	0,5W
3839	4822 116 52298	680K	5%	0,5W
3840	4822 050 11002	1K	1%	0,4W
3841	4822 116 52285	470K	5%	0,5W
3842	4822 116 52297	68K	5%	0,5W
3843	4822 116 83881	390R	5%	0,5W
3844	4822 116 52291	56K	5%	0,5W

- RESISTORS -

3847	4822 116 52257	22K	5%	0,5W
3848	4822 116 52257	22K	5%	0,5W
3849	4822 116 52175	100R	5%	0,5W
3850	4822 116 52283	4K7	5%	0,5W
3851	4822 116 52244	15K	5%	0,5W
3852	4822 116 83883	470R	5%	0,5W
3853	4822 116 52251	18K	5%	0,5W
3854	4822 116 52243	1K5	5%	0,5W
3855	4822 116 52264	27K	5%	0,5W
3856	4822 116 52303	8K2	5%	0,5W
3857	4822 116 52269	3K3	5%	0,5W
3858	4822 116 80176	1R	5%	0,5W
3859	4822 050 21003	10K	1%	0,6W
3860	4822 117 12798	8R2	5%	0,25W
3861	4822 117 12798	8R2	5%	0,25W
3862	4822 116 52269	3K3	5%	0,5W
3863	4822 116 52219	330R	5%	0,5W
3864	4822 116 52256	2K2	5%	0,5W
3865	4822 116 52256	2K2	5%	0,5W
3866	4822 052 10828	8R2	5%	0,33W
3867	4822 052 10478	4R7	5%	0,33W
3869	4822 116 83883	470R	5%	0,5W
3870	4822 116 52257	22K	5%	0,5W
3871	4822 050 11002	1K	1%	0,4W
3874	4822 116 83872	220R	5%	0,5W
3877	4822 116 52244	15K	5%	0,5W
3878	4822 116 52228	680R	5%	0,5W
3880	4822 116 52207	1K2	5%	0,5W
3881	4822 116 52257	22K	5%	0,5W
3882	4822 050 21003	10K	1%	0,6W
3883	4822 116 83866	1M	5%	0,5W
3884	4822 116 52264	27K	5%	0,5W
3885	4822 111 30893	4M7	5%	0,2W
3886	4822 116 83866	1M	5%	0,5W
3887	4822 116 83872	220R	5%	0,5W
3888	4822 116 83883	470R	5%	0,5W
3889	4822 116 83883	470R	5%	0,5W
3890	4822 050 21003	10K	1%	0,6W
3891	4822 116 83883	470R	5%	0,5W
3892	4822 116 83883	470R	5%	0,5W
3893	4822 050 23303	33K	1%	0,6W
3894	4822 116 83883	470R	5%	0,5W
3895	4822 116 52283	4K7	5%	0,5W
3896	4822 116 52283	4K7	5%	0,5W
3897	4822 116 83883	470R	5%	0,5W
3898	4822 116 52283	4K7	5%	0,5W
3899	4822 050 11002	1K	1%	0,4W
3900	4822 050 12203	22K	1%	0,4W
3901	4822 050 16802	6K8	1%	0,4W
3902	4822 050 16802	6K8	1%	0,4W

ELECTRICAL PARTSLIST - COMBI BOARD**- RESISTORS -**

3903	4822 050 12203	22K	1%	0,4W
3904	4822 050 11503	15K	1%	0,4W
3905	4822 050 16802	6K8	1%	0,4W
3906	4822 050 11503	15K	1%	0,4W
3907	4822 050 11503	15K	1%	0,4W (For AZ1050)
3907	4822 050 21003	10K	1%	0,6W (For AZ1055)
3908	4822 050 11503	15K	1%	0,4W (For AZ1050)
3908	4822 050 21003	10K	1%	0,6W (For AZ1055)
3909	4822 050 11503	15K	1%	0,4W
3910	4822 050 11503	15K	1%	0,4W
3912	4822 050 12203	22K	1%	0,4W
3913	4822 050 11503	15K	1%	0,4W
3914	4822 050 11503	15K	1%	0,4W
3915	4822 050 12203	22K	1%	0,4W
3916	4822 050 11503	15K	1%	0,4W
3917	4822 050 11503	15K	1%	0,4W
9860	4822 051 20008	Jumper		
9861	4822 051 20008	Jumper		
9862	4822 051 20008	Jumper		

-COILS & FILTERS -

5101	4822 157 70513	Coil FM
5102	2422 535 94985	Coil 64µH 5%
5104	4822 157 11843	Coil MD7B-01F
5105	4822 157 71145	Coil 270µH
5106	4822 157 70499	Coil IFT AM
5107	4822 242 81154	Filter KMFC5058-Z
5108	4822 156 11146	Coil IFT AM
5201	4822 157 70826	Coil 2,4µH
5625	4822 157 10371	Coil Var 100kHz
5801	4822 157 70826	Coil 2,4µH
5803	4822 242 73557	Filter CST8,46MTW-TF01

-DIODES -

6101	4822 130 30621	Diode 1N4148
6102	4822 130 30621	Diode 1N4148
6250	4822 130 31878	Diode 1N4003G
6251	4822 130 31878	Diode 1N4003G
6252	4822 130 31878	Diode 1N4003G
6253	4822 130 31878	Diode 1N4003G
6256	4822 130 30621	Diode 1N4148
6300	4822 130 30621	Diode 1N4148
6625	4822 130 34167	Diode BZX79-B6V2
6800	4822 130 31881	Diode BZX79-B3V0
6801	4822 130 31881	Diode BZX79-B3V0
6802	4822 130 30621	Diode 1N4148
6803	4822 130 30621	Diode 1N4148
6804	4822 130 30621	Diode 1N4148
6805	3198 010 53980	Diode BZX79-B3V9

-DIODES -

6850	4822 130 31881	Diode BZX79-B3V0
6851	5322 130 34834	Diode BZX79-C3V6

-IC & TRANSISTORS -

7101	4822 209 32746	IC TEA5711T/N2
7102	4822 130 44503	Trans BC547C
7300	4822 209 31544	IC TA8227P
7301	4822 130 40959	Trans BC547B
7601	4822 130 44503	Trans BC547C
7625	9322 140 00668	IC AN7323S (For AZ1050)
7625	4822 209 32918	IC AN7318S (For AZ1055)
7626	4822 130 40959	Trans BC547B
7800	4822 209 15932	IC TMP47C422F (For AZ1050)
7800	4822 209 17363	IC TMP47C422F (For AZ1055)
7801	4822 209 16076	IC M65824FP/ES5.0
7803	4822 209 90496	IC M62475FP
7805	4822 209 32636	IC LA6531 (For AZ1050)
7805	4822 209 32852	IC TDA7073A/N2 (For AZ1055)
7806	4822 209 32636	IC LA6531 (For AZ1050)
7806	4822 209 32852	IC TDA7073A/N2 (For AZ1055)
7850	9322 003 63676	Trans TBC327-40
7851	4822 130 44568	Trans BC557B
7852	9322 003 63676	Trans TBC327-40
7853	4822 130 44503	Trans BC547C
7854	4822 130 42231	Trans BC557C
7855	4822 130 44503	Trans BC547C

-MISCELLANEOUS -

1002	4822 240 10248	Loudspeaker 4 Ohm 6 W
1003	4822 240 10248	Loudspeaker 4 Ohm 6 W
1006	4822 265 20318	Mains Socket
1007	△ 4822 277 21794	Volt Selector (For -/01/11)
1102	2422 549 44211	Ferrite Bar 5x13x55
1250	4822 277 11739	Slide Switch
1302	2422 026 05076	Headphone Socket
1350	4822 276 12648	Push Switch
1626	4822 277 11504	Push Switch
1807	4822 276 13963	CD Door Switch
5001	△ 3140 118 32680	Transformer (For -/00/14)
5001	△ 4822 146 10875	Transformer (For -/01/11)
5001	△ 3140 118 32690	Transformer (For -/10)
5001	△ 3140 118 32700	Transformer (For -/17)
8003	4822 320 12637	Flexible Foil 15P

Note: Only these parts mentioned in the list are normal service parts.

ELECTRICAL PARTSLIST - FRONT BOARD**- CAPACITORS -**

2901	4822 122 33519	470pF	10%	50V
2902	4822 122 33519	470pF	10%	50V
2903	4822 124 23432	100µF	20%	10V
2904	4822 122 33519	470pF	10%	50V
2905	4822 122 33519	470pF	10%	50V

- RESISTORS -

3872	4822 116 83882	39K	5%	0,5W
3873	4822 116 52257	22K	5%	0,5W
3875	4822 116 52256	2K2	5%	0,5W
3876	4822 116 52283	4K7	5%	0,5W
3901	4822 116 52257	22K	5%	0,5W
3902	4822 116 52234	100K	5%	0,5W
3903	4822 116 52234	100K	5%	0,5W
3904	4822 116 52175	100R	5%	0,5W
3905	4822 050 21003	10K	1%	0,6W
3906	4822 050 21003	10K	1%	0,6W

- MISCELLANEOUS -

1800	4822 276 13114	Push Switch
1801	4822 276 13114	Push Switch
1802	4822 276 13114	Push Switch
1803	4822 276 13114	Push Switch
1804	4822 276 13114	Push Switch
1820	9322 146 49682	LCD Display
7901	5322 209 11147	IC HEF4093BT
7900	9322 155 82667	IR Receiver TSOP2236 (For AZ1055)

Note: Only these parts mentioned in the list are normal service parts.