

Service
Service
Service

Manual #1870
AZ11101701

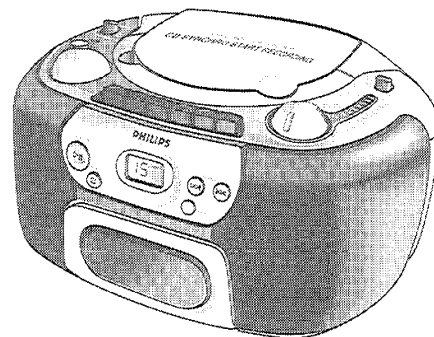

Service Manual

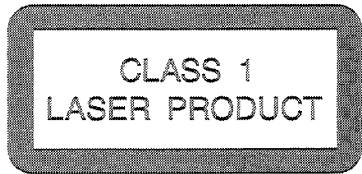

TABLE OF CONTENTS

	chapter		chapter
Handling chip components and safety	1 - 1	MAIN BOARD	
Technical Specification & Service Tools	2 - 1	circuit diagram	9 - 1
Service Measurement	2 - 2	layout diagram	9 - 2
Connections & Controls	3 - 1	RECORDER BOARD	
Instructions for use	3 - 2 to 3 - 5	circuit diagram	10 - 1
Disassembly Diagram	4 - 1	layout diagram	10 - 2
CD Service Test Program	4 - 2 to 4 - 3	CD MODULE	
Block Diagram	5 - 1	layout diagram	11 - 1
Wiring Diagram	6 - 1	circuit diagram	11 - 2
CONTROL BOARD		EXPLODED VIEW DIAGRAM	
circuit diagram	7 - 1	cabinet	12 - 1
layout diagram	7 - 2	tape deck	12 - 2
TUNER BOARD		Mechanical partslist	12 - 2
radio alignment (3 Band)	8 - 1	Electrical partslist	13 - 1 to 13 - 3
circuit & layout diagram (3 band)	8 - 2		
circuit & layout diagram (2 band)	8 - 3		
radio alignment (2 Band)	8 - 4		

Safety regulations require that the set be restored to its original condition and that parts which are identical with those specified be used.

© Copyright 1995 Philips Consumer Electronics B.V. Eindhoven, The Netherlands
All rights reserved. No part of this publication may be reproduced, stored in a retrieval system or transmitted, in any form or by any means, electronic, mechanical, photocopying, or otherwise without the prior permission of Philips.



HANDLING CHIP COMPONENTS

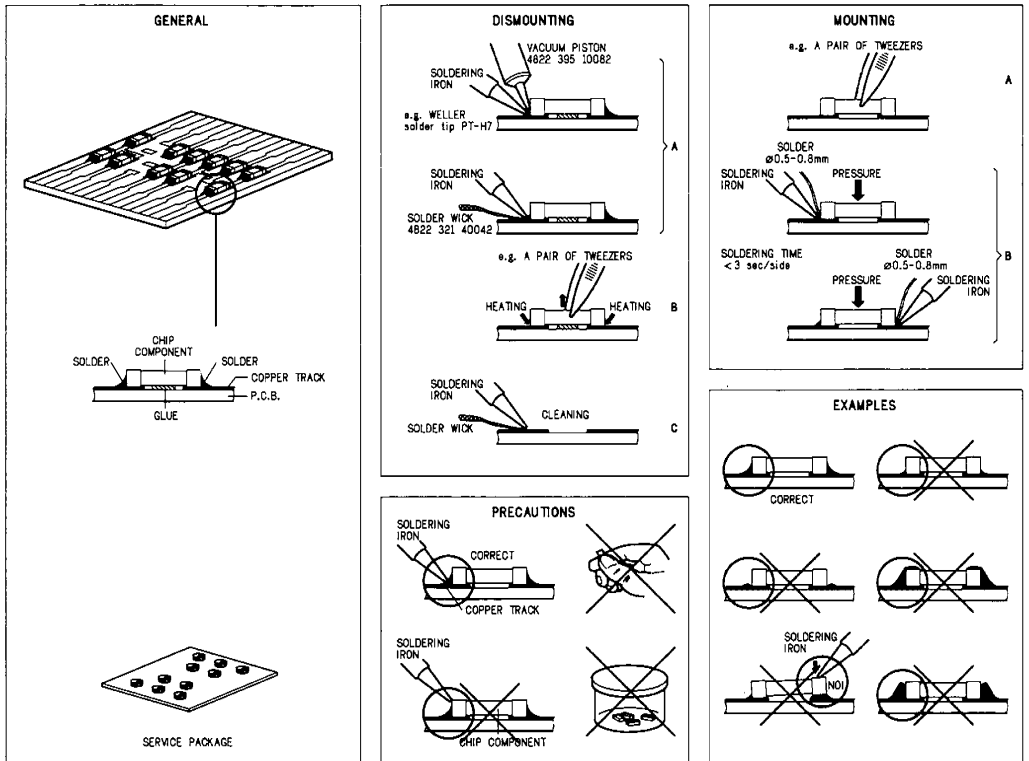

(GB) WARNING

All ICs and many other semiconductors are susceptible to electrostatic discharges (ESD). Careless handling during repair can reduce life drastically. When repairing, make sure that you are connected with the same potential as the mass of the set via a wrist wrap with resistance. Keep components and tools at this potential.

ESD



(F) ATTENTION

Tous les IC et beaucoup d'autres semi-conducteurs sont sensibles aux décharges statiques (ESD). Leur longévité pourrait être considérablement écourtée par le fait qu'aucune précaution n'est prise à leur manipulation. Lors de réparations, s'assurer de bien être relié au même potentiel que la masse de l'appareil et enfilez le bracelet seré d'une résistance de sécurité. Veillez à ce que les composants ainsi que les outils que l'on utilise soient également à ce potentiel.

(D) WARNUNG

Alle ICs und viele andere Halbleiter sind empfindlich gegenüber elektrostatischen Entladungen (ESD). Unvorsichtige Behandlung im Reparaturfall kann die Lebensdauer drastisch reduzieren. Sorgen Sie dafür, dass Sie im Reparaturfall über ein Pulsarmband mit Widerstand mit dem Massepotential des Gerätes verbunden sind. Halten Sie Bauteile und Hilfsmittel ebenfalls auf diesem Potential.

(NL) WAARSCHUWING

Alle IC's en vele andere halfgeleiders zijn gevoelig voor electrostatische ontladingen (ESD). Onzorgvuldig behandelen tijdens reparatie kan de levensduur drastisch doen verminderen. Zorg ervoor dat u tijdens reparatie via een polsband met weerstand verbonden bent met hetzelfde potentiaal als de massa van het apparaat. Houd componenten en hulpmiddelen ook op ditzelfde potentiaal.

(I) AVVERTIMENTO

Tutti IC e parecchi semi-conduttori sono sensibili alle scariche statiche (ESD). La loro longevità potrebbe essere fortemente ridotta in caso di non osservazione della più grande cauzione alla loro manipolazione. Durante le riparazioni occorre quindi essere collegato allo stesso potenziale che quello della massa dell'apparecchio tramite un braccialetto a resistenza. Assicurarsi che i componenti e anche gli utensili con quali si lavora siano anche a questo potenziale.

Anti-static table mat large 1200x650x1.25mm
small 600x650x1.25mm

Anti-static wrist band
Connection box (1MΩ)
Extendible cable (to connect wrist band to conn. box)
Connecting cable (to connect table mat to conn. box)
Earth cable (to connect any product to mat or box)
Complete kit ESD3 (combining all above products)
Wristband tester

4822 466 10953
4822 466 10958
4822 395 10223
4822 320 11307
4822 320 11305
4822 320 11306
4822 320 11308
4822 310 10671
4822 344 13999

(GB)

Safety regulations require that the set be restored to its original condition and that parts which are identical with those specified be used. Safety components are marked by those symbol. ▲

(S) Varning !

Osynlig laserstrålning när apparaten är öppnad och spårren är utkopplad. Beträkta ej strålen.

(DK) Advarsel !

Usynlig laserstrålning ved åbning når sikkerhedsafbrydere er ude af funktion. Undgå udsættelse for stråling.

(SF) Varoitus !

Avatussa laitteessa ja suojalukituksen ohitettaessa olet alttiina näkymättömälle laserisäteilylle. Älä katso säteeseen!

(GB) WARNING

Safety regulations require that the set be restored to its original condition and that parts which are identical with those specified be used.

(F) ATTENTION

Les normes de sécurité exigent que l'appareil soit remis à l'état d'origine et que soient utilisées les pièces de rechange identiques à celles spécifiées.

(D) WARNUNG

Bei jeder Reparatur sind die geltenden Sicherheitsvorschriften zu beachten. Der Originalzustand des Gerätes darf nicht verändert werden. Für Reparaturen sind Original-ersatzteile zu verwenden.

(NL) WAARSCHUWING

Veiligheidsbepalingen vereisen, dat het apparaat in zijn oorspronkelijke toestand wordt teruggebracht en dat onderdelen, identiek aan de gespecificeerde, worden toegepast.

(I) AVVERTIMENTO

Le norme di sicurezza estigono che l'apparecchio venga rimesso nelle condizioni originali e che siano utilizzati i pezzi di ricambio identici a quelli specificati.

TECHNICAL SPECIFICATIONS

GENERAL

Mains voltage	-/00 : 230 V
	-/01/11 : 120/230 V
	-/05 : 240 V
	-/17 : 120 V
Mains frequency	-/00/05 : 50 Hz
	-/01/11 : 50 / 60 Hz
	-/17 : 60 Hz
Battery	mains : 9 V (R20 x 6)
Power consumption	: 17 W
Dimension (W x H x D)	: 295 x 150 x 270 mm
Weight	: 3.2 Kg

AMPLIFIER

Output power	mains : 2 x 2 W
	battery : 2 x 2 W
Speaker impedance	: 2 x 8 ohm
Frequency response	: 100 Hz - 8 kHz (± 3 dB)

TUNER - FM SECTION

Tuning range	: 87 - 108.5 MHz
IF frequency	: 10.7 MHz
Sensitivity	: < 22 dB at 26dB S/N
Selectivity	: > 20 dB at ± 300 kHz
IF rejection	: > 54 dB
Image rejection	: > 20 dB

TUNER - AM SECTION

Tuning range	MW : 512 - 1635 kHz
	-/17 : 520 - 1730 kHz
	LW : 153 - 279 kHz
IF frequency	: 468 kHz \pm 3 kHz
Sensitivity	MW : < 4000 μ V/m at 26dB S/N
	LW : < 6000 μ V/m at 26dB S/N
Selectivity	MW : < 16 dB
	LW : < 20 dB
IF rejection ratio	MW : < 24 dB
	LW : < 26 dB
Image rejection ratio	MW : < 28 dB
	LW : < 30dB

AUDIO CASSETTE RECORDER

Number of tracks	: 1 stereo
Tape speed	: 4.76 cm/sec \pm 3%
Wow & flutter	: < 0.36 % JIS UWTD
Fast wind/rewind C60	: < 120 sec.
Frequency response	P/B : 125 - 6300 Hz
S/N ratio	: > 36 dB

COMPACT DISC

Frequency response	: 63 Hz - 16 kHz
S/N ratio	: > 62 dB
Channel difference	1 kHz : < 3 dB
Channel crosstalk	1 kHz : > 26 dB
Laser wavelength	: 780 \pm 20nm
Laser light power	: < 0.3 mW

SERVICE TOOLS

TORX T10 screwdriver with shaftlength 150mm	4822 395 50423
Audio signal disc SBC 429	4822 397 30184
Playability test disc SBC 444	4822 397 30245
Test disc 5 (disc without errors) +	
Test disc 5A (disc with dropout errors, black spots and fingerprints)	
SBC 426/426A	4822 397 30096
Burn in test disc (65 min. 1kHz signal at -30 dB level without "pause") ...	4822 397 30155
Universal test cassette Fe SBC 420	4822 397 30071

SERVICE MEASUREMENTS

Tuner FM

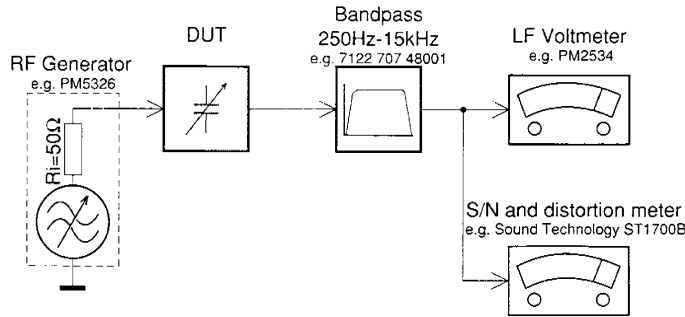

Use a bandpass filter to eliminate hum (50Hz, 100Hz) and disturbance from the pilotone (19kHz, 38kHz).

Tuner AM (MW,LW)

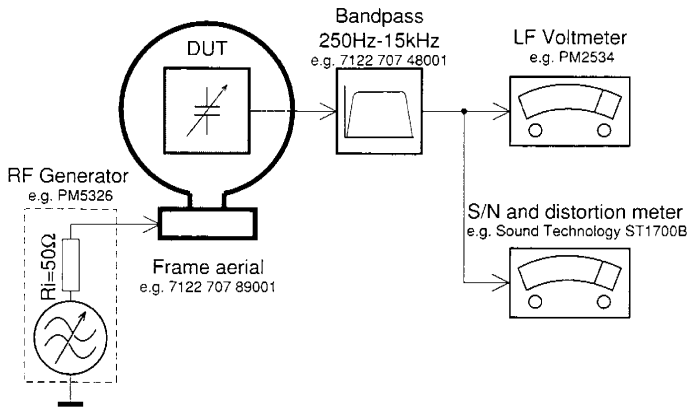

To avoid atmospheric interference all AM-measurements have to be carried out in a Faraday's cage. Use a bandpass filter (or at least a high pass filter with 250Hz) to eliminate hum (50Hz, 100Hz).

CD

Use Audio Signal Disc SBC429 4822 397 30184 (replaces test disc 3)

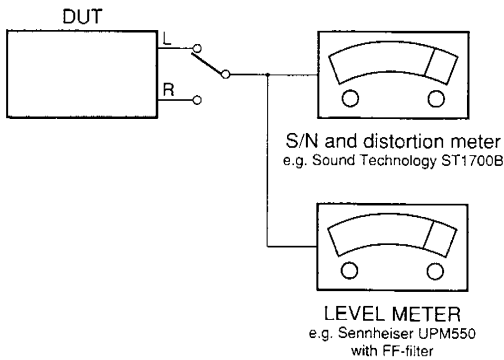

RECORDER

Use Universal Test Cassette Fe SBC420 4822 397 30071

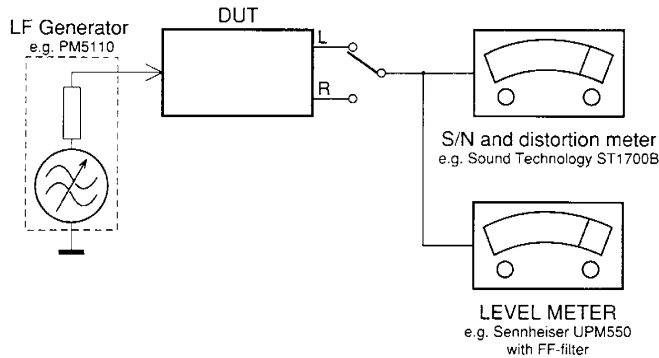

CONNECTIONS AND CONTROLS

TOP and FRONT PANEL

- ① **DBB (Dynamic Bass Boost)** – to increase the bass level
- ② **VOLUME** – to adjust the volume level
- ③ **Cassette keys**
 - PAUSE II** – to interrupt playback
 - STOP • OPEN** – to stop playback and open the cassette compartment
 - SEARCH ◀◀** – to fast forward the tape
 - SEARCH ▶▶** – to fast rewind the tape
 - PLAY ◀** – to start playback
 - RECORD ●** – to start recording
- ④ **CD buttons**
 - PLAY • PAUSE ▶▶ II** – to start or interrupt CD playback
 - STOP ■** – to stop playback
 - SEARCH ◀◀ ▶▶** – to skip or search a passage or a track
 - MODE** – to select a different playback mode e.g. to SHUFFLE or REPEAT and to program track numbers
- ⑤ **CD display** – to indicate CD functions
- ⑥ **Cassette compartment**
- ⑦ **TUNING** – to tune to radio stations
- ⑧ **Tuning dial pointer**
- ⑨ **Band selector** – to select the wave band (FM-MW)
- ⑩ **OPEN** – to open the CD door
- ⑪ **Source selector** – POWER ON/OFF switch and to select the sound source: CD - RADIO - TAPE
- ⑫ **↕** – 3.5 mm headphone socket

Note: Connecting headphones will automatically disconnect the speakers

BACK PANEL

- ⑬ **Telescopic aerial** – To improve FM reception
- ⑭ **MAINS** – for mains lead
- ⑮ **Battery door** – to open the battery compartment
- ⑯ **Voltage selector** – (inside battery compartment)

Both the model and production numbers can be found on the bottom of the set.

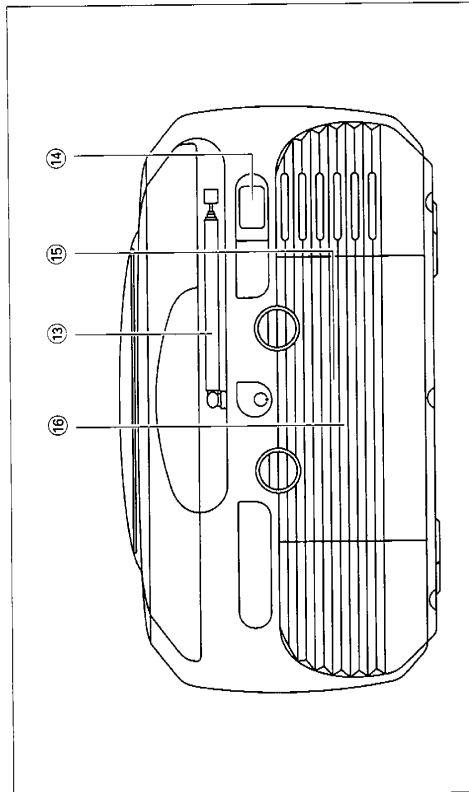
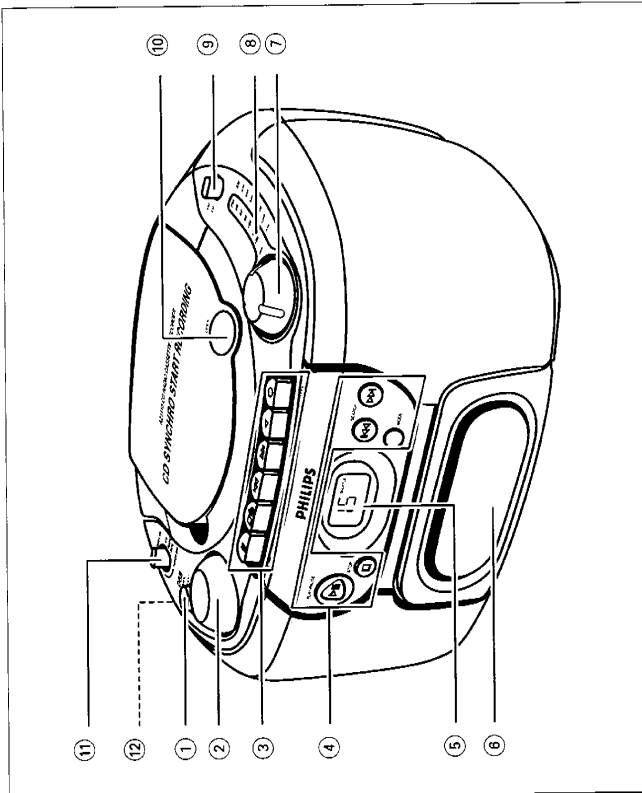

INSTRUCTIONS FOR USE

BATTERIES

Whenever convenient, use the mains supply if you want to conserve battery life. Make sure you remove the mains plug from the set and wall socket before inserting batteries.

Batteries (optional)

1. Open the battery compartment and insert as shown six batteries, type R20, or D-cells.
2. Replace the compartment door, making sure the batteries are firmly and correctly in place.
3. Remove the batteries if exhausted or if they will not be used again for a long period.

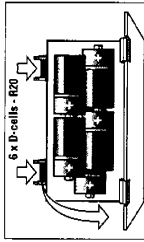

– The incorrect use of batteries can cause electrolyte leakage and will corrode the compartment or cause the batteries to burst. Therefore:

- Do not mix battery types, e.g. alkaline with zinc carbonate.
- When inserting new batteries, replace all batteries at the same time.

Batteries contain chemical substances, so they should be disposed of properly

Note: The battery supply is switched off when the set is connected to the mains.

MAINS

1. Check if the mains voltage as shown on the type plate (on the bottom of the set) corresponds to your local mains voltage. If it does not, consult your dealer or service organisation.
2. If your set is equipped with a voltage selector, set it to the local mains voltage.
3. Connect the mains lead to the MAINS socket and the wall socket.
 - The set is now ready to use.
4. To switch off the mains supply completely, pull the mains plug out of the wall socket.
 - Disconnect the mains lead when you change over to battery supply, or to protect the set during heavy thunderstorms.

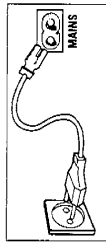
**GENERAL OPERATION**

1. To switch on the set, use the source selector
2. Adjust the sound using the VOLUME control and DBB switch
3. To switch off the set, set the source selector to TAPE/POWER/OFF position, with the cassette keys released.

**RADIO**

1. Set the source selector to RADIO.
2. Adjust the sound using the VOLUME control and the DBB switch.
3. Select the wave band using the FM-MW band selector.
4. Tune to a radio station using the TUNING knob.
 - For FM, pull out the telescopic aerial. To improve FM-reception, incline and turn the aerial. Reduce its length if the FM-signal is too strong (very close to a transmitter).
 - For MW, the set is provided with a built-in aerial, so the telescopic aerial is not needed. Direct the aerial by turning the whole set.
5. To switch off the set, set the source selector to TAPE/POWER/OFF position, with the cassette keys released.

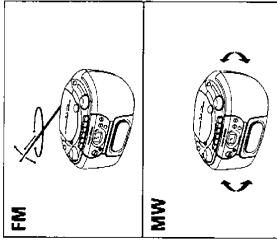
**Environmental information**

All redundant packaging material has been omitted. We have done our utmost to make the packaging easily separable into three mono materials: cardboard (box), expandable polystyrene (buffer) and polyethylene (bags, protective foam sheet).

Your set consists of materials which can be recycled if disassembled by a specialized company. Please observe the local regulations regarding the disposal of packaging materials, exhausted batteries and old equipment.

CD DISPLAY INDICATION

- Total track number: in stop position.
- Current track number: during CD play.
- Current track number flashes: in PAUSE mode.
- **SHUFFLE/REPEAT** mode: the respective mode is activated.
- **PROGRAM**: program function is active. P also appears briefly when you store a track.
- No display: error in CD operation or with the CD (see Troubleshooting).

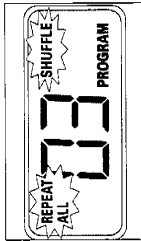

PLAYING A CD

1. Set the source selector to CD.
2. To open the CD compartment, press OPEN on the CD door.
3. Insert the audio CD, printed side facing up.
4. To close the CD compartment, push the door down.
 - The CD player scans the contents of the CD and the total number of tracks is displayed
5. Press PLAY • PAUSE ► II to start playback.
6. Adjust the sound using the VOLUME control and the DBB switch.
7. To interrupt playback, press PLAY • PAUSE ► II. Press PLAY • PAUSE ► II again to continue playback.
8. Press STOP ■ to stop CD playback.
9. Set the source selector to TAPE/POWER/OFF position to switch off the set.

Note: CD playback will also stop when:

- the CD has reached the end;
- the CD door is opened;
- the source selector is in the RADIO or TAPE/POWER/OFF position.

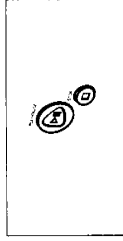

SEARCH ◀◀ or ▶▶

Selecting a different track during playback

- You can jump to the next track by pressing SEARCH ▶▶ once. If you want to skip more than one track, press SEARCH ▶▶ more than once until the display shows the desired track number.
- If you want to repeat the running track from the beginning, press ◀◀ SEARCH once. If you want to repeat one of the previous tracks, press ◀◀ SEARCH more than once until the display shows the required track number.

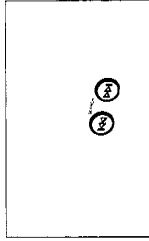

Starting with a particular track

1. In the STOP position you can select a desired track using the ◀◀ SEARCH or SEARCH ▶▶ button.
2. Press PLAY • PAUSE ► II to start playback.

Searching for a passage within a track

You can search for a passage within a track. The CD is played at low volume and at high speed, however, the sound is still recognizable.

1. Keep the ◀◀ SEARCH or SEARCH ▶▶ button pressed during playback, and release the button as soon as you recognize the required passage:
 - Normal CD playback will resume from this point.

SHUFFLE/REPEAT

The MODE button allows you to select four different modes. The modes can be selected or changed during playback.

1. During playback only, press MODE until the desired function appears on the display.

REPEAT - Continuous playback of the current track.

SHUFFLE - Tracks are played in random order.

REPEAT ALL, SHUFFLE - Continuous playback of tracks in random order.

REPEAT ALL - Repeats the entire CD.

- During playback you can use ◀◀ SEARCH or SEARCH ▶▶ to skip tracks.

2. To leave the SHUFFLE mode, press the MODE button repeatedly until the various SHUFFLE/REPEAT modes are no longer shown on the display. You can also press STOP ■ to quit playback.

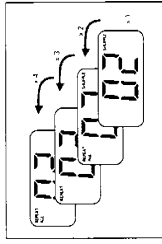

PROGRAMMING TRACK NUMBERS

You may store at most 20 tracks in the memory in the desired sequence. You may store any track more than once.

Programming track numbers

1. In the stop position select the desired track using ◀◀ SEARCH or SEARCH ▶▶ until the display shows the desired track number.
2. Store the desired track by pressing MODE once.
 - The display shows P and PROGRAM followed by your selected track number.
3. Select and store all desired tracks of a CD in this way.

Checking a program

1. To review the set program, in the stop position press and hold MODE for more than 2 seconds.
 - The display will show the track numbers you have selected in sequence.
2. To start playback of the program, press PLAY • PAUSE ► II.
 - Playback starts with the first track of the program. After the last track, playback stops and the display shows the CD's total number of tracks.

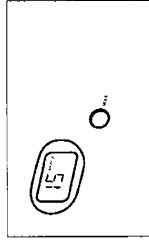

PROGRAMMING TRACK NUMBERS

Erasing a program

- You can erase a program by:
- opening the CD door.
 - setting the source selector to the TAPE or RADIO position.
 - pressing STOP twice during playback/in the stop position.

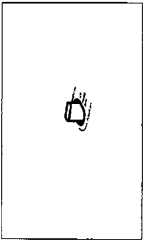

CASSETTE PLAYBACK

1. Set the source selector to TAPE.
2. Press STOP • OPEN ■ ▲ to open the cassette holder.
3. Insert a recorded cassette.
4. Press PLAY ◀ and playback will start.
5. Adjust the sound using the VOLUME, and DBB controls.
6. For brief interruptions, press PAUSE ■. Press PAUSE ■ again to resume playback.
7. By pressing ◀◀ or ▶▶, fast winding of the tape is possible in both directions.
8. To stop playback, press STOP • OPEN ■ ▲.
9. The keys are automatically released at the end of the tape.
9. Set the source selector to TAPE/POWER/OFF position (with the cassette keys released) to switch off the set.

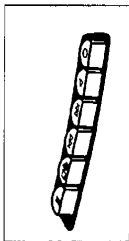

RECORDING FROM THE RADIO

1. Set the source selector to RADIO.
2. Tune to the desired radio station using the TUNING knob.
3. Press STOP • OPEN ■ ▲ to open the cassette holder.
4. Insert a blank cassette.
5. Press RECORD ● to start recording.
6. For brief interruptions, press PAUSE ■. To resume recording, press PAUSE ■ again.
7. To stop, press STOP • OPEN ■ ▲.

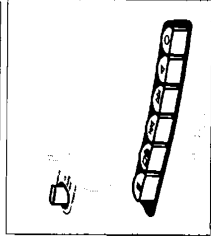

CD SYNCHRO START RECORDING

1. Set the source selector to CD.
2. Insert a CD and if desired, program track numbers.
3. Press STOP • OPEN ■ ▲ to open the cassette holder.
4. Insert a blank cassette.
5. Press RECORD ● to start recording.
 - Playing of the CD program starts automatically from the beginning of the program. It is not necessary to start the CD player separately.
6. For brief interruptions, press PAUSE ■. To resume recording, press PAUSE ■ again.
7. To stop recording press STOP • OPEN ■ ▲.

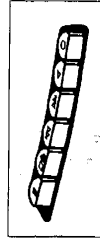

CASSETTE RECORDING

- General information on cassette recording**
- Recording is permissible insofar as copyright or other rights of third parties are not infringed.
 - This deck is not suited for recording on CHROME (IEC III) or METAL (IEC IV) type cassettes. For recording you should use NORMAL type cassettes (IEC I) on which the tabs have not been broken.
 - The recording level is set automatically. Altering the VOLUME control or, DBB switch will not affect the recording in progress.
 - No recording will take place during the first 7 seconds, when the leader tape passes the recorder heads.
 - To prevent the accidental erasure of a recording, keep the cassette side to be safeguarded in front of you and break out the left tab. Recording on this side is no longer possible.

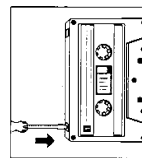

To select and record a particular passage within a track

1. Press ◀◀ SEARCH or SEARCH ▶▶ to select a passage.
2. Put the CD player in PAUSE ■ position at the selected passage.
 - Recording will start from this exact point when you press RECORD ●.

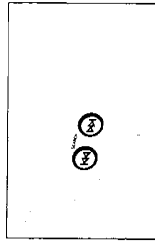

INSTRUCTIONS FOR USE

If a fault occurs, first check the points listed below before taking the set for repair. If you are unable to remedy a problem by following these hints, consult your dealer or service centre.

WARNING: Under no circumstances should you try to repair the set yourself, as this would invalidate the guarantee.

PROBLEM	POSSIBLE CAUSE	REMEDY
Set does not react to operation of any control.	- Electrostatic discharge.	• Switch off the set, disconnect the mains plug and reconnect after a few seconds.
Display does not function properly.	- Electrostatic discharge.	• Switch off the set, disconnect the mains plug and reconnect after a few seconds.
No sound.	- VOLUME is not adjusted. - Headphones are connected. - Batteries are exhausted. - Batteries are incorrectly inserted. - Mains lead is not securely connected.	• Adjust the VOLUME. • Disconnect headphones. • Insert fresh batteries. • Insert the batteries correctly. • Connect the mains lead properly. • Replace batteries.
Bad sound.	- Batteries are exhausted.	• Replace batteries.
Severe radio hum or noise.	- Set too close to TV, VCR or computer. - Weak radio signal.	• Increase the distance. • FM: aim and extend the telescopic aerial for best reception; • MW: rotate the entire set.
Poor radio reception.	- Dust and dirt on the heads, capstan or pressure roller. - Use of incompatible cassette types (METAL or CHROME). - Cassette tab(s) may be broken out. - CD is badly scratched or dirty.	• Clean the heads etc., see Maintenance. • Only use NORMAL (IEC I) for recording. • Apply a piece of adhesive tape over the missing tab space. • Replace or clean the CD, see Maintenance. • Insert CD. • Insert CD with printed side facing up. • Wait until lens has acclimatized.
Poor cassette sound quality.	- No CD inserted. - CD inserted upside down. - Laser lens is steamed up.	• Select tracks or erase program.
Recording does not work.	- MODE pressed but no tracks selected during programming. - CD is damaged or dirty. - PROGRAM/SHUFFLE is active.	• Replace or clean the CD. • Switch off the PROGRAM/SHUFFLE function.
CD playback does not work.		
The CD skips tracks.		

PRECAUTIONS & GENERAL MAINTENANCE

- Place the set on a hard, flat surface so that it does not tilt.
- Do not expose the set, CDs, batteries or cassettes to humidity, rain, sand, direct sunlight or other places where high temperatures can occur, such as in the vicinity of heating apparatus or in motor cars parked in the sun.
- Do not cover the set. The amplifier produces heat which must dissipate freely, so make sure that there is sufficient ventilation around the set. A minimum gap of 15 cm is necessary.
- The mechanical parts of the CD player and the cassette deck contain self-lubricating bearings and must not be oiled or lubricated.
- A chamois leather slightly moistened with water is sufficient for cleaning the housing. Do not use cleaning agents containing alcohol, spirits, ammonia or abrasives as these may harm the housing.

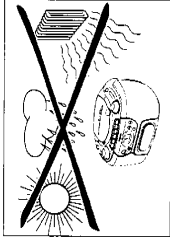

CD MAINTENANCE

- The lens of the CD player should never be touched.
- The lens may cloud over if the set is moved from cold to warm surroundings. The CD player will not start. Give the player some time to acclimatise.
- To take a CD out of its box, press the centre spindle while lifting the CD. Always pick up the CD by the edge and replace the CD back in its box after use to avoid scratching and dust.
- To clean the CD, wipe in a straight line from the centre towards the edge using a soft, lint-free cloth. Do not use cleaning agents as they may damage the disc.
- Never write on a CD or attach stickers to it.

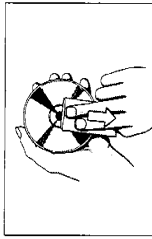

RECORDER MAINTENANCE

- To ensure a good recording and playback quality, clean the indicated parts (A), (B) and (C) after every 50 hours of operation or, on average, once a month. Use a cotton bud slightly moistened with alcohol or a special head cleaning fluid.
- Press PLAY ◀ and clean the rubber pressure roller (C).
 - Then press PAUSE II and clean the capstan (B) and the heads (A).
 - After cleaning, press STOP • OPEN ■▲.
- Cleaning of the heads (A) can also be done by playing a cleaning cassette through once.

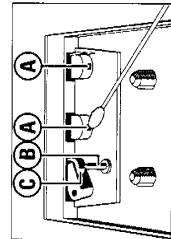

DISASSEMBLY DIAGRAM

4-1

- A. To remove Front Cabinet Assembly
- B. To remove Main Board
- C. To remove Volume Board
- D. To remove Tuner Board
- E. To remove Tape Deck
- F. To remove CD Assembly
- G. To remove CD Door

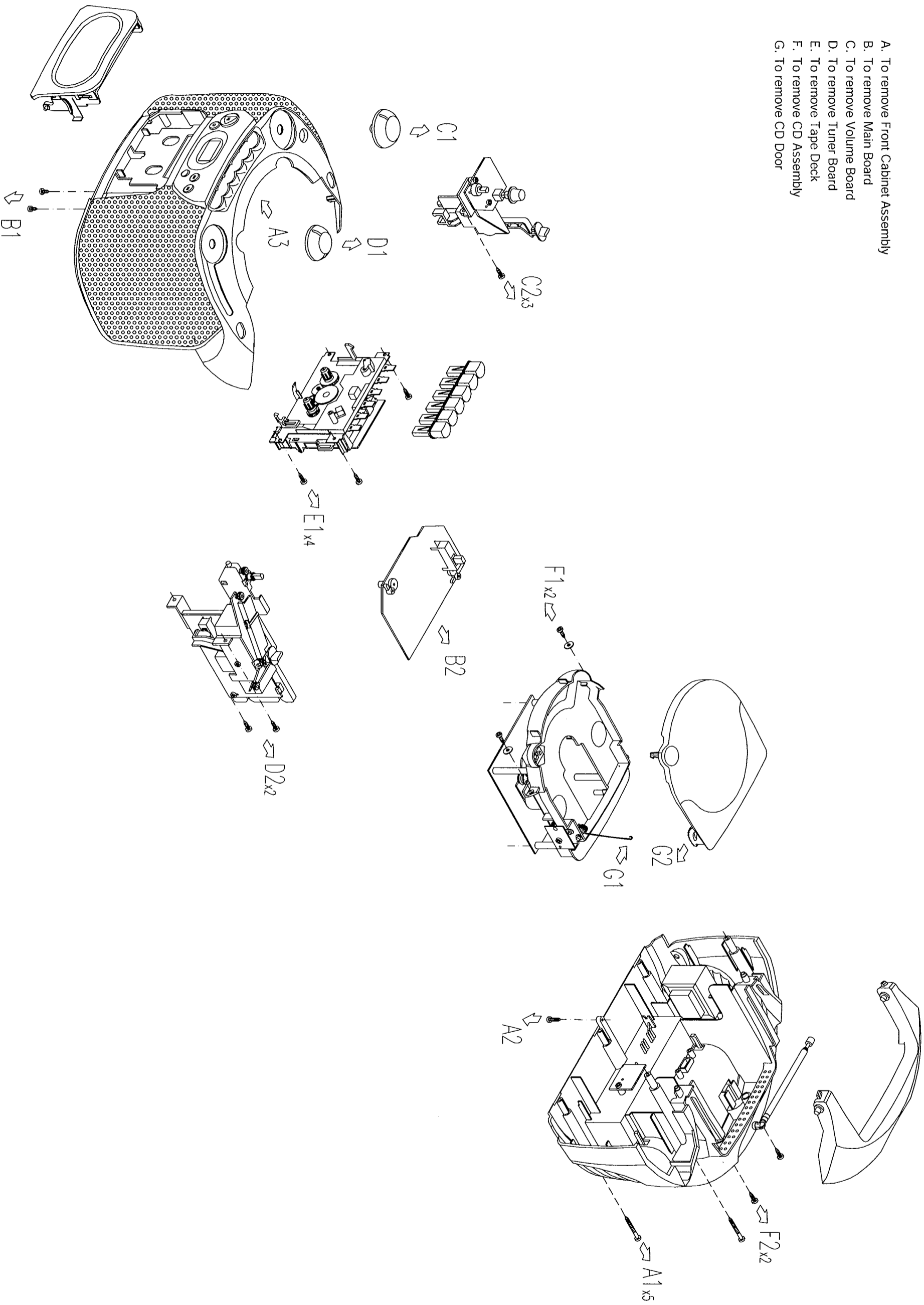

4-1

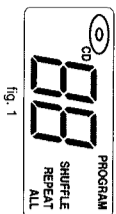
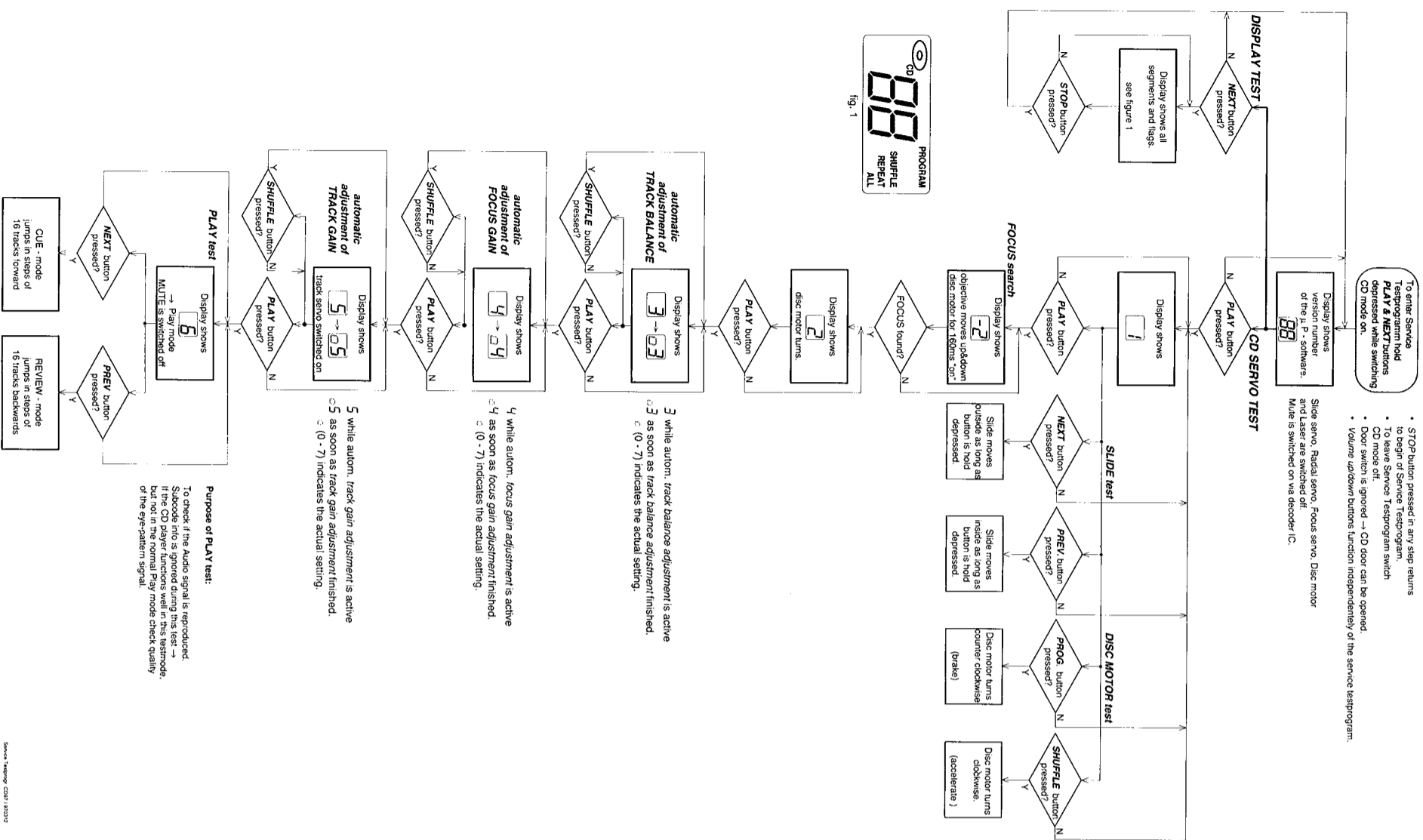
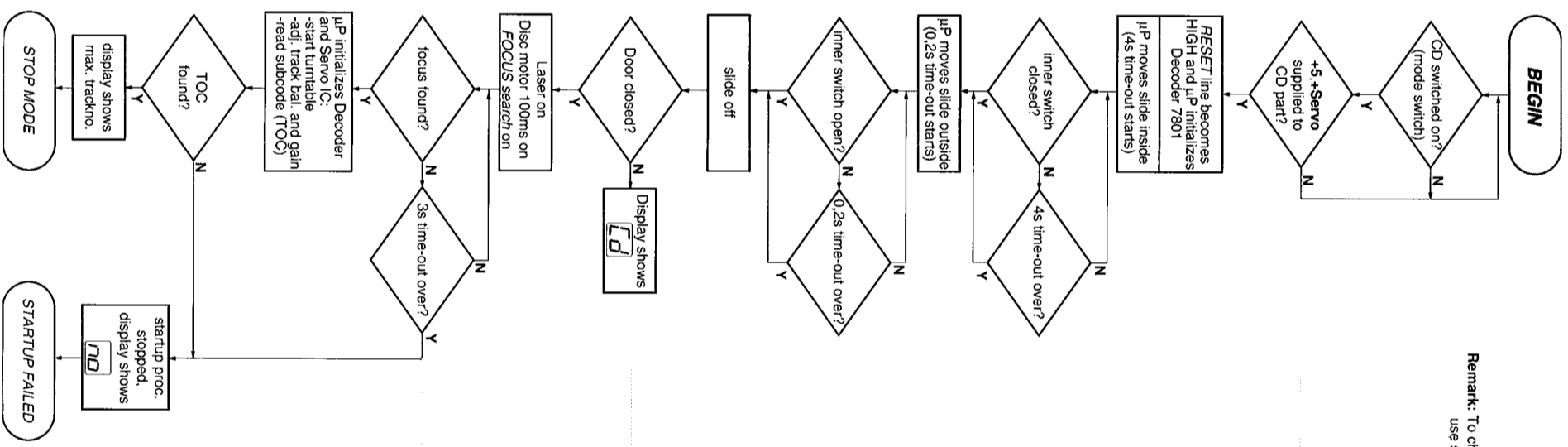

Fig. 1

Purpose of PLAY test:
To check if the Audio signal is reproduced. Subcode info is ignored during this test → If the CD player functions well in this testmode, but not in the normal Play mode check quality of the eye-pattern signal.



Remark: To check focus servo, slide servo, track servo and turntable use service test program

- Battery empty?
- check +5 and +Servo

check: - door switch

check: - Laser light on ? - Check pin 38 of 7803 and LASER CONTROL circuit
- Focus Servo

check: - Motor control pin 37/38 of Decoder 7801 and Disc Motor driver 7805
- HF Signal
- Signal on pin7 of Decoder 7801

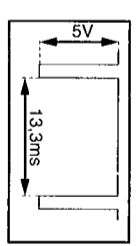

Abbreviations and Pin-descriptions of CD ICs

SERVO PROCESSOR M62475FP

Pin Name	Direction	Description
1-3 A, B, C	Diode array → Servo processor	Current input (central photo diode signal input)
4-5 E, F	Diode array → Servo processor	Current input (satellite photo diode signal input)
6 SGT	Servo processor → Track servo	Signal generator output to track servo, sends 1700Hz for adjustment, procedure
7 TE -	-	Inverting input of tracker error amplifier
8 TEGain	-	Gain control pin of track error amplifier
9 TG1	-	Track Gain 1 - switch: controls the gain of the track servo amplifier
10 TE out	-	Track Error amplifier output
11 TC/Shock	-	Track Cross/Shock detector input
12 TS +	-	Non inverting input of track servo amplifier
13 TG2	-	Track Gain 2 - switch: controls the gain of the track servo amplifier
14 TS -	-	Inverting input of track servo amplifier
15 TS out	Servo processor → Servo driver	Output of track servo amplifier
16 SS +	-	Non inverting input of slide servo amplifier
17 SS -	-	Inverting input of slide servo amplifier
18 Slide out	Servo processor → Motor driver	Output of slide servo amplifier
19 DETFIL	Servo processor → external electronic	Pin for connection of DETection FILTER capacitor of ADJUST LOGIC
20 BIAS	-	Reference Voltage output Vcc/2 of Internal BIAS-generator
21 GND	-	Ground connection pin (negative supply)
22 ML/A/DIS	µP → Servo processor	Serial interface Microprocessor Latch control / DIScharge control for adjustment
23 JP1/SG	µP → Servo processor	Serial interface Jump control line / Signal Generator input line for adjustment
24 MCK	µP → Servo processor	Serial interface Clock input line
25 MSD	µP → Servo processor	Serial interface Data input line
26 Dout	Servo processor → µP	Serial interface Data output line
27 CLPF	-	Pin for connection of Low Pass Filter capacitor for ADJUST LOGIC
28 IREF	-	Reference current input
29 VCC	-	Positive supply connection pin (4V - 5.5V)
30 FSout	Servo processor → Servo driver	Output of focus servo amplifier
31 FS -	-	Inverting input of focus servo amplifier
32 FEGain	-	Gain control pin of focus error amplifier
33 FE -	-	Inverting input of focus error amplifier
34 SGF	Servo processor → Focus servo	Signal generator output to focus servo, sends 1300Hz for adjust, procedure
35 CFSR	-	Charge capacitor for Focus Search triangle-generator
36 APC +	-	Non inverting input of Automatic laser Power Control amplifier
37 APC -	Servo processor → Laser driver	Inverting input of Automatic laser Power Control amplifier
38 APC out	-	Output of Automatic laser Power Control amplifier
39 MFC	-	Connection pin for capacitor of Mirror detector
40 HF	Servo processor → Decoder	Output of HF amplifier
41 HFI	-	Inverting input of HF amplifier
42 ABC	-	Sum output of amplified A, B and C input (central photo diode signal input) to external ac-coupling capacitor

SIGNAL PROCESSOR M65821FP

Pin Name	Direction	Description
1 VDD1	-	+supply for signal processor
2 EMP	not connected	Emphasis flag output
3 SYCLK	not connected	Frame synchronize output
4 LOCK	not connected	Low disc rotation detect output
5 SCAND	not connected	Subcode sync signal detection
6 CR/CF	not connected	Subcode Q CRC check flag output
7 SBOS	Signal processor → µP	Interrupt signal to read out subcode Q data
8 MSD	µP ↔ Signal processor	Data line
9 RESET	Reset circuit → Signal processor	System reset
10 MCK	µP → Signal processor	Clock input
11 M/LA	µP → Signal processor	Latch clock input
12-14 MODx	µP → Signal processor	Mode setting inputs (0,1,2)
15 VDD2	-	+supply for data slicer and VCO
16 IREF	-	Current reference
17 HF	Signal processor → µP	HF signal detect
18 LPF	-	P.L.L. loop filter
19 HF	Servo processor → Signal processor	HF signal input
20 TLC	-	Output from slice level control
21 VSS2	-	Ground
22 C846	not connected	8,4672MHz clock output
23 C423	Signal processor → µP	4,2336MHz clock output
24 EST2	not connected	Error monitor output2
25 EST1	not connected	Error monitor output1
26 XI	X-Tal → Signal processor	Crystal oscillator input
27 XO	Signal processor → X-Tal	Crystal oscillator output
28 DOTX	not connected	Output of digital interface
29 DO1	Signal processor → DAC	Serial data output to DAC
30 DO2	not connected	Serial data output to DAC
31 CKSEL	not connected	Crystal selector input, H=8MHz, L=16MHz
32 DSCK	Signal processor → DAC	Serial data output to DAC
33 WDCK	Signal processor → DAC	Data shift clock
34 LRCK1	Signal processor → DAC	Word clock
35-36	not used	Left/Right clock
37 PWM1	Signal processor → Motor driver	Disc motor driving (Pulse Width Modulation) output1
38 PWM2	Signal processor → Motor driver	Disc motor driving (Pulse Width Modulation) output2
39-41	not used	
42 VSS1	GND	Digital system ground

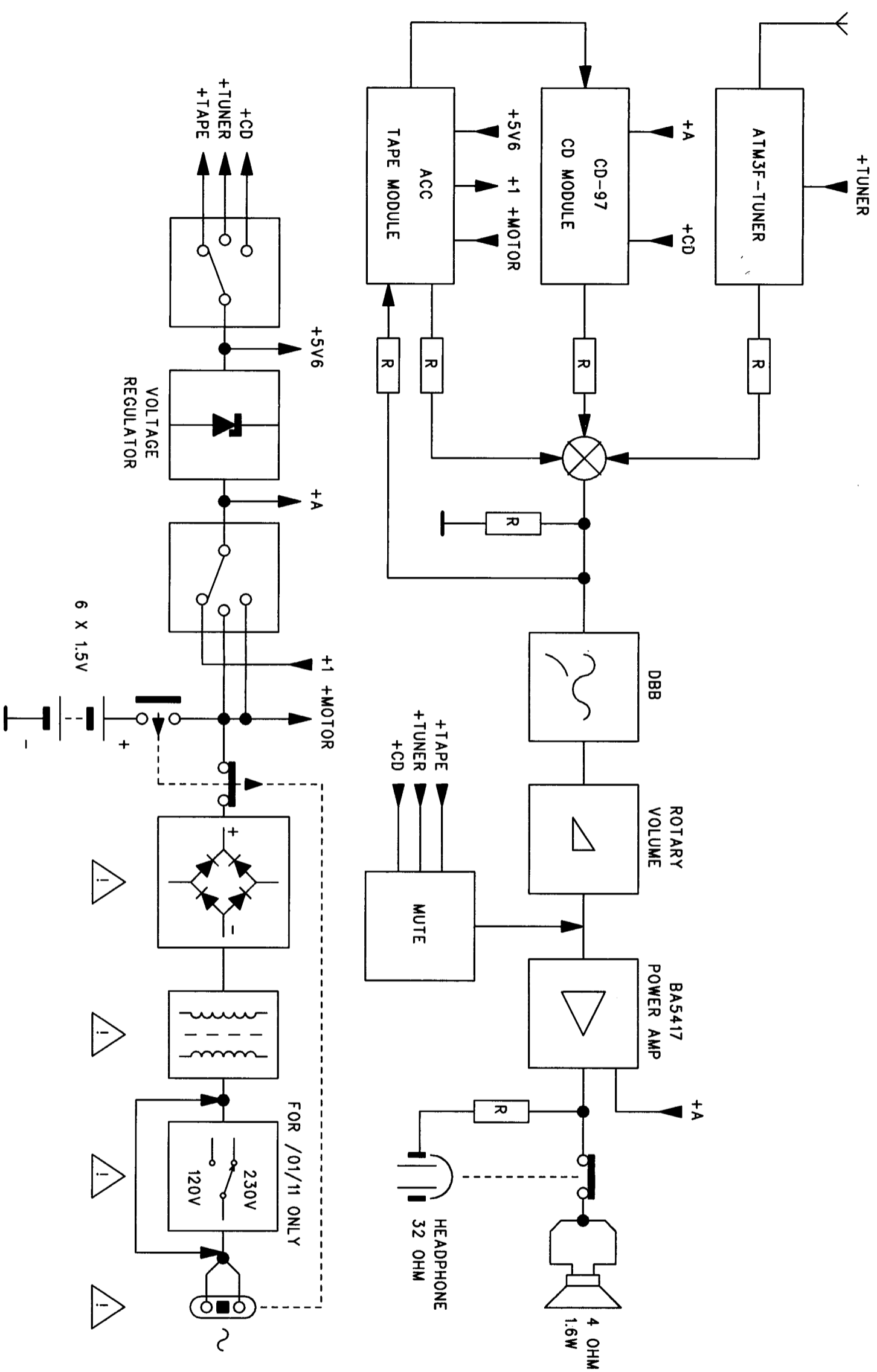

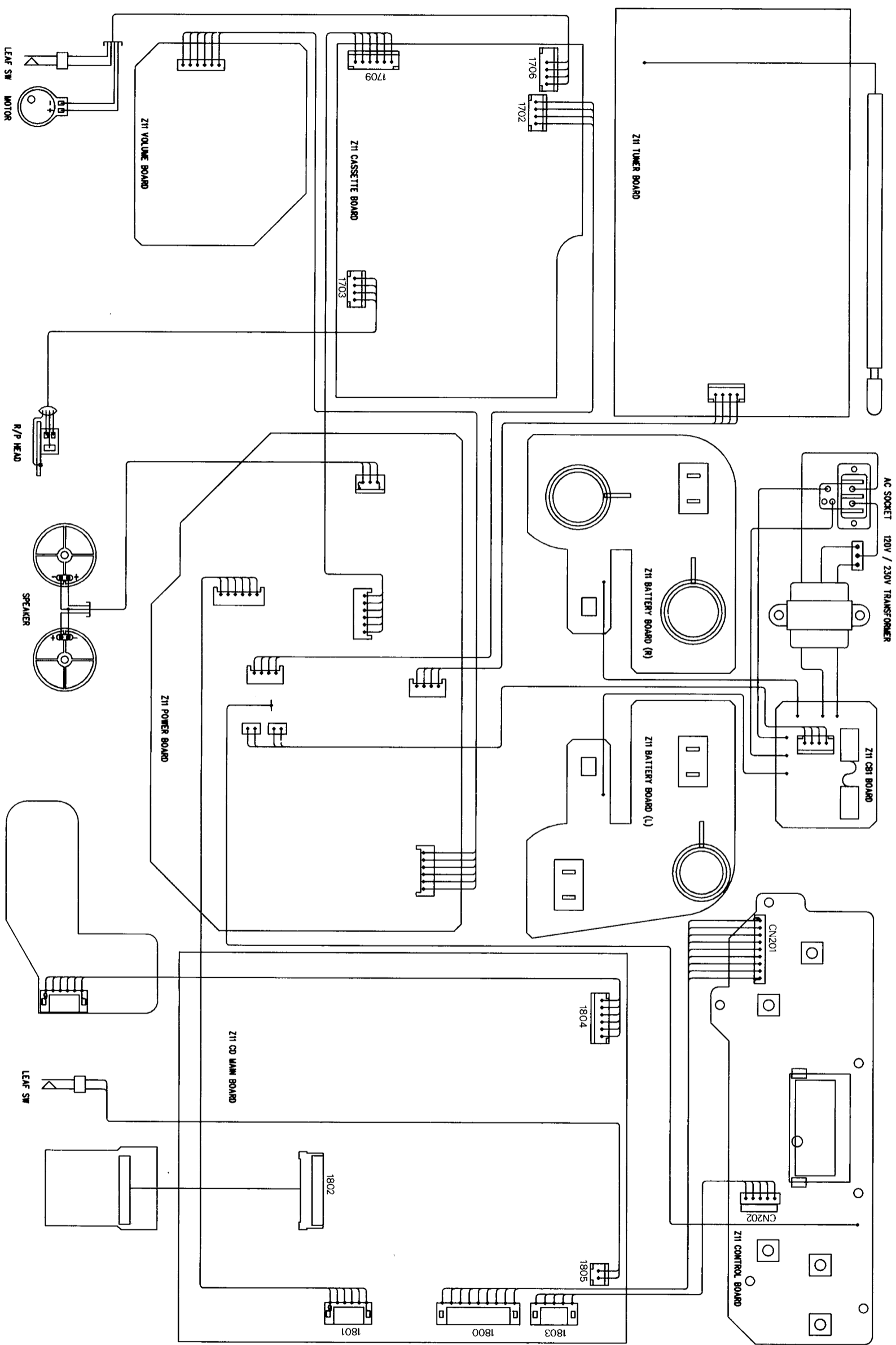

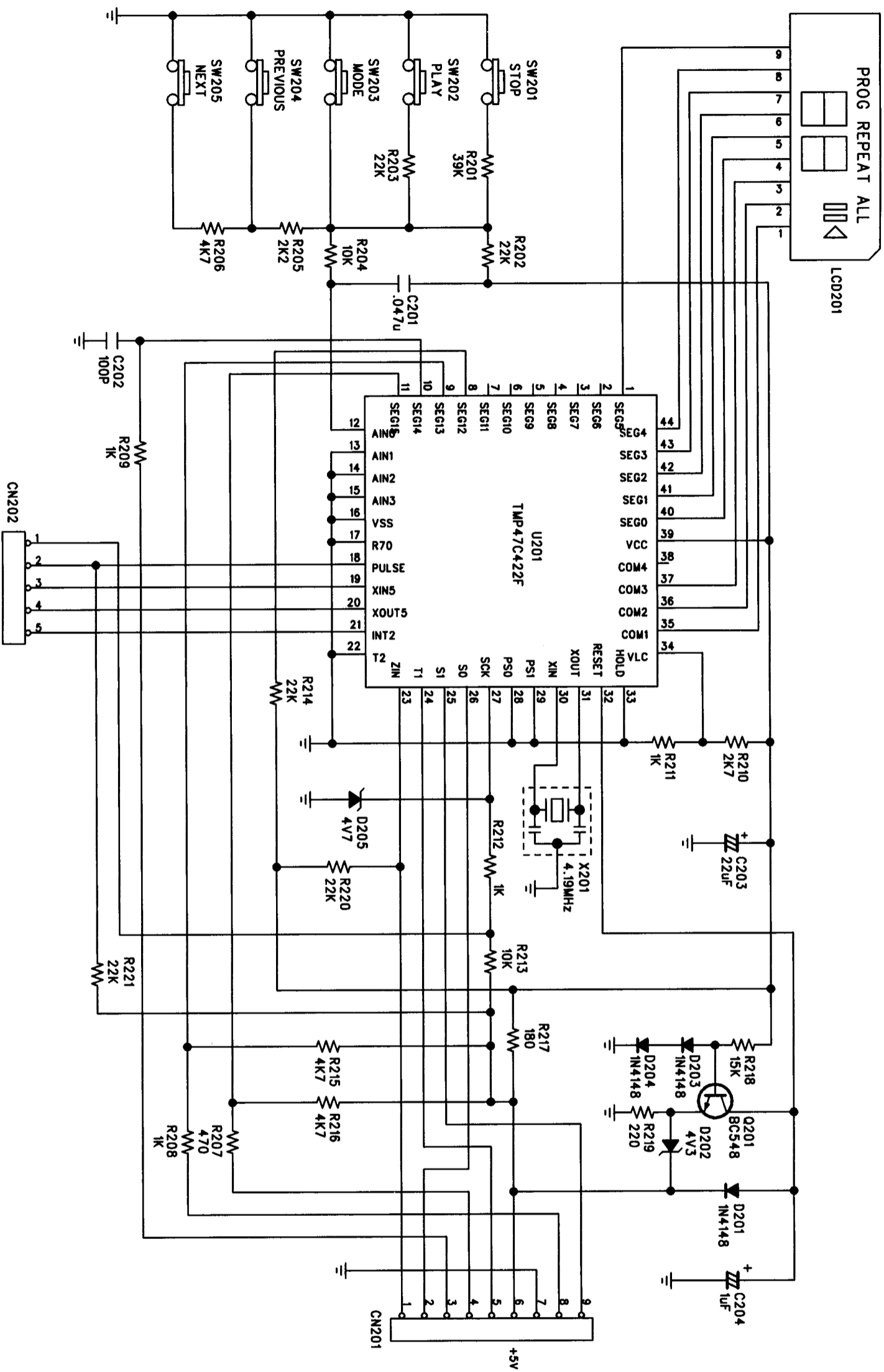

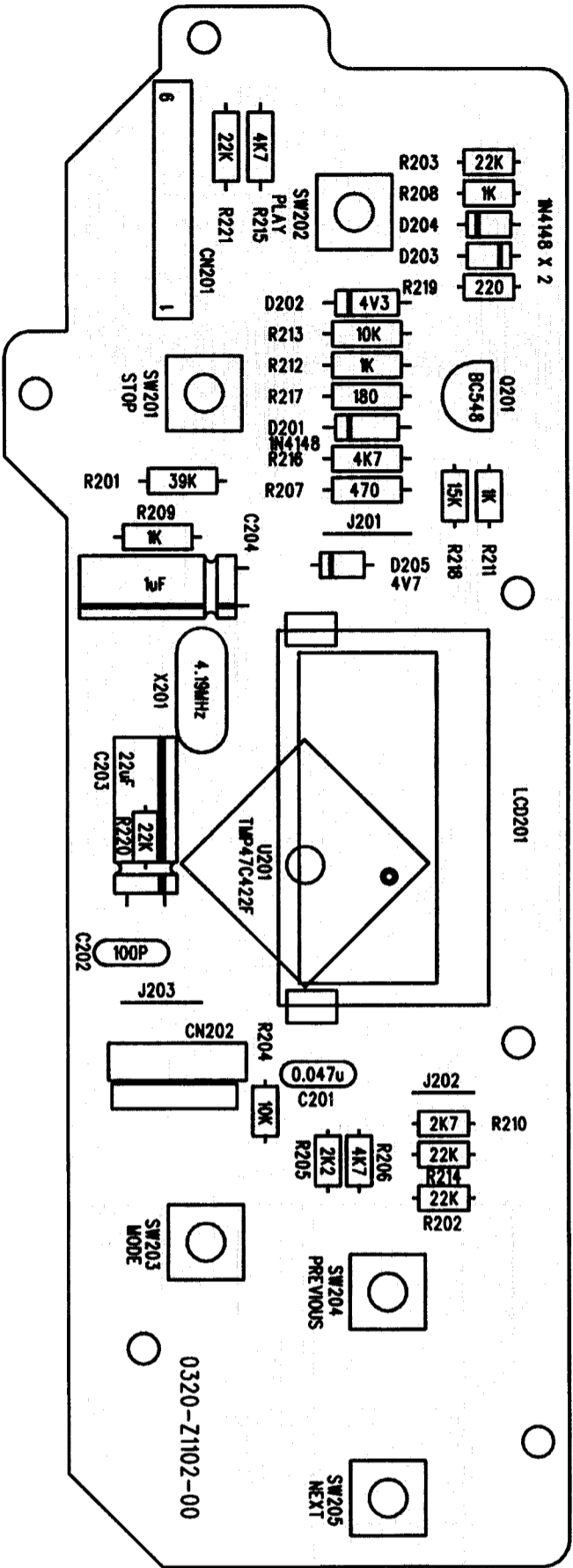

	B	C	E
Q201	1.08	1.094	4.7

PIN	U201	TMP47C422F
1	3.038	23 4.71
2	3.190	24 5.18
3	3.190	25 5.17
4	3.054	26 0.061
5	3.060	27 0
6	3.069	28 0
7	3.061	29 3.46
8	4.75	30 2.325
9	5.24	31 2.25
10	4.3	32 4.66
11	4.59	33 0
12	4.15	34 1.29
13	0	35 3.032
14	0	36 3.034
15	0	37 3.033
16	0	38 3.032
17	0	39 4.77
18	5.26	40 3.046
19	0.887	41 3.054
20	1.048	42 3.836
21	4.97	43 3.068
22	0	44 3.043

VOLUME BOARD - LAYOUT DIAGRAM

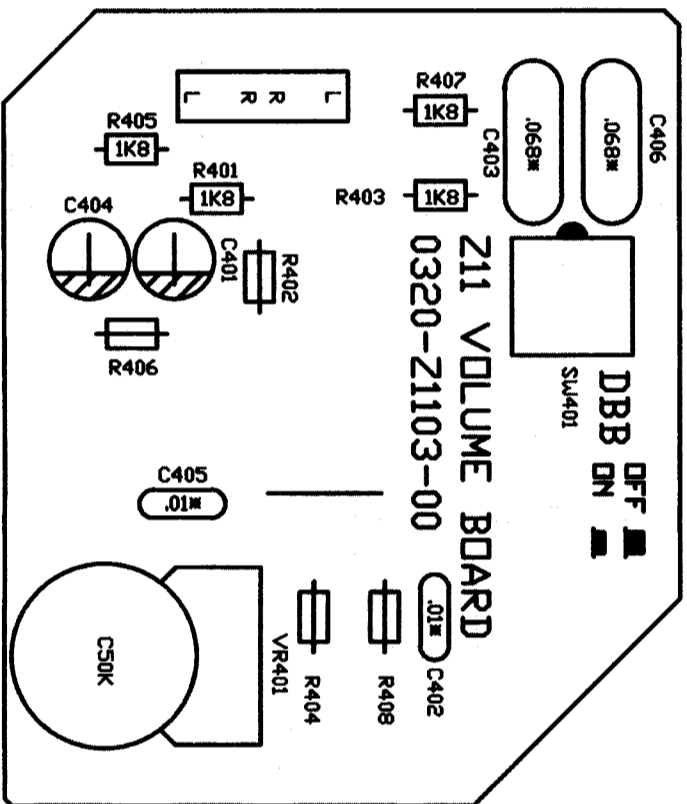

AM IF							
AM or MW	468KHZ	A	min.	5106 5108	1	max.	
AM RF							
MW *	512KHZ	B	max.	5105	H/P Jack	max.	max.
	1635KHZ		min.	C4			
	550KHZ			L2			
(see fig. 3)	1500KHZ	B		C3	H/P Jack	max.	max.
	520KHZ		max.	5105			
	1730KHZ		min.	C4			
AM *	550KHZ	B		L2	H/P Jack	max.	max.
	1500KHZ			C3			
	147KHZ		max.	5109			
LW *	291KHZ	B	min.	2126	H/P Jack	max.	max.
	155KHZ			5103			
	270KHZ		max.	2150			
FM IF							
FM #	10.7MHZ						<input checked="" type="checkbox"/> symm. <input type="checkbox"/> max. lin.
FM RF							
FM #	87.35MHZ	C	max.	5104	H/P Jack	max.	max.
	108.25MHZ		min.	C2			
	88MHZ			5101			
(see fig. 4 & 5)	106MHZ	C		C1	H/P Jack	max.	max.
	64.7MHZ		max.	5104			
	108.25MHZ		min.	C2			
FM #	68MHZ	C		5101	H/P Jack	max.	max.
	106MHZ		max.	C1			
	106MHZ		min.	5101			
STEREO DECODER							
FM #	98MHZ	C	98MHZ	3101	D	152 ± 1KHZ	

* Mod. 1KHz 30%
10nF + 15E
Repeat

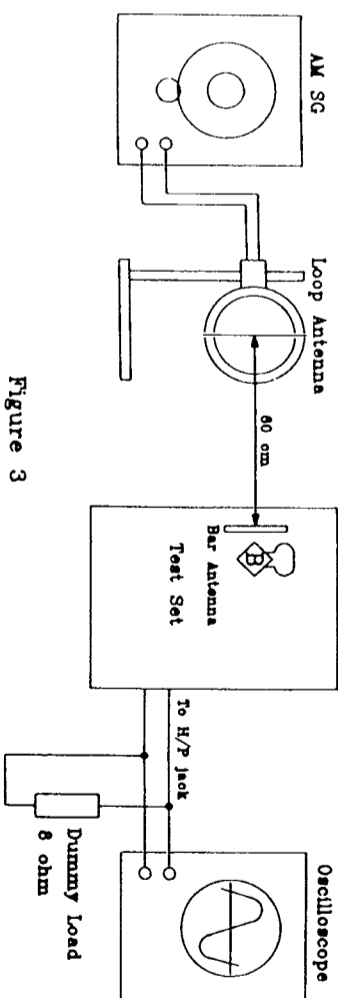

Figure 3

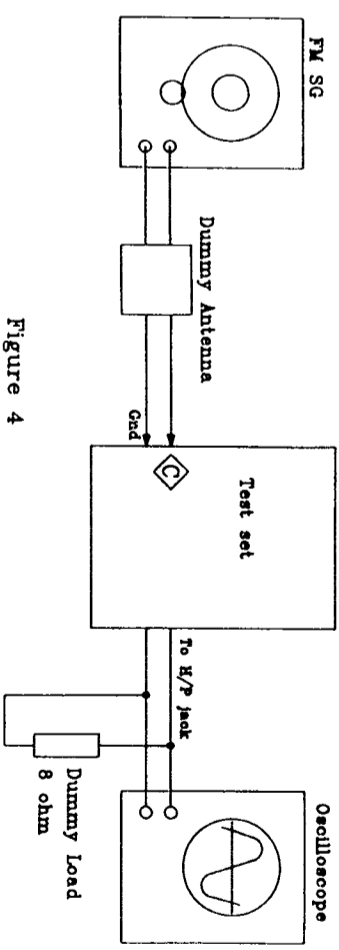

Figure 4

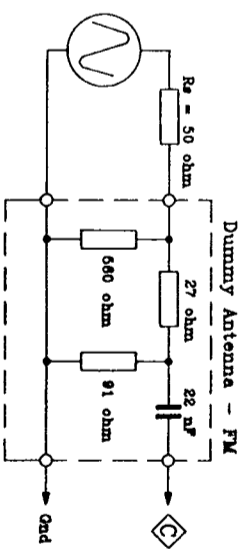
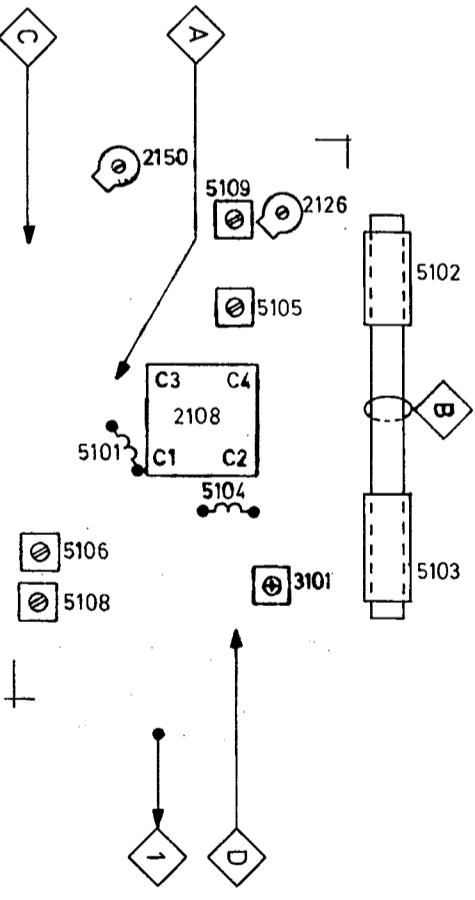
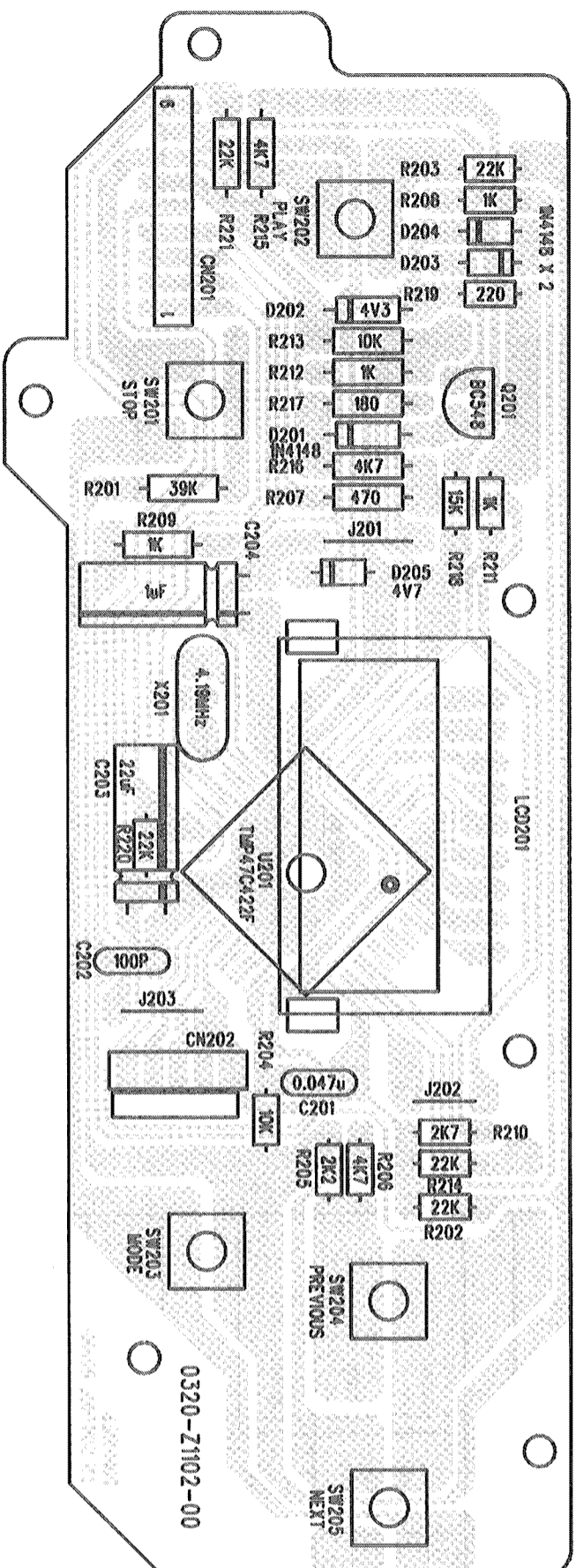

Fig. 5





	B	C	E
Q201	1.08	1.094	4.7

PIN	U201	TMP47C422F
1	3.038	23 4.71
2	3.190	24 5.18
3	3.190	25 5.17
4	3.054	26 0.061
5	3.060	27 0
6	3.069	28 0
7	3.061	29 3.46
8	4.75	30 2.325
9	5.24	31 2.25
10	4.3	32 4.66
11	4.59	33 0
12	4.15	34 1.29
13	0	35 3.032
14	0	36 3.034
15	0	37 3.033
16	0	38 3.032
17	0	39 4.77
18	5.26	40 3.046
19	0.887	41 3.054
20	1.046	42 3.836
21	4.97	43 3.068
22	0	44 3.043

VOLUME BOARD - LAYOUT DIAGRAM

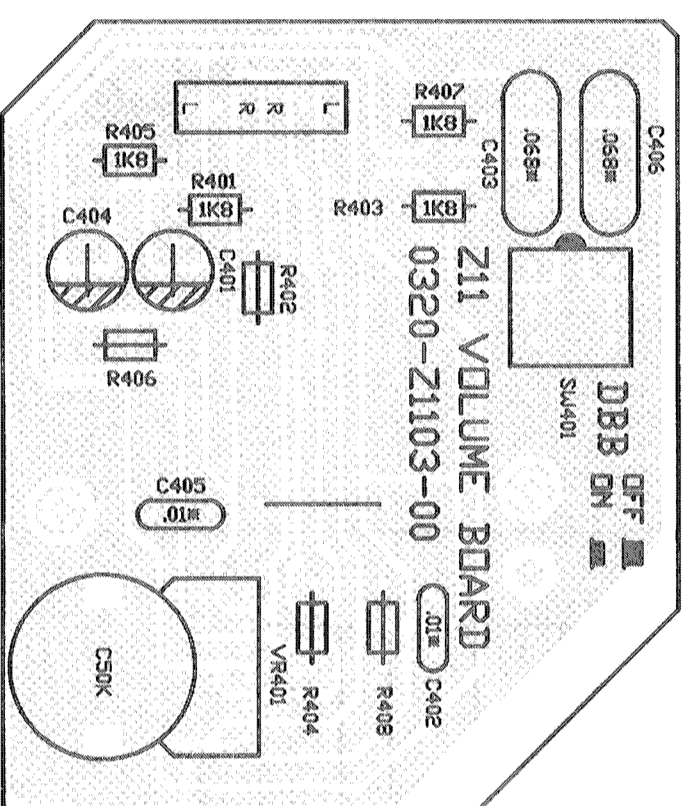

TUNER BOARD (MW/LW/FM) - CIRCUIT DIAGRAM

1100a	G10	2101	B 4	2105	E 3	2106a	G 7	2112	H 5	2115	B10	2119	D10	2125	G 5	3101	F 8	3102	H 8	3105	F 1	3107a	A 5	3109	G 5	3110	A12	3114	F 4		
1100b	F 6	2102	C 3	2106b	D 3	2107	E 4	2112	G 7	2116	C10	2120	D10	2126	G 5	3102	F 8	3103	F10	3104	H 8	3105	F 1	3107b	A 7	3109	G 5	3110	D11	3114	F 4
1100c	G 7	2103	D 3	2106c	C 2	2108	F 4	2113	F 9	2117	C10	2121	E10	2131	F 2	3103	F 8	3104	F10	3105	F 1	3107c	A 9	3109	G 5	3110	B 2	3112	G 6		
1100d	F 3	2104	D 3	2106d	C 2	2109	F 4	2114	G 9	2118	C10	2122	E11	2150	F 2	3104	F10	3105	F 1	3106	A 5	3108	A 7	3109	G 5	3110	B 2	3111	G 6		

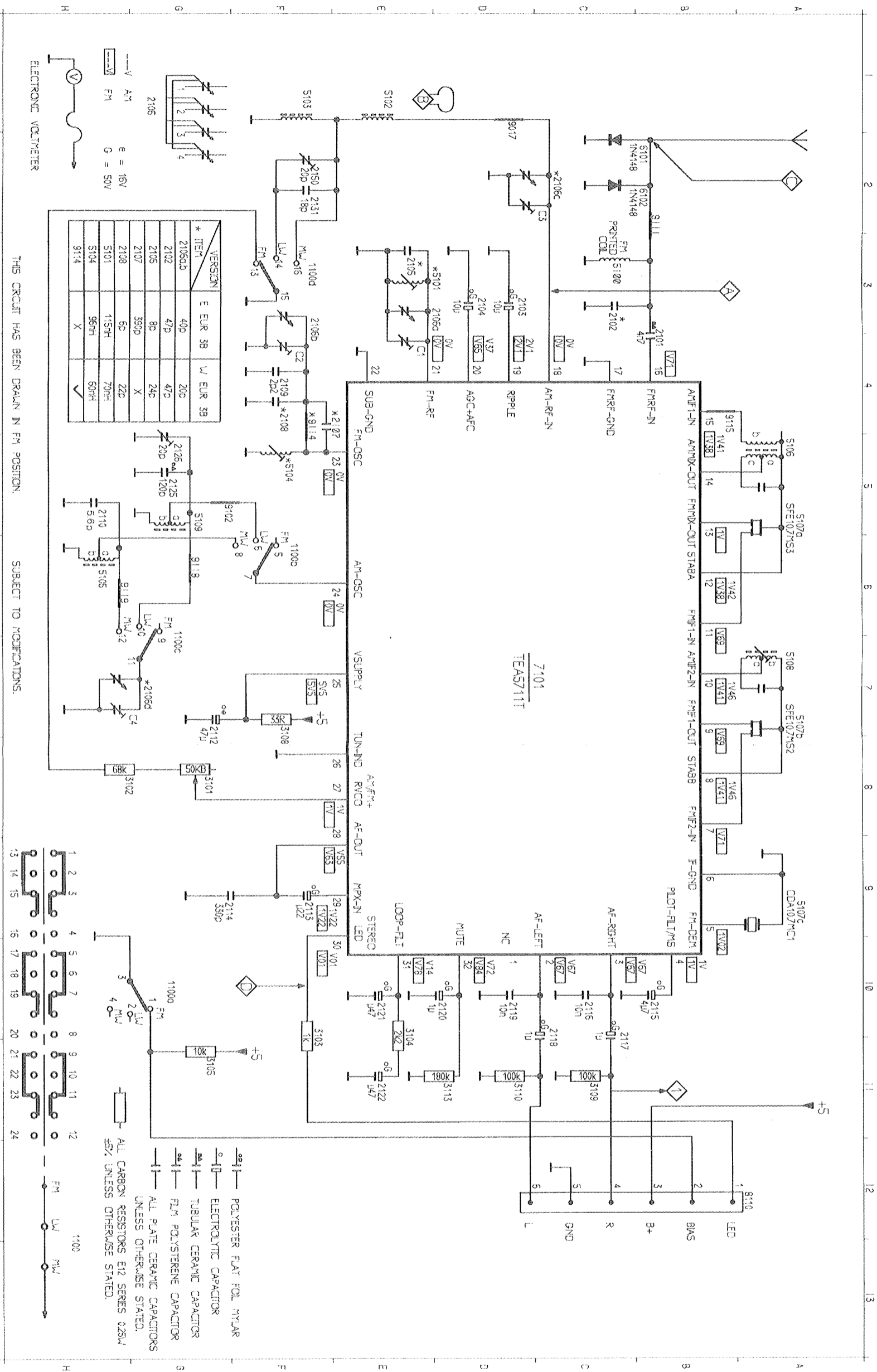

TUNER BOARD (MW/LW/FM)

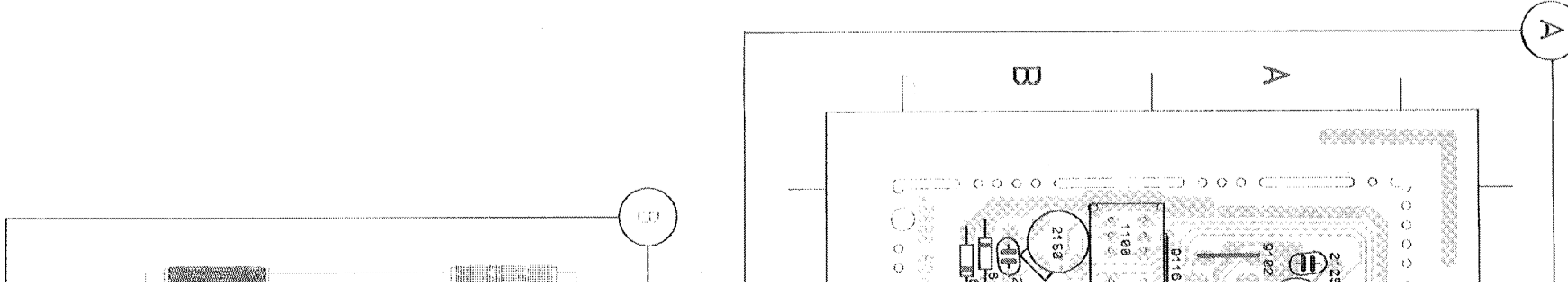

TUNER BOARD (MW/FM) - CIRCUIT DIAGRAM

1100a	F 6	2103	C 2	2106b	D 2	2109	E 4	2114	F 7	2118	C 9	2122	D 9	3102	F 6	3108	E 5	5100	B 2	5105	F 5	5107c	A 8	7101	C 5
1100b	A 9	2104	C 2	2106c	E 4	2110	E 4	2115	B 9	2119	C 9	2133	E 10	3103	E 9	3109	B 9	5101	D 1	5106	A 3	5107b	A 6	8110	A 10
2101	B 2	2105	D 1	2108	E 4	2113	E 7	2117	B 9	2120	D 9	3101	E 6	3104	A 9	3112	D 9	5102	C 1	5107a	A 4	6101	B 1	9101	E 3
2102	B 2	2106a	C 1	2108	E 4	2113	E 7	2117	B 9	2121	D 9	3101	E 6	3105	A 9	3113	D 9	5104	E 3	5107b	A 6	6102	B 1		

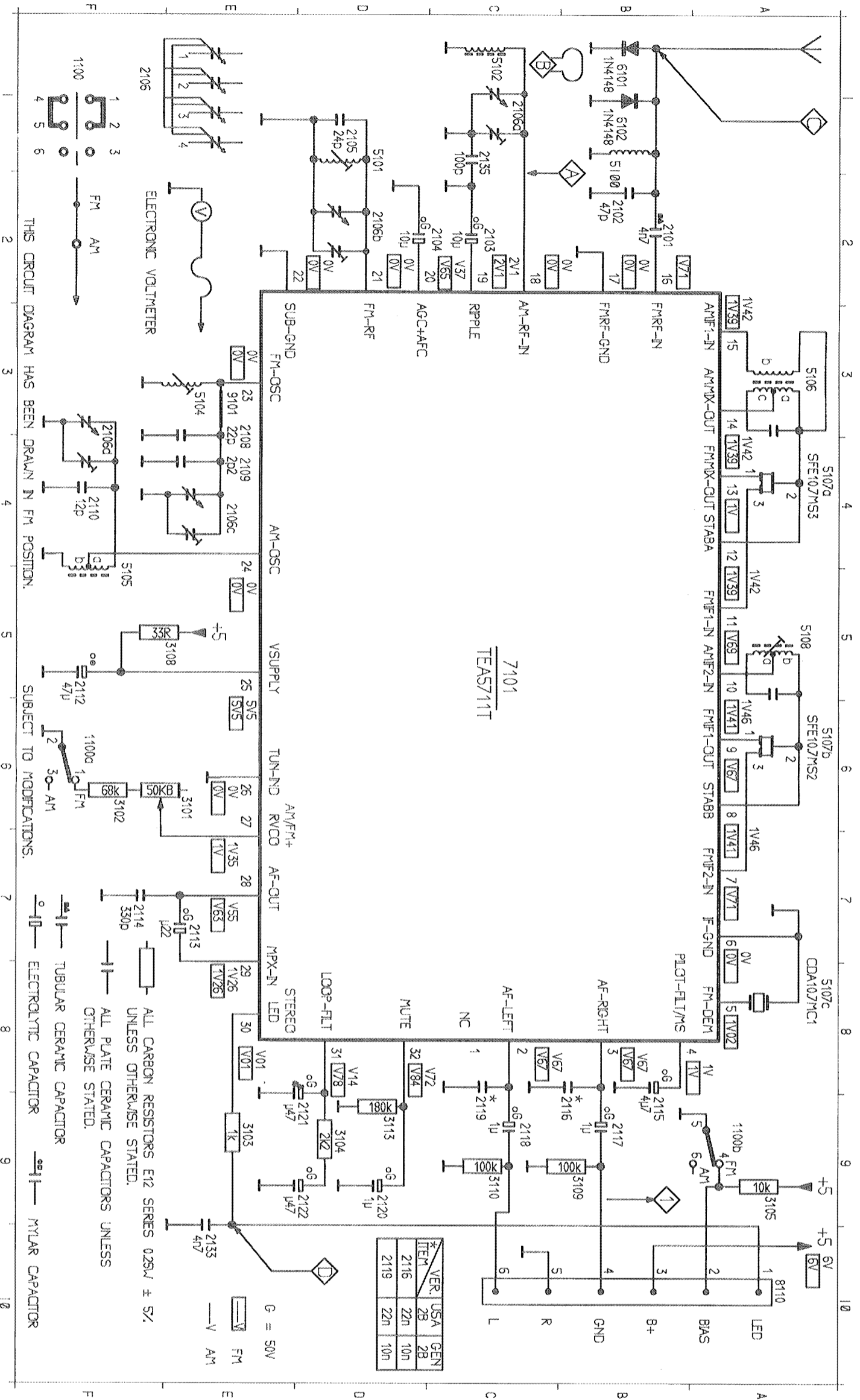

THIS CIRCUIT DIAGRAM HAS BEEN DRAWN IN FM POSITION.
SUBJECT TO MODIFICATIONS.

ALL CARBON RESISTORS E12 SERIES 0.25W ± 5%
UNLESS OTHERWISE STATED.
ALL PLATE CERAMIC CAPACITORS UNLESS
OTHERWISE STATED.
TUBULAR CERAMIC CAPACITOR
ELECTROLYTIC CAPACITOR
MYLAR CAPACITOR

G = 50V
FM
AM

VER.	USA	GEN
2116	28	28
2119	22n	10n
	22n	10n

TUNER BOARD (MW/FM) - LAYOUT DIAGRAM

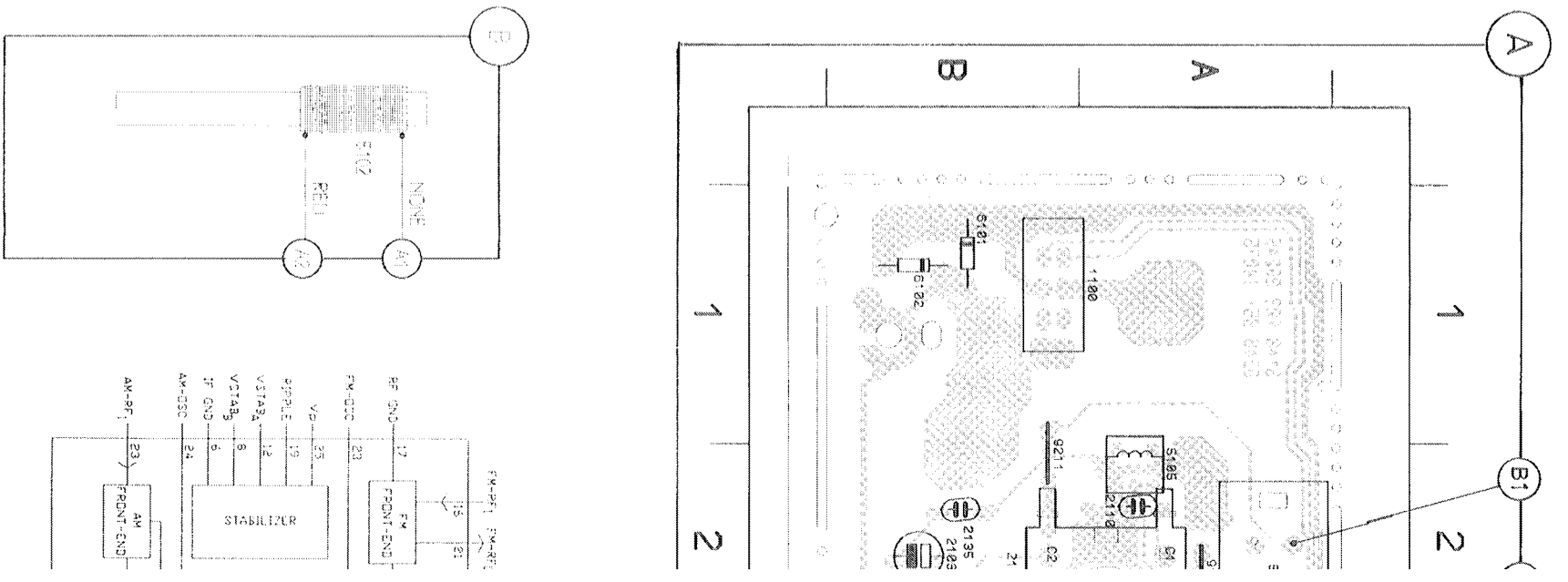

AM IF							
AM or MW	468KHZ	A	min.	5106 5108	1	max.	
AM RF							
MW *	512KHZ	B	max.	5105	H/P Jack	max.	
	1635KHZ		min.	C4			
	550KHZ			L2			
(see fig. 3)	1500KHZ	B		C3	H/P Jack	max.	
	520KHZ		max.	5105			
	1730KHZ		min.	C4			
AM *	550KHZ	B		L2	H/P Jack	max.	
	1500KHZ			C3			
	147KHZ		max.	5109			
LW *	291KHZ	B	min.	2126	H/P Jack	max.	
	155KHZ			5103			
	270KHZ		max.	2150			
FM IF							
FM #	10.7MHZ						symm. max. lin.
FM RF							
FM #	87.35MHZ	C	max.	5104	H/P Jack	max.	
	108.25MHZ		min.	C2			
	88MHZ			5101			
(see fig. 4 & 5)	106MHZ	C		C1	H/P Jack	max.	
	64.7MHZ		max.	5104			
	108.25MHZ		min.	C2			
FM # for -/14 (see fig. 4 & 5)	68MHZ	C		5101	H/P Jack	max.	
	106MHZ			C1			
	106MHZ		max.	5104			
STEREO DECODER							
FM #	98MHZ	C	98MHZ	3101	D	152 ± 1KHZ	

* Mod. 1KHz 30%
10nF + 15E
Repeat

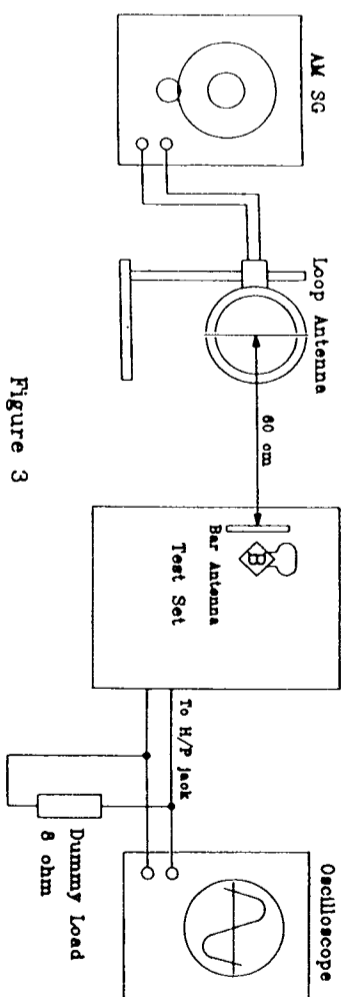

Figure 3

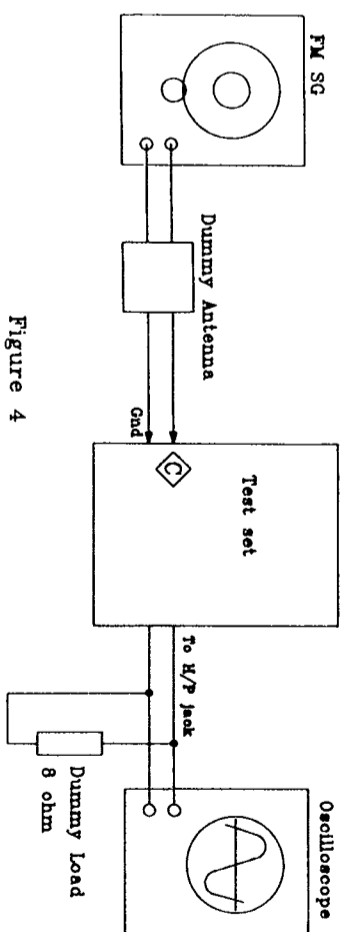

Figure 4

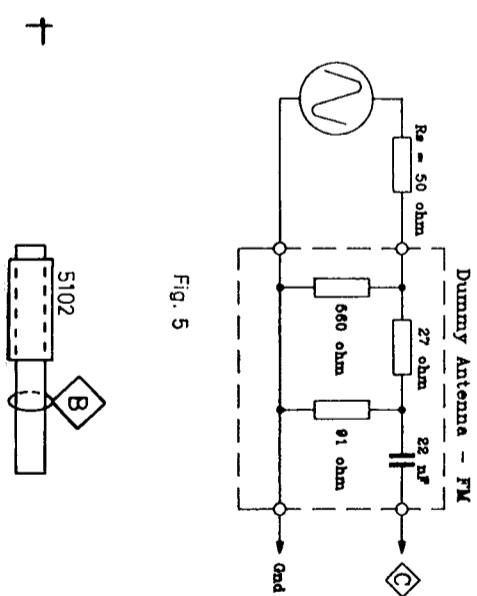
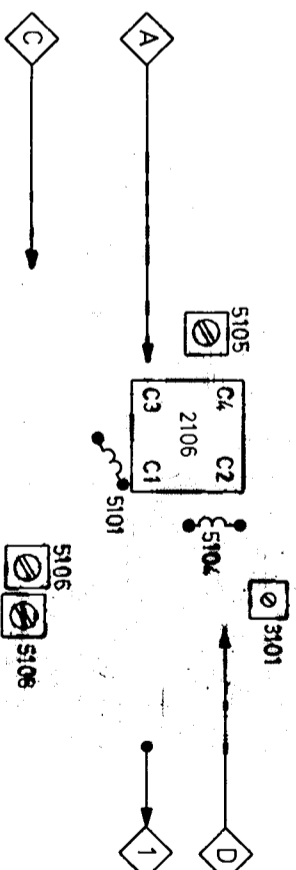
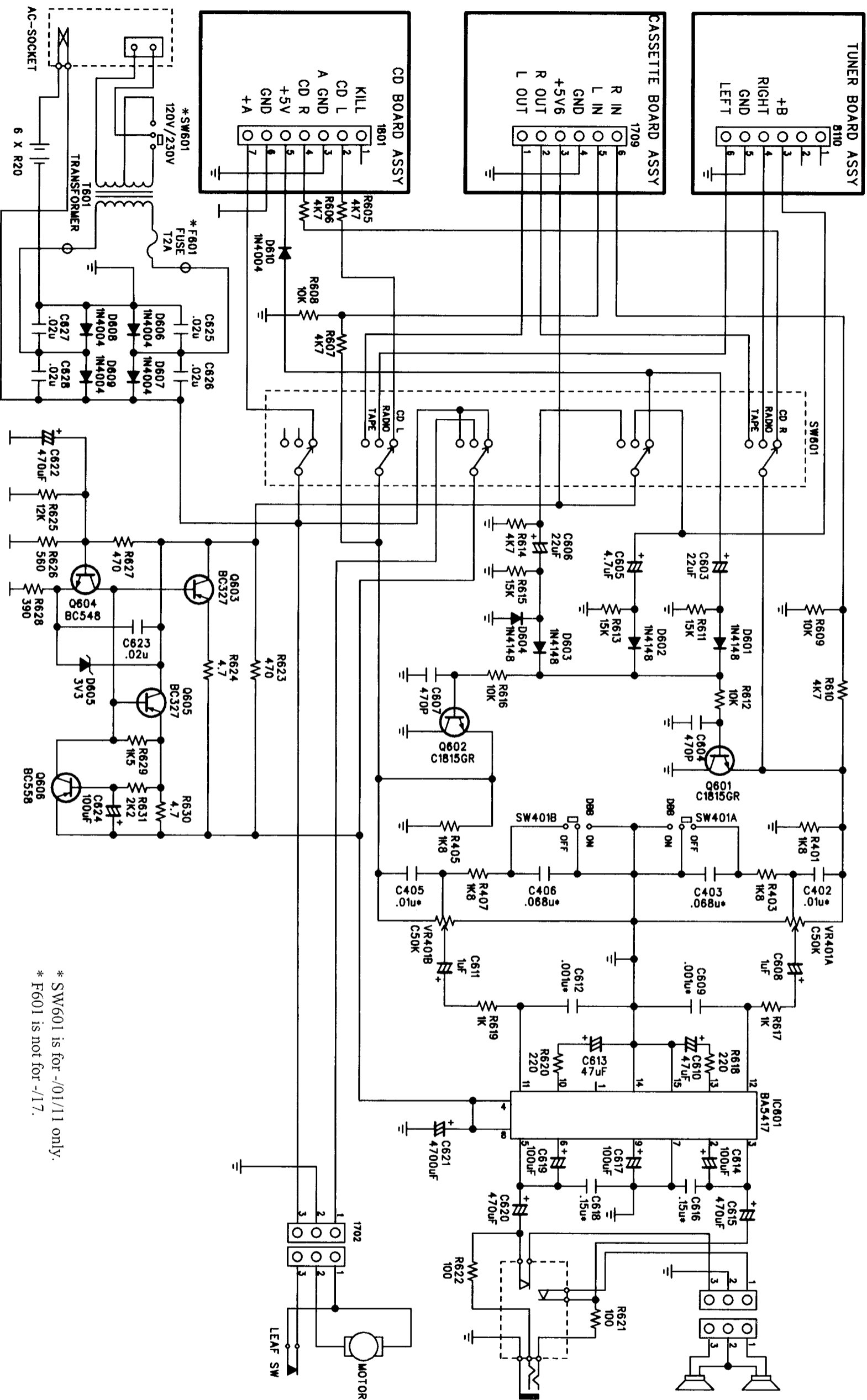
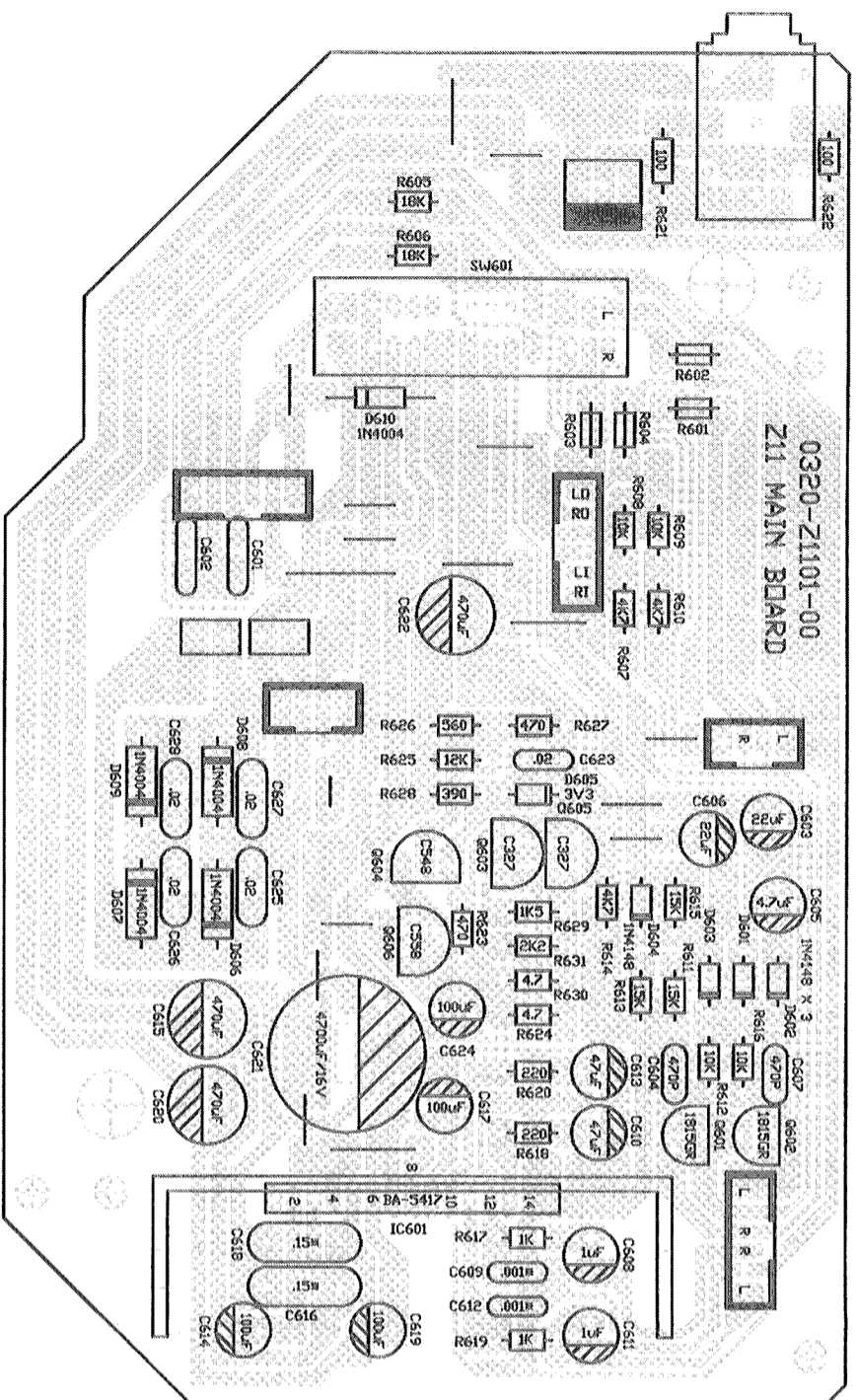

Fig. 5





* SW601 is for -/01/11 only.
 * F601 is not for -/17.



PIN	IC601 BA5417
1	0
2	8.42
3	4.52
4	9
5	4.52
6	8.42
7	0
8	9
9	5.13
10	0.818
11	0.016
12	0.016
13	0.818
14	0
15	0

	B	C	E
0603	7.98	6.16	8.60
0604	3.28	7.98	2.68
0605	7.98	6.16	8.62
0606	8.61	7.98	8.95

CONNECT BOARD - LAYOUT DIAGRAM

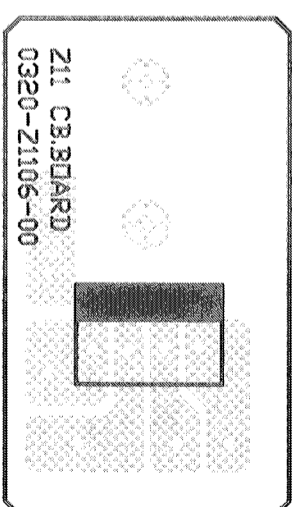

BATTERY CONTACT BOARD (R) - LAYOUT DIAGRAM

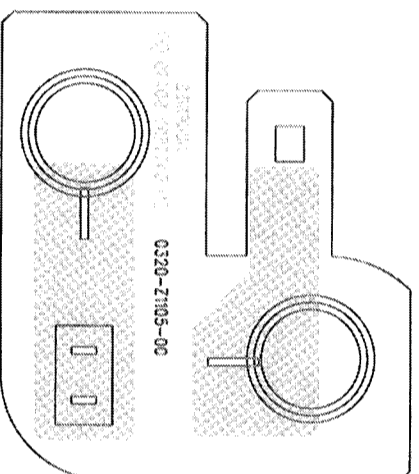
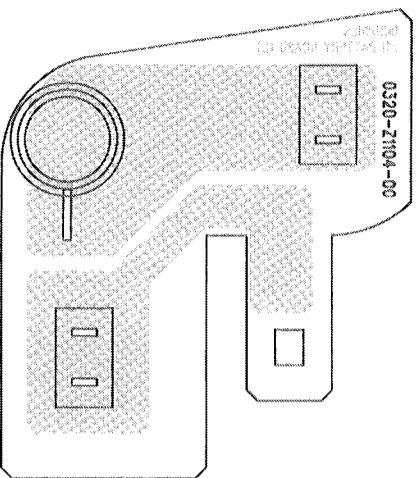

CONNECT BOARD 1 - LAYOUT DIAGRAM

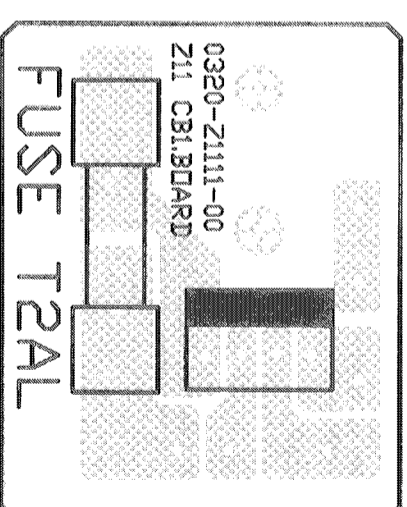

BATTERY CONTACT BOARD (L) - LAYOUT DIAGRAM

RECORDER BOARD - CIRCUIT DIAGRAM

10-1

10-1

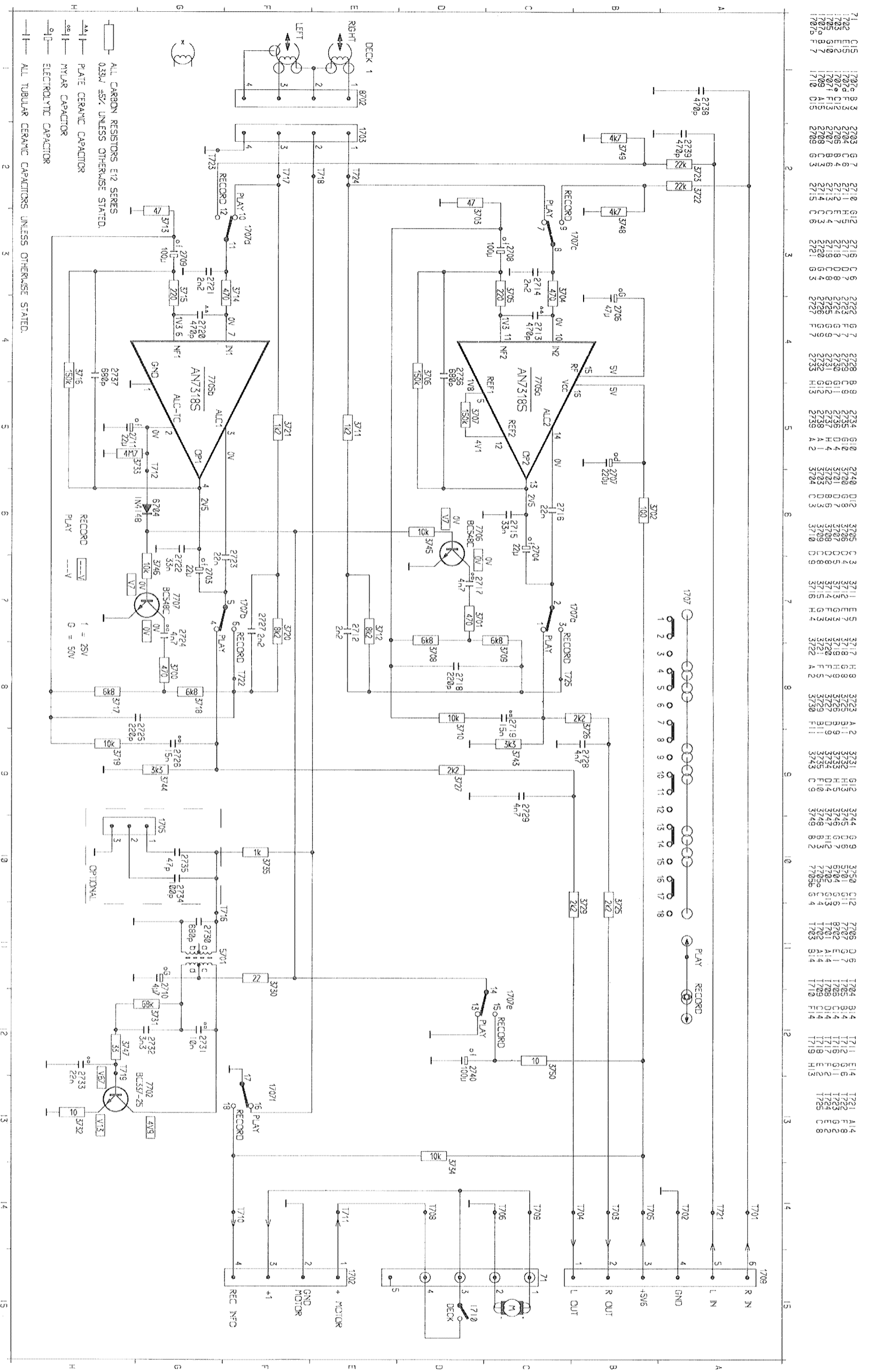

- 71 C15 7230 B 3
- 7231 C12 2704 B 4
- 7232 C12 2705 B 4
- 7233 C12 2706 B 4
- 7234 C12 2707 C 3
- 7235 C12 2708 C 3
- 7236 C12 2709 C 3
- 7237 C12 2710 C 3
- 7238 C12 2711 C 3
- 7239 C12 2712 C 3
- 7240 C12 2713 C 3
- 7241 C12 2714 C 3
- 7242 C12 2715 C 3
- 7243 C12 2716 C 3
- 7244 C12 2717 C 3
- 7245 C12 2718 C 3
- 7246 C12 2719 C 3
- 7247 C12 2720 C 3
- 7248 C12 2721 C 3
- 7249 C12 2722 C 3
- 7250 C12 2723 C 3
- 7251 C12 2724 C 3
- 7252 C12 2725 C 3
- 7253 C12 2726 C 3
- 7254 C12 2727 C 3
- 7255 C12 2728 C 3
- 7256 C12 2729 C 3
- 7257 C12 2730 C 3
- 7258 C12 2731 C 3
- 7259 C12 2732 C 3
- 7260 C12 2733 C 3
- 7261 C12 2734 C 3
- 7262 C12 2735 C 3
- 7263 C12 2736 C 3
- 7264 C12 2737 C 3
- 7265 C12 2738 C 3
- 7266 C12 2739 C 3
- 7267 C12 2740 C 3
- 7268 C12 2741 C 3
- 7269 C12 2742 C 3
- 7270 C12 2743 C 3
- 7271 C12 2744 C 3
- 7272 C12 2745 C 3
- 7273 C12 2746 C 3
- 7274 C12 2747 C 3
- 7275 C12 2748 C 3
- 7276 C12 2749 C 3
- 7277 C12 2750 C 3
- 7278 C12 2751 C 3
- 7279 C12 2752 C 3
- 7280 C12 2753 C 3
- 7281 C12 2754 C 3
- 7282 C12 2755 C 3
- 7283 C12 2756 C 3
- 7284 C12 2757 C 3
- 7285 C12 2758 C 3
- 7286 C12 2759 C 3
- 7287 C12 2760 C 3

ALL CARBON RESISTORS E12 SERIES
0.33W. 5%. UNLESS OTHERWISE STATED.
ALL TUBULAR CERAMIC CAPACITORS UNLESS OTHERWISE STATED.

—||— ELECTROLYTIC CAPACITOR
—||— MYLAR CAPACITOR
—||— PLATE CERAMIC CAPACITOR

1 = 25V
G = 50V

RECORDER BOARD - CIRCUIT DIAGRAM

10-1

10-1

RECORDER BOARD - CIRCUIT DIAGRAM

10-1

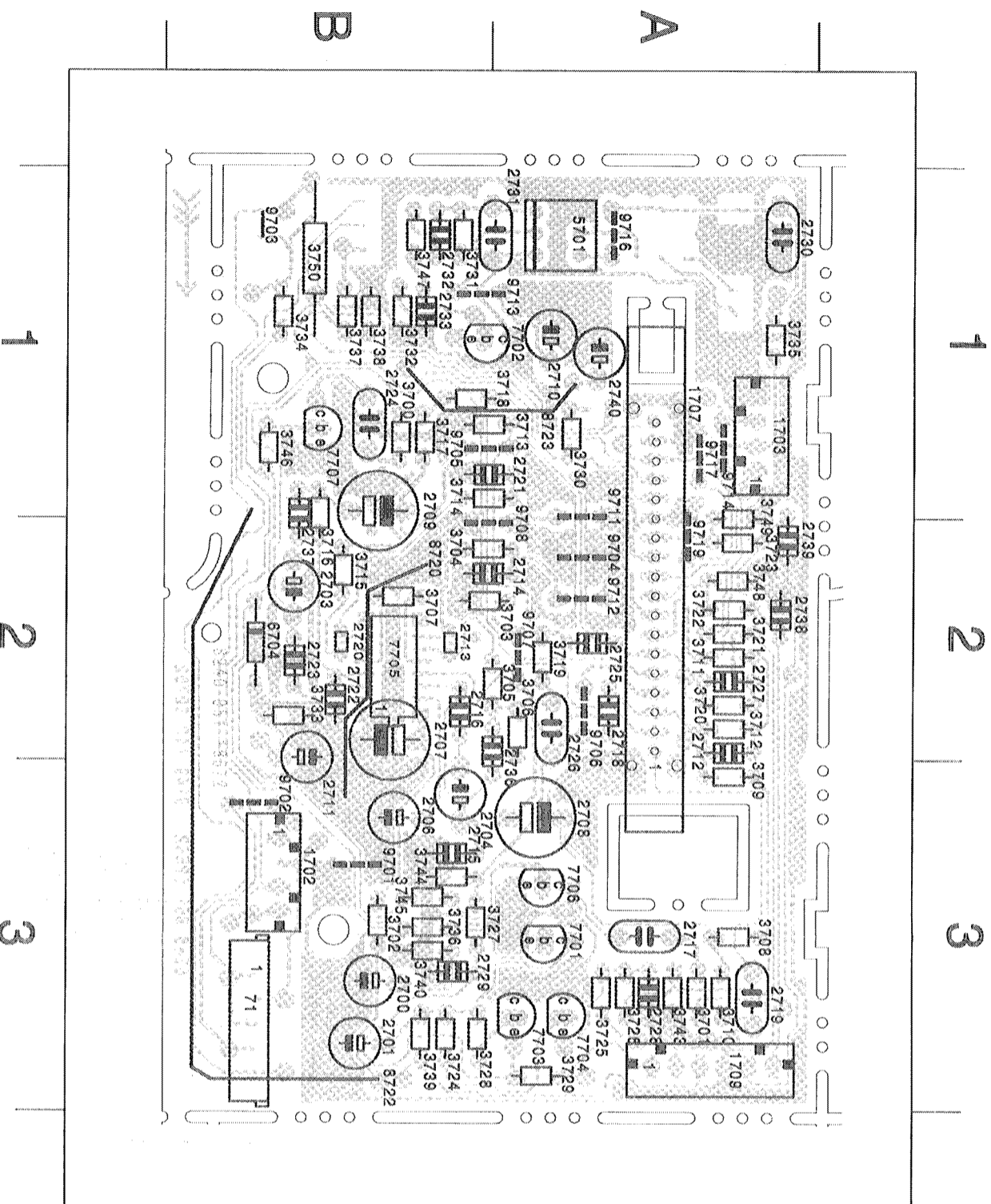

- | | | | |
|----------|----------|----------|----------|
| 71 B 3 | 2736 A 2 | 3792 B 1 | 9716 A 1 |
| 1702 B 3 | 2737 B 1 | 3763 B 2 | 9717 A 1 |
| 1703 A 1 | 2738 A 2 | 3734 B 1 | 9719 A 2 |
| 1707 A 2 | 2739 A 2 | 3735 A 1 | 8720 B 2 |
| 1709 A 3 | 2740 A 1 | 3736 B 3 | 8722 B 3 |
| 2700 B 3 | 3700 B 1 | 3737 B 1 | 8723 A 1 |
| 2701 B 3 | 3701 A 3 | 3738 B 1 | 9703 B 1 |
| 2703 B 2 | 3702 B 3 | 3739 B 3 | |
| 2704 B 3 | 3703 B 2 | 3740 B 3 | |
| 2706 B 3 | 3704 B 2 | 3743 A 3 | |
| 2707 B 2 | 3705 A 2 | 3744 B 3 | |
| 2708 A 3 | 3706 A 2 | 3745 B 3 | |
| 2709 B 1 | 3707 B 2 | 3746 B 1 | |
| 2710 A 1 | 3708 A 3 | 3747 B 1 | |
| 2711 B 2 | 3709 A 3 | 3748 A 2 | |
| 2712 A 2 | 3710 A 3 | 3749 A 2 | |
| 2713 B 2 | 3711 A 2 | 3750 B 1 | |
| 2714 B 2 | 3712 A 2 | 5701 A 1 | |
| 2715 B 3 | 3713 B 1 | 6704 B 2 | |
| 2716 B 2 | 3714 B 1 | 7701 A 3 | |
| 2717 A 3 | 3715 B 2 | 7702 B 1 | |
| 2718 A 2 | 3716 B 1 | 7703 A 3 | |
| 2719 A 3 | 3717 B 1 | 7704 A 3 | |
| 2720 B 2 | 3718 B 1 | 7705 B 2 | |
| 2721 B 1 | 3719 A 2 | 7706 A 3 | |
| 2722 B 2 | 3720 A 2 | 7707 B 1 | |
| 2723 B 2 | 3721 A 2 | 9701 B 3 | |
| 2724 B 1 | 3722 A 2 | 9702 B 3 | |
| 2725 A 2 | 3723 A 2 | 9704 A 2 | |
| 2726 A 2 | 3724 B 3 | 9705 B 1 | |
| 2727 A 2 | 3725 A 3 | 9706 A 2 | |
| 2728 A 3 | 3726 A 3 | 9707 A 2 | |
| 2729 B 3 | 3727 B 3 | 9708 B 2 | |
| 2730 A 1 | 3728 B 3 | 9711 A 1 | |
| 2731 A 1 | 3729 A 3 | 9712 A 2 | |
| 2732 B 1 | 3730 A 1 | 9713 B 1 | |
| 2733 B 1 | 3731 B 1 | 9714 A 1 | |

CASSETTE ADJUSTMENT

Adjustment	Cassette	SK	Deck 1	Measure on	Read on	Adjust with	Adjust to
Azimuth	10KHZ SBC420*	TAPE	Play	H/P Jack	mV meter	Left hand Screw R/P Head	max.
Motor Speed	3150KHZ SBC420*	TAPE	Play	H/P Jack	Wow and flutter meter	Preset in motor	**a

* SBC420 : 4822 397 30071

**a The maximum permissible speed deviation is ± 3%.
Moreover, the wow and flutter value can be read.

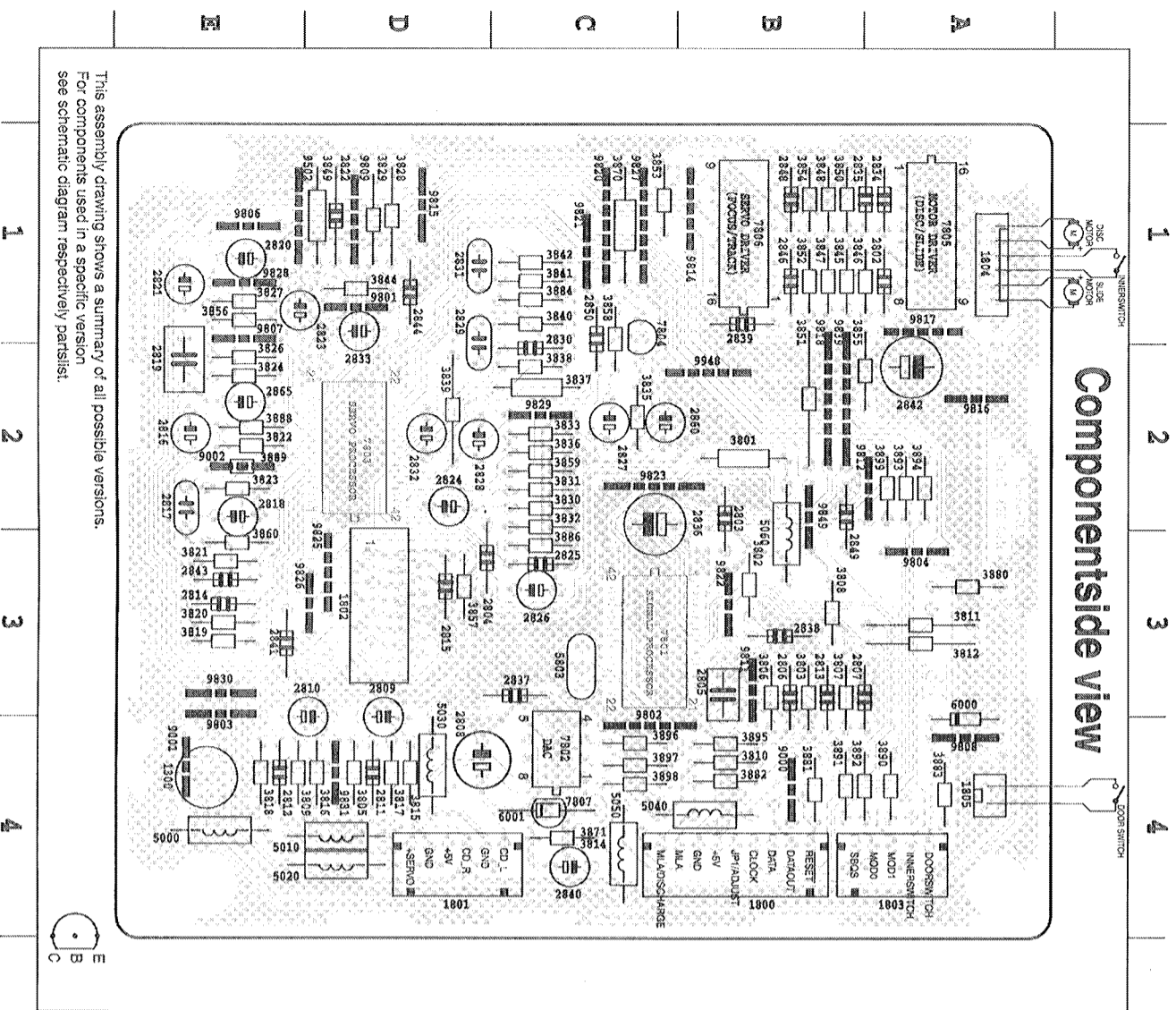

1200 E 4	3907 B 3	3891 B 4
1800 B 4	3808 B 3	3892 A 4
1801 D 4	3809 B 4	3893 A 2
1802 D 3	3810 A 4	3894 A 2
1803 A 4	3811 A 3	3895 B 4
1804 A 1	3812 A 3	3896 C 4
1805 A 4	3814 C 4	3897 C 4
2802 A 1	3815 D 4	3898 C 4
2803 B 2	3817 D 4	5000 E 4
2804 D 3	3818 D 4	5010 D 4
2805 B 3	3819 E 3	5020 D 4
2806 B 3	3820 E 3	5030 B 4
2807 A 3	3821 E 3	5040 B 4
2808 D 4	3822 E 2	5050 C 4
2809 D 4	3823 E 2	5060 B 3
2810 D 4	3824 E 2	5803 C 3
2811 D 4	3825 E 2	6001 C 4
2812 B 3	3826 E 2	6001 C 4
2813 B 3	3827 E 2	7802 C 4
2814 B 3	3828 D 1	7804 C 1
2815 D 3	3829 D 1	7805 A 1
2816 E 2	3830 C 2	7806 A 1
2817 E 2	3831 C 2	7807 C 4
2818 E 2	3832 C 2	8000 B 4
2819 B 2	3833 C 2	9000 B 4
2820 E 1	3834 C 2	9001 E 4
2821 E 1	3835 C 2	9002 E 2
2822 D 1	3836 C 2	9502 E 1
2823 D 1	3837 C 2	9502 E 1
2824 D 2	3838 C 2	9801 D 1
2825 C 2	3839 C 2	9802 C 4
2826 C 2	3840 C 1	9803 E 3
2827 C 2	3841 C 1	9804 A 3
2828 D 2	3842 C 1	9805 E 1
2829 D 2	3843 D 1	9807 E 4
2830 C 2	3844 D 1	9808 A 4
2831 A 1	3845 A 1	9809 D 1
2832 D 1	3847 B 1	9811 B 3
2833 D 1	3848 B 1	9812 A 2
2834 A 1	3849 D 1	9814 B 1
2835 A 1	3850 B 1	9815 D 1
2836 C 1	3851 B 2	9816 A 2
2837 C 2	3852 B 1	9817 A 1
2838 B 1	3853 C 1	9818 B 2
2839 B 1	3854 B 1	9820 C 1
2840 A 2	3855 A 2	9821 C 1
2841 C 4	3856 B 1	9822 B 3
2842 A 2	3857 D 1	9823 C 2
2843 A 2	3858 C 2	9825 D 3
2844 D 1	3859 C 2	9826 D 3
2845 D 1	3860 B 3	9827 C 1
2846 B 1	3870 C 1	9828 B 1
2847 B 1	3871 C 4	9829 C 2
2848 B 2	3880 A 3	9830 C 3
2849 C 1	3881 B 4	9831 D 4
2850 C 2	3882 B 4	9832 B 2
2851 C 2	3883 B 2	9833 A 4
2852 E 2	3884 C 1	9848 B 2
2853 E 2	3885 C 3	9848 B 2
2854 C 3	3888 E 2	7803 C 3
2855 E 2	3889 E 2	7803 D 2
2856 E 2	3890 A 4	3890 A 4

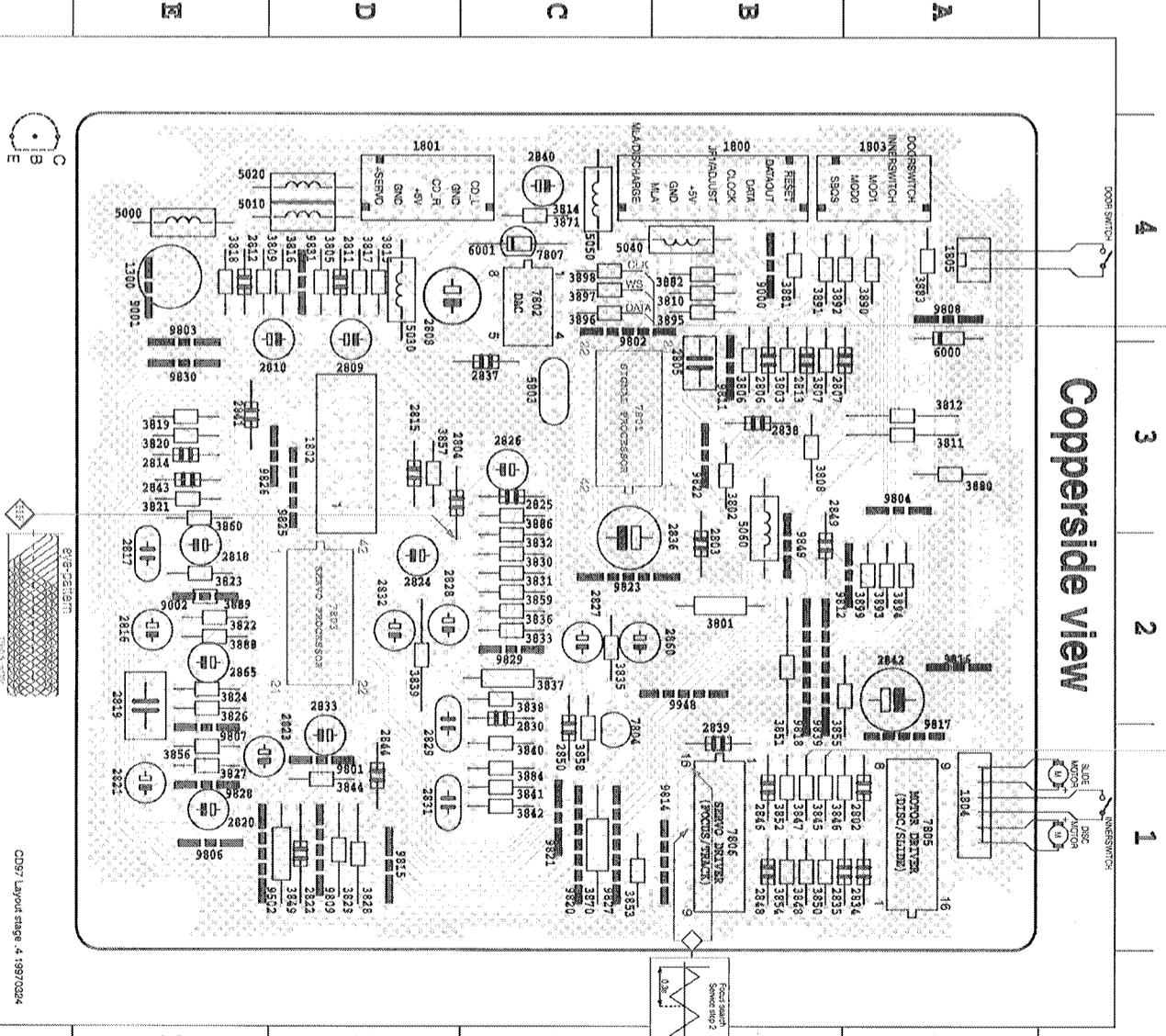

1200 E 4	3907 B 3	3891 B 4
1800 B 4	3808 B 3	3892 A 4
1801 D 4	3809 B 4	3893 A 2
1802 D 3	3810 A 4	3894 A 2
1803 A 4	3811 A 3	3895 B 4
1804 A 1	3812 A 3	3896 C 4
1805 A 4	3814 C 4	3897 C 4
2802 A 1	3815 D 4	3898 C 4
2803 B 2	3817 D 4	5000 E 4
2804 D 3	3818 D 4	5010 D 4
2805 B 3	3819 E 3	5020 D 4
2806 B 3	3820 E 3	5030 B 4
2807 A 3	3821 E 3	5040 B 4
2808 D 4	3822 E 2	5050 C 4
2809 D 4	3823 E 2	5060 B 3
2810 D 4	3824 E 2	5803 C 3
2811 D 4	3825 E 2	6001 C 4
2812 B 3	3826 E 2	6001 C 4
2813 B 3	3827 E 2	7802 C 4
2814 B 3	3828 D 1	7804 C 1
2815 D 3	3829 D 1	7805 A 1
2816 E 2	3830 C 2	7806 A 1
2817 E 2	3831 C 2	7807 C 4
2818 E 2	3832 C 2	8000 B 4
2819 B 2	3833 C 2	9000 B 4
2820 E 1	3834 C 2	9001 E 4
2821 E 1	3835 C 2	9002 E 2
2822 D 1	3836 C 2	9502 E 1
2823 D 1	3837 C 2	9502 E 1
2824 D 2	3838 C 2	9801 D 1
2825 C 2	3839 C 2	9802 C 4
2826 C 2	3840 C 1	9803 E 3
2827 C 2	3841 C 1	9804 A 3
2828 D 2	3842 C 1	9805 E 1
2829 D 2	3843 D 1	9807 E 4
2830 C 2	3844 D 1	9808 A 4
2831 A 1	3845 A 1	9809 D 1
2832 D 1	3847 B 1	9811 B 3
2833 D 1	3848 B 1	9812 A 2
2834 A 1	3849 D 1	9814 B 1
2835 A 1	3850 B 1	9815 D 1
2836 C 1	3851 B 2	9816 A 2
2837 C 2	3852 B 1	9817 A 1
2838 B 1	3853 C 1	9818 B 2
2839 B 1	3854 B 1	9820 C 1
2840 A 2	3855 A 2	9821 C 1
2841 C 4	3856 B 1	9822 B 3
2842 A 2	3857 D 1	9823 C 2
2843 A 2	3858 C 2	9825 D 3
2844 D 1	3859 C 2	9826 D 3
2845 D 1	3860 B 3	9827 C 1
2846 B 1	3870 C 1	9828 B 1
2847 B 1	3871 C 4	9829 C 2
2848 B 2	3880 A 3	9830 C 3
2849 C 1	3881 B 4	9831 D 4
2850 C 2	3882 B 4	9832 B 2
2851 C 2	3883 B 2	9833 A 4
2852 E 2	3884 C 1	9848 B 2
2853 E 2	3885 C 3	9848 B 2
2854 C 3	3888 E 2	7803 C 3
2855 E 2	3889 E 2	7803 D 2
2856 E 2	3890 A 4	3890 A 4

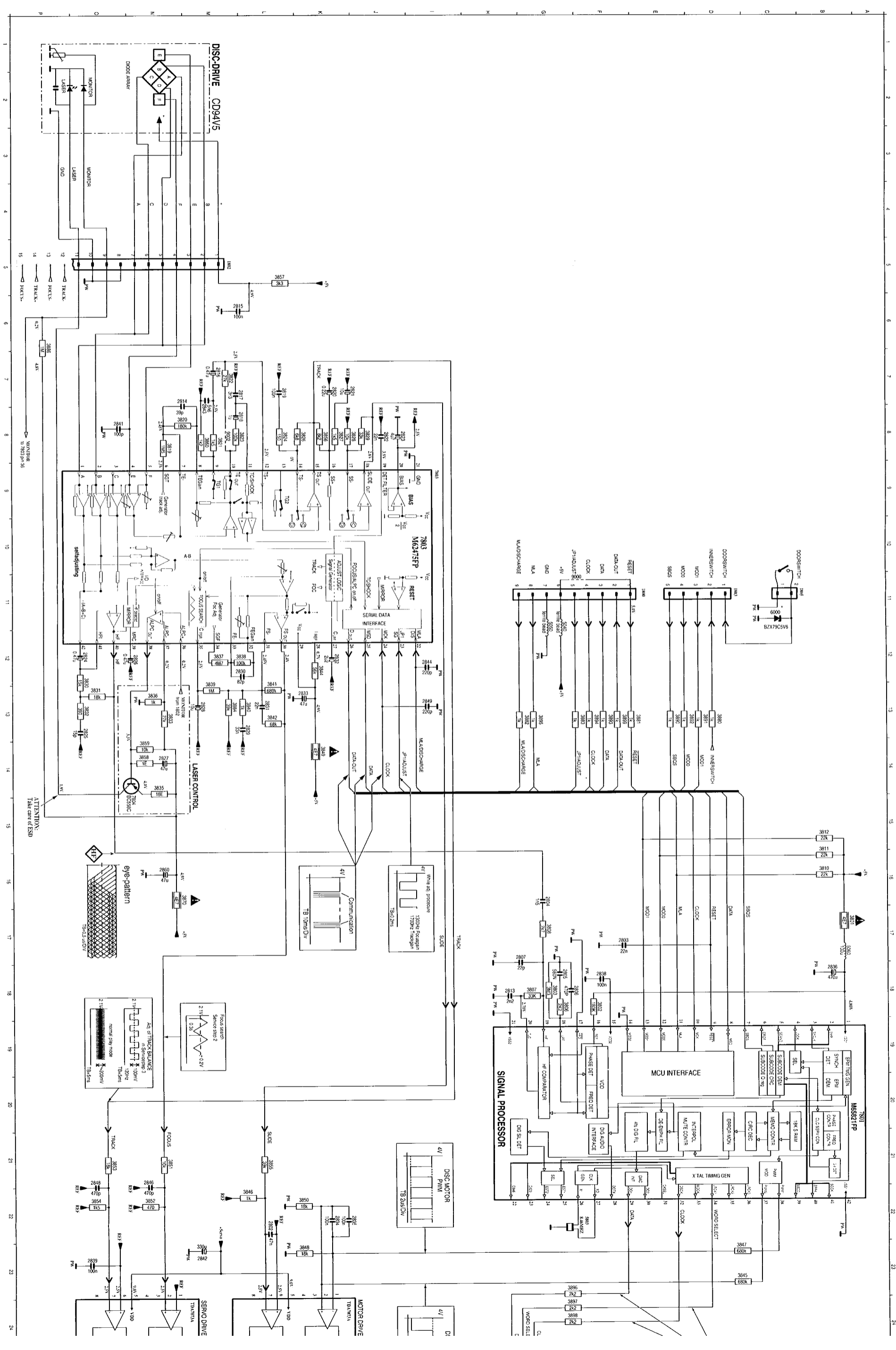

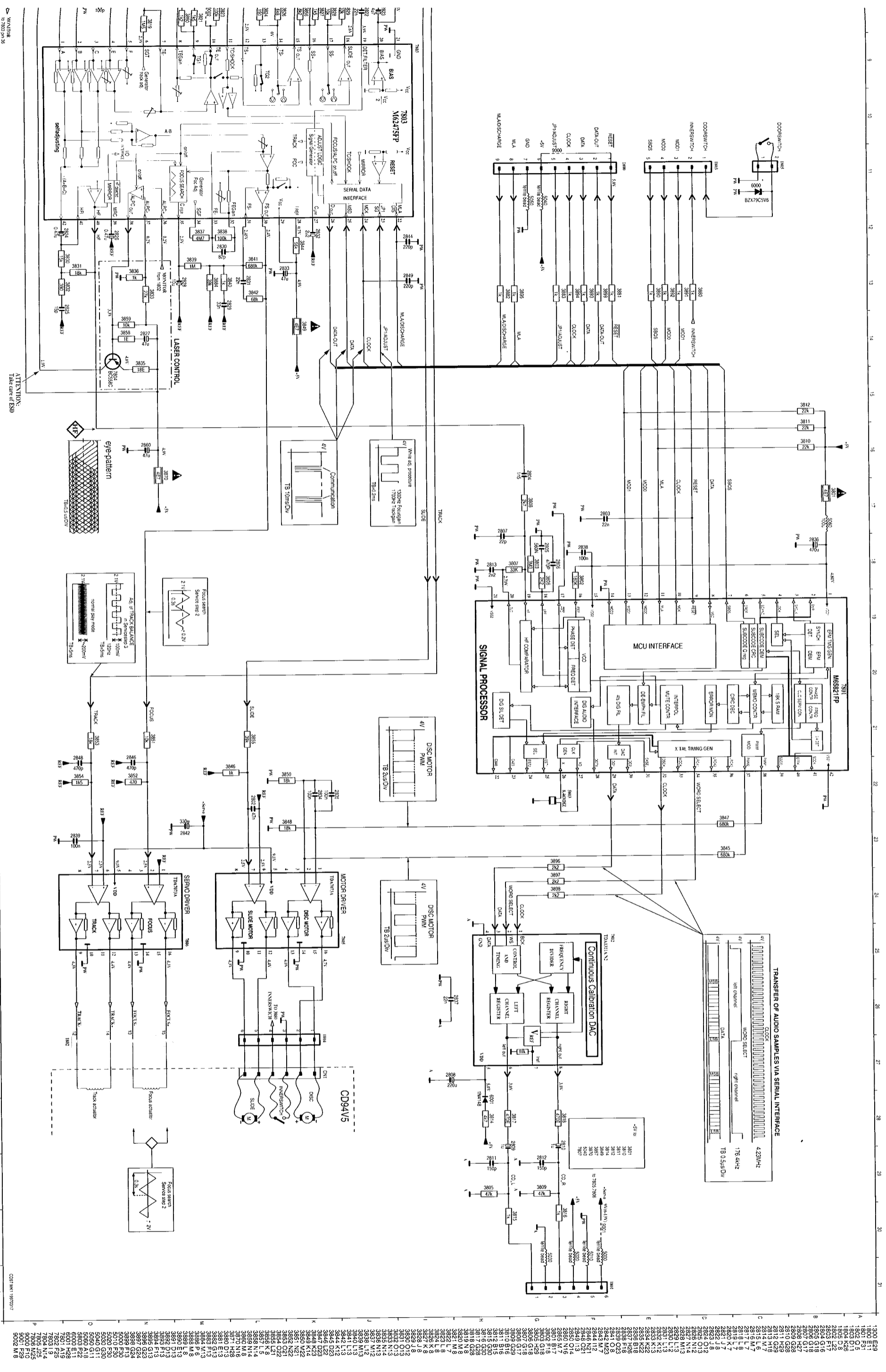

SCREW LIST :

1	M2 x 5
2	M2.6 x 6
3	M3 x 8
4	T2 x 6
5	T2 x 8
6	T3 x 8
7	T3 x 10
8	T3 x 12
9	T3 x 14
10	T3 x 32

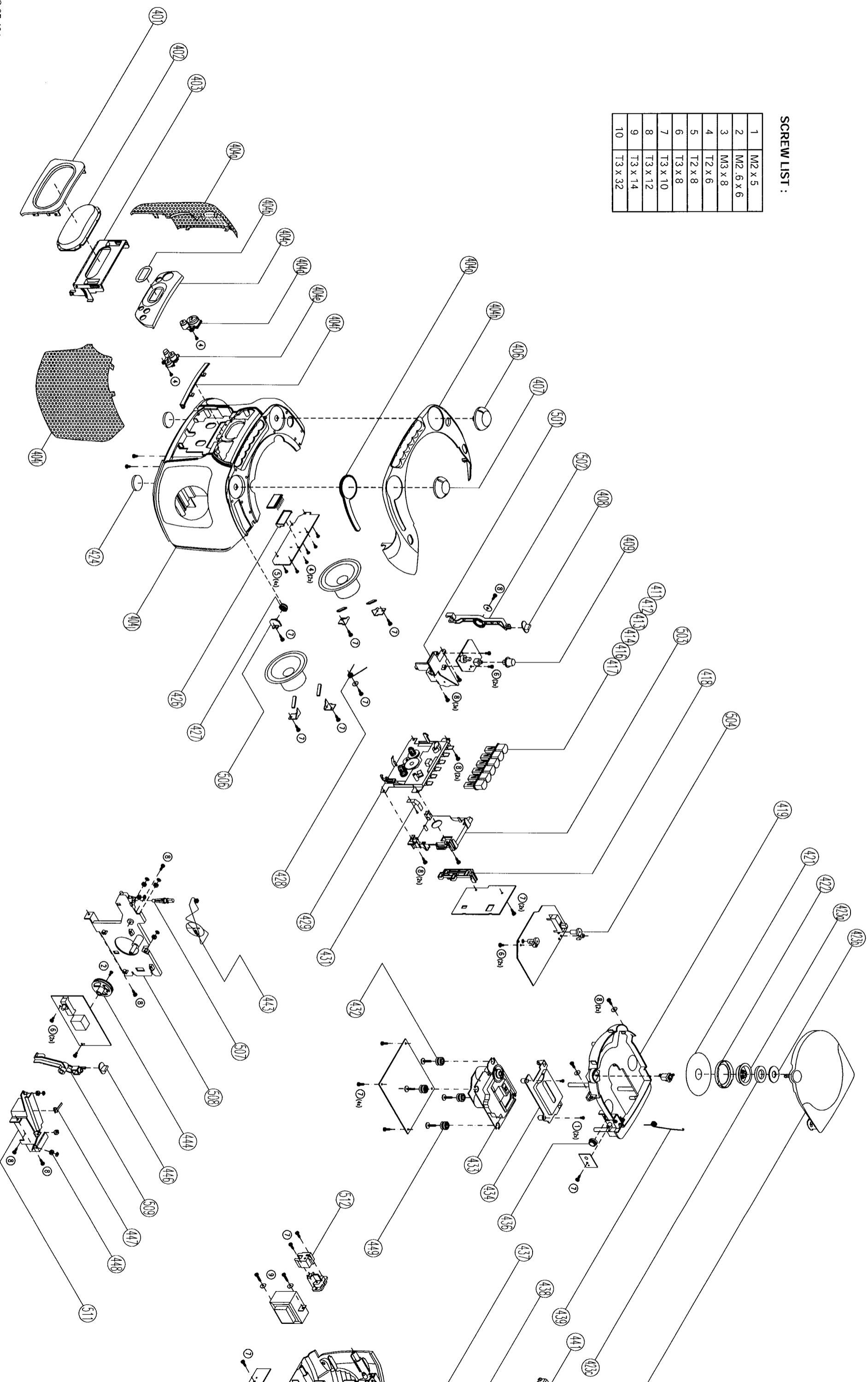

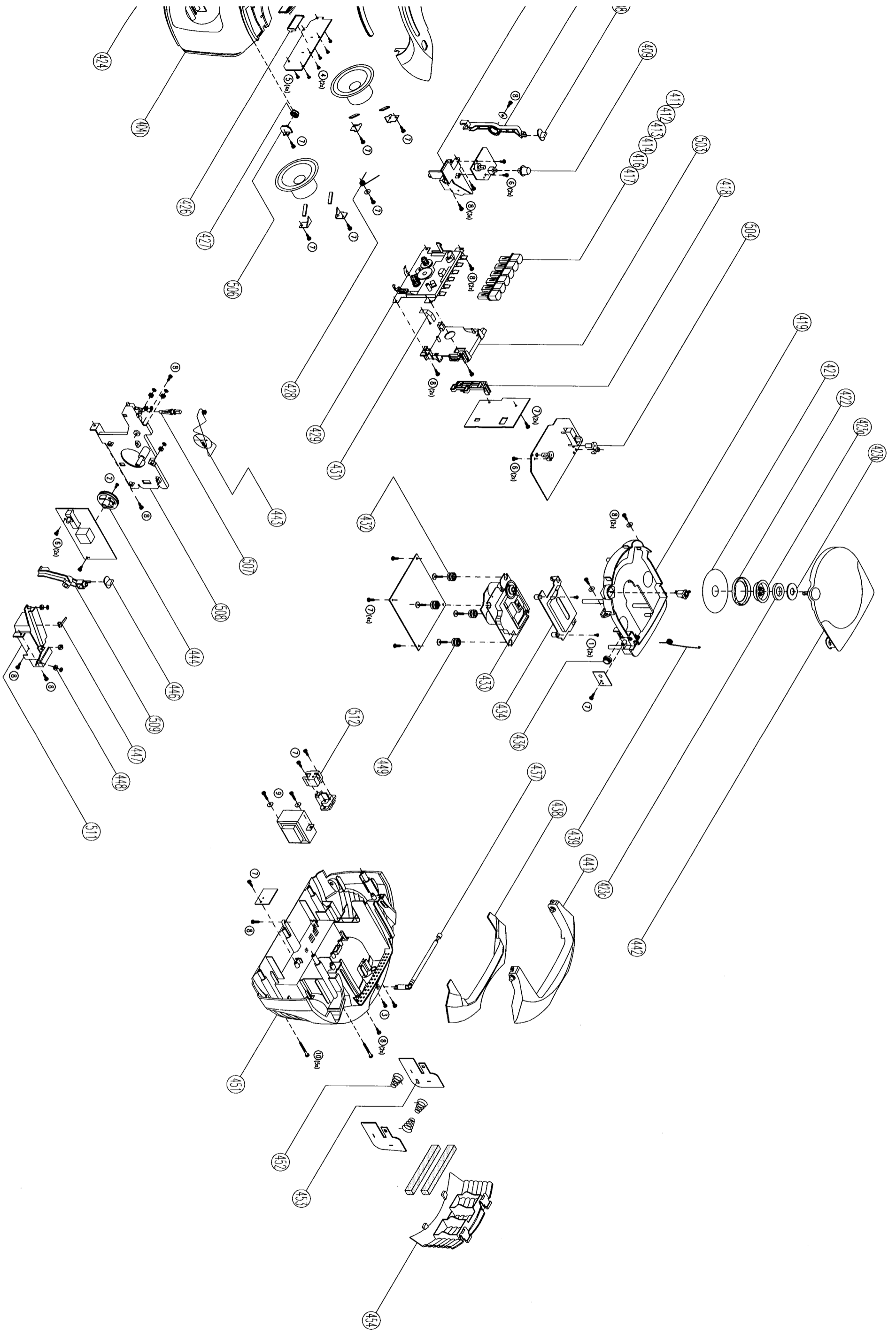

401	4822 443 10962	Cassette Door	441	4822 498 10701	Handle
402	4822 450 10512	Cass Door Lens	442	4822 443 10961	CD Door
403	4822 402 11067	Cass Door Bracket	443	4822 492 11639	Dial Spring
406	4822 410 11839	Volume Knob	444	4822 528 11261	Dial Drum
407	4822 410 11843	Tuning Knob	446	4822 410 11841	Band Knob
408	4822 410 11841	Function Knob	447	4822 450 10513	Dial Pointer
409	4822 410 11842	DBB Knob	448	4822 528 11263	Dial Pulley (B)
411	4822 410 11872	Cass Knob (Pause)	449	4822 529 10386	Damper Rubber (30 DEG)
412	4822 410 11872	Cass Knob (Stop)	452	4822 492 11641	Battery Contact Spring (-ve)
413	4822 410 11872	Cass Knob (Rew)	453	4822 492 11204	Battery Contact Plate (+ve)
414	4822 410 11872	Cass Knob (F.F.)	454	4822 443 10963	Battery Door
416	4822 410 11872	Cass Knob (Play)		4822 528 11262	Dial Pulley (A)
417	4822 410 11872	Cass Knob (Rec)		4822 736 16127	Instruction Manual (For-/00)
418	4822 402 10126	Lever Recording		4822 736 16136	Instruction Manual (For-/01)
419	4822 418 10348	CD Tray		4822 736 16128	Instruction Manual (For-/17)
421	4822 535 60096	Disc			
422	4822 532 12241	Ring (CD-Lid)			
423	4822 532 12798	Pressure Ring Assy			
426	4822 402 11069	LCD Bracket			
427	4822 522 10706	Cass Door Gear			
428	4822 492 11637	Cass Door Spring			
429	4822 691 10612	Cass Deck Mechanism			
431	4822 492 11061	Spring Recording			
432	4822 529 10387	Damper Rubber (40 DEG)			
433	4822 691 10654	CD Mechanism CD94V5T1			
434	4822 442 01096	CD Lens Cover			
436	4822 522 10706	CD Gear			
437	4822 303 14073	Swivel Rod Antenna			
438	4822 466 11934	Handle Back Plate			
439	4822 492 11638	CD Door Spring			

Note : Only those parts mentioned in the are normal service parts.

MECHANICAL PARTSLIST - TAPE DECK

10	4822 528 70849	Pinch Roller Arm (B)	110	4822 278 90721	Leaf Switch
11	4822 528 70695	Pinch Roller Assy	111	4822 249 30218	MS18R-AKONI
74	4822 403 70968	Eject Hook (A)	112	4822 249 40306	E. Head
106	4822 358 31325	Main Belt 45.2 x 1.2	115	4822 361 21565	Motor EG-530AD-9B
107	4822 358 31124	Sub Belt 44.7 x 1.2	116	4822 528 81497	Motor Pulley

Note : Only those parts mentioned in the are normal service parts.

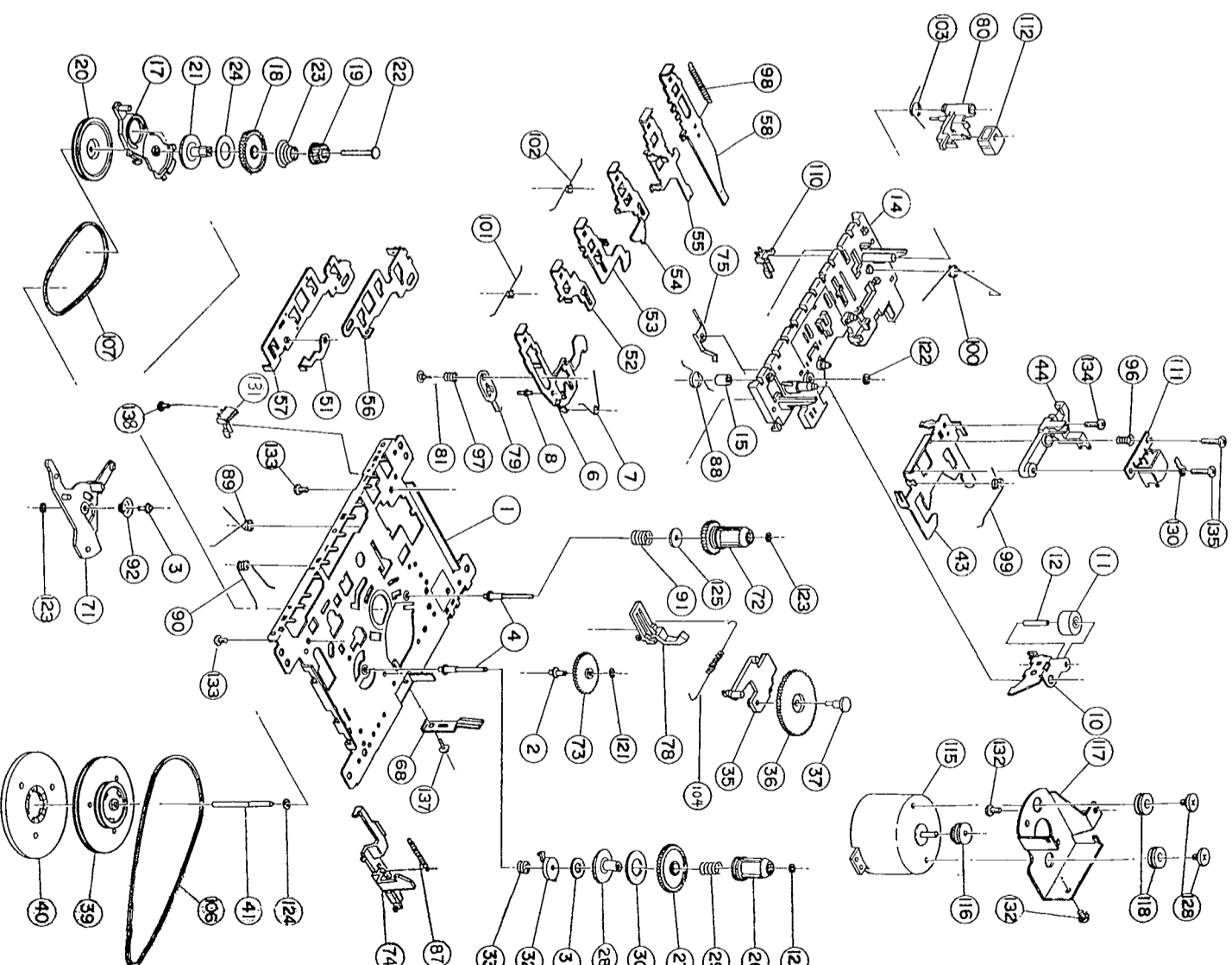

RECORDER BOARD

13-1

		
2703	4822 124 81151	22µF 50V
2704	4822 124 81151	22µF 50V
2706	4822 124 40433	47µF 20% 25V
2707	4822 124 80144	220µF 20% 25V
2708	4822 124 42446	100µF 20% 10V
2709	4822 124 42446	100µF 20% 10V
2710	4822 124 22726	4.7µF 35V
2711	4822 124 81151	22µF 50V
2712	4822 126 12339	2.2nF 10% Y5R
2713	5322 122 32311	470pF 10% 100V
2714	4822 126 12339	2.2nF 10% Y5R
2715	4822 126 13174	33nF +80-20% 16V
2716	4822 126 11585	22nF +80-20% Y5V 25V
2717	4822 121 10686	4.7nF 10% 50V
2718	4822 122 10466	220pF 10% 50V
2719	4822 121 51305	15nF 10% 50V
2720	5322 122 32311	470pF 10% 100V
2721	4822 126 12339	2.2nF 10% Y5R
2722	4822 126 13174	33nF +80-20% 16V
2723	4822 126 11585	22nF +80-20% Y5V 25V
2724	4822 121 10686	4.7nF 10% 50V
2725	4822 122 10466	220pF 10% 50V
2726	4822 121 51305	15nF 10% 50V
2727	4822 126 12339	2.2nF 10% Y5R
2728	4822 126 11714	4.7nF 20%
2729	4822 126 11714	4.7nF 20%
2730	4822 126 14316	680pF 10% 50V Y5P
2731	4822 121 41857	10nF 5% 250V
2732	4822 126 11714	4.7nF 20%
2733	4822 121 70619	22nF 10% 50V
2736	4822 126 14316	680pF 10% 50V Y5P
2737	4822 126 14316	680pF 10% 50V Y5P
2738	4822 122 33519	470pF 10% 50V
2739	4822 122 33519	470pF 10% 50V
2740	4822 124 42446	100µF 20% 10V
3700	4822 116 83883	470R 5% 0.5W
3701	4822 116 83883	470R 5% 0.5W
3702	4822 116 52175	100R 5% 0.5W
3703	4822 116 52195	47R 5% 0.5W
3704	4822 116 83883	470R 5% 0.5W

		
3705	4822 116 83872	220R 5% 0.5W
3706	4822 116 52245	150K 5% 0.5W
3707	4822 116 52245	150K 5% 0.5W
3708	4822 116 83961	6K8 5%
3709	4822 116 83961	6K8 5%
3710	4822 116 83864	10K 5% 0.5W
3711	4822 116 52207	1K2 5% 0.5W
3712	4822 116 52303	8K2 5% 0.5W
3713	4822 116 52195	47R 5% 0.5W
3714	4822 116 83883	470R 5% 0.5W
3715	4822 116 83872	220R 5% 0.5W
3716	4822 116 52245	150K 5% 0.5W
3717	4822 116 83961	6K8 5%
3718	4822 116 83961	6K8 5%
3719	4822 116 83864	10K 5% 0.5W
3720	4822 116 52303	8K2 5% 0.5W
3721	4822 116 52207	1K2 5% 0.5W
3722	4822 116 52257	22K 5% 0.5W
3723	4822 116 52257	22K 5% 0.5W
3725	4822 116 52256	2K2 5% 0.5W
3726	4822 116 52256	2K2 5% 0.5W
3727	4822 116 52256	2K2 5% 0.5W
3729	4822 116 52256	2K2 5% 0.5W
3730	4822 116 52186	22R 5% 0.5W
3731	4822 116 52297	68K 5% 0.5W
3732	4822 116 52176	10R 5% 0.5W
3733	4822 111 30893	4M7 5% 0.2W
3734	4822 116 83864	10K 5% 0.5W
3735	4822 050 21002	1K 1% 0.6W
3743	4822 116 52269	3K3 5% 0.5W
3744	4822 116 52269	3K3 5% 0.5W
3745	4822 116 83864	10K 5% 0.5W
3746	4822 116 83864	10K 5% 0.5W
3747	4822 116 52191	33R 5% 0.5W
3748	4822 116 52283	4K7 5% 0.5W
3749	4822 116 52283	4K7 5% 0.5W
3750	4822 116 52176	10R 5% 0.5W
5701	4822 157 10371	Coil 100KHZ

RECORDER BOARD

13-1

		
6704	4822 130 30621	Diode 1N4148
7702	4822 130 40981	Trans BC337-25
7705	4822 209 32918	IC AN7318S
7706	4822 130 44503	Trans BC547C
7707	4822 130 44503	Trans BC547C
- MISCELLANEOUS -		
1707	4822 277 11504	Push Switch

Note : Only those parts mentioned in the list are normal service parts.

MAIN BOARD

13-2

VR401	4822 101 11884	Rotary Volume
X201	4822 242 73769	Filter CST4.19MGW
D201	4822 130 30621	Diode 1N4148
D202	4822 130 31554	Diode BZX79-BAV3
D203	4822 130 30621	Diode 1N4148
D204	4822 130 30621	Diode 1N4148
D205	4822 130 34174	Diode BZX79-BAV7
D601	4822 130 30621	Diode 1N4148
D602	4822 130 30621	Diode 1N4148
D603	4822 130 30621	Diode 1N4148
D604	4822 130 30621	Diode 1N4148
D605	5322 130 31504	Diode BZX79-B3V3
D606	5322 130 34574	Diode 1N4004G
D607	5322 130 34574	Diode 1N4004G
D608	5322 130 34574	Diode 1N4004G
D609	5322 130 34574	Diode 1N4004G
D610	5322 130 34574	Diode 1N4004G
IC601	4822 209 16465	IC BA5417
Q201	4822 130 44503	Trans BC547C
Q601	4822 130 63773	Trans KTC3198-GR
Q602	4822 130 63773	Trans KTC3198-GR
Q603	4822 130 41327	Trans BC327-40
Q604	4822 130 44196	Trans BC548C
Q605	4822 130 41327	Trans BC327-40
Q606	5322 130 60068	Trans BC558C
U201	4822 209 16127	IC TMP47C422F

- MISCELLANEOUS -

LD201	4822 135 00213	LCD Display LD-1712
SW201	4822 276 13443	Tact Switch
SW202	4822 276 13443	Tact Switch
SW203	4822 276 13443	Tact Switch
SW204	4822 276 13443	Tact Switch

- MISCELLANEOUS -

SW205	4822 276 13443	Tact Switch
SW401	4822 276 13972	Push Switch
SW601	4822 277 21782	Slide Switch
T601	4822 146 10988	Transf 230V (For -/00)
T601	4822 146 10997	Transf 120V/230V (For -/01)
T601	4822 146 10989	Transf 120V (For -/17)
F601	4822 277 11756	CD Door Switch
	4822 265 10674	Stereo Earphone Jack
	4822 240 10291	Speaker 3" 4 Ohm 4W
	4822 277 30971	Volt Selector (For -/01)
	4822 070 32001	Fuse 0.2A (For -/00/01)
	4822 267 31891	AC Socket (For -/00/01)
	4822 265 11294	AC Socket (For -/17)
	4822 321 10249	AC Cord (For -/00/01)
	4822 321 10882	AC Cord (For -/17)

Note : Only those parts mentioned in the list are normal service parts.

ATM 3 TUNER BOARD

13-2

2101	4822 122 32764	4.7nF 20% 50V
2102	4822 126 12812	47pF 5% SL 50V
2103	4822 124 40248	10uF 20% 63V
2104	4822 124 40248	10uF 20% 63V
2105	4822 126 12828	24pF 5% SL 50V
2105	4822 126 12814	24pF 5% N220 50V
2106	4822 125 50681	Cap Tuning 2XAM/2XFM
2108	4822 122 32147	22pF 2% N470 100V
2109	4822 126 12809	2.2pF 5% N470 50V
2110	4822 126 12284	5.6pF 0.5% N1500 50V
2110	4822 126 13592	10pF ±0.5pF N750
2110	4822 126 12229	8.2pF N750 50V
2112	4822 124 41397	47uF 20% 25V
2113	4822 126 13581	0.22uF 20% 50V
2113	4822 124 40746	0.22uF 20% 63V
2114	4822 126 12671	330pF 10% YB 50V
2115	4822 124 40246	4.7uF 20% 63V
2116	4822 124 80141	10nF 10% 50V
2116	4822 121 43144	22nF 10% 50V
2117	4822 124 40242	1uF 20% 63V
2118	4822 124 40242	1uF 20% 63V
2119	4822 124 80141	10nF 10% 50V
2119	4822 121 43144	22nF 10% 50V
2120	4822 124 40242	1uF 20% 63V
2121	4822 124 40239	0.47uF 20% 63V
2122	4822 124 40239	0.47uF 20% 63V
2126	4822 125 50045	1p8-22p 250V
2134	4822 126 10777	100pF 50V
2135	4822 126 10777	100pF 50V
2150	4822 125 50045	1p8-22p 250V
3101	4822 100 20167	50K 30% LIN 0.1W
3102	4822 116 52297	68K 5% 0.5W
3103	4822 050 21002	1K 1% 0.6W
3104	4822 116 52256	2K2 5% 0.5W
3105	4822 116 83864	10K 5% 0.5W
3108	4822 116 52191	33R 5% 0.5W
3109	4822 116 52234	100K 5% 0.5W
3110	4822 116 52234	100K 5% 0.5W
3113	4822 116 52252	180K 5% 0.5W

- MISCELLANEOUS -

5101	4822 157 70513	Coil - FM Ant
5102	4822 158 60627	Coil - MW/LW Ant
5102	4822 157 70731	Coil - MW Ant
5104	4822 156 30947	Coil - FM Osc
5105	4822 157 71145	Coil - MW Osc
5106	4822 157 70499	IFT - MW
5107	4822 242 81154	Filter KMFC5058-Z
5108	4822 156 11146	IFT - MW
5109	4822 157 71144	Coil - LW Osc
6101	4822 130 30621	Diode 1N4148
6102	4822 130 30621	Diode 1N4148
7101	4822 209 32746	IC TEA5711T/N2

Note : Only those parts mentioned in the list are normal service parts.

α is only for -/00
β is only for -/01/11
φ is only for -/17

2802	4822 126 12785	47nF +80-20% 50V
2803	4822 126 11585	47nF +80-20% 50V
2804	4822 126 12878	1,5nF 10% 16V
2805	4822 121 51412	560nF 10% 50V
2806	4822 122 33519	470pF 10% 50V
2807	4822 122 33191	18pF 5% 50V
2808	4822 124 22263	220µF 20% 25V
2809	4822 124 40242	1µF 20% 50V
2810	4822 124 40242	1µF 20% 50V
2811	4822 122 33849	150pF 10% 50V
2812	4822 122 33849	150pF 10% 50V
2813	4822 126 12339	2,2nF 10% 16V
2814	4822 126 13677	39pF 5% 50V
2815	4822 126 12882	100nF 8.2% 50V
2816	4822 124 41407	0,47µF 20% 50V
2817	4822 121 42687	3,3nF 10% 50V
2818	4822 124 40242	1µF 20% 50V
2819	5322 121 42386	100nF 10% 50V
2820	4822 124 40746	0,22µF 20% 50V
2821	4822 124 41579	10µF 20% 50V
2822	4822 122 10167	22nF 30% 50V
2823	4822 124 40246	4,7µF 20% 50V
2824	4822 124 41407	0,47µF 20% 50V
2825	4822 122 10462	15pF 5% NPO
2826	4822 124 41407	0,47µF 20% 50V
2827	4822 124 40433	47µF 20% 25V
2828	4822 124 41579	10µF 20% 50V
2829	5322 121 42489	33nF 10% 50V
2830	4822 122 10319	82pF 10% 50V
2831	4822 121 41856	22nF 10% 50V
2832	4822 124 41576	2,2µF 20% 50V
2833	4822 124 40433	47µF 20% 25V
2834	4822 126 12882	100nF +80-20% 50V
2835	4822 126 12882	100nF +80-20% 50V
2836	4822 124 80791	470µF 20% 16V
2837	4822 126 11585	22nF +80-20% 25V
2838	4822 126 12882	100nF +80-20% 50V
2839	4822 126 12882	100nF +80-20% 50V
2841	4822 122 33195	100pF 10% 50V
2842	4822 124 40849	330µF 20% 16V

2843	4822 126 13098	5,6nF 20% 16V
2844	4822 122 10466	220pF 10% 50V
2846	4822 122 33519	470pF 10% 50V
2848	4822 122 33519	470pF 10% 50V
2849	4822 122 10466	220pF 10% 50V
2860	4822 124 40433	47µF 20% 25V
3801	4822 052 10478	4R7 5% 0,33W
3802	4822 116 52252	180K 5% 0,16W
3803	4822 111 50499	3M3 5%
3805	4822 116 83884	47K 5% 0,16W
3806	4822 116 52256	2K2 5% 0,16W
3807	4822 116 52271	33K 5% 0,16W
3808	4822 116 52263	2K7 5% 0,16W
3809	4822 116 83884	47K 5% 0,16W
3810	4822 116 52257	22K 5% 0,16W
3811	4822 116 52257	22K 5% 0,16W
3812	4822 116 52257	22K 5% 0,16W
3815	4822 050 11002	1K 5% 0,16W
3816	4822 050 11002	1K 5% 0,16W
3817	4822 116 83883	470R 5% 0,16W
3818	4822 116 83883	470R 5% 0,16W
3819	4822 117 11825	1M5 5%
3820	4822 116 52252	180K 5% 0,16W
3821	4822 116 52243	1K5 5% 0,16W
3822	4822 116 52264	27K 5% 0,16W
3823	4822 116 52234	100K 5% 0,16W
3824	4822 116 83868	150R 5% 0,16W
3826	4822 116 83961	6K8 5% 0,16W
3827	4822 116 52243	1K5 5% 0,16W
3828	4822 116 83864	10K 5% 0,16W
3829	4822 116 52271	33K 5% 0,16W
3830	4822 116 52244	15K 5% 0,16W
3831	4822 116 52251	18K 5% 0,16W
3832	4822 116 52222	390R 5% 0,16W
3833	4822 116 52264	27K 5% 0,16W
3835	4822 116 52184	18R 5% 0,16W

3836	4822 050 11002	1K 5% 0,16W
3837	4822 111 30893	4M7 5%
3838	4822 11652234	100K 5% 0,16W
3839	4822 116 52235	1M 5% 0,16W
3840	4822 050 11002	1K 5% 0,16W
3841	4822 116 52298	680K 5% 0,16W
3842	4822 116 52297	68K 5% 0,16W
3844	4822 116 52291	56K 5% 0,16W
3845	4822 116 52298	680K 5% 0,16W
3846	4822 050 11002	1K 5% 0,16W
3847	4822 116 52298	680K 5% 0,16W
3848	4822 116 52251	18K 5% 0,16W
3849	4822 052 10478	4R7 5%
3850	4822 116 52251	18K 5% 0,16W
3851	4822 116 52244	15K 5% 0,16W
3852	4822 116 83883	470R 5% 0,16W
3853	4822 116 52251	18K 5% 0,16W
3854	4822 116 52243	1K5 5% 0,16W
3855	4822 116 83882	29K 5% 0,16W
3856	4822 116 52303	8K2 5% 0,16W
3857	4822 116 52269	3K3 5% 0,16W
3858	4822 116 80176	1R 5% 0,16W
3859	4822 116 83864	10K 5% 0,16W
3860	4822 116 52207	1K2 5% 0,16W
3870	4822 052 10478	4R7 5%
3871	4822 116 52283	4K7 5% 0,5W
3880	4822 050 11002	1K 5% 0,16W
3881	4822 050 11002	1K 5% 0,16W
3882	4822 050 11002	1K 5% 0,16W
3883	4822 050 11002	1K 5% 0,16W
3884	4822 116 83882	39K 5% 0,16W
3886	4822 116 52235	1M 5% 0,16W
3890	4822 050 11002	1K 5% 0,16W
3891	4822 050 11002	1K 5% 0,16W
3892	4822 050 11002	1K 5% 0,16W
3893	4822 050 11002	1K 5% 0,16W
3894	4822 050 11002	1K 5% 0,16W
3895	4822 050 11002	1K 5% 0,16W
3896	4822 116 52256	2K2 5% 0,16W
3897	4822 116 52256	2K2 5% 0,16W

3898	4822 116 52256	2K2 5% 0,16W
3899	4822 050 11002	1K 5% 0,16W
5000	4822 526 10494	Ind Fxd 100MHz
5010	4822 526 10494	Ind Fxd 100MHz
5020	4822 526 10494	Ind Fxd 100MHz
5030	4822 526 10494	Ind Fxd 100MHz
5040	4822 526 10494	Ind Fxd 100MHz
5050	4822 526 10494	Ind Fxd 100MHz
5060	4822 157 50964	Coil 100µH 15%
5803	4822 242 73557	Filter 8MHz467
6001	4822 130 30621	Diode 1N4148
7801	4822 209 13703	IC M65821FP
7802	4822 209 32421	IC TDA1311A
7803	4822 209 90496	IC M62475FP
7804	5322 130 60068	Trans BC558C
7805	4822 209 32852	IC TDA7073A
7806	4822 209 32852	IC TDA7073A
- MISCELLANEOUS -		
1802	4822 265 10925	Connector
8000	4822 265 10926	Connector

Note : Only those parts mentioned in the list are normal service parts.