

Service  
Service  
Service



Manual #1861  
AZ12001701 / AZ12051701

# Service Manual

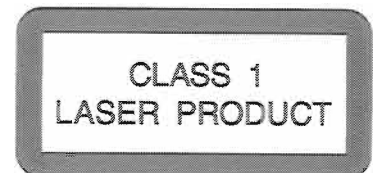

**TABLE OF CONTENTS**

Page	Page		
Handling chip components and safety .....	1	FRONT BOARD	
Connections & Controls .....	2 - 4	circuit diagram .....	17
Specification .....	5	layout diagram .....	18
Disassembly Diagram .....	6	TAPE DECK BOARD	
Block Diagram .....	6	circuit diagram .....	19
Wiring Diagram .....	8	layout diagram .....	20
AUDIO BOARD		Cassette Adjustment .....	20
circuit diagram (AZ1200) .....	9	CD MODULE	
layout diagram (AZ1200) .....	10	circuit diagram .....	21
circuit diagram (AZ1205) .....	11	layout diagram .....	22
layout diagram (AZ1205) .....	12	CD Startup and Service Test Program .....	23 - 24
TUNER BOARD (FM/MW)		EXPLODED VIEW DIAGRAM	
circuit diagram .....	13	cabinet .....	26
layout diagram .....	14	tape deck .....	25
TUNER BOARD (FM/LW/MW)		Mechanical partslist .....	25
circuit diagram .....	15	Electrical partslist .....	27 - 31
layout diagram .....	16		

Safety regulations require that the set be restored to its original condition and that parts which are identical with those specified be used.

© Copyright 1995 Philips Consumer Electronics B.V. Eindhoven, The Netherlands  
All rights reserved. No part of this publication may be reproduced, stored in a retrieval system or transmitted, in any form or by any means, electronic, mechanical, photocopying, or otherwise without the prior permission of Philips.



# HANDLING CHIP COMPONENTS

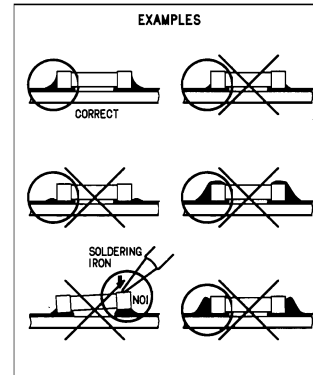
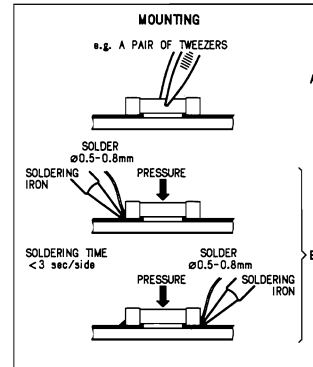
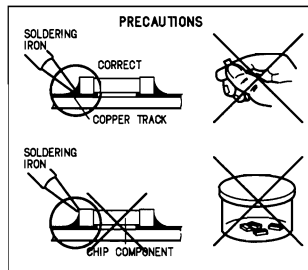
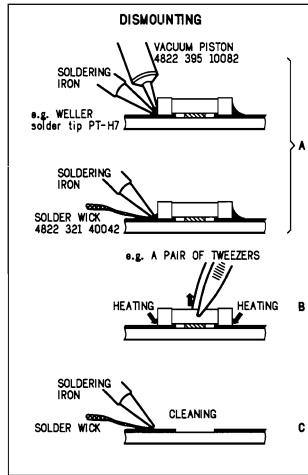
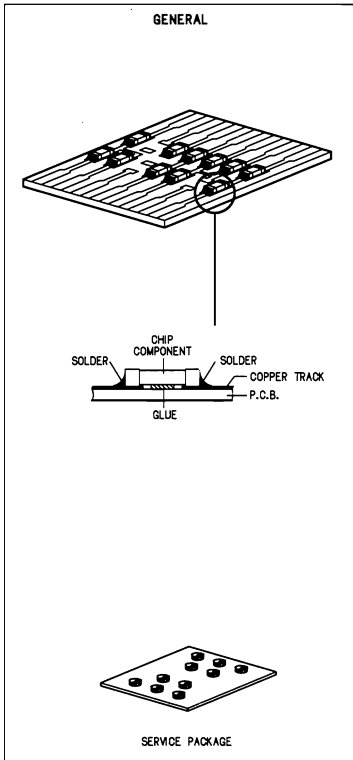

## GB WARNING

All ICs and many other semiconductors are susceptible to electrostatic discharges (ESD). Careless handling during repair can reduce life drastically. When repairing, make sure that you are connected with the same potential as the mass of the set via a wrist wrap with resistance. Keep components and tools at this potential.

## F ATTENTION

Tous les IC et beaucoup d'autres semi-conducteurs sont sensibles aux décharges statiques (ESD). Leur longévité pourrait être considérablement écourtée par le fait qu'aucune précaution n'est prise à leur manipulation. Lors de réparations, s'assurer de bien être relié au même potentiel que la masse de l'appareil et enfilez le bracelet senti d'une résistance de sécurité. Veillez à ce que les composants ainsi que les outils que l'on utilise soient également à ce potentiel.

## ESD



## D WARNUNG

Alle ICs und viele andere Halbleiter sind empfindlich gegenüber elektrostatischen Entladungen (ESD). Unvorsichtige Behandlung im Reparaturfall kann die Lebensdauer drastisch reduzieren. Sorgen Sie dafür, daß sie im Reparaturfall über ein Pulsarmband mit Widerstand mit dem Massepotential des Gerätes verbunden sind. Halten Sie Bauteile und Hilfsmittel ebenfalls auf diesem Potential.

## NL WAARSCHUWING

Alle IC's en vele andere halfgeleiders zijn gevoelig voor electrostatische ontladingen (ESD). Onzorgvuldig behandelen tijdens reparatie kan de levensduur drastisch doen verminderen. Zorg ervoor dat u tijdens reparatie via een polsband met weerstand verbonden bent met hetzelfde potentiaal als de massa van het apparaat. Houd componenten en hulpmiddelen ook op ditzelfde potentiaal.

## I AVVERTIMENTO

Tutti IC e parecchi semi-conduttori sono sensibili alle scariche statiche (ESD). La loro longevità potrebbe essere fortemente ridotta in caso di non osservazione della più grande cauzione alla loro manipolazione. Durante le riparazioni occorre quindi essere collegato allo stesso potenziale che quello della massa dell'apparecchio tramite un braccialetto a resistenza. Assicursarsi che i componenti e anche gli utensili con quali si lavora siano anche a questo potenziale.

## GB WARNING

Safety regulations require that the set be restored to its original condition and that parts which are identical with those specified be used.

## F ATTENTION

Les normes de sécurité exigent que l'appareil soit remis à l'état d'origine et que soient utilisées les pièces de rechange identiques à celles spécifiées.

## D WARNUNG

Bei jeder Reparatur sind die geltenden Sicherheitsvorschriften zu beachten. Der Originalzustand des Gerätes darf nicht verändert werden. Für Reparaturen sind Original-ersatzteile zu verwenden.

## NL WAARSCHUWING

Veiligheidsbepalingen vereisen, dat het apparaat in zijn oorspronkelijke toestand wordt teruggebracht en dat onderdelen, identiek aan de gespecificeerde, worden toegepast.

## I AVVERTIMENTO

Le norme di sicurezza estigono che l'apparecchio venga rimesso nelle condizioni originali e che siano utilizzati i pezzi di ricambio identici a quelli specificati.

Anti-static table mat large 1200x650x1.25mm  
small 600x650x1.25mm

Anti-static wrist band  
Connection box (1MΩ)  
Extendible cable (to connect wrist band to conn. box)  
Connecting cable (to connect table mat to conn. box)  
Earth cable (to connect any product to mat or box)  
Complete kit ESD3 (combining all above products)  
Wristband tester

4822 466 10953  
4822 466 10958  
4822 395 10223  
4822 320 11307  
4822 320 11305  
4822 320 11306  
4822 320 11308  
4822 310 10671  
4822 344 13999

GB Safety regulations require that the set be restored to its original condition and that parts which are identical with those specified be used. Safety components are marked by those symbol. ▲

S Varning! Osynlig laserstrålning när apparaten är öppnad och spärrar är ukkopplad. Betrakta ej strålen.

DK Advarsel! Usynlig laserstrålning ved åbning når sikkerhedsafbrydere er ude af funktion. Undgå udsættelse for stråling.

SF Varoitus! Avatussa laitteessa ja suojalukituksen ohitettaessa olet alttiina näkyvättömälle laserisäteilylle. Älä katso säteeseen!

GB After servicing and before returning the set to customer perform a leakage current measurement test from all exposed metal parts to earth ground, to assure no shock hazard exists. The leakage current must not exceed 0.5mA.

F "Pour votre sécurité, ces documents doivent être utilisés par des spécialistes agréés, seuls habilités à réparer votre appareil en panne".

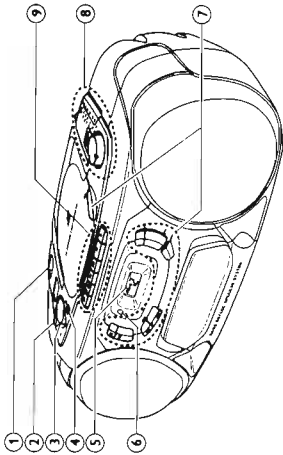

AZ 1205 only

## BASIC FUNCTIONS

- ① POWER: CD, TUNER, TAPE...selects the sound source
- ② DBB.....enhances the bass
- ③ VOLUME.....adjusts the volume level
- ④ .....3.5mm headphone socket  
Note: *Connecting the headphones will switch off the speakers.*
- ⑤ Display
- ⑥ REMOTE SENSOR sensor for the infrared remote control (AZ 1205 only)

## ⑦ CD PLAYER

- OPEN.....opens the CD compartment
- STOP .....stops CD play and erases the program
- PLAY-PAUSE .....starts and interrupts CD play
- SEARCH .....skips and searches forward and backward
- PROGRAM.....programs track numbers and reviews the program
- SHUFFLE.....plays CD tracks in random order
- REPEAT.....repeats a track, the entire CD, or the program

## ⑧ RADIO

- TUNING.....tunes to radio stations
- BAND.....selects the wave band

## ⑨ CASSETTE RECORDER

- PAUSE .....interrupts recording or playback
- STOP-OPEN .....stops the tape and opens the cassette compartment
- SEARCH .....rewinds the tape
- SEARCH .....fast forwards the tape
- PLAY .....starts playback
- RECORD .....starts recording

## REMOTE CONTROL (AZ 1205 only)

- VOLUME .....decreases or increases the volume level
- SHUFFLE.....plays CD tracks in random order
- REPEAT.....repeats a track, the entire CD, or the program
- .....starts and interrupts CD play
- .....selects the beginning of a current, previous or subsequent track of a CD
- .....stops CD play and erases the program
- SEARCH .....searches backward/forward in a CD track

Note: *The TUNER CONTROL keys on the remote control have no function with this set.*

## Batteries

### For the set (optional)

Open the battery compartment of the set and insert 6 batteries, type R20, UM-1 or D-cells (preferably alkaline).

### For the remote control (AZ 1205 only)

Open the battery compartment of the remote control and insert 2 batteries, type R03, UM-4 or AAA-cells (preferably alkaline).

Remove batteries if they are dead or if the set is not going to be used for a long time.

**Batteries contain chemical substances, so they should be disposed of properly.**

## AC power supply

- 1 Check whether the voltage as shown on the type plate corresponds to your local voltage. If it does not, consult your dealer or service organization. **The type plate is located on the bottom of the set.**
- 2 If the set is equipped with a VOLTAGE selector (⊗), set this selector to the local voltage.
- 3 Connect the AC power cord to the AC MAINS socket and to the wall socket. This switches on the AC power supply. **The AC power cord is inside the battery compartment.**

The battery supply will be switched off when the set is connected to the AC power. To change to battery supply, disconnect the AC power cord from the unit's AC MAINS socket.

To disconnect the set from AC power completely, remove the AC power cord from the wall socket.

## Environmental information

All redundant packing material has been omitted. We have tried to make the packaging easy to separate into three materials: cardboard (box), polystyrene foam (buffer) and polyethylene (bags, protective foam sheet).

Your set consists of materials which can be recycled if disassembled by a specialized company. Please observe the local regulations regarding the disposal of packing materials, dead batteries and old equipment.

### Switching the set on and off

Set the POWER control to the desired sound source: CD, TUNER, or TAPE.

The set is switched off when the POWER control is set to OFF/TAPE and the keys of the tape deck are released.

*Note: If you use batteries, always be sure to switch the set off after use. This will avoid unnecessary power consumption.*

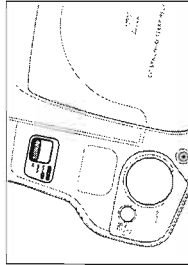

### Adjusting volume and sound

Adjust the volume using the VOLUME control.

→ Display indication: Volume level from 0 to 32 (AZ 1205 only).

Increase and decrease the bass level by pressing DBB.

The bass level can also be emphasized if you place the set against a wall or shelf. Do not cover any vents; leave sufficient room around the unit for ventilation.

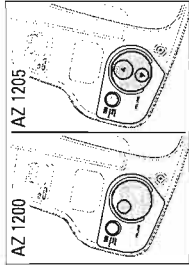

### Radio — tuning to radio stations

- 1 Set the POWER control to TUNER.
- 2 Select the wave band using the BAND selector.
- 3 Tune to the desired radio station by using the TUNING knob.

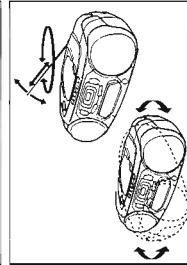
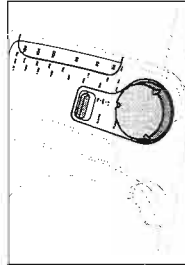

#### Improving RADIO reception

For **FM** stations, pull out the telescopic antenna. To improve the signal, incline and turn the antenna. Reduce its length if the signal is too strong (very close to a transmitter).

For **AM** stations, direct the built-in antenna by turning the whole set. The telescopic antenna is not needed.

## CONNECTIONS AND CONTROLS

### Playing a CD

- 1 Set the POWER control to CD.
  - 2 Press **OPEN** to open the CD compartment.
  - 3 Insert an audio CD (printed side up) and close the CD compartment.
    - The CD player starts and scans the contents list of the CD. Then, the CD player stops. Display indication: the total number of tracks.
  - 4 Press the **PLAY-PAUSE** button to start CD play.
    - Display indication: the current track number.
  - 5 Press the **STOP** button to stop CD play.
    - Display indication: the total number of tracks.
- You can interrupt CD play by pressing **PLAY-PAUSE**. Continue CD play by pressing the button again.
- Display indication: the current track number flashes.

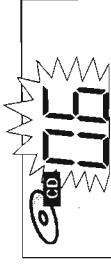
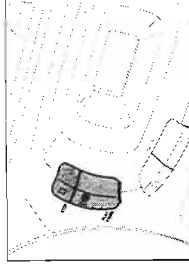

*Note: CD play will also stop if:*

- you open the CD compartment,
- the end of the CD is reached, or
- you move the POWER control to TUNER or TAPE.

If you make a mistake when operating the CD player, or if the CD player cannot read the CD, the display shows **E** or **no**. (See "TROUBLESHOOTING".)



If you press **PLAY-PAUSE** and there is no CD inserted, the display shows **no**.



**Different playing modes: SHUFFLE / REPEAT**

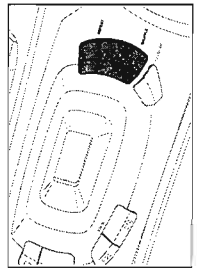

**SHUFFLE – Playing in random order**  
 1 Press SHUFFLE before or during CD play.  
 → All the tracks of the CD (or program if available) will now be played in random order.  
 2 Press SHUFFLE again to return to normal CD play.

**REPEAT – Repeating the entire CD or one track of the CD**  
 1 Before or during CD play, press REPEAT repeatedly to cause the display to show the different repeating modes.  
 → REPEAT: the current track is played repeatedly.  
 → REPEAT ALL: the entire CD or program is played repeatedly.

2 Press REPEAT until the display indication disappears to return to normal CD play.

*Note: You can activate the different playing modes at the same time, e. g. you can repeatedly play the entire CD or program in random order (SHUFFLE REPEAT ALL).*



**Search backward and forward**

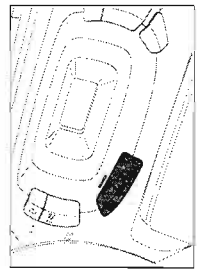

**Selecting another track**  
 Briefly press the SEARCH  $\ll$  or  $\gg$  button once/several times to skip to the beginning of the current, previous or subsequent track(s).  
*During play:*  
 CD play continues automatically with the selected track.  
*When playback is stopped:*  
 Press PLAY:PAUSE  $\triangleright$  to start CD play.  
 → Display indication: the selected track number.

**Searching for a passage during CD play**  
 1 Hold down the SEARCH  $\ll$  or  $\gg$  button to find a particular passage in a forward or backward direction.  
 → CD play continues at a low volume.

2 Release the button when you have reached the desired passage.  
*Note: In the SHUFFLE and REPEAT modes or when playing a program, searching is only possible within the particular track.*

**Playing a cassette**

**Programming track numbers**

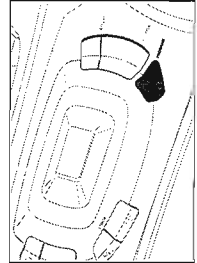

You can select a number of tracks and store these in the memory in the desired sequence. You can store any track more than once. A maximum of 20 tracks can be stored in the memory.

- 1 Select the desired track with SEARCH  $\ll$  or  $\gg$ .
- 2 As soon as the number of the desired track is displayed, press the PROGRAM button to store the track in the memory.  
 → PROGRAM appears in the display and P lights up briefly. Then, the number of the stored track is shown.
- 3 Select and store all desired tracks in this way.



You can review your settings by pressing the PROGRAM button for more than 2 seconds.  
 → The display shows all stored track numbers in sequence.

If you try to store more than 20 tracks, the display shows F.



**Playing the program**



If you have selected the tracks while playback is stopped, press PLAY:PAUSE  $\triangleright$ .

If you have selected the tracks during CD play, first press STOP  $\square$ , then press PLAY:PAUSE  $\triangleright$ .

**Erasing the program when playback is stopped**



From the stop position, press STOP  $\square$ .  
 →  $\square$  lights up briefly, PROGRAM disappears, and your program is erased.

*Note: The program will also be erased if you:*  
 – interrupt the power supply,  
 – open the CD compartment, or  
 – move the POWER control to TUNER or TAPE.

**Recording from the CD player – CD search start**

## Playing a cassette

- 1 Set the POWER control to TAPE.
- 2 Press STOP-OPEN □△ to open the cassette compartment.
- 3 Insert a recorded cassette with the open side upwards and close the cassette compartment.
- 4 Press PLAY <| to start playback.
- 5 Press ▷ or ◀ to rewind or fast forward the tape.
- 6 To stop the tape press STOP-OPEN □△.

*Note: The keys are released at the end of the tape.*

## General information on recording

Recording is permissible insofar as copyright or other rights of third parties are not infringed upon.

For recording on this set you should use a cassette of the type NORMAL (IEC type I). This deck is not suitable for recording on cassettes of the type CHROME (IEC type II) or METAL (IEC type IV).

The recording level is set automatically. The controls VOLUME and DBB do not affect the recording.

At the very beginning and end of the tape, no recording will take place in the 7 seconds during which the leader tape passes the recorder heads.

## Protecting tapes from accidental erasure

Keep the cassette side to be protected in front of you and snap off the left tab. Now, recording on this side is no longer possible.

To record again on this side of the cassette, cover the opening with a piece of adhesive tape.

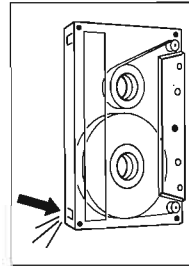

## Recording from the CD player – CD synchro start

- 1 Set the POWER control to CD.
- 2 Insert a CD and, if desired, program the track numbers.
- 3 Press STOP-OPEN □△ to open the cassette compartment.
- 4 Insert a blank, unprotected, cassette and close the cassette compartment.
- 5 Press RECORD ○ to start recording.  
→ Playing of the CD or program starts automatically. It is not necessary to start the CD player separately.
- 6 For brief interruptions press PAUSE ■. Press the PAUSE ■ key again to resume recording.
- 7 To stop recording, press STOP-OPEN □△.

*Note: the recording can be started from different positions:*

- if the CD player is in pause mode, recording will start from this very position (use SEARCH ◀ or ▶);
- if the CD player is in stop mode, recording will start from the beginning of the CD or program.

## Recording from the radio

- 1 Set the POWER control to TUNER.
- 2 Tune to the desired radio station (see "RADIO").
- 3 Press STOP-OPEN □△ to open the cassette compartment.
- 4 Insert a blank, unprotected, cassette and close the cassette compartment.
- 5 Press RECORD ○ to start recording.
- 6 For brief interruptions press PAUSE ■. To resume recording press the PAUSE ■ key again.
- 7 To stop recording, press STOP-OPEN □△.

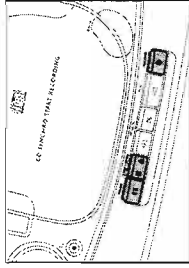

# CONNECTIONS AND CONTROLS

## WARNING

If a fault occurs, first check the points listed below before taking the set for repair.

**Under no circumstances should you try to repair the set yourself as this will invalidate the warranty.**

## General maintenance

Do not expose the set, batteries, CDs, or tapes to humidity, rain, sand, or excessive heat (caused by heating equipment or direct sunlight).

The mechanical parts of the set contain self-lubricating bearings and must not be oiled or lubricated!

You can clean the set with a soft, slightly dampened, lint-free cloth. Do not use any cleaning agents as they may have a corrosive effect.

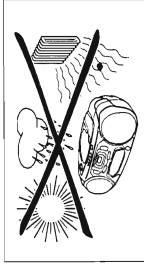

## Tape deck maintenance

To ensure proper recording and playback quality, clean parts (A), (B) and (C) after approximately 50 hours of operation. Use a cotton swab slightly moistened with alcohol or head-cleaner fluid.

Press PLAY < and clean the rubber pressure rollers (A).

Press PAUSE  $\square$  and clean the capstans (B) and the heads (C).

*Note: Cleaning of the heads (C) can also be done by playing a cleaning tape once.*

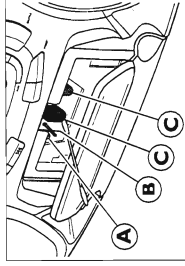

## CD player and CD handling

The lens (X) of the CD player should never be touched. Always keep the CD compartment closed to avoid dust on the lens.

The lens may cloud over when the set is suddenly moved from cold to warm surroundings. Playing a CD is not possible then. Leave the CD player in a warm environment until the moisture evaporates.

To take the CD out of its box easily, press the center spindle while lifting the CD. Always pick up the CD by the edge and put it back in its box after use.

To clean the CD, wipe it in a straight line from the center toward the edge using a soft, lint-free cloth. A cleaning agent may damage the disc!

Never write on a CD or attach a sticker to it.

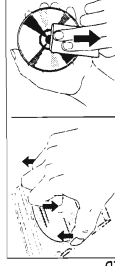
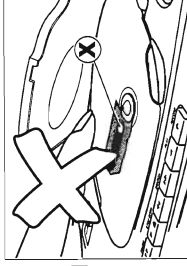

## CAUTION

**Use of controls or adjustments or performance of procedures other than here-in may result in hazardous radiation exposure.**

### Problem

**No sound, no power**

### Possible cause

VOLUME is not adjusted.  
Headphones are connected.  
Power cord is not securely connected.  
Batteries are dead.  
Batteries are inserted incorrectly.  
Trying to change over from AC power to battery supply without removing the power cord.

### Solution

Adjust volume.  
Disconnect headphones.  
Connect the power cord properly.  
Insert fresh batteries.  
Insert batteries correctly.

Remove the power cord from the unit's AC MAINS socket.

**No reaction to operation of any keys**

Electrostatic discharge.  
Weak radio signal.

Disconnect the set from power supply, reconnect after a few seconds.  
Adjust the antenna for optimum reception.

**Poor radio reception**

Interference caused by electrical equipment like TVs, computers, engines, etc.  
The CD is badly scratched or dirty.

Keep the radio away from electrical equipment.  
Replace or clean the CD.

**No or  $\mathcal{E}$  indication**

No CD is inserted.  
The CD is inserted upside down.  
The laser lens is steamed up.  
The CD is damaged or dirty.

Insert a CD.  
Insert CD with label facing up.  
Wait until the lens has cleared.  
Replace or clean the CD.

**The CD skips tracks**

SHUFFLE or PROGRAM is active.  
Dust and dirt on the heads, capstans or pressure rollers.

Switch off SHUFFLE or PROGRAM.  
Clean heads, capstans, and pressure rollers.

**Poor cassette sound quality**

Use of unsuitable cassette types (METAL or CHROME) for recording.  
Cassette tab(s) may be snapped off.

Only use NORMAL type cassettes for recording.  
Apply a piece of adhesive tape over the opening.

**Recording does not work**

Batteries are inserted incorrectly.  
Batteries are dead.  
Distance to the set is too large.

Insert batteries correctly.  
Insert fresh batteries.  
Reduce distance.

**Remote control does not function properly (AZ 1205 only)**

Batteries are inserted incorrectly.  
Batteries are dead.  
Distance to the set is too large.

Insert batteries correctly.  
Insert fresh batteries.  
Reduce distance.

# SPECIFICATIONS

## GENERAL

Mains voltage        -/00/14 : 230V  
                          -/17 : 120V  
Mains frequency    -/00/14 : 50 Hz  
                          -/17 : 60 Hz  
Battery             mains : 9 V (R20 x 6)  
                          remote : 1.5V (R03 x 2)  
Power consumption       : 10 W  
Dimension (W x H x D) : 470 x 175 x 250 mm  
Weight                : 4.2 Kg

## AMPLIFIER

Output power        mains : 2 x 1.6 W  
                          battery : 2 x 1.6 W  
Speaker impedance    : 2 x 4 ohm  
Frequency response   : 100 Hz - 10 kHz ( $\pm 4$ dB)

## TUNER - FM SECTION

Tuning range         : 87.5 - 108 MHz  
IF frequency         : 10.7 MHz  $\pm$  0.2 MHz  
Sensitivity           : < 22 dBf at 26dB S/N  
Selectivity          : > 20 dB at 300kHz  
IF rejection         : > 50 dB  
Image rejection      : > 20 dB

## TUNER - AM SECTION

Tuning range         MW : 522 - 1607 kHz  
                          -/17 : 520 - 1730 kHz  
                          LW : 148.5 - 284 kHz  
Sensitivity          MW : < 4000  $\mu$ V/m at 26dB S/N  
                          LW : < 6000  $\mu$ V/m at 26dB S/N  
Selectivity          MW : > 16 dB  
                          LW : > 20 dB  
IF rejection         MW : > 24 dB  
                          LW : > 26 dB  
Image rejection      MW : > 28 dB  
                          LW : > 30 dB

## AUDIO CASSETTE RECORDER

Number of tracks     : 1 stereo  
Tape speed           : 4.76 cm/sec  $\pm$  3%  
Wow & flutter        : < 0.48 JIS UWTD  
Fast wind/rewind C60 : < 110 sec.  
Frequency response   P/B : 125 - 6300 Hz  
S/N ratio             :  $\geq$  38 dB

## COMPACT DISC

Frequency response   : 100 Hz - 10 kHz  
S/N ratio             : < 60 dB  
Channel difference    1 kHz : < 3 dB  
Channel crosstalk    1 kHz : > 26 dB  
Laser wavelength     : 780  $\pm$  20 nm  
Laser light power    : < 0.3 mW



**DISASSEMBLY DIAGRAM**

- A. To remove Front Cabinet Assembly
- B. To remove Cassette Door
- C. To remove Tape Deck
- D. To remove CD Assembly
- E. To remove Audio Board Assembly
- F. To remove Tuner Board
- G. To remove Handle

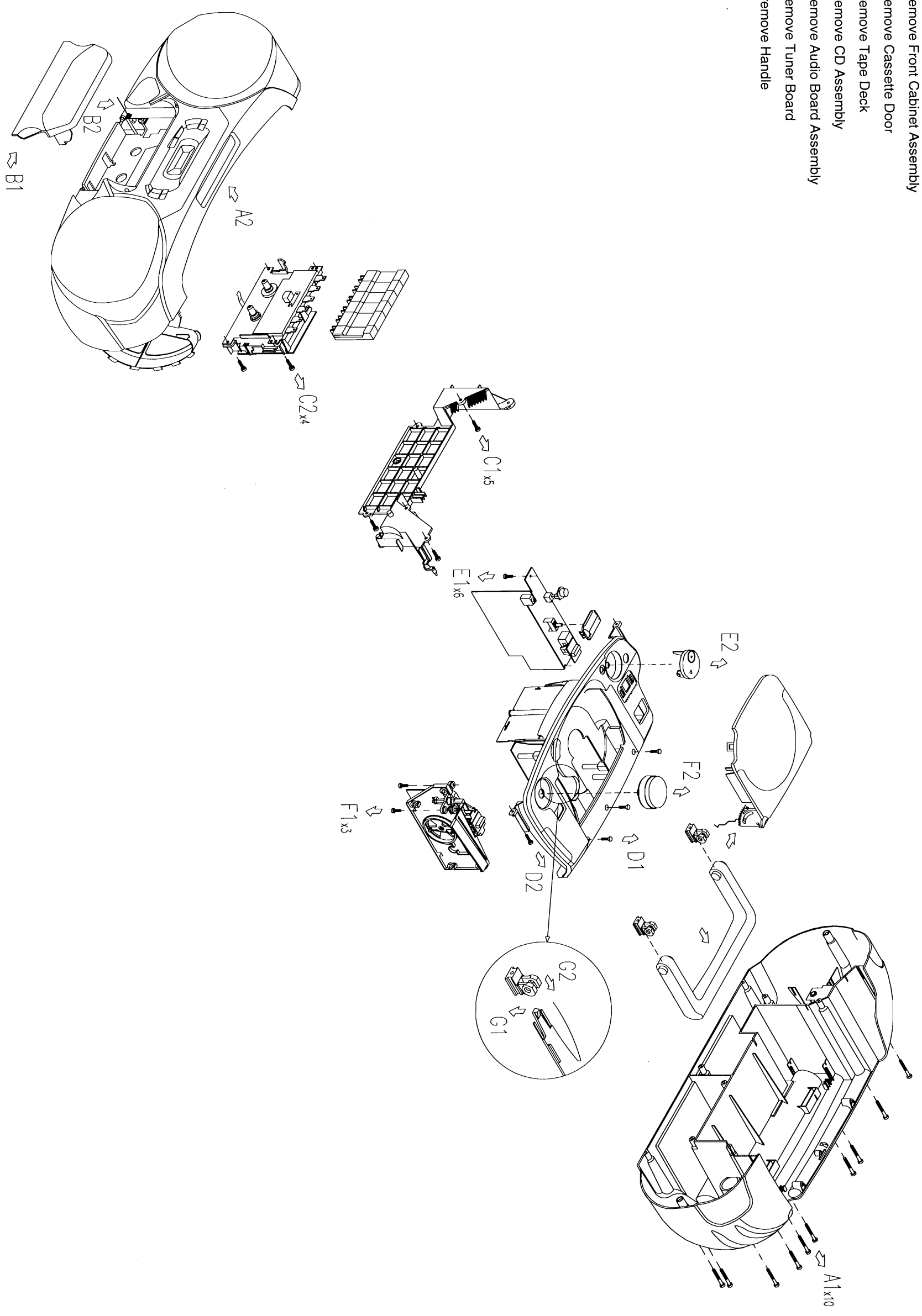

BLOCK DIAGRAM

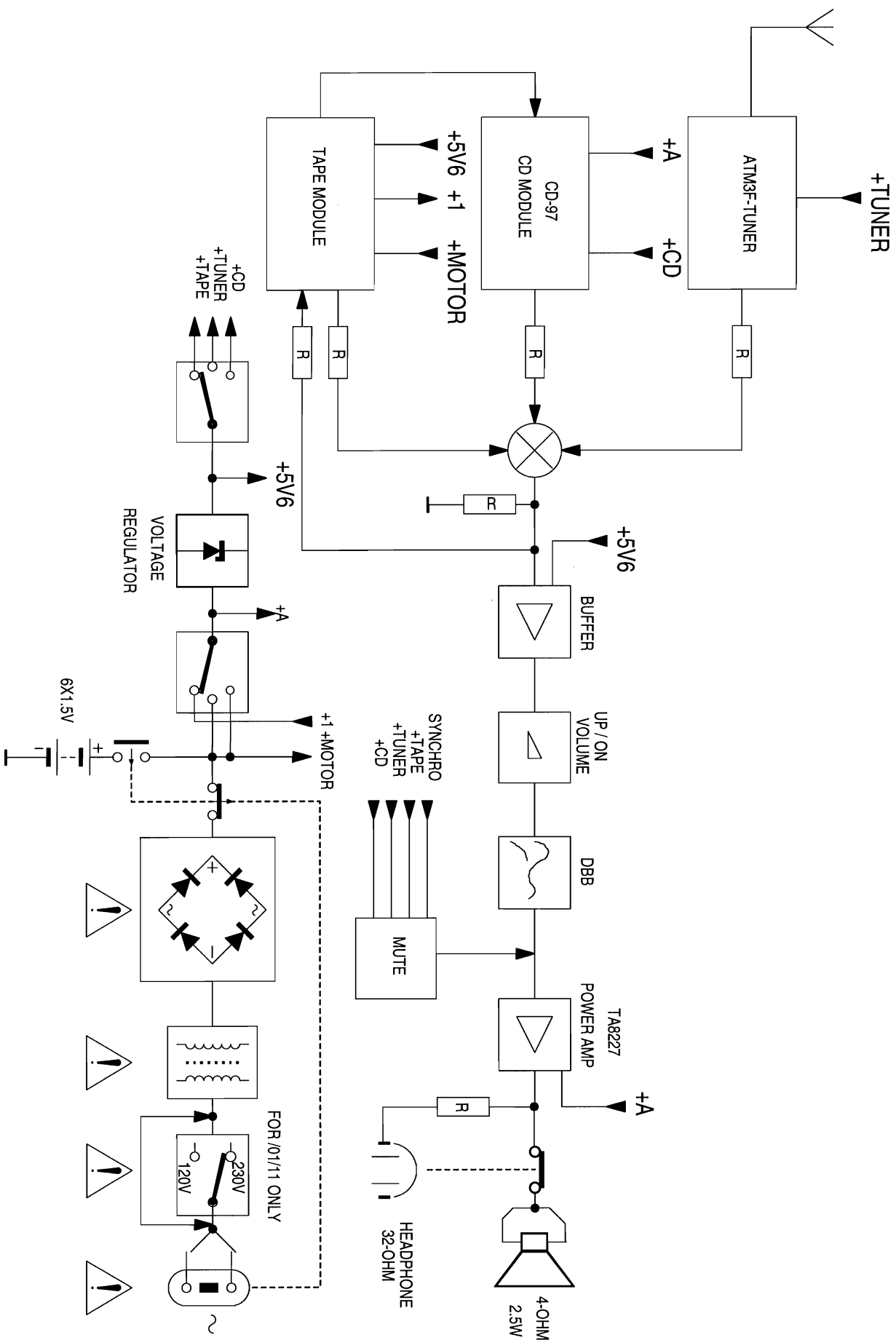





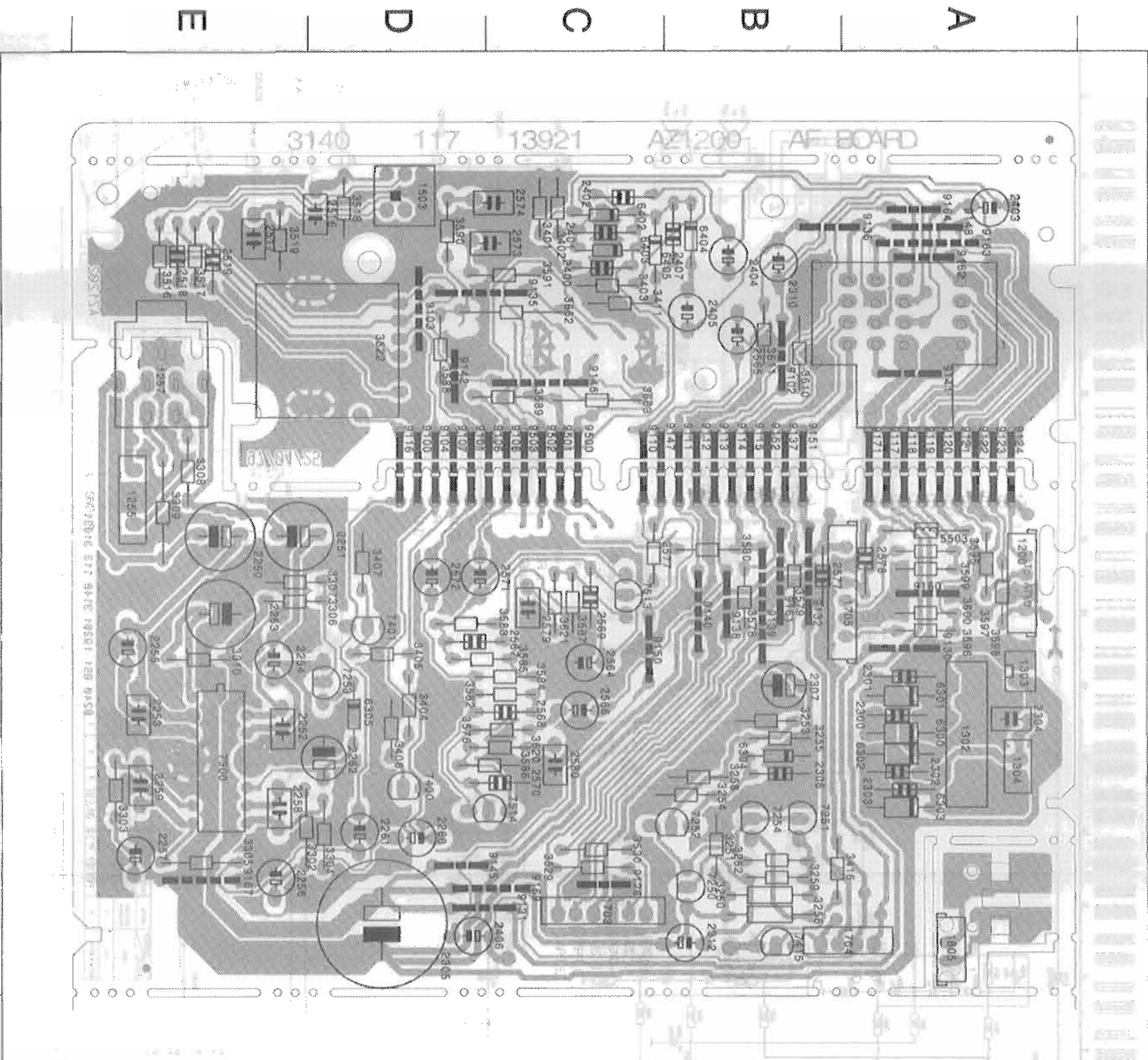

1 A 1	3254 B 4	6405 C 1	12 E 2
1200 A 3	3255 B 4	7250 B 4	13 E 2
1255 E 2	3256 B 4	7251 B 4	14 E 3
1257 E 2	3258 B 4	7252 B 4	15 E 2
1302 A 4	3259 B 4	7253 D 3	16 E 3
1303 A 3	3302 E 4	7254 B 4	17 D 4
1304 A 4	3303 E 4	7300 E 4	18 D 4
1503 D 1	3304 E 4	7400 D 4	19 B 3
1703 C 4	3305 D 4	7401 D 3	10 B 3
1704 A 4	3306 E 3	7415 B 4	111 A 4
1705 A 3	3307 E 2	7513 C 4	112 A 4
1805 A 4	3308 E 3	7514 C 3	113 A 3
2250 E 2	3309 E 2	9100 D 2	114 A 2
2251 E 2	3310 E 3	9101 D 2	115 A 3
2252 E 3	3401 C 1	9102 B 1	116 A 3
2253 E 3	3402 C 1	9103 D 1	117 B 2
2254 E 3	3403 C 1	9104 D 2	118 B 3
2255 E 3	3404 D 3	9105 C 2	119 A 4
2256 E 4	3405 D 3	9106 C 2	120 A 4
2257 E 4	3406 D 3	9107 D 2	121 B 4
2258 E 4	3407 D 3	9110 C 2	122 B 4
2259 E 4	3411 C 1	9111 B 2	123 C 2
2260 D 4	3418 B 4	9112 B 2	124 C 2
2261 D 4	3516 E 1	9113 B 2	125 C 2
2262 D 4	3517 E 1	9114 B 2	127 A 1
2263 E 3	3518 D 1	9115 B 2	128 A 1
2300 A 3	3519 E 1	9116 D 2	
2301 A 3	3522 D 1	9117 A 2	
2302 A 4	3522 C 4	9118 A 2	
2303 A 4	3530 C 4	9119 A 2	
2304 A 3	3576 C 3	9120 A 2	
2305 D 4	3577 C 2	9121 A 2	
2306 B 4	3578 B 3	9122 A 2	
2307 B 3	3579 B 3	9123 A 2	
2310 B 1	3580 B 2	9124 A 2	
2312 B 4	3582 C 3	9126 C 4	
2400 C 1	3583 D 3	9130 A 3	
2401 C 1	3585 C 3	9131 D 4	
2402 C 1	3585 D 3	9132 B 3	
2403 A 1	3588 C 4	9135 D 1	
2404 B 1	3587 C 3	9136 B 1	
2405 B 1	3588 D 1	9137 B 2	
2406 D 4	3588 C 2	9138 B 3	
2407 B 1	3590 D 1	9139 B 3	
2516 D 1	3591 C 1	9140 B 3	
2517 E 1	3595 A 2	9141 A 1	
2518 E 1	3596 A 3	9142 D 1	
2519 E 1	3597 A 3	9145 D 4	
2564 C 3	3598 A 3	9146 C 2	
2565 B 1	3600 A 3	9147 C 2	
2566 C 3	3610 B 1	9150 C 3	
2567 D 3	3611 B 1	9151 B 2	
2568 C 3	3620 C 3	9152 B 2	
2569 C 4	3621 C 3	9160 A 3	
2570 C 4	3662 C 1	9161 B 3	
2571 D 3	3663 C 2	9162 A 1	
2572 D 3	3663 C 2	9163 A 1	
2573 C 1	3300 A 3	9164 A 1	
2574 C 1	3301 A 3	9167 E 4	
2577 B 3	3302 A 4	9169 C 4	
2578 A 3	3303 A 4	9171 A 2	
2579 C 3	3304 B 4	9500 C 2	
2580 C 4	3305 D 3	9501 C 2	
3251 B 4	6402 C 1	9502 C 2	
3252 B 4	6403 C 1	9503 C 2	
3253 B 3	6404 B 1	11 E 2	

AUDIO BOARD (AZ1205) - CIRCUIT DIAGRAM

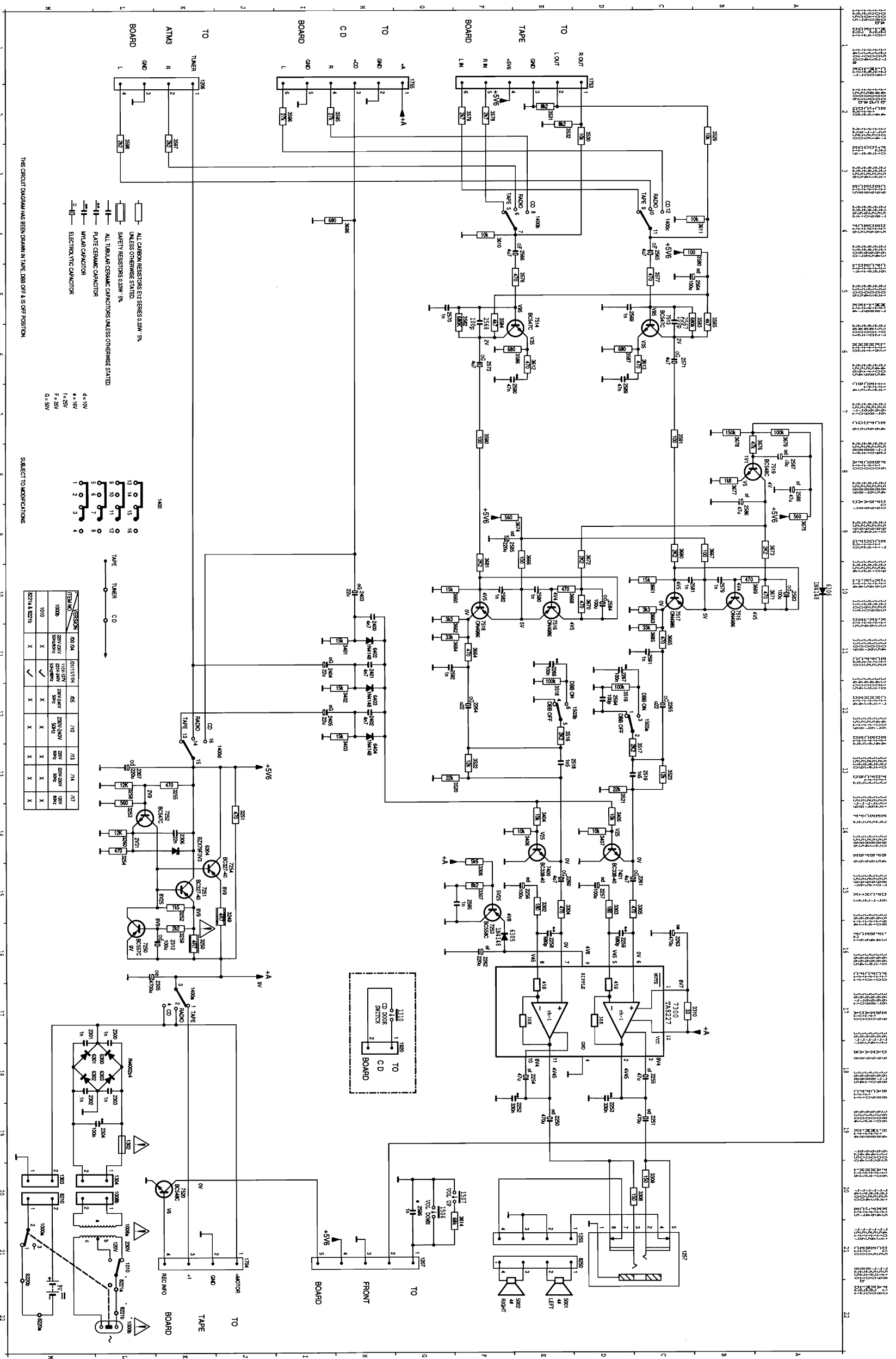

THIS CIRCUIT DIAGRAM HAS BEEN DRAWN IN TAPE DRIB OFF AS OFF POSITION.

SUBJECT TO MODIFICATIONS

- ALL CARBON RESISTORS E12 SERIES 0.25W 5%
- UNLESS OTHERWISE STATED
- SAFETY RESISTORS 0.25W 5%
- ALL TUBULAR CERAMIC CAPACITORS UNLESS OTHERWISE STATED
- PLATE CERAMIC CAPACITOR
- MILAR CAPACITOR
- ELECTROLYTIC CAPACITOR

- 4 = 10V
- 4 = 15V
- 1 = 20V
- F = 50V
- G = 50V

AUDIO BOARD (AZ1205) - LAYOUT DIAGRAM

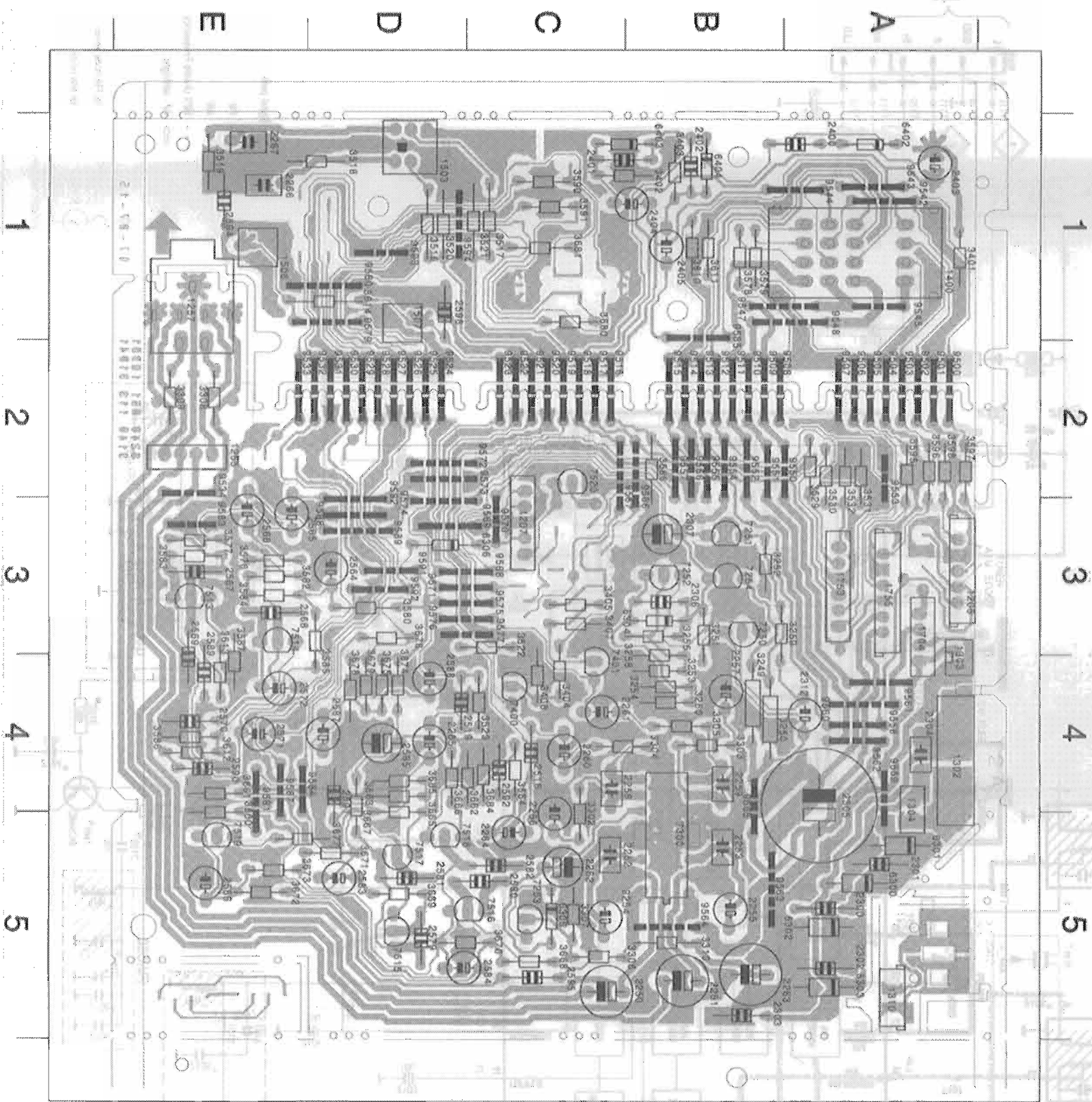

1206 A 3	2585 D 4	3598 A 2	9508 B 2	9583 E 3
1207 C 3	2588 E 5	3610 B 1	9509 B 2	9584 E 4
1256 E 2	2587 D 4	3611 B 1	9510 B 2	9585 B 1
1257 E 1	2588 D 4	3612 E 4	9511 B 2	9587 E 4
1302 A 4	2589 E 4	3613 E 4	9512 B 2	9588 D 3
1303 A 4	2590 E 4	3614 D 1	9513 B 2	9589 D 3
1304 A 4	2591 D 4	3680 E 5	9514 B 2	9591 D 3
1310 A 5	2592 C 4	3681 E 4	9515 B 2	9582 D 3
1400 A 1	2594 E 1	3682 C 2	9516 C 2	9593 D 1
1503 D 1	2595 C 5	3683 D 4	9517 C 2	9594 D 1
1508 E 1	2598 D 1	3684 C 4	9518 C 2	
1507 D 1	3248 B 4	3685 D 4	9519 C 2	
1704 A 3	3250 B 4	3686 D 4	9520 C 2	
1753 A 3	3251 B 3	3687 D 4	9521 C 2	
2250 A 3	3252 B 3	3688 C 5	9522 C 2	
2250 C 6	3253 B 4	3689 D 5	9523 C 2	
2251 B 5	3254 B 4	3670 C 5	9524 D 2	
2252 C 5	3255 B 3	3671 D 5	9525 D 2	
2253 B 5	3256 B 4	3672 E 5	9526 D 2	
2254 C 5	3259 B 3	3673 E 5	9527 D 2	
2256 C 5	3302 C 5	3674 D 2	9528 D 2	
2257 B 4	3303 B 4	3675 D 3	9529 D 2	
2258 C 4	3304 C 4	3677 E 5	9531 D 2	
2259 B 4	3305 B 4	3678 D 4	9532 D 2	
2260 C 4	3306 C 5	3679 D 4	9533 E 2	
2261 C 4	3307 C 5	3680 C 1	9534 E 2	
2262 C 5	3308 E 2	3681 C 1	9542 A 1	
2263 B 5	3309 E 2	3684 C 4	9543 A 1	
2264 C 5	3310 B 5	3685 D 4	9544 A 1	
2265 D 4	3401 A 1	3686 B 2	9545 A 1	
2266 E 1	3402 C 1	6300 A 5	9547 A 1	
2267 E 1	3403 B 1	6301 A 5	9548 A 1	
2300 A 5	3404 C 4	6302 A 4	9550 A 2	
2301 A 5	3405 C 3	6303 A 5	9551 B 2	
2302 A 5	3406 C 4	6304 A 3	9552 B 2	
2303 A 5	3407 C 3	6305 C 5	9553 A 2	
2304 A 4	3408 C 1	6306 D 3	9554 B 2	
2305 A 4	3517 C 1	6402 A 1	9555 B 2	
2306 B 3	3518 D 1	6403 C 1	9556 B 2	
2307 B 3	3519 E 1	6404 B 1	9557 B 2	
2312 A 4	3520 D 1	7250 B 3	9558 A 4	
2400 A 1	3521 C 1	7251 B 3	9559 A 4	
2401 C 1	3522 C 3	7252 B 3	9560 A 4	
2402 B 1	3523 C 4	7253 C 5	9561 A 4	
2403 A 1	3529 A 2	7254 B 3	9562 A 4	
2404 B 1	3530 A 2	7300 B 5	9563 B 5	
2405 B 1	3531 A 2	7400 C 4	9564 B 5	
2518 C 4	3532 A 2	7401 C 4	9565 B 4	
2519 D 4	3576 E 3	7513 E 3	9568 B 2	
2564 D 3	3577 E 3	7514 E 3	9569 C 2	
2565 E 3	3578 B 1	7515 D 5	9569 C 3	
2566 E 3	3579 B 1	7516 C 5	9569 D 3	
2567 E 3	3580 D 3	7517 D 5	9570 C 3	
2568 E 3	3582 E 3	7518 D 5	9571 C 3	
2569 E 4	3583 E 3	7519 E 5	9572 D 2	
2570 E 4	3584 E 3	7520 C 2	9573 D 2	
2571 E 4	3585 D 3	9501 A 2	9574 D 3	
2572 E 4	3586 E 4	9502 A 2	9575 C 3	
2579 D 5	3587 E 4	9503 A 2	9576 C 3	
2580 C 5	3590 C 1	9504 A 2	9577 C 3	
2581 D 5	3591 C 1	9504 A 2	9579 D 1	
2582 C 5	3599 A 2	9505 A 2	9580 D 1	
2583 D 5	3598 A 2	9506 A 2	9581 E 4	
2584 D 5	3597 A 2	9507 A 2	9582 D 3	

(PENTIA) GRAOBS REMUT DOJAWA  
GROBOSI WIMURA

# ANALOG TUNER BOARD (ATM3F)

## FM/MW VERSIONS

VERSION	FM 87.5-108MHz	Japan 76-108 MHz
2105	22p	22p
2106	20p	40p
2107	-	470p
2108	22p	10p
2109	4p7	2p2
5101	550H	60H
5104	40H	80H
9101	JMP	-

U .....provisional only  
W.....for Japanese version only

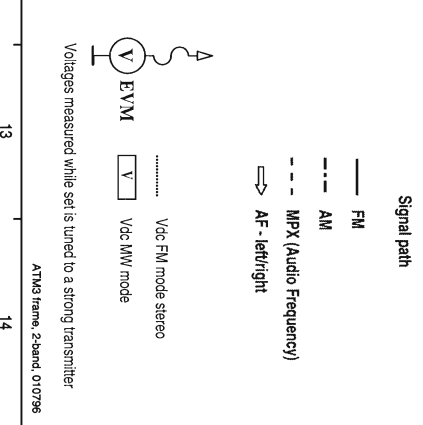
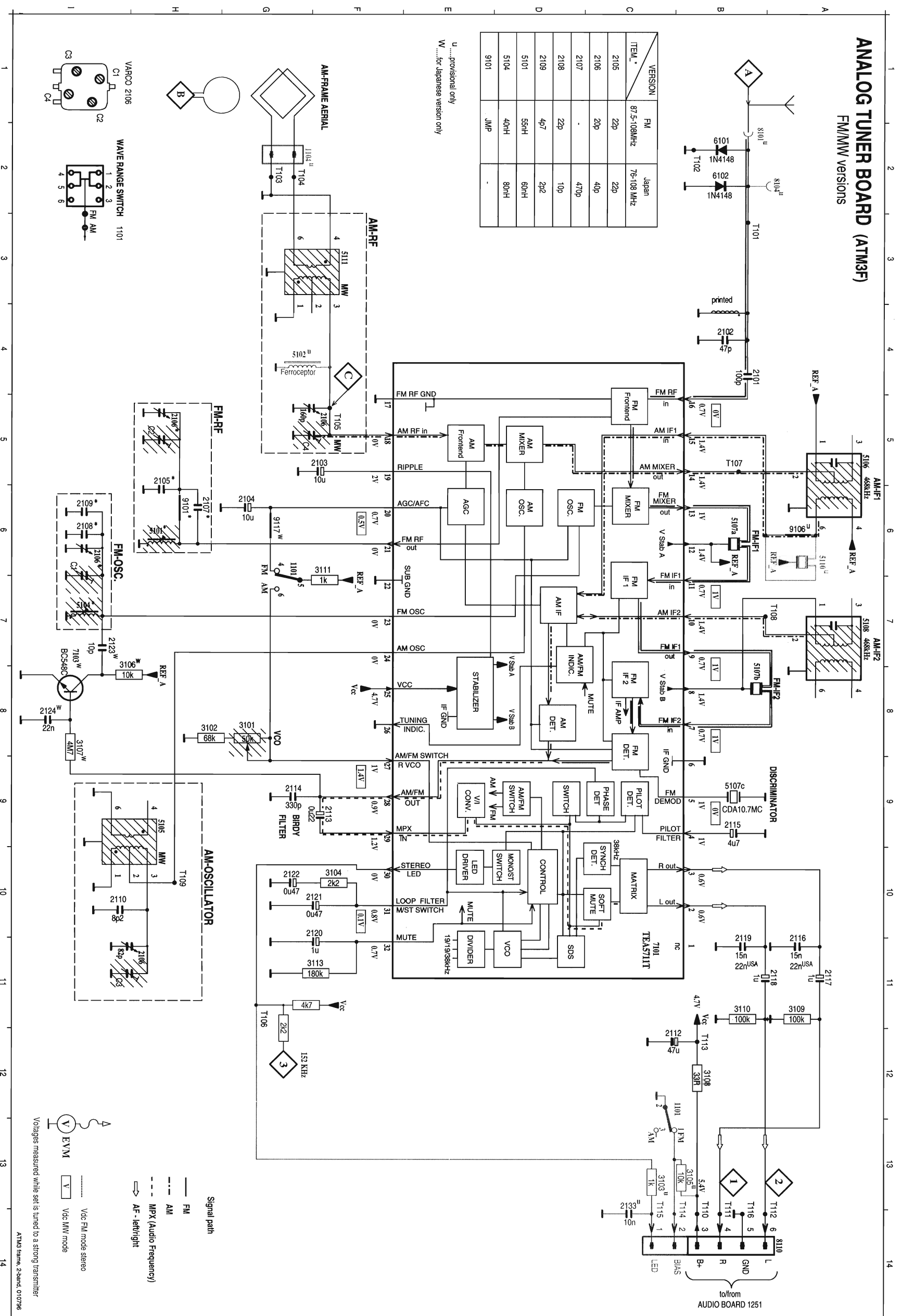

- 1101 B12
- 1101 G6
- 1104 G2
- 2101 B4
- 2102 B4
- 2103 F5
- 2104 G6
- 2105 H5
- 2106 H6
- 2106 H11
- 2106 F5
- 2107 H6
- 2108 H6
- 2109 I6
- 2110 I10
- 2112 B12
- 2113 F9
- 2114 G9
- 2115 B9
- 2116 A11
- 2118 A11
- 2118 B11
- 2120 F10
- 2121 F10
- 2122 G10
- 2123 I8
- 2124 I8
- 2125 C13
- 3101 G8
- 3102 G8
- 3102 C13
- 3102 F13
- 3105 B19
- 3105 I9
- 3107 I8
- 3109 B12
- 3109 A11
- 3110 B11
- 3111 F6
- 3113 F11
- 5101 H6
- 5102 G4
- 5104 I7
- 5105 I9
- 5106 A5
- 5107 A6
- 5107 B8
- 5107 C8
- 5107 D8
- 5107 E8
- 5107 F8
- 5107 G8
- 5107 H8
- 5107 I8
- 5108 A7
- 5110 A6
- 5111 F3
- 6101 B2
- 6102 B2
- 7101 C11
- 7103 I7
- 8101 B2
- 8104 A2
- 8110 A14
- 9101 H6
- 9106 A6
- 9117 G6



2101 B 1	2106 A 2	2114 B 4	2121 A 4	2104 A 4	2111 A 1	2106 B 3	6101 B 1	9101 B 3	9115 A 4
2102 A 1	2109 A 3	2115 B 4	2122 A 3	2105 A 4	2112 A 2	2107 B 3	6102 B 1	9102 B 3	9117 A 1
2102 B 2	2109 A 3	2115 B 4	2122 A 3	2105 A 4	2112 A 2	2107 B 3	6102 B 1	9102 B 3	9117 A 1
2103 B 3	2110 A 2	2118 B 4	2123 A 4	2106 A 3	2113 B 3	2107 B 4	7101 A 3	9103 B 2	9120 A 2
2104 B 2	2112 A 4	2119 A 4	2124 A 4	2107 A 3	2114 B 3	2108 B 4	7101 B 1	9104 B 1	9121 A 1
2105 B 2	2113 B 4	2120 A 4	2125 A 4	2108 A 4	2115 B 3	2109 A 1	8101 B 1	9111 B 1	9122 A 4
				2109 A 2	2116 B 2	2110 A 1	8104 A 1	9111 A 2	9123 A 1
				2110 A 4	2117 A 4	2111 A 2	8104 B 1	9112 A 2	
				2111 A 4	2118 A 4	2112 A 2	8105 A 4	9113 A 2	
				2112 A 4	2119 A 4	2113 A 2	8110 A 4	9114 A 2	
				2113 B 4	2120 A 4	2114 A 2			

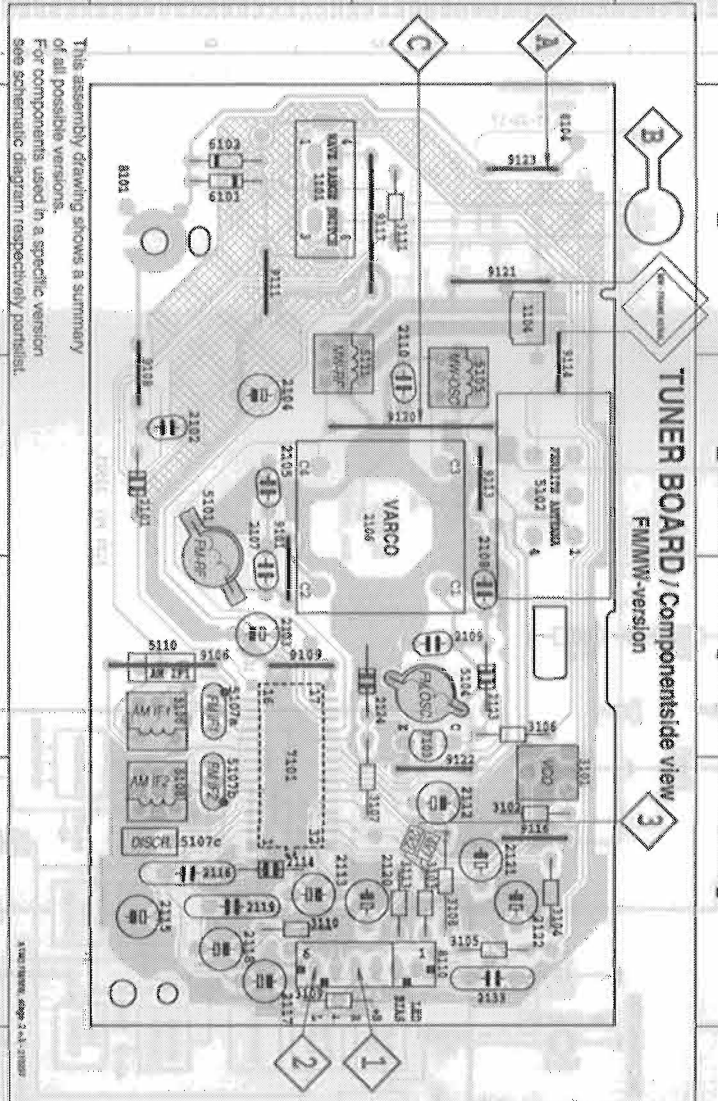

2101 B 1	2106 A 2	2114 B 4	2121 A 4	2104 A 4	2111 A 1	2106 B 3	6101 B 1	9101 B 3	9115 A 4
2102 A 1	2107 B 3	2115 B 4	2122 A 4	2105 A 4	2112 A 2	2107 B 3	6102 B 1	9102 B 3	9117 A 1
2102 B 2	2109 A 3	2117 B 4	2123 A 3	2106 A 4	2113 B 3	2107 B 4	7101 A 3	9103 B 2	9120 A 2
2103 B 2	2109 A 3	2117 B 4	2123 A 3	2106 A 4	2113 B 3	2107 B 4	7101 A 3	9103 B 2	9120 A 2
2103 B 3	2110 A 2	2117 B 4	2124 A 3	2107 A 3	2114 B 3	2108 B 4	7101 B 1	9104 B 1	9121 A 1
2104 B 2	2112 A 4	2119 A 4	2125 A 4	2108 A 4	2115 B 3	2109 A 1	8101 B 1	9111 B 1	9122 A 4
2105 B 2	2113 B 4	2120 A 4	2126 A 4	2109 A 4	2116 B 2	2110 A 1	8104 A 1	9111 A 2	9123 A 1
				2110 A 4	2117 A 4	2111 A 2	8104 B 1	9112 A 2	
				2111 A 4	2118 A 4	2112 A 2	8105 A 4	9113 A 2	
				2112 A 4	2119 A 4	2113 A 2			
				2113 B 4	2120 A 4	2114 A 2			

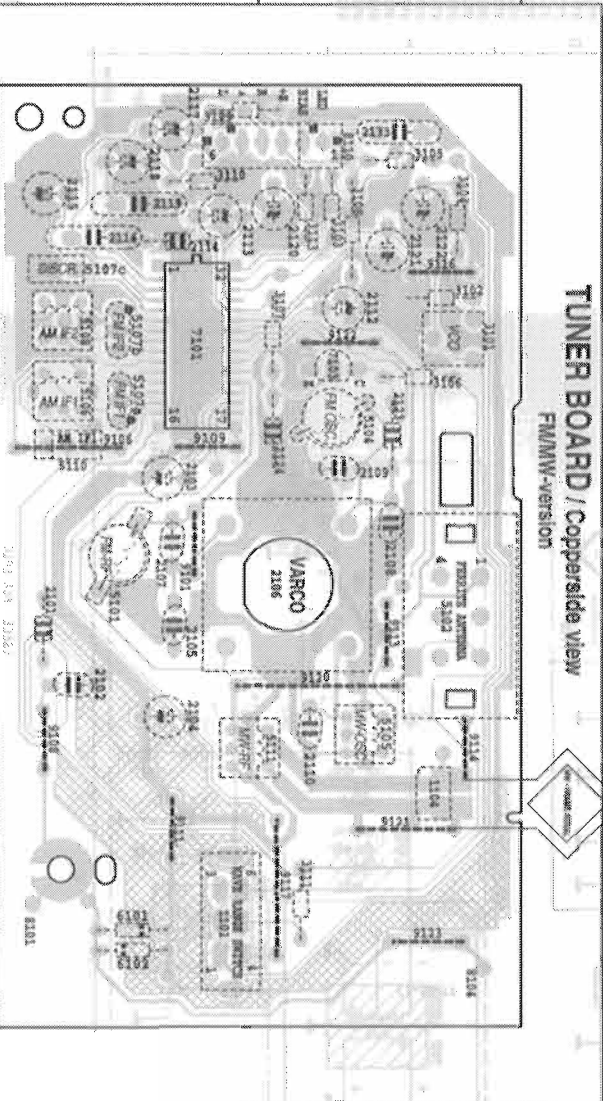

TUNER ADJUSTMENT TABLE (ATM3 FM/AM - versions with AM-frame aerial)

Wavelength	Input Frequency	Input	Set tuned to	Adjust	Measure on	Scope / Counter
<b>OSCILLATOR</b>						
FM 87.5 - 108 MHz	87.35 MHz	A	lower band end	5104	1 or 2	
			upper band end	2106 C1		
MW 525 - 1607 kHz (530 - 1710 kHz) 1)	512 kHz (520 kHz)	C	lower band end	5105	1 or 2	
			upper band end	2106 C3		
FM - RF 87.5 - 108 MHz	87.5 MHz	A	87.5 MHz	5101	1 or 2	
			108 MHz	2106 C2		
VCO	98 MHz	A	98 MHz	3101	3	
FM 98 MHz	98 MHz	A	continuous wave	3101	3	
			V <sub>RF</sub> = 1 mV			
AM - IF	468 kHz	C	connect pin 24 of IC 7101 (AM Osc) with short wire to ground	5106	1 or 2	
			$\Delta f = \pm 15 \text{ kHz}$ $V_{RF} = 10 \text{ mV}$	5108		
AM - RF	560 kHz	B	560 kHz	5111	1 or 2	
			1500 kHz	2106 C4		
MW	1500 kHz	B	$\Delta f = \pm 30 \text{ kHz}$ $V_{RF}$ as low as possible	2106 C4	1 or 2	
			1500 kHz			

1) for USA /17  
2) RC-network serves for damping the IF-filter while adjusting the other one.



This assembly drawing shows a summary of all possible versions. For components used in a specific version, see schematic diagram respectively partlist.

# ANALOG TUNER BOARD (ATM3F)

## FM/LW/MW and FM/SW/MW versions

VERSION	FM	EAST EUROPE
ITEM *	87.5-108MHz	65-108 MHz
2105	22p	8p2
2106	20p	40p
2107	-	390p
2108	22p	5p6
2109	4p7	2p2
5101	55H	91H
5104	40H	72H
9101	JMP	-

U ..... provisional only  
 Y ..... value for SW-EU (5.918.1MHz)  
 SW ..... only for FM/SW/MW version  
 LW ..... only for FM/LW/MW version

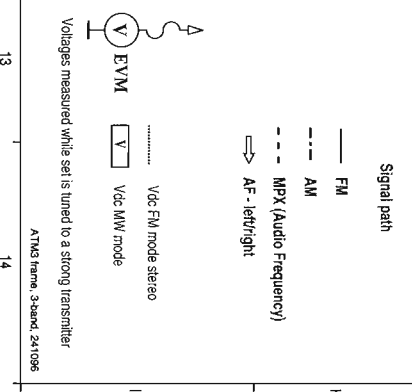
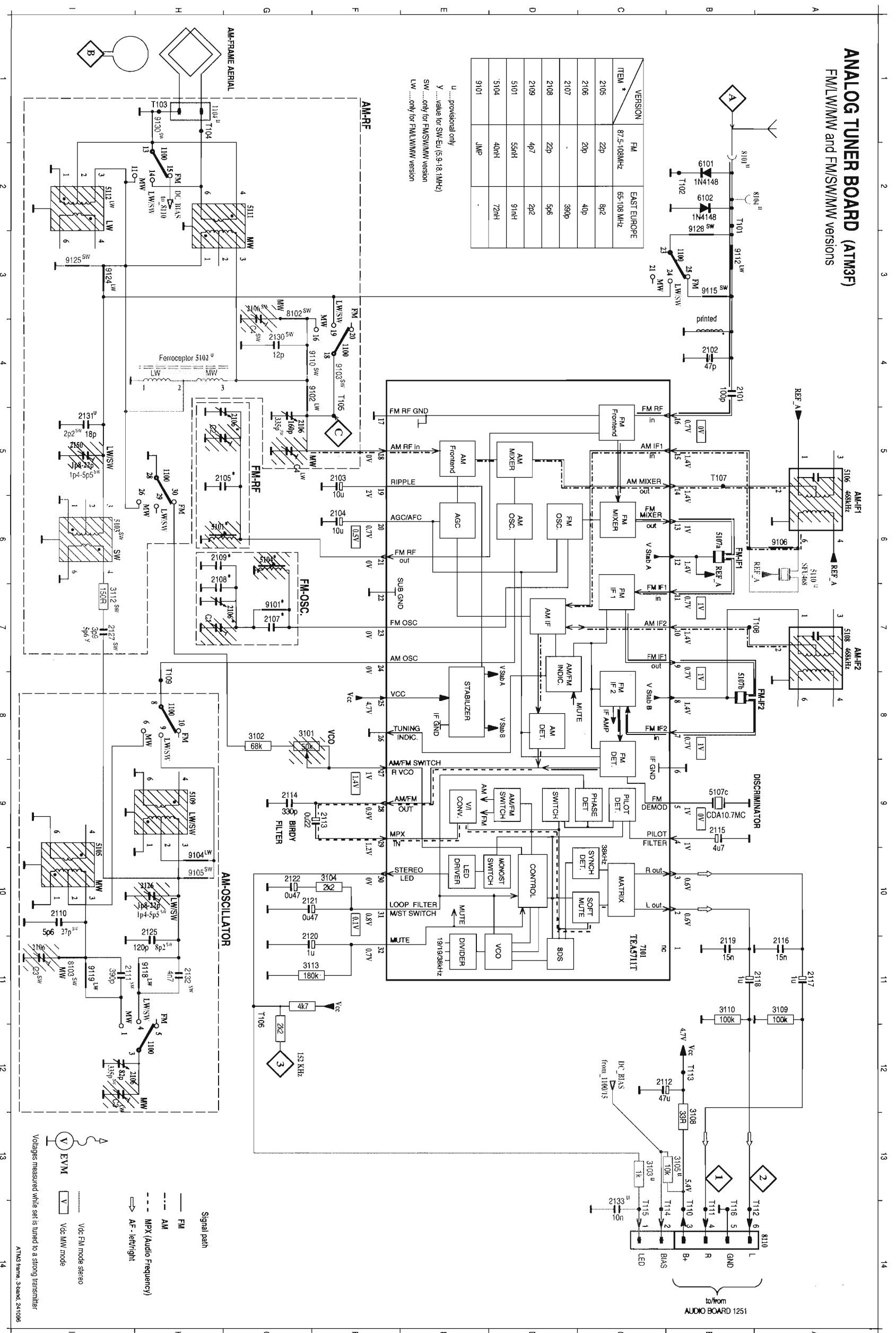

- 1100 H12
- 1100 H8
- 1100 F2
- 1100 B3
- 1100 H5
- 1104 H1
- 2101 B4
- 2102 B4
- 2103 F5
- 2104 F6
- 2105 F6
- 2106 G7
- 2106 G5
- 2108 G2
- 2108 G5
- 2108 G3
- 2107 G7
- 2109 H6
- 2109 H6
- 2110 H0
- 2111 H1
- 2112 B12
- 2113 F9
- 2114 G9
- 2115 B9
- 2116 B9
- 2117 A11
- 2118 B11
- 2120 F1
- 2120 G10
- 2125 H10
- 2127 L7
- 2130 G4
- 2131 F5
- 2132 H11
- 2133 C14
- 2150 F5
- 3101 G8
- 3102 G8
- 3102 C13
- 3104 F10
- 3105 B13
- 3109 A13
- 3110 B11
- 3112 F17
- 3113 F11
- 5101 H4
- 5102 H4
- 5103 H6
- 5104 G6
- 5105 H0
- 5106 A5
- 5107 A8
- 5107 B8
- 5107 C9
- 5108 A7
- 5109 F9
- 5110 G2
- 5111 G2
- 5112 L2
- 6101 B2
- 6102 B2
- 7101 C11
- 8101 B2
- 8102 G3
- 8103 H1
- 8104 A2
- 8110 A14
- 9101 G7
- 9102 G4
- 9102 F10
- 9104 H10
- 9105 A6
- 9110 G4
- 9112 B3
- 9115 B3
- 9118 B11
- 9119 H11
- 9124 H3
- 9125 B3
- 9128 B3
- 9130 H1

2100 B 1	2108 A 3	2117 B 4	2120 B 2	2106 A 4	5104 A 3	5111 A 1	9120 A 4	9109 B 3	9118 B 1	9130 A 1
2104 A 1	2100 A 3	2118 B 4	2121 B 1	2108 A 4	5105 A 1	5112 A 1	9121 A 3	9110 A 2	9119 B 1	
2103 B 3	2110 A 1	2119 B 4	2122 B 2	2109 B 4	5108 B 3	5101 B 1	9122 A 2	9111 A 1	9120 A 2	
2102 B 3	2111 A 2	2120 B 4	2123 B 3	2110 B 4	5107 B 3	5102 B 1	9123 B 2	9112 A 1	9121 A 1	
2104 B 3	2112 A 4	2121 A 4	2124 B 1	2111 B 4	5107 B 4	7101 B 1	9124 A 3	9113 A 1	9122 A 1	
2104 B 3	2113 B 2	2122 A 4	2125 B 1	2112 B 4	5107 B 4	9101 B 1	9125 B 1	9114 A 2	9123 A 1	
2105 B 2	2114 B 4	2123 B 4	2126 B 1	2113 B 4	5108 B 4	9102 B 1	9126 B 1	9115 B 1	9124 B 1	
2106 A 2	2115 B 4	2124 B 4	2127 B 2	2114 B 4	5109 A 2	9103 B 1	9127 A 1	9116 A 1	9125 A 1	
2106 A 2	2116 B 4	2125 B 4	2128 B 2	2115 B 4	5109 B 2	9104 A 1	9128 B 1	9117 A 1	9126 B 1	
2107 A 3	2118 B 4	2127 B 2	2130 A 4	2116 B 4	5110 B 2	9104 A 1	9129 B 1	9118 A 1		

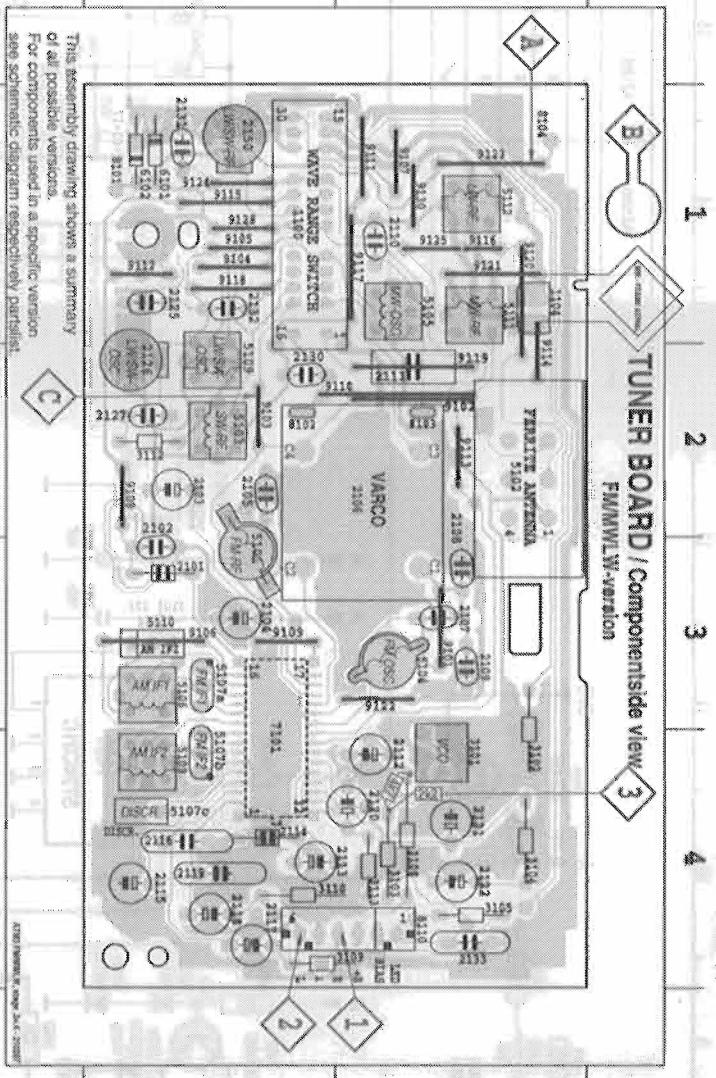

1160 B 1	2108 A 3	2117 B 4	2130 A 4	5104 A 3	5111 A 1	9120 A 4	9118 B 1
1164 A 1	2109 A 3	2118 B 4	2131 B 1	5105 A 1	5112 A 1	9121 A 3	9119 B 1
2102 B 3	2110 A 1	2119 B 4	2132 B 2	5108 B 3	5101 B 1	9122 A 2	9120 A 2
2102 B 3	2111 A 2	2120 B 4	2133 B 3	5107 B 3	5102 B 1	9123 B 2	9111 A 1
2103 B 3	2112 A 4	2121 A 4	2134 B 4	5107 B 4	7101 B 1	9124 A 3	9112 A 1
2104 B 3	2113 B 2	2122 A 4	2135 B 1	5107 B 4	9101 B 1	9125 B 1	9113 A 1
2104 B 3	2114 B 4	2123 B 4	2136 B 1	5108 B 4	9102 B 1	9126 B 1	9114 A 2
2105 B 2	2115 B 4	2124 B 4	2137 B 2	5109 A 2	9103 B 1	9127 A 1	9115 B 1
2106 A 2	2116 B 4	2125 B 4	2138 B 2	5109 B 2	9104 A 1	9128 B 1	9116 A 1
2107 A 3	2118 B 4	2127 B 2	2139 B 2	5110 B 2	9104 A 1	9129 B 1	9118 A 1

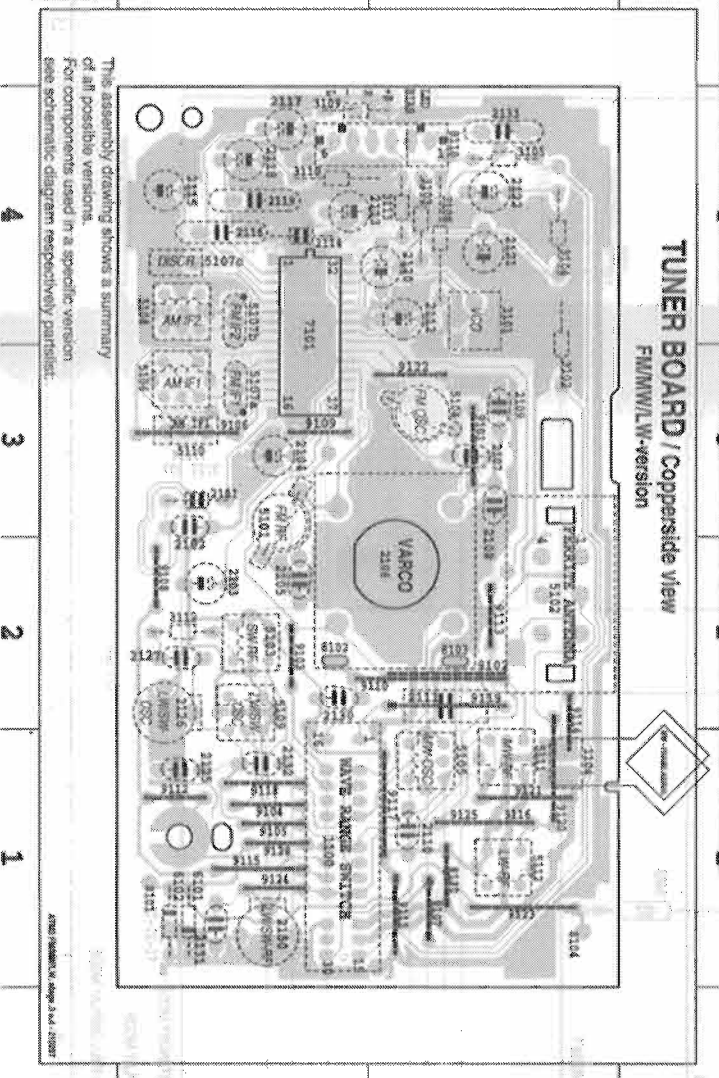

**TUNER ADJUSTMENT TABLE ( ATM3 FM/LW/MW - versions with AM-frame aerial )**

Waverange	Input Frequency	Input	Set tuned to	Adjust	Measure on	Scope / Counter
<b>FM</b> 87.5 - 108 MHz (65 - 108 MHz) <sup>1)</sup>	87.35 MHz (64.7 MHz)	<b>A</b>	lower band end upper band end	5104 2106 C1	<b>1</b> or <b>2</b>	
<b>MW</b> 525 - 1607 KHz (530 - 1710 KHz) <sup>2)</sup>	512 KHz (520 KHz)	<b>C</b>	lower band end upper band end	5105 2106 C3	<b>1</b> or <b>2</b>	
<b>LW</b> <sup>3)</sup> 148.5 - 284 KHz	147 KHz	$\Delta f = \pm 30 \text{ kHz}$ $V_{RF} = 100 \mu\text{V}$	lower band end upper band end	5109 2126	<b>1</b> or <b>2</b>	
<b>FM - RF</b> 87.5 MHz (65 MHz)	87.5 MHz (65 MHz)	<b>A</b>	87.5 MHz (65 MHz)	5101 2106 C2	<b>1</b> or <b>2</b>	
<b>VCO</b> 87.5 - 108 MHz (65 - 108 MHz) <sup>1)</sup>	108 MHz	$\Delta f = \pm 500 \text{ kHz}$ $V_{RF} = 10 \mu\text{V}$	108 MHz	2106 C2	<b>1</b> or <b>2</b>	
<b>FM</b> 98 MHz	98 MHz	<b>A</b> continuous wave $V_{RF} = 1 \text{ mV}$	98 MHz	3101	<b>3</b> 	152 ± 1 kHz
<b>AM - IF</b>	488 kHz	<b>C</b>	connect pin 24 of IC 7101 (AM Osc) with short wire to ground	5108	<b>1</b> or <b>2</b>	
<b>AM</b>	560 kHz	$\Delta f = \pm 15 \text{ kHz}$ $V_{RF} = 10 \text{ mV}$	560 kHz	5111	<b>1</b> or <b>2</b>	
<b>MW</b>	1500 kHz	<b>B</b>	1500 kHz	2106 C4	<b>1</b> or <b>2</b>	
<b>LW</b> <sup>3)</sup>	280 kHz	$\Delta f = \pm 30 \text{ kHz}$ $V_{RF}$ as low as possible	280 kHz	2150	<b>1</b> or <b>2</b>	

repeat <sup>1)</sup> for East Europe /14 <sup>2)</sup> for USA /17 <sup>3)</sup> LW not for all versions  
<sup>4)</sup> RC-network serves for damping the IF-filter while adjusting the other one.

FRONT BOARD - CIRCUIT DIAGRAM

- 1401 A 3 1411 H 5 1417 I 6 2444 C14 2496 G 8
- 1402 G14 1412 H 5 2441 B 5 2445 D15 2498 E11
- 1403 F11 1413 I 6 2442 C 8 2446 D15 2499 D12
- 1404 E12 1414 J 6 2443 D12 2447 E11 2491 E13
- 1410 1415 I 5 2443 D12 2448 F12 2492 F12
- 1411 I 5 2444 C14 2449 G13 2493 G13
- 2441 B 5 2445 D15 2441 B 5 2445 D15 2494 H 3
- 2442 C 8 2446 D15 2442 C 8 2446 D15 2495 I 4
- 2443 D12 2447 E11 2443 D12 2447 E11 2496 G 8
- 2444 C14 2448 F12 2444 C14 2448 F12 2497 H 4
- 2445 D15 2449 G13 2445 D15 2449 G13 2498 I 5
- 2446 D15 2449 G13 2446 D15 2449 G13 2499 J 6
- 2447 E11 2491 E13 2447 E11 2491 E13 3401 A 9
- 2448 F12 2492 F12 2448 F12 2492 F12 3402 C 8
- 2449 G13 2493 G13 2449 G13 2493 G13 3403 C 9
- 2496 G 8 3404 A 8 3404 A 8 3410 H 4
- 2498 E11 3405 A 8 3405 A 8 3411 H 5
- 2499 D12 3406 B 8 3406 B 8 3412 H 6
- 3401 A 9 3401 A 9 3412 H 6
- 3402 C 8 3412 H 6
- 3403 C 9 3413 I 5
- 3404 A 8 3414 J 6
- 3405 A 8 3415 I 6
- 3406 B 8 3416 I 6
- 3407 H 4 3417 J 6
- 3408 I 5 3418 I 6
- 3409 J 6 3419 J 6
- 3410 H 4 3420 K 6
- 3411 H 5 3421 K 6
- 3412 H 6 3422 L 6
- 3413 I 5 3423 L 6
- 3414 J 6 3424 M 6
- 3415 I 6 3425 M 6
- 3416 I 6 3426 N 6
- 3417 J 6 3427 N 6
- 3418 J 6 3428 O 6
- 3419 K 6 3429 O 6
- 3420 K 6 3430 P 6
- 3421 L 6 3431 P 6
- 3422 L 6 3432 Q 6
- 3423 M 6 3433 Q 6
- 3424 M 6 3434 R 6
- 3425 M 6 3435 R 6
- 3426 N 6 3436 S 6
- 3427 N 6 3437 S 6
- 3428 O 6 3438 T 6
- 3429 O 6 3439 T 6
- 3430 P 6 3440 U 6
- 3431 P 6 3441 U 6
- 3432 Q 6 3442 V 6
- 3433 Q 6 3443 V 6
- 3434 R 6 3444 W 6
- 3435 R 6 3445 W 6
- 3436 S 6 3446 X 6
- 3437 S 6 3447 X 6
- 3438 T 6 3448 Y 6
- 3439 T 6 3449 Y 6
- 3440 U 6 3450 Z 6
- 3441 U 6 3451 Z 6
- 3442 V 6 3452 Z 6
- 3443 V 6 3453 Z 6
- 3444 W 6 3454 Z 6
- 3445 W 6 3455 Z 6
- 3446 X 6 3456 Z 6
- 3447 X 6 3457 Z 6
- 3448 Y 6 3458 Z 6
- 3449 Y 6 3459 Z 6
- 3450 Z 6 3460 Z 6
- 3451 Z 6 3461 Z 6
- 3452 Z 6 3462 Z 6
- 3453 Z 6 3463 Z 6
- 3454 Z 6 3464 Z 6
- 3455 Z 6 3465 Z 6
- 3456 Z 6 3466 Z 6
- 3457 Z 6 3467 Z 6
- 3458 Z 6 3468 Z 6
- 3459 Z 6 3469 Z 6
- 3460 Z 6 3470 Z 6
- 3461 Z 6 3471 Z 6
- 3462 Z 6 3472 Z 6
- 3463 Z 6 3473 Z 6
- 3464 Z 6 3474 Z 6
- 3465 Z 6 3475 Z 6
- 3466 Z 6 3476 Z 6
- 3467 Z 6 3477 Z 6
- 3468 Z 6 3478 Z 6
- 3469 Z 6 3479 Z 6
- 3470 Z 6 3480 Z 6
- 3471 Z 6 3481 Z 6
- 3472 Z 6 3482 Z 6
- 3473 Z 6 3483 Z 6
- 3474 Z 6 3484 Z 6
- 3475 Z 6 3485 Z 6
- 3476 Z 6 3486 Z 6
- 3477 Z 6 3487 Z 6
- 3478 Z 6 3488 Z 6
- 3479 Z 6 3489 Z 6
- 3480 Z 6 3490 Z 6
- 3481 Z 6 3491 Z 6
- 3482 Z 6 3492 Z 6
- 3483 Z 6 3493 Z 6
- 3484 Z 6 3494 Z 6
- 3485 Z 6 3495 Z 6
- 3486 Z 6 3496 Z 6
- 3487 Z 6 3497 Z 6
- 3488 Z 6 3498 Z 6
- 3489 Z 6 3499 Z 6
- 3490 Z 6 3500 Z 6

MODEL NO.	ITEM NO.	AZ1200	AZ1205
	9486	✓	X
	9487	✓	X
	9421	✓	X
	9489	✓	X

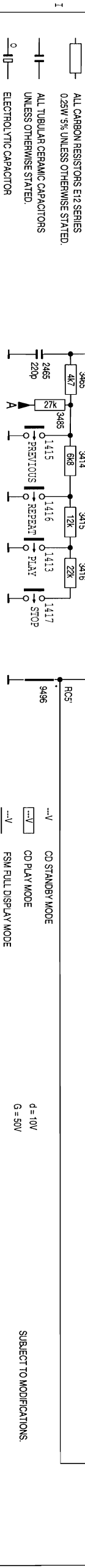
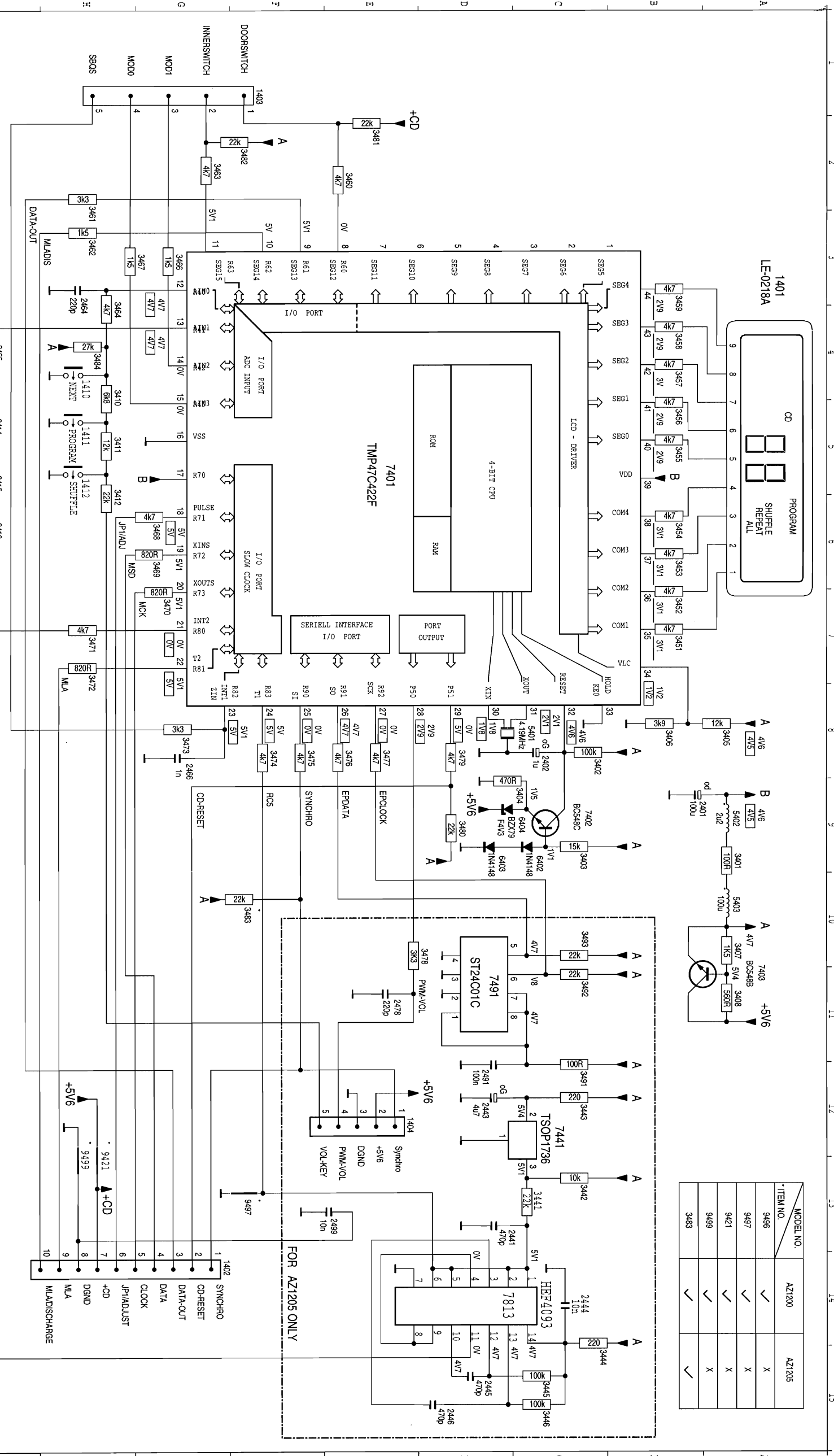

FRONT BOARD - LAYOUT DIAGRAM

MARZANO TUCCHIO - GRAFOS X3200 3PAT

1401 A 3	1416 A 5	2464 A 5	3404 B 3	3415 A 1	3452 A 3	3461 A 5	3470 B 4	3479 B 3	3493 B 3	7403 A 2	9409 B 1	9422 B 2	9499 B 1
1402 B 1	1417 A 1	2465 A 5	3405 A 3	3416 A 1	3453 A 3	3462 A 5	3471 B 4	3480 B 1	5401 A 3	7441 A 2	9410 B 5	9423 A 1	
1403 A 1	2401 B 5	2466 B 4	3406 A 3	3441 A 2	3454 A 3	3463 A 5	3472 B 4	3481 A 1	5402 B 5	7491 B 3	9411 B 1	9424 B 2	
1404 A 2	2402 B 3	2478 B 3	3407 A 3	3442 A 1	3455 A 3	3464 A 5	3473 B 4	3482 A 1	5403 B 5	7813 B 2	9412 B 1	9428 B 2	
1410 B 2	2441 B 2	2491 B 3	3408 A 2	3443 A 2	3456 A 3	3465 A 5	3474 B 4	3483 A 1	6402 A 3	9402 A 2	9413 B 2	9429 B 3	
1411 B 5	2443 A 2	2499 B 1	3410 A 5	3444 A 2	3457 A 4	3466 B 5	3475 B 4	3484 A 1	6403 A 3	9403 B 2	9414 B 2	9495 B 3	
1412 B 5	2444 B 2	3401 B 5	3411 A 5	3445 B 1	3458 A 4	3467 B 5	3476 B 4	3485 A 1	6404 B 2	9406 B 4	9417 B 1	9496 B 4	
1413 B 1	2445 B 1	3402 A 3	3412 A 1	3446 B 2	3459 A 4	3468 B 5	3477 B 4	3491 B 3	7401 A 4	9407 B 1	9418 A 3	9497 B 4	
1415 B 2	2446 B 1	3403 A 3	3414 A 5	3451 A 3	3460 A 5	3469 B 4	3478 B 3	3492 B 4	7402 B 3	9408 B 1	9421 B 1	9498 B 1	

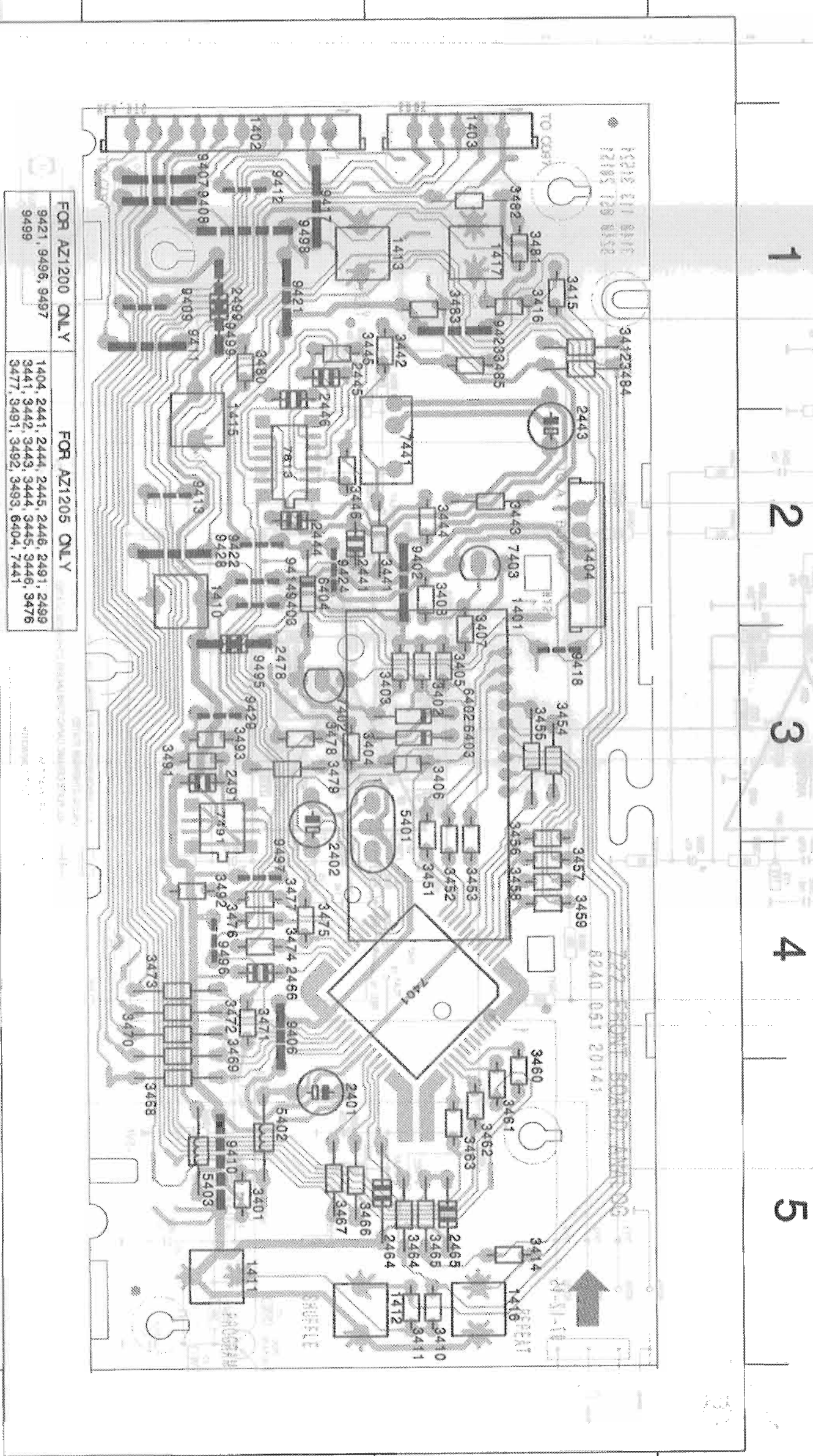

FOR AZ1200 ONLY	FOR AZ1205 ONLY
9421, 9496, 9497	1404, 2441, 2444, 2445, 2446, 2491, 2499
9499	3441, 3442, 3443, 3444, 3445, 3446, 3476
	3477, 3491, 3492, 3493, 6404, 7441

1 2 3 4 5

B

A

B

A



TAPE DECK BOARD - LAYOUT DIAGRAM

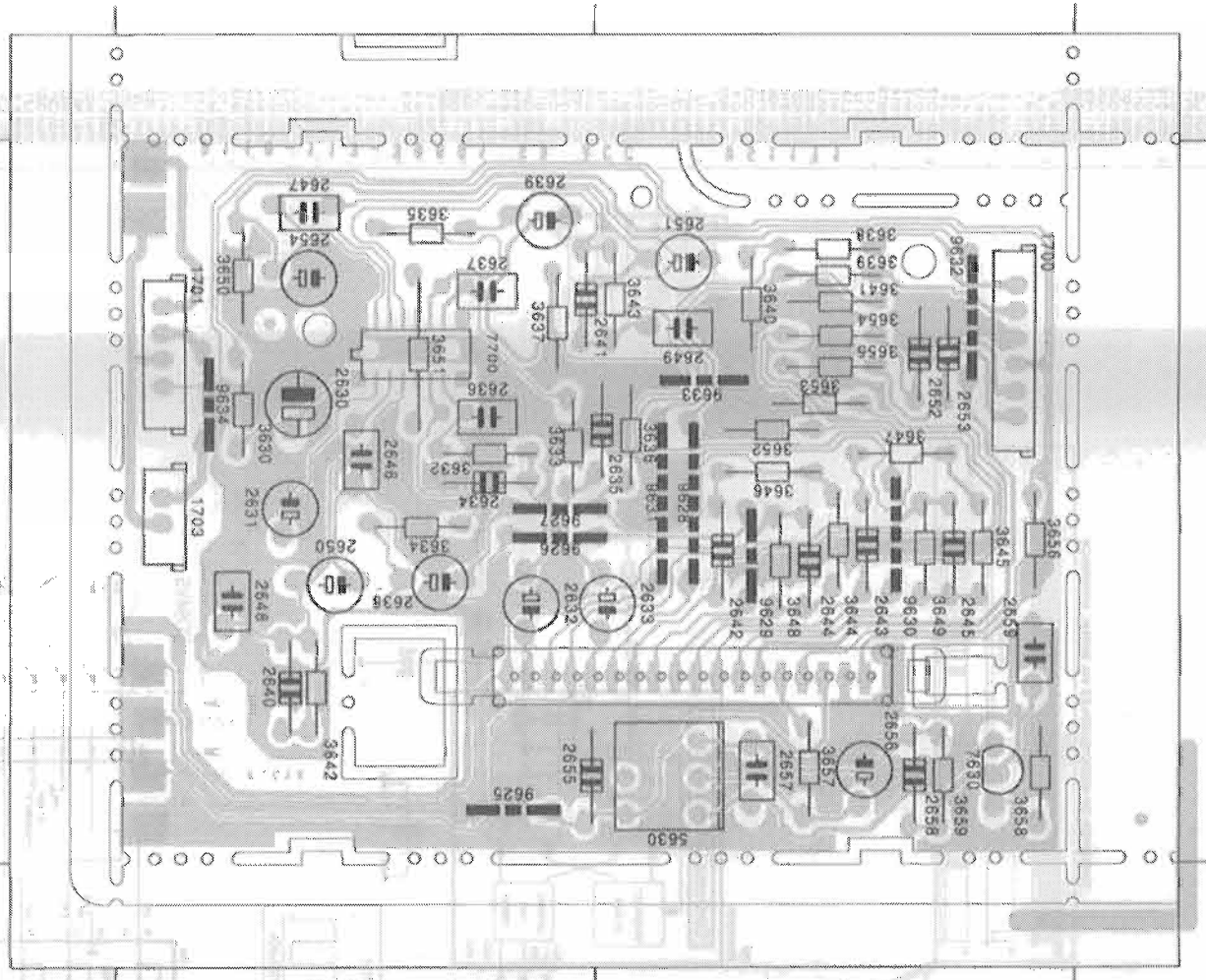

CASSETTE ADJUSTMENT

Adjustment	Cassette	SK ...	Deck 1	Measure on	Read on	Adjust with	Adjust to
Azimuth	10KHz SBC420*	TAPE	Play	H/P Jack	mV meter	Left hand Screw R/P Head	max.
Motor Speed	3150KHz SBC420*	TAPE	Play	H/P Jack	Wow and flutter meter	Preset in motor	**a

\* SBC420 : 4822 397 30071  
 \*\*a The maximum permissible speed deviation is ± 3%.  
 Moreover, the wow and flutter value can be read.

- 1619 A1 1629 A1 1639 A2 2635 A1 2645 A1 2655 A2 3636 A1 3646 A1 3656 A1 9628 A1 PAD4 A2
- 1620 A1 1630 A1 1640 A2 2636 A2 2646 A2 2656 A1 3637 A2 3647 A1 3657 A1 9629 A1 PAD5 A2
- 1621 A2 1631 A1 1700 A1 2637 A2 2647 A2 2657 A1 3638 A1 3648 A1 3658 A1 9630 A1 PAD6 A2
- 1622 A2 1632 A1 1701 A2 2638 A2 2648 A2 2658 A1 3639 A1 3649 A1 3659 A1 9631 A1
- 1623 A1 1633 A1 1703 A2 2639 A2 2649 A1 2659 A1 3640 A1 3650 A2 5630 A1 9632 A1
- 1624 A1 1634 A1 2630 A2 2640 A2 2650 A2 3641 A1 3651 A2 7630 A1 9633 A1
- 1625 A1 1635 A1 2631 A2 2641 A2 2651 A1 3642 A2 3652 A1 7700 A2 9635 A2
- 1626 A1 1636 A1 2632 A2 2642 A1 2652 A1 3643 A2 3653 A1 9625 A2 PAD1 A2
- 1627 A1 1637 A2 2633 A1 2643 A1 2653 A1 3644 A2 3654 A1 9626 A2 PAD2 A2
- 1628 A1 1638 A2 2634 A2 2644 A1 2654 A2 3645 A1 3655 A1 9627 A2 PAD3 A2

## CASSETTE ADJUSTMENT

Adjustment	Cassette	SK ....	Deck 1	Measure on	Read on	Adjust with	Adjust to
Azimuth	10KHz SBC420*	TAPE	Play	H/P Jack	mV meter	Left hand Screw R/P Head	max.
Motor Speed	3150KHz SBC420*	TAPE	Play	H/P Jack	Wow and flutter meter	Preset in motor	**a

\* SBC420 : 4822 397 30071

\*\*a The maximum permissible speed deviation is  $\pm 3\%$ .  
Moreover, the wow and flutter value can be read.

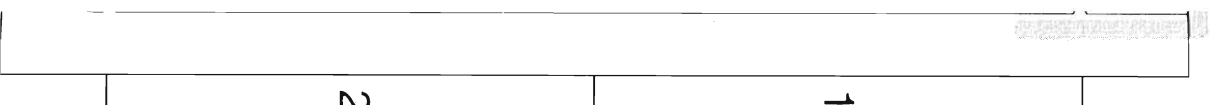

PAD4 A2  
PAD5 A2  
PAD6 A2





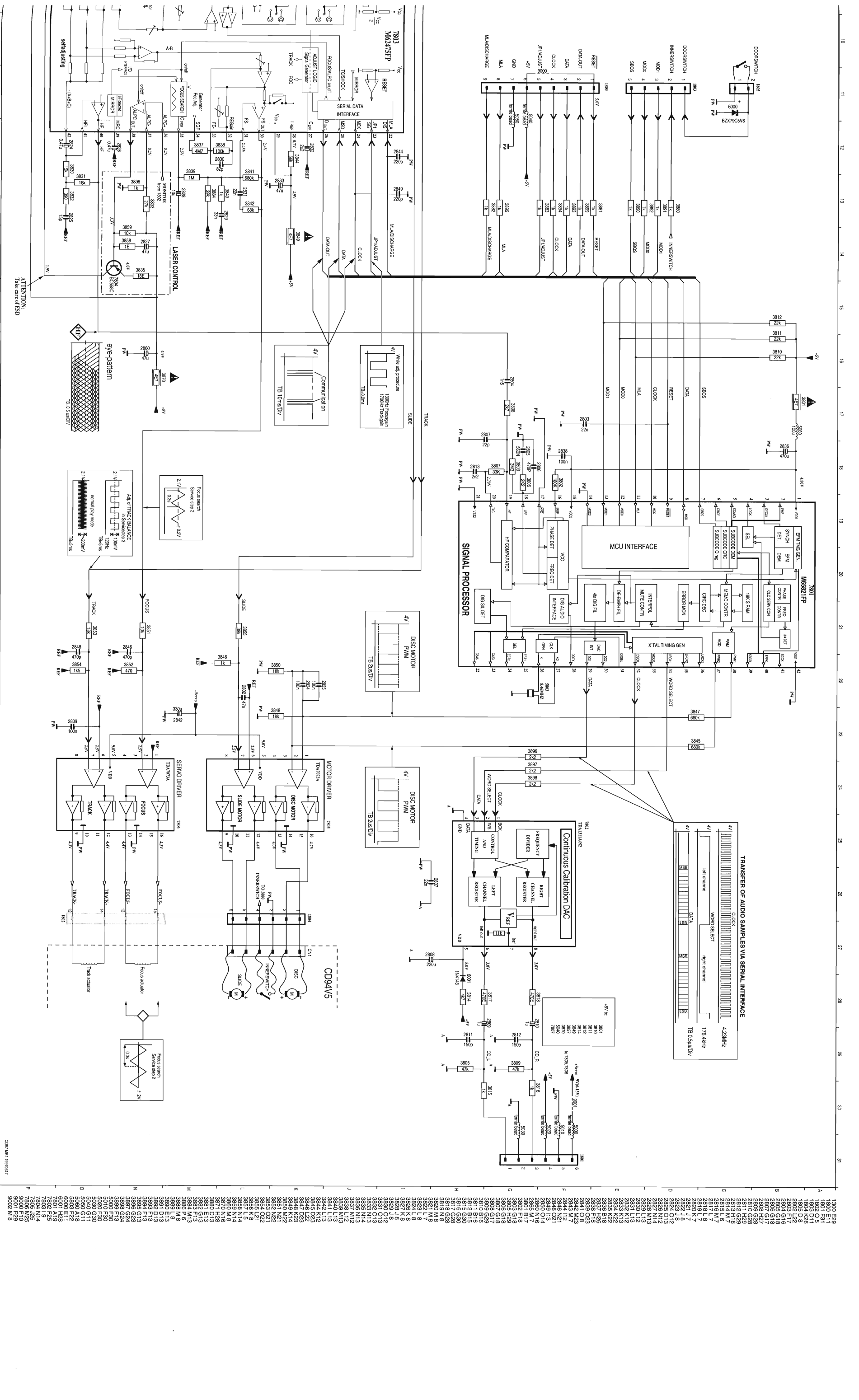

1300 E29  
1800 E11  
1801 E11  
1802 D11  
1803 D11  
1804 K26  
1805 L22  
2802 L22  
2803 F17  
2804 G18  
2805 G18  
2807 G17  
2808 D27  
2809 D27  
2810 G28  
2811 H29  
2812 G28  
2813 M7  
2814 M7  
2815 L6  
2816 M7  
2817 M7  
2818 L8  
2819 L7  
2820 L7  
2821 L7  
2822 L7  
2823 J8  
2824 J8  
2825 O13  
2826 N14  
2827 N14  
2828 N14  
2829 O13  
2830 L12  
2831 L13  
2832 L13  
2833 K13  
2834 K13  
2835 K22  
2836 K22  
2837 H26  
2838 F18  
2839 O23  
2840 M23  
2841 M7  
2842 M23  
2843 M7  
2844 N12  
2845 N12  
2846 O21  
2847 O21  
2848 O21  
2849 L13  
2850 M7  
2851 M7  
2852 M7  
2853 M7  
2854 M7  
2855 M7  
2856 M7  
2857 M7  
2858 M7  
2859 M7  
2860 M7  
2861 B17  
2862 G18  
2863 G18  
2864 G18  
2865 G18  
2866 M7  
2867 M7  
2868 M7  
2869 G29  
2870 B16  
2871 B16  
2872 B16  
2873 B15  
2874 B15  
2875 G30  
2876 G30  
2877 G28  
2878 G28  
2879 N8  
2880 N8  
2881 M8  
2882 L7  
2883 L8  
2884 L8  
2885 K8  
2886 K8  
2887 K8  
2888 J8  
2889 J8  
2890 O13  
2891 O13  
2892 O13  
2893 O13  
2894 N13  
2895 N13  
2896 M12  
2897 M12  
2898 M12  
2899 M13  
2900 M13  
2901 L13  
2902 L13  
2903 K12  
2904 K12  
2905 D23  
2906 D23  
2907 K23  
2908 K23  
2909 K14  
2910 K14  
2911 M22  
2912 M22  
2913 M22  
2914 M22  
2915 O21  
2916 O21  
2917 O21  
2918 K9  
2919 K9  
2920 L5  
2921 L5  
2922 M8  
2923 M8  
2924 M8  
2925 M8  
2926 M8  
2927 M8  
2928 M8  
2929 M8  
2930 M8  
2931 M8  
2932 M8  
2933 M8  
2934 M8  
2935 M8  
2936 M8  
2937 M8  
2938 M8  
2939 M8  
2940 M8  
2941 M8  
2942 M8  
2943 M8  
2944 M8  
2945 M8  
2946 M8  
2947 M8  
2948 M8  
2949 M8  
2950 M8  
2951 M8  
2952 M8  
2953 M8  
2954 M8  
2955 M8  
2956 M8  
2957 M8  
2958 M8  
2959 M8  
2960 M8  
2961 M8  
2962 M8  
2963 M8  
2964 M8  
2965 M8  
2966 M8  
2967 M8  
2968 M8  
2969 M8  
2970 M8  
2971 M8  
2972 M8  
2973 M8  
2974 M8  
2975 M8  
2976 M8  
2977 M8  
2978 M8  
2979 M8  
2980 M8  
2981 M8  
2982 M8  
2983 M8  
2984 M8  
2985 M8  
2986 M8  
2987 M8  
2988 M8  
2989 M8  
2990 M8  
2991 M8  
2992 M8  
2993 M8  
2994 M8  
2995 M8  
2996 M8  
2997 M8  
2998 M8  
2999 M8  
3000 M8

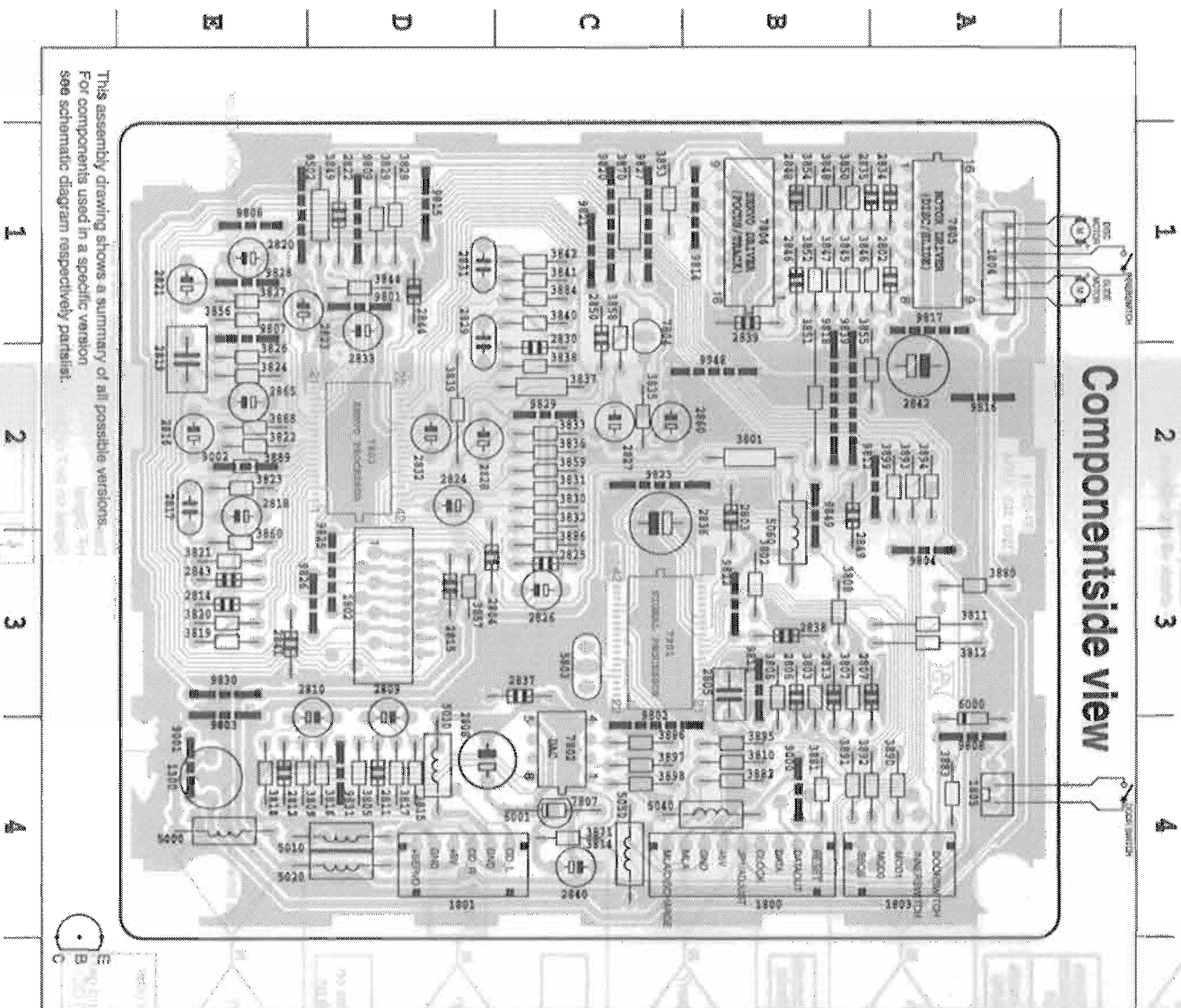

This assembly drawing shows a summary of all possible versions.  
For components used in a specific version  
see schematic diagram respectively partlist.

1300 B 4	3807 B 3	5891 B 4
1800 B 4	3808 B 3	3892 A 4
1801 D 4	3809 B 4	3893 A 2
1802 D 3	3810 B 4	3894 A 2
1803 A 4	3811 A 3	3895 B 4
1804 A 1	3812 A 3	3896 C 4
1805 A 4	3814 C 4	3897 C 4
1805 A 1	3815 D 4	3898 C 4
1806 B 2	3816 D 4	3899 A 2
1806 D 3	3817 D 4	5000 E 4
1807 B 3	3818 E 4	5010 D 4
1808 B 3	3819 E 3	5020 D 4
1809 A 3	3820 E 3	5030 D 4
1809 D 4	3821 E 3	5040 B 4
1809 D 4	3822 E 2	5050 C 4
1810 D 4	3823 E 2	5060 B 3
1811 D 4	3824 E 2	5803 C 3
1812 D 4	3826 E 2	6000 A 4
1813 B 3	3827 E 1	6003 C 4
1814 E 3	3828 D 1	7802 C 4
1815 D 3	3829 D 1	7804 C 1
1816 E 2	3830 C 2	7805 A 1
1817 E 2	3831 C 2	7806 B 1
1818 E 2	3832 C 2	7807 C 4
1819 E 2	3833 C 2	9000 B 4
1820 E 1	3834 C 2	9001 E 4
1821 E 1	3835 C 2	9002 E 2
1822 D 1	3837 C 2	9502 E 1
1823 E 1	3838 C 2	9502 D 1
1824 D 2	3839 C 2	9502 C 4
1825 C 3	3840 C 1	9803 E 3
1826 C 3	3841 C 1	9804 E 3
1827 C 2	3842 C 1	9806 E 1
1828 D 2	3843 D 1	9807 E 1
1829 D 1	3844 D 1	9808 A 4
1830 C 2	3845 A 1	9809 D 1
1831 D 2	3846 B 1	9811 B 3
1832 D 2	3847 B 1	9812 A 2
1833 D 1	3848 D 1	9814 B 1
1834 A 1	3849 B 1	9815 A 1
1835 A 1	3850 B 1	9816 A 1
1836 A 1	3851 B 2	9817 A 1
1837 C 3	3852 C 1	9818 B 2
1838 B 3	3853 C 1	9819 B 2
1839 B 1	3854 A 2	9820 C 1
1840 C 4	3855 A 2	9821 C 1
1841 E 3	3856 E 3	9822 B 3
1842 A 2	3857 D 3	9823 C 2
1843 A 2	3858 C 1	9825 D 3
1844 D 3	3859 C 2	9826 D 3
1845 B 1	3870 C 1	9827 C 1
1846 B 1	3871 C 4	9829 C 2
1849 B 2	3880 A 3	9830 E 3
1850 C 1	3881 B 4	9831 D 4
1851 D 4	3882 A 4	9839 B 2
1852 E 2	3883 B 2	9840 B 2
1853 E 2	3884 C 1	9848 B 2
1854 E 2	3885 E 2	9849 B 2
1855 E 2	3886 C 3	7802 C 3
1856 E 2	3887 D 4	7803 D 2
1857 E 2	3888 E 2	
1858 E 2	3889 A 4	

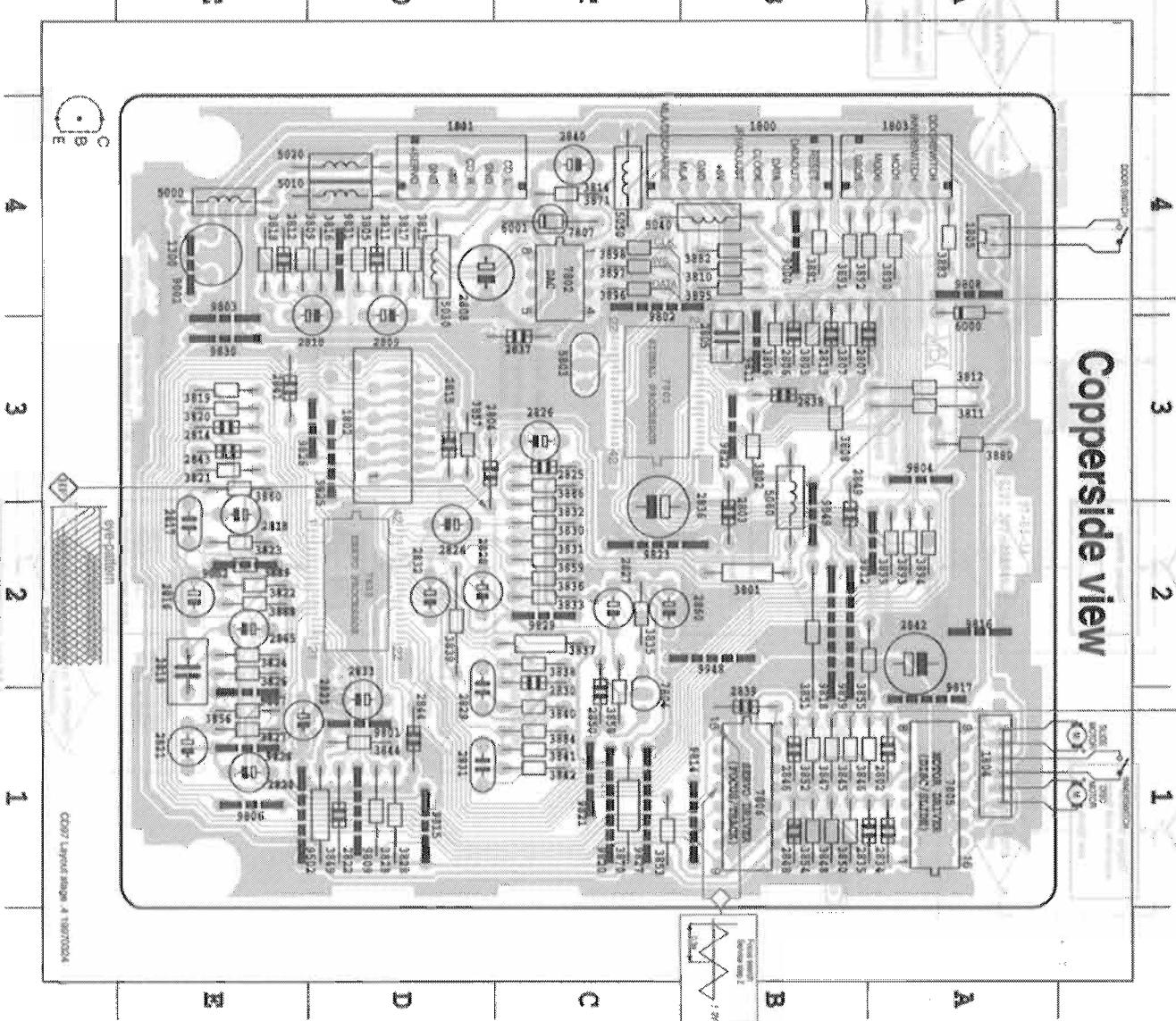

This assembly drawing shows a summary of all possible versions.  
For components used in a specific version  
see schematic diagram respectively partlist.

1300 B 4	3807 B 3	5891 B 4
1800 B 4	3808 B 3	3892 A 4
1801 D 4	3809 B 4	3893 A 2
1802 D 3	3810 B 4	3894 A 2
1803 A 4	3811 A 3	3895 B 4
1804 A 1	3812 A 3	3896 C 4
1805 A 4	3814 C 4	3897 C 4
1805 A 1	3815 D 4	3898 C 4
1806 B 2	3816 D 4	3899 A 2
1806 D 3	3817 D 4	5000 E 4
1807 B 3	3818 E 4	5010 D 4
1808 B 3	3819 E 3	5020 D 4
1809 A 3	3820 E 3	5030 D 4
1809 D 4	3821 E 3	5040 B 4
1809 D 4	3822 E 2	5050 C 4
1810 D 4	3823 E 2	5060 B 3
1811 D 4	3824 E 2	5803 C 3
1812 D 4	3826 E 2	6000 A 4
1813 B 3	3827 E 1	6003 C 4
1814 E 3	3828 D 1	7802 C 4
1815 D 3	3829 D 1	7804 C 1
1816 E 2	3830 C 2	7805 A 1
1817 E 2	3831 C 2	7806 B 1
1818 E 2	3832 C 2	7807 C 4
1819 E 2	3833 C 2	9000 B 4
1820 E 1	3834 C 2	9001 E 4
1821 E 1	3835 C 2	9002 E 2
1822 D 1	3837 C 2	9502 E 1
1823 E 1	3838 C 2	9502 D 1
1824 D 2	3839 C 2	9502 C 4
1825 C 3	3840 C 1	9803 E 3
1826 C 3	3841 C 1	9804 E 3
1827 C 2	3842 C 1	9806 E 1
1828 D 2	3843 D 1	9807 E 1
1829 D 1	3844 D 1	9808 A 4
1830 C 2	3845 A 1	9809 D 1
1831 D 2	3846 B 1	9811 B 3
1832 D 2	3847 B 1	9812 A 2
1833 D 1	3848 D 1	9814 B 1
1834 A 1	3849 B 1	9815 A 1
1835 A 1	3850 B 1	9816 A 1
1836 A 1	3851 B 2	9817 A 1
1837 C 3	3852 C 1	9818 B 2
1838 B 3	3853 C 1	9819 B 2
1839 B 1	3854 A 2	9820 C 1
1840 C 4	3855 A 2	9821 C 1
1841 E 3	3856 E 3	9822 B 3
1842 A 2	3857 D 3	9823 C 2
1843 A 2	3858 C 1	9825 D 3
1844 D 3	3859 C 2	9826 D 3
1845 B 1	3870 C 1	9827 C 1
1846 B 1	3871 C 4	9829 C 2
1849 B 2	3880 A 3	9830 E 3
1850 C 1	3881 B 4	9831 D 4
1851 D 4	3882 A 4	9839 B 2
1852 E 2	3883 B 2	9840 B 2
1853 E 2	3884 C 1	9848 B 2
1854 E 2	3885 E 2	9849 B 2
1855 E 2	3886 C 3	7802 C 3
1856 E 2	3887 D 4	7803 D 2
1857 E 2	3888 E 2	
1858 E 2	3889 A 4	

# CD - SERVICE TESTPROGRAM

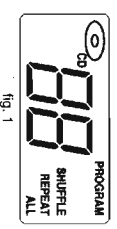
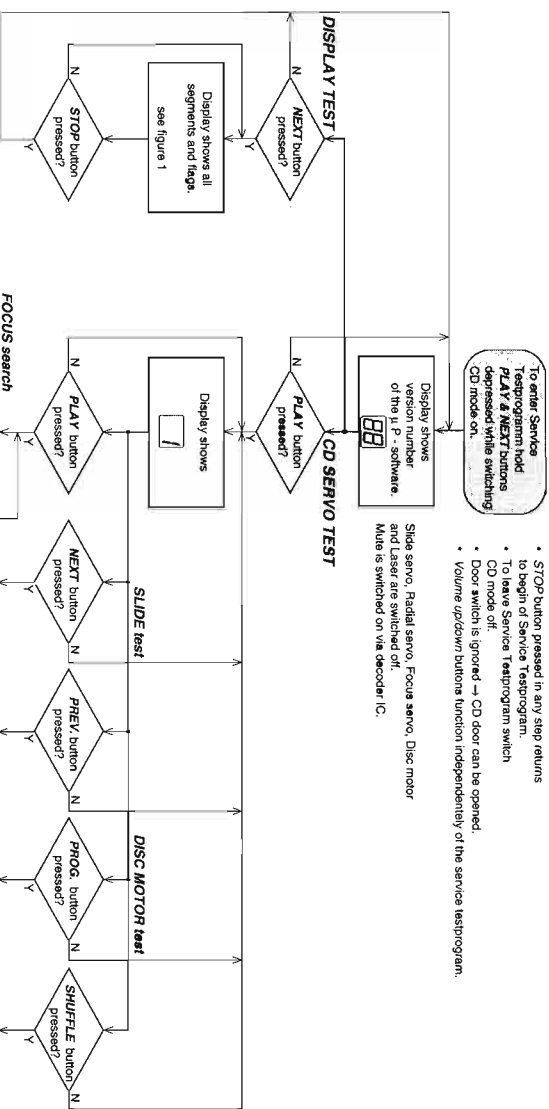
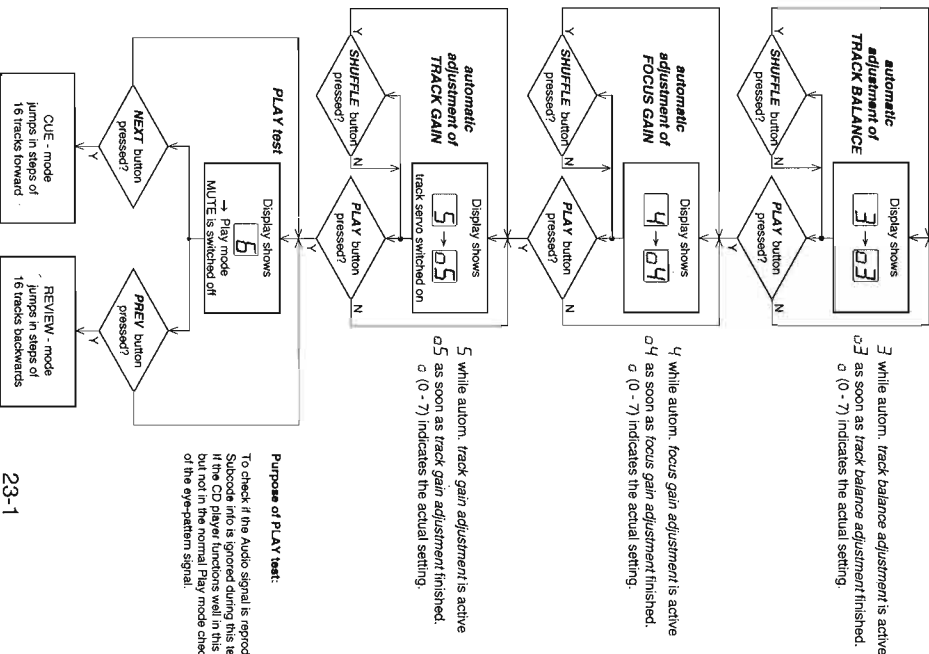

Fig. 1

- STOP button pressed in any step returns to begin of Service Testprogram.
- To leave Service Testprogram switch CD mode off.
- Door switch is ignored → CD door can be opened.
- Volume up/down buttons function independently of the service testprogram.

Slide servo, Radial servo, Focus servo, Disc motor servo, Servo motor for Mute is switched on via decoder IC.



3 while autom. track balance adjustment is active as soon as track balance adjustment finished. 0 (0 - 7) indicates the actual setting.

4 while autom. focus gain adjustment is active 0 (0 - 7) indicates the actual setting.

5 while autom. track gain adjustment is active 0 (0 - 7) indicates the actual setting.

**Purpose of PLAY test:**  
To check if the Audio signal is reproduced. Subcode info is ignored during this test → MUTE is switched off.

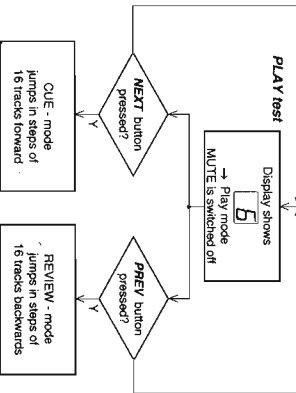

# CD STARTUP - PROCEDURE

Remark: To check focus servo, slide servo, track servo and turntable use service test program

- Battery empty?
- check +5 and +Servo

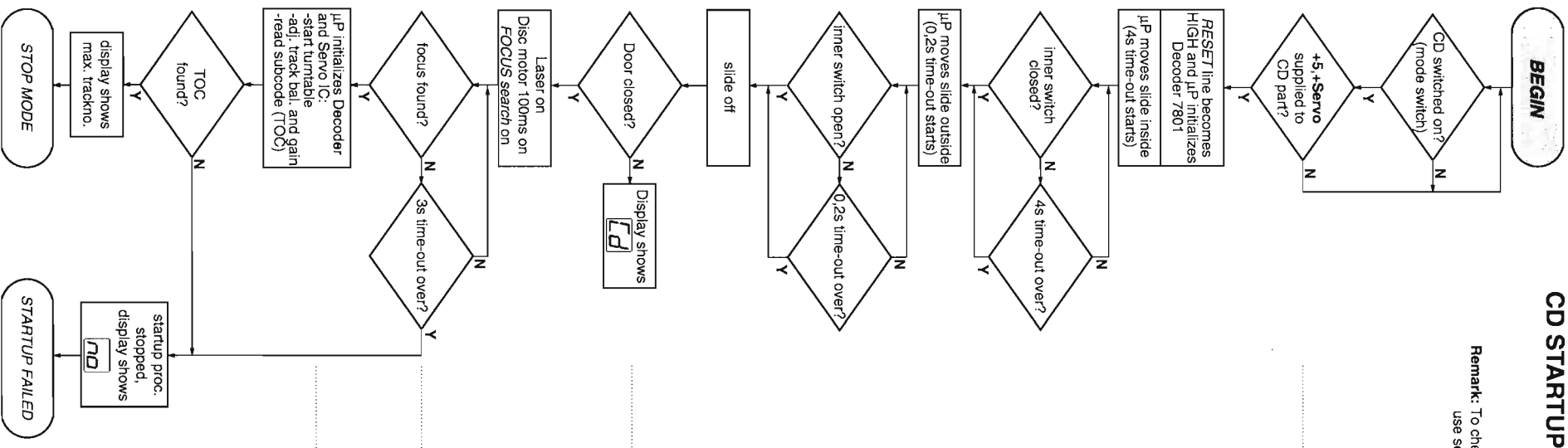

check: - door switch

check: - Laser light on ? - Check pin 38 of 7803 and LASER CONTROL circuit  
- Focus Servo

check: - Motor control pin 37/38 of Decoder 7801 and Disc Motor driver 7805  
- HF Signal  
- Signal on pin7 of Decoder 7801

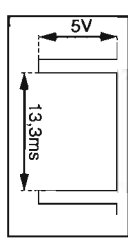

## Abbreviations and Pin-descriptions of CD ICs

### SERVO PROCESSOR M62475FP

Pin	Name	Direction	Description
1-3	A, B, C	Diode array → Servo processor	Current input ( central photo diode signal input )
4-5	E, F	Diode array → Servo processor	Current input ( satellite photo diode signal input )
6	SGT	Servo processor → Track servo	Signal generator output to track servo, sends 1700Hz for adjustment procedure
7	TE -	-	Inverting input of trackerror amplifier
8	TEGain	-	Gain control pin of track error amplifier
9	TG1	-	Track Gain 1 - switch: controls the gain of the track servo amplifier
10	TE out	-	Track Error amplifier output
11	TC/Shock	-	Track Cross/Shock detector input
12	TS +	not connected	Non inverting input of track servo amplifier
13	TG2	-	Track Gain 2 - switch: controls the gain of the track servo amplifier
14	TS -	-	Inverting input of track servo amplifier
15	TS out	Servo processor → Servo driver	Output of track servo amplifier
16	SS +	-	Non inverting input of slide servo amplifier
17	SS -	-	Inverting input of slide servo amplifier
18	Slide out	Servo processor → Motor driver	Output of slide servo amplifier
19	DETFL	-	Output of slide servo amplifier
20	BIAS	Servo processor → external electronic	Pin for connection of DETection Filter capacitor of ADJUST LOGIC
21	GND	-	Reference Voltage output Vcc/2 of internal BIAS-generator
22	MLA/DIS	JP → Servo processor	Ground connection pin ( negative supply )
23	JP1/SG	JP → Servo processor	Serial interface Microprocessor Latch control / DIScharge control for adjustment
24	MCK	JP → Servo processor	Serial interface Clock input line
25	MSD	JP → Servo processor	Serial interface Data input line
26	Dout	Servo processor → JP	Serial interface Data output line
27	CLPF	-	Pin for connection of Low Pass Filter capacitor for ADJUST LOGIC
28	REF	-	Reference current input
29	VCC	-	Positive supply connection pin ( 4V - 5.5V )
30	FSout	Servo processor → Servo driver	Output of focus servo amplifier
31	FS -	-	Inverting input of focus servo amplifier
32	FEgain	-	Gain control pin of focus error amplifier
33	FE -	-	Inverting input of focus error amplifier
34	SGF	Servo processor → Focus servo	Signal generator output to focus servo, sends 1300Hz for adjust. procedure
35	CFSR	-	Charge capacitor for Focus Search triangle-generator
36	APC +	-	Non inverting input of Automatic laser Power Control amplifier
37	APC -	-	Inverting input of Automatic laser Power Control amplifier
38	APC out	Servo processor → Laser driver	Output of Automatic laser Power Control amplifier
39	MRC	-	Connection pin for capacitor of Mirror detector
40	HF	Servo processor → Decoder	Output of HF amplifier
41	HFI	-	Inverting input of HF amplifier
42	ABC	-	Sum output of amplified A, B and C input ( central photo diode signal input ) to external ac-coupling capacitor

### SIGNAL PROCESSOR M65821FP

Pin	Name	Direction	Description
1	VDD1	-	+supply for signal processor
2	EMP	not connected	Emphasis flag output
3	SYCLK	not connected	Frame synchronize output
4	LOCK	not connected	Low disc rotation detect output
5	SCAND	not connected	Subcode sync signal detection
6	CRCF	not connected	Subcode Q CRC check flag output
7	SBOS	Signal processor → JP	Interrupt signal to read out subcode Q data
8	MSD	JP ↔ Signal processor	Data line
9	RESET	Reset circuit → Signal processor	System reset
10	MCK	JP → Signal processor	Clock input
11	MLA	JP → Signal processor	Latch clock input
12-14	MODx	JP → Signal processor	Mode setting inputs (0, 1, 2)
15	VDD2	-	+supply for data slicer and VCO
16	IREF	-	Current reference
17	HFD	Signal processor → JP	HF signal detect
18	LPF	-	HF signal filter
19	HF	Servo processor → Signal processor	PLL loop filter
20	TLC	-	HF signal input
21	VSS2	-	Output from slice level control
22	C846	not connected	Ground
23	C423	Signal processor → JP	8.4672MHz clock output
24	EST2	not connected	4.2336MHz clock output
25	EST1	not connected	Error monitor output2
26	XI	not connected	Error monitor output1
27	XO	X-Tal → Signal processor	Crystal oscillator input
28	DOTX	Signal processor → X-Tal	Output of digital interface
29	DO1	not connected	Serial data output to DAC
30	DO2	Signal processor → DAC	Serial data output to Dual DAC
31	CKSEL	not connected	Crystal selector input. H=8MHz, L=16MHz
32	DSCK	Signal processor → DAC	Data shift clock
33	WDCK	Signal processor → DAC	Word clock
34	LRCK1	Signal processor → DAC	Left/Right clock
35-36	not used	-	Left/Right clock
37	PWM1	Signal processor → Motor driver	Disc motor driving ( Pulse Width Modulation ) output1
38	PWM2	Signal processor → Motor driver	Disc motor driving ( Pulse Width Modulation ) output2
39-41	not used	-	-
42	VSS1	GND	Digital system ground

**EXPLODED VIEW DIAGRAM - TAPE DECK**

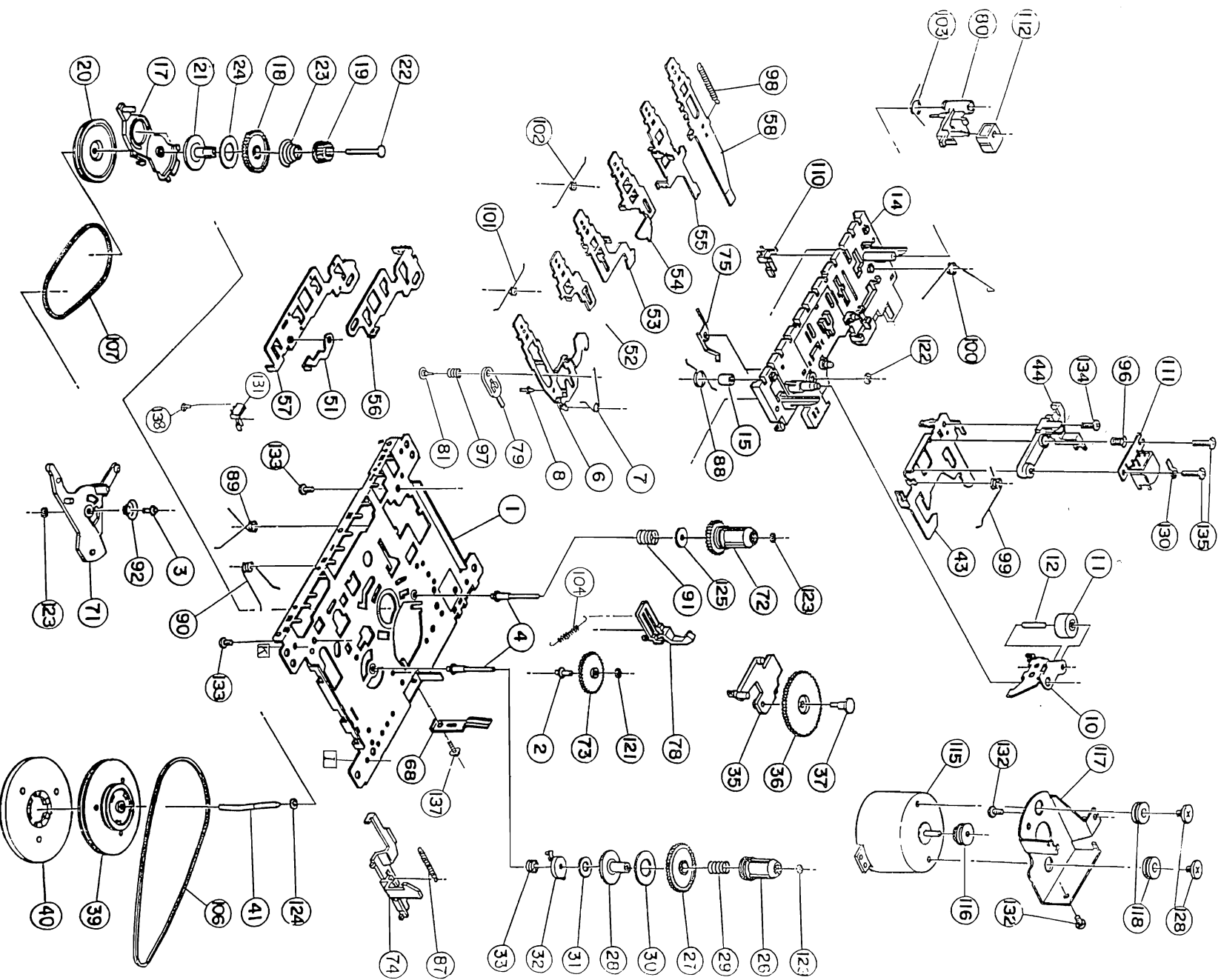

401	4822 459 04986	Front Panel	452	4822 528 10322	Pointer
402	4822 381 10515	Front Panel Lens (AZ1200)	453	4822 529 10386	Damper Rubber (30 DEG)
402	4822 381 11981	Front Panel Lens (AZ1205/17)	454	4822 691 10654	CD Drive
403	4822 450 10517	Window LCD	456	4822 529 10322	Damper Assy
404	4822 450 10516	Cassette Door Lens (AZ1200/00/14)	457	4822 402 10363	Tuning Lens (For -/00)
404	4822 450 10525	Cassette Door Lens (AZ1200/17)	457	4822 402 11982	Tuning Lens (For -/14)
404	4822 450 10521	Cassette Door Lens (AZ1205/17)	457	4822 402 10359	Tuning Lens (For -/17)
406	4822 443 10964	Cassette Door	458	4822 402 11126	Tuning Knob
407	4822 492 42709	Spring Door	459	4822 402 10724	Bracket Handle
408	4822 459 04987	Front Cabinet Assy	461	4822 498 10644	Handle
411	4822 410 11845	Button Set Play	462	4822 492 11642	Spring CD
413	4822 402 11066	LCD Bracket (DI/G)	463	4822 426 10473	Cabinet Rear
414	4822 410 11239	Cassette Knob	464	4822 265 20318	Socket Main (Not for -/17)
416	4822 492 11061	Spring Recording	464	4822 265 20706	Socket Main (For -/17)
417	4822 402 10126	Lever Recording	466	4822 492 51733	Spring Compression
418	4822 410 11844	Button Set Shuffle	467	4822 492 51961	Spring Compression
422	4822 402 10784	Sound Box Bracket	468	4822 290 80313	Contact Plate
428	4822 529 10387	Damper Rubber (40 DEG)	469	4822 443 10655	Battery Door
429	4822 410 11124	Knob DBB	471	4822 303 14038	Telescopic Aerial
432	4822 410 11590	Knob Mode	472	4822 219 10355	RC0786/04 (AZ1205 only)
434	4822 402 10723	Lever Eject	4822 321 10249	Mains Cord (For -/00/14)	
436	4822 492 11058	Spring Eject	4822 321 10882	Mains Cord (For -/17)	
437	4822 418 10349	Tray CD (AZ1200/00) (AZ1205/17)	4822 736 16131	Instr Manual (For -/00)	
437	4822 418 10353	Tray CD (AZ1200/14)	4822 736 16135	Instr Manual (For -/14)	
437	4822 418 10352	Tray CD (AZ1200/17)	4822 736 16132	Instr Manual (For -/14)	
438	4822 410 11132	Knob Volume (AZ1200)			
438	4822 410 11383	Knob Volume (AZ1205)			
439	4822 410 11128	Knob Open			
441	4822 535 60096	Disc			
443	4822 532 12798	Pressure Ring Assy			
444	4822 443 10654	CD Door			
447	4822 464 10294	Frame Tuning			
448	4822 492 40854	Torsion Spring			
449	4822 528 40208	Drum			
451	4822 528 80907	Pulley Pom			

Note : Only those parts mentioned in the list are normal service parts.

**EXPLODED VIEW DIAGRAM - TAPE DECK**

10	4822 528 70849	Pinch Roller Arm (B)	110	4822 278 90721	Leaf Switch
11	4822 528 70695	Pinch Roller Assy	111	4822 249 30218	MS18R-AKONI
74	4822 403 70968	Eject Hook (A)	112	4822 249 40306	E. Head
106	4822 358 31325	Main Belt 45.2 x 1.2	115	4822 361 21656	Motor EG-530AD-9B
107	4822 358 31124	Sub Belt 44.7 x 1.2	116	4822 528 81497	Motor Pulley

Note : Only those parts mentioned in the list are normal service parts.

4822 691 10612 Tape Deck Mechanism

**EXPLODED VIEW DIAGRAM - CABINET**

EXPLODED VIEW DIAGRAM - CABINET

DIAL STRINGING

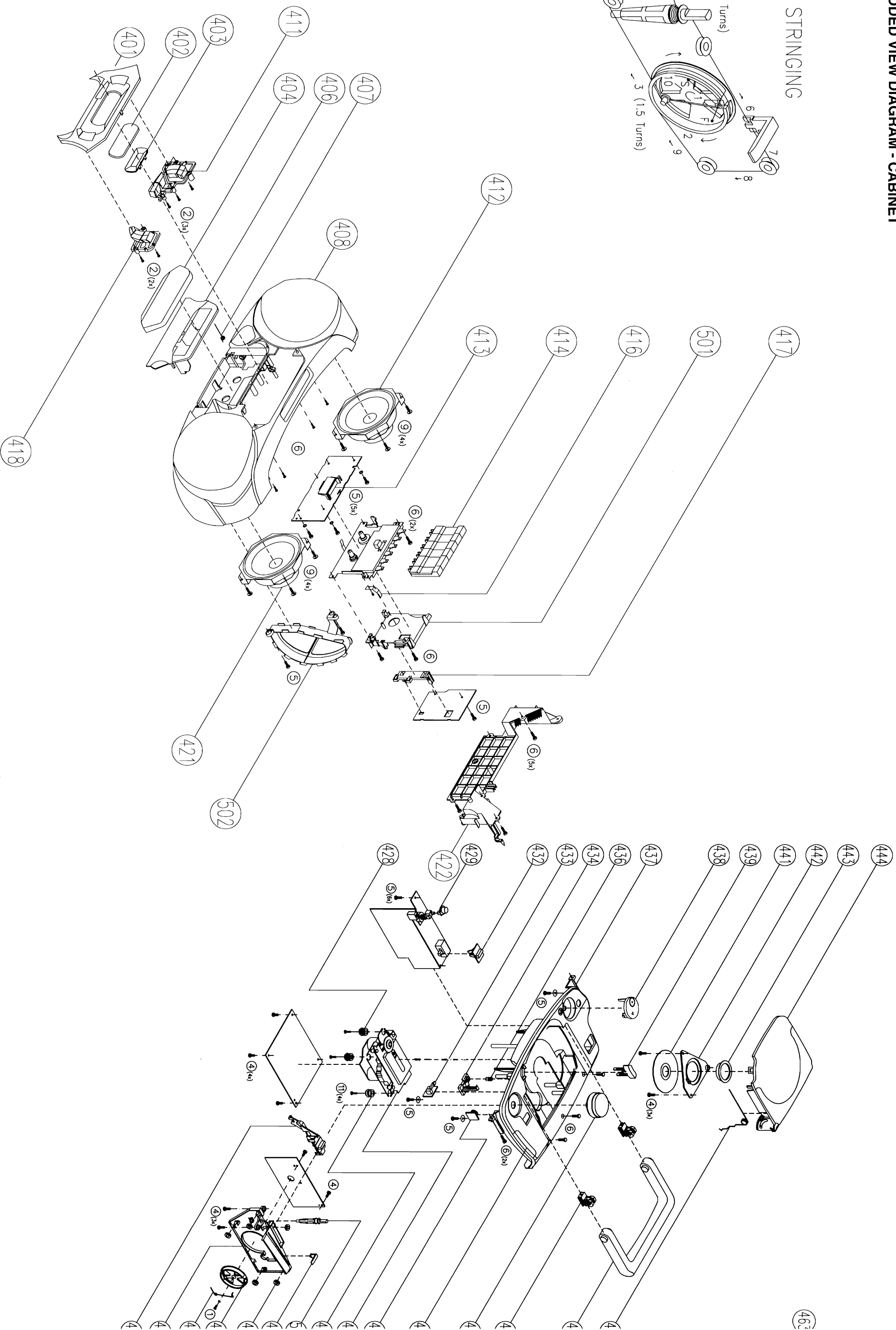
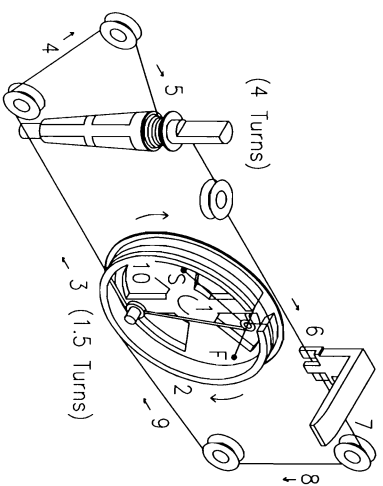

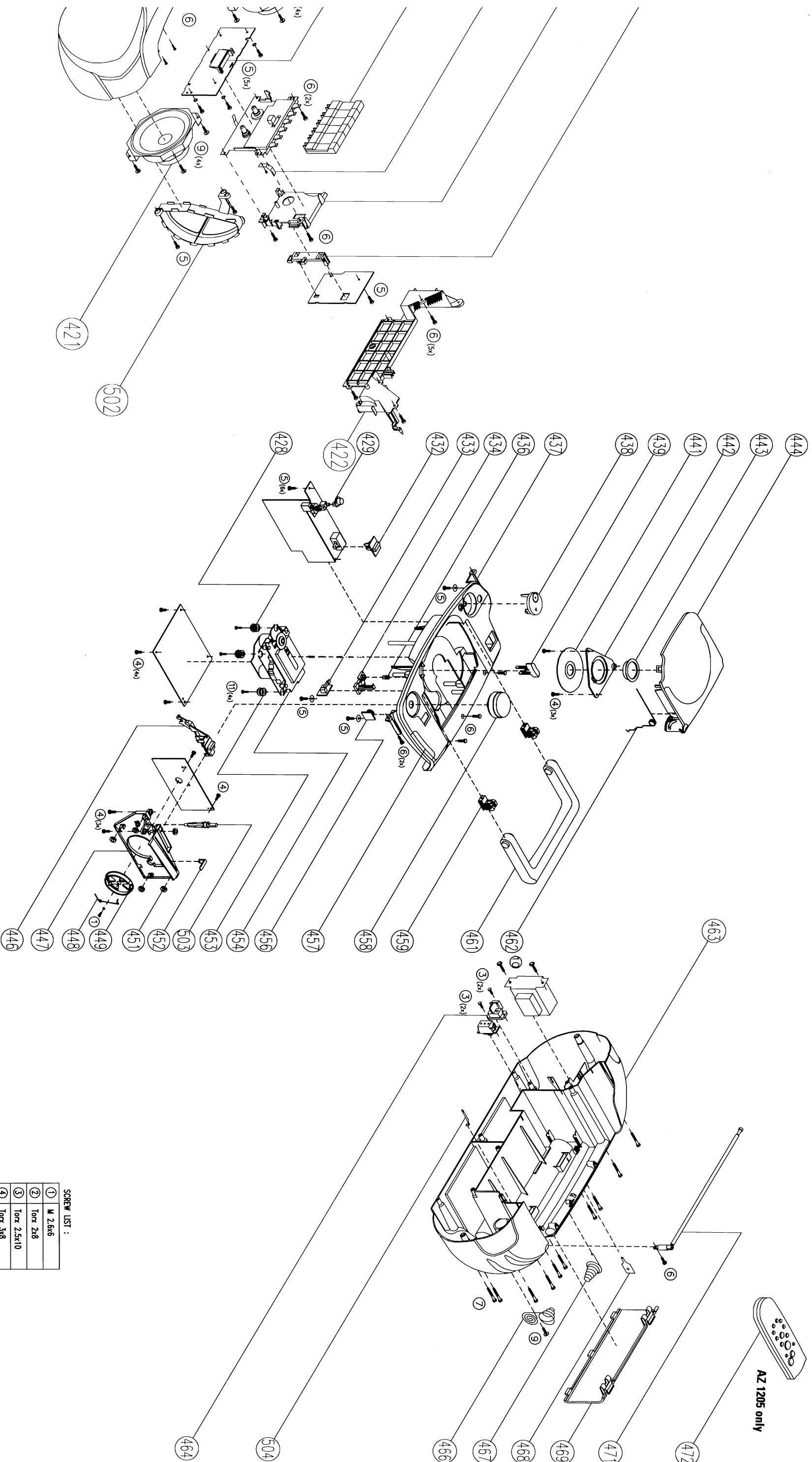

AZ 1205 only



AUDIO BOARD

3254	#	4822 116 83883	470R	5%	0.5W
3255	*	4822 116 83883	470R	5%	0.5W
3256	*	4822 052 10478	4R7	5%	0.33W
3258	*	4822 116 52238	12K	5%	0.5W
3259	*	4822 116 52256	2K2	5%	0.5W
3260	#	4822 116 52238	12K	5%	0.5W
3302	*	4822 116 83872	220R	5%	0.5W
3302	#	4822 116 52206	120R	5%	0.5W
3303	*	4822 116 83872	220R	5%	0.5W
3303	#	4822 116 52206	120R	5%	0.5W
3304	*	4822 116 83883	470R	5%	0.5W
3305	*	4822 116 83883	470R	5%	0.5W
3306	*	4822 116 52289	5K6	5%	0.5W
3307	*	4822 116 52303	8K2	5%	0.5W
3308	*	4822 116 83868	150R	5%	0.5W
3309	*	4822 116 83868	150R	5%	0.5W
3310	*	4822 116 52191	33E	5%	0.5W
3401	*	4822 116 52244	15K	5%	0.5W
3402	*	4822 116 52244	15K	5%	0.5W
3403	*	4822 116 52244	15K	5%	0.5W
3405	*	4822 116 83864	10K	5%	0.5W
3406	*	4822 116 83864	10K	5%	0.5W
3407	*	4822 116 83864	10K	5%	0.5W
3411	*	4822 116 52244	15K	5%	0.5W
3416	*	4822 116 52304	82K	5%	0.5W
3516	*	4822 116 52269	3K3	5%	0.5W
3516	#	4822 116 52256	2K2	5%	0.5W
3517	*	4822 116 52269	3K3	5%	0.5W
3517	#	4822 116 52256	2K2	5%	0.5W
3518	*	4822 116 52235	1M	5%	0.5W
3518	#	4822 116 52234	100K	5%	0.5W
3519	*	4822 116 52235	1M	5%	0.5W
3519	#	4822 116 52234	100K	5%	0.5W
3520	#	4822 116 52257	22K	5%	0.5W
3521	#	4822 116 52257	22K	5%	0.5W
3522	*	4822 102 10447	50K	BX2	
3522	#	4822 116 52238	12K	5%	0.5W
3523	#	4822 116 52238	12K	5%	0.5W
3529	*	4822 116 52238	12K	5%	0.5W
3529	#	4822 116 83864	10K	5%	0.5W
3530	*	4822 116 52238	12K	5%	0.5W
3530	#	4822 116 83864	10K	5%	0.5W
3531	*	4822 116 52303	8K2	5%	0.5W
3532	#	4822 116 52303	8K2	5%	0.5W
3576	*	4822 116 83883	470R	5%	0.5W

3577	*	4822 116 83883	470R	5%	0.5W
3578	*	4822 116 52244	15K	5%	0.5W
3578	#	4822 116 52263	2K7	5%	0.5W
3579	*	4822 116 52244	15K	5%	0.5W
3579	#	4822 116 52263	2K7	5%	0.5W
3580	*	4822 116 83872	220R	5%	0.5W
3580	#	4822 116 52175	100R	5%	0.5W
3582	*	4822 116 52305	820K	5%	0.5W
3582	#	4822 116 52298	680K	5%	0.5W
3583	*	4822 116 52305	820K	5%	0.5W
3583	#	4822 116 52298	680K	5%	0.5W
3584	*	4822 116 52243	1K5	5%	0.5W
3584	#	4822 116 52283	4K7	5%	0.5W
3585	*	4822 116 52243	1K5	5%	0.5W
3585	#	4822 116 52283	4K7	5%	0.5W
3586	*	4822 116 52228	680R	5%	0.5W
3587	*	4822 116 52228	680R	5%	0.5W
3588	*	4822 116 52257	22K	5%	0.5W
3589	*	4822 116 52257	22K	5%	0.5W
3590	*	4822 116 52297	68K	5%	0.5W
3590	#	4822 116 52175	100R	5%	0.5W
3591	*	4822 116 52297	68K	5%	0.5W
3591	#	4822 116 52175	100R	5%	0.5W
3595	*	4822 116 83864	10K	5%	0.5W
3595	#	4822 116 52264	27K	5%	0.5W
3596	*	4822 116 83864	10K	5%	0.5W
3596	#	4822 116 52264	27K	5%	0.5W
3597	*	4822 116 52238	12K	5%	0.5W
3597	#	4822 116 52256	2K2	5%	0.5W
3598	*	4822 116 52238	12K	5%	0.5W
3598	#	4822 116 52256	2K2	5%	0.5W
3599	*	4822 116 52283	4K7	5%	0.5W
3600	#	4822 116 52283	4K7	5%	0.5W
3610	*	4822 116 83864	10K	5%	0.5W
3611	*	4822 116 83864	10K	5%	0.5W
3612	#	4822 116 83883	470R	5%	0.5W
3613	#	4822 116 83883	470R	5%	0.5W
3614	#	4822 116 52297	68K	5%	0.5W
3620	#	4822 116 52175	100R	5%	0.5W
3621	*	4822 116 52175	100R	5%	0.5W
3660	*	4822 116 52244	15K	5%	0.5W
3661	*	4822 116 52244	15K	5%	0.5W
3662	*	4822 116 52244	15K	5%	0.5W
3662	#	4822 116 52269	3K3	5%	0.5W
3663	*	4822 116 52244	15K	5%	0.5W

2250	*	4822 124 80195	470µF	20%	10V
2251	*	4822 124 80195	470µF	20%	10V
2252	*	5322 121 42661	330nF	5%	63V
2253	*	5322 121 42661	330nF	5%	63V
2254	*	4822 124 40433	47µF	20%	25V
2255	*	4822 124 40433	47µF	20%	25V
2256	#	4822 124 42446	100µF	20%	10V
2257	*	4822 124 42446	100µF	20%	10V
2258	*	5322 122 32052	680pF	10%	100V
2259	*	5322 122 32052	680pF	10%	100V
2260	*	4822 124 40242	1µF	20%	63V
2260	#	4822 124 40246	4.7µF	20%	63V
2261	*	4822 124 40242	1µF	20%	63V
2261	#	4822 124 40246	4.7µF	20%	63V
2262	*	4822 124 80144	220µF	20%	25V
2263	*	4822 124 12011	470µF	20%	16V
2263	#	4822 124 11909	470µF	20%	25V
2264	#	4822 126 13581	0.22µF	20%	50V
2265	#	4822 126 13581	0.22µF	20%	50V
2266	#	5322 121 42386	100nF	5%	63V
2267	#	5322 121 42386	100nF	5%	63V
2300	*	4822 122 33197	1nF	10%	50V
2301	*	4822 122 33197	1nF	10%	50V
2302	*	4822 122 33197	1nF	10%	50V
2303	*	4822 122 33197	1nF	10%	50V
2304	*	5322 121 42386	100nF	5%	63V
2305	*	4822 124 12012	4700µF	20%	25V
2306	*	4822 126 11585	22nF +80-20% Y5V	25V	
2307	*	4822 124 12068	220µF	20%	10V
2310	*	4822 124 41576	2.2µF	20%	50V
2312	*	4822 124 42446	100µF	20%	10V
2400	*	4822 126 11714	4.7nF	20%	
2401	*	4822 126 11714	4.7nF	20%	
2402	*	4822 126 11714	4.7nF	20%	
2403	*	4822 124 81151	22µF	50V	
2404	*	4822 124 81151	22µF	50V	
2405	*	4822 124 81151	22µF	50V	
2406	*	4822 124 81151	22µF	50V	
2407	*	4822 126 11714	4.7nF	20%	
2516	*	4822 121 10684	68nF	10%	50V
2517	*	4822 121 10684	68nF	10%	50V
2518	*	4822 126 12878	1.5nF	10%	16V
2519	*	4822 126 12878	1.5nF	10%	16V
2564	*	4822 124 42446	100µF	20%	10V
2565	*	4822 124 40246	4.7µF	20%	63V

2565	#	4822 124 22726	4.7µF	35V	
2566	*	4822 124 40246	4.7µF	20%	63V
2566	#	4822 124 22726	4.7µF	35V	
2567	*	4822 122 33195	100pF	10%	50V
2568	*	4822 122 33195	100pF	10%	50V
2569	*	4822 122 33197	1nF	10%	50V
2570	*	4822 122 33197	1nF	10%	50V
2571	*	4822 124 40242	1µF	20%	63V
2571	#	4822 124 40246	4.7µF	20%	63V
2572	*	4822 124 40242	1µF	20%	63V
2572	#	4822 124 40246	4.7µF	20%	63V
2573	*	4822 121 43897	1nF	5%	400V
2574	*	4822 121 43897	1nF	5%	400V
2577	*	4822 122 33197	1nF	10%	50V
2578	*	4822 122 33197	1nF	10%	50V
2579	*	5322 121 42386	100nF	5%	63V
2579	#	4822 122 33197	1nF	10%	50V
2580	*	5322 121 42386	100nF	5%	63V
2580	#	4822 122 33197	1nF	10%	50V
2581	#	4822 122 33197	1nF	10%	50V
2582	#	4822 122 33197	1nF	10%	50V
2583	#	4822 124 42446	100µF	20%	10V
2584	#	4822 124 42446	100µF	20%	10V
2585	#	4822 124 12068	220µF	20%	10V
2586	#	4822 124 40433	47µF	20%	25V
2587	#	4822 124 40248	10µF	20%	63V
2588	#	4822 124 40433	47µF	20%	25V
2589	#	4822 126 12785	47nF	Y5V	50V
2590	#	4822 126 12785	47nF	Y5V	50V
2591	#	4822 122 33197	1nF	10%	50V
2592	#	4822 122 33197	1nF	10%	50V
2594	#	4822 122 33195	100pF	10%	50V
2595	#	4822 122 33197	1nF	10%	50V
2596	#	4822 121 51387	10nF	20%	16V
3249	#	4822 052 10478	4R7	5%	0.33W
3250	*	4822 052 10478	4R7	5%	0.33W
3251	*	4822 116 83883	470R	5%	0.5W
3252	*	4822 116 52243	1K5	5%	0.5W
3253	*	4822 116 52226	560R	5%	0.5W

3663	#	4822 116 5226			
3664	#	4822 116 8388			
3665	#	4822 116 8388			
3666	#	4822 116 5217			
3667	#	4822 116 5217			
3668	#	4822 116 8388			
3669	#	4822 116 8388			
3670	#	4822 116 8388			
3671	#	4822 116 8388			
3672	#	4822 116 5225			
3673	#	4822 116 5225			
3674	#	4822 116 5222			
3675	#	4822 116 5222			
3676	#	4822 116 8388			
3677	#	4822 116 5224			
3678	#	4822 116 5224			
3679	#	4822 116 5223			
3680	#	4822 116 5227			
3681	#	4822 116 5227			
3684	#	4822 116 5227			
3685	#	4822 116 5227			
3686	#	4822 116 5222			
5503	*	4822 157 5119			
6300	*	4822 130 3187			
6301	*	4822 130 3187			
6302	*	4822 130 3187			
6303	*	4822 130 3187			
6304	*	5322 130 3150			
6305	*	4822 130 3062			
6306	#	4822 130 3062			
6402	*	4822 130 3062			
6402	*	4822 130 3062			

**AUDIO BOARD**

0.5W	2250	4822 124 80195	470µF	20%	10V
0.5W	2251	4822 124 80195	470µF	20%	10V
0.5W	2252	5322 121 42661	330nF	5%	63V
0.5W	2253	5322 121 42661	330nF	5%	63V
0.5W	2254	4822 124 40433	47µF	20%	25V
0.5W	2255	4822 124 40433	47µF	20%	25V
0.5W	2256	4822 124 42446	100µF	20%	10V
0.5W	2257	4822 124 42446	100µF	20%	10V
0.5W	2258	5322 122 32052	680pF	10%	100V
0.5W	2259	5322 122 32052	680pF	10%	100V
0.5W	2260	4822 124 40242	1µF	20%	63V
0.5W	2260	4822 124 40246	4.7µF	20%	63V
0.5W	2261	4822 124 40242	1µF	20%	63V
0.5W	2261	4822 124 40246	4.7µF	20%	63V
0.5W	2262	4822 124 80144	220µF	20%	25V
0.5W	2263	4822 124 12011	470µF	20%	16V
0.5W	2263	4822 124 11909	470µF	20%	25V
0.5W	2264	4822 126 13581	0.22µF	20%	50V
0.5W	2265	4822 126 13581	0.22µF	20%	50V
0.5W	2266	5322 121 42386	100nF	5%	63V
0.5W	2267	5322 121 42386	100nF	5%	63V
0.5W	2300	4822 122 33197	1nF	10%	50V
0.5W	2301	4822 122 33197	1nF	10%	50V
0.5W	2302	4822 122 33197	1nF	10%	50V
0.5W	2303	4822 122 33197	1nF	10%	50V
0.5W	2304	5322 121 42386	100nF	5%	63V
0.5W	2305	4822 124 12012	4700µF	20%	25V
0.5W	2306	4822 126 11585	22nF +80-20% Y5V	25V	
0.5W	2307	4822 124 12068	220µF	20%	10V
0.5W	2310	4822 124 41576	2.2µF	20%	50V
0.5W	2312	4822 124 42446	100µF	20%	10V
0.5W	2400	4822 126 11714	4.7nF	20%	
0.5W	2401	4822 126 11714	4.7nF	20%	
0.5W	2402	4822 126 11714	4.7nF	20%	
0.5W	2403	4822 124 81151	22µF	50V	
0.5W	2404	4822 124 81151	22µF	50V	
0.5W	2405	4822 124 81151	22µF	50V	
0.5W	2406	4822 124 81151	22µF	50V	
0.5W	2407	4822 126 11714	4.7nF	20%	
0.5W	2516	4822 121 10684	68nF	10%	50V
0.5W	2517	4822 121 10684	68nF	10%	50V
0.5W	2518	4822 126 12878	1.5nF	10%	16V
0.5W	2519	4822 126 12878	1.5nF	10%	16V
0.5W	2564	4822 124 42446	100µF	20%	10V
0.5W	2565	4822 124 40246	4.7µF	20%	63V

0.5W	2565	4822 124 22726	4.7µF	35V	
0.5W	2566	4822 124 40246	4.7µF	20%	63V
0.5W	2566	4822 124 22726	4.7µF	35V	
0.5W	2567	4822 122 33195	100pF	10%	50V
0.5W	2568	4822 122 33195	100pF	10%	50V
0.5W	2569	4822 122 33197	1nF	10%	50V
0.5W	2570	4822 122 33197	1nF	10%	50V
0.5W	2571	4822 124 40242	1µF	20%	63V
0.5W	2571	4822 124 40246	4.7µF	20%	63V
0.5W	2572	4822 124 40242	1µF	20%	63V
0.5W	2572	4822 124 40246	4.7µF	20%	63V
0.5W	2573	4822 121 43897	1nF	5%	400V
0.5W	2574	4822 121 43897	1nF	5%	400V
0.5W	2577	4822 122 33197	1nF	10%	50V
0.5W	2578	4822 122 33197	1nF	10%	50V
0.5W	2579	5322 121 42386	100nF	5%	63V
0.5W	2579	4822 122 33197	1nF	10%	50V
0.5W	2580	5322 121 42386	100nF	5%	63V
0.5W	2580	4822 122 33197	1nF	10%	50V
0.5W	2581	4822 122 33197	1nF	10%	50V
0.5W	2582	4822 122 33197	1nF	10%	50V
0.5W	2583	4822 124 42446	100µF	20%	10V
0.5W	2584	4822 124 42446	100µF	20%	10V
0.5W	2585	4822 124 12068	220µF	20%	10V
0.5W	2586	4822 124 40433	47µF	20%	25V
0.5W	2587	4822 124 40248	10µF	20%	63V
0.5W	2588	4822 124 40433	47µF	20%	25V
0.5W	2589	4822 126 12785	47nF	Y5V	50V
0.5W	2590	4822 126 12785	47nF	Y5V	50V
0.5W	2591	4822 122 33197	1nF	10%	50V
0.5W	2592	4822 122 33197	1nF	10%	50V
0.5W	2594	4822 122 33195	100pF	10%	50V
0.5W	2595	4822 122 33197	1nF	10%	50V
0.5W	2596	4822 121 51387	10nF	20%	16V
0.5W	3249	4822 052 10478	4R7	5%	0.33W
0.5W	3250	4822 052 10478	4R7	5%	0.33W
0.5W	3251	4822 116 83883	470R	5%	0.5W
0.5W	3252	4822 116 52243	1K5	5%	0.5W
0.5W	3253	4822 116 52226	560R	5%	0.5W

**AUDIO BOARD**

0.5W	3663	4822 116 52269	3K3	5%	0.5W
0.5W	3664	4822 116 83883	470R	5%	0.5W
0.5W	3665	4822 116 83883	470R	5%	0.5W
0.5W	3666	4822 116 52175	100R	5%	0.5W
0.5W	3667	4822 116 52175	100R	5%	0.5W
0.5W	3668	4822 116 83883	470R	5%	0.5W
0.5W	3669	4822 116 83883	470R	5%	0.5W
0.5W	3670	4822 116 83883	470R	5%	0.5W
0.5W	3671	4822 116 83883	470R	5%	0.5W
0.5W	3672	4822 116 52256	2K2	5%	0.5W
0.5W	3673	4822 116 52256	2K2	5%	0.5W
0.5W	3674	4822 116 52226	560R	5%	0.5W
0.5W	3675	4822 116 52226	560R	5%	0.5W
0.5W	3676	4822 116 83884	47K	5%	0.5W
0.5W	3677	4822 116 52249	1K8	5%	0.5W
0.5W	3678	4822 116 52245	150K	5%	0.5W
0.5W	3679	4822 116 52234	100K	5%	0.5W
0.5W	3680	4822 116 52276	3K9	5%	0.5W
0.5W	3681	4822 116 52276	3K9	5%	0.5W
0.5W	3684	4822 116 52271	33K	5%	0.5W
0.5W	3685	4822 116 52271	33K	5%	0.5W
0.5W	3686	4822 116 52228	680R	5%	0.5W
0.5W	5503	4822 157 51195	Coil 1µH	20%	
0.5W	6300	4822 130 31878	Diode 1N4003G		
0.5W	6301	4822 130 31878	Diode 1N4003G		
0.5W	6302	4822 130 31878	Diode 1N4003G		
0.5W	6303	4822 130 31878	Diode 1N4003G		
0.5W	6304	5322 130 31504	Diode BZX79-B3V3		
0.5W	6305	4822 130 30621	Diode 1N4148		
0.5W	6306	4822 130 30621	Diode 1N4148		
0.5W	6402	4822 130 30621	Diode 1N4148		
0.5W	6402	4822 130 30621	Diode 1N4148		
0.5W	6403	4822 130 30621	Diode 1N4148		
0.5W	6404	4822 130 30621	Diode 1N4148		
0.5W	6405	4822 130 30621	Diode 1N4148		

0.5W	7250	4822 130 42231	Trans BC557C
0.5W	7251	4822 130 41327	Trans BC927-40
0.5W	7252	4822 130 44503	Trans BC557C
0.5W	7253	4822 130 42231	Trans BC557C
0.5W	7254	4822 130 41327	Trans BC927-40
0.5W	7300	4822 209 31544	IC TA8227P
0.5W	7400	5322 130 44779	Trans BC927-40
0.5W	7401	5322 130 44779	Trans BC927-40
0.5W	7415	4822 130 44503	Trans BC547C
0.5W	7513	4822 130 44503	Trans BC547C
0.5W	7514	4822 130 44503	Trans BC557C
0.5W	7515	4822 130 44568	Trans BC557B
0.5W	7516	4822 130 44568	Trans BC557B
0.5W	7517	4822 130 44568	Trans BC557B
0.5W	7518	4822 130 44568	Trans BC557B
0.5W	7519	4822 130 44503	Trans BC557C
0.5W	7520	4822 130 44503	Trans BC557C
<b>- MISCELLANEOUS -</b>			
0.5W	1006	4822 146 10822	Loudspeaker 6W
0.5W	1007	4822 146 10822	Loudspeaker 6W
0.5W	1008	4822 146 10825	Transf (For -/00/14)
0.5W	1008	4822 146 10822	Transf (For -/17)
0.5W	1257	4822 267 31468	Headphone Socket
0.5W	1257	4822 267 31468	Headphone Socket
0.5W	1257	4822 267 31468	Headphone Socket
0.5W	1302	4822 070 32002	Fuse 2A (Not for -/00/14)
0.5W	1302	5322 253 30116	Fuse 2A (For -/17)
0.5W	1400	4822 277 30689	Slide Switch
0.5W	1400	4822 277 30689	Slide Switch
0.5W	1503	4822 276 12648	Push Switch
0.5W	1503	4822 276 12648	Push Switch
0.5W	1506	4822 276 13114	Tact Switch
0.5W	1507	4822 276 13114	Tact Switch
0.5W	1800	4822 276 13625	Push Switch
0.5W	1920	4822 276 13625	Push Switch

Note : Only those parts mentioned in the list are normal service parts.

\* For AZ1200 only  
# For AZ1205/17 only

# FRONT BOARD



2401		4822 124 42446	100μF	20%	10V
2402		4822 124 40242	1μF	20%	63V
2441	#	4822 122 33519	470pF	10%	50V
2443	#	4822 124 22726	4.7μF		35V
2444	#	4822 121 51387	10nF	20%	16V
2445	#	4822 122 33519	470pF	10%	50V
2446	#	4822 122 33519	470pF	10%	50V
2464		4822 122 10466	220pF	10%	50V
2465		4822 122 10466	220pF	10%	50V
2466		4822 122 33197	1nF	10%	50V
2478	#	4822 122 10466	220pF	10%	50V
2491	#	4822 126 12882	100nF	+80-20%	50V
2499	#	4822 121 51387	10nF	20%	16V



3401		4822 116 52175	100R	5%	0.5W
3402		4822 116 52234	100K	5%	0.5W
3403		4822 116 52244	15K	5%	0.05W
3404		4822 116 83883	470R	5%	0.5W
3405		4822 116 52238	12K	5%	0.5W
3406		4822 116 52276	3K9	5%	0.5W
3407		4822 116 52243	1K5	5%	0.5W
3408		4822 116 52226	560R	5%	0.5W
3410		4822 116 83961	6K8	5%	
3411		4822 116 52238	12K	5%	0.5W
3412		4822 116 52257	22K	5%	0.5W
3414		4822 116 83961	6K8	5%	
3415		4822 116 52238	12K	5%	0.5W
3416		4822 116 52257	22K	5%	0.5W
3441	#	4822 116 52257	22K	5%	0.5W
3442	#	4822 116 83864	10K	5%	0.5W
3443	#	4822 116 83872	220R	5%	0.5W
3444	#	4822 116 83872	220R	5%	0.5W
3445	#	4822 116 52234	100K	5%	0.5W
3446	#	4822 116 52234	100K	5%	0.5W
3451		4822 116 52283	4K7	5%	0.5W
3452		4822 116 52283	4K7	5%	0.5W
3453		4822 116 52283	4K7	5%	0.5W
3454		4822 116 52283	4K7	5%	0.5W
3455		4822 116 52283	4K7	5%	0.5W



3456		4822 116 52283	4K7	5%	0.5W
3457		4822 116 52283	4K7	5%	0.5W
3458		4822 116 52283	4K7	5%	0.5W
3459		4822 116 52283	4K7	5%	0.5W
3460		4822 116 52283	4K7	5%	0.5W
3461		4822 116 52269	3K3	5%	0.5W
3462		4822 116 52243	1K5	5%	0.5W
3463		4822 116 52283	4K7	5%	0.5W
3464		4822 116 52283	4K7	5%	0.5W
3465		4822 116 52283	4K7	5%	0.5W
3466		4822 116 52243	1K5	5%	0.5W
3467		4822 116 52243	1K5	5%	0.5W
3468		4822 116 52283	4K7	5%	0.5W
3469		4822 116 52231	820R	5%	0.5W
3470		4822 116 52231	820R	5%	0.5W
3471		4822 116 52283	4K7	5%	0.5W
3472		4822 116 52231	820R	5%	0.5W
3473		4822 116 52269	3K3	5%	0.5W
3474		4822 116 52283	4K7	5%	0.5W
3475		4822 116 52283	4K7	5%	0.5W
3476	#	4822 116 52283	4K7	5%	0.5W
3477	#	4822 116 52283	4K7	5%	0.5W
3478	#	4822 116 52269	4K7	5%	0.5W
3479		4822 116 52283	4K7	5%	0.5W
3480		4822 116 52257	22K	5%	0.5W
3481		4822 116 52257	22K	5%	0.5W
3482		4822 116 52257	22K	5%	0.5W
3483		4822 116 52257	22K	5%	0.5W
3484		4822 116 52264	27K	5%	0.5W
3485		4822 116 52264	27K	5%	0.5W
3491	#	4822 116 52175	100R	5%	0.5W
3492	#	4822 116 52257	22K	5%	0.5W
3493	#	4822 116 52257	22K	5%	0.5W

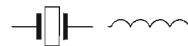

5401		4822 242 73769	Filter	CST4,19MGW
5402		4822 157 11477	Inductor	LAL02TB2R2J
5403		4822 157 52333	Inductor	100μH

## FRONT BOARD



6402	4822 130 30621	Diode 1N4148
6403	4822 130 30621	Diode 1N4148
6404	4822 130 31554	Diode BZX79-B4V3

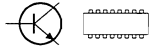

7401	4822 209 15568	IC TMP47C422F
7402	4822 130 44503	Trans BC547C
7403	4822 130 40959	Trans BC547B
7491 #	4822 209 13156	IC ST24C01M6
7813 #	5322 209 11147	IC HEF4093BT

### - MISCELLANEOUS -

1401	4822 135 00212	LCD DISPLAY
1410	4822 276 13114	Tact Switch
1411	4822 276 13114	Tact Switch
1412	4822 276 13114	Tact Switch
1413	4822 276 13114	Tact Switch
1415	4822 276 13114	Tact Switch
1416	4822 276 13114	Tact Switch
1417	4822 276 13114	Tact Switch

\* For AZ1200 only

# For AZ1205/17 only

Note : Only those parts mentioned in the list are normal service parts.



2802	4822 126 12785	47nF +80-20% 50V
2803	4822 126 11585	47nF +80-20% 50V
2804	4822 126 12878	1,5nF 10% 16V
2805	4822 121 51412	560nF 10% 50V
2806	4822 122 33519	470pF 10% 50V
2807	4822 122 33191	18pF 5% 50V
2808	4822 124 22263	220µF 20% 25V
2809	4822 124 40242	1µF 20% 50V
2810	4822 124 40242	1µF 20% 50V
2811	4822 122 33849	150pF 10% 50V
2812	4822 122 33849	150pF 10% 50V
2813	4822 126 12339	2,2nF 10% 16V
2814	4822 126 13677	39pF 5% 50V
2815	4822 126 12882	100nF 8.2% 50V
2816	4822 124 41407	0,47µF 20% 50V
2817	4822 121 42687	3,3nF 10% 50V
2818	4822 124 40242	1µF 20% 50V
2819	5322 121 42386	100nF 10% 50V
2820	4822 124 40746	0,22µF 20% 50V
2821	4822 124 41579	10µF 20% 50V
2822	4822 122 10167	22nF 30% 50V
2823	4822 124 40246	4,7µF 20% 50V
2824	4822 124 41407	0,47µF 20% 50V
2825	4822 122 10462	15pF 5% NPO
2826	4822 124 41407	0,47µF 20% 50V
2827	4822 124 40433	47µF 20% 25V
2828	4822 124 41579	10µF 20% 50V
2829	5322 121 42489	33nF 10% 50V
2830	4822 122 10319	82pF 10% 50V
2831	4822 121 41856	22nF 10% 50V
2832	4822 124 41576	2,2µF 20% 50V
2833	4822 124 40433	47µF 20% 25V
2834	4822 126 12882	100nF +80-20% 50V
2835	4822 126 12882	100nF +80-20% 50V
2836	4822 124 80791	470µF 20% 16V
2837	4822 126 11585	22nF +80-20% 25V
2838	4822 126 12882	100nF +80-20% 50V
2839	4822 126 12882	100nF +80-20% 50V
2841	4822 122 33195	100pF 10% 50V
2842	4822 124 40849	330µF 20% 16V



2843	4822 126 13098	5,6nF 20% 16V
2844	4822 122 10466	220pF 10% 50V
2846	4822 122 33519	470pF 10% 50V
2848	4822 122 33519	470pF 10% 50V
2849	4822 122 10466	220pF 10% 50V
2860	4822 124 40433	47µF 20% 25V

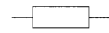

3801	4822 052 10478	4R7 5% 0,33W
3802	4822 116 52252	180K 5% 0,16W
3803	4822 111 50499	3M3 5%
3805	4822 116 83884	47K 5% 0,16W
3806	4822 116 52256	2K2 5% 0,16W
3807	4822 116 52271	33K 5% 0,16W
3808	4822 116 52263	2K7 5% 0,16W
3809	4822 116 83884	47K 5% 0,16W
3810	4822 116 52257	22K 5% 0,16W
3811	4822 116 52257	22K 5% 0,16W
3812	4822 116 52257	22K 5% 0,16W
3815	4822 050 11002	1K 5% 0,16W
3816	4822 050 11002	1K 5% 0,16W
3817	4822 116 83883	470R 5% 0,16W
3818	4822 116 83883	470R 5% 0,16W
3819	4822 117 11825	1M5 5%
3820	4822 116 52252	180K 5% 0,16W
3821	4822 116 52243	1K5 5% 0,16W
3822	4822 116 52264	27K 5% 0,16W
3823	4822 116 52234	100K 5% 0,16W
3824	4822 116 83868	150R 5% 0,16W
3826	4822 116 83961	6K8 5% 0,16W
3827	4822 116 52243	1K5 5% 0,16W
3828	4822 116 83864	10K 5% 0,16W
3829	4822 116 52271	33K 5% 0,16W
3830	4822 116 52244	15K 5% 0,16W
3831	4822 116 52251	18K 5% 0,16W
3832	4822 116 52222	390R 5% 0,16W
3833	4822 116 52264	27K 5% 0,16W
3835	4822 116 52184	18R 5% 0,16W

3836
3837
3838
3839
3840
3841
3842
3844
3845
3846
3847
3848
3849
3850
3851
3852
3853
3854
3855
3856
3857
3858
3859
3860
3870
3871
3880
3881
3882
3883
3884
3886
3890
3891
3892
3893
3894
3895
3896
3897

CD 97



3836	4822 050 11002	1K 5% 0,16W
3837	4822 111 30893	4M7 5%
3838	4822 11652234	100K 5% 0,16W
3839	4822 116 52235	1M 5% 0,16W
3840	4822 050 11002	1K 5% 0,16W
3841	4822 116 52298	680K 5% 0,16W
3842	4822 116 52297	68K 5% 0,16W
3844	4822 116 52291	56K 5% 0,16W
3845	4822 116 52298	680K 5% 0,16W
3846	4822 050 11002	1K 5% 0,16W
3847	4822 116 52298	680K 5% 0,16W
3848	4822 116 52251	18K 5% 0,16W
3849	4822 052 10478	4R7 5%
3850	4822 116 52251	18K 5% 0,16W
3851	4822 116 52244	15K 5% 0,16W
3852	4822 116 83883	470R 5% 0,16W
3853	4822 116 52251	18K 5% 0,16W
3854	4822 116 52243	1K5 5% 0,16W
3855	4822 116 83882	29K 5% 0,16W
3856	4822 116 52303	8K2 5% 0,16W
3857	4822 116 52269	3K3 5% 0,16W
3858	4822 116 80176	1R 5% 0,16W
3859	4822 116 83864	10K 5% 0,16W
3860	4822 116 52207	1K2 5% 0,16W
3870	4822 052 10478	4R7 5%
3871	4822 116 52283	4K7 5% 0,5W
3880	4822 050 11002	1K 5% 0,16W
3881	4822 050 11002	1K 5% 0,16W
3882	4822 050 11002	1K 5% 0,16W
3883	4822 050 11002	1K 5% 0,16W
3884	4822 116 83882	39K 5% 0,16W
3886	4822 116 52235	1M 5% 0,16W
3890	4822 050 11002	1K 5% 0,16W
3891	4822 050 11002	1K 5% 0,16W
3892	4822 050 11002	1K 5% 0,16W
3893	4822 050 11002	1K 5% 0,16W
3894	4822 050 11002	1K 5% 0,16W
3895	4822 050 11002	1K 5% 0,16W
3896	4822 116 52256	2K2 5% 0,16W
3897	4822 116 52256	2K2 5% 0,16W

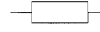

3898	4822 116 52256	2K2 5% 0,16W
3899	4822 050 11002	1K 5% 0,16W

---

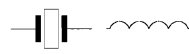

5000	4822 526 10494	Ind Fxd 100MHz
5010	4822 526 10494	Ind Fxd 100MHz
5020	4822 526 10494	Ind Fxd 100MHz
5030	4822 526 10494	Ind Fxd 100MHz
5040	4822 526 10494	Ind Fxd 100MHz
5050	4822 526 10494	Ind Fxd 100MHz
5060	4822 157 50964	Coil 100µH 15%
5803	4822 242 73557	Filter 8MHz467

---



6001	4822 130 30621	Diode 1N4148
------	----------------	--------------

---

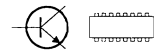

7801	4822 209 13703	IC M65821FP
7802	4822 209 32421	IC TDA1311A
7803	4822 209 90496	IC M62475FP
7804	5322 130 60068	Trans BC558C
7805	4822 209 32852	IC TDA7073A
7806	4822 209 32852	IC TDA7073A

---



**- MISCELLANEOUS -**

1802	4822 265 10925	Connector
8000	4822 265 10926	Connector

Note : Only those parts mentioned in the list are normal service parts.

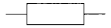
### ATM 3

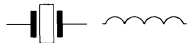

		
2101	4822 122 33195	100pF 10% 50V
2102	4822 126 12812	47pF 5% 50V
2103	4822 124 40248	10µF 20% 63V
2104	4822 124 40248	10µF 20% 63V
2105	4822 126 12112	22pF 5% N220 50V
2106	4822 125 50681	Var Capacitor
2108	4822 122 32147	22pF 2% N470 100V
2109	4822 122 31821	3,3pF 0,25% 100V
2110	4822 126 12284	5,6pF 0,5% N1500 50V
2110	4822 126 12229	8,2pF N750 50V
2112	4822 124 41397	47µF 20% 25V
2113	4822 126 13581	0,22µF 20% 50V
2114	4822 126 12787	330pF 10% Y5V 50V
2115	4822 124 40246	4,7µF 20% 63V
2116	4822 126 12077	15nF 10% 25V
2116	4822 126 12147	22nF 10% Y5R 25V
2117	4822 124 40242	1µF 20% 63V
2118	4822 124 40242	1µF 20% 63V
2119	4822 126 12077	15nF 10% 25V
2119	4822 126 12147	22nF 10% Y5R 25V
2120	4822 124 40242	1µF 20% 63V
2121	4822 124 40239	0,47µF 20% 63V
2122	4822 124 40239	0,47µF 20% 63V
2125	β 4822 126 12826	120pF 50% N750 50V
2126	β 4822 125 50045	1p8-22p 250V
2150	β 4822 125 50045	1p8-22p 250V
		
3101	4822 100 20167	50K 30% 0,1W
3102	4822 116 52297	68K 5% 0,5W
3104	4822 116 52256	2K2 5% 0,5W
3108	4822 116 52191	33R 5% 0,5W
3108	4822 116 52195	47R 5% 0,5W
3109	4822 116 52234	100K 5% 0,5W
3110	4822 116 52234	100K 5% 0,5W
3111	α 4822 116 83863	1K 5% 0,5W
3113	4822 116 52252	180K 5% 0,5W



		
5101	4822 157 70513	FM-RF Coil
5101	4822 157 53789	FM-RF Coil
5104	4822 156 30947	FM-Osc Coil
5105	4822 157 71145	Coil 270µH
5106	4822 157 70499	AM-IF Filter 468KHz
5107	4822 242 81154	Filter KMFC5058-Z
5108	4822 156 11146	AM-IF Filter 468KHz
5109	β 4822 157 71144	Coil 280µH
5111	4822 156 21738	Coil F7BRS-12645X
5112	β 4822 156 21739	Coil F126ANS-8402Y
		
6101	4822 130 30621	Diode 1N4148
6102	4822 130 30621	Diode 1N4148
		
7101	4822 209 32746	IC TEA5711T/N2
- MISCELLANEOUS -		
1100	β 4822 277 30933	Switch FM/LW/MW
1101	α 4822 277 21698	Switch FM/AM

α for FM/MW only  
β for FM/MW/LW only

Note : Only those parts mentioned in the list are normal service parts.

# TAPE DECK BOARD

		
2630	4822 126 13678	470µF 10V
2631	4822 124 41596	22µF 20% 50V
2632	4822 124 40242	1µF 20% 63V
2633	4822 124 40242	1µF 20% 63V
2634	4822 126 12878	1,5nF 10% 16V
2635	4822 126 12878	1,5nF 10% 16V
2636	5322 122 32311	470pF 10% 100V
2637	5322 122 32311	470pF 10% 100V
2638	4822 124 11958	47µF 20% 25V
2639	4822 124 11958	47µF 20% 25V
2640	4822 126 12787	330pF 10% Y5V 50V
2641	4822 126 12787	330pF 10% Y5V 50V
2642	4822 121 51304	10nF 10% 50V
2643	4822 121 51304	10nF 10% 50V
2644	4822 126 12339	2,2nF 10% Y5R
2645	4822 126 12339	2,2nF 10% Y5R
2646	5322 121 42386	100nF 5% 63V
2647	5322 121 42386	100nF 5% 63V
2648	4822 126 11167	22nF 20% 50V
2649	4822 126 11167	22nF 20% 50V
2650	4822 124 11958	47µF 20% 25V
2651	4822 124 11958	47µF 20% 25V
2652	4822 122 33197	1nF 10% 50V
2653	4822 122 33197	1nF 10% 50V
2654	4822 124 41596	22µF 20% 50V
2655	4822 122 33197	1nF 10% 50V
2656	4822 124 40242	1µF 20% 63V
2657	4822 121 51304	10nF 10% 50V
2658	4822 126 11714	4,7nF 20%
2659	4822 126 12147	22nF 10% Y5R 25V
		
3630	4822 116 83872	220R 5% 0,5W
3632	4822 116 83883	470R 5% 0,5W
3633	4822 116 83883	470R 5% 0,5W
3634	4822 116 83883	470R 5% 0,5W
3635	4822 116 83883	470R 5% 0,5W

		
3636	4822 116 52197	56R 5% 0,5W
3637	4822 116 52197	56R 5% 0,5W
3638	4822 116 52271	33K 5% 0,5W
3639	4822 116 52271	33K 5% 0,5W
3640	4822 116 83961	6K8 5%
3641	4822 116 83961	6K8 5%
3642	4822 116 52252	180K 5% 0,5W
3643	4822 116 52252	180K 5% 0,5W
3644	4822 116 83864	10K 5% 0,5W
3645	4822 116 83864	10K 5% 0,5W
3646	4822 116 52244	15K 5% 0,5W
3647	4822 116 52244	15K 5% 0,5W
3648	4822 116 52238	12K 5% 0,5W
3649	4822 116 52238	12K 5% 0,5W
3650	4822 111 30893	4M7 5% 0,2W
3651	4822 116 52245	150K 5% 0,5W
3652	4822 116 52219	330R 5% 0,5W
3653	4822 116 52219	330R 5% 0,5W
3654	4822 116 52289	5K6 5% 0,5W
3655	4822 116 52289	5K6 5% 0,5W
3656	4822 116 83864	10K 5% 0,5W
3657	4822 116 52206	120R 5% 0,5W
3658	4822 116 52176	10R 5% 0,5W
3659	4822 116 52291	56K 5% 0,5W
		
5630	4822 156 20946	Osc Coil 100 KHz
		
7630	4822 130 40959	Trans BC547B
7700	4822 209 32918	IC AN7318S
- MISCELLANEOUS -		
1640	4822 277 11504	Push Switch

Note: Only those parts mentioned in the list are normal service parts.