

SERVICEBLAD ÖVER CHASSI

EL 56 A

Chassit ingår i följande apparater:

PHILIPS DUX CONSERTON

EL 3556 A SA 9131 A

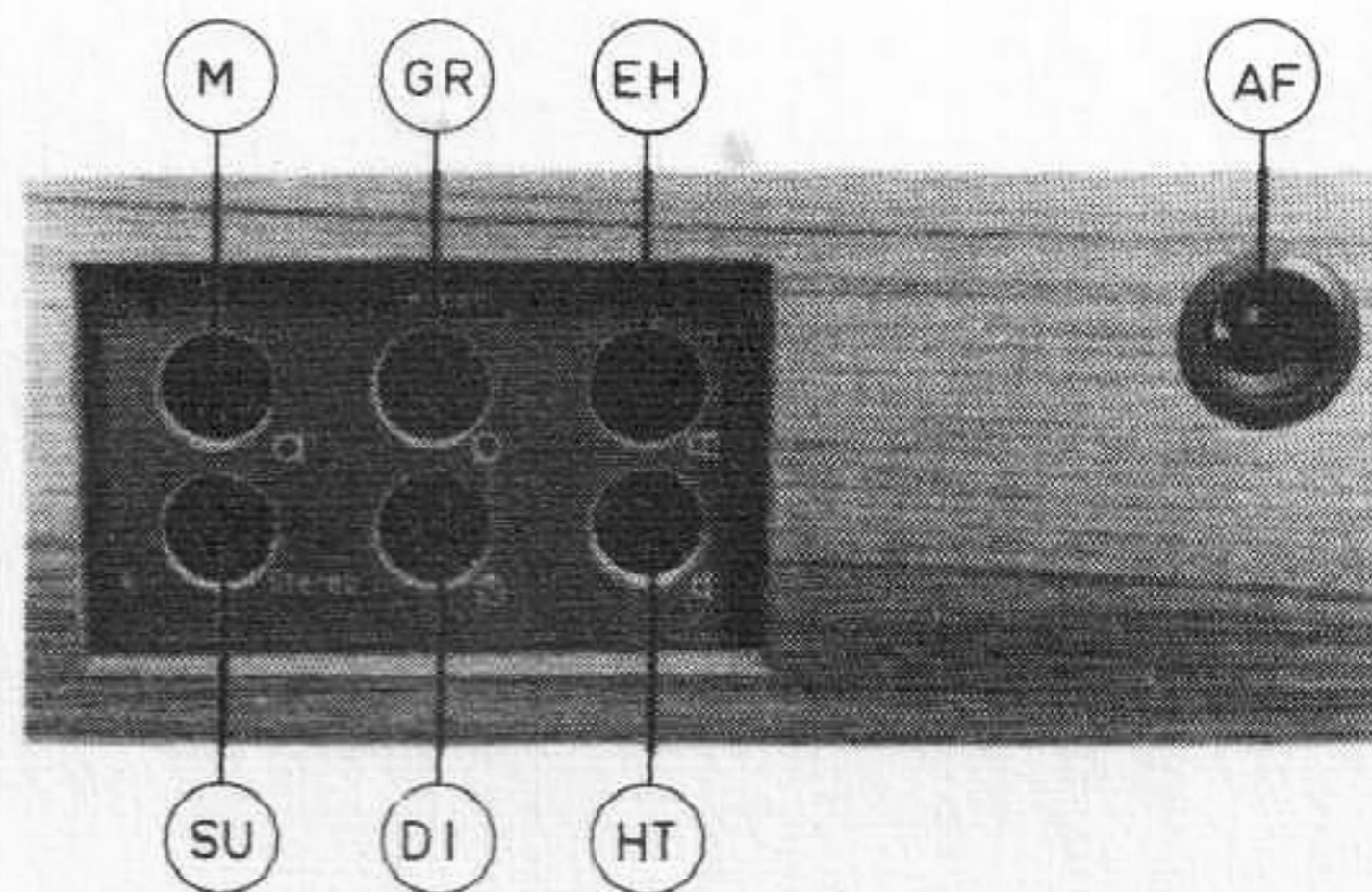
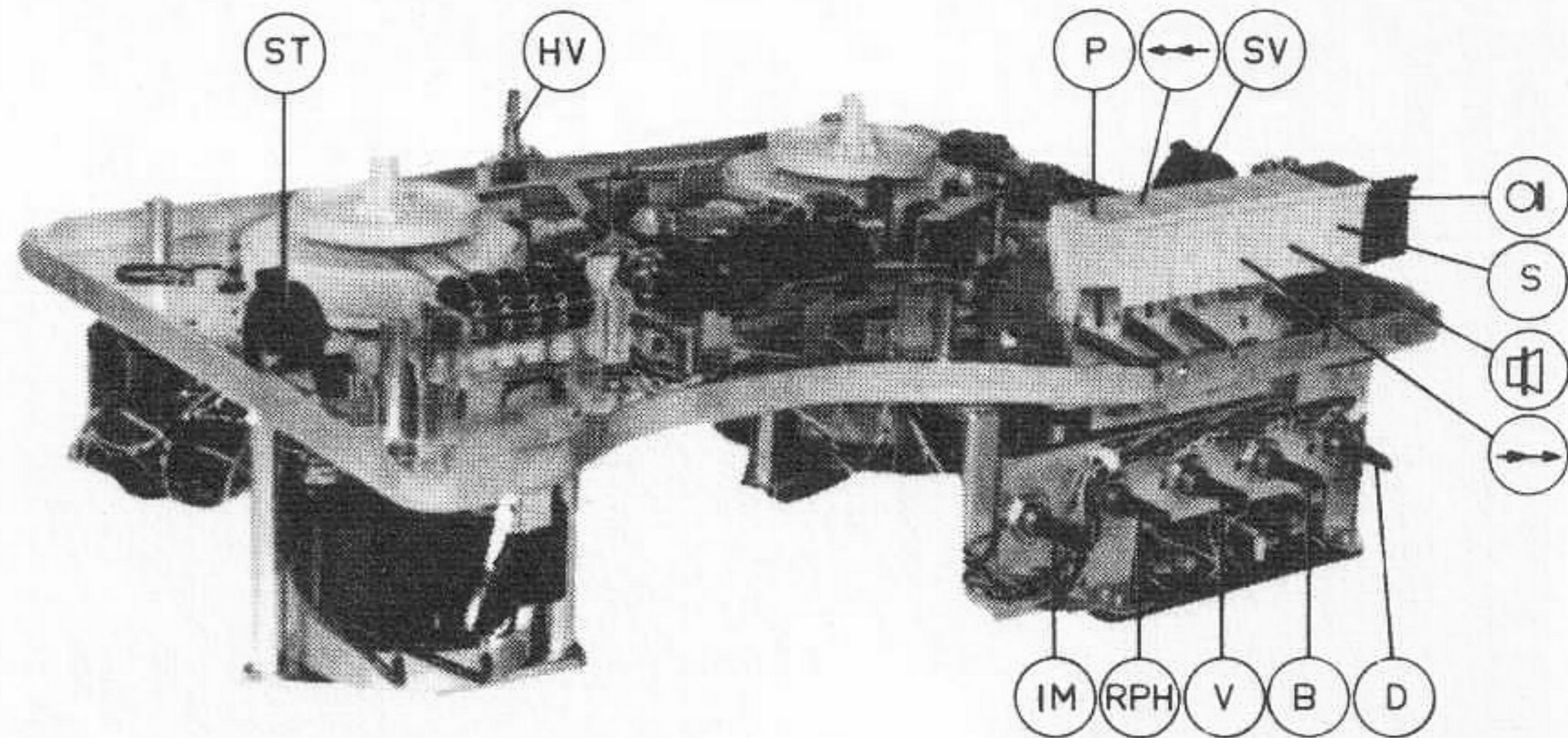

TEKNISKA DATA

Bandhastigheter	2,4 cm/s 4,75 cm/s 9,5 cm/s 19 cm/s
	15/16 "/s 1 7/8 "/s 3 3/4 "/s 7 1/2 "/s
Max. spoldiameter	18 cm (7")
Nätspänningar	110, 127, 220 och 245 V ~ , 50-60 Hz
Effektförbrukning	60 W
Uteffekt	3,5 W över 5,6 Ω

Utspanning

Hörtelefonutgång	200 mV över 15 k Ω
Diodutgång	1 V över 50 k Ω

















Känslighet och ingångsimpedans

Mikrofon	0,25 mV över 2 k Ω
Nålmikrofon	100 mV över 0,5 M Ω
Diodutgång	2 mV över 20 k Ω

För justeringsanvisningar hänvisas till sep. beskrivningsblad.

RÖR, TRANSISTORER OCH DIODER

B 1	Utstyrningsindikator	EM 87
B 2	LF-förstärkare	ECC 83
B 3	Slutsteg	EL 95
B 4	Slutsteg	EL 95
Tr 1	LF-förstärkare	AC 172
Tr 2	Förförstärkare	AC 172
Tr 3	LF-förstärkare	AC 172
Tr 4	LF-förstärkare	AC 126
Tr 5	LF-förstärkare	AC 126
Tr 6	Oscillator	AC 125
X 1	Indikatorlikriktare	OA 70
X 2	Nätlikriktare	B 250 C 100 td
X 3	Nätlikriktare	B 30 C 60

	Till / Från-tangent
	Hastighetsväljare
	Paus-tangent
	Snabbspolning bakåt
	Spårväljare
	Inspelningstangent
	Stopptangent
	Återgivningsstangent
	Snabbspolning framåt
	Inspelningskontroll, Mikrofon
	Radio/Phono
	Volymkontroll
	Baskontroll
	Diskantkontroll
	Mikrofoningång BU 1
	Grammofoningång BU 2
	Extra högtalareuttåg BU 3
	Stereo-uttåg BU 4
	Diodingång BU 5
	Hörtelefonuttåg BU 6
	Fotkontroll

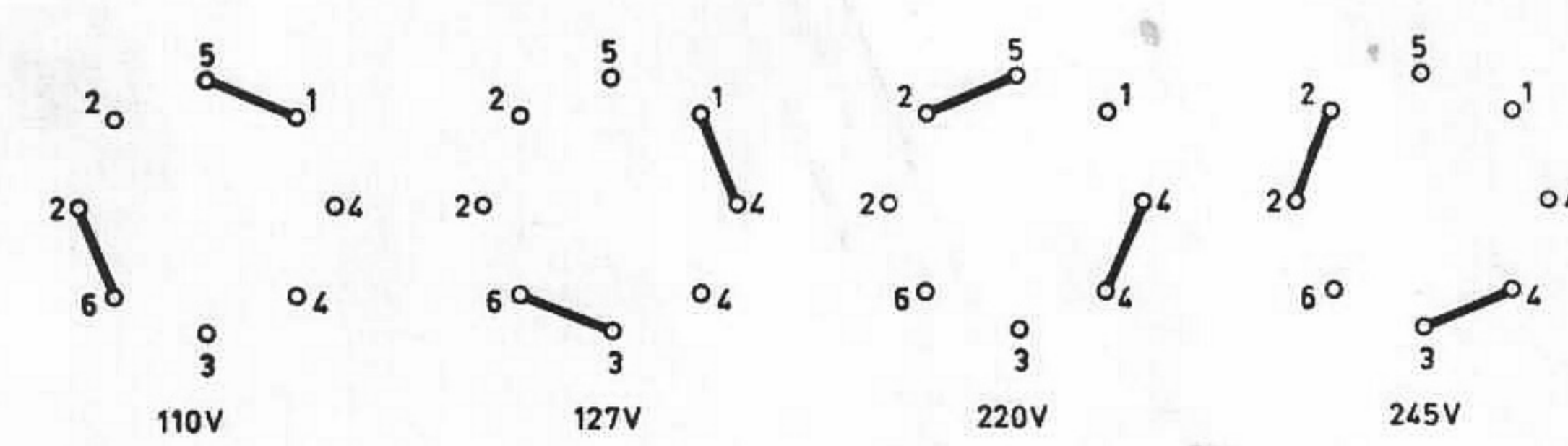
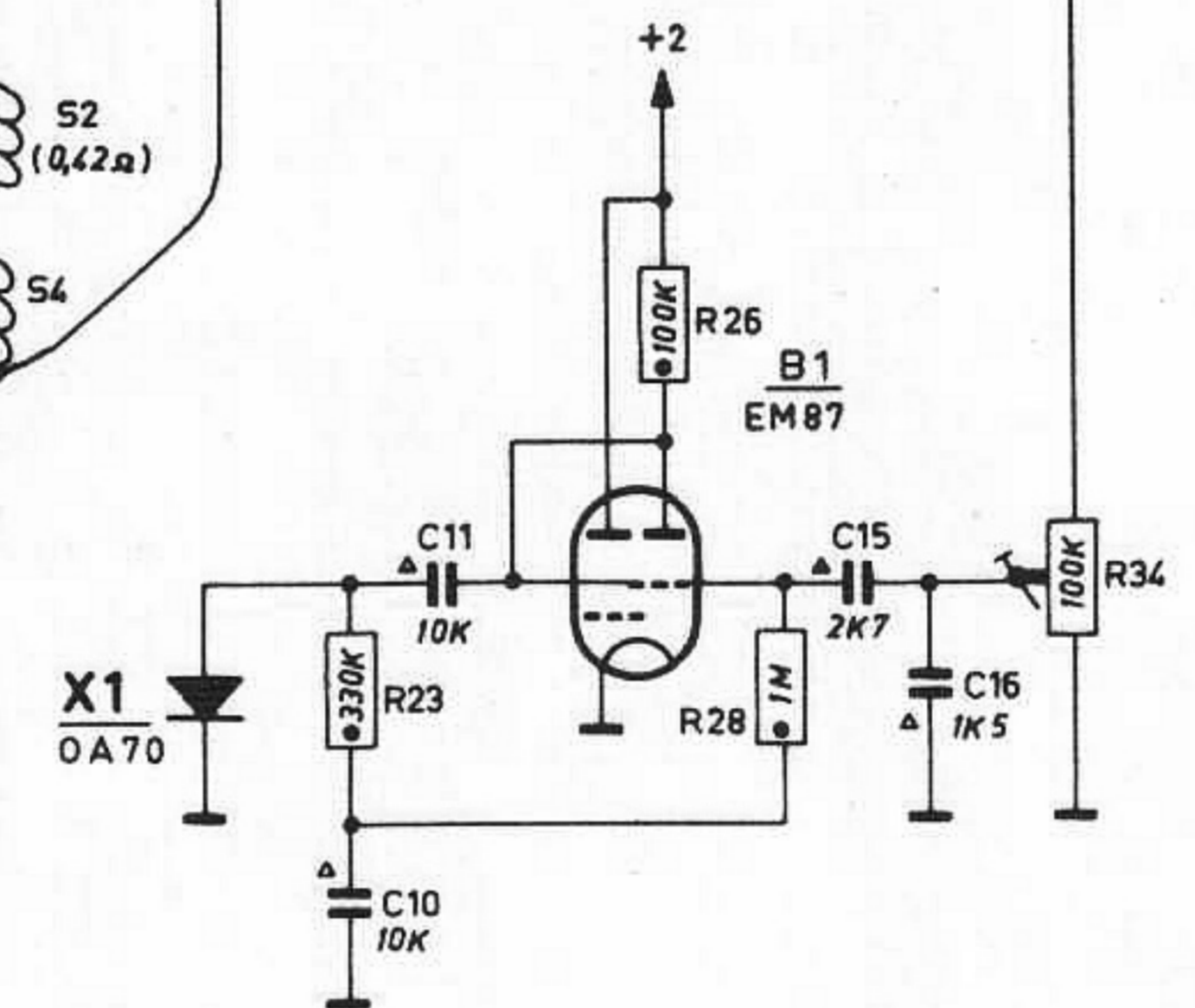
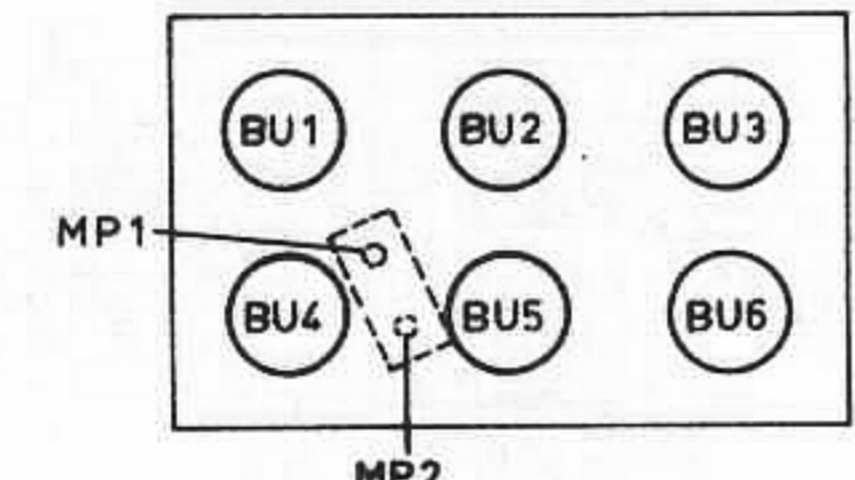
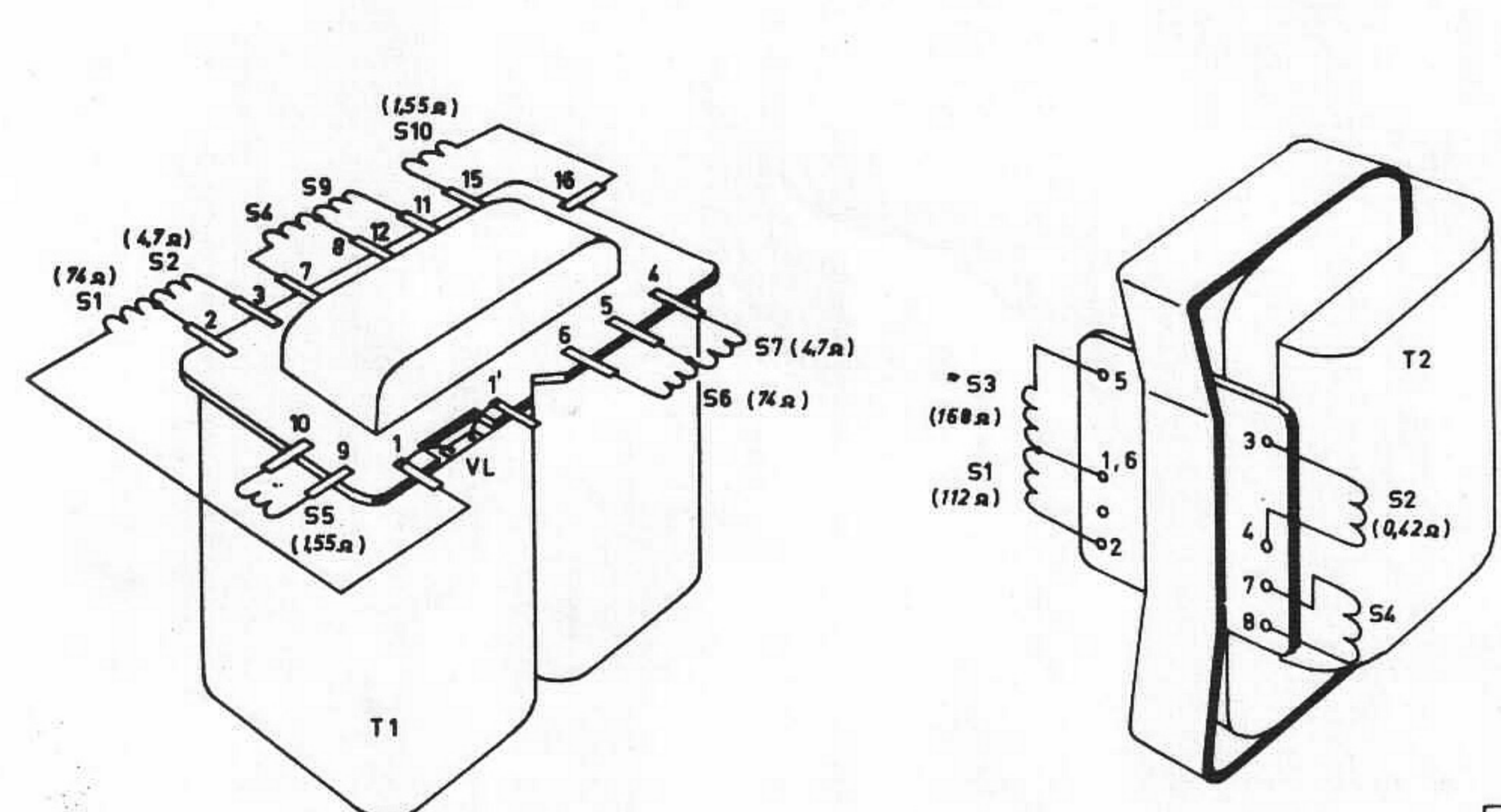
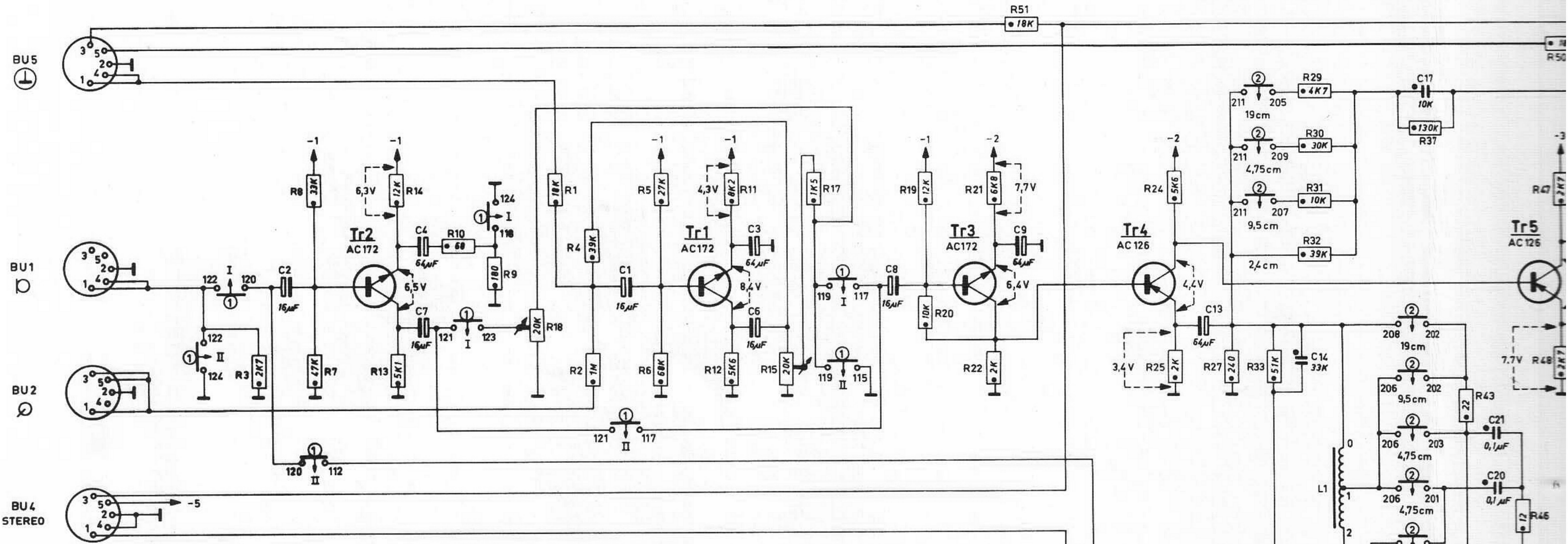

- ① = SK1
 - ② = SK2
 - ③ = SK3
 - ④ = SK4
- = I INSPELNING
 = II ÅTERGIVNING

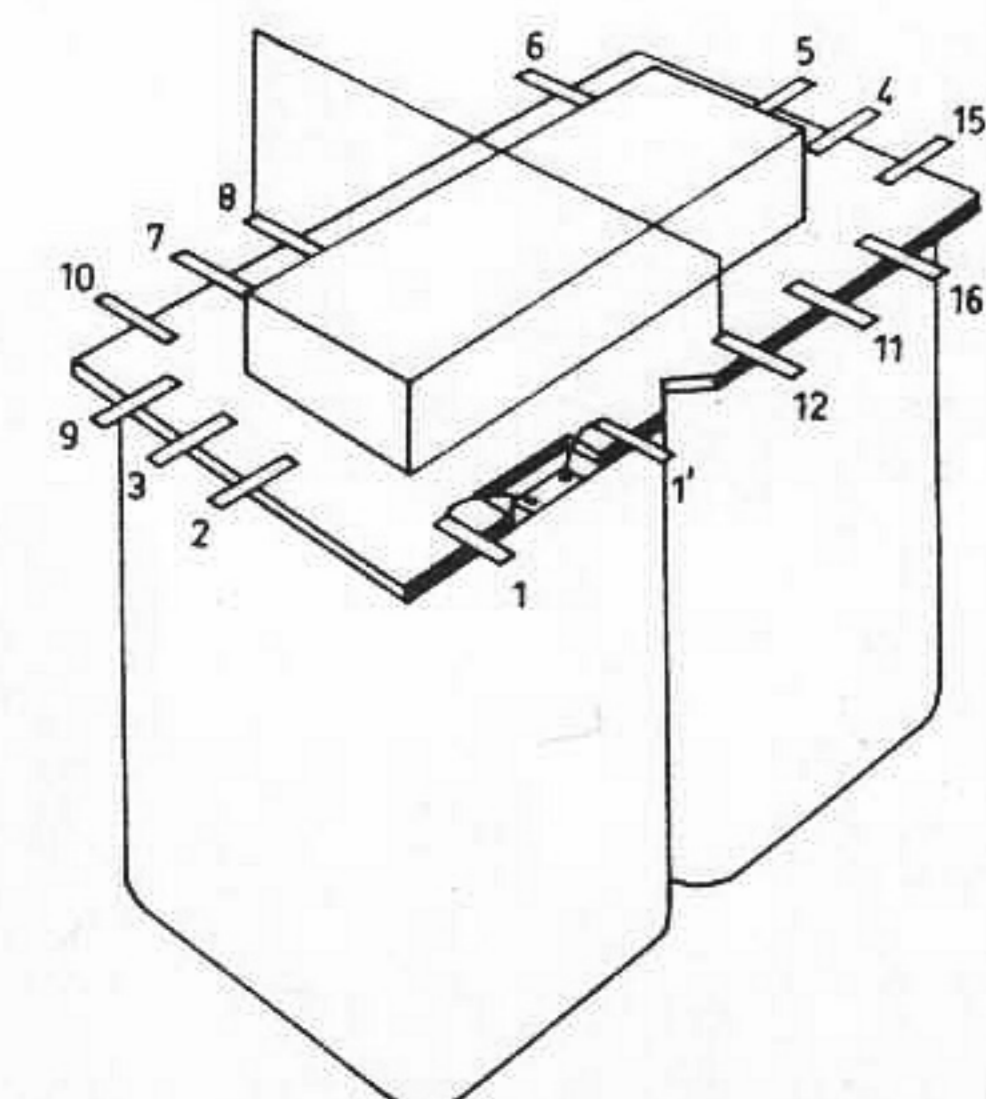

T1 fr. o. m. factory plate WR01

