

PHILIPS*Service*

250076

**ELA
AMPLIFIERS****EL 6435/00**

C 352 82

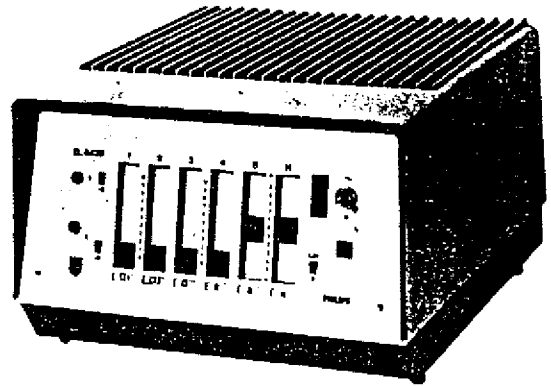

140 Watt amplifier for public address purposes; can be adapted for use in a 19" rack in combination with panel EL 6533/06.

GENERALDimensions:

Width 13 " (330 mm)
 Height 8 " (220 mm)
 Depth 16 " (410 mm)

Weight:

48 lbs (21½ kg)

Figures:

1. Schematic diagram and transformers
2. Top view
3. Left hand side view
4. Bottom view
5. Front view
6. Print unit A
7. Print unit B
8. Print unit C
9. Frequency characteristics

SERVICE INFORMATION										
------------------------	--	--	--	--	--	--	--	--	--	--

Ver/PC

Copyright Central Service Division N.V. PHILIPS' GLOEILAMPENFABRIEKEN, Eindhoven

Confidential Information for Philips Service Dealers

93 730 79.1.10

Valves:

B1...4 EF86
B5 ECC85
B6...9 PE 06/40N
B10 EM84

Fuses:

VL1 Temperature safety 974/T125
VL2 200-245 V 3A slow 974/V3150
110-145 V 6A slow 974/V6300
VL3 Fuse wire ϕ 0.25 Unit A R 152 JB/DO.25
VL4 Fuse wire ϕ 0.14 Unit C R 076 JB/DO.14

Lamps:

LA1 12 V 3 W 12910
LA2 40 mA 16 V D 115 10/40 mA/60 V
LA3 200 mA 4 V D 115 03/0.2 A/ 4 V
LA4 12 V 3 W 12875
B11 Neon Z8

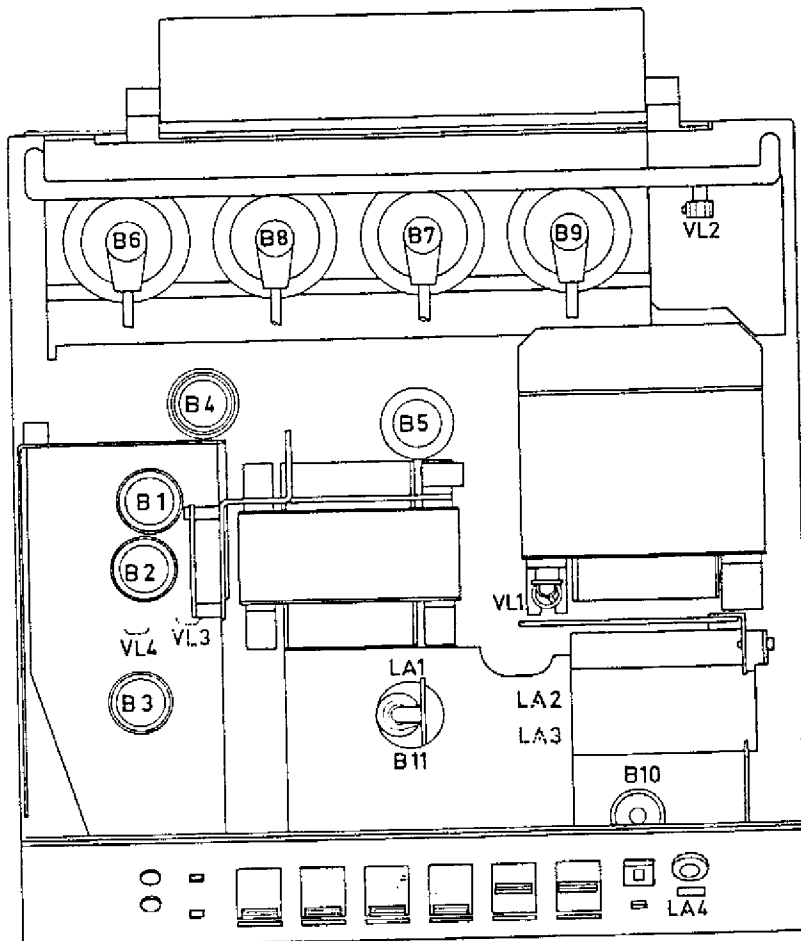

TECHNICAL DATA

Power supply: Supply voltage can be adjusted by means of the voltage adaptor (SK2) to 110-125-145-200-220-245 volts.
Mains frequency 50 - 100 c/s.

Consumption:

No load	133 W	192 VA	$\cos \varphi$	0.69
Full load	326 W	405 VA	$\cos \varphi$	0.80
Stand by	60 W	158 VA	$\cos \varphi$	0.38

Sensitivity: for nominal output voltage:

channels 1 and 2	5.25 mV \pm 20 %
channels 3 and 4	145 mV \pm 20 %

Input impedance: * (50 - 15000 c/s)

channels 1 and 2	1 - 0.2 M Ω
channels 3 and 4	0.22 - 0.1 M Ω

Output: - voltages; with screw connections
10-25-35-50-70-100 volts free from earth.

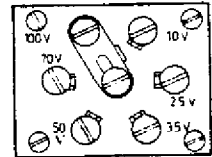

4 Volt line output to drive other amplifiers, minimum load 5 Ω .

Distortion: At 1000 c/s and 140 W output 2,5 % average.

Hum and noise Volume controls down -67 dB.

* Remark

= 30mV

On channels 1 and 2 on signal of 35 dB higher is tolerable (with volume control set down) without increasing the distortion level.

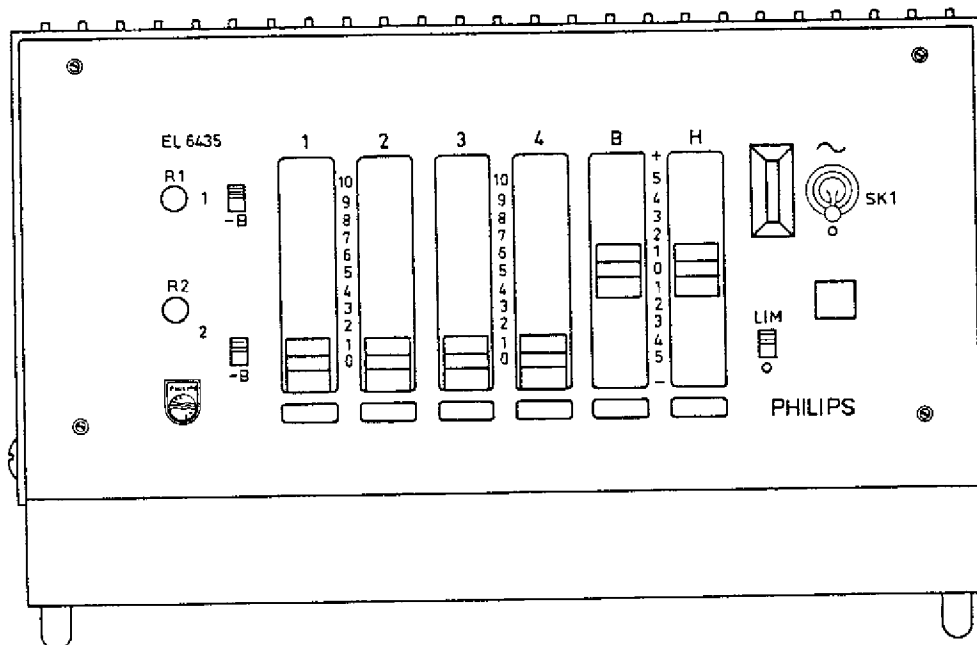
CONTROLS

From left to right on front panel:

- R1 screwdriver potentiometer (under plastic plug) channel 1, underneath for channel 2. With these controls the volume can be preset to a predetermined maximum level, or be set to avoid acoustic feedback.
- Two switches, switched upwards the characteristic on channel 1 or 2 is straight (music position); switched down, bass attenuation -3 dB at 600 c/s. (see fig. 9).
- 6 sliding controls: volume controls for channel 1, channel 2, channel 3, channel 4, next bass control B, next treble control H. With B and H set at 0 straight characteristic.
- Output indicator valve B10; with green columns closed, maximum output is delivered.
- Underneath limiter on/off switch SK.11
- Mains switch SK.1
- Underneath indicator light LA4.

ADJUSTMENT OF OUTPUT VALVES

Remove the bottom cover.

Adjustment is carried out by comparing the cathode current of the final amplifier valve on by one with a reference current. Each current flows through an indicator lamp, placed side by side. When the current is properly adjusted, the brightness of indicator lamp LA2 should be identical to the brightness of reference indicator LA3.

First switch SK8 away from the front. Then keep SK6 pushed down while with a screwdriver R12 is so adjusted that the brightness of LA2 and LA3 is identical. B6 is then adjusted properly. Let go switch SK6, and continue for the other output valves; B7 with SK4 and R10 etc.

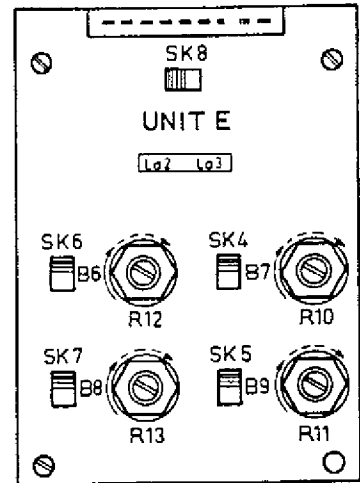
ACCESSORIES

With the amplifier, the following are supplied:

2 input plugs	977/F05
1 loudspeaker plug	978/2x12
4 shorting plugs	EL 6820
6 plastic potentiometer covers	P5 648 44/138

Extra available accessories

Plug in transformer 50-25000 Ω	EL 6805/01
Cable transformer 50-25000 Ω	EL 6806/10 or -/00
Plug in transformer 500-500 Ω	EL 6807/00
Plug in through connector	EL 6820/01
Plug in amplifier (straight characteristic)	EL 6825/00
Plug in amplifier (reduced bass response)	EL 6825/01
Plug in unit for remote control	EL 6826/00
Plug in amplifier (RIAA characteristic)	EL 6827/00
Plug in Music-speech switch	EL 6829/00
Panel for 19" rack mounting	EL 6533/06

CONNECTIONS

All connections are made to the back on a connection block. This block may be turned 90° so that external cabling can be brought into the bottom or into the back.

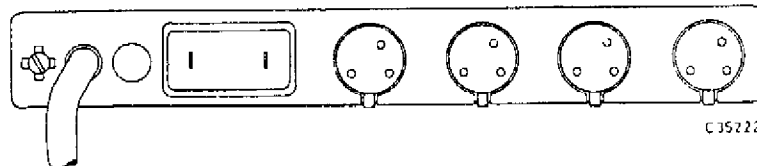

- Earth screw to earth the amplifier.
- Power cord, 3 core. If the earth connection is established via this cord and plug, it is advised not to use the earth screw.
- A hole to feed through the remote control cable when used, or to bring out the 4 V line output.
- Loudspeaker connection free from earth (use flat pin plug supplied).
- Inputs channel 4)

3)	} use 3 pole	pin 1	sensitive side
2)	} male plug	pin 2	insensitive side
1)		pin 3	earth

CIRCUIT DESCRIPTION

The four inputs are applied to the plug in bases 1, 2, 3 and 4. In bases 1 and 2, plug - in through connectors or matching transformers can be used; in bases 3 and 4 also pre-amplifiers. (see under "Extra available accessories").

The inputs on channels 1 and 2 are applied to valves B1 and B2 and amplified. In the anode circuit a switch SK9/10 is incorporated, so that the low notes can be attenuated in the position (for speech).- With the aid of the screwdriver operated potentiometer R1/2 the volume can be preset to maximum level, so that acoustic feedback will not occur. Between B3 and B4 the tone control section is built, whereby R8 controls the bass response and R7 the treble response.

- GR14 in the grid circuit of B5 improves the RC time of coupling capacitor C20 and grid leak R40, so that when the grid (7) of B5 becomes too far negative, this charge can leak away faster through GR14.
- Feedback is effected by means of winding S3 of output transformer T2, back via C21/R44 to the cathode resistor R35 of valve B4.
- Indicator valve B10 is fed from winding S3.
- Limiter.

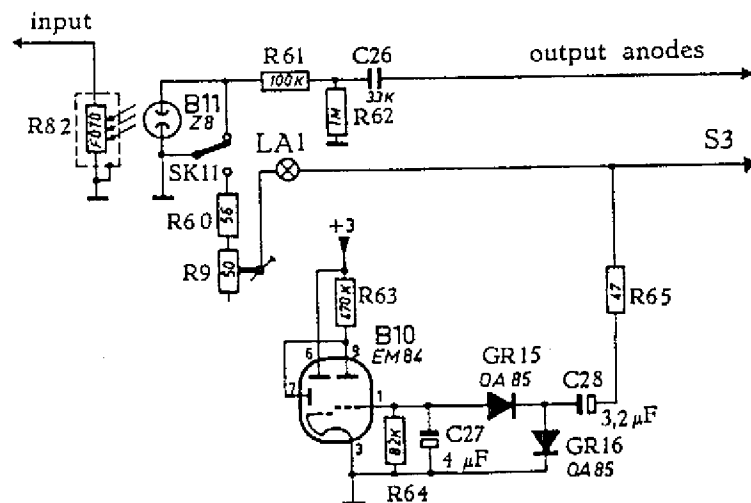

From the anodes of B7 and B9 a voltage is put across neon tube B11, if the voltage is not shorted by SK11. B11 light up, its brightness depending on the signal voltage on B7 and B9. The light strikes the photo resistor R82. Its resistance is reduced, and part of the input voltages is shorted to earth. Part of the voltage from S3 is fed via LA1 to earth. So when the average level of input signal is too high, LA1 light up and helps to reduce the resistance of the photo resistor;

thereby reducing the signal level going into B3. LA1 has thus a slow action effect, whilst Z8 takes care of sudden peaks. To compensate for differences in the photo resistor a potentiometer R9 with screwdriver adjustment has been fitted underneath the instruction plate. Do not touch this adjustment unless the photo resistor has been replaced.

REMOTE CONTROL

If use is made of the relay unit for remote control EL 6826, the relay coil is connected to points 1 and 2 of PL2, whereby points 1 and 2 of the connection RC are connected externally via a switch. If the switch is closed, the relay will be energised, and the connections 3-4, 5-6, 7-8 will be broken. Thereby the contacts 3-4 and 5-6 will open S2 and the H.T. will be switched off. The valves will only receive filament current. Loudspeaker output is disconnected using contacts 7-8.

If the switch is opened, a warning lamp (suggested 2.5 V 100 mA) will light up, the loudspeaker output is closed and the H.T. is supplied; the amplifier works normally.

If no remote control is used, the points 3-4, 5-6, 7-8 on PL2 must be short-circuited (see fig. 2 on top of supply transformer T1).

ADJUSTING OUTPUT VALVES

The output valves are adjusted by comparing the cathode current of the output valves one by one with a reference current (see below). When the cathode current is properly adjusted, the brilliance of lamp LA2 and the "reference lamp" LA3 should be equal. The output valves can be adjusted with R1, R2, R3, R4. The bias supply is taken from S6 and rectified by GR13.

SK8 "normal position" (away from front panel)

In the position drawn in Fig. 1 the negative side of the bias supply is taken from the point of junction R70-R71 via measuring point P on PL3, via SK8 and delivered to R10...R13. The positive side of the bias supply (Y) is earthed via Q (PL3) and SK8, and thus the cathodes of the output valves.

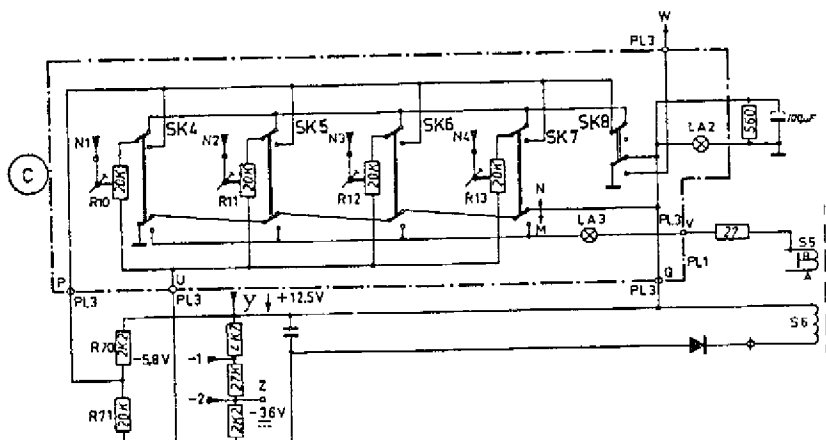

SK8 "adjust position" (towards frontpanel)

When SK8 is switched to the "adjust position", Y is earthed via SK4...7, and no longer via SK8.

Point W (PL3) (and therefore all incoming signals) is earthed via SK8.

The grids of the output valves are connected to full negative bias via R10...R13 and U (PL3), and are cut off. R10...R13 are no longer connected across R71, as SK8 disconnects the top side of R10...R13. When SK4 (SK5, SK6 or SK7) is held in switched-over position, Y is earthed via LA2. Point V (PL3) is earthed via LA3 and LA3 lights up. The top side of R10 (R11, R12 or R13) is connected to the point of junction R70-R71 and the corresponding valve conducts. The grid bias can now be adjusted with R10 (R11, R12 or R13), while the cathode current runs from Y via LA2 to earth. The corresponding valve is properly adjusted when LA3 and LA2 glow with an equal brilliance. Likewise adjust the other output valves, with R10, R11 or R13 and after that, replace SK8 in the normal position, away from the front panel.

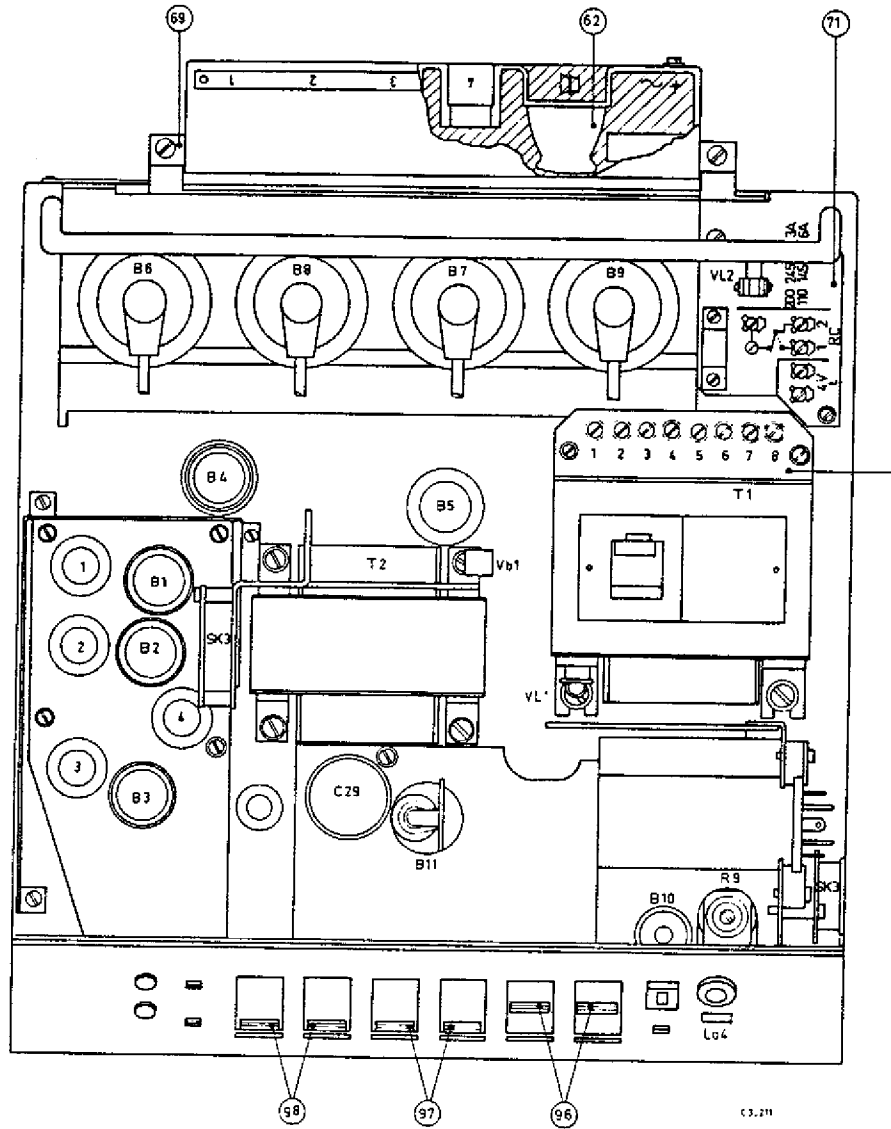

Fig. 2

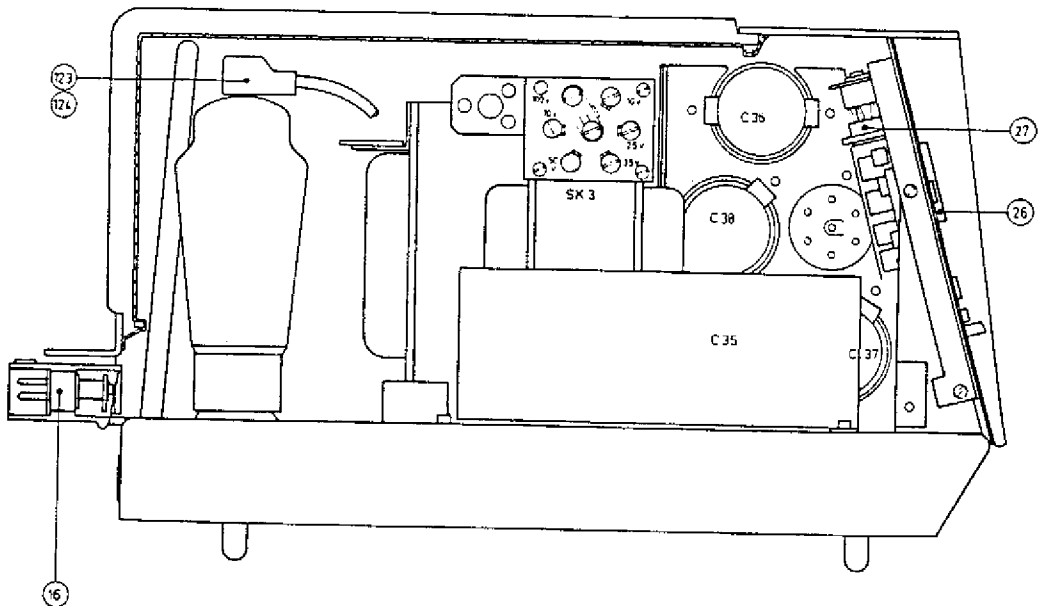

Fig. 3

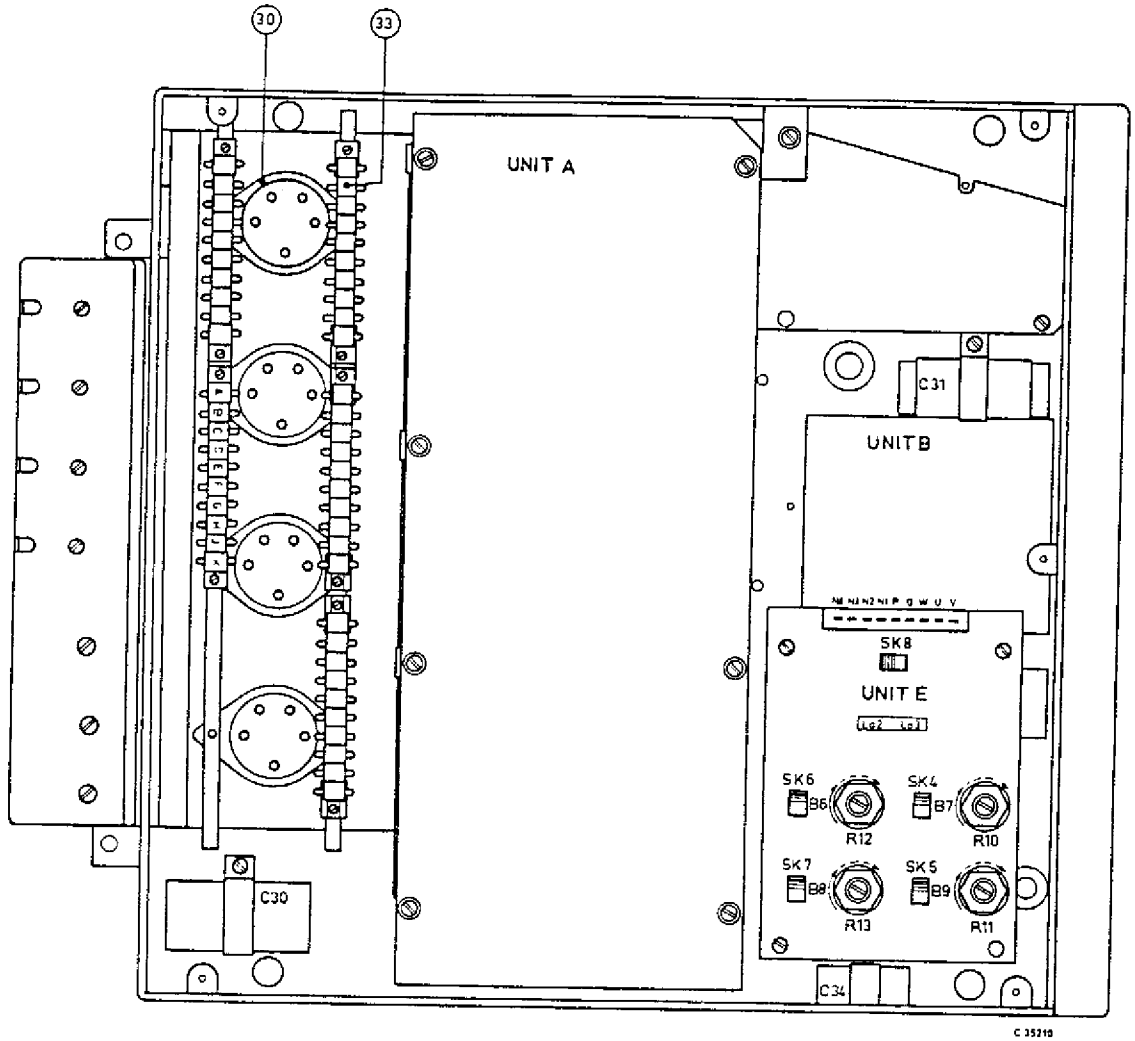

Fig. 4

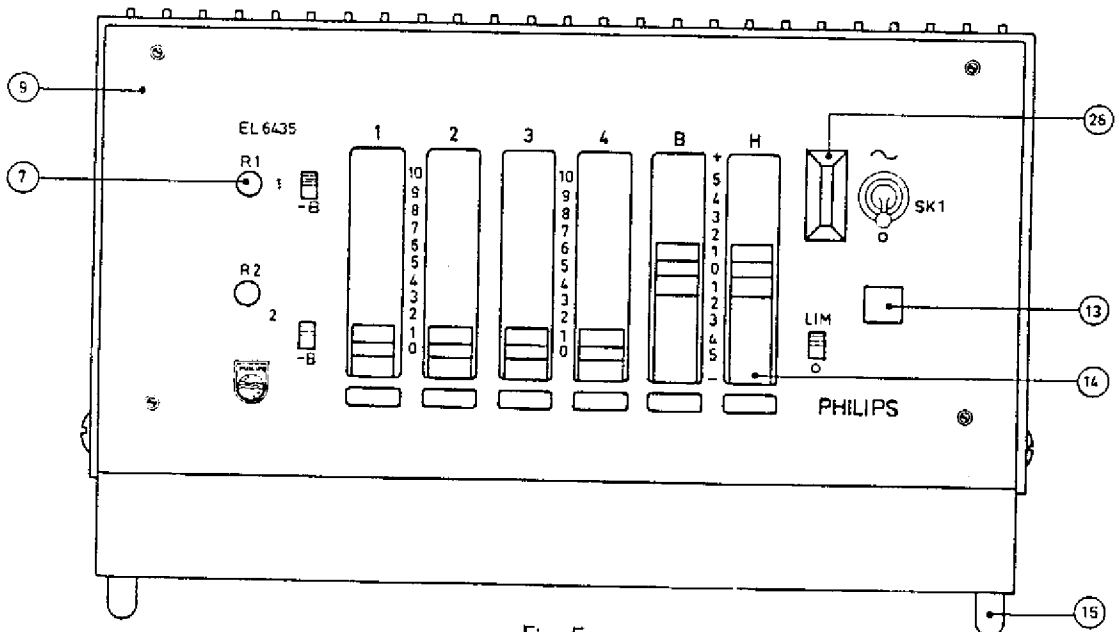

Fig. 5

(B)

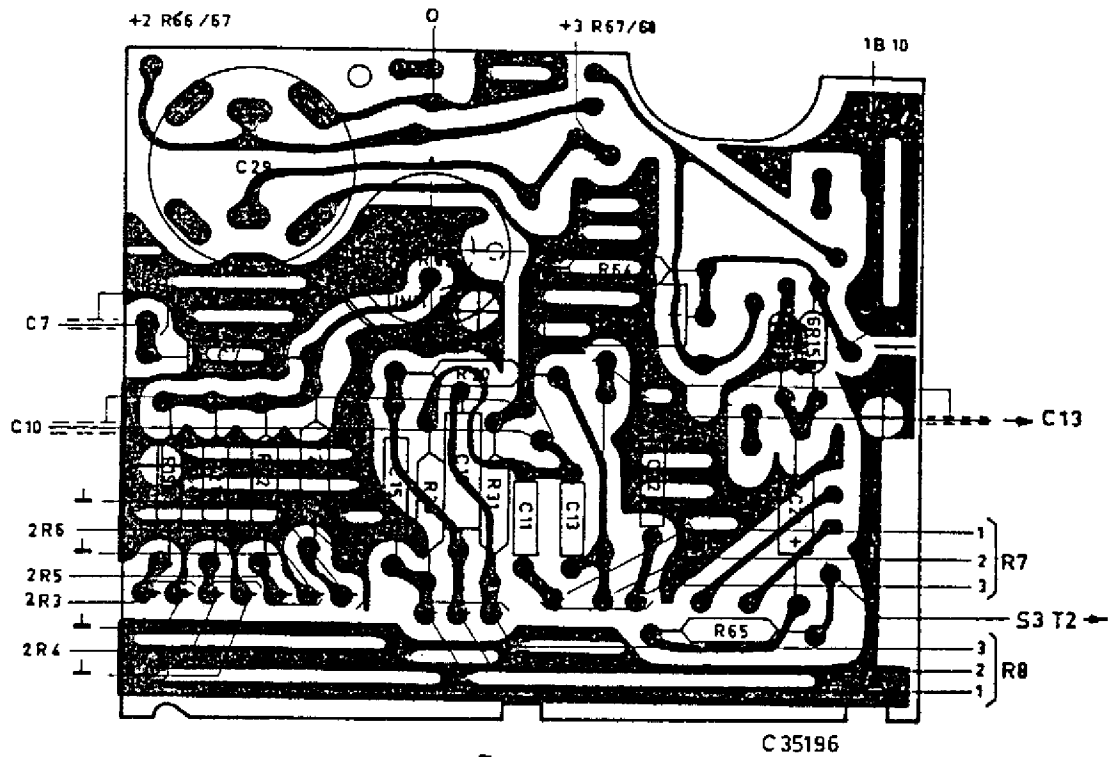

Fig. 7

(C)

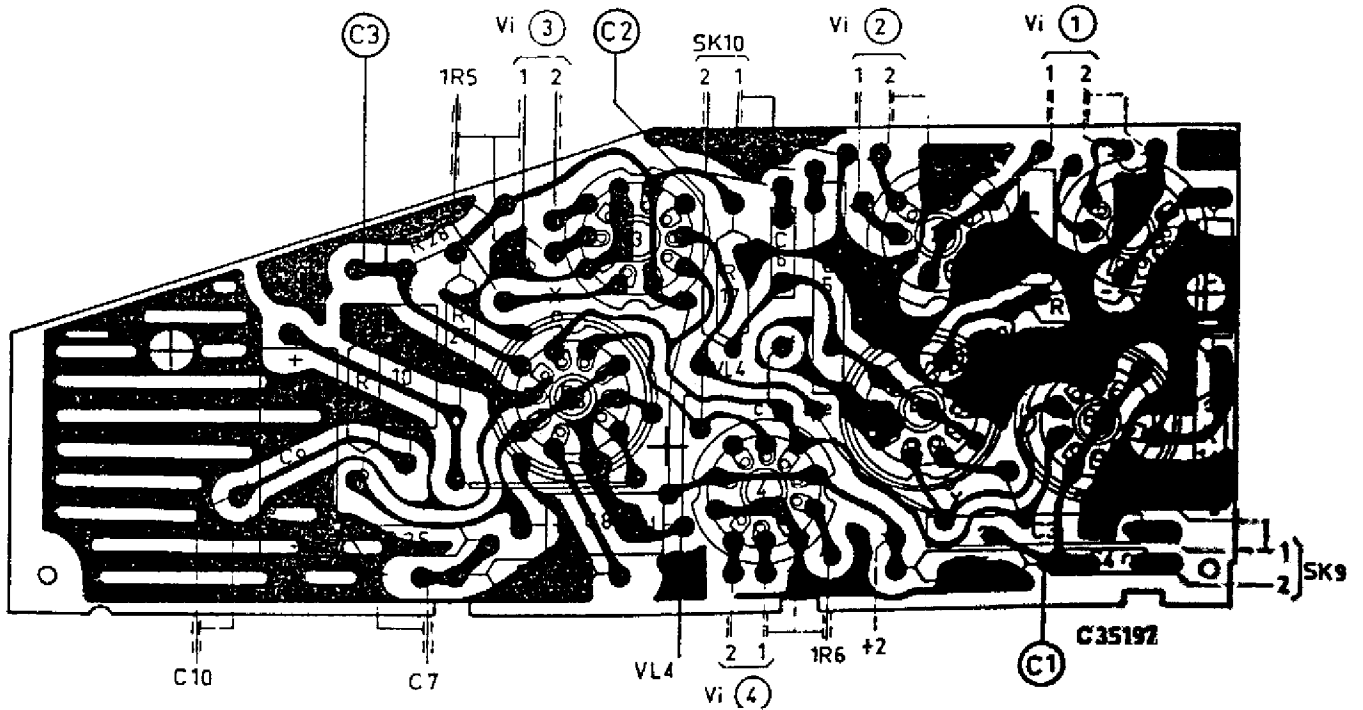
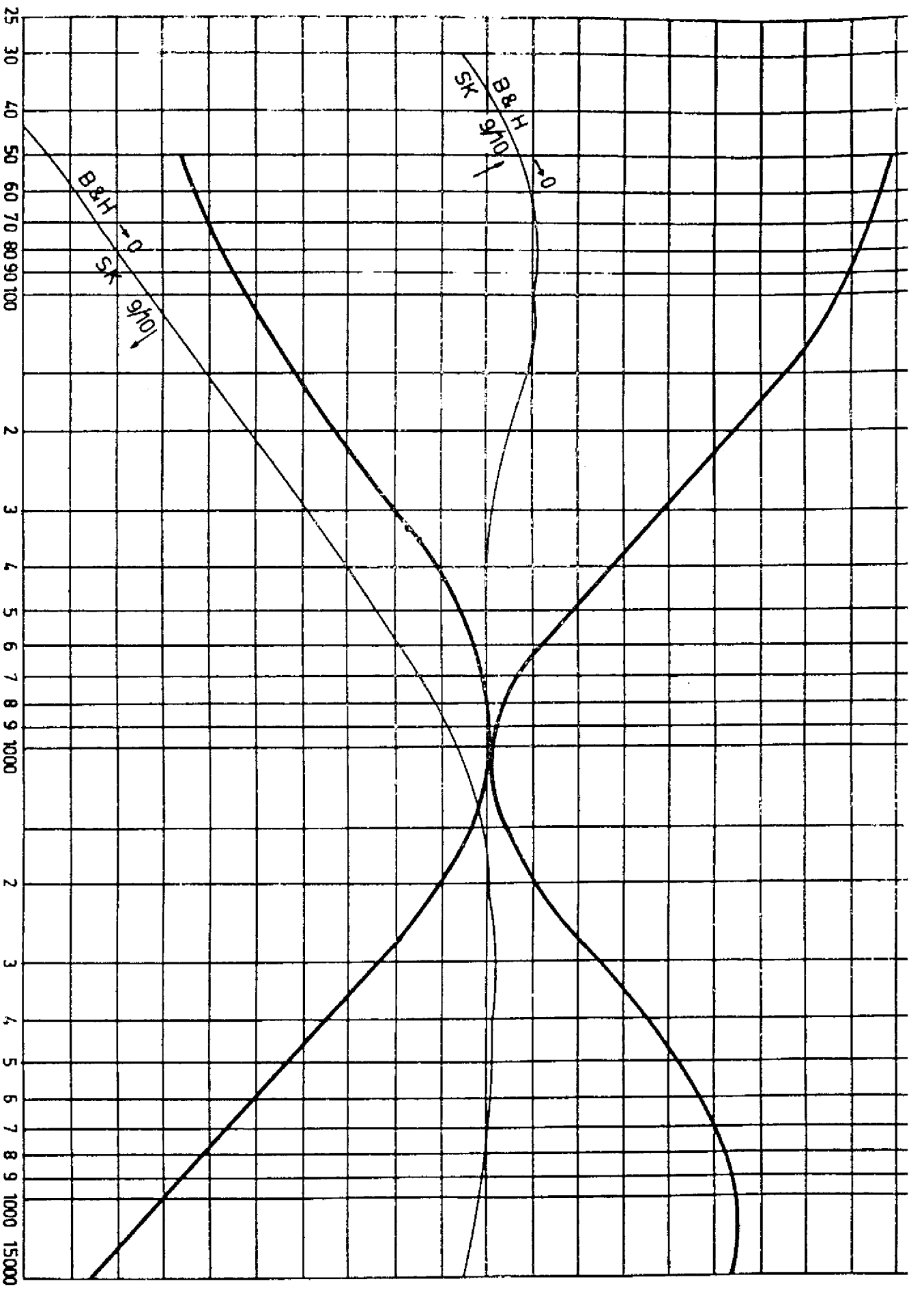

Fig. 8

+16
 +14
 +12
 +10
 +8
 +6
 +4
 +2
 0dB0
 -2
 -4
 -6
 -8
 -10
 -12
 -14
 -16
 -18
 -20



→ freq.

C35223

