

PHILIPS Service

RADIO

L2X42T/00L/00R/52L/52R

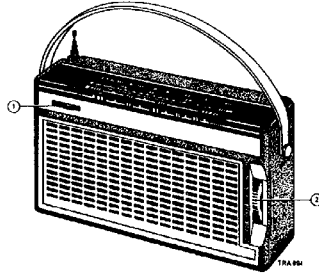

① Volume control + battery switch
Geluidssterkteregelaar + batterijschakelaar
Contrôl de volume + interrupteur
Lautstärkereglér + Batterieschalter
Control de volumen + interruptor

R35
+
SK3

② Tuning
Afstemming
Syntonisation
Abstimmung
Sintonía

S3+S5 (FM)
C25+C26 (AM)

The wave range switch is situated at the rear of the casing.
De golfbereikschakelaar bevindt zich aan de achterzijde van de kast.
Le commutateur de gammes d'ondes se trouve à l'arrière du coffret.
Der Wellenbereichschalter befindet sich an der Rückseite des Gehäuses.
El conmutador de ondas se encuentra a la parte trasera de la caja.

SPECIFICATION	SPECIFICATIE	SPECIFICATION	SPEZIFIKATION	ESPECIFICACION		
Loudspeaker	AD2309 SY	Luidspreker	Haut-parleur	Lautsprecher	AD2309 SY	Altavoz
IF (AM)	452 kc/s	MF (AM)	FI (AM)	ZF (AM)	452 kc/s	FI (AM)
IF (FM)	10,7 Mc/s	MF (FM)	FI (FM)	ZF (UKW)	10,7 Mc/s	FI (FM)
Tension	6 V (4x1,5 V)	Spanning	Tension	Spannung	6 V (4x1,5 V)	Tensión
Quiescent current	17 - 23 mA (FM)	Ruistroom	Courant de repos	Ruhestrom	17 - 23 mA (FM)	Corriente de reposo
Output power	250 mW	Uitgangsvermogen	Puissance de sortie	Ausgangsleistung	250 mW	Potencia de salida
Dimensions	172x108x49	Afmetingen	Dimensions	Abmessungen	172x108x49	Dimensiones

Wave ranges - Golfgebieden - Gammes d'ondes - Wellenbereiche - Márgenes de ondas

LW - LG - GO - LW - OL	: 2000 - 1150 m	(150 - 260 kc/s)
MW - MG - PO - MW - OM	: 580 - 184,9 m	(517 - 1612 kc/s)
SW - KG - OC - KW - OC	: 50,6 - 40 m	(5,9 - 7,5 Mc/s)
FM - FM - FM - UKW - FM	: 3,45 - 2,88 m	(87,5 - 104 Mc/s)

Transistors

TS1 - AF121	TS5 - AF121
TS2 - AF124	TS6 - AC125
TS3 - AF126	TS7 - AC126
TS4 - AF126	TS8 - AC127
	TS9 - AC128

Diodes

GR1 - AA119	GR6 - BA100
GR2,3 - 2x AA119	GR7 - 4822 211 00953
GR4 - OA90	
GR5 - OA90	

SERVICE INFORMATION									

Removing the apparatus from the casing, fig. 1

- . By loosening screws A, the rear cover can be removed.
- . The telescopic aerial can be removed by loosening screw B.
- . After having loosened screws C, the complete chassis can be removed from the casing.

Uitkasten, fig.1

- . Door de schroeven A los te draaien, kan de achterwand worden weggenomen.
- . De telescoopantenne kan worden verwijderd door schroef B los te draaien.
- . Door de schroeven C los te draaien kan het complete chassis uit de kast worden genomen.

Extraction du chassis, fig. 1

- . L'on peut enlever la paroi arrière en dévissant les vis A.
- . Retirer l'antenne télescopique en dévissant la vis B.
- . L'on peut extraire le châssis complet du boîtier en dévissant les vis C.

Ausbau, Abb. 1

- . Wenn man die Schrauben A losdreht, kann die Rückwand entfernt werden.
- . Die Teleskopantenne kann entfernt werden, indem man die Schraube B losdreht.
- . Wenn man die Schrauben C losdreht, kann das vollständige Chassis aus dem Gehäuse genommen werden.

Quitar el chasis de la caja, ver la fig. 1

- . Soltando los tornillos A puede retirarse la pared posterior.
- . La antena telescópica puede quitarse soltando el tornillo B.
- . Soltando los tornillos C puede retirarse el chasis completo de la caja.

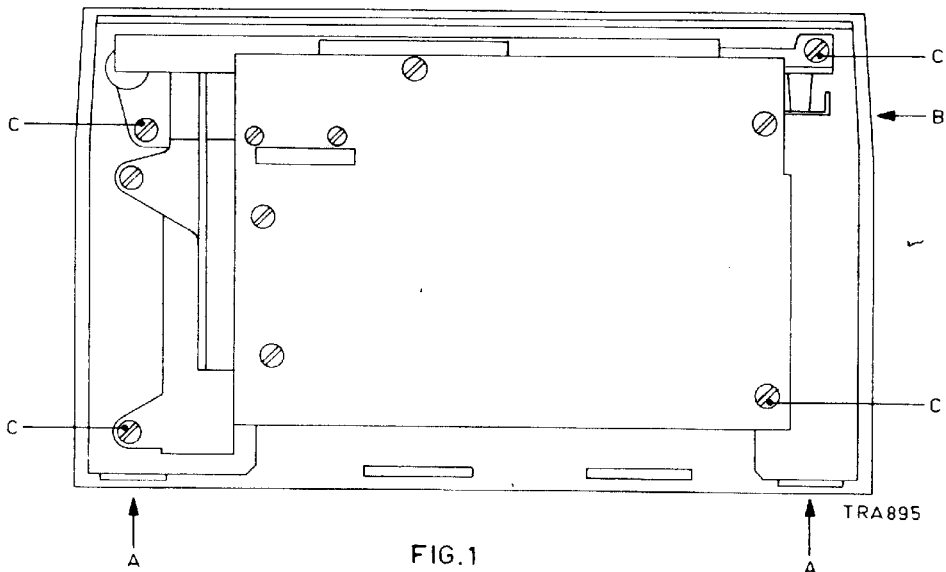

FIG.1

L2X42T/52L/52R/00L/00R

S11 } S12 } C16 }	4822 210 00889	IF coil FM MF-spoel FM Bobine de MF, FM ZF-Spule UKW Bobina de FI, FM	S24 } S24 } S25 }	4822 210 00893	Oscillator coil SW Oscillatortroepel KC Bobine d'oscillateur OC Oscillatortroepale KW Bobina de oscilador OC	S35 } S35' } C37 }	4822 210 00896	IF coil AM MF-spoel AM Bobine de MF, AM ZF-Spule AM Bobina de FI, AM
S13 } S14 } S15 } S16 }	4822 211 00954	Ferroreceptor Ferroreceptoor Ferroreceptor Ferroreceptor	S26 } S27 }	4822 210 00894	IF coil AM MF-spoel AM Bobine de MF, AM ZF-Spule AM Bobina de FI, AM	S38 } S38' } S39 } C38 }	4822 107 00183	Detector coil FM Detectortroepel FM Bobine d'etecteur FM Berektoerspule UKW Bobina de detector FM
S18 } S19 }	4822 210 00891	Aerial coil SW Antennespoel KC Bobine d'antenne OC Antennenspule KW Bobina de antena OC	S29 } S30 } C50 }	4822 107 00182	IF coil FM MF-spoel FM Bobine de MF, FM ZF-Spule UKW Bobina de FI, FM	S40 } S40' } S41 } C39 }	4822 107 00184	Detector coil FM Detectortroepel FM Bobine d'etecteur FM Berektoerspule UKW Bobina de detector FM
S20 } S20' } S21 }	4822 210 00892	Oscillator coil, MW-LW Oscillatortroepel, MG-LG Bob. d'oscillateur, FO-CO Oscillatortroepale, MW-LW Bob. de oscilador, OM-OL	S33 } S34 } C52 }	4822 107 00182	IF coil FM MF-spoel FM Bobine de MF, FM ZF-Spule UKW Bobina de FI, FM	S42 } S43 }	4822 210 00897	Detector coil AM Detectortroepel AM Bobine d'etecteur AM Berektoerspule AM Bobina de detector AM
S25 } C26 }	4822 059 00341	Tuning capacitor Afstemcondensator Condensateur variable Dreikondensator Condensateur variable	S31 } C51 }	4822 210 00895	IF coil AM MF-spoel AM Bobina de MF, AM ZF-Spule AM Bobina de FI, AM		4822 210 00881	FM tuner FM-eenhheid Unité de FM UKW-Einheits Unidad de FM modelo-00
C2 } C3 } C4 } C5 } C7 } C8 } C15 } C20 } C21 } C22 } C23 } C24 }	4822 069 00627 4822 069 00627 4822 069 00627 4822 069 00966 4822 069 00627 4822 069 00627 4822 069 00627 4822 069 00639 4822 211 00955 4822 211 00812 4822 069 00555 4822 211 00812 4822 069 00831	C45 C46 C47 C48 C55 C56 C61 C62 C63 C64	C 280 AA/F4TK C 280 AA/F4TK 905/D3K C 280 AA/F4TK 4822 069 00811 4822 069 00627 905/W2.5 4822 069 00627 905/D3K C 280 AA/F4TK 4822 069 00627	C65 C66 C67 C68 C70 C71 C72 C73 C74 C75 C76	4822 211 01035 909/3200 909/3200 905/A100 905/D3K 905/C25 909/A100 4822 069 00644 905/A100 909/3200 C 280 AA/F4TK 909/3200	677 678 679 C80 C81 R35 R45 R46 R47 R50 R57	509/3200 509/3200 505/A100 505/W2.5 4822 069 00624 4822 211 00958 4822 211 00956 4822 071 00729 4822 211 00957 4822 071 00672	

To order parts which are not mentioned in this list, consult the Catalogue for Service Spare Parts.

Voor het bestellen van onderdelen die niet in bovenstaande lijst vermeld zijn, raadpleeg men de Catalogue voor Service-onderdelen.

Pour les pièces ne figurant pas dans cette liste, consulter le Catalogue pour Pièces de Rechange Standard.

Zur Bestellung nicht in dieser Liste genannten Einzelteile siehe den Katalog für Service Standard Ersatzteile.

Para las piezas que no figuran en las listas, consúltense el Catálogo de Recambio Standard.

Front part, R-version	4822 211 01102	Voorzijde, R-uitvoering	L'avant, exécution R	4822 211 01102	Vorderseite, R-Ausführung	4822 211 01102	Fronte ejecución R
Rear cover, R-version	4822 210 01029	Achterwand, R-uitvoering	Fanneau arrière exécution R	4822 210 01029	Rückwand, R-Ausführung	4822 210 01029	Panel posterior, ejecución R
Front part, L-version	4822 211 01103	Achterwand, L-uitvoering	L'avant, exécution L	4822 211 01103	Vorderseite, L-Ausführung	4822 211 01103	Panel, ejecución L
Rear cover, L-version	4822 210 01028	Achterwand, L-uitvoering	Fanneau arrière exécution L	4822 210 01028	Rückwand, L-Ausführung	4822 210 01028	Panel posterior, ejecución L
Ornamental grid	4822 211 01104	Sierrooster	Grille enjoliveuse	4822 211 01104	Ziergitter	4822 211 01104	Redilla ornamental
Ornamental strip on front	4822 211 01106	Sierstrip op front	Enjolivre à l'avant	4822 211 01106	Zierstreifen an der Vorderseite	4822 211 01106	Platina ornamental en frente
Battery cover, R-version	4822 211 00946	Batterijdeksel, R-uitvoering	Coque de pile	4822 211 00946	Batteriedeckel	4822 211 00946	Cubierta de pilas
Battery cover, L-version	4822 211 00947	Batterijdeksel, L-uitvoering	Coque de pile	4822 211 00947	Batteriedeckel	4822 211 00947	Cubierta de pilas
Grip R-version	4822 211 00942	Handgrip, R-uitvoering	Poignée, exécution R	4822 211 00942	Handgriff, R-Ausführung	4822 211 00942	Ass, ejecución R
Grip L-version	4822 211 00943	Handgrip, L-uitvoering	Poignée, exécution L	4822 211 00943	Handgriff, L-Ausführung	4822 211 00943	Ass, ejecución L
Dial, R-version	4822 211 00959	Schaal, R-uitvoering	Cadrán, exécution R	4822 211 00959	Skala, R-Ausführung	4822 211 00959	Escala, ejecución R
Dial (EUR), L-version	4822 211 00961	Schaal (EUR), L-uitvoering	Cadrán, (EUR) exécution L	4822 211 00961	Skala, (EUR) L-Ausführung	4822 211 00961	Escala (EUR), ejecución L
Dial (OV), L-version	4822 211 00962	Schaal (OV), L-uitvoering	Cadrán, (OV) exécution L	4822 211 00962	Skala, (OV) L-Ausführung	4822 211 00962	Escala (OV), ejecución L
Plastic chassis	4822 211 01067	Plastic chassis	Chassis en matière plastique	4822 211 01067	Kunststoffchassis	4822 211 01067	Chassis de plástico
Plastic pulley	WE 744 78	Plastic snarwiel	Fouille en matière plastique	WE 744 78	Kunststoffseilrad	WE 744 78	Polea pequeña de plástico
Little shaft for plastic pulley	4822 211 01101	Kleine as voor plastic-snarwiel	Petit axe pour poulie plastique	4822 211 01101	Kleine Achse für Kunststoffseilrad	4822 211 01101	Eje pequeña para polea de plástico
Little plastic pulley, complete with bracket	4822 210 00998	Kleine plastic snarwiel, compleet met beugel	Petite poulie en matière plastique, complète avec support	4822 210 00998	Kunststoffseilrad komplett mit Bügel	4822 210 00998	Polea pequeña de plástico, completo con abrazadera
Socket earphone	4822 211 00965	Socket earphone	Oortelefoon-sensuïtizing	4822 211 00965	Kopfhörersensuchluss	4822 211 00965	Hembrilla del auricular
Nut fixing socket earphone	43 715 60	Nut fixing socket earphone	Moer bevestiging oortelefoon-sensuïtizing	43 715 60	Mutter Befestigung Kopfhörersensuchluss	43 715 60	Tuerca fijación hembrilla del auricular
Screw fixing battery cover	4822 211 00948	Screw fixing battery cover	Vis fixation couvercle batterie	4822 211 00948	Schraube Befestigung Batteriedeckel	4822 211 00948	Tornillo fijación cubierta de pilas
Contact plate with spring (-)	4822 211 00944	Contact plaat met veer (-)	Plaquelette fixe avec ressort (-)	4822 211 00944	Kontaktplatte mit Feder (-)	4822 211 00944	Placa portacontactos con resorte (-)
Contact plate (+)	4822 211 00945	Contact plaat (+)	Plaquelette fixe (+)	4822 211 00945	Kontaktplatte (+)	4822 211 00945	Placa porta contactos (+)
Telescopic aerial	4822 210 00885	Telescopic aerial	Antenne télescopique	4822 210 00885	Teleskopantenne	4822 210 00885	Antena telescópica
Slide switch (wave ranges)	4822 210 00886	Slide switch (wave ranges)	Commutateur coulissant (game d'ondes)	4822 210 00886	Schiebeschalter (Wellenbereiche)	4822 210 00886	Commutador deslizante (márgenes de ondas)
Slide for switch	4822 210 00888	Schuif voor schakelaar	Curseur pour commutateur	4822 210 00888	Schieber für Schalter	4822 210 00888	Placa deslizante para conmutador
Pin for slide of switch	4822 211 00949	Pen voor schakelaarschuif	Clavette pour curseur	4822 211 00949	Stift für Schieber	4822 211 00949	Patilla de placa deslizante
Spring for slide of switch	4822 101 00345	Veer voor schakelaarschuif	Ressort pour curseur	4822 101 00345	Feder für Schieber	4822 101 00345	Resorte para placa deslizante
Driving mechanism slide switch with knob	4822 210 00887	Driving mechanism slide switch with knob	Mécanisme d'entraînement commutateur à bouton	4822 210 00887	Schaltmechanismus des Knopf (Abtastung)	4822 210 00887	Dispositivo de arrastre botón (sin botón)
Diagonal background	4822 211 00951	Diagonal background	Plaque derrière skaia	4822 211 00951	Platte hinter Skala	4822 211 00951	Fondo diagonal con botón
	4822 211 00952			4822 211 00952		4822 211 00952	Placa tras escala

Adjustment

- x Signal with 400 c/s amplitude modulated, via coupling coil on ferroceptor.
- xx Telescopic aerial extended.
- xxx Service oscillator with 10,7 Mc/s amplitude modulated signal connected to aerial input.

The collector current of the two output transistors TS8 and TS9 should be 4 mA, possible deviations can be corrected with R45.

Afregeling

- x Signaal met 400 Hz amplitude-gemoduleerd via een koppelspoel op de ferroceptor.
- xx Telescoopantenne uitgeschoven.
- xxx Service-oscillator met 10,7 Mc/s amplitude gemoduleerd signaal op antenne-ingang aansluiten.

De collectorstroom van de beide eindtransistoren TS8 en TS9 moet 4 mA bedragen, een eventuele afwijking kan met R45 worden gecorrigeerd.

Alignement

- x Signal avec 400 Hz modulé en amplitude à travers une bobine de couplage sur le ferrocaptor.
- xx Antenne télescopique sortie.
- xxx Oscillateur de service avec une fréquence modulée en amplitude de 10,7 Mc/s à l'entrée d'antenne.

Le courant de collecteur des deux transistors finals TS8 et TS9 doit s'élever à 4 mA, un écart éventuel peut être corrigé à l'aide de R45.

Abgleichen

- x Ein mit 400 Hz in amplituden-moduliertes Signal über Koppelwicklung auf Ferroceptor.
- xx Teleskopantenne ausgeschoben.
- xxx Service-Oszillator mit einer amplitudenmodulierten Frequenz von 10,7 MHz am Antenneneingang anschliessen.

Der Kollektorstrom der beiden Endtransistoren TS8 und TS9 muss 4 mA betragen. Eine etwaige Abweichung kann mit R45 korrigiert werden.

Ajuste

- x Señal de 400 c/s modulado en amplitudo a través de la bobina de acoplo sobre el ferrocaptor.
- xx Antena telescópica desenchufada.
- xxx Oscilador de service con una frecuencia de 10,7 Mc/s en amplitud sobre la entrada de antena.

La corriente de colector de los dos transistores de salida TS8 y TS9 tiene que ser de 4 mA, cualquier desviación puede corregirse mediante R45.

Serv-o-mecum E-a-1 E-a-2	Wave range Golffgebied Gamme d'ondes Wellenbereich Margen de ondas	Service oscillator	Frequency Frequentie Fréquence Frecuencia	Variable capacitor Variable condenser Condensateur variable Drehkondensator Condensador variable	Volume control Volumeregelaar Contrôle de volume Lautstärkerregler Control de volumen	Adjust to max. output Afrregelen op max. uitgangsspanning Régler au max. tension de sortie Abgleichen auf max. Ausgangsspannung Ajustarse al max. tensión de salida	
1F-NF-F1-ZF-F1 (AM)	MW-MG-PO-NW-OM	35000 pF - 0753	452 kc/s	← Min.	Max.	S42, S55, S51, S26	
RF-RF-F1-F1-F1 (AM)	MW-MG-PO-NW-OM	"	510 kc/s	→ Max.	Max.	S20	
			1650 kc/s	← Min.	Max.	C56	
			550 kc/s	550 kc/s	Max.	S13	
			1350 kc/s	1350 kc/s	Max.	S30	
	Repeat						
	1W-LG-00-1W-01	"	"	147 kc/s	→ Max.	Max.	C37
				170 kc/s	170 kc/s	Max.	S15
				250 kc/s	250 kc/s	Max.	C21
	Repeat						
	SW-K0-00-KW-00	"	"	5,85 Mc/s	→ Max.	Max.	S24, S18
7,6 Mc/s				← Min.	Max.	C39, C21	
Repeat							
1F-NF-F1-ZF-F1 (FM)	FM-FM-FM-0KW-FM	S1	10,7 Mc/s	-	Max.	S40, S38, S33, S29, S6	
RF-RF-F1-F1-F1 (FM)	FM-FM-FM-0KW-FM	S1	88,2 Mc/s	88,2 Mc/s	Max.	S5	
			102,6 Mc/s	102,6 Mc/s	Max.	C11	
			95 Mc/s	95 Mc/s	Max.	S5	
			Repeat				

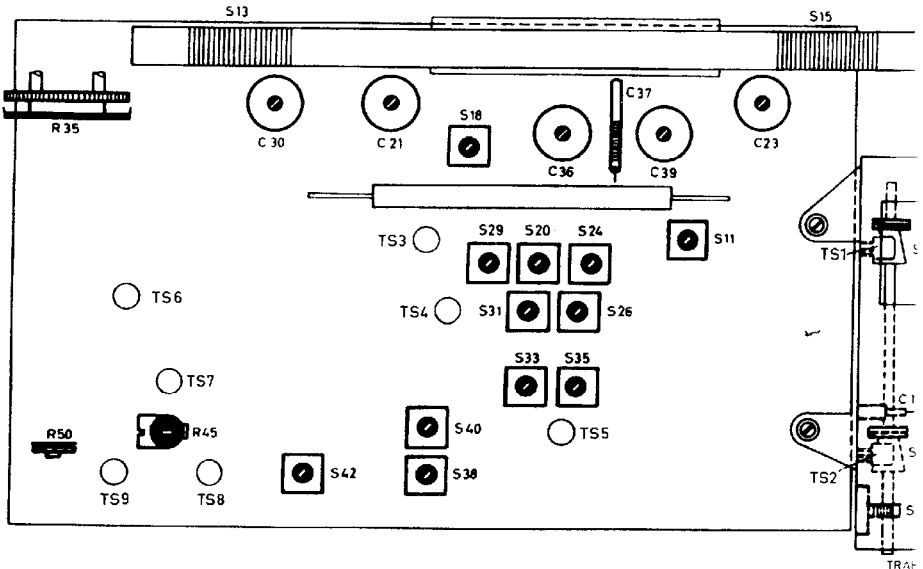

S		A.	46	B.	C.	D.	E.	F.	G.	H.	K.L.									
C		76	23	73	24	41	38	42	46	37	47	31	48	55	22	21	42	68	75	61
						39	33	43			36	32				44	20	65	56	
R			15			14	25				22	53	24	13	16	30	12	26		11
			23																	

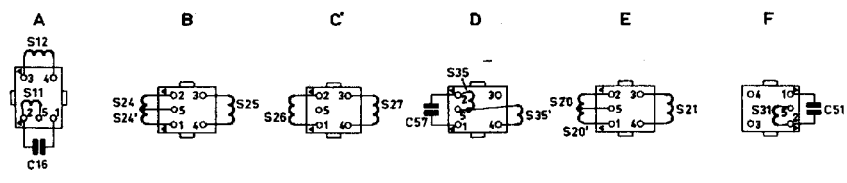
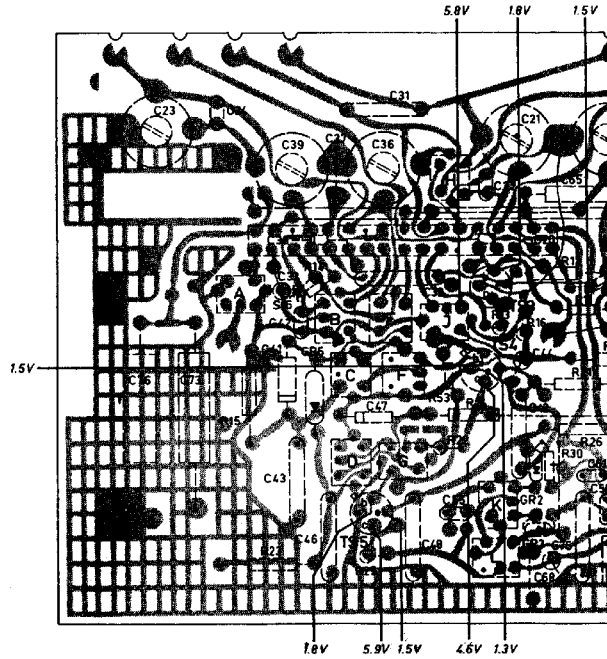

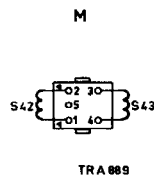
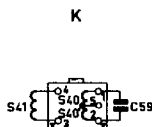
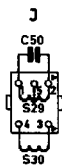
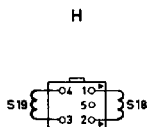
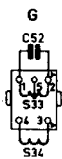
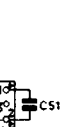
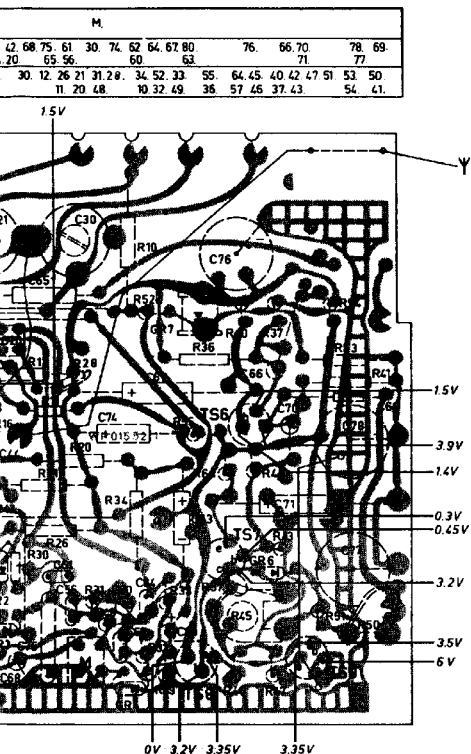

S	1.2.6.7.	4	3.5.
C	1.8.7.14.9.11.10.2.3.4.12.15.	5.6.	
R	1.2.1.6.5.	7	

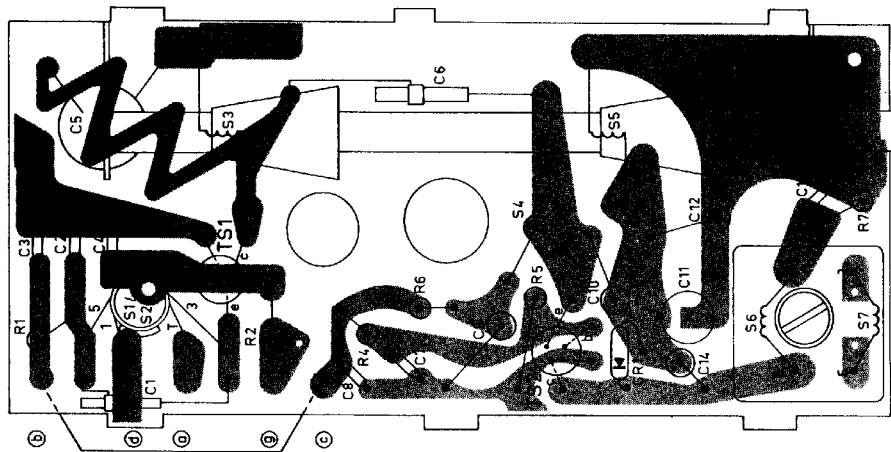

TRA 890

S	3.5.	4	12.6.7.
C	6	5	15.12.2.3.4.10.11.9.14.7.8.1.
R	7.	5.6.1.2.4.	

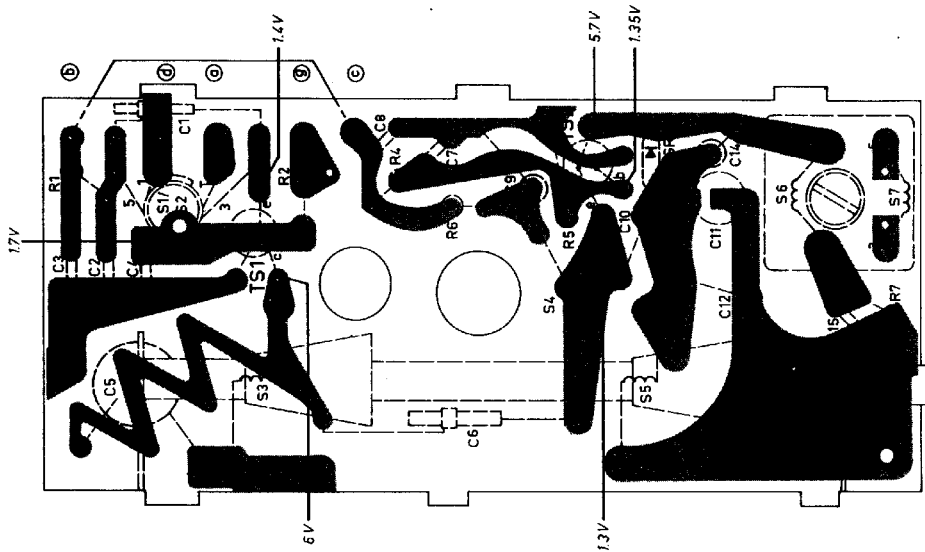

TRA 891

L2X42T/52L/52R/00L/00R

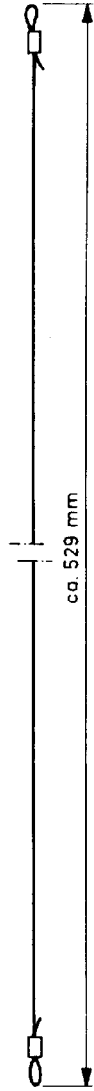
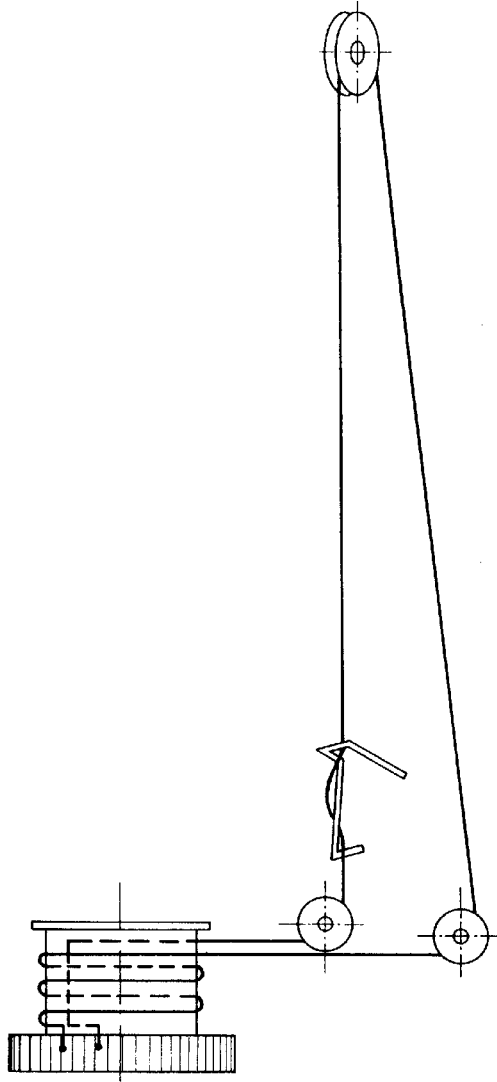
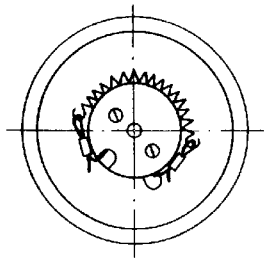

TRA 893

S	1	2	3	4	18	15	13	16	14	19	5	6	7	11	12	13	14	20	21	20	29	30	25	24	35	33	26	34	27	31	38	39	40	38	42	41	40	43				
R	1	2	3	4	6	4	5	10	7	11	12	13	14	15	16	17	18	19	20	21	22	23	15	24	16	26	25	20	30	31	32	33	34	35	36	37	38	39	40	41	42	43
C	81	1	2	3	4	19	5	25	6	9	20	23	22	8	7	11	12	14	15	16	32	33	30	37	45	26	53	39	52	42	47	41	43	44	51	48	58	68	55	80	74	

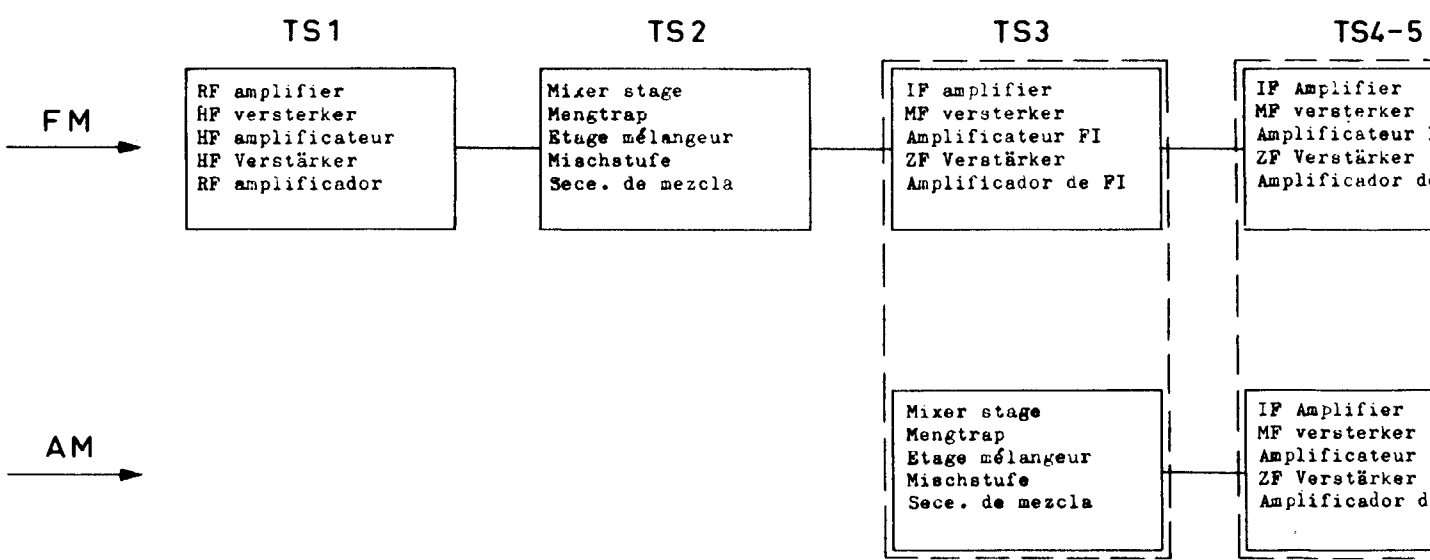
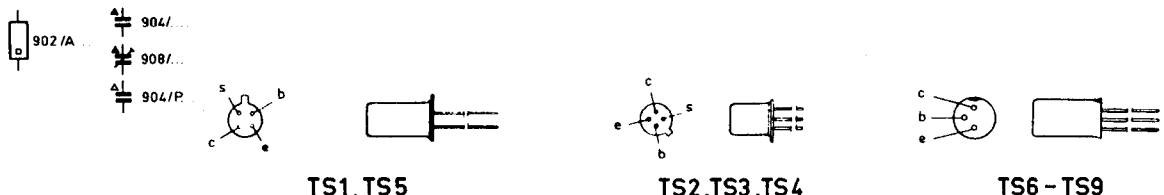
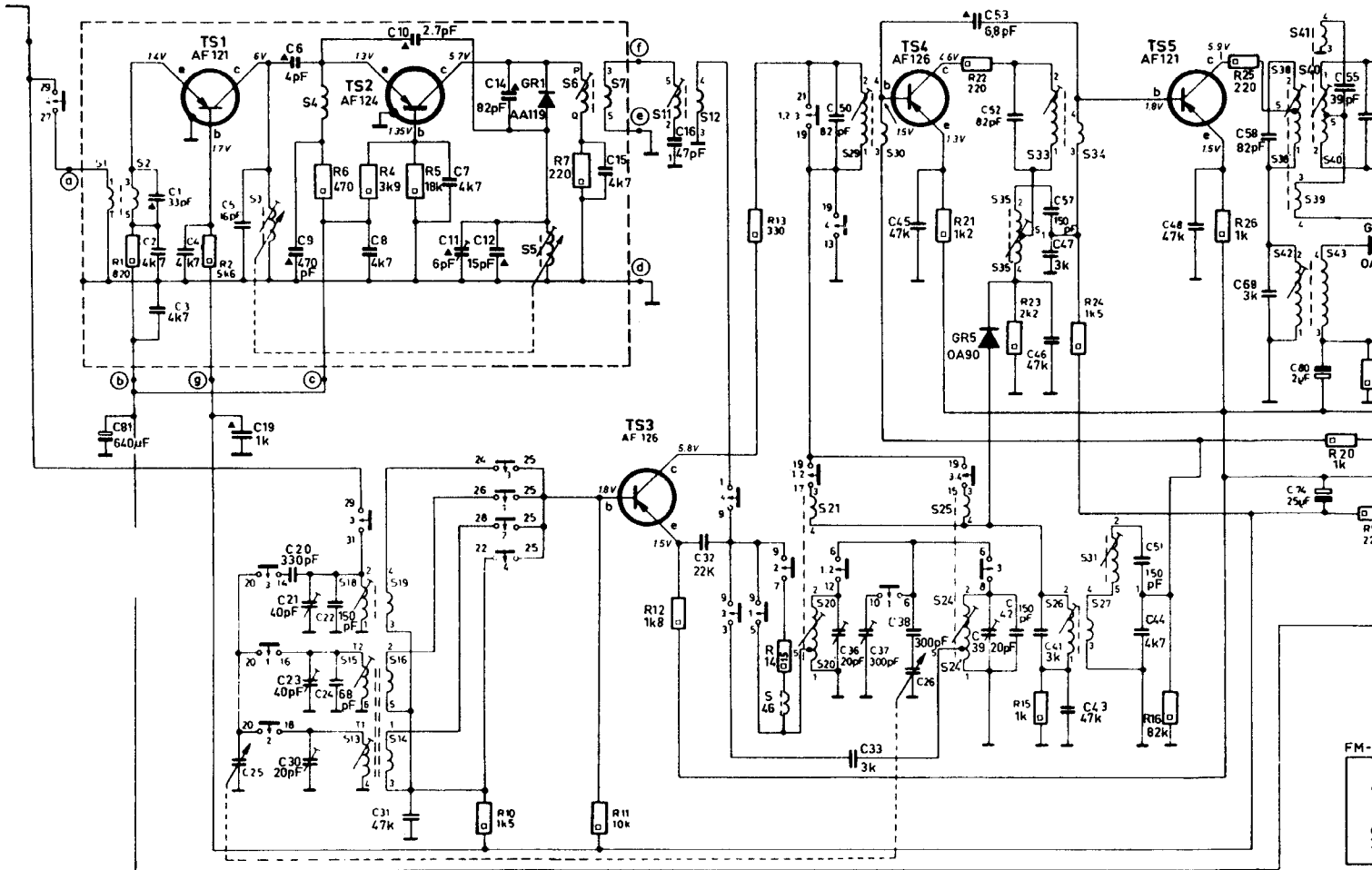

38	39	40																	45	S											
38	42	41	40	43		20	30	49	5248	53	32	31	33	2854	36	35	37		4041	55	42	44		45	43	57	51	46	50	56	R
68	55	80	74	59	62	61	75	56	63	64	76	60	66	77	65	78	67	69	70	71	73		79							72	C

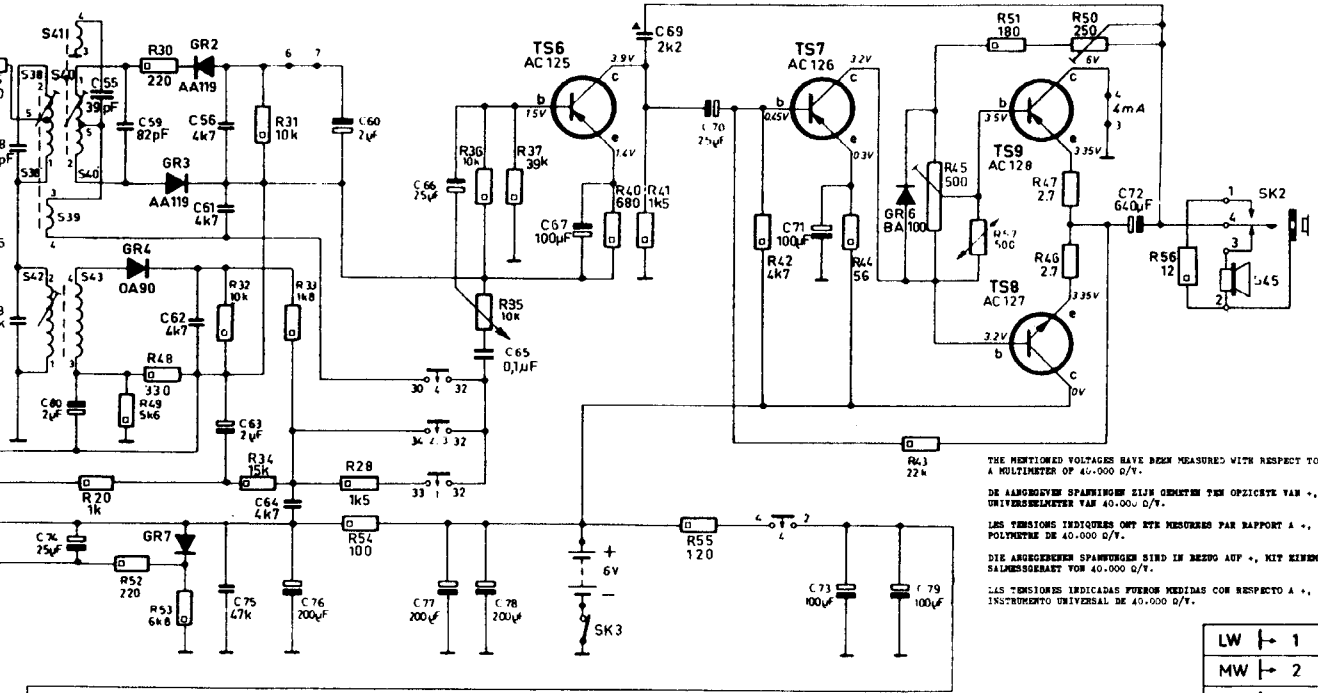

THE MENTIONED VOLTAGES HAVE BEEN MEASURED WITH RESPECT TO +, WITH A MULTIMETER OF 40.000 Ω/V.

DE AANGEGEVEN SPANNINGEN ZIJN GEMETEN TEN OPZICHT VAN +, MET EEN UNIVERSALMETER VAN 40.000 Ω/V.

LES TENSIONES INDICADAS SON EN REFERENCIA A +, CON UN POLIMETER DE 40.000 Ω/V.

DIE ANGEZEIGTEN SPANNUNGEN SIND IN BEZUG AUF +, MIT EINEM UNIVERSALMESSGERÄT VON 40.000 Ω/V.

LAS TENSIONES INDICADAS FUERON MEDIDAS CON RESPECTO A +, CON UN INSTRUMENTO UNIVERSAL DE 40.000 Ω/V.

LW	←	1
MW	←	2
SW	←	3
FM	←	4

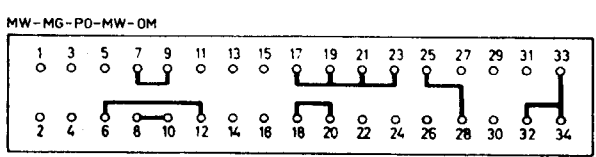
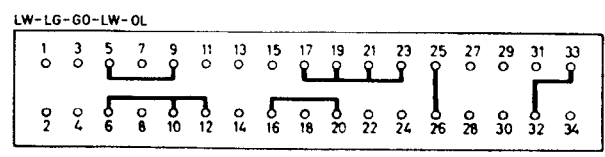
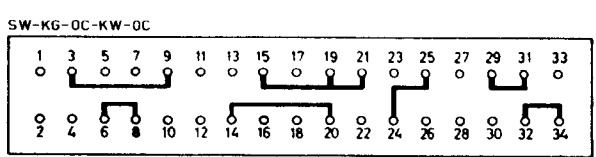
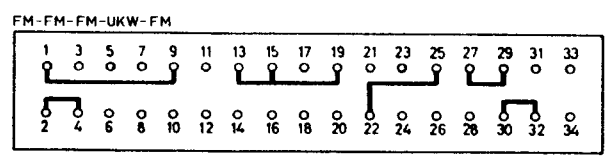

TRA886

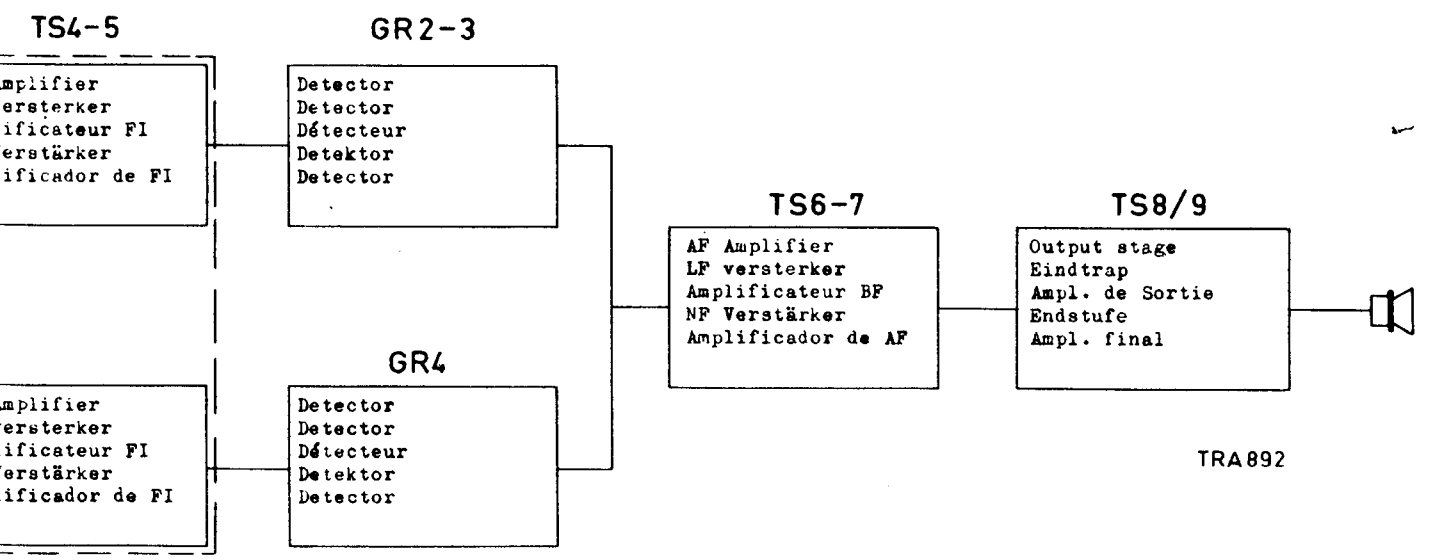

TRA892

S	45									13
C		72	69 77	70 66	76	63 80	64 60			14
R		56	35 41	78 53	54	47 37	40 64	46 55	33 32	34 48
			50	51		43 42	57 45	36	49 52	10 31

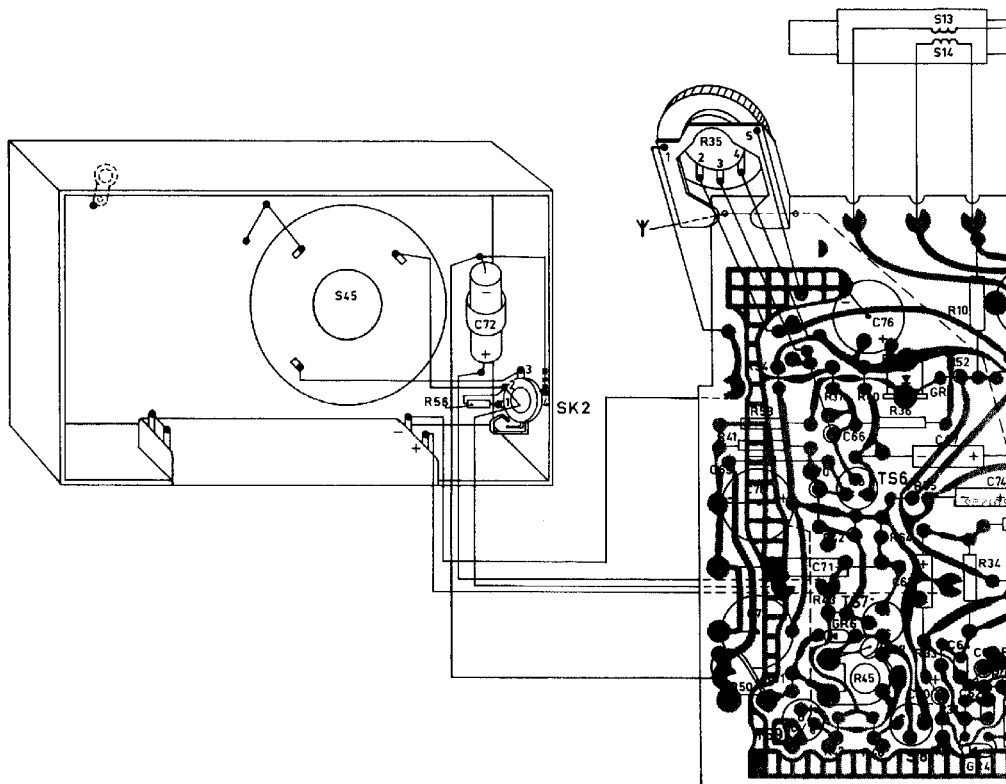

	M	K L H I G F E D C B										46	A			15
64 60	30 61 65 68 20	44 22	55 32	48 31	47 37	46	38 43	24 73	23 79	25						
52 74	55 75	45		36		33 39	42 41			26	19	81				
32 34 48 20	28 21 12	16 13	24 53		25 14		23 15									
52 10 31	11 26 30		22													

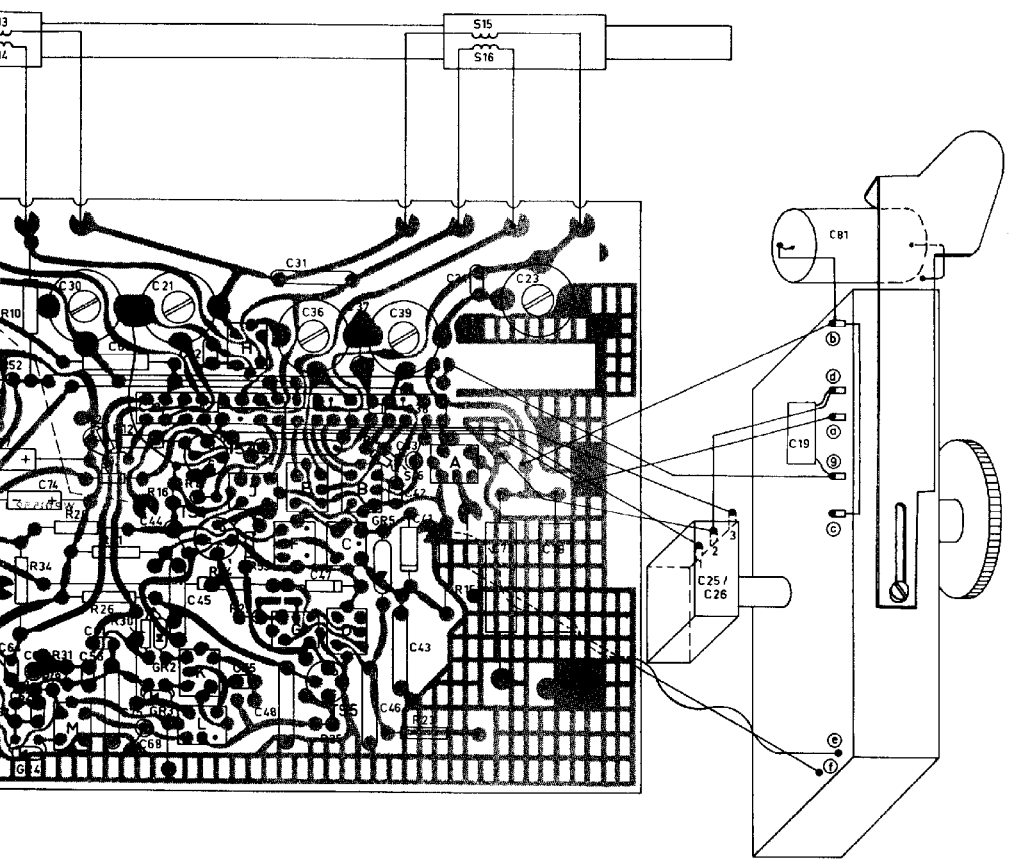

TRA 888