

**PHILIPS**

*Service*

**RADIO**

**L3X09T**

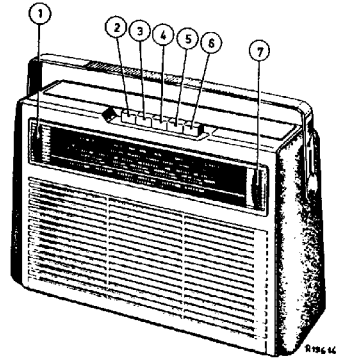

Controls

Volume control  
Battery switch  
Tone control  
S.W.1 switch  
S.W.2 switch  
M.W. switch  
Tuning

Bediening

1 Volumeregelaar  
2 Batterijschakelaar  
3 Toonregeling  
4 K.G.1 schakelaar  
5 K.G.2 schakelaar  
6 M.G. schakelaar  
7 Afstemming

Bedienung

Lautstärkereglér  
Batterie Schalter  
Klangregler  
K.W.1 Schalter  
K.W.2 Schalter  
N.W. Schalter  
Abstimmung

Comande

Contrôle de volume  
Comm. de batterie  
Contrôle de tonalité  
Comm. O.C.1  
Comm. O.C.2  
Comm. P.O.  
Syntonisation

Organes de mando

1 Control de volumen  
2 Comm. para pila  
3 Regulador de tono  
4 Comm. de O.C.1  
5 Comm. de O.C.2  
6 Comm. de O.L.  
7 Sintonia

Specification

Loudspeaker  
I.F.  
Battery  
Consumption  
(without signal)  
Dimensions

AD 3414 Z  
452 kc/s  
6V-(4x1,5V)  
17 mA  
306,5x187x94mm  
12"x7½"x3½"

Specificatie

Luidspreker  
M.F.  
Batterijspanning  
Verbruik  
(zonder signaal)  
Afmetingen

Spezifikation

Lautsprecher  
Z.F.  
Batteriespannung  
Verbrauch  
(ohne Signal)  
Abmessungen

Specification

Haut-parleur  
M.P.  
Tens.de batterie  
Consumation  
(sans signal)  
Dimensions

AD 3414 Z  
452 kc/s  
6V-(4x1,5V)  
17 mA  
306,5x187x94mm  
12"x7½"x3½"

Specificación

Altavoz  
F.I.  
Tens. de pila  
Consuma  
(sin señal)  
Dimensiones

Wave ranges - Golfbereiken - Wellenbereiche - Gammes d'ondes - Kargen de ondas

S.W.1 - K.G.1 - K.W.1 - O.C.1 - O.C.1 : 16,5 - 50,8 m (18,1 - 5,9 Mc/s)  
S.W.2 - K.G.2 - K.W.2 - O.C.2 - O.C.2 : 57 - 180 m ( 5,2 - 1,62 Mc/s)  
M.W. - M.G. - M.W. - P.O. - O.N. : 185 - 580 m (1622 - 517 kc/s)

Transistors - Transistoren  
Transistoren - Transistors  
Transistores

OC170-OC45-OC45-0A79  
0A79-0C71-0C71-2X0C72

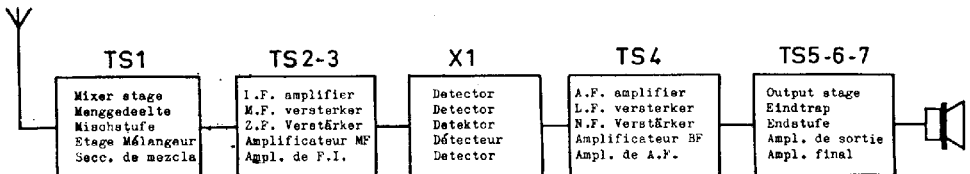

SERVICE INFORMATION									
---------------------	--	--	--	--	--	--	--	--	--

Serv-O-Meum E-a-1	Pushbutton Druktoets Taste Touche poussoire Pulsador	Tuning capacitor Afstem condensator Drehkondensatoren Cond. variable Cond. variable	Signal Signaal Signal Signal Señal	Adjust to max. output Afregelen op max. uitgangsspanning Abgleichen auf max. Ausgangsspannung Régler au max. de sortie Ajustense al max. de salida
I.F.-M.F.-Z.F.-M.F.-F.I.	4	min.	451 kc/s coll. ts. 1 453 kc/s coll. ts. 1 452 kc/s via 0,1 MΩ coll.ts.1	S20, S21 S18, S19 S16, S17

The signals are applied by means of a couple winding.  
 De signalen worden door middel van een koppelwinding toegevoerd.  
 Die Signale werden mittels einer Kopplungswicklung zugeführt.  
 Les signaux sont appliqués au moyen d'un enroulement de couplage.  
 Los senales se aplican por medio de un arrollamiento de acoplo.

R.F. circuits	5	max.	512 kc/s	S13, S14, S15
		min.	1625 kc/s	C14
H.F. kringen	5	550 kc/s	550 kc/s	S5, S6
		1500 kc/s	1500 kc/s	C5
H.F. Kreise	4	max.	1,61 Mc/s	S10, S11, S12
		min.	5,25 Mc/s	C12
Circuits H.F.	4	1,74 Mc/s	1,74 Mc/s	S3, S4
		4,8 Mc/s	4,8 Mc/s	C4
Circuitos de R.F.	3	max.	5,85 Mc/s	S7, S8, S9
		min.	18,2 Mc/s	C8
		6,35 Mc/s	6,35 Mc/s	S2, S2a
		16,9 Mc/s	16,9 Mc/s	C3

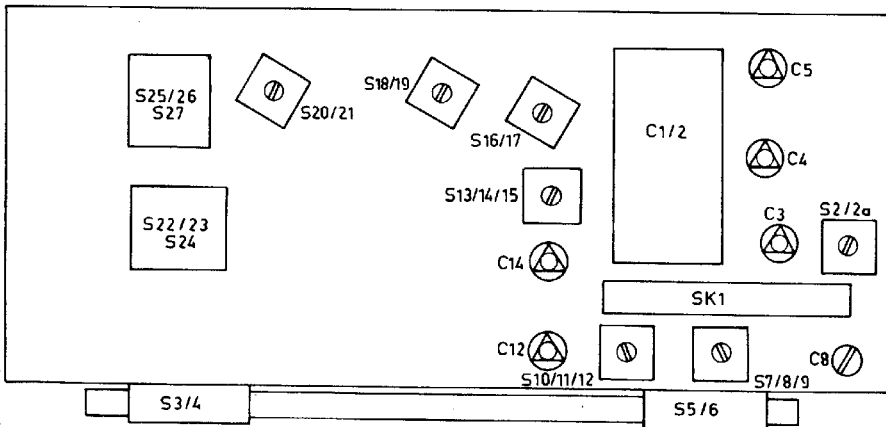



L3X09T

19	20	20a	21																22	23	24					25	26	27	28
21	22	23	24	41	42	37	25	26	27	31	28				29				30										
7	9	8	30		10	11	12	13	14	15	16	17	18	19	20	23	21	22	24	25	26								

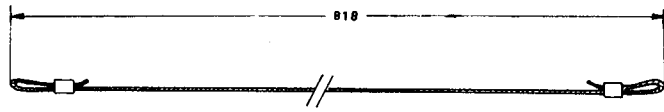
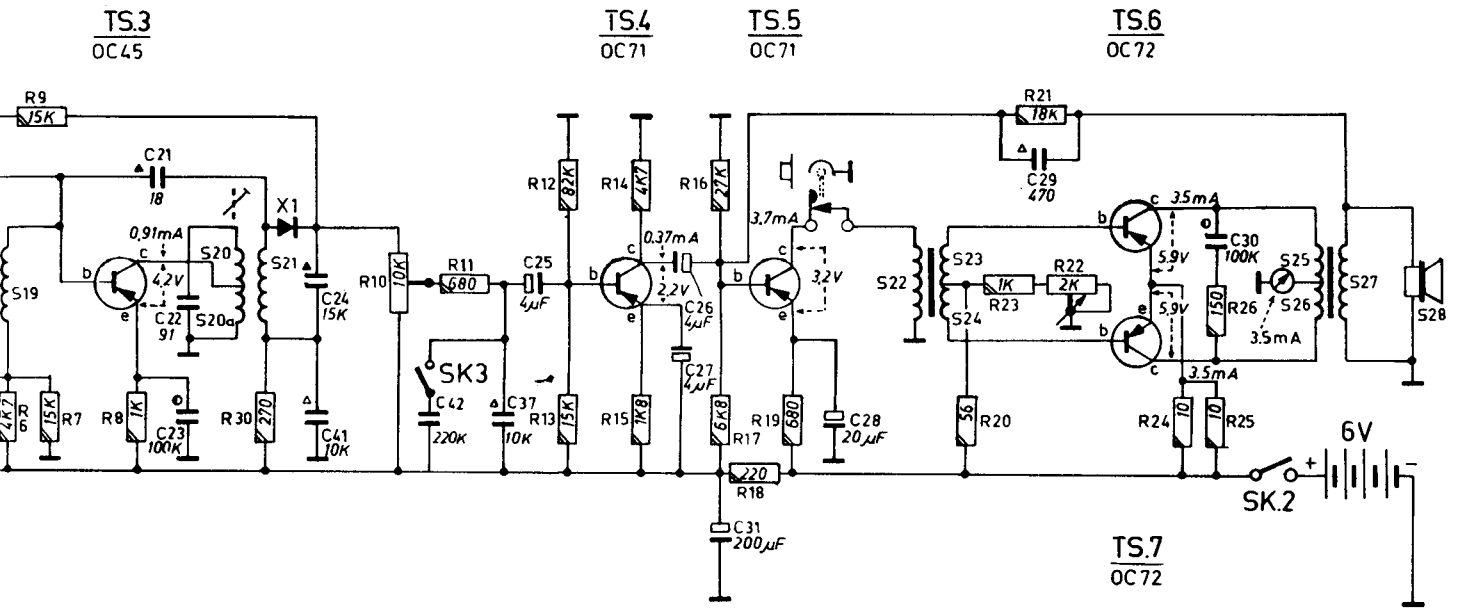

R195 99

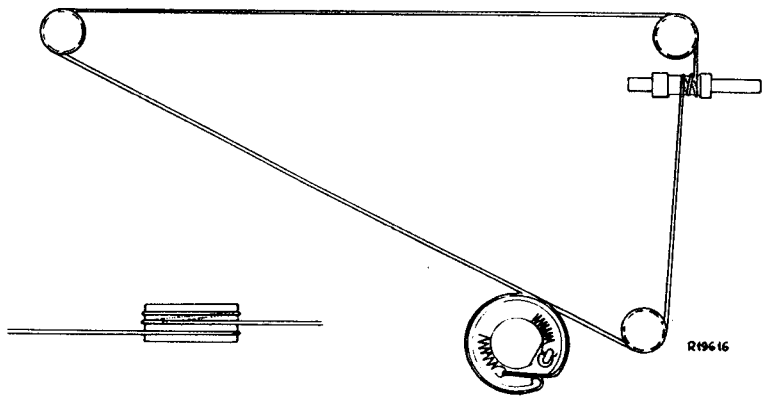

R196.16

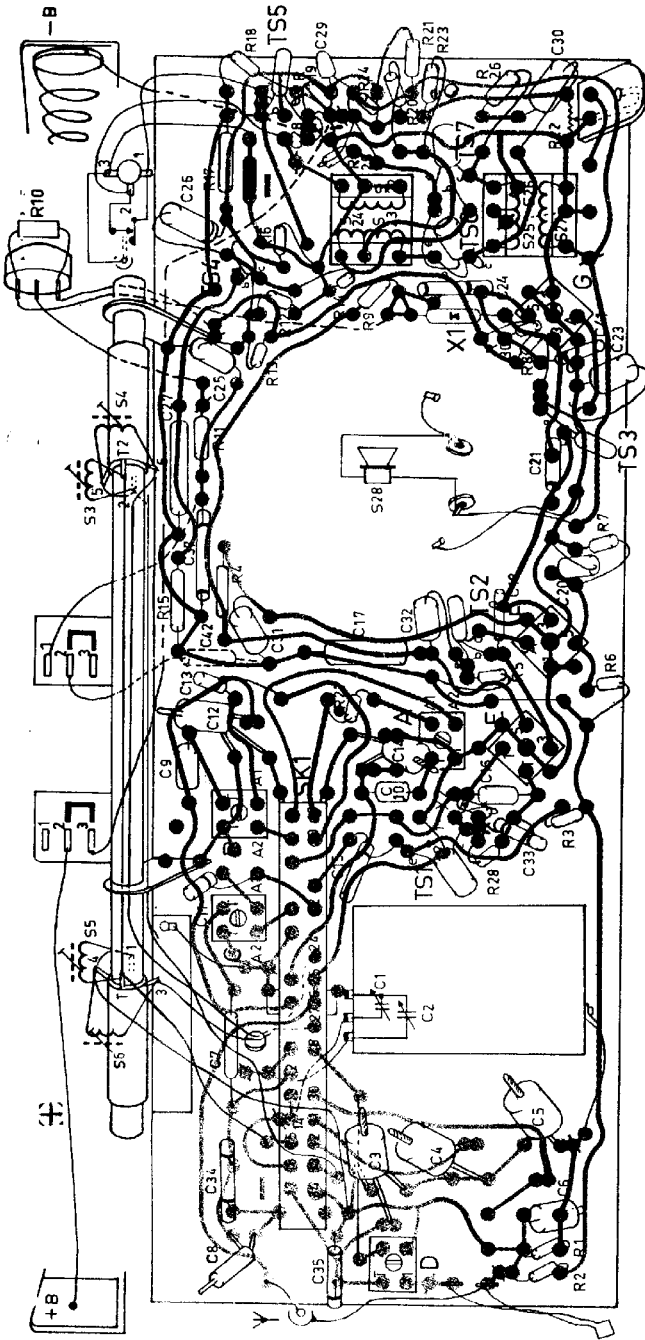

R196 00

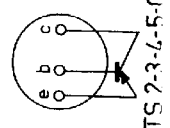
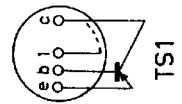
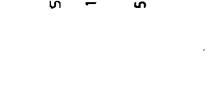
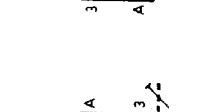
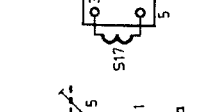
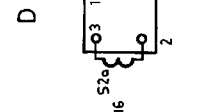
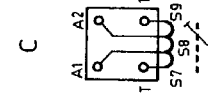
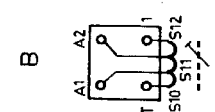
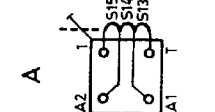

Cabinet	A3 961 45	Kast	Coffret	Gehäuse	A3 961 45	Mueble	A3 961 45
Front	A3 756 84	Front	Front	Front	A3 756 84	Fronte	A3 756 84
Rear cover	P5 450 37/423/PC	Achterwand	Couvercle arriere	Rückwand	P5 450 37/423/PC	Cubierta	P5 450 37/423/PC
Handle	A3 311 10	Handvat	Poignée	Handgriff	A3 311 10	Asa	A3 311 10
Battery holder	A3 786 97	Batteryholder	Porte-pile	Batterieshalter	A3 786 97	Portapila	A3 786 97
Socket plate for carburene plug	A3 966 21	Coulersefoon aansluiting	Fiche femelle casque teleph.	Kontrastecker Kopf-Höhrer	A3 966 21	Casaca de Hembra casaco telefonico	A3 966 21
Bracket for aerial plug	A3 966 41	Bougel voor antenne aansluiting	Support pour fiche femelle antenne	Bügel für Kontrastecker	A3 966 41	Abrazadera para clavija hembra antena	A3 966 41
Screw for fixing handle	A3 714 72	Schroef bev. handvat	Vis de fix. poignée	Schraube Bef. Handgriff	A3 714 72	Tornillo fij. asa	A3 714 72
Slide cover battery holder	P5 411 87/423/PC	Schifdeksel batterijhouder	Coullisse de couvercle porte-pile	Schiebedeckel - Batteriehalter	P5 411 87/423/PC	Corredora portapila	P5 411 87/423/PC
Side wall left	A3 796 20	Zijwand links	Paroi latérale gauche	Seitenwand links	A3 796 20	Costado izquierdo	A3 796 20
Side wall right	A3 796 21	Zijwand rechts	Paroi latérale droite	Seitenwand rechts	A3 796 21	Costado derecho	A3 796 21
Wheel in driving	P4 362 07/799	Wiel in aandrijving	Roue dans transmission	Rad in Antrieb	P4 362 07/799	Rueda en transmisión	P4 362 07/799
Knob	P4 078 22/801/MN	Knop	Bouton	Knopf	P4 078 22/801/MN	Béton	P4 078 22/801/MN
Slide for pushbutton	A3 294 09	Schif voor drukknop	Coullisse de bouton-poussoir	Schiebe für Drucktaste	A3 294 09	Festillo de pulsador	A3 294 09
Slide for pushbutton	A3 294 11	Schif voor drukknop	Coullisse de bouton-poussoir	Schiebe für Drucktaste	A3 294 11	Festillo de pulsador	A3 294 11
Slide for pushbutton	A3 294 24	Schif voor drukknop	Coullisse de bouton-poussoir	Schiebe für Drucktaste	A3 294 24	Festillo de pulsador	A3 294 24
Pressure spring	A3 294 25	Drukveer	Ressort de pression	Druckfeder	A3 294 25	Resorte de presión	A3 294 25
Spring	971/117	Veer	Ressort	Feder	971/117	Resorte	971/117
Contact alide	A3 294 28	Contactenschuif	Tiroir	Kontaktschiebe	A3 294 28	Placa deslizable	A3 294 28
Contact spring	971/112	Contactveer	Ressort de contact	Kontaktfeder	971/112	Resorte de contacto	971/112
Contact plate	A3 294 28	Contactplaat	Plaque fixe	Kontaktplatte	A3 294 28	Placa porta contactos	A3 294 28
Contact lip	971/79	Contactlip	Contact pour plaque	Kontaktschuppe	971/79	Contacto fijo	971/79
Leaf spring	A3 294 30	Bladveer	Ressort à lame	Blattfeder	A3 294 30	Resorte de lámina	A3 294 30
Push button	P5 420 49/139/PC	Drukknop	Touche poussoire	Drucktaste	P5 420 49/139/PC	Pulsador	P5 420 49/139/PC
Spring batterie holder	A3 796 27	Veer in batterijholder	Ressort dans porte-pile	Feder in Batterieshalter	A3 796 27	Resorte en portapila	A3 796 27
Dial O.V.	A3 966 71	Schaal O.V.	Cadrán O.V.	Skala O.V.	A3 966 71	Cuadrante O.V.	A3 966 71
S2 } S2a }	A3 987 07	S13 } S14 } S15 }	S22 } S23 } S24 }	A3 162 21	C25 } C26 } C27 }	909/24	
S3 } S4 } S5 } S6 }	A3 986 01	S16 } S17 }	S25 } S26 } S27 }	A3 154 25	C28 } R10 } R22 }	C 426 AM/020 B1 530 32	
S7 } S8 } S9 }	A3 129 81	S18 } S19 } S19 }	C1 } C2 }	49 002 61		B1 514 54	
S10 } S11 } S12 }	A3 129 82	S20 } S20a } S21 } S22 }	C10 }	C 285 AB/D350E			