

PHILIPS Service

RADIO

L4X42T/00/12

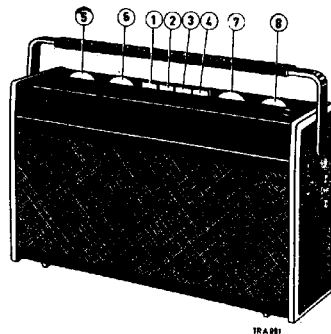

1 Battery switch
Batterijschakelaar
Interrupteur
Batterieschalter
Interruptor

2 FM switch
FM-schakelaar
Commutateur FM
UKW-Schalter
SK2
Commutador de FM

3 MW switch
MG-schakelaar
Commutateur PO
SK3
MW-Schalter
Commutador de OM

4 LW switch
LG-schakelaar
Commutateur GO
SK4
LW-Schalter
Commutador de OL

5 FM tuning
FM-afstemming
Syntonisation FM
Abstimmung UKW
S8-59
Sintonía de FM

6 Volume control
Geluidssterkeregelaar
Contrôle de volume
R32
Lautstärkereglor
Control de volumen

7 Tone control
Toonregeling
Tonalité
R31
Klangregler
Tonalidad

8 AM tuning
AM-afstemming
Syntonisation AM
C3-C35
Abstimmung AM
Sintonía de AM

Loudspeaker	AD3465RX (4 Ω)	Luidspreker	Haut-parleur	Lautsprecher	AD 3465RX (4 Ω)	Altavoz
IF-AM	452 kc/s	MF-AM	FI-AM	ZF-AM	452 kc/s	FI-AM
IF-FM	10,7 Mc/s	MF-FM	FI-FM	ZF-FM	10,7 Mc/s	FI-FM
Battery	6 V (4x1,5 V)	Batterij	Batterie	Batterie	6 V (4x1,5 V)	Bateria
Output	1 W	Uitgangsvermogen	Puissance	Ausgangsleistung	1 W	Potencia de salida
Consumption AM	17,5 mA	Verbruik AM	Consommation AM	Verbrauch AM	17,5 mA	Consumo AM
Consumption FM	21 mA	Verbruik FM	Consommation FM	Verbrauch UKW	21 mA	Consumo FM
Dimensions	290x165x85 mm	Afmetingen	Dimensions	Abmessungen	290x165x85 mm	Dimensiones

Wave ranges - Golfgebieden - Gammas d'ondes - Wellenbereiche - Márgenes de ondas

FM - FM - FM - UKW - FM	:	2,86 - 3,45 m (104 - 87 Mc/s)
MW - MG - PO - MW - OM	:	185 - 578 m (1622 - 520 kc/s)
LW - LG - GO - LW - OL	:	1150 - 2000 m (260 - 150 kc/s)





Resistors

TS1 -	AP121	TS6 -	AC125	GR1 -	AA119
TS2 -	AF125	TS7 -	AC125	GR2 -	BA102
TS3 -	AF126	TS8 -	AC125	GR3 -	
TS4 -	AF126	TS9 -		GR4 -	2x 0A79
TS5 -	AF126	TS10 -	2x AC128	GR5 -	2,15T1

SERVICE INFORMATION										
---------------------	--	--	--	--	--	--	--	--	--	--

Copyright Central Service N.V. PHILIPS' GLOEILAMPENFABRIEKEN, Eindhoven

Confidential information for Philips Service Dealers

Serv-o-meum E-a-1 E-a-2	Wave range Golfgebied Gamme d'onde Wellenbereich Margen de onda	Pointer Wijzer Aiguille Zeiger Aguja		Signal Signal Signal Signal Señal	Adjust Afregelen Régler Abgleichen Ajustense	Indication Aanwijzing Indication Anzeige Indicación
IF circuit MF-kringen Circuits FI (AM) ZF-Kreise Circuitos de FI	MW MG PO MW OM	Min. oap. (185 m)	452 kc/s	via 33000 pF bTS3	S36, S35 S29, S28 S19	Max. Max. Min.
RF circuits HF-kringen Circuits HF (AM) HF-Kreise Circuitos de RF	MW-MG-PO-OM	Max. oap. (578 m)	512 kc/s	Ferroceptor 	S22, S3	Max.
		Min. oap. (185 m)	1630 kc/s		C36, C2	Max.
	LW-LG-QO-OL	200 kc/s (1500 m)	200 kc/s		S17	Max.
		200 kc/s (1500 m)	200 kc/s		S14	Max.
MW-MG-PO-OM	Max. oap. (578 m)	520 kc/s		C30	Max.	
Min. oap. (185 m)	1630 kc/s					
IF circuits MF-kringen Circuits FI (FM) ZF-Kreise Circuitos de FI	FM UKW	Min. ind. (87 Mc/s)	10,7 Mc/s	via 4700 pF 	S32 S26, S20 S11, S10 S33-34	Max. DV ^M Max. DV ^M Max. DV ^M OV DV ^M
RF circuits HF-kringen Circuits HF (FM) HF-Kreise Circuitos de RF	FM UKW	87,5 Mc/s 104 Mc/s 94 Mc/s	87,5 Mc/s 104 Mc/s 94 Mc/s		S8 (S9) ^M C21 ^M S8	Max. Max. Max.

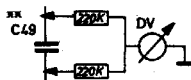
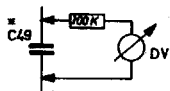

###

- C41 short-circuited
- C41 kortgesloten
- C41 court-circuité
- C41 kurzgeschlossen
- C41 enoorto-circuito

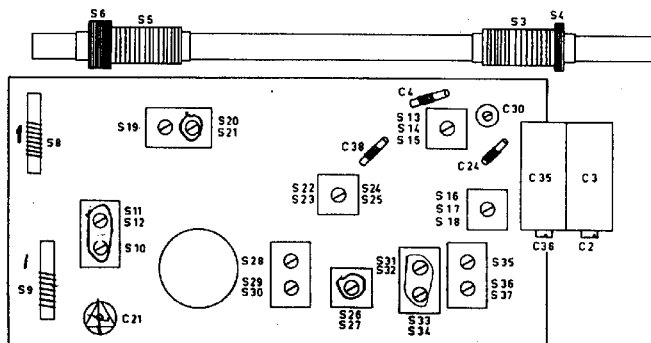

S										45	7	1	2	9	8
C	24 51 28 30 46	53 4 68	38 48 47	39	49	40 13 50 31 26	25	19 29 41 20 16 21 11 9 5 6 6 7 14 22 6 10 12 18	52						
R	25 27	24	22 25	21	30	3 29	19 20 18	28 17 12 15	8 14 10	23	7	13	4 6 1	5 15	2

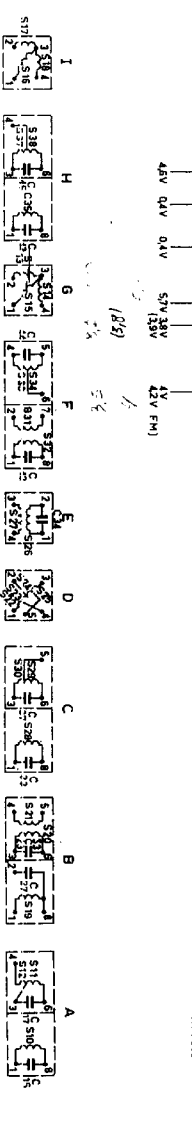
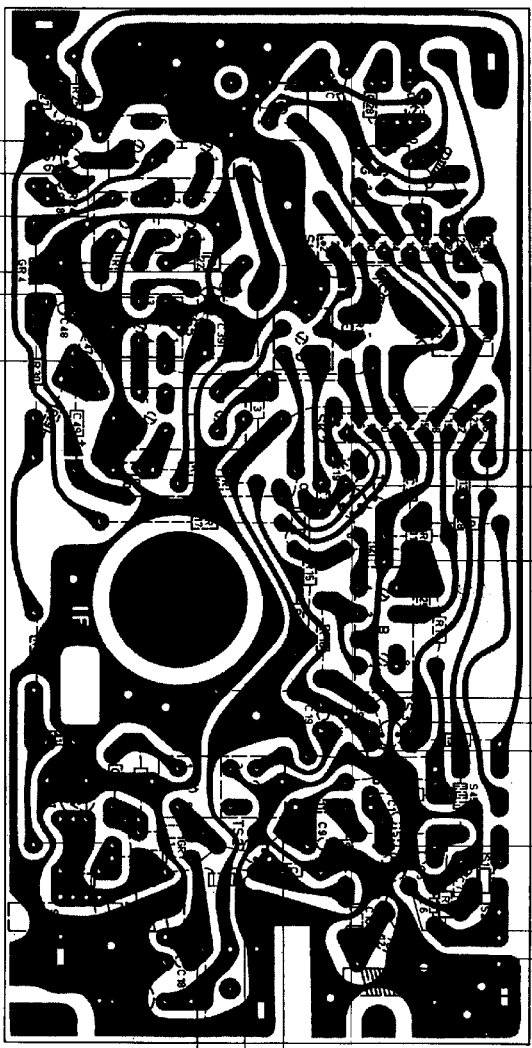

C	43	48	47	46	45	44	43	42	41	40	39	38	37	36	35	34	33	32	31	30	29	28	27	26	25	24	23	22	21	20	19	18	17	16	15	14	13	12	11	10	9	8	7	6	5	4	3	2	1												
	59	54	57	55	53	34	37	36	33	58	67	56	42	61	60	17	38	39	59	62	63	40	39	38	37	36	35	34	33	32	31	30	29	28	27	26	25	24	23	22	21	20	19	18	17	16	15	14	13	12	11	10	9	8	7	6	5	4	3	2	1

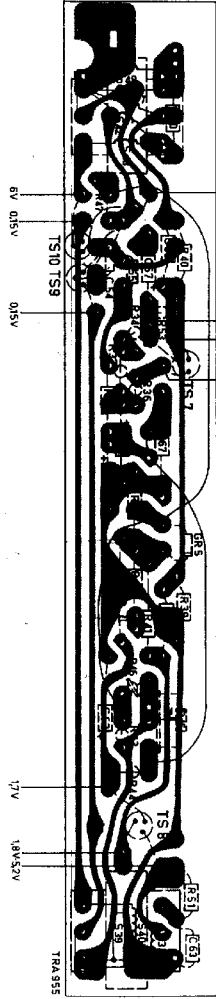

179
56.1

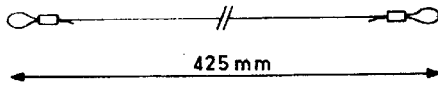
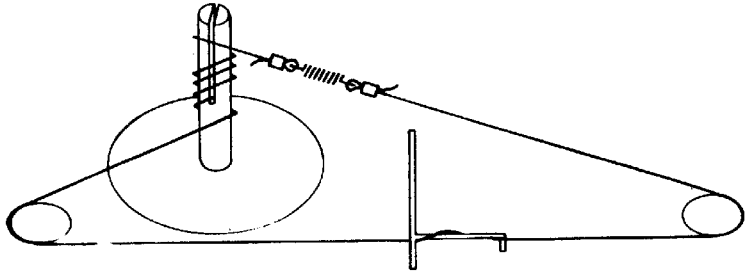

TRA 956

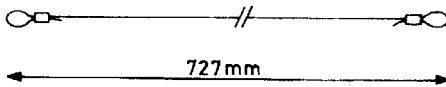
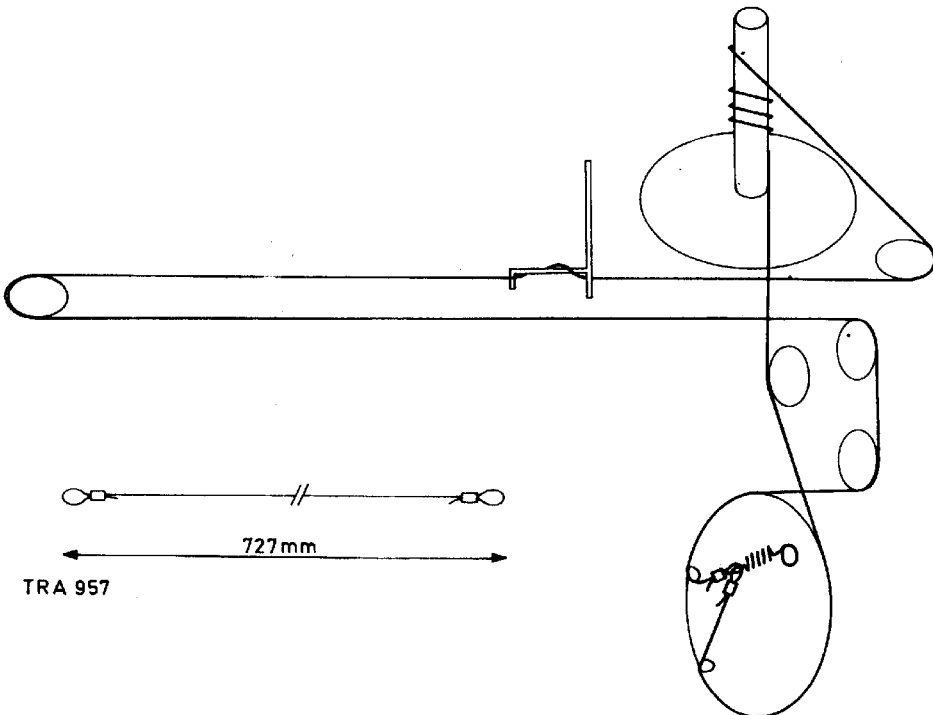

TRA 957

S1	4822 204 00159	Aerial coil Antennespoul Bobine d'antenne Antennaspule Bobina de antena	S19 S20 S21 S22	4822 204 00168	IP coil FM MF-spoul FM Transformateur FI, FM Zf-Spule FM Transformator de FI, FM	S36 S37 S38 S39	4822 204 00175	Driver transformer Injektionstransformator Transformateur de puissance Treiberttransformator Transformator de entrada RF
S2								
S3	4822 204 00161	Ferrocapteur Ferrocapteur Ferrocapteur Ferrocapteur	S22 S23 S24 S25	4822 204 00169	Oscillateur coil, MV-MV Oscillatörspoul, MG-LG Bobine d'oscillateur, PO-00 Oscillatörspule, MV-MV Bobina de oscilador, OM-01	S41 S42 S43	4822 204 00176	Output transformer Uitgangstransformator Transformateur de sortie Ausgangstransformator Transformator de alivoz
S4								
S5								
S6								
S7	4822 204 00162	Absorption coil FM Zulspool FM Bobine d'absorption FM Saugspule FM Bobina de absorbtion	S26 S27 S28 S29	4822 204 00171	IP coil, FM MF-spoul, FM Transformateur FI, FM Zf-Spule, FM Transformator de FI, FM	S45 S46	4822 204 00182	Choke Smootspool Self Drossel Bobina de choque
S8								
S9								
S10	4822 204 00165	TP coil FM MF-spoul FM Transformateur FI, FM Zf-Spule FM Transformator de FI, FM	S28 S29 S30	4822 204 00172	IP coil, AM MF-spoul, AM Transformateur FI, AM Zf-Spule, AM Transformator de FI, AM	S47	4822 182 00173	Aerial coil, FM Antennespoul, FM Bobine d'antenne, FM Antennaspule, FM Bobina de antena, FM
S11								
S12								
S13	4822 204 00166	Aerial coil, MV Antennespoul, MG Bobine d'antenne, PO Antennaspule, MV Bobina de antena, OM	S31 S32 S33 S34 S35	4822 204 00173	Ratiodeflector Ratiodefektor Détecteur de rapport Ratiodefektor Detector de relacion	C2 C3 C5 C36	4822 059 00344	Variable capacitor Afstemningspotentiometer Condensateur variable Drehkondensator Condensator variable
S14								
S15								
S16	4822 204 00167	Aerial coil LM Antennespoul LG Bobine d'antenne OO Antennaspule LM Bobina de antena OL	S35 C43 C44 S37 C45	4822 204 00174	Detector coil, AM Detectörspoul, AM Bobine de detecteur AM Detektorpule AM Bob. de detector AM	R31 R32	4822 071 00735	Potentiometer Potentiometer Potentiometer Potentiometer Potentiometer
S17								
S18								
C1	907/508-175E		C20	909/4100				
C4	81 530 57		C21	C 005 CC/30E				
C5	4822 069 00554		C22	907/508-175E				
C8	81 530 57		C23	4822 069 00532				
C9	81 530 57		C28	4822 069 00535				
C11	C 285 AA/D470E		C29	4822 069 00572				
C13	907/508-175E		C30	908/12E				
C16	4822 069 00535		C31	C 280 AA/P47K				
C18	81 530 57		C36	907/45E-275E				
C19	81 530 57		C39	C 280 AA/P47K				

Cabinet	4822 182 00368	Kaas	Colfrat	Gehäuse	4822 182 00368	Caja
Rear cover	4822 182 00371	Achterwand	Panneau arrière	Rückwand	4822 182 00371	Fondo posterior
Side wall (left)	4822 182 00372	Zijkant (links)	Paroi latérale (gauche)	Seitenwand (links)	4822 182 00372	Lado (izquierdo)
Side wall (right)	4822 182 00373	Zijkant (rechts)	Paroi latérale (droite)	Seitenwand (rechts)	4822 182 00373	Lado (derecho)
Aerial	4822 182 00306	Antenne	Antenne	Antenne	4822 182 00306	Antena
Essential of sockets	4822 182 00369	Profiel voor stekerbussen	Profil pour douilles	Profil für Steckerbuchsen	4822 182 00369	Caja de hembrillas
Handle	4822 182 00374	Handvat	Polgnde	Handgriff	4822 182 00374	Asa
Screw fix. handle	4822 182 00375	Schroef bev. handvat	Vas fix. polgnde	Schraube bef. Handgriff	4822 182 00375	Tornillo fij. asa
Battery cover	4822 182 00376	Batterijdeksel	Couvercle de perre-pile	Batteriedeckel	4822 182 00376	Tapa de portapilas
Locking screw	4822 182 00377	Bevestigingschroef	Vas fix. couvercle	Schraube bef. Deckel	4822 182 00377	Tornillo fij. tapa
Dial background	4822 182 00378	Schaalachtergrond	Fond de cadran	Skaalachtergrond	4822 182 00378	Fondo de cuadrante
Rush button unit	4822 182 00379	Drucktoetsenheid	Bloc à clevier	Drucktasteninheit	4822 182 00379	Unidad de teclas
Rush button	4822 182 00381	Drucktoets	Pouche	Taste	4822 182 00381	Tecla
Knob (AM)	4822 182 00382	Knop (AM)	Bouton (AM)	Knopf (AM)	4822 182 00382	Botón (AM)
Knob (FM)	4822 182 00383	Knop (FM)	Bouton (FM)	Knopf (FM)	4822 182 00383	Botón (FM)
Knob (volume)	4822 182 00384	Knop (geluidssterkte)	Bouton (puissance)	Knopf (Lautstärke)	4822 182 00384	Botón (volumen)
Fullly	4822 182 00185	Snaarwiel	Poulie	Antriebrolle	4822 182 00185	Polea
Drum in driving	4822 182 00385	Snaarwiel	Rambour d'entraînement	Trommel	4822 182 00385	Tambor
Switch SK2	4822 107 00386	Schakelaar SK2	Schaltelaar SK2	Schalter SK2	4822 107 00386	Deslizador SK2
Slide of SK2	4822 107 00389	Schuiif van SK2	Tiroir de SK2	Schieber von SK2	4822 107 00389	Deslizador de SK2
Switch SK3	4822 107 00391	Schakelaar SK3	Commutateur SK3	Schalter SK3	4822 107 00391	Commutador SK3
Slide of SK3	4822 107 00392	Schuiif van SK3	Tiroir de SK3	Schieber von SK3	4822 107 00392	Deslizador de SK3
Switch SK4	4822 107 00393	Schakelaar SK4	Commutateur SK4	Schalter SK4	4822 107 00393	Commutador SK4
Slide of SK4	4822 107 00394	Schuiif van SK4	Tiroir de SK4	Schieber von SK4	4822 107 00394	Deslizador de SK4
Foot strip	4822 182 00388	Voet	Pied	Fuss	4822 182 00388	Pie
Socket aerial with switch	4822 182 00387	Antenna-aansluiting met schakelaar	Douille d'antenne avec commutateur	Antennenanschluss mit Schalter	4822 182 00387	Hembrilla de antena con conmutador
Socket earphone	4822 182 00389	Oortelefoonansluiting	Douille d'écouteur	Ohrphoeranschluss	4822 182 00389	Hembrilla de auricular
Dial	4822 182 00389	Schaal	Cadran	Skaal	4822 182 00389	Cuadrante

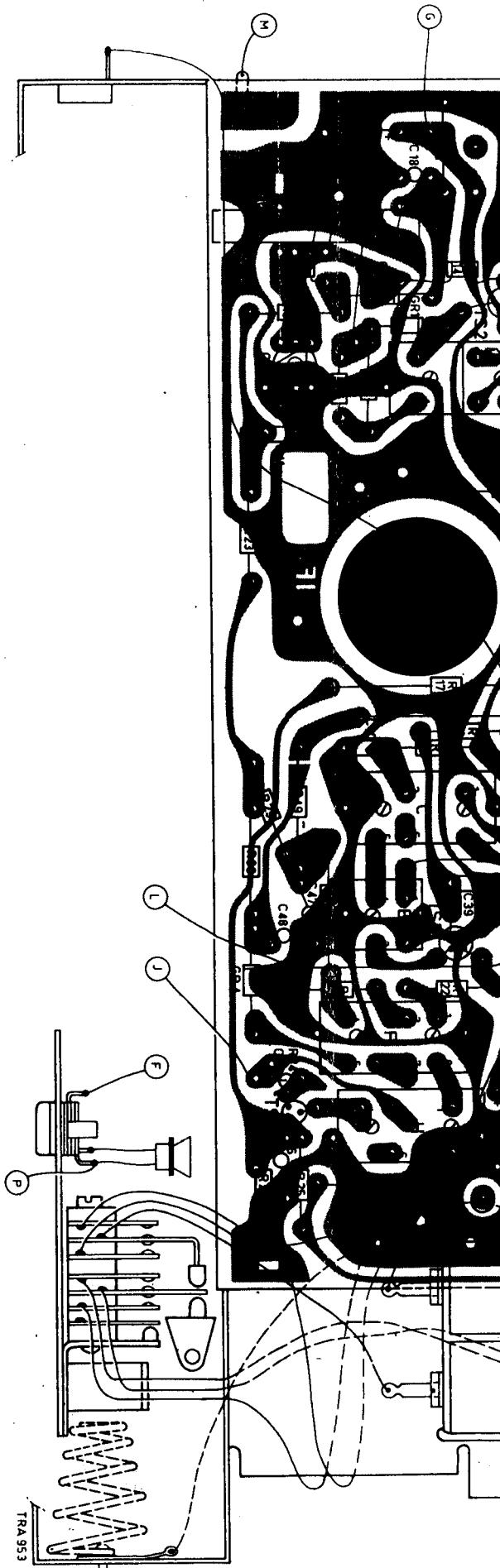

S	38	39	40	62	60	61	42	56	67	58	33	36	37	34	53	55	57	54	59	47	48	42	41	49	43
C	63			44	43	45	46																		
R	51																								

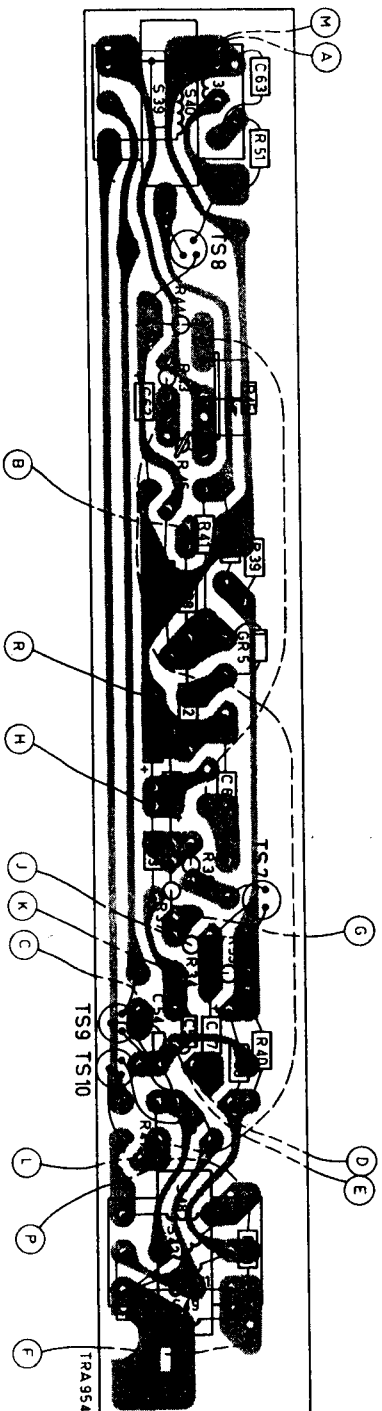

22	23	24	25	31	32	35	33	34	36	37	38	39	40	41	42	43	48	49													
26	31	40	43	42	36	39	35	38	44	45	47	48	68	49	46	54	50	55	56	57	58	20	60	67	61	58	63	62	52	53	
20	18	22	21	25	24	27	29	30	23	17	31	33	28	32	34	35	36	37	39	38	41	42	43	40	44	45	46	51	47	3	50

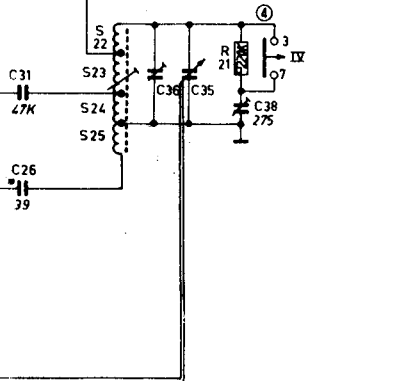
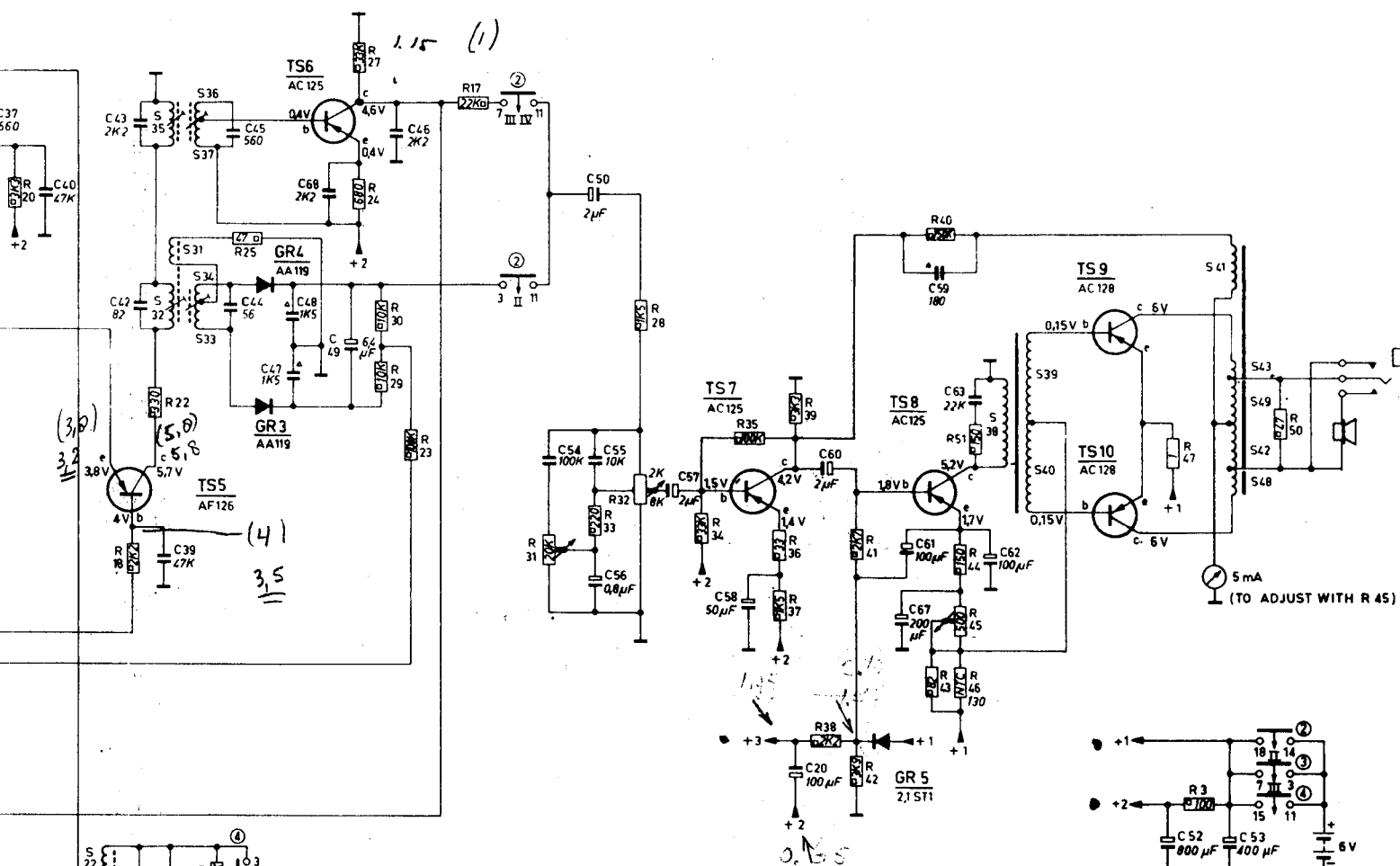

② SK 2	③ SK 3	④ SK 4
II = FM UKW	III = MW MG PO OM	IV = LW LG GO OL

- 902/A...
- 904/I...
- 904/P...
- 905/D...

S	46	47	1	2	45	13	16	14	15	17	18	8	7	10	11	12	3	5	9	4	6	20	19	21	26	28	29	30	27	22	23	24	25								
C	32	5	6	7	30	1	12	24	10	28	3	66	11	2	9	15	16	14	4	8	17	18	21	22	19	29	41	13	51	23	27	25	34	33	37	26	31	40	43	42	
R	2			1					5	4			6						9			16			7	8	13	26	10	11	14	12			15	19		20		18	21

35 < 4
3.4 < 3.8

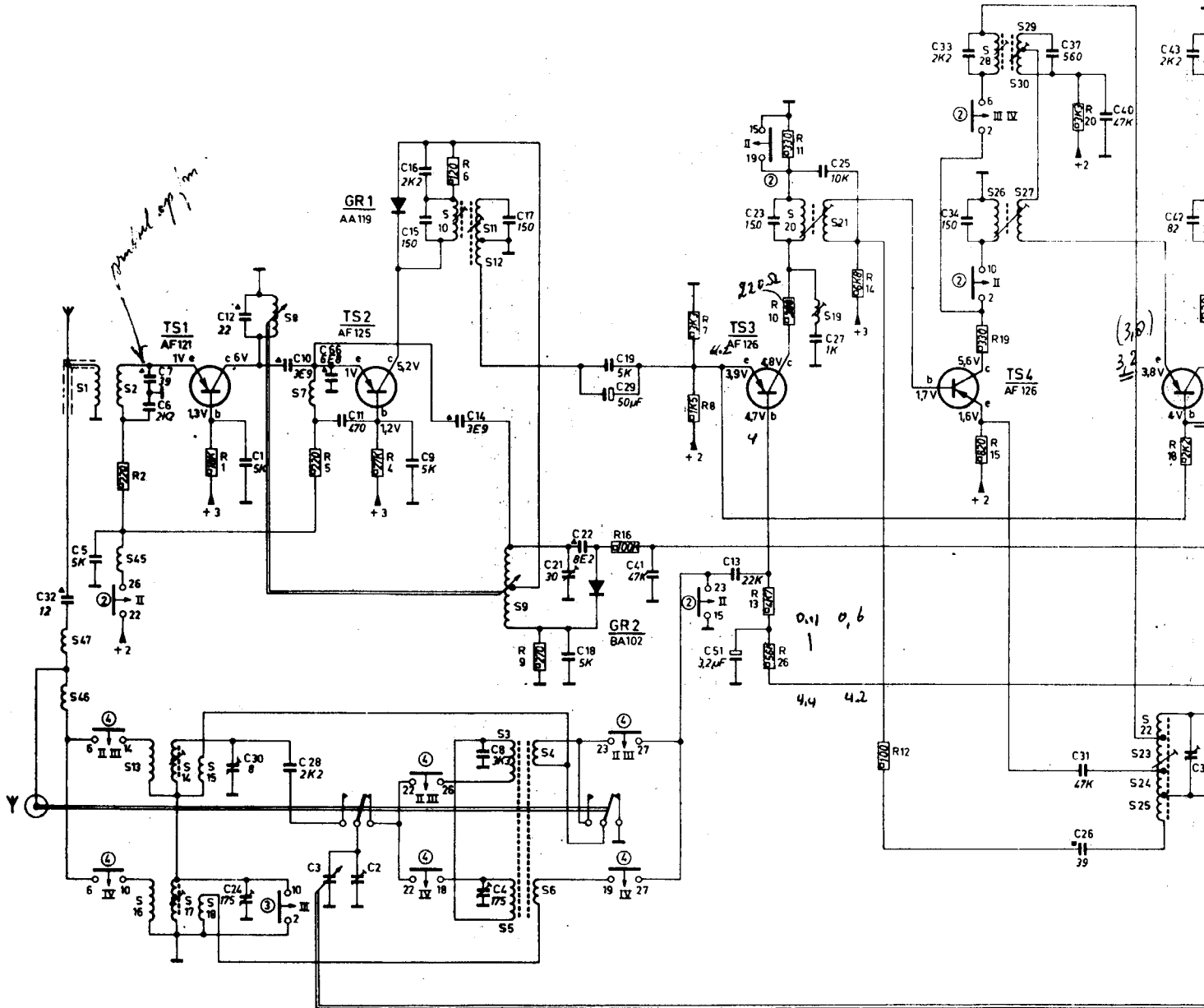

Order 4-6-63

PHILIPS Service

RADIO

L4X42T/13/52

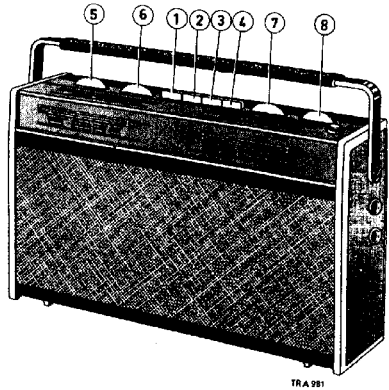

TRA 981



- 1** Battery switch
Batterijschakelaar
Interrupteur
Batterieschalter
Interruptor
- 2** FM switch
FM-schakelaar
Commutateur FM
UKW-Schalter
Commutador de FM
- 3** MW switch
MG-schakelaar
Commutateur PO
SK3 MW-Schalter
Commutador de OM

- 4** LW switch
LG-schakelaar
Commutateur GO
LW-Schalter
SK4 Commutador de GL
- 5** FM tuning
FM-afstemming
Sintonisation FM
SK2-S9 Abtimmung UKW
Sintonía de FM
- 6** Volume control
Geluidsterkteregelaar
Contrôle de volume
R32 Lautstärkereglér
Control de volumen

- 7** Tone control
Toonregeling
Tonalité
Klangregler
R31 Tonalidad
- 8** AM tuning
AM-afstemming
Sintonisation AM
SK3-C35 Abtimmung AM
Sintonía de AM

	AD 3465 RX (4 Ω)	Luidspreker	Haut-parleur	Lautsprecher	AD 3465 RX (4 Ω)	Altavoz
IF-AM	452 kHz	MF-AM	FI-AM	ZF-AM	452 kHz	FI-AM
IF-FM	10,7 MHz	MF-FM	FI-FM	ZF-FM	10,7 MHz	FI-FM
Battery	6 V (4x1,5 V)	Batterij	Batterie	Batterie	6 V (4x1,5 V)	Batería
Output	1 W	Uitgangsvermogen	Puissance	Ausgangsleistung	1 W	Potencia de salida
Consumption AM	17,5 mA	Verbruik AM	Consumption AM	Verbrauch AM	17,5 mA	Consumo AM
Consumption FM	21 mA	Verbruik FM	Consumption FM	Verbrauch UKW	21 mA	Consumo FM
Dimensions	290x165x85 mm	Afmetingen	Dimensions	Abmessungen	290x165x85 mm	Dimensiones

WAVE RANGES - GOLFGEBIEDEN - GAMMES D'ONDES - WELLENBEREICHE - MARGENES DE ONDAS

FM - FM - FM - UKW - FM	± 2,78 - 3,45 m	(108 - 87 MHz)
MW - MG - PO - MW - OM	± 185 - 578	m (1622 - 520 kHz)
LW - LG - GO - LW - OL	± 1150 - 2000	m (260 - 150 kHz)

*gewicht br. 2
netto 2*

TRANSISTORS



TS1 - AF121	TS6 - AC125
TS2 - AF125	TS7 - AC125
TS3 - AF126	TS8 - AC125
TS4 - AF126	TS9)
TS5 - AF126	TS10) - 2xAC126

DIODES

GR1 - AA119
GR2 - BA102
GR3) - 2xAA119
GR4
GR5 - 2,1ST1

2 = 2x 119 gr

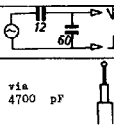
SERVICE INFORMATION										
---------------------	--	--	--	--	--	--	--	--	--	--

Serv-o-Mecum E-a-1 E-a-2	Wave range Golffebied Gamme Wellenbereich Mangen de ondas	Pointer Wijzer Aiguille Zeiger Aguja	Signal Signaal Signal Signal Señal	Adjust Afregelen Régler Abgleichen Ajuste	Indication Aanwijzing Indication Anzeige Indicación
IF circuits MF-kringen Circuits FI (AM) ZF-Kreise Circuitos de FI	MW-MG-PO-OM	Min. cap. (185 m)	452 kHz	via 55000 pF S7e3	S36, S35 S29, S28 S19 Max. Max. Min.
HF circuits HF-kringen Circuits HF (AM) HF-Kreise Circuitos de HF	MW-MG-PO-OM	Max. cap. (578 m) Min. cap. (185 m)	512 kHz 1630 kHz	Ferroceptor 	S22, S3 C36, C2 C38, S5 Max. Max. Max.
	LW-LG-GO-OL	200 kHz (1500m) 200 kHz (1500m)	200 kHz 200 kHz		S17 Max.
	MW-MG-PO-OM	Max. cap. (578 m) Min. cap. (185 m)	520 kHz 1630 kHz		S14 C30 Max. Max.
IF circuits MF-kringen Circuits FI (FM) ZF-Kreise Circuitos de FI	FM-UKW	Min. ind. (87 MHz)	10,7 MHz	via 4700 pF 	S32 S26, S20 S11, S10 S33, 34 Max. DV ^x Max. DV ^x Max. DV ^x OV DV ^{xx}
FR circuits HF-kringen Circuits HF (FM) HF-Kreise Circuitos de HF	FM-UKW	89 MHz 104 MHz 100 MHz	89 MHz 104 MHz 100 MHz		S9 ^{xxx} C21 ^{xxx} S8 Max. Max. Max.

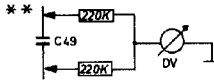
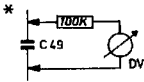

*** C41 short-circuited
C41 kortgesloten
C41 court-circuité
C41 kurzgeschlossen
C41 an cortado-circuito

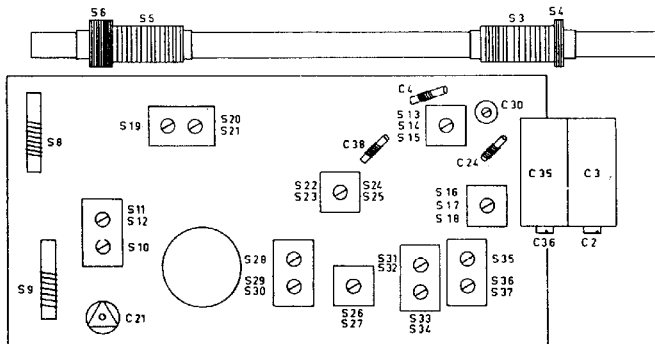

S	6	5	8	9	1	2	7	45	A	B	C	47	46	D	E	50	F	G	H	I	3	4
C	52	18	12	10	6	22	7	14	5	66	9	11	20	16	7	20	16	7	20	16	7	20
R	9	16	5	1	4	6	13	1	32	23	10	14	B	15	12	11	20	18	20	19	29	3
R																						

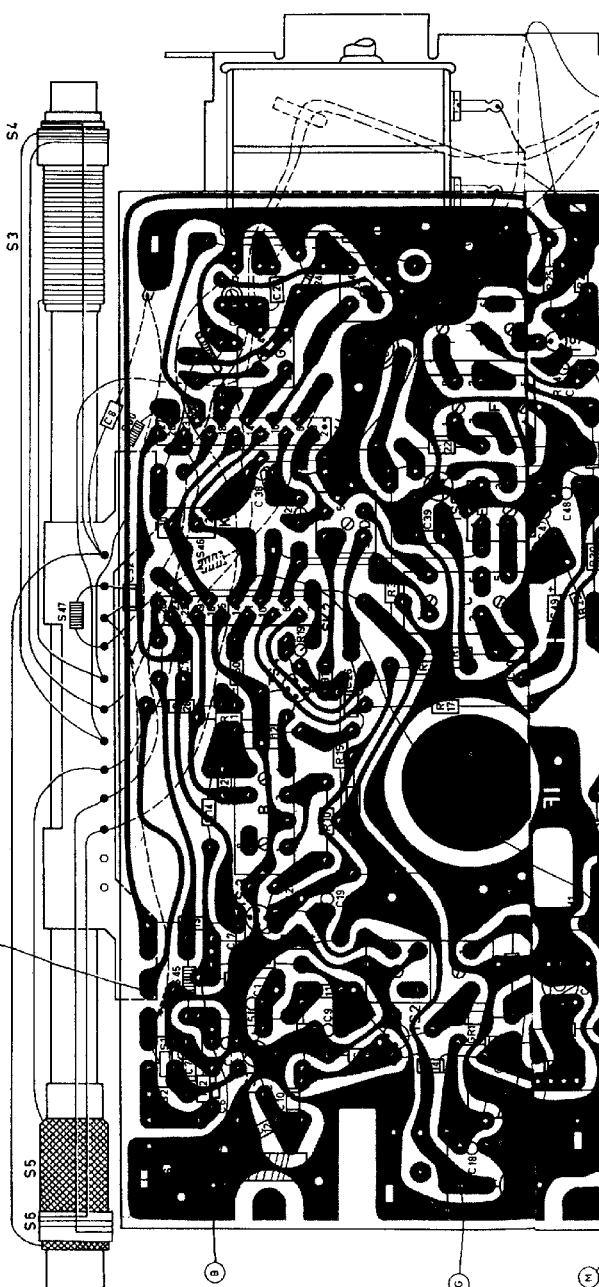
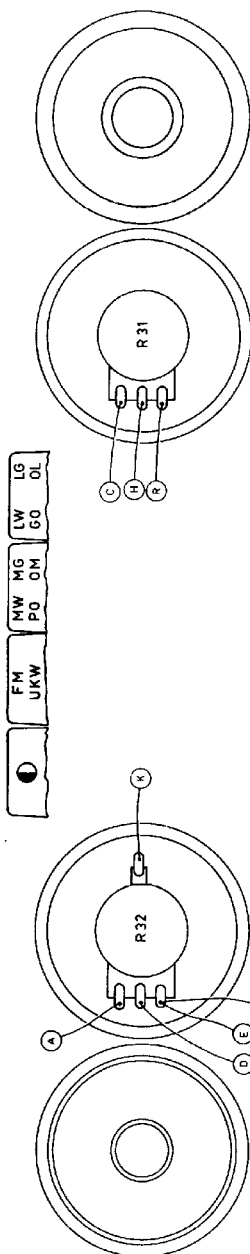

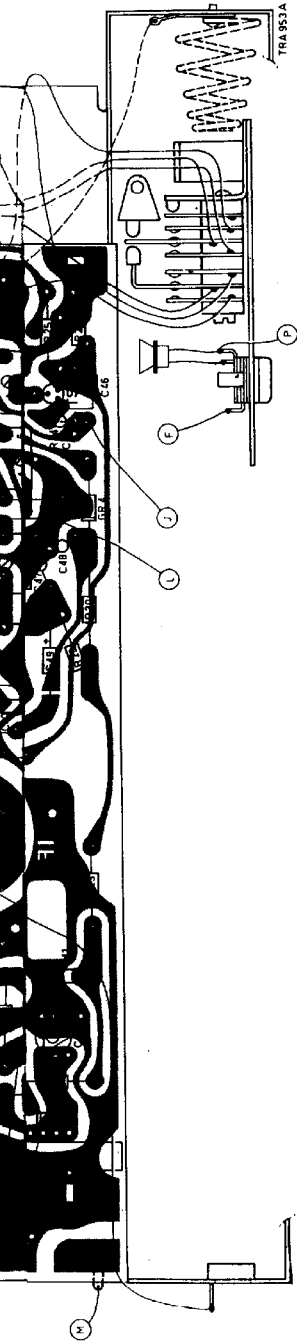

S	38	39	40	41	39	38	42	56	57	58	55	57	54	59	47	48	42	41	49	43
C	63	62	61	41	39	38	42	56	57	58	55	57	54	59	47	48	42	41	49	43
R	51	44	43	45	46	45	42	33	36	37	34	53	40	47	50					

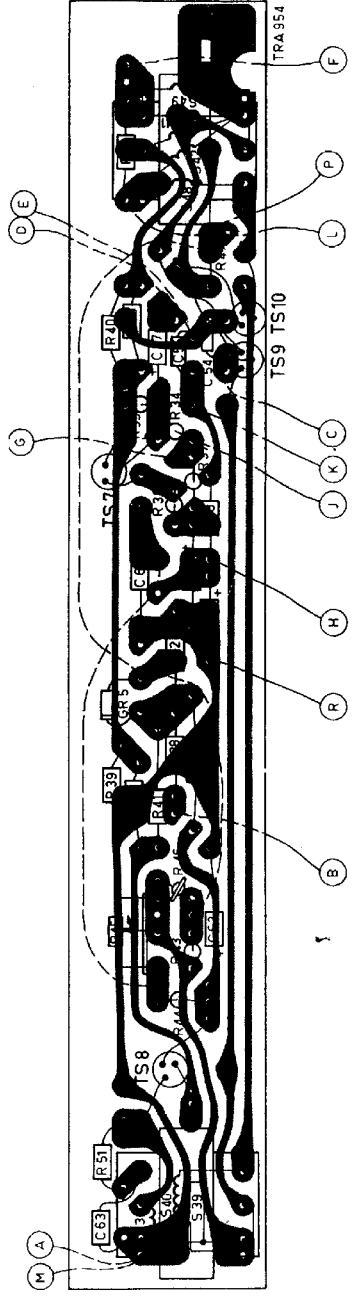

S										45	7	1	2	9	8
C	24	51	28	30	45	53	4	68							
R	25	27	24	22	25	21	30	3	25	19	20	18	20	7	11

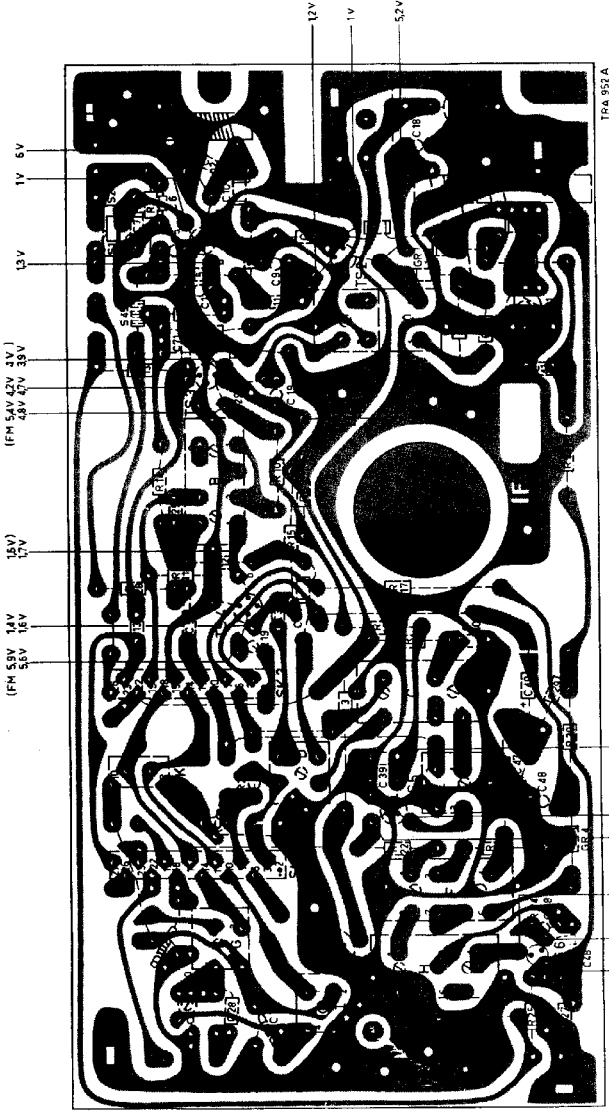

1PA 952 A

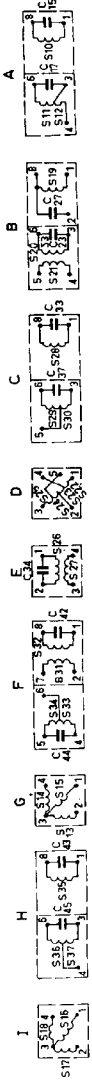

S	43	49	41	42	48										40	35	38			
C						59	54	57	55	58	67	56	62					63		
R	50	47				40	53	34	37	26	33	42	38	39	41	46	45	43	44	51

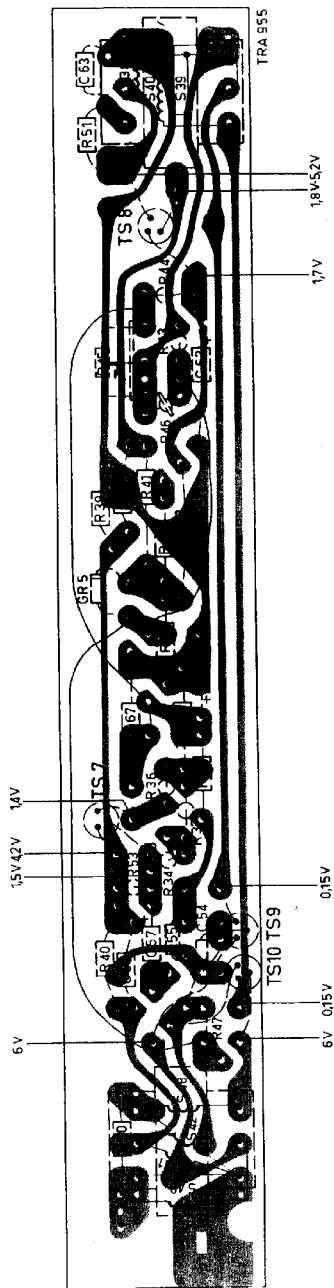

S	46	47	1	2	45	13	16	14	15	17	18	8	7	10	11	12	50	53	4	6	20	19	21	26	28	29	30	27	22	23	24	25	31	32									
C	32	5	6	7	30	1	12	24	10	20	3	66	11	2	9	15	16	14	4	8	17	10	21	22	19	29	41	13	51	23	71	27	25	34	33	37	26	31	40	43	42	36	3
R		2		1						5	4			6			9				16		7	8	13	26	10	11	14	12			15	19		20					18	22	

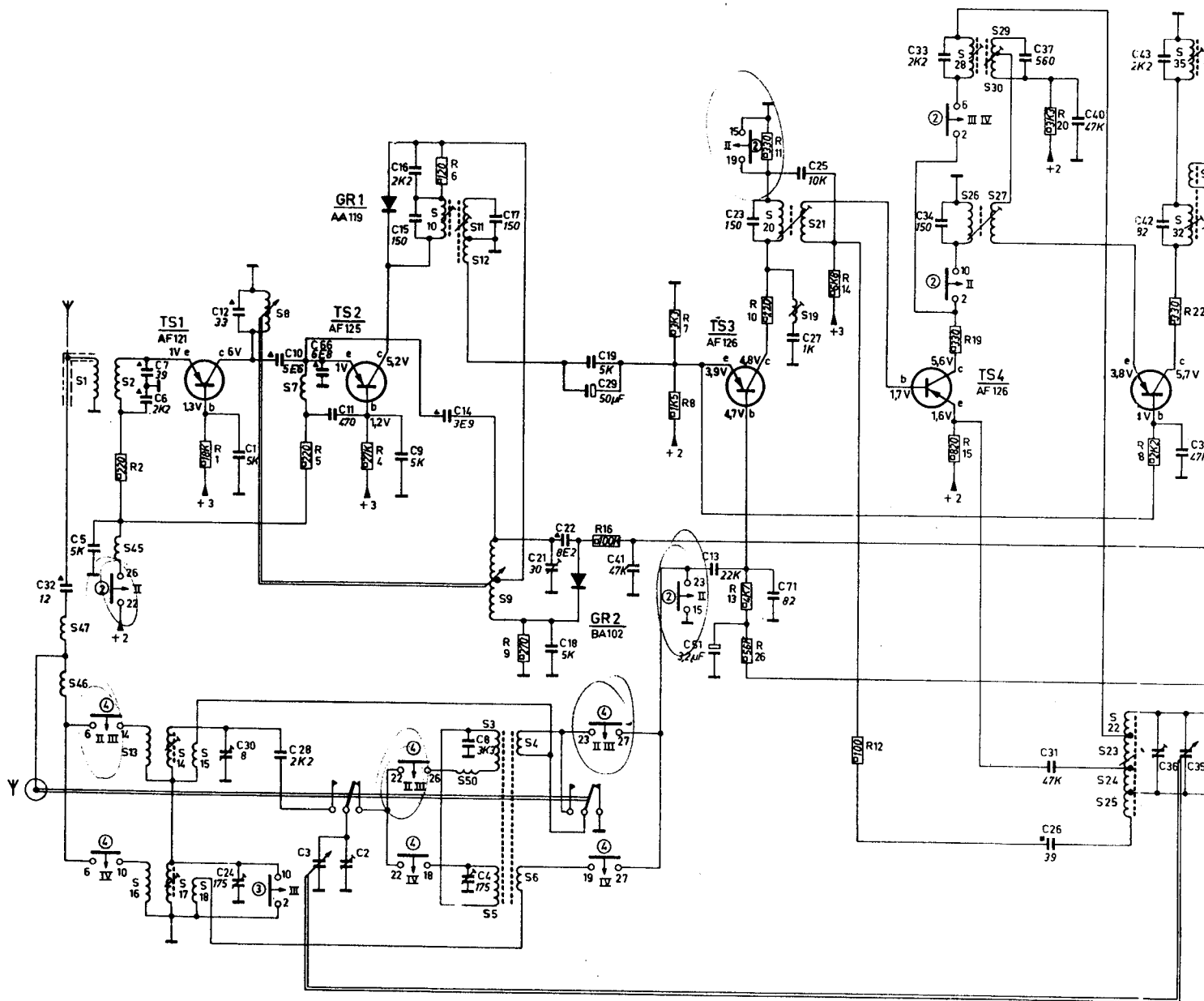

2	23	24	25	31	32	35	33	34	36	37											38	39	40											41	42	43	40	49
43	42	36	39	35	30	44	45	47	48	68	49	46	54	50	55	56	57	58	20	60	67	61	59	63	62	52	53											
18	22						21	25	24	27	29	30	23	17	31	33	28	32	34	35	36	37	39	38	41	42	43	40	44	45	46	51	47	3	50			

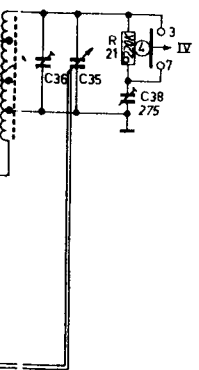
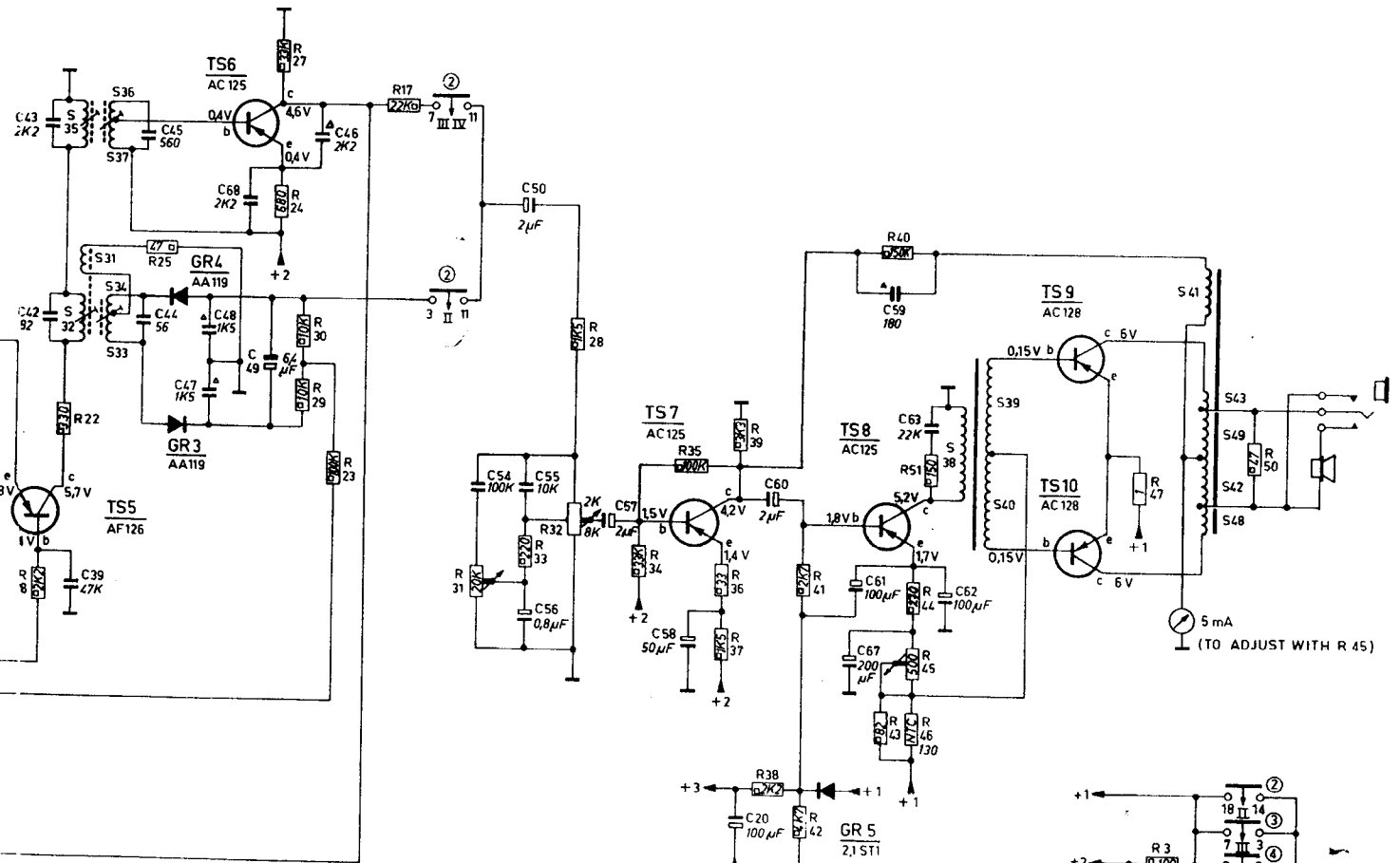

② SK 2	③ SK 3	④ SK 4
II = FM UKW	MW MC PO CM	LW LG GO OL

- 902/A...
- 904/...
- 904/P...
- 905/D...

THE MENTIONED VOLTAGES HAVE BEEN MEASURED WITH RESPECT TO +, WITH A MULTIMETER OF 40000 Ω/V.

DE AANGEGEVEN SPANNINGEN ZIJN GEMETEN TEN OPZICHTE VAN +, MET EEN UNIVERSIEELMETER VAN 40000 Ω/V.

LES TENSIONS INDIQUEES ONT ETE MESUREES PAR RAPPORT A +, AVEC UN POLYMETRE DE 40000 Ω/V.

DIE AANGEBOEVEN SPANNINGEN SIND IN BEZUG AUF +, MIT EINEM UNIVERSALMESSGERAET VON 40000 Ω/V.

LAS TENSIONES INDICADAS FUERON MEDIDAS CON RESPECTO A +, CON UN INSTRUMENTO UNIVERSAL DE 40000 Ω/V.

TRA 951A

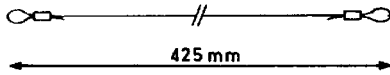
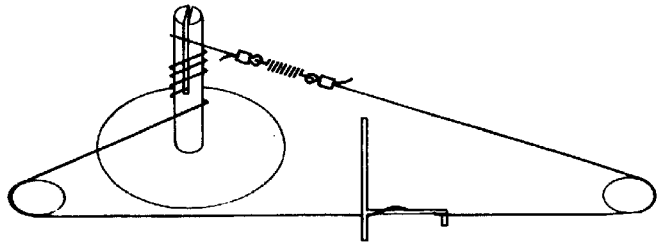

TRA 956

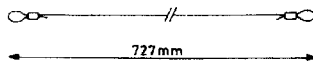
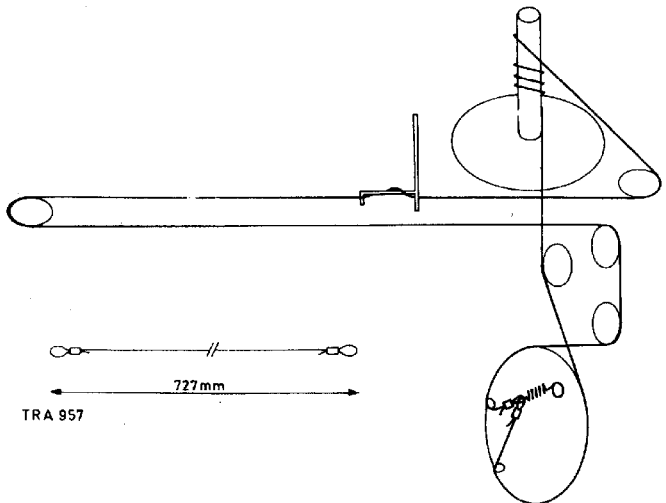

TRA 957

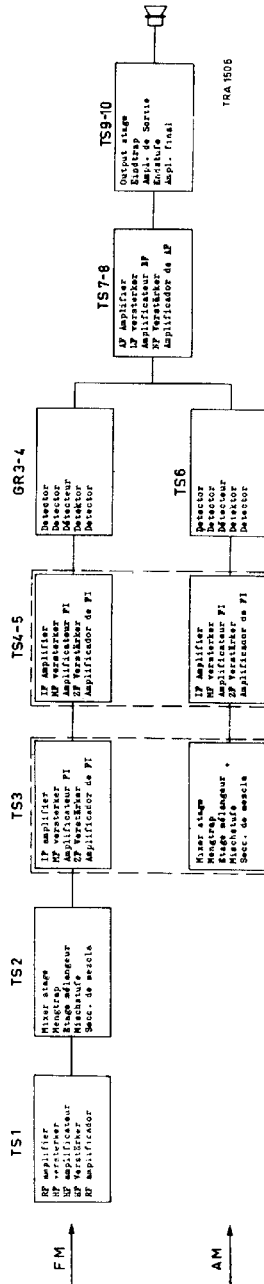

Cabinet	4822 182 00368	Kast	4822 182 00368	Genhuise	4822 182 00368	Caja	4822 182 00368
Rear cover	4822 182 00371	Achterwand	4822 182 00371	Ruokwand	4822 182 00371	Tapa posterior	4822 182 00371
Side wall	4822 182 00372	Zijkant	4822 182 00372	Seitengewand	4822 182 00372	Tapa lateral	4822 182 00372
Aerial	4822 106 00328	Antenne	4822 106 00328	Antenne	4822 106 00328	Antena	4822 106 00328
Escutcheon of sockets	4822 182 00359	Profil van steekerbussen	4822 182 00359	Profil pour douilles	4822 182 00359	Caja de hembrillas	4822 182 00359
Handle	4822 182 00374	Handvat	4822 182 00374	Poignée	4822 182 00374	Asa	4822 182 00374
Screw fixing handle	4822 177 00225	Schroef bev. handvat	4822 177 00225	Vis fix. poignée	4822 177 00225	Tornillo fij. asa	4822 177 00225
Battery cover	4822 182 00376	Batterijdeksel	4822 182 00376	Convercle de ports-pile	4822 182 00376	Tapa de portapila	4822 182 00376
Locking screw	4822 182 00377	Bevestigingsschroef	4822 182 00377	Vis fix. couvercle	4822 182 00377	Tornillo fij. tapa	4822 182 00377
Dial background	4822 182 00359	Schaal achtergrond	4822 182 00359	Fond de cadran	4822 182 00359	Fondo de cuadrante	4822 182 00359
Push button unit	4822 182 00370	Druktoets eenheid	4822 182 00370	Elec à clavier	4822 182 00370	Unidad de teclas	4822 182 00370
Push button	4822 182 00381	Druktoets	4822 182 00381	Touche	4822 182 00381	Tecla	4822 182 00381
Knop (FM)	4822 182 00382	Knop (AM)	4822 182 00382	Bouton (AM)	4822 182 00382	Botón (AM)	4822 182 00382
Knop (volume)	4822 182 00383	Knop (FM)	4822 182 00383	Bouton (FM)	4822 182 00383	Botón (FM)	4822 182 00383
	4822 182 00384	Knop (volume)	4822 182 00384	Bouton (puissance)	4822 182 00384	Botón (volumen)	4822 182 00384
Pulley	4822 182 00165	Smarwiel	4822 182 00165	Poulie	4822 182 00165	Polja	4822 182 00165
Drum in driving	4822 182 00395	Smartrommel	4822 182 00395	Tambour d'entraînement	4822 182 00395	Trommel	4822 182 00395
Switch SK2	4822 107 00588	Schakelaar SK2	4822 107 00588	Interrupteur SK2	4822 107 00588	Commutador SK2	4822 107 00588
Slide of SK2	4822 107 00587	Schuif van SK2	4822 107 00587	Plaque SK2	4822 107 00587	Deslizador de SK2	4822 107 00587
Switch SK3	4822 107 00591	Schakelaar SK3	4822 107 00591	Commutateur SK3	4822 107 00591	Commutador SK3	4822 107 00591
Slide of SK3	4822 107 00592	Schuif van SK3	4822 107 00592	Tiroir de SK3	4822 107 00592	Deslizador de SK3	4822 107 00592
Switch SK4	4822 107 00593	Schakelaar SK4	4822 107 00593	Commutateur SK4	4822 107 00593	Commutador SK4	4822 107 00593
Slide of SK4	4822 107 00594	Schuif van SK4	4822 107 00594	Tiroir de SK4	4822 107 00594	Deslizador de SK4	4822 107 00594
Foot strip	4822 182 00386	Voet	4822 182 00386	Pied	4822 182 00386	Hembrilla de antena con	4822 182 00386
Socket aerial with switch	4822 182 00387	Antenne-aansluiting met schakelaar	4822 182 00387	Radielle d'antenne avec commutateur	4822 182 00387	comutador	4822 182 00387
Socket earphone	4822 211 00965	Ortofoon-aansluiting	4822 211 00965	Bouille d'écouteur	4822 211 00965	Hembrilla de auricular	4822 211 00965
Dial (-/13)	4822 182 00545	Schaal (-/13)	4822 182 00545	Scala (-/13)	4822 182 00545	Cuadrante (-/13)	4822 182 00545
Dial (-/52)	4822 182 00541	Schaal (-/52)	4822 182 00541	Cadran (-/52)	4822 182 00541	Cuadrante (-/52)	4822 182 00541

S1	4822 204 00159	Aerial coil Antennespoul Bobine d'antenne Antennenspule Bobina de antena	S16) C17) S20) C23) S21) S22)	IF coil, FM MF-spoul, FM Transformateur FI, FM ZF-Spule, FM Transformador de FI, FM	S38) S39) S40)	4822 204 00175	Driver transformer Ingangstransformator Transformateur déphaseur Treibertransformator Transformador de entrada BF
S3	4822 204 00161	Ferroceptor Ferrocaptor Ferroreceptor Ferroreceptor	S22) S23) S24) S25)	Oscillator coil, FM-LW Oscillatortoppul, FM-LW Oscillatortoppul, FM-LW Oscillatortoppul, FM-LW Bobina de oscilador, OM-OL	S41) S42) S43)	4822 204 00176	Output transformer Uitgangstransformator Transformateur de sortie Ausgangstransformator Transformador de altavoz
S7	4822 204 00162	Absorption coil FM Zuigspool, FM Bobine d'absorption FM Saugspule, FM Bobina de absorción	S26) C34) S27)	MF-spoul, FM Transformateur FI, FM ZF-Spule, FM Transformador de FI, FM	S45) S46)	4822 204 00162	Choke Smoorspoel Bobine Drossel Bobina de choque
S10	4822 204 00165	IF coil, FM MF-spoul, FM Transformateur FI, FM ZF-Spule, FM Transformador de FI, FM	S28) C33) S29) C37) S30)	IF coil, AM MF-spoul, AM Transformateur FI, AM ZF-Spule, AM Transformador de FI, AM	S47)	4822 192 00473	Aerial coil, FM Antennespoul, FM Bobine d'antenne, FM Antennenspule, FM Bobina de antena, FM
S13	4822 204 00166	Aerial coil, MW Antennespoul, MW Bobine d'antenne, MW Antennenspule, MW Bobina de antena, MW	S31) S32) C42) S33) S34) C44)	Radioindicator Radiocaptor Détecteur de rapport Radioindikator Detector de relación	C2) C3) C4) C36)	4822 059 00344	Tuning capacitor Afstemcondensator Condensateur variable Drehkondensator Condensador variable
S16	4822 204 00167	Aerial coil LW Antennespoul LG Bobine d'antenne GO Antennenspule LW Bobina de antena OL	S35) C43) S37) C45)	Detection coil, AM Rapportspool, AM Bobine de détecteur AM Detektorspule AM Bob. de detector AM	R31) R32)	4822 071 00732 4822 071 00731	Potentiometer Potentiometer Potentiometer Potentiometer
C1	4822 069 00627		909/A100	C40	C 280 AA/F4TK	029/M2.5	
C4	907/308-175E		C21	C 005 CC/10E		4822 369 30572	
C5	4822 069 00627		C24	907/308-175E	C49	909/M2	
C8	4822 069 00554		C25	4822 069 00589	C50	909/A100	
C9	4822 069 00627		C28	4822 069 00535	C51	909/M2.5	
C11	C 295 AB/BA7CE		C29	4822 069 00512	C52	909/M4	
C13	4822 069 001001		C30	909/12E	C53	4822 069 00675	
C16	4822 069 00535		C31	C 280 AA/F4TK	C54	909/A100-909/A19.4	
C18	4822 069 00627		C38-	907/308-175E	C55	909/M2.5	
C19	4822 069 00627		C39	C 280 AA/F4TK	C56	4822 069 00589	
			C59		C56	909/C1.6	
					C57	4822 069 01001	
					C58	909/200	
					C59	4822 071 00918	
					C61	4822 069 00634	
					R45	E 097 AC/500E	
					R46	E 201 BC/A130E	