

Pioneer

Service Manual

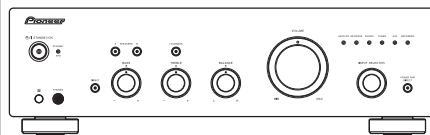

A-30-K

ORDER NO.
RRV4297

INTEGRATED AMPLIFIER

A-30-K

A-30-S

A-20-K

A-20-S

A-20

A-10-K

A-10-S

THIS MANUAL IS APPLICABLE TO THE FOLLOWING MODEL(S) AND TYPE(S).

Model	Type	Power Requirement	Remarks
A-30-K/-S	PWSYXE8	AC 220 V to 230 V	
A-20-K/-S	PWSYXE8	AC 220 V to 230 V	
A-20	CUXE	AC 120 V	
A-10-K/-S	SYXE8	AC 220 V to 230 V	



PIONEER CORPORATION 1-1, Shin-ogura, Saiwai-ku, Kawasaki-shi, Kanagawa 212-0031, Japan
PIONEER ELECTRONICS (USA) INC. P.O. Box 1760, Long Beach, CA 90801-1760, U.S.A.
PIONEER EUROPE NV Haven 1087, Keetberglaan 1, 9120 Melsele, Belgium
PIONEER ELECTRONICS ASIACENTRE PTE. LTD. 253 Alexandra Road, #04-01, Singapore 159936

©PIONEER CORPORATION 2012

K-FZV MAY 2012 Printed in Japan

1 2 3 4

SAFETY INFORMATION

This service manual is intended for qualified service technicians ; it is not meant for the casual do-it-yourselfer. Qualified technicians have the necessary test equipment and tools, and have been trained to properly and safely repair complex products such as those covered by this manual.

Improperly performed repairs can adversely affect the safety and reliability of the product and may void the warranty. If you are not qualified to perform the repair of this product properly and safely, you should not risk trying to do so and refer the repair to a qualified service technician.

WARNING

This product contains lead in solder and certain electrical parts contain chemicals which are known to the state of California to cause cancer, birth defects or other reproductive harm.

Health & Safety Code Section 25249.6 - Proposition 65

NOTICE

(FOR CANADIAN MODEL ONLY)

Fuse symbols (fast operating fuse) and/or (slow operating fuse) on PCB indicate that replacement parts must be of identical designation.

REMARQUE

(POUR MODÈLE CANADIEN SEULEMENT)

Les symboles de fusible (fusible de type rapide) et/ou (fusible de type lent) sur CCI indiquent que les pièces de remplacement doivent avoir la même désignation.

(FOR USA MODEL ONLY)

1. SAFETY PRECAUTIONS

The following check should be performed for the continued protection of the customer and service technician.

LEAKAGE CURRENT CHECK

Measure leakage current to a known earth ground (water pipe, conduit, etc.) by connecting a leakage current tester such as Simpson Model 229-2 or equivalent between the earth ground and all exposed metal parts of the appliance (input/output terminals, screwheads, metal overlays, control shaft, etc.). Plug the AC line cord of the appliance directly into a 120V AC 60 Hz outlet and turn the AC power switch on. Any current measured must not exceed 0.5 mA.

AC Leakage Test

ANY MEASUREMENTS NOT WITHIN THE LIMITS OUTLINED ABOVE ARE INDICATIVE OF A POTENTIAL SHOCK HAZARD AND MUST BE CORRECTED BEFORE RETURNING THE APPLIANCE TO THE CUSTOMER.

2. PRODUCT SAFETY NOTICE

Many electrical and mechanical parts in the appliance have special safety related characteristics. These are often not evident from visual inspection nor the protection afforded by them necessarily can be obtained by using replacement components rated for voltage, wattage, etc. Replacement parts which have these special safety characteristics are identified in this Service Manual.

Electrical components having such features are identified by marking with a on the schematics and on the parts list in this Service Manual.

The use of a substitute replacement component which does not have the same safety characteristics as the PIONEER recommended replacement one, shown in the parts list in this Service Manual, may create shock, fire, or other hazards.

Product Safety is continuously under review and new instructions are issued from time to time. For the latest information, always consult the current PIONEER Service Manual. A subscription to, or additional copies of, PIONEER Service Manual may be obtained at a nominal charge from PIONEER.

2

A-30-K

1 2 3 4

CONTENTS

SAFETY INFORMATION.....	2	
1. SERVICE PRECAUTIONS.....	4	A
1.1 NOTES ON SOLDERING.....	4	
2. SPECIFICATIONS.....	5	
2.1 ACCESSORIES.....	5	
2.2 SPECIFICATIONS.....	5	
3. BASIC ITEMS FOR SERVICE.....	6	
3.1 CHECK POINTS AFTER SERVICING.....	6	
3.2 PCB LOCATIONS.....	7	
3.3 JIGS LIST.....	7	
4. BLOCK DIAGRAM.....	8	
4.1 OVERALL CONNECTION DIAGRAM.....	8	
4.2 BLOCK DIAGRAM.....	10	
5. DIAGNOSIS.....	12	B
5.1 TROUBLESHOOTING.....	12	
5.2 PROTECTION CIRCUIT DESCRIPTION.....	15	
5.3 IC INFORMATION.....	17	
6. SERVICE MODE.....	21	
7. DISASSEMBLY.....	22	
8. EACH SETTING AND ADJUSTMENT.....	29	
8.1 HOW TO CHECK THE FIRMWARE VERSION.....	29	
8.2 FARMWARE UPDATING.....	29	
8.3 HOW TO ADJUST THE IDLE CURRENT.....	31	
9. EXPLODED VIEWS AND PARTS LIST.....	32	
9.1 PACKING SECTION.....	32	
9.2 EXTERIOR SECTION (A-30/A-20).....	34	C
9.3 EXTERIOR SECTION (A-10).....	38	
10. SCHEMATIC DIAGRAM.....	40	
10.1 MAIN ASSY.....	40	
10.2 FRONT ASSY and SECOND POWER SW ASSY (A-30/A-20).....	42	
10.3 MASTER VOLUME ASSY, TONE ASSY and HEADPHONE ASSY.....	44	
11. PCB CONNECTION DIAGRAM.....	46	
11.1 MAIN ASSY.....	46	
11.2 FRONT ASSY.....	50	
11.3 MASTER VOLUME ASSY.....	52	
11.4 TONE ASSY.....	53	
11.5 HEADPHONE ASSY and SECOND POWER SW ASSY (A-30/A-20).....	54	
12. PCB PARTS LIST.....	55	D

1. SERVICE PRECAUTIONS

1.1 NOTES ON SOLDERING

- A • For environmental protection, lead-free solder is used on the printed circuit boards mounted in this unit.
Be sure to use lead-free solder and a soldering iron that can meet specifications for use with lead-free solders for repairs accompanied by reworking of soldering.
- Compared with conventional eutectic solders, lead-free solders have higher melting points, by approximately 40 °C. Therefore, for lead-free soldering, the tip temperature of a soldering iron must be set to around 373 °C in general, although the temperature depends on the heat capacity of the PC board on which reworking is required and the weight of the tip of the soldering iron.

Do NOT use a soldering iron whose tip temperature cannot be controlled.

- B Compared with eutectic solders, lead-free solders have higher bond strengths but slower wetting times and higher melting temperatures (hard to melt/easy to harden).

The following lead-free solders are available as service parts:

- Parts numbers of lead-free solder:
GYP1006 1.0 in dia.
GYP1007 0.6 in dia.
GYP1008 0.3 in dia.

C

D

E

F

2. SPECIFICATIONS

2.1 ACCESSORIES

- Remote control unit (A-30-K/-S : CARTA30)
(A-20-K/-S, A-20 : CARTA20)
- AC Power cord (A-30-K/-S : CJA2B054Z)
(A-20-K/-S, A-10-K/-S : CJA2B020Z)
- Operating instructions (A-30-K/-S, A-20-K/-S, A-10-K/-S : CQX1A1640Y)
(A-20 : CQX1A1644Z)
- AAA/R03 dry cell battery x 2 (A-30-K/-S, A-20-K/-S, A-20)
- Warranty card (A-30-K/-S, A-20-K/-S, A-10-K/-S : CQE1A541Z)

2.2 SPECIFICATIONS

Amplifier section

Power output specification is for when power supply is 230 V.
(A-30-K/-S, A-20-K/-S, A-10-K/-S)

Power output specification is for when power supply is 120 V.
(A-20)

•Continuous power output (both channels driven at 20 Hz to 20 kHz)

A-30	70 W + 70 W
A-20, A-10	50 W + 50 W (THD 0.1 %, 4 Ω)
A-30	40 W + 40 W
A-20, A-10	30 W + 30 W (THD 0.05 %, 8 Ω)

Audio section

•Input (Sensitivity/Impedance)

SACD/CD, NETWORK, TUNER, AUX, RECORDER	200 mV/50 kΩ
POWER AMP DIRECT (A-30 only)	1 V/10 kΩ
PHONO (MM)	2.8 mV/50 kΩ

•Output (Level/Impedance)

RECORDER OUT	200 mV/2.2 kΩ
PHONES	250 mV/32 Ω

•Frequency response

SACD/CD, NETWORK, TUNER, AUX, RECORDER	5 Hz to 100 kHz ± 0.3 dB*
PHONO (MM)	20 Hz to 20 kHz ± 0.5 dB*

* Measured with DIRECT button switched on.

•Tone control

(When VOLUME is set to -30 dB)	
Bass	± 10 dB (100 Hz)
Treble	± 10 dB (10 kHz)

•Signal-to-Noise Ratio (IHF SHORTED, A-NETWORK)

SACD/CD, NETWORK, TUNER, AUX, RECORDER	105 dB*
PHONO (MM, 2.8 mV input)	77 dB*

* Measured with DIRECT button switched on.

•Speaker load impedance

A, B	4 Ω to 16 Ω
A+B	8 Ω to 32 Ω
Bi-wiring	4 Ω to 16 Ω

Miscellaneous

Power requirements	AC 220 V to 230 V, 50 Hz (A-30-K/-S, A-20-K/-S, A-10-K/-S)
	AC 120 V, 60 Hz (A-20)

Power consumption

A-30	175 W
A-20/A-10	135 W
In standby	0.3 W
Dimensions	435 mm (W) x 128 mm (H) x 360 mm (D)
Weight (without package)	
A-30	7.9 kg
A-20	7.2 kg
A-10	6.7 kg



Note

- Specifications and the design are subject to possible modifications without notice, due to improvements.
- Corporation and product names mentioned herein are trademarks or registered trademarks of the respective corporations.

3. BASIC ITEMS FOR SERVICE

3.1 CHECK POINTS AFTER SERVICING

A To keep the product quality after servicing, confirm recommended check points shown below.

No.	Procedures	Check points
1	Check the symptom pointed out by a customer	The pointed content should not reoccur Sound and operation should not be defective
2	Check each input and main VOL (check the operation of selector)	The sound is output by selecting an analog-connected input with a selector and the sound volume should change by rotating main VOL knob
3	Check the tone control, balance, and function	The sound quality or right and left balances should change by rotating each VOL knob
4	Check LOUDNESS and DIRECT functions	The sound quality should change by setting LOUDNESS function to ON. LOUDNESS function should be disabled by setting DIRECT function to ON.
5	Check POWER AMP DIRECT terminal (only A-30) (connected from pre-out terminal of AV AMP to POWER AMP DIRECT terminal)	The sound volume should change by adjusting the sound volume of connected AV AMP. The sound volume should not be changed by the main VOL on the main unit.
6	Check SPEAKER A/B and headphone terminal	There should not be defect in sound such as noise
7	Check the external package	Check scratch or taint is not generated after accepting the repair

C See the table below for the items to be checked regarding audio.

Item to be checked regarding audio
Distortion
Noise
Volume too low
Volume too high
Volume fluctuating
Sound interrupted

3.2 PCB LOCATIONS

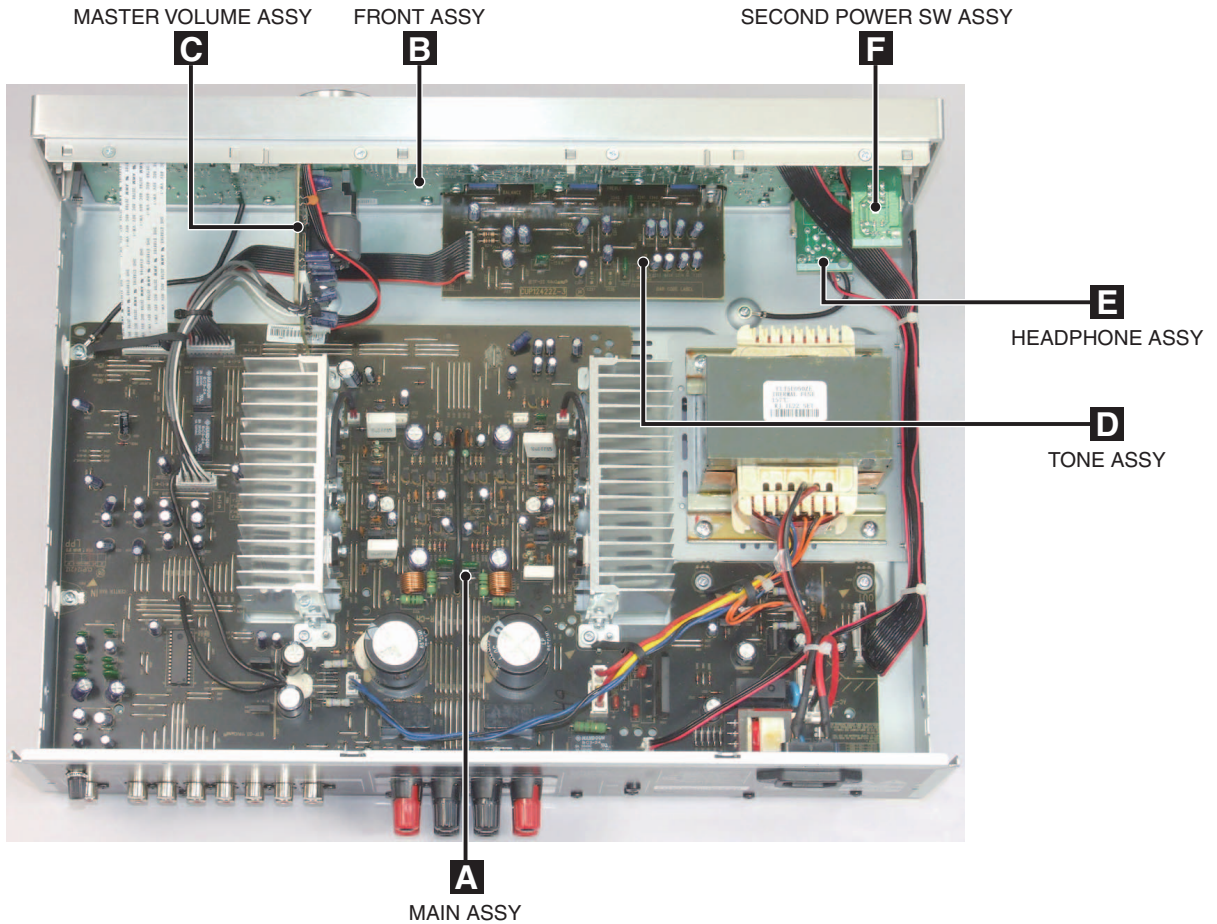

NOTES: ● Parts marked by “NSP” are generally unavailable because they are not in our Master Spare Parts List.
 ● The ⚠ mark found on some component parts indicates the importance of the safety factor of the part.
 Therefore, when replacing, be sure to use parts of identical designation.

Mark No.	Description	Part No.	Mark No.	Description	Part No.
LIST OF ASSEMBLIES					
NSP	1..MAIN ASSY (A-30-K/-S) 2..MAIN ASSY	COP12421B AZW7487	NSP	1..FRONT ASSY (A-20-K/-S) 2..FRONT ASSY 2..MASTER VOLUME ASSY 2..TONE ASSY 2..HEADPHONE ASSY 2..SECOND POWER SW ASSY	COP12422C AZW7483 AZW7481 AZW7477 AZW7479 AZW7478
NSP	1..MAIN ASSY (A-20-K/-S) 2..MAIN ASSY	COP12421D AZW7489	NSP	1..FRONT ASSY (A-20) 2..FRONT ASSY 2..MASTER VOLUME ASSY 2..TONE ASSY 2..HEADPHONE ASSY 2..SECOND POWER SW ASSY	COP12422G AZW7484 AZW7481 AZW7477 AZW7479 AZW7478
NSP	1..MAIN ASSY (A-20) 2..MAIN ASSY	COP12421E AZW7490	NSP	1..FRONT ASSY (A-10-K/-S) 2..FRONT ASSY 2..MASTER VOLUME ASSY 2..TONE ASSY 2..HEADPHONE ASSY 2..SECOND POWER SW ASSY	COP12422D AZW7485 AZW7481 AZW7477 AZW7479 AZW7478
NSP	1..MAIN ASSY (A-10-K/-S) 2..MAIN ASSY	COP12421F AZW7491	NSP	1..FRONT ASSY (A-30-K/-S) 2..FRONT ASSY 2..MASTER VOLUME ASSY 2..TONE ASSY 2..HEADPHONE ASSY 2..SECOND POWER SW ASSY	COP12422B AZW7482 AZW7476 AZW7477 AZW7479 AZW7478
NSP	1..FRONT ASSY (A-30-K/-S) 2..FRONT ASSY 2..MASTER VOLUME ASSY 2..TONE ASSY 2..HEADPHONE ASSY 2..SECOND POWER SW ASSY	COP12422B AZW7482 AZW7476 AZW7477 AZW7479 AZW7478	NSP	1..FRONT ASSY (A-10-K/-S) 2..FRONT ASSY 2..MASTER VOLUME ASSY 2..TONE ASSY 2..HEADPHONE ASSY	COP12422D AZW7485 AZW7481 AZW7477 AZW7479

3.3 JIGS LIST

Name	Jig No.	Remarks
UPDATE JIG	GGF1675	Firmware Update

4. BLOCK DIAGRAM

4.1 OVERALL CONNECTION DIAGRAM

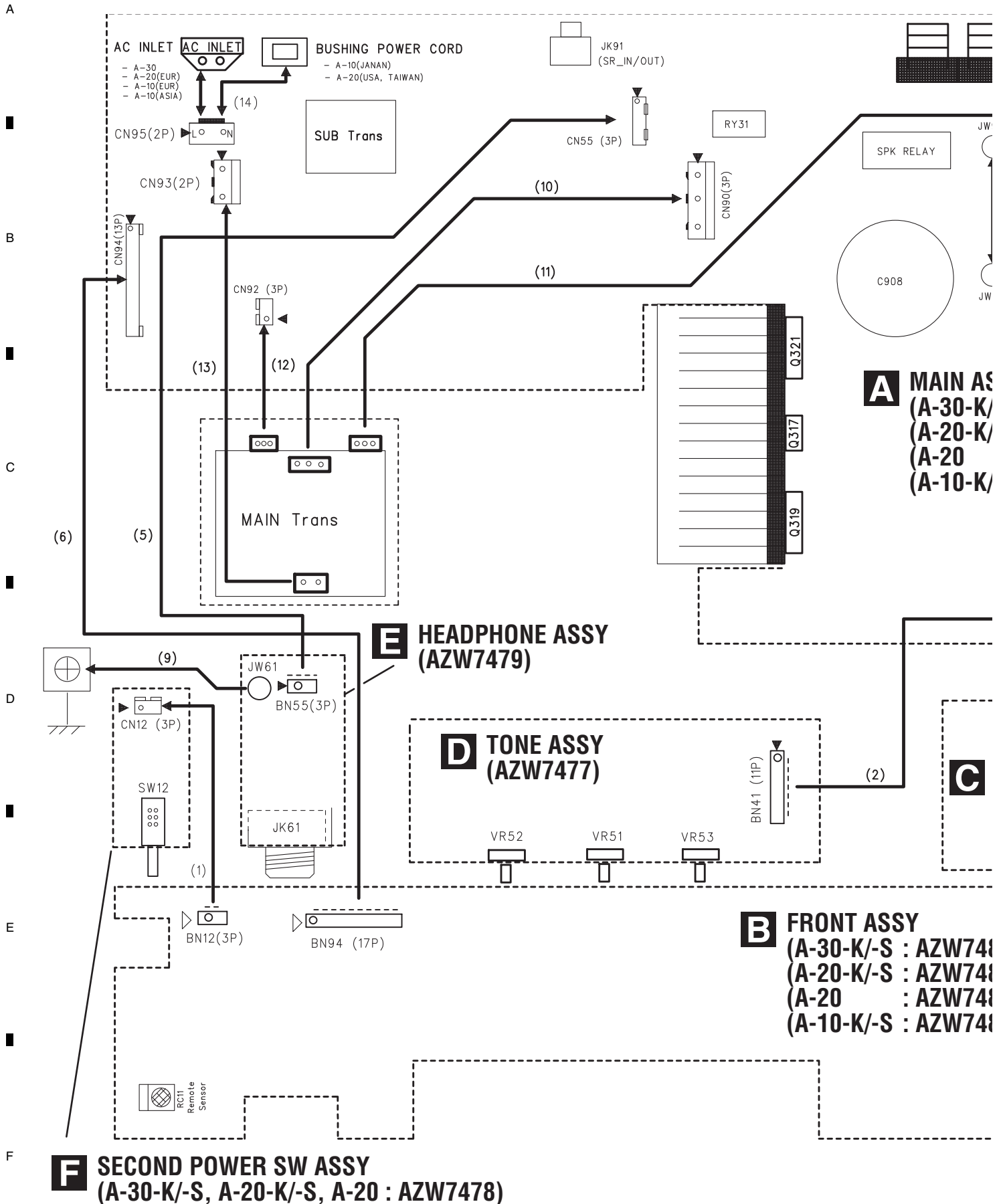

A
B
C
D
E
F

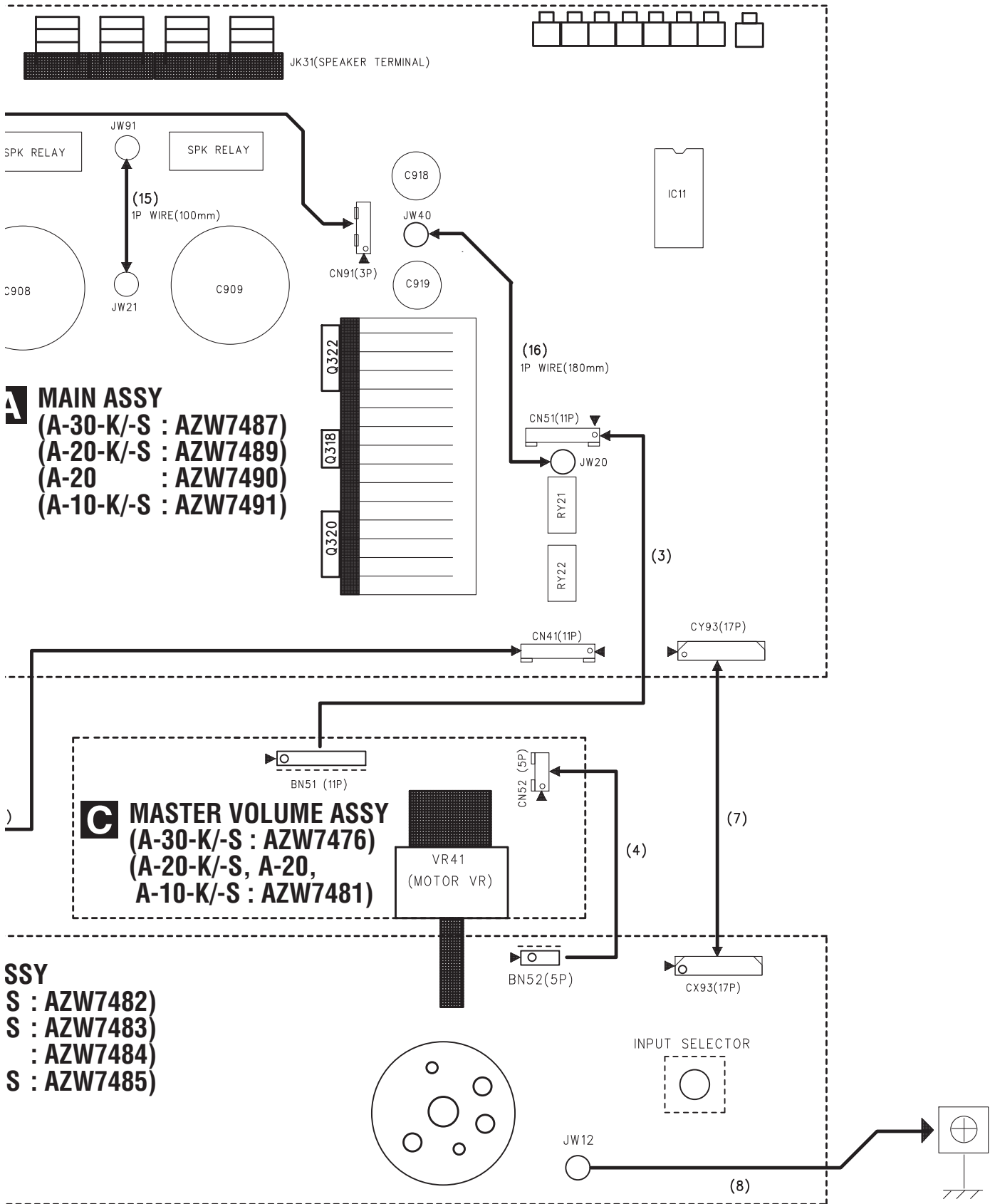

MAIN ASSY
 (A-30-K/-S : AZW7487)
 (A-20-K/-S : AZW7489)
 (A-20 : AZW7490)
 (A-10-K/-S : AZW7491)

MASTER VOLUME ASSY
 (A-30-K/-S : AZW7476)
 (A-20-K/-S, A-20,
 A-10-K/-S : AZW7481)

SSY
 S : AZW7482)
 S : AZW7483)
 : AZW7484)
 S : AZW7485)

● When ordering service parts, be sure to refer to "EXPLODED VIEWS and PARTS LIST" or "PCB PARTS LIST".
 ● The Δ mark found on some component parts indicates the importance of the safety factor of the part.
 Therefore, when replacing, be sure to use parts of identical designation.

4.2 BLOCK DIAGRAM

* COMPARE LIST *

	A-30	A-20(EUR)	A-20(USA/TAIWAN)	A-10(JAPAN)	A-10(EUR/ASIA)
OUTPUT	70W+70W	50W+50W	50W+50W	50W+50W	50W+50W
LED INDI.	BLUE	RED	RED	GREEN	RED
REMOCON	YES	YES	YES	YES	NO
POWER SW	MOMS	MOMS	MOMS	TACT SW	TACT SW
ST-BY LED	YES	YES	YES	YES	YES
AC INLET	BIG	Small	NO	NO	Small
BUSHING	NO	NO	BUSHING	BUSHING	NO
VOLUME	MOTOR	MOTOR	MOTOR	MOTOR	WITHOUT MOTOR
REMO. SENSOR	YES	YES	YES	YES	NO
P-AMP	YES	NO	NO	NO	NO
SR_IN/OUT	YES	YES	YES	NO	NO

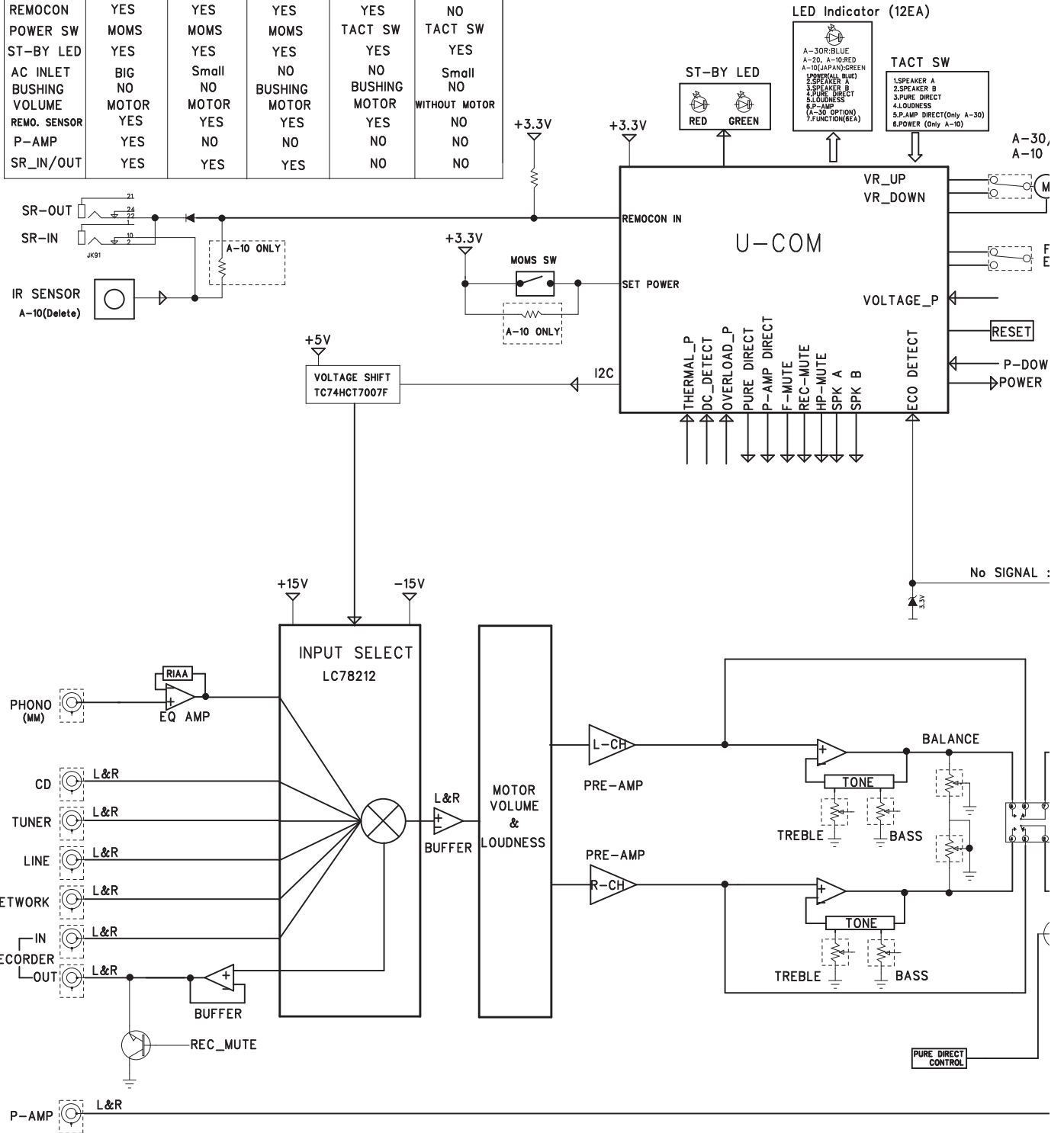

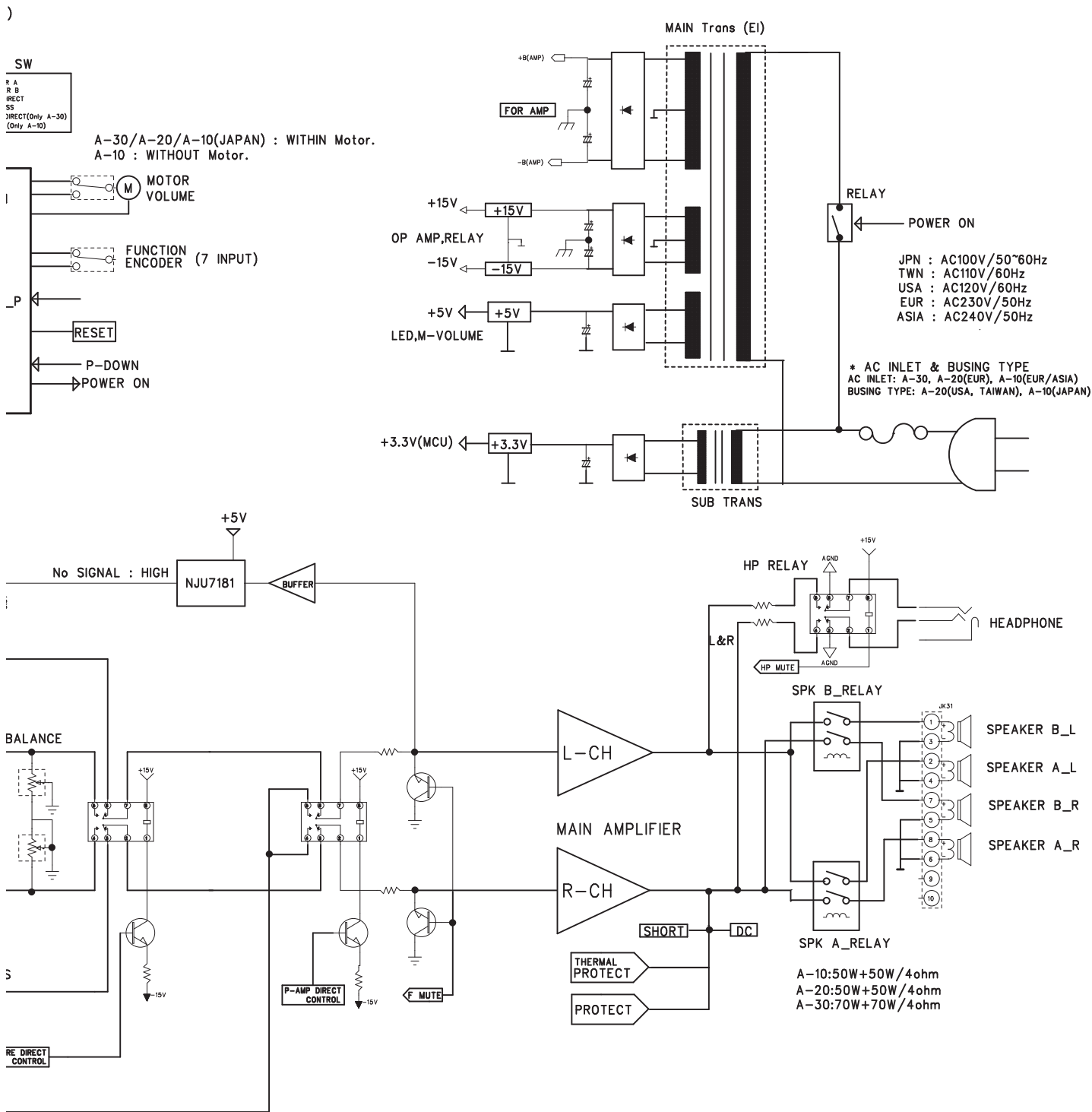

5. DIAGNOSIS

5.1 TROUBLESHOOTING

●No sound

[Status of product]

- Insert AC Power cord
- Main unit POWER SW: ON (A-30/A-20)
- POWER ON operation by remote control Unit
- Select SPEAKER-A
- INPUT : SACD/CD

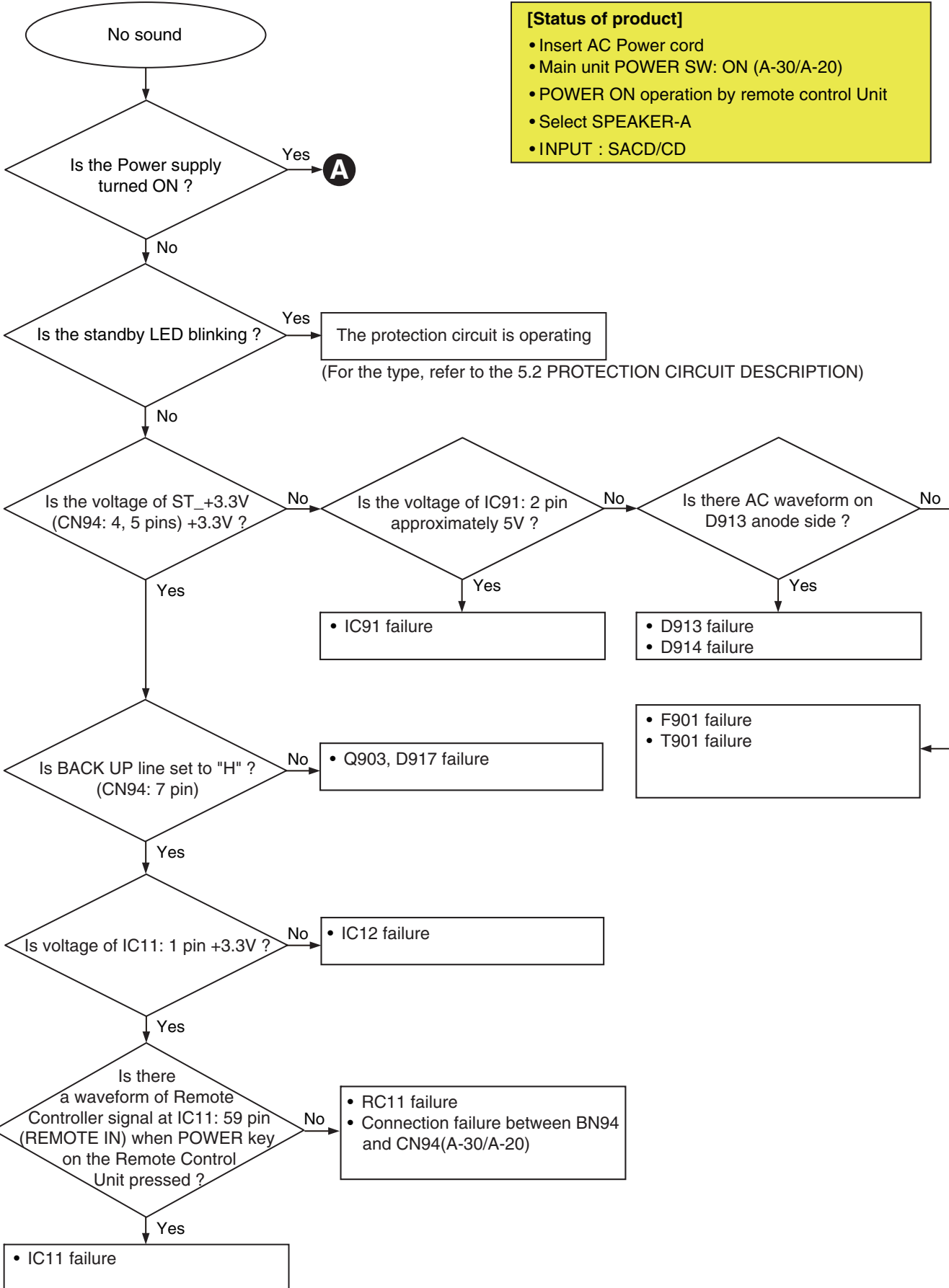

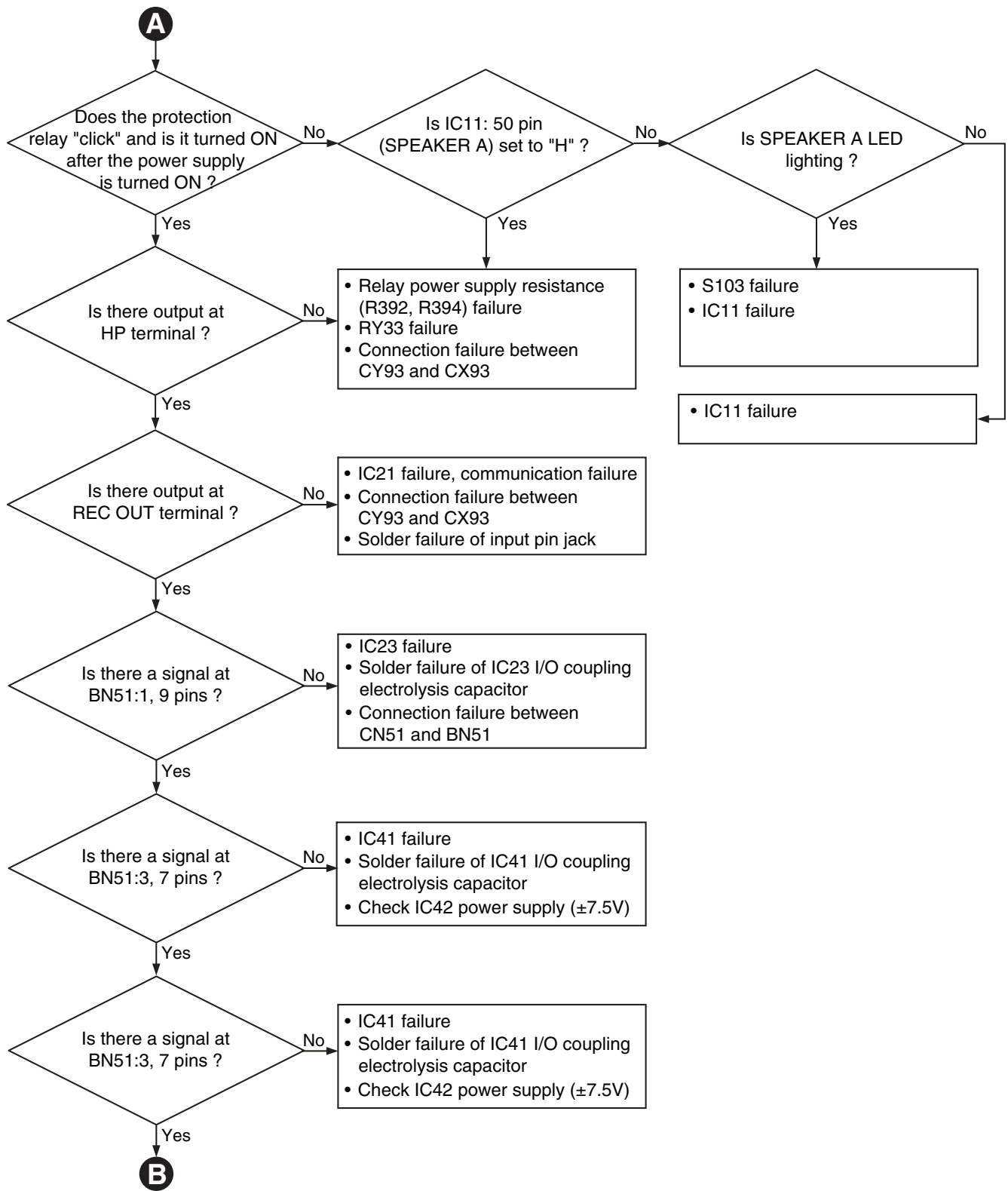

B

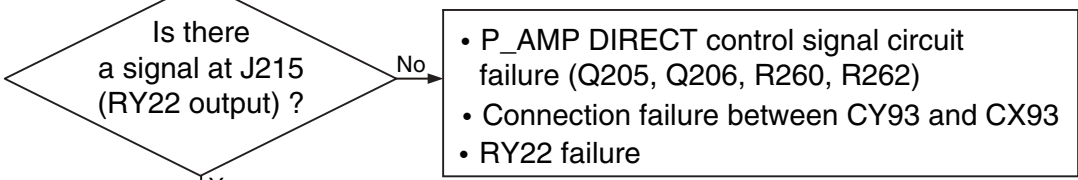
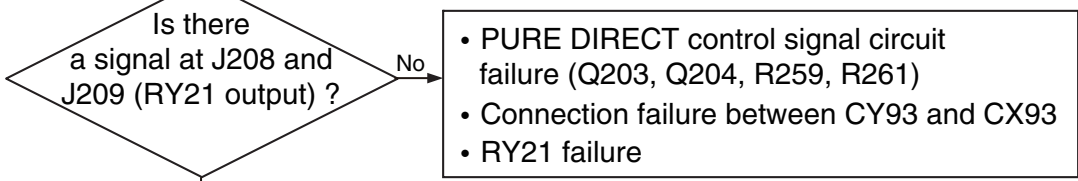
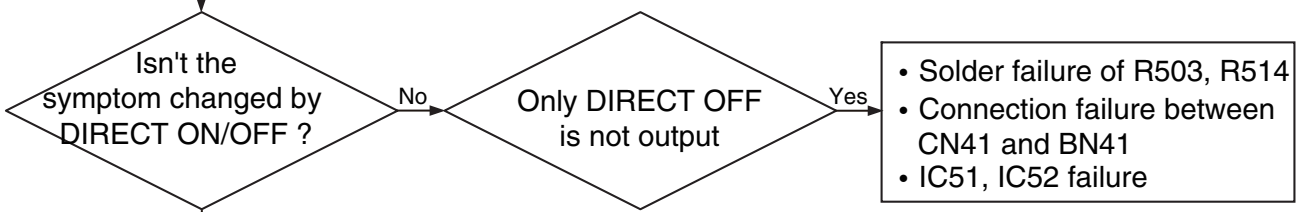

A-30 ONLY

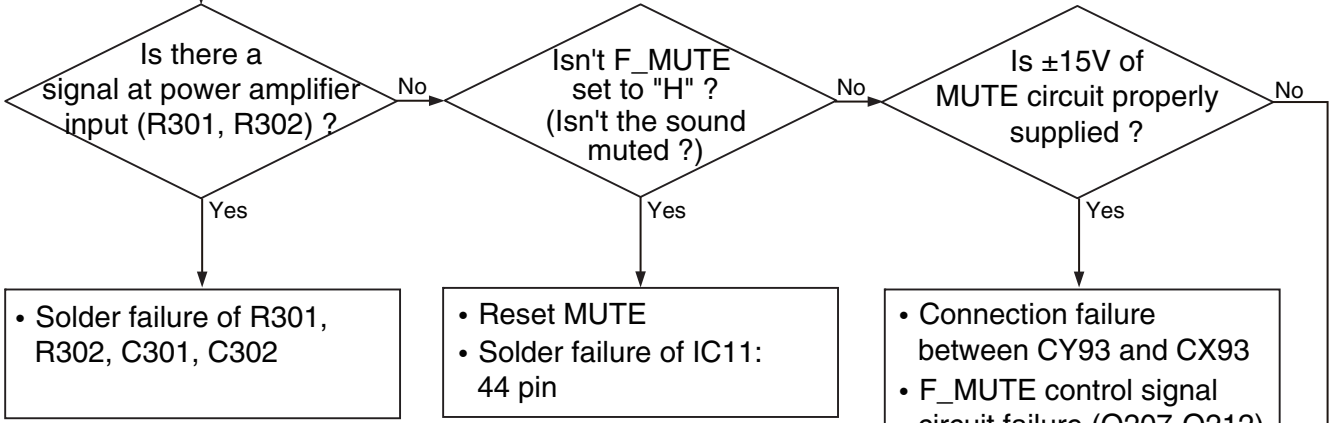

5.2 PROTECTION CIRCUIT DESCRIPTION

1. PROTECTION operation

Purpose of PROTECTION operation

- Protection of operation due to failure of product
 - Protection of operation due to wrong use by a user
- e.g.) Rare short of speaker connection is generated, or product is installed by blocking the heat release hole

1.1 DC DETECT

After DC DETECT is detected, MUTE ON & PROTECTION RELAY OFF are carried out.

If DC DETECT is detected for 3 seconds or more continuously, it is evaluated as "1.1.1 AMP failure" shown below.

If DC DETECT is detected for less than 3 seconds, it is evaluated as 1.1.2 SIGNAL CLIP" shown below.

1.1.1 AMP failure

If DC DETECT is detected for 3 seconds or more continuously, it is evaluated as "AMP failure" and the power is turned OFF.

If the power supply is automatically turned OFF after AMP failure is detected, all key operations are prohibited (power ON is prohibited).

For turn ON the power supply again, refer to "3. How to reset the prohibition of power ON" shown below.

1.1.2 SIGNAL CLIP

If DC DETECT is detected for less than 3 seconds, it is evaluated as "SIGNAL CLIP".

If the detection of DC DETECT is reset within 3 seconds, MUTE OFF & PROTECTION RELAY ON are carried out.

NOTE) If the detection of DC DETECT is reset within 3 seconds and DC detection functions immediately, PROTECTION RELAY OFF/ON is repeated, however, there is no problem.

1.2 OVER LOAD

MUTE ON & PROTECTION RELAY OFF are carried out immediately after the detection and the power is turned OFF.

After OVER LOAD is detected, the key operation is not prohibited (the power supply can be turned ON).

NOTE) If a short of speaker cable may be generated, the connection is made again and the power supply cannot be turned ON by a user, so a complaint is generated.

If AMP is broken actually, DC detection operates, so there is no problem.

1.3 Temperature PROTECTION

MUTE ON & PROTECTION RELAY OFF are carried out immediately after the detection and the power is turned OFF.

After temperature PROTECTION is detected, the key operation is not prohibited (the power supply can be turned ON).

NOTE) After the detection, if the temperature is still high even by turning ON the power supply, the temperature PROTECTION is detected again and the power supply is turned OFF.

1.4 Power PROTECTION

MUTE ON & PROTECTION RELAY OFF are carried out immediately after the detection and the power is turned OFF.

If the power supply is automatically turned OFF after the power PROTECTION is detected, all key operations are prohibited (power ON is prohibited).

For turn ON the power supply again, refer to "3. How to reset the prohibition of power ON" shown below.

2. Keeping the prohibition of power ON after 1.1.1 AMP failure is detected and 1.4 power PROTECTION is detected

If the power supply is automatically turned OFF after AMP failure is detected and power PROTECTION is detected, all key operations are prohibited (power ON is prohibited).

The power ON prohibition status is kept even if the backup is carried out and the power cord is disconnected and inserted.

For turn ON the power supply again, refer to "3. How to reset the prohibition of power ON" shown below.

3. How to reset the prohibition of power ON

A

Press Front Key [DIRECT] + [SPEAKER B] at the same time for 2 seconds or more continuously.
The key prohibition mode after 1.1.1 AMP failure is detected and 1.4. power PROTECTION is detected is released and the power supply is turned ON.

4. STANDBY LED display after PROTECTION is detected

Each PROTECTION operations above are identified by blinking timing of STANDBY LED.
The blinking of LED is continued until the power supply is turned ON again.

For the blinking specification of LED, refer to "Protect LED display specifications" shown below.

B

Protect LED display specifications

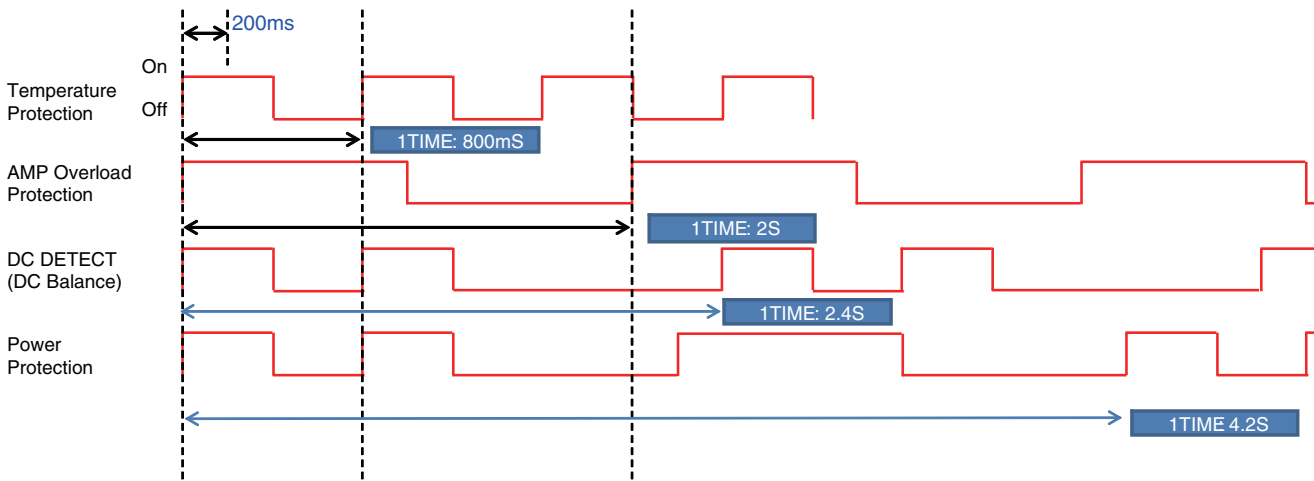

D

E

F

HVILC78212

(Analog Function Switch)

● Pin Layout

(Top View)

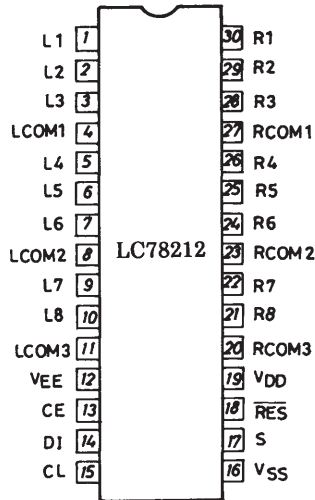

● Block Diagram

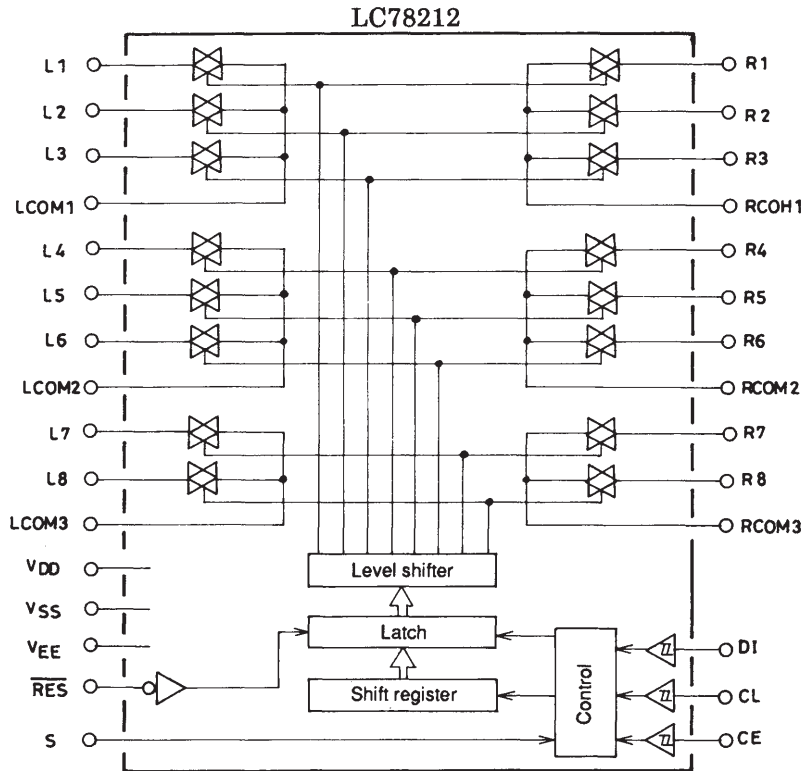

CVINJU7181RB1

(Signal Level Sensor System)

● Pin Layout

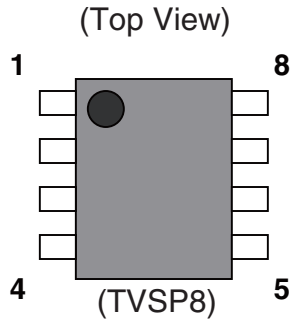

● Block Diagram

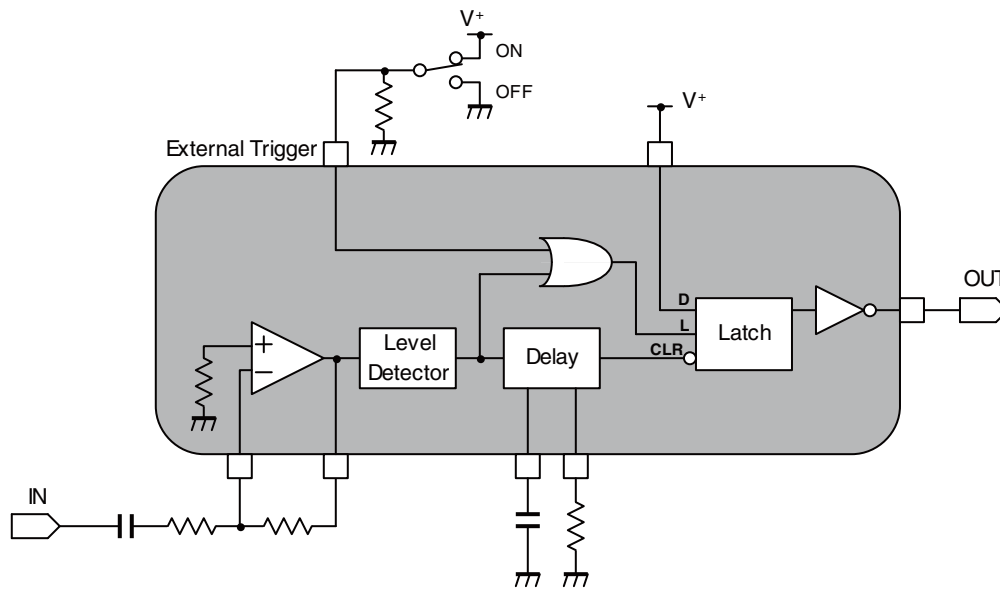

● Pin Function

No.	Pin Name	Function
1	IN	AC Input
2	AMP_OUT	Amplifier Output
3	TRIN	External Trigger Input
4	GND	Ground
5	CAP_D	Capacitor connection terminal for delay time setting
6	RES_D	Resister connection terminal for delay time setting
7	OUT	DC Output
8	V ⁺	Power Supply Voltage

CVIANAM1656A

(Micro Controller)

● Pin Layout

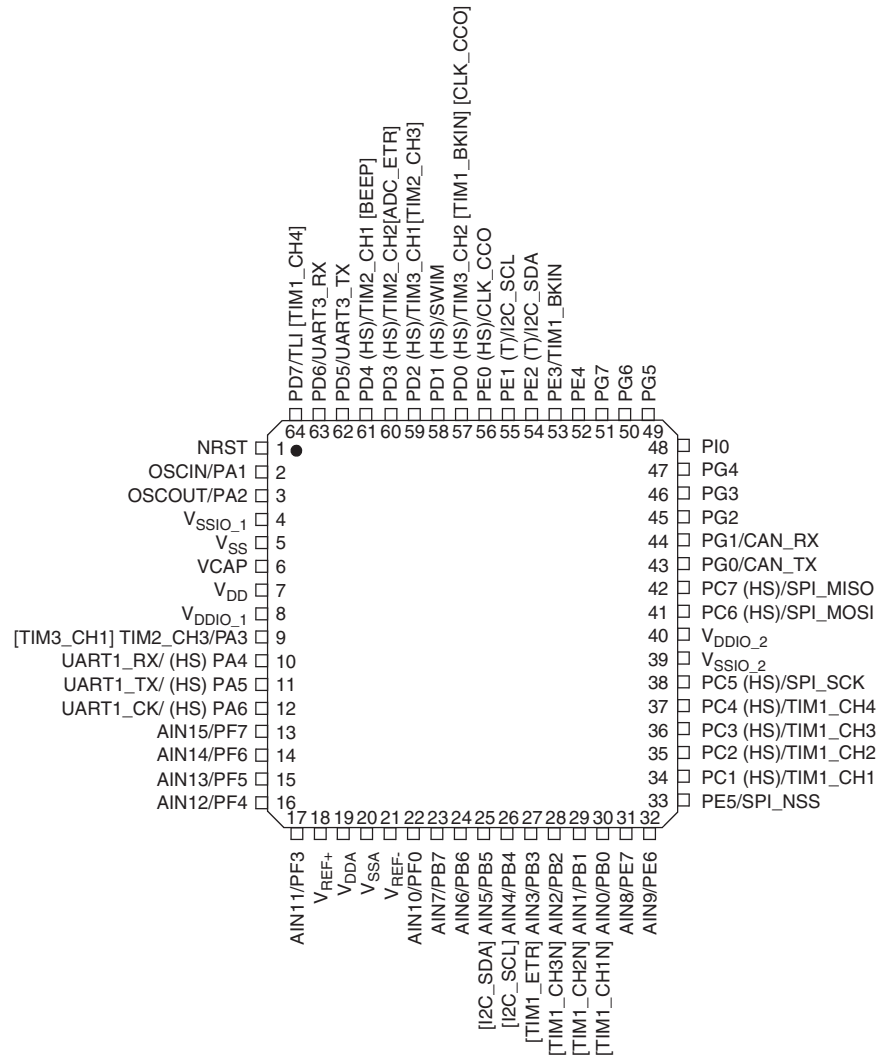

1. (HS) high sink capability.
2. (T) True open drain (P-buffer and protection diode to VDD not implemented).
3. [] alternate function remapping option (If the same alternate function is shown twice, it indicates an exclusive choice not a duplication of the function).
4. CAN_RX and CAN_TX is available on STM8S208xx devices only.

1

2

3

4

2/3

CVIANAM1656A

(Micro Controller)

● Block Diagram

The block diagram illustrates the internal architecture of the CVIANAM1656A microcontroller. A central vertical bar represents the **Address and data bus**. Various components are connected to this bus and to external interfaces.

Power and Clock Management:

- Reset block:** Includes a **Reset** input, **POR** (Programmable Open Reset), and **BOR** (Brown-Out Reset).
- Clock controller:** Receives input from **XTAL 1-24 MHz**, **RC int. 16 MHz**, and **RC int. 128 kHz**. It provides **Clock to peripherals and core**.

Core and Memory:

- STM8 core:** The central processing unit.
- Window WDG** and **Independent WDG** (Watchdog Timers).
- Up to 128 Kbytes high density program Flash**.
- Up to 2 Kbytes data EEPROM**.
- Up to 6 Kbytes RAM**.
- Boot ROM**.

Peripherals and Timers:

- Debug/SWIM:** Connected to **Single wire debug interf.**
- i²C:** Connected to **400 Kbit/s** interface.
- SPI:** Connected to **10 Mbit/s** interface.
- UART1:** Supports **LIN master** and **SPI emul.**
- UART3:** Supports **Master/slave autosynchro**.
- beCAN:** Connected to **1 Mbit/s** interface.
- ADC2:** Provides **16 channels**.
- Beeper:** Generates a **1/2/4 kHz beep**.
- Timers:**
 - 16-bit advanced control timer (TIM1):** Provides **Up to 4 CAPCOM channels + 3 complementary outputs**.
 - 16-bit general purpose timers (TIM2, TIM3):** Provide **Up to 5 CAPCOM channels**.
 - 8-bit basic timer (TIM4)**.
 - AWU timer** (Automatic Wake-Up timer).

20

A-30-K

1

2

3

4

CVIANAM1656A

(Micro Controller)

● Pin Function

Pins	Pin Name	TYPE	Main Function (After reset)	Default Alternate functions	USE	Status			Pin Description
						init	stby	Act.Lvl	
1	NRST	I/O				-	-	-	NRST
2	PA1/OSCIN	I/O	OSC_IN	GPIO	O	L	L	-	OSC_IN
3	PA2/OSCOOUT	I/O	OSC_OUT	GPIO	O	L	L	-	OSC_OUT
4	Vssio_1	S				-	-	-	VSSIO_1
5	Vss	S				-	-	-	VSS
6	Vcap	S				-	-	-	VCAP
7	Vdd	S				-	-	-	VDD
8	Vddio_1	S				-	-	-	VDDIO1
9	PA3/TIM2_CH3	I/O	PA3	TIM2_CH3	I	-	-	H	SEC_POWER
10	PA4/UART1_Rx	I/O	PA4	UART1	I/O	-	L	-	UPDATE_TX
11	PA5/UART1_Tx	I/O	PA5	UART1	O	H	L	L	UPDATE_RX
12	PA6/UART1_Clk	I/O	PA6	UART1	I	-	-	H	ECO_DETECT
13	PF7/AN15	I/O	PF7	ADC	O	L	L	L	STBY_LED
14	PF6/AN14	I/O	PF6	ADC	O	L	L	H	LOUDNESS_LED
15	PF5/AN13	I/O	PF5	ADC	O	L	L	H	SPEAKER_B_LED
16	PF4/AN12	I/O	PF4	ADC	O	L	L	H	SPEAKER_A_LED
17	PF3/AN11	I/O	PF3	ADC	O	L	L	H	P_AMP_DIRECT
18	Vref+	S				-	-	-	
19	Vdda	S				-	-	-	
20	Vssa	S				-	-	-	
21	Vref-	S				-	-	-	
22	PF0/AN10	I/O	PF0	ADC	O	L	L	H	P_AMP_LED
23	PB7/AN7	I/O	PB7	ADC	O	L	L	H	PHONO_LED
24	PB6/AN6	I/O	PB6	ADC	I	-	-	H	MODEL_OPT
25	PB5/AN5	I/O	PB5	ADC	O	L	L	H	TUNER_LED
26	PB4/AN4	I/O	PB4	ADC	O	L	L	H	RECORDER_LED
27	PB3/AN3	I/O	PB3	ADC	O	L	L	H	AUX_LED
28	PB2/AN2	I/O	PB2	ADC	O	L	L	H	NETWORK_LED
29	PB1/AN1	I/O	PB1	ADC	O	-	-	-	KEY_IN#2
30	PB0/AN0	I/O	PB0	ADC	O	-	-	-	KEY_IN#1
31	PE7/AN8	I/O	PE7	ADC	O	L	L	H	CD_LED
32	PE6/AN9	I/O	PE6	ADC	O	L	L	H	VR_DOWN
33	PE5/SPI_NSS	I/O	PE5	SPI	O	L	L	H	FUNC_CE
34	PC1/TIM1_CH1	I/O	PC1	TIM1_CH1	O	L	L	H	VR_UP
35	PC2/TIM1_CH2	I/O	PC2	TIM1_CH2	I	-	-	L	THERMAL_P
36	PC3	I/O	PC3		I	-	-	L	DC_DETECT
37	PC4/TIM1_CH4	I/O	PC4	TIM1_CH4	I	-	-	L	OVERLOAD_P
38	PC5/SPI_SCK	I/O	PC5	SPI	O	L	L	H/L	FUNC_CLK
39	Vssio_2	S				-	-	-	
40	Vddio_2	S				-	-	-	
41	PC6/SPI_MOSI	I/O	PC6	SPI	O	L	L	H/L	FUNC_DATA
42	PC7/SPI_MISO	I/O	PC7	SPI	I	-	-	L	VOLTAGE_P
43	PG0/CAN_Tx	I/O	PG0		O	H	H(OD)	H	REC_MUTE
44	PG1/CAN_Rx	I/O	PG1		O	H	H(OD)	H	F_MUTE
45	PG2	I/O	PG2		O	L	L	H	P_ON_RELAY
46	PG3	I/O	PG3		O	L	L	H	LOUDNESS
47	PG4	I/O	PG4		O	L	L	H	PURE_DIRECT
48	PI0	I/O	PI0		O	L	L	-	
49	PG5	I/O	PG5		O	L	L	H	SPEAKER_B
50	PG6	I/O	PG6		O	L	L	H	SPEAKER_A
51	PG7	I/O	PG7		O	L	L	H	PURE_DIRECT_LED
52	PE4	I/O	PE4		I	-	-	H/L	FUNCTION_EN1
53	PE3/TIM1_BKIN	I/O	PE3	TIM1_BKIN	I	-	-	H/L	FUNCTION_EN2
54	PE2/I2C_SDA	I/O	PE2	I2C	I	-	-	L	UPDATE_SEL
55	PE1/I2C_SCL	I/O	PE1	I2C	O	L	L	-	
56	PE0/CLK_CCO	I/O	PE0	CLK_CCO	O	L	L	H	POWER_LED
57	PD0/TIM3_CH2	I/O	PD0	TIM3_CH2	O	L	L	H	APD_LED
58	PD1/SWIM	I/O	DEBUG	GPIO	O				Debug Jig
59	PD2/TIM3_CH1	I/O	PD2	TIM3_CH1	I	-	-	H/L	REMOTE_IN
60	PD3/TIM2_CH2	I/O	PD3	TIM2_CH2	O	L	L	H	DIMMER
61	PD4/TIM2_CH1	I/O	PD4	TIM2_CH1	O	L	L	-	
62	PD5/UART3_Tx	I/O	PD5	UART3	O	L	L	-	
63	PD6/UART3_Rx	I/O	PD6	UART3	O	L	L	L	HP_MUTE
64	PD7/TLI	I/O	PD7	TLI	O	-	-	L	BACK_UP

6. SERVICE MODE

There is no information to be shown in this chapter.

7. DISASSEMBLY

Note 1 : Even if the unit shown in the photos and illustrations in this manual may differ from your product, the procedures described here are common.

Note 2 : As for the assembling, please perform assembling following to the opposite procedures of How to Disassemble. If any notes are existed, please follow those instructions.

Note 3 : Before starting the diagnosis, wait for several seconds until the electricity of the unit is discharged.

[1] Top Cabinet

- (1) Remove the four screws.
(A-30-K, A-20-K, A-20, A-10-K:)
CTB4+6FFZRP
(A-30-S, A-20-S, A-10-S:)
CTB4+6FFCP
- (2) Remove the five screws.
(BBZ30P060FTB)

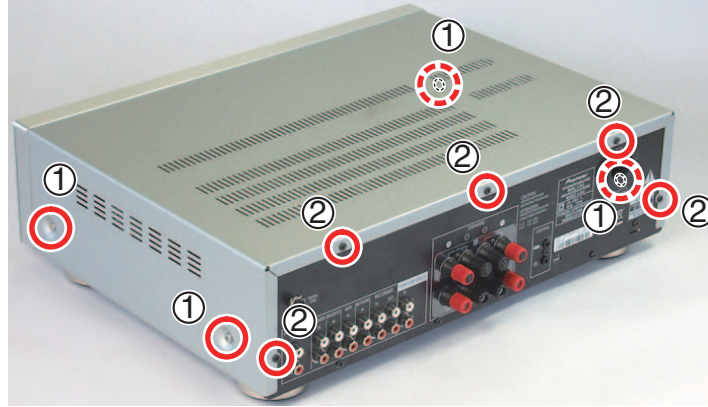

- (3) Insert nails between the Top Cabinet and Rear Panel and pull the Top Cabinet backward horizontally.

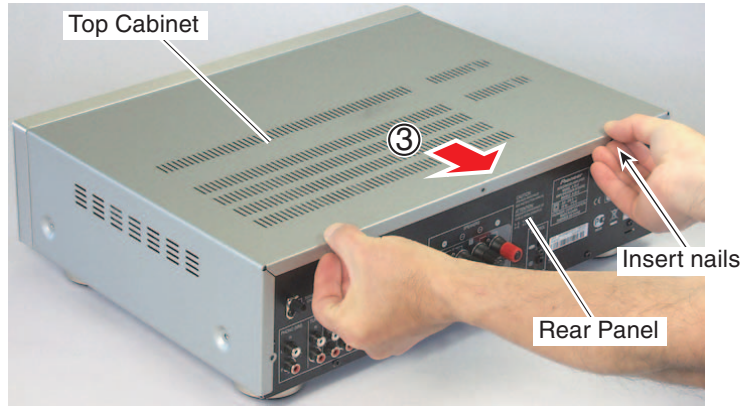

- (4) Take out Top Cabinet upward while spreading Rear Side Piece.

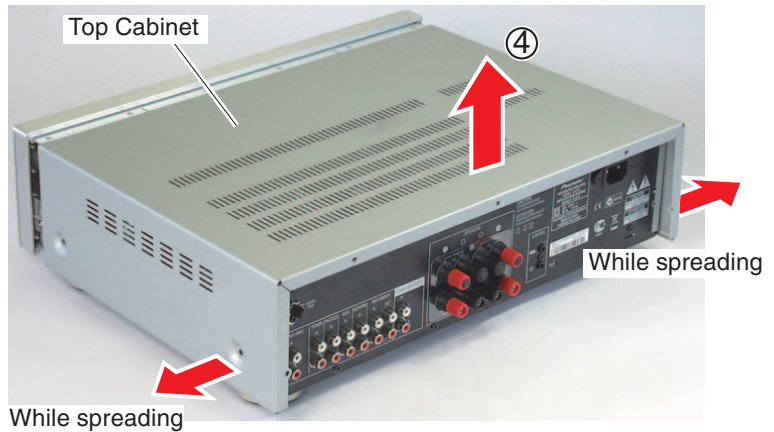

[2] Diagnosis

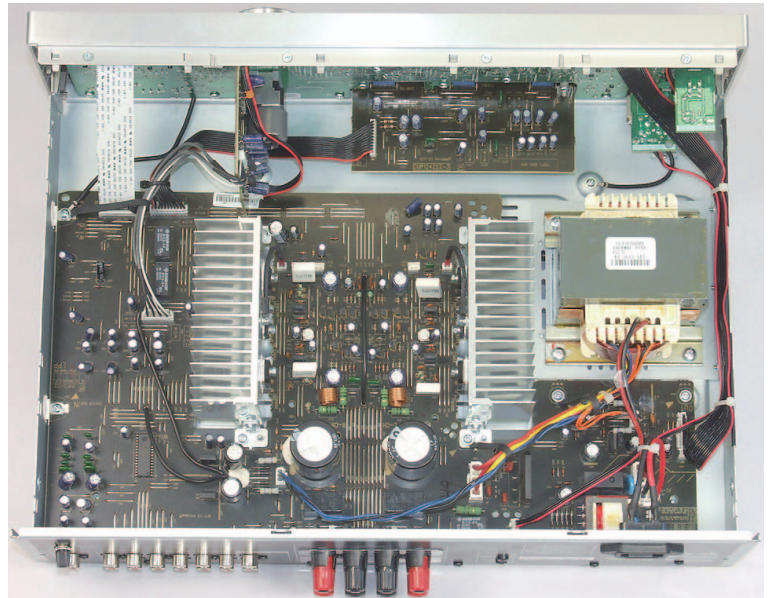

[3] Front Section

(1) Remove the screw. (CTW3+6JR)

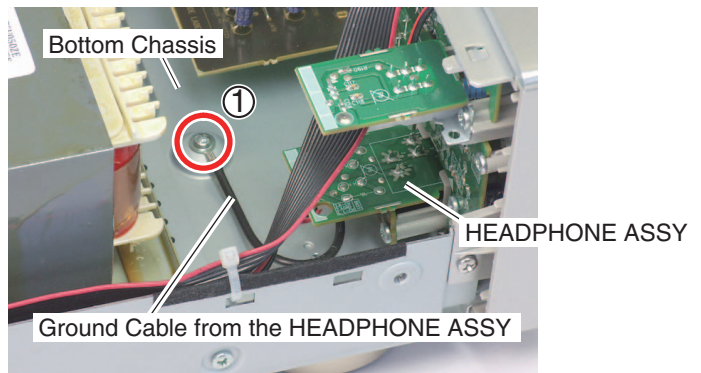

(2) Cut the two Clampers. (CHR301)

(3) Disconnect the two connectors.

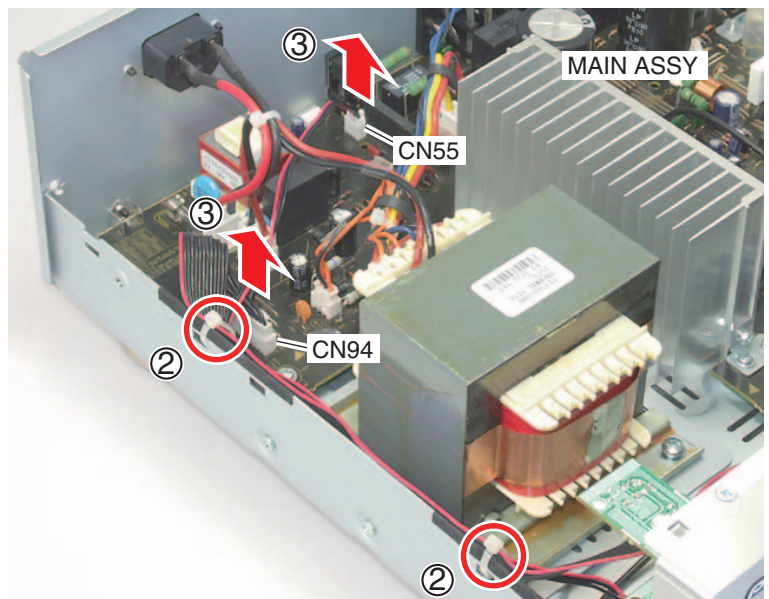

- (4) Disconnect the three connectors.
- (5) Remove the screw. (CTW3+6JR)

A

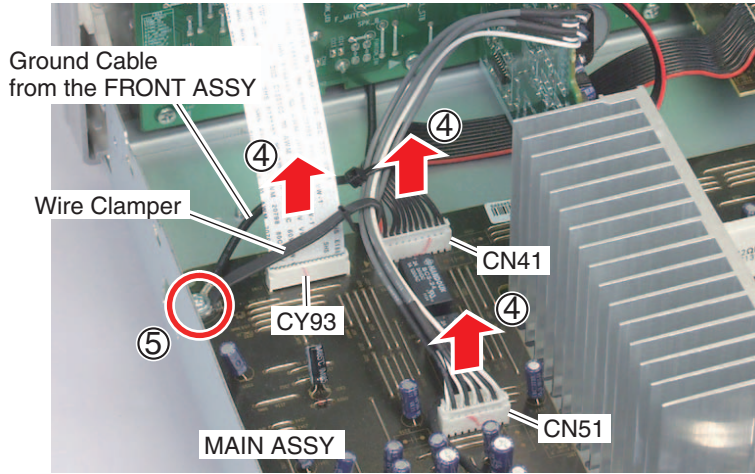

B



- (6) Remove the six screws.
 (A-30-K, A-20-K, A-20, A-10-K:)
 BBZ30P080FTB
 (A-30-S, A-20-S, A-10-S:)
 CTB3+8JFC

C

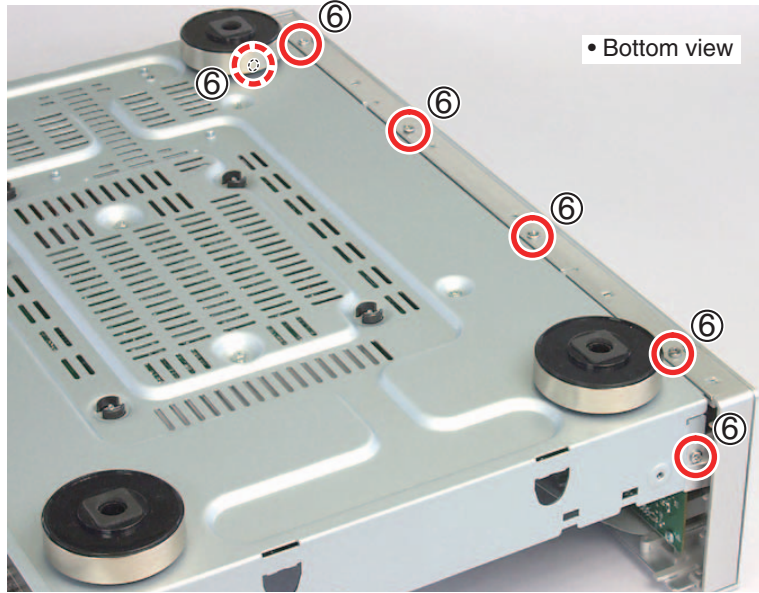

D



- (7) Unhook the two hooks and remove the Front Section.

E

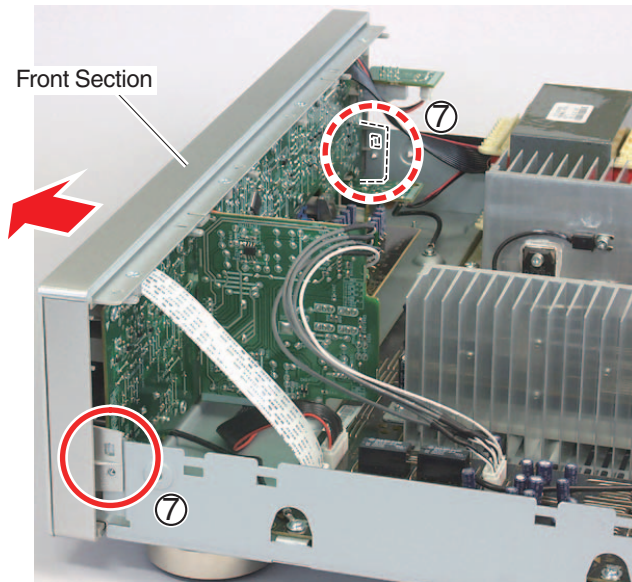

F

Notes on assembling

[1] Styling of cables

When you attach each unit, make styling, connection of cables and other parts as shown in the photo.

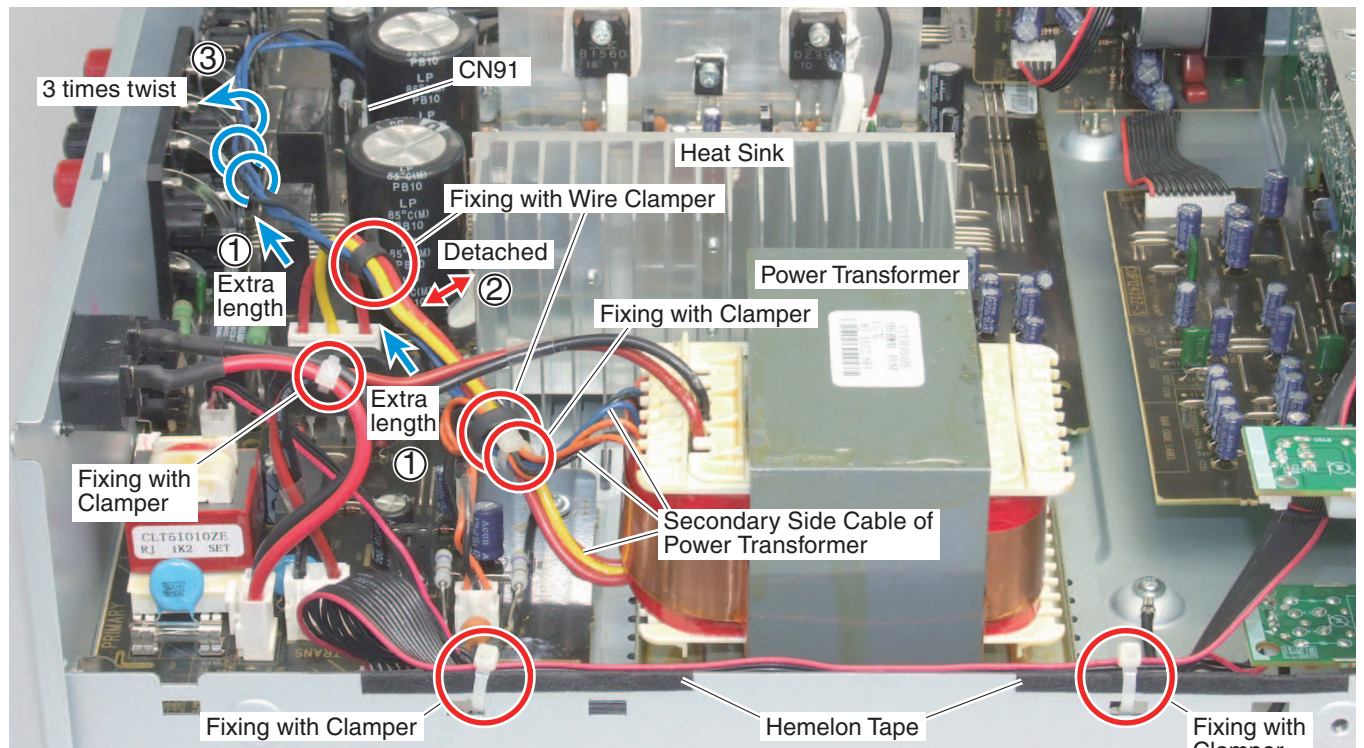

- (1) Secondary Side Cable of the Power Transformer (*)
Fix the cable from the position near the Power Transformer with a Clamper (x1) and Wire Clampers (x2) and release the extra length to the opposite direction of the Power Transformer.
- (2) Secondary Side Cable of the Power Transformer (*)
Release it not to touch with the Heat Sink.
- (3) Secondary Side Cable of the Power Transformer (*) connect to CN91
After checking it is not twisted, twist it three times.
- (4) Cable from the HEADPHONE ASSY
Release it not to touch with the Secondary Side Cable of Power Transformer.
- (5) Secondary Side Cable of the Power Transformer (*)
Release it not to touch with the D901.

* Power Transformer

(A-30-K, A-30-S:	CLT5U050ZE)
(A-20-K, A-20-S,	
(A-10-K, A-10-S:	CLT5R043ZE)
(A-20:	CLT5R043ZU)

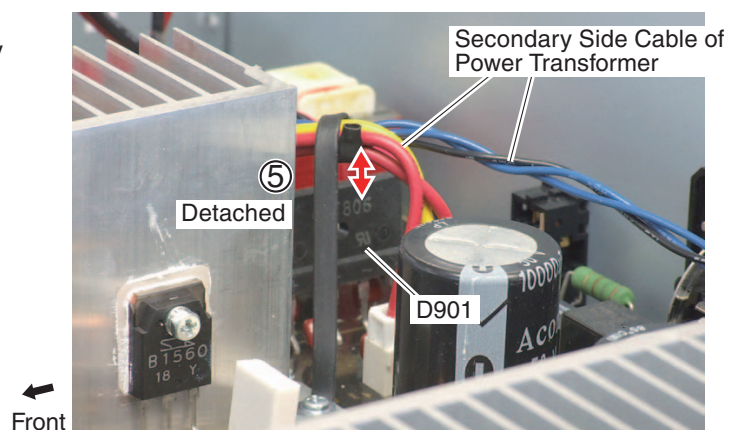
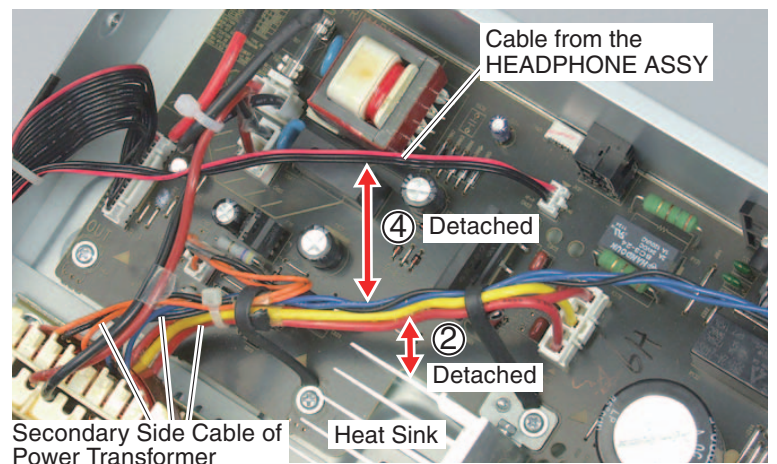

(6) Cable from the MASTER VOLUME ASSY
Fix it with the Cable from the TONE ASSY, using the Clamper. Release it not to touch with the Heat Sink.

(7) Cable from the MASTER VOLUME ASSY
Fix it with the Wire Clamper and release it not to touch with the Heat Sink.

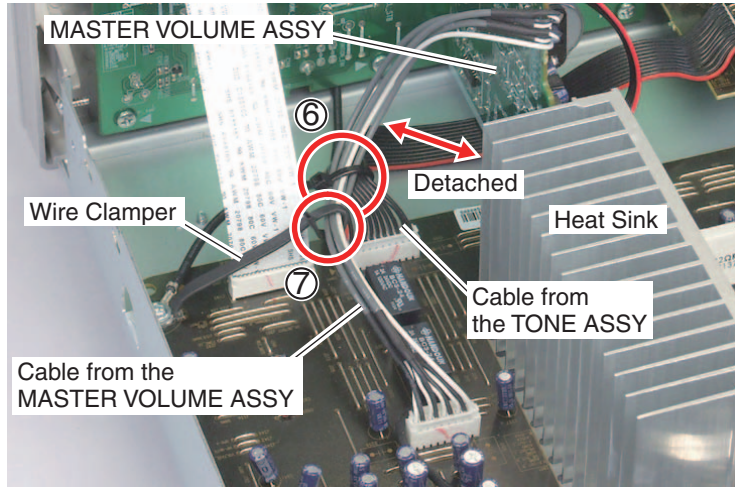

(8) Wrap the protrusion at the lower part of left front side of the Bottom Chassis with Hemelon Tape to prevent short with the FRONT ASSY.

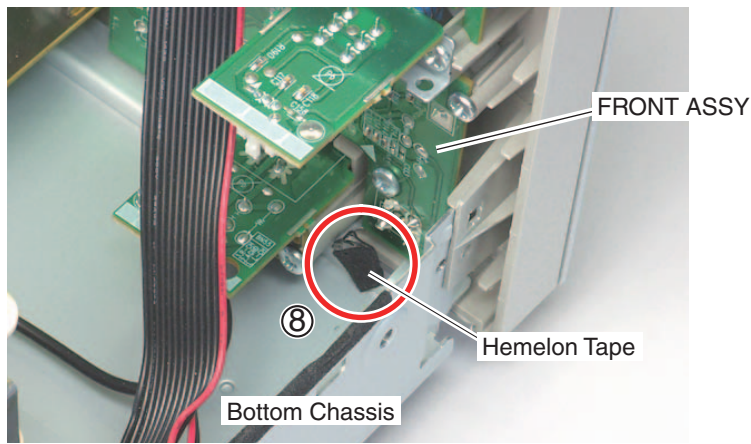

(9) Cable of right and left Temperature Sensors
Release it not to touch with the transistor (Q319, Q320).

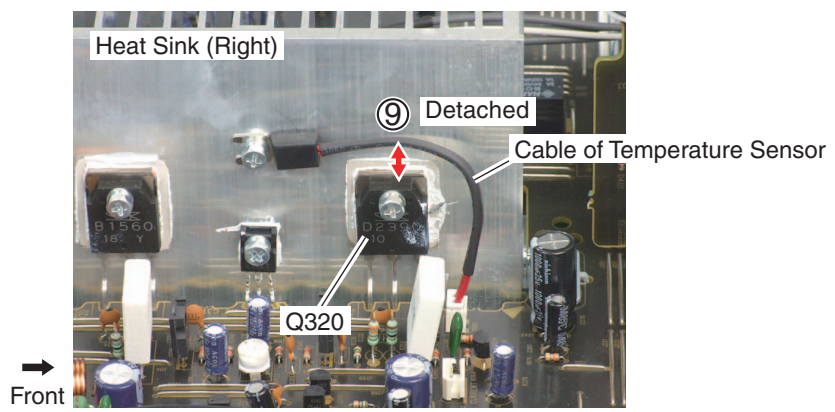
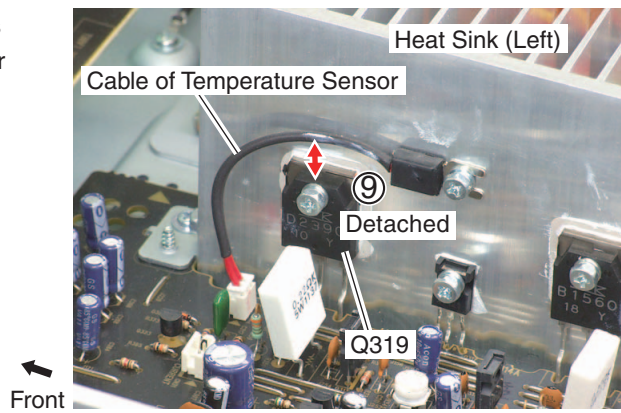

[2] Direction of Insulator

Align the mark at under surface of the Insulator with the direction of photo.

(A-30-K, A-20-K, A-20, A-10-K:)
CKL1A204

(A-30-S, A-20-S, A-10-S:)
CKL1A204H65

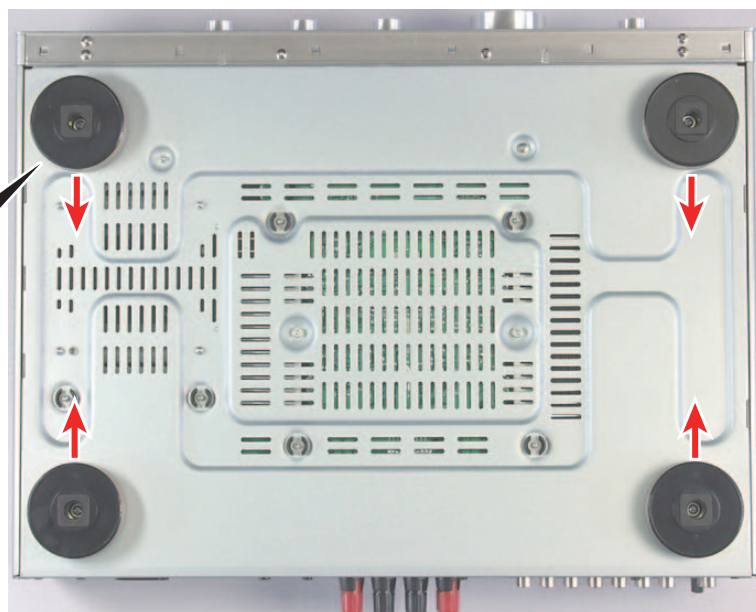
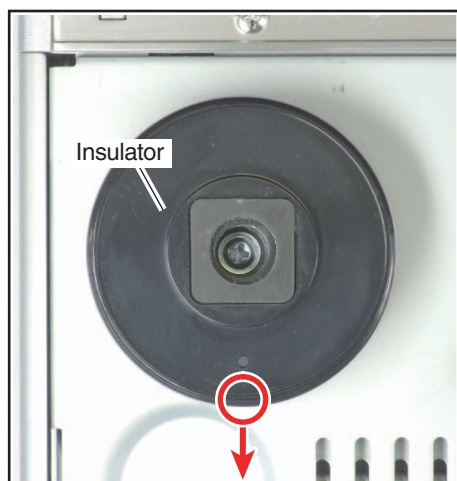

[3] Where to attach the sound quality improvement tape

Acetate Tape or Double Side Tape is attached to some parts in this model to improve sound quality. When the following components are replaced, be sure to attach designated the Acetate Tape and Double Side Tape again to the designated location. Concerning the Acetate Tape, if it is difficult to reuse the Tape, order a new Tape and attach it. (You can use other Acetate Tape than that designated by cutting it to a designated size.)

The Double Side Tape cannot be reused easily. When the knob is removed, attach a new Tape.

(1) Panel section

Attach two pieces of Acetate Tape (Part No.: CHS1A217, 10 mm x 15 mm) to a flat surface around the Volume Knob as shown in the photo.

Be sure to attach the Tape to a flat surface.

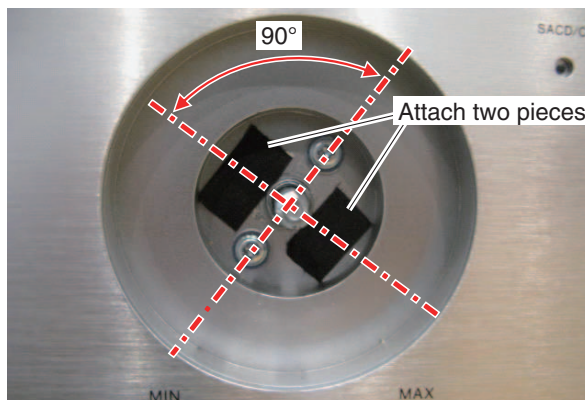

(2) MASTER VOLUME ASSY

Attach a piece of Acetate Tape (Part No.: CHS1A217, 10 mm x 15 mm) to the specified position on the lateral side of the Electric Volume as shown in the photo.

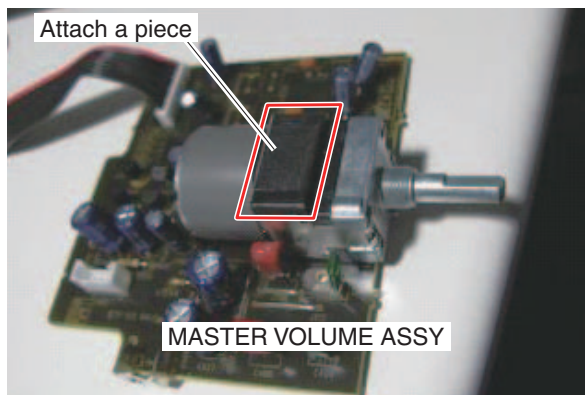

(3) FRONT ASSY

Attach two pieces of Acetate Tape (Part No.: CHS1A217, 10 mm x 15 mm) to the pattern surface of the FRONT ASSY as shown in the photo. The Acetate Tape comes between the Electric Volume and the FRONT ASSY, but fix them directly with screws from the FRONT ASSY.

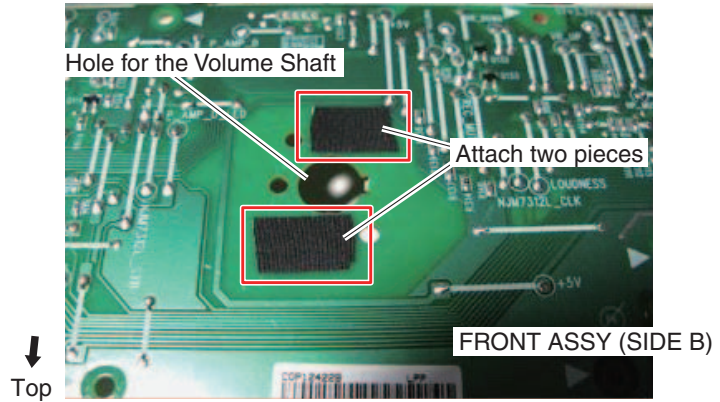

(4) Top Cabinet

Attach four pieces of Acetate Tape (Part No.: CHS1A218, 5 mm x 25 mm) to the front side of the reverse surface at the same location as that of the Top Cushion.

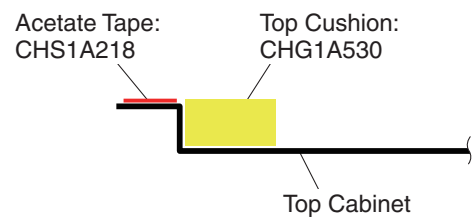

(5) FRONT ASSY (INPUT SELECTOR), TONE ASSY

(Carry out the operation shown below when Volume part or Encoder part of each ASSY is replaced too)

Attach a piece of Double Side Tape (Part No.: C4FA051, 5 mm x 5 mm) to flat surface at the tip of each axis at Volume part and axis at Encoder part.

Each axis of BASS, TREBLE and BALANCE in TONE ASSY

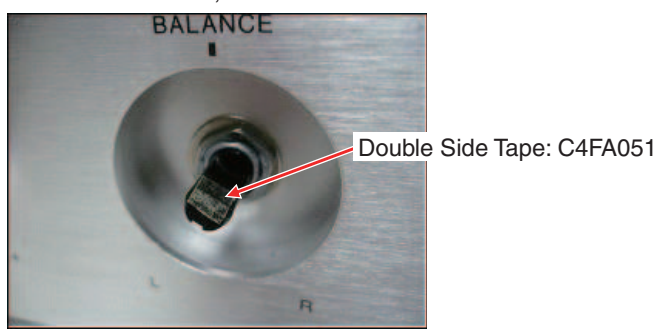

INPUT SELECTOR part

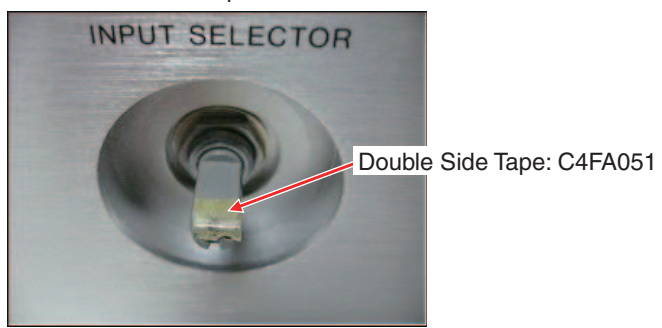

8. EACH SETTING AND ADJUSTMENT

8.1 HOW TO CHECK THE FIRMWARE VERSION

1. In STANDBY status, press Front Key [DIRECT] + [SPEAKERS A] at the same time (5 seconds).

At this time, the version can be checked with the indicator.

Major Version				Minor1						Minor2	
SPK A	SPK B	LOUD	No USE	CD	NET A	PHONO	TUNER	AUX	REC	0	PURE D
<input type="checkbox"/>	<input type="checkbox"/>	<input type="checkbox"/>	No USE	<input type="checkbox"/>	<input type="checkbox"/>	<input type="checkbox"/>	<input type="checkbox"/>	<input type="checkbox"/>	<input type="checkbox"/>	0	<input type="checkbox"/>
<input type="checkbox"/>	<input type="checkbox"/>	<input checked="" type="checkbox"/>	1	<input type="checkbox"/>	<input type="checkbox"/>	<input type="checkbox"/>	<input type="checkbox"/>	<input type="checkbox"/>	<input checked="" type="checkbox"/>	1	<input checked="" type="checkbox"/>
<input type="checkbox"/>	<input checked="" type="checkbox"/>	<input type="checkbox"/>	2	<input type="checkbox"/>	<input type="checkbox"/>	<input type="checkbox"/>	<input type="checkbox"/>	<input checked="" type="checkbox"/>	<input type="checkbox"/>	2	<input type="checkbox"/>
<input type="checkbox"/>	<input checked="" type="checkbox"/>	<input checked="" type="checkbox"/>	3	<input type="checkbox"/>	<input type="checkbox"/>	<input type="checkbox"/>	<input checked="" type="checkbox"/>	<input type="checkbox"/>	<input type="checkbox"/>	3	<input type="checkbox"/>
<input checked="" type="checkbox"/>	<input type="checkbox"/>	<input type="checkbox"/>	4	<input type="checkbox"/>	<input type="checkbox"/>	<input checked="" type="checkbox"/>	<input type="checkbox"/>	<input type="checkbox"/>	<input type="checkbox"/>	4	<input type="checkbox"/>
<input checked="" type="checkbox"/>	<input type="checkbox"/>	<input checked="" type="checkbox"/>	5	<input type="checkbox"/>	<input checked="" type="checkbox"/>	<input type="checkbox"/>	<input type="checkbox"/>	<input type="checkbox"/>	<input type="checkbox"/>	5	<input type="checkbox"/>
<input checked="" type="checkbox"/>	<input checked="" type="checkbox"/>	<input type="checkbox"/>	6	<input checked="" type="checkbox"/>	<input type="checkbox"/>	<input type="checkbox"/>	<input type="checkbox"/>	<input type="checkbox"/>	<input type="checkbox"/>	6	<input type="checkbox"/>
<input checked="" type="checkbox"/>	<input checked="" type="checkbox"/>	<input checked="" type="checkbox"/>	7	<input type="checkbox"/>	<input type="checkbox"/>	<input type="checkbox"/>	<input type="checkbox"/>	<input type="checkbox"/>	<input type="checkbox"/>		<input type="checkbox"/>

<e.g.> Ver.3.6.0

<input type="checkbox"/>	<input checked="" type="checkbox"/>	<input checked="" type="checkbox"/>	3	<input checked="" type="checkbox"/>	<input type="checkbox"/>	<input type="checkbox"/>	<input type="checkbox"/>	<input type="checkbox"/>	<input type="checkbox"/>	6	<input type="checkbox"/>
--------------------------	-------------------------------------	-------------------------------------	---	-------------------------------------	--------------------------	--------------------------	--------------------------	--------------------------	--------------------------	---	--------------------------

If the power supply is turned ON in this status, the product is reset to the factory-shipping status.

8.2 FIRMWARE UPDATING

[Necessary Tool]

- Firmware
- PC with a serial port (for PC without a serial port, a commercially-available USB serial conversion cable is also available)
- RS-232C cable (9-pin to 9-pin, straight cable)
- RS-232C update jig: GGF1675 (use included FFC (7P to 7P))

[Connection Diagram]

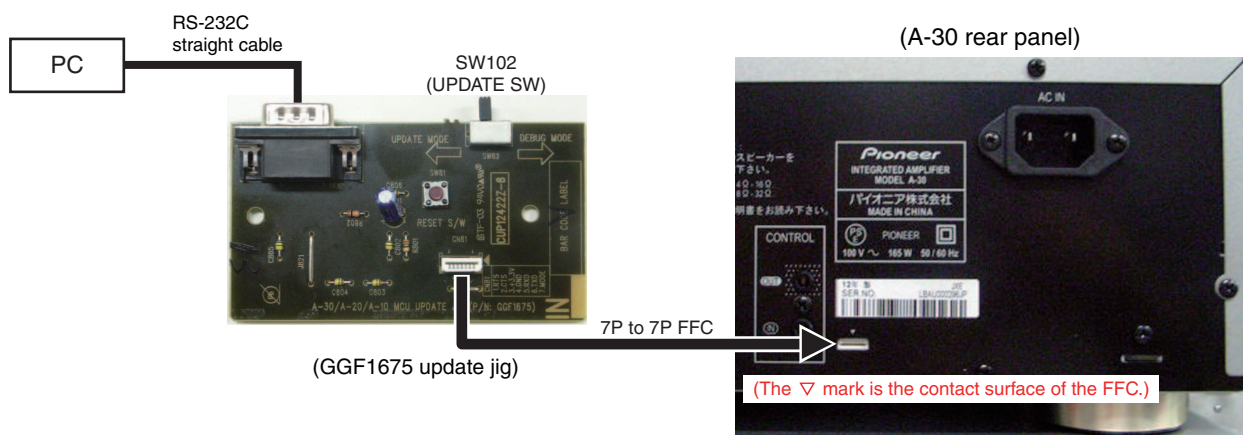

[Update Procedure]

1. Connect UPDATE JIG (GGF1675) to A-30/20/10 and PC when the power cord is disconnected.
 MAIN ASSY CN95 ⇔ UPDATE JIG CN101
 PC (RS-232C connector) ⇔ UPDATE JIG JK101

2. Set SW102 (UPDATE SW) of UPDATE JIG to UPDATE MODE side and connect the power cord.
 (At this time, the front LED enters in Update Mode (Waiting) status)

3. Prepare update application and update file.

It is necessary to store 3 files in the same folder of PC.

- a. PioneerAxxUpdate.ini : Update Information File
- b. UpdateAppPioneerA30_1v2.exe : Windows Update Application File
- c. PIONEER_A-30SOFT_REL.BIN : Update Binary File

4. Double-click UpdateAppPioneerA30_1v2.exe and start up the update application.

5. Select the serial port you connected and click "START UPDATE" button.
 (At this time, the front LED enters in Update Mode (Updating) status)

Click -->

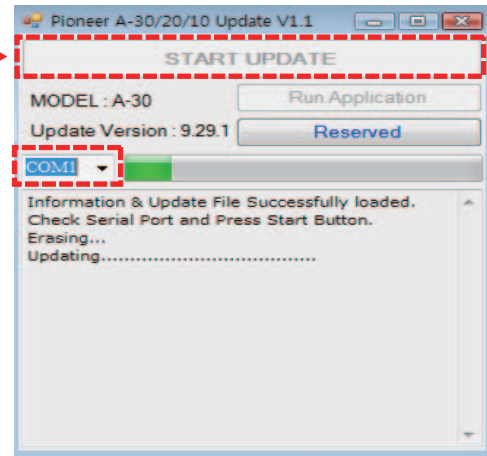

* If the update cannot be executed because of "Connection Error" message, connect RS-232C cable again and carry out the operation from the beginning.

6. If "Updating completed" is displayed, quit the update application and disconnect the power cord.

7. Disconnect UPDATE JIG.

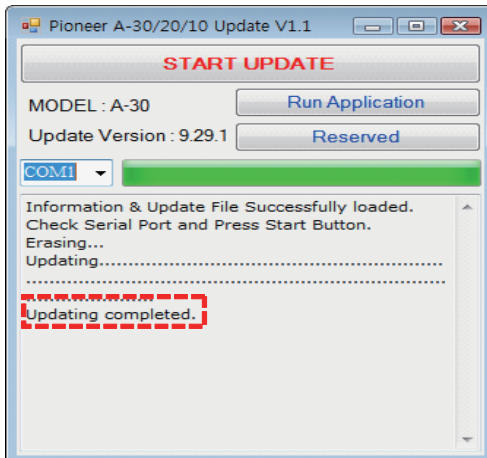

LED display at update

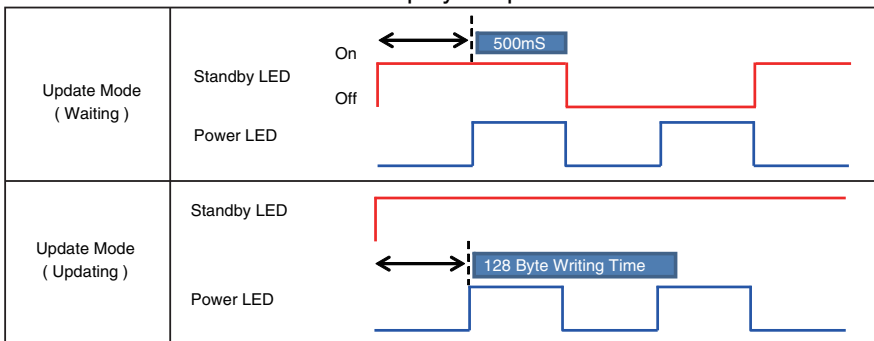

8.3 HOW TO ADJUST THE IDLE CURRENT

[Adjustment Condition]

Idle current needs to be adjusted when the following components are replaced:

- 1. MAIN ASSY (Adjust the idle current for both channels)
- 2. Components within the red frame (excluding the capacitors)
The circuit diagram below is for Lch, but it is only necessary to adjust the idle current only for the channel in which the components are replaced.

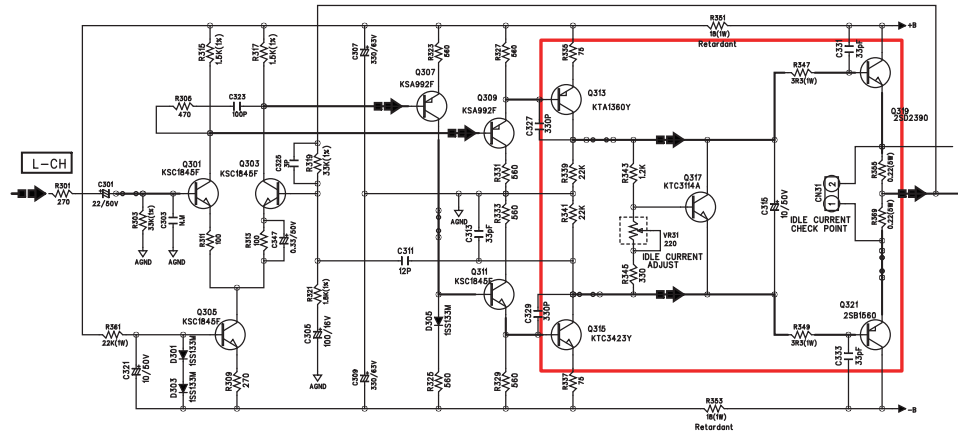

[Adjustment Procedure]

- 1. Turn ON the power supply of the product.
- 2. Set INPUT SELECTOR to SACD/CD and set VOL to MIN, and wait for 3 minutes.
- 3. Connect a multi-meter to CN31 and CN32 of MAIN ASSY.
- 4. Adjust VR31 and VR32 so that DC LEVEL becomes 8 ± 2 mV.

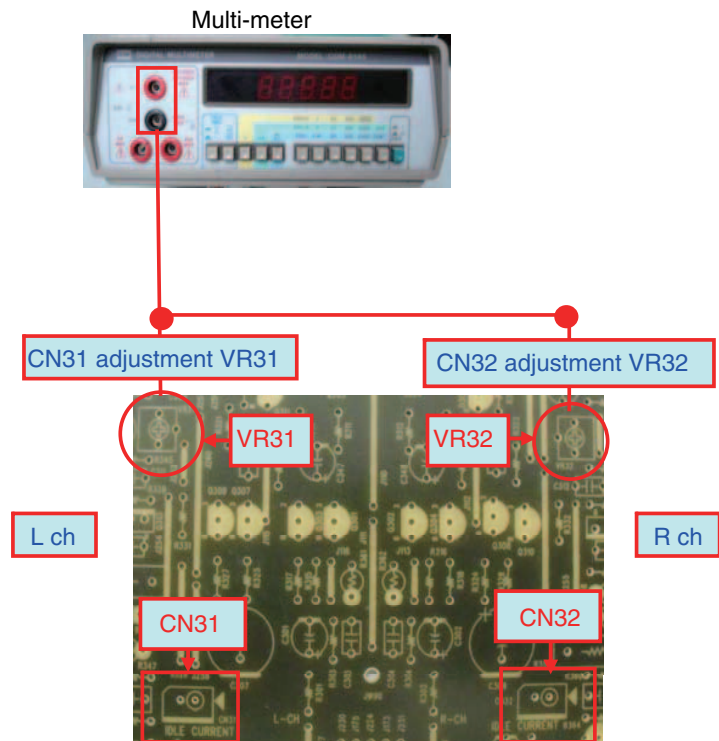

9. EXPLODED VIEWS AND PARTS LIST

- NOTES:
- Parts marked by "NSP" are generally unavailable because they are not in our Master Spare Parts List.
 - The \triangle mark found on some component parts indicates the importance of the safety factor of the part. Therefore, when replacing, be sure to use parts of identical designation.
 - Screws adjacent to ∇ mark on product are used for disassembly.
 - For the applying amount of lubricants or glue, follow the instructions in this manual. (In the case of no amount instructions, apply as you think it appropriate.)

9.1 PACKING SECTION

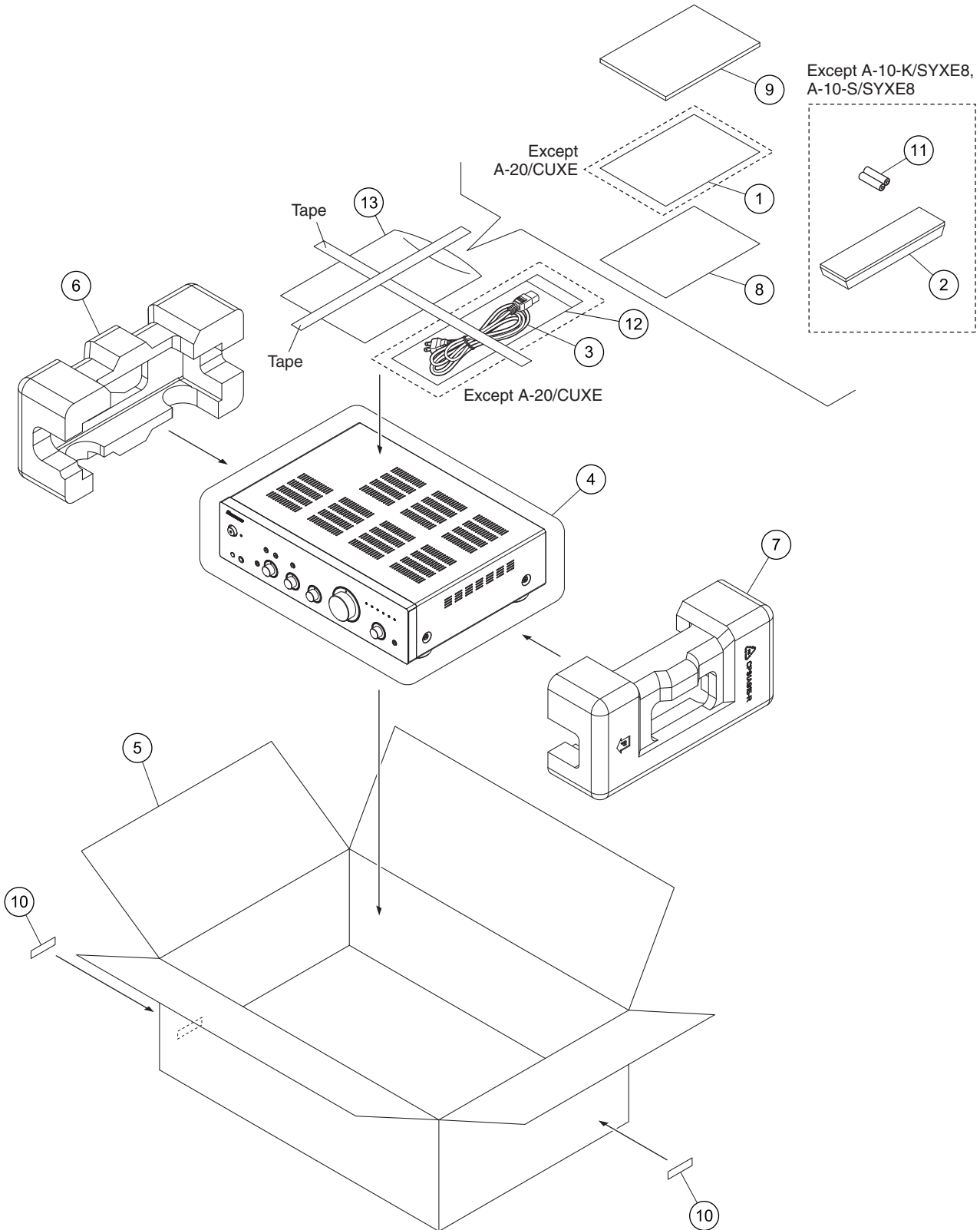

(1) PACKING SECTION PARTS LIST

Mark No.	Description	Part No.
	1 Warranty Card SY	See Contrast table (2)
	2 Remote Control Unit	See Contrast table (2)
⚠	3 AC Power Cord	See Contrast table (2)
	4 Polyethylene Bag	CPB1A013W
	5 Packing Case	See Contrast table (2)
	6 Packing Pad (L)	CPS1A914
	7 Packing Pad (R)	CPS1A915
	8 Speaker Caution En	CQE1A539Z
	9 Operating Instructions	See Contrast table (2)
NSP	10 Serial Label S	VRW2017
NSP	11 AAA/R03 Dry Cell Battery x 2	•••••
	12 Polyethylene Bag (Accessory)	See Contrast table (2)
	13 Polyethylene Bag (Manual)	CPB1A197Z

(2) CONTRAST TABLE

A-30-K/PWSYXE8, A-30-S/PWSYXE8, A-20-K/PWSYXE8, A-20-S/PWSYXE8, A-20/CUXE, A-10-K/SYXE8 and A-10-S/SYXE8 are constructed the same except for the following:

Mark	No.	Symbol and Description	A-30-K/ PWSYXE8	A-30-S/ PWSYXE8	A-20-K/ PWSYXE8	A-20-S/ PWSYXE8	A-20/ CUXE	A-10-K/ SYXE8	A-10-S/ SYXE8
⚠	1	Warranty Card SY	CQE1A541Z	CQE1A541Z	CQE1A541Z	CQE1A541Z	Not used	CQE1A541Z	CQE1A541Z
	2	Remote Control Unit	CARTA30	CARTA30	CARTA20	CARTA20	CARTA20	Not used	Not used
	3	AC Power Cord	CJA2B054Z	CJA2B054Z	CJA2B108ZV	CJA2B108ZV	Not used	CJA2B108ZV	CJA2B108ZV
	5	Packing Case	CPG1A961Z	CPG1A961W	CPG1A961Y	CPG1A961U	CPG1A961T	CPG1A961X	CPG1A961R
	9	Operating Instructions	CQX1A1640Y	CQX1A1640Y	CQX1A1640Y	CQX1A1640Y	CQX1A1644Z	CQX1A1640Y	CQX1A1640Y
	12	Polyethylene Bag (Accessory)	CPB1A008Z	CPB1A008Z	CPB1A008Z	CPB1A008Z	Not used	CPB1A008Z	CPB1A008Z

9.2 EXTERIOR SECTION (A-30/A-20)

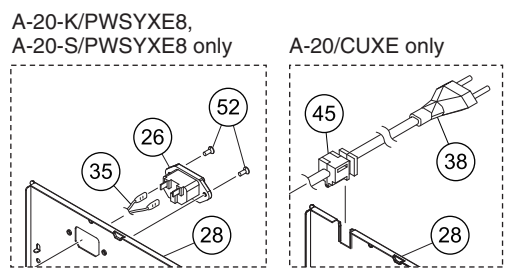
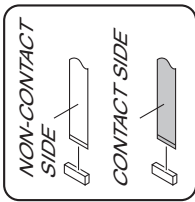
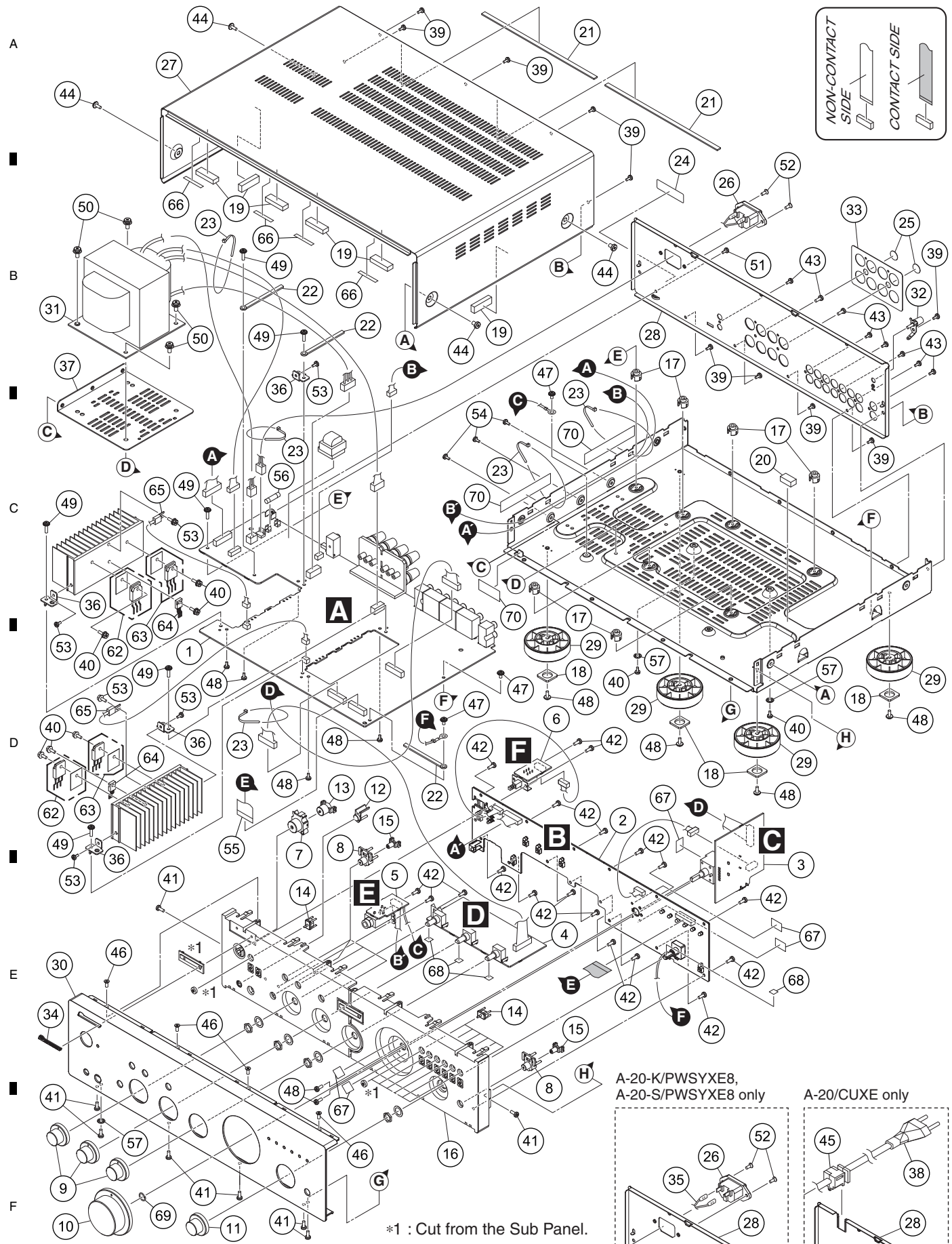

*1 : Cut from the Sub Panel.

(1) EXTERIOR SECTION (A-30/A-20) PARTS LIST

<u>Mark No.</u>	<u>Description</u>	<u>Part No.</u>	<u>Mark No.</u>	<u>Description</u>	<u>Part No.</u>
1	MAIN ASSY	See Contrast table (2)	36	Heat Sink Bracket	CMD1A800
2	FRONT ASSY	See Contrast table (2)	37	Trans Bracket	CMD1A801
3	MASTER VOLUME ASSY	See Contrast table (2)	△	38 AC Power Cord (CU)	See Contrast table (2)
4	TONE ASSY	AZW7477	39	Screw	BBZ30P060FTB
5	HEADPHONE ASSY	AZW7479	40	Special Screw	CHD3A012R
6	SECOUND POWER SW ASSY	AZW7478	41	Screw	See Contrast table (2)
7	Power Knob	See Contrast table (2)	42	Screw	CTB3+8JR
8	Function Knob	See Contrast table (2)	43	Screw	BBZ30P100FTB
9	Balance Knob	See Contrast table (2)	44	Screw	See Contrast table (2)
10	Volume Knob	See Contrast table (2)	45	AC Cord Bushing	See Contrast table (2)
11	Input Knob	See Contrast table (2)	46	Screw	See Contrast table (2)
12	IR Window	See Contrast table (2)	47	Screw	CTW3+6JR
13	Power Indicator	CGL1A296	48	EOL Item Screw	CTW3+8JR
14	Standby Indicator	CGL1A297	49	Screw	CTW3+12JR
15	Funkcion Indicator	CGL1A298	50	Trans Screw	CHDR1A023R
16	Sub Panel	See Contrast table (2)	51	Screw	BSZ30P060FTB
17	PCB Holder	CHE170	52	Screw	See Contrast table (2)
18	Foot Cushion	CHG1A528	53	Special Screw	CHD4A012R
19	Top Cushion	CHG1A530	54	Screw	CTB3+6JR
20	Main Cushion	CHG1A531	55	17P FFC Cable	CWC4F4A17B150B10
21	PEF Cushion	CHG1A532	△	56 Fuse (250V)	See Contrast table (2)
22	Wire Clamper	CHK1A009	57	Ground Washer	CNW1A035
23	Clamper	CHR301	58	•••••	
NSP	24 Serial Label S	VRW2017	59	•••••	
25	Cover Sheet	CHS1A154	60	•••••	
26	AC Inlet	See Contrast table (2)	61	•••••	
27	Top Cabinet	See Contrast table (2)	62	Power TR	CVT2SD2390P43M
28	Rear Panel	See Contrast table (2)	63	Power TR	CVT2SB1560P43M
29	Insulator	See Contrast table (2)	64	Bias TR	HVTKTC3114A
30	AL Panel	See Contrast table (2)	65	Posistor ASSY	CRTDHTS100070W2
△	31 Power Transformer	See Contrast table (2)	66	Acetate Tape (5 x 25)	CHS1A218
32	Ground Terminal	CMA1A006	67	Acetate Tape (10 x 15)	CHS1A217
33	Speaker Sheet	CMZ1A139Z	68	Double Side Tape	C4FA051
34	Pioneer Badge (AL)	See Contrast table (2)	69	Knob Spring	CUS2A169
35	AC Inlet Wire (SY)	See Contrast table (2)	70	Hemelon Tape	CHS1A032

(2) CONTRAST TABLE

A-30-K/PWSYXE8, A-30-S/PWSYXE8, A-20-K/PWSYXE8, A-20-S/PWSYXE8 and A-20/CUXE are constructed the same except for the following:

Mark	No.	Symbol and Description	A-30-K/ PWSYXE8	A-30-S/ PWSYXE8	A-20-K/ PWSYXE8	A-20-S/ PWSYXE8	A-20/ CUXE	
A	1	MAIN ASSY	AZW7487	AZW7487	AZW7489	AZW7489	AZW7490	
	2	FRONT ASSY	AZW7482	AZW7482	AZW7483	AZW7483	AZW7484	
	3	MASTER VOLUME ASSY	AZW7476	AZW7476	AZW7481	AZW7481	AZW7481	
	7	Power Knob	CBT1A1162	CBT1A1162C81	CBT1A1162	CBT1A1162C81	CBT1A1162	
	8	Funktion Knob	CBT1A1163	CBT1A1163MQG69	CBT1A1163	CBT1A1163MQG69	CBT1A1163	
	9	Balance Knob	CGK1A164ZA	CGK1A164YA	CBN1A260	CBN1A260MQG69	CBN1A260	
	10	Volume Knob	CGK1A165ZA	CGK1A165YA	CBN1A262	CBN1A262MQG69	CBN1A262	
	11	Input Knob	CGK2A164ZA	CGK2A164YA	CBN1A261	CBN1A261MQG69	CBN1A261	
	12	IR Window	CGL1A295Z	CGL1A295	CGL1A295Z	CGL1A295	CGL1A295Z	
	16	Sub Panel	CGW1A517	CGW1A517MQG69	CGW1A517	CGW1A517MQG69	CGW1A517	
	B	26	AC Inlet	CJJ8A006ZW	CJJ8A006ZW	CJJ8A018Z	CJJ8A018Z	Not used
		27	Top Cabinet	CKC2A214B62	CKC2A214G70	CKC2A214B62	CKC2A214G70	CKC2A214B62
		28	Rear Panel	CKF1A452Z	CKF1A452R	CKF2A452X	CKF2A452Q	CKF4A452W
		29	Insulator	CKL1A204	CKL1A204H65	CKL1A204	CKL1A204H65	CKL1A204
		30	AL Panel	CKM1A243ZC79	CKM1A243YC80	CKM2A243XC79	CKM2A243WC80	CKM2A243VC79
		C	⚠ 31	Power Transformer	CLT5U050ZE	CLT5U050ZE	CLT5R043ZE	CLT5R043ZE
34	Pioneer Badge (AL)		BAM1004	VAM1124	BAM1004	VAM1124	PAN1376	
35	AC Inlet Wire (SY)		Not used	Not used	CWZA10CN96A	CWZA10CN96A	Not used	
⚠ 38	Power Cord (CU)		Not used	Not used	Not used	Not used	CJA523FBYA	
41	Screw		BBZ30P080FTB	CTB3+8JFC	BBZ30P080FTB	CTB3+8JFC	BBZ30P080FTB	
C	44	Screw	CTB4+6FFZRP	CTB4+6FFCP	CTB4+6FFZRP	CTB4+6FFCP	CTB4+6FFZRP	
	45	AC Cord Bushing	Not used	Not used	Not used	Not used	CHR1A028	
	46	Screw	CTS3+8JFZR	CTS3+8JR	CTB3+8JFZR	CTB3+8JFZR	CTB3+8JFZR	
	⚠ 52	Screw	CBZ30P080FTB	CBZ30P080FTB	CTB3+8JFZR	CTB3+8JFZR	Not used	
	⚠ 56	Fuse (250V)	CBA2C2000TLEC	CBA2C2000TLEC	CBA2C2000TLEC	CBA2C2000TLEC	CBA2C3150TLEC	

■

5

■

6

■

7

■

8

■

A

■

B

■

C

■

D

■

E

■

F

■

5

■

6

A-30-K

■

7

■

8

■

9.3 EXTERIOR SECTION (A-10)

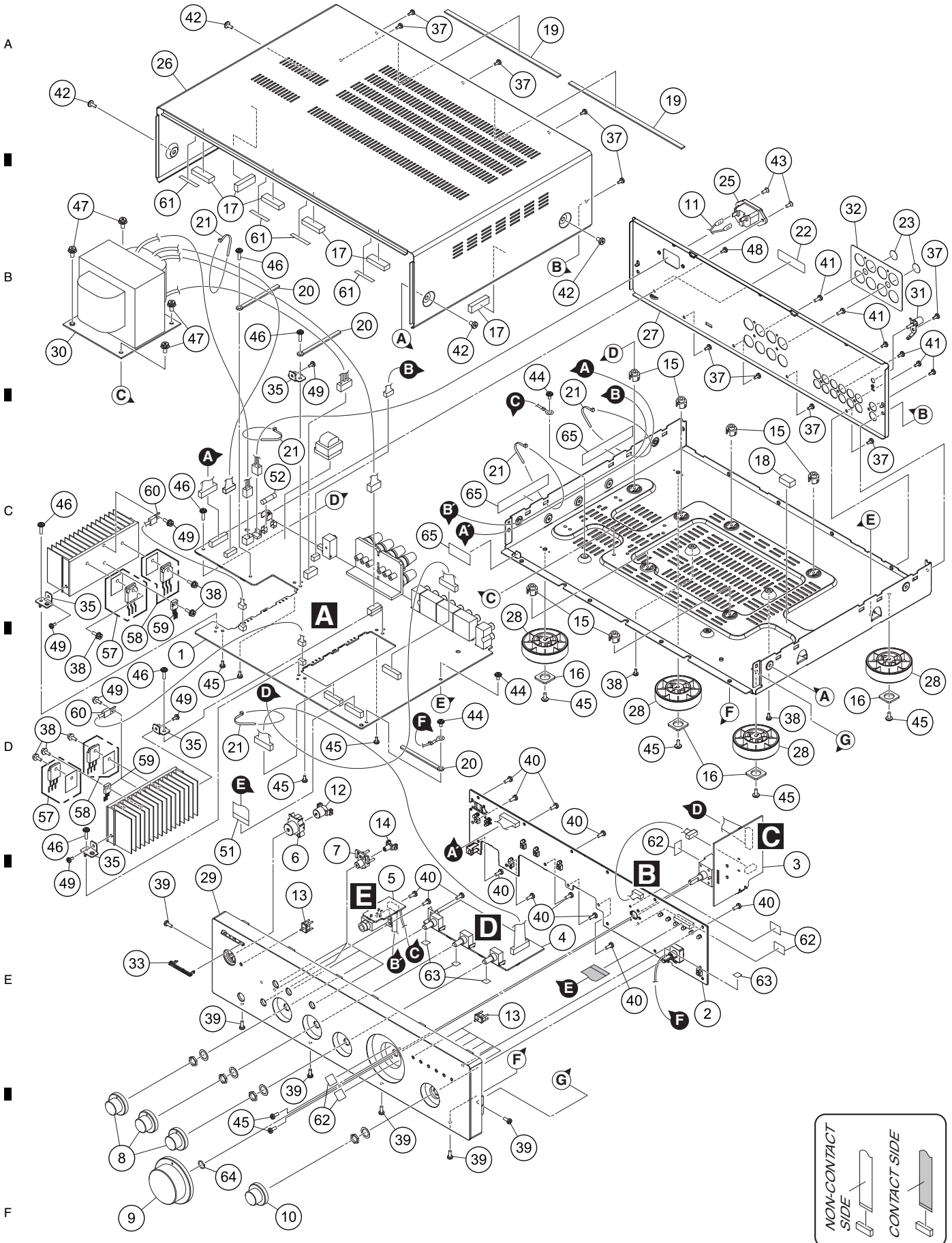

(1) EXTERIOR SECTION (A-10) PARTS LIST

<u>Mark No.</u>	<u>Description</u>	<u>Part No.</u>	<u>Mark No.</u>	<u>Description</u>	<u>Part No.</u>
1	MAIN ASSY	AZW7491	36	•••••	
2	FRONT ASSY	AZW7485	37	Screw	BBZ30P060FTB
3	MASTER VOLUME ASSY	AZW7481	38	Special Screw	CHD3A012R
4	TONE ASSY	AZW7477	39	Screw	See Contrast table (2)
5	HEADPHONE ASSY	AZW7479	40	Screw	CTB3+8JR
6	Power Knob	See Contrast table (2)	41	Screw	BBZ30P100FTB
7	Function Knob	See Contrast table (2)	42	Screw	See Contrast table (2)
8	Balance Knob	See Contrast table (2)	43	Screw	CTB3+8JFZR
9	Volume Knob	See Contrast table (2)	44	Screw	CTW3+6JR
10	Input Knob	See Contrast table (2)	45	EOL Item Screw	CTW3+8JR
11	AC Inlet Wire (SY)	CWZA10CN96A	46	Screw	CTW3+12JR
12	Power Indicator	CGL1A296	47	Trans Screw	CHDR1A023R
13	Standby Indicator	CGL1A297	48	Screw	BSZ30P060FTB
14	Function Indicator	CGL1A298	49	Special Screw	CHD4A012R
15	PCB Holder	CHE170	50	•••••	
16	Foot Cushion	CHG1A528	51	17P FFC Cable	CWC4F4A17B150B10
17	Top Cushion	CHG1A530	52	Fuse (250V 2A)	CBA2C2000TLEC
18	Main Cushion	CHG1A531	53	•••••	
19	PEF Cushion	CHG1A532	54	•••••	
20	Wire Clamper	CHK1A009	55	•••••	
21	Clamper	CHR301	56	•••••	
NSP 22	Serial Label S	VRW2017	57	Power TR	CVT2SD2390P43M
23	Cover Sheet	CHS1A154	58	Power TR	CVT2SB1560P43M
24	•••••		59	Bias TR	HVTKTC3114A
25	AC Inlet (Screw Type)	CJJ8A018Z	60	Posistor ASSY	CRTDHTS100070W2
26	Top Cabinet	See Contrast table (2)	61	Acetate Tape (5 x 25)	CHS1A218
27	Rear Panel	See Contrast table (2)	62	Acetate Tape (10 x 15)	CHS1A217
28	Insulator	See Contrast table (2)	63	Double Side Tape	C4FA051
29	Front Panel	See Contrast table (2)	64	Knob Spring	CUS2A169
⚠ 30	Power Transformer (74 x 53) SY	CLT5R043ZE	65	Hemelon Tape	CHS1A032
31	Ground Terminal	CMA1A006			
32	Speaker Sheet	CMZ1A139Z			
33	Pioneer Badge	See Contrast table (2)			
34	•••••				
35	Heat Sink Bracket	CMD1A800			

(2) CONTRAST TABLE

A-10-K/SYXE8 and A-10-S/SYXE8 are constructed the same except for the following:

<u>Mark No.</u>	<u>Symbol and Description</u>	<u>A-10-K/ SYXE8</u>	<u>A-10-S/ SYXE8</u>
6	Power Knob	CBT1A1162	CBT1A1162C81
7	Function Knob	CBT1A1163	CBT1A1163MQG69
8	Balance Knob	CBN1A260	CBN1A260MQG69
9	Volume Knob	CBN1A262	CBN1A262MQG69
10	Input Knob	CBN1A261	CBN1A261MQG69
26	Top Cabinet	CKC2A214B62	CKC2A214G70
27	Rear Panel	CKF3A452U	CKF3A452P
28	Insulator	CKL1A204	CKL1A204H65
29	Front Panel	CGW2A518H10Z	CGW2A518MQG69Y
33	Pioneer Badge	AAM7016	VAM1129
39	Screw	BBZ30P080FTB	CTB3+8JFC
42	Screw	CTB4+6FFZRP	CTB4+6FFCP

A MAIN ASSY
(A-30-K/-S : AZW7487)
(A-20-K/-S : AZW7489)
(A-20 : AZW7490)
(A-10-K/-S : AZW7491)

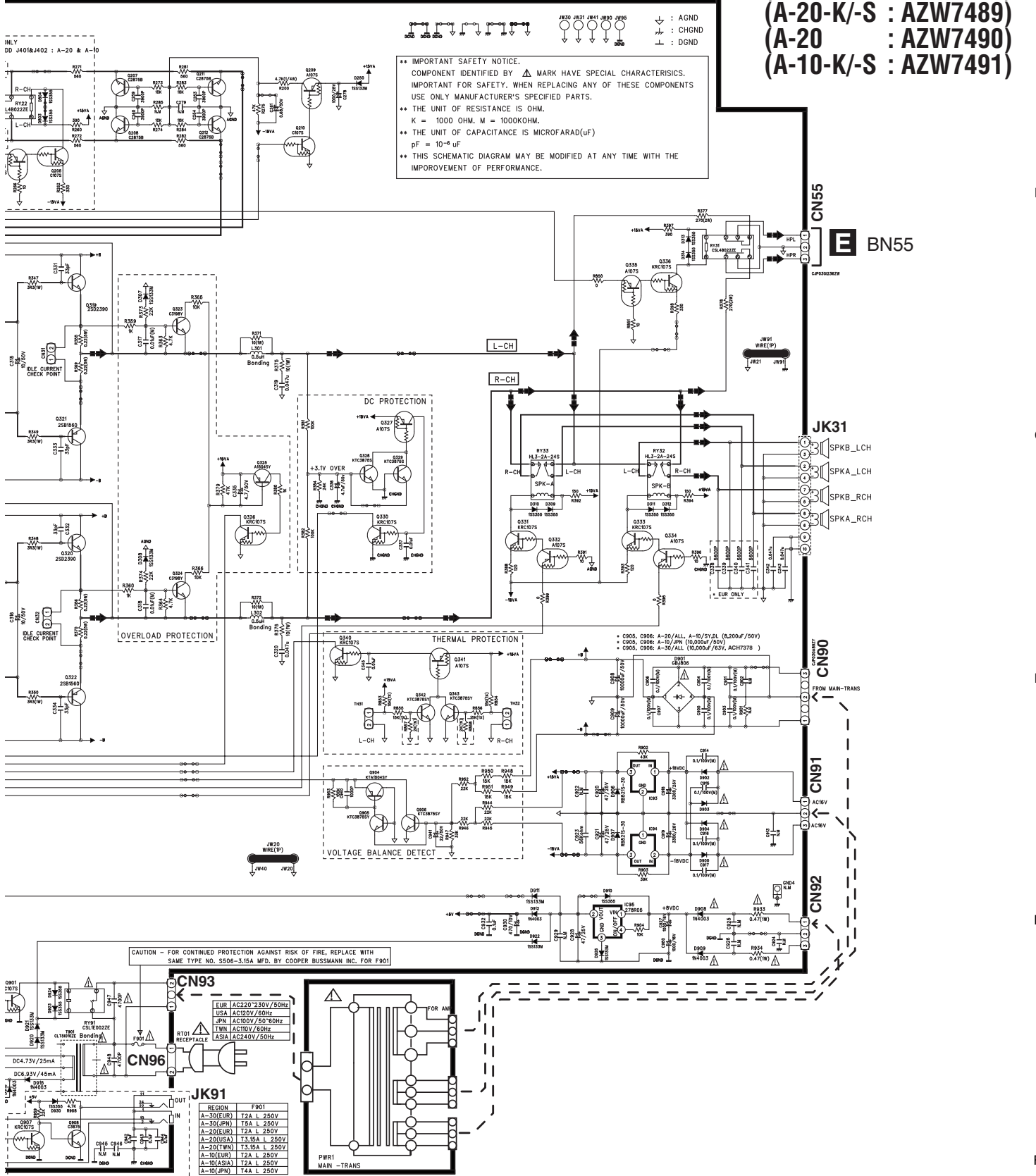

IMPORTANT SAFETY NOTICE.
 COMPONENT IDENTIFIED BY Δ MARK HAVE SPECIAL CHARACTERISTICS.
 IMPORTANT FOR SAFETY, WHEN REPLACING ANY OF THESE COMPONENTS
 USE ONLY MANUFACTURER'S SPECIFIED PARTS.
 • THE UNIT OF RESISTANCE IS OHM.
 K = 1000 OHM, M = 1000KOHM.
 • THE UNIT OF CAPACITANCE IS MICROFARAD(μ F)
 pF = 10^{-8} μ F
 • THIS SCHEMATIC DIAGRAM MAY BE MODIFIED AT ANY TIME WITH THE
 IMPROVEMENT OF PERFORMANCE.

CAUTION - FOR CONTINUED PROTECTION AGAINST RISK OF FIRE, REPLACE WITH
 SAME TYPE NO. S506-3.15A MFD. BY COOPER BUSSMANN INC. FOR F901

REGION	F901
A-30(EUR)	T2A L 250V
A-30(JPN)	T2A L 250V
A-20(EUR)	T2A L 250V
A-20(USA)	T3.15A L 250V
A-20(TWN)	T3.15A L 250V
A-10(EUR)	T2A L 250V
A-10(ASIA)	T2A L 250V
A-10(JPN)	T4A L 250V

• When ordering service parts, be sure to refer to "EXPLODED VIEWS AND PARTS LIST" or "PCB PARTS LIST".
 • The Δ mark found on some component parts indicates the importance of the safety factor of the part.
 Therefore, when replacing, be sure to use parts of identical designation.



10.2 FRONT ASSY and SECOND POWER SW ASSY (A-30/A-20)

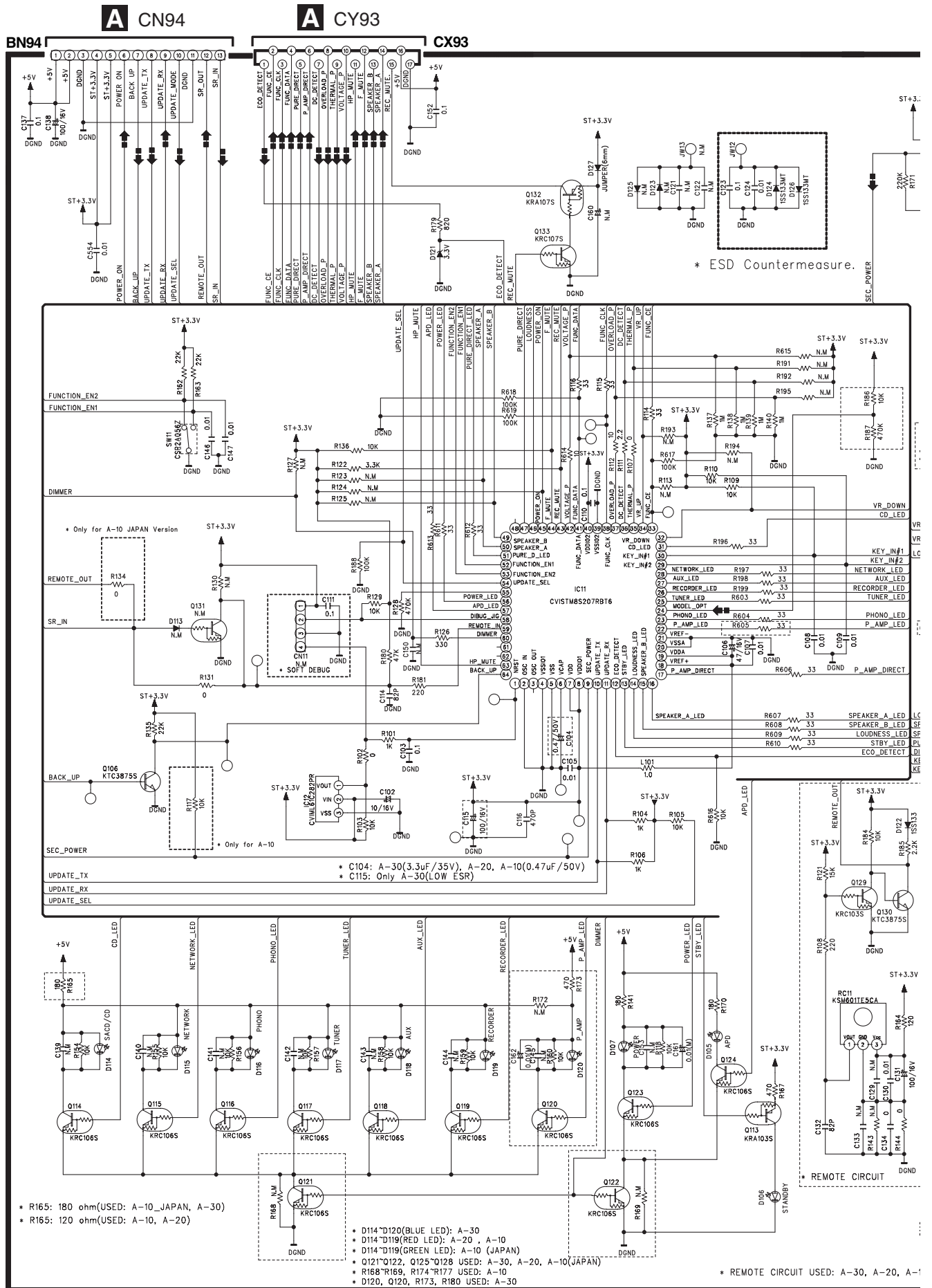

F SECOND POWER SW ASSY (A-30-K/-S, A-20-K/-S, A-20 : AZW7478)

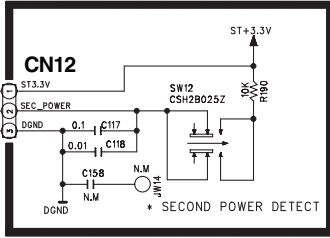

B FRONT ASSY (A-30-K/-S : AZW7482) (A-20-K/-S : AZW7483) (A-20 : AZW7484) (A-10-K/-S : AZW7485)

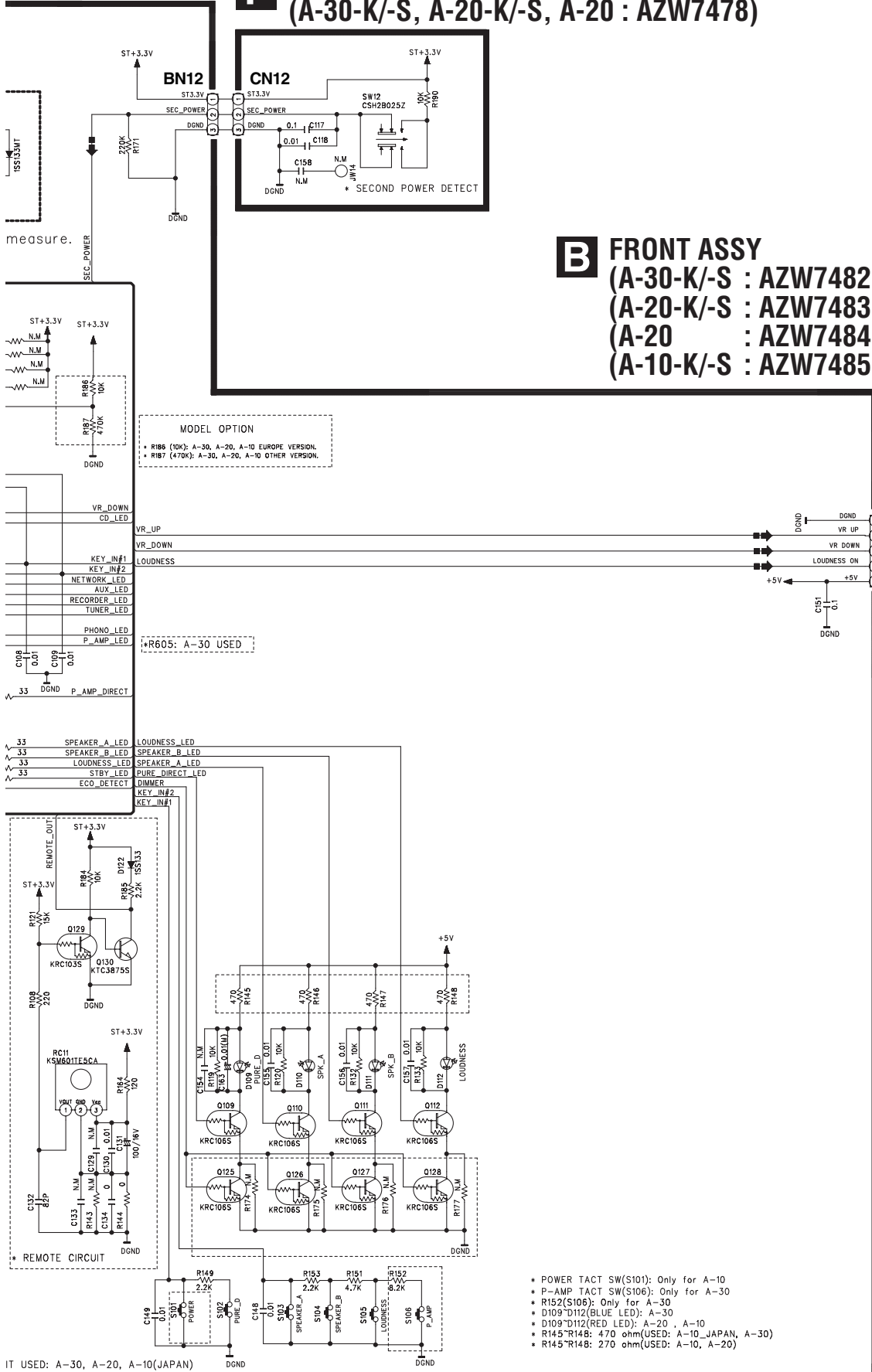

C CN52

- * POWER TACT SW(S101): Only for A-10
- * P-AMP TACT SW(S106): Only for A-30
- * R152(S106): Only for A-30
- * D109'D112(BLUE LED): A-30
- * D109'D112(RED LED): A-20 , A-10
- * R145'R148: 470 ohm(USED: A-10 ,JAPAN, A-30)
- * R145'R148: 270 ohm(USED: A-10, A-20)

IT USED: A-30, A-20, A-10(JAPAN)



10.3 MASTER VOLUME ASSY, TONE ASSY and HEADPHONE ASSY

C MASTER VOLUME ASSY (A-30-K-S : AZW7476) (A-20-K/-S, A-20, A-10-K/-S : AZW7481)

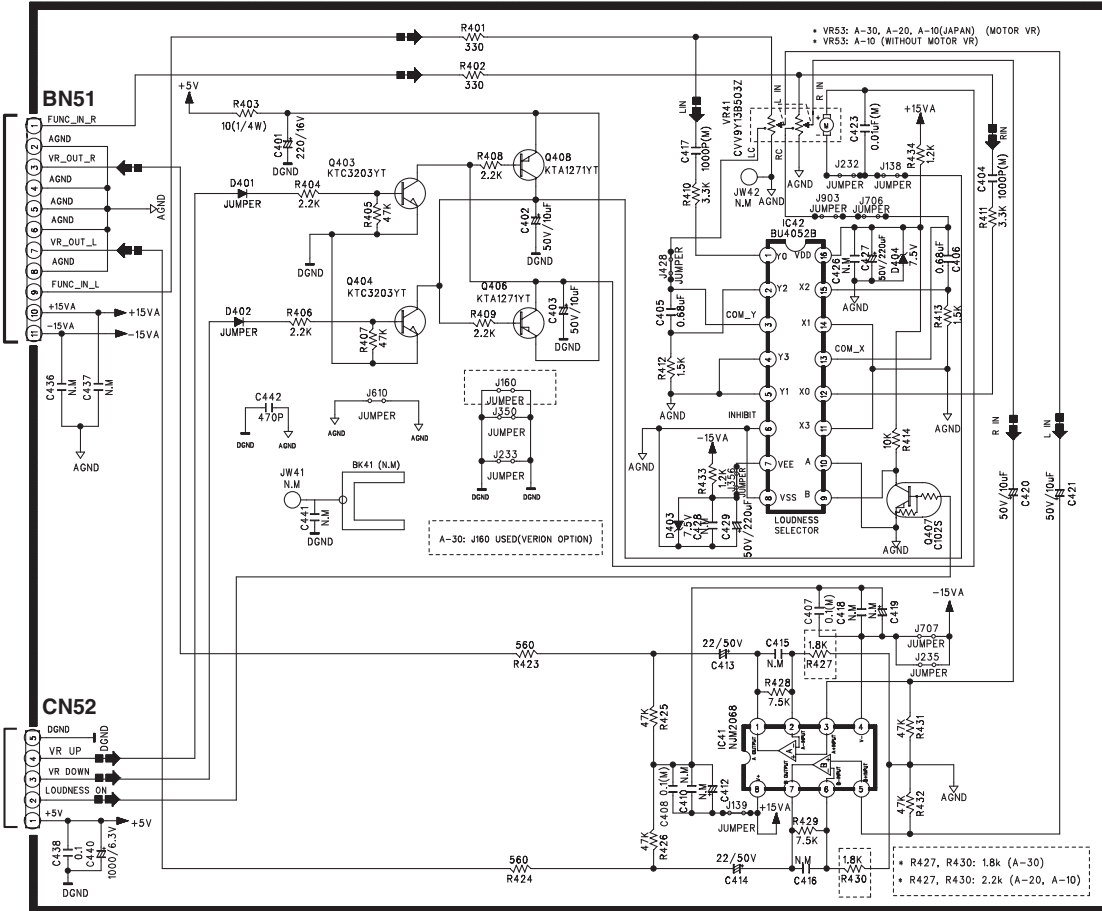

D TONE ASSY (AZW7477)

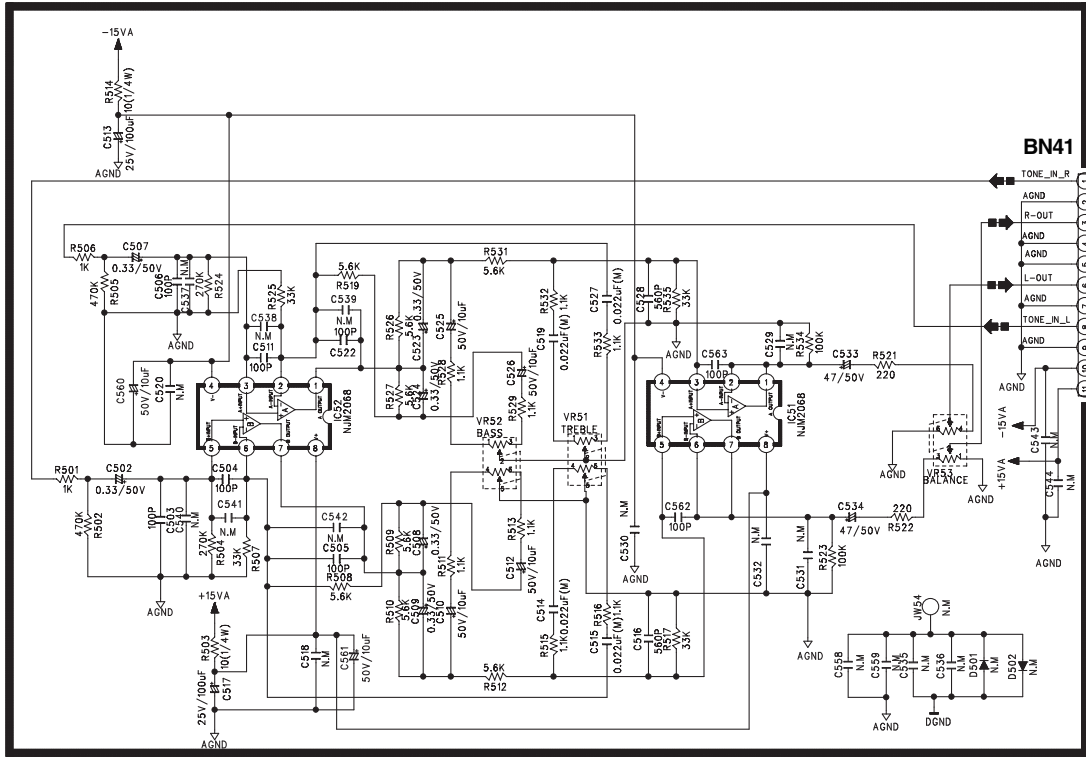

E HEADPHONE ASSY (AZW7479)

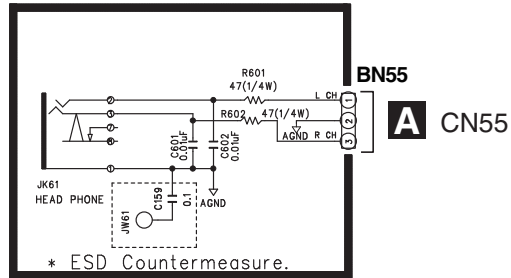

11. PCB CONNECTION DIAGRAM

11.1 MAIN ASSY

SIDE A

A MAIN ASSY

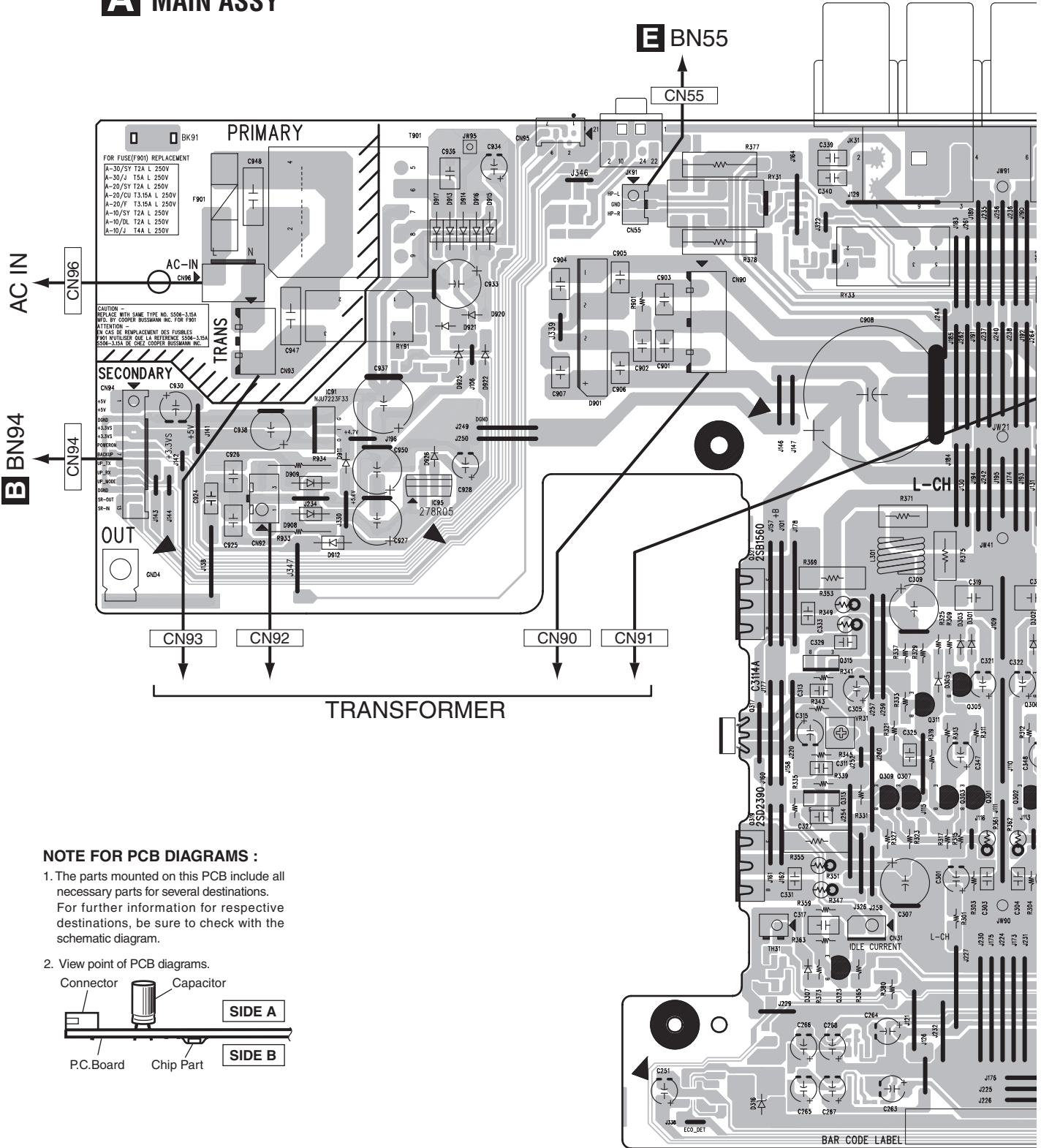

A

SIDE A

A

B

C

D

E

F

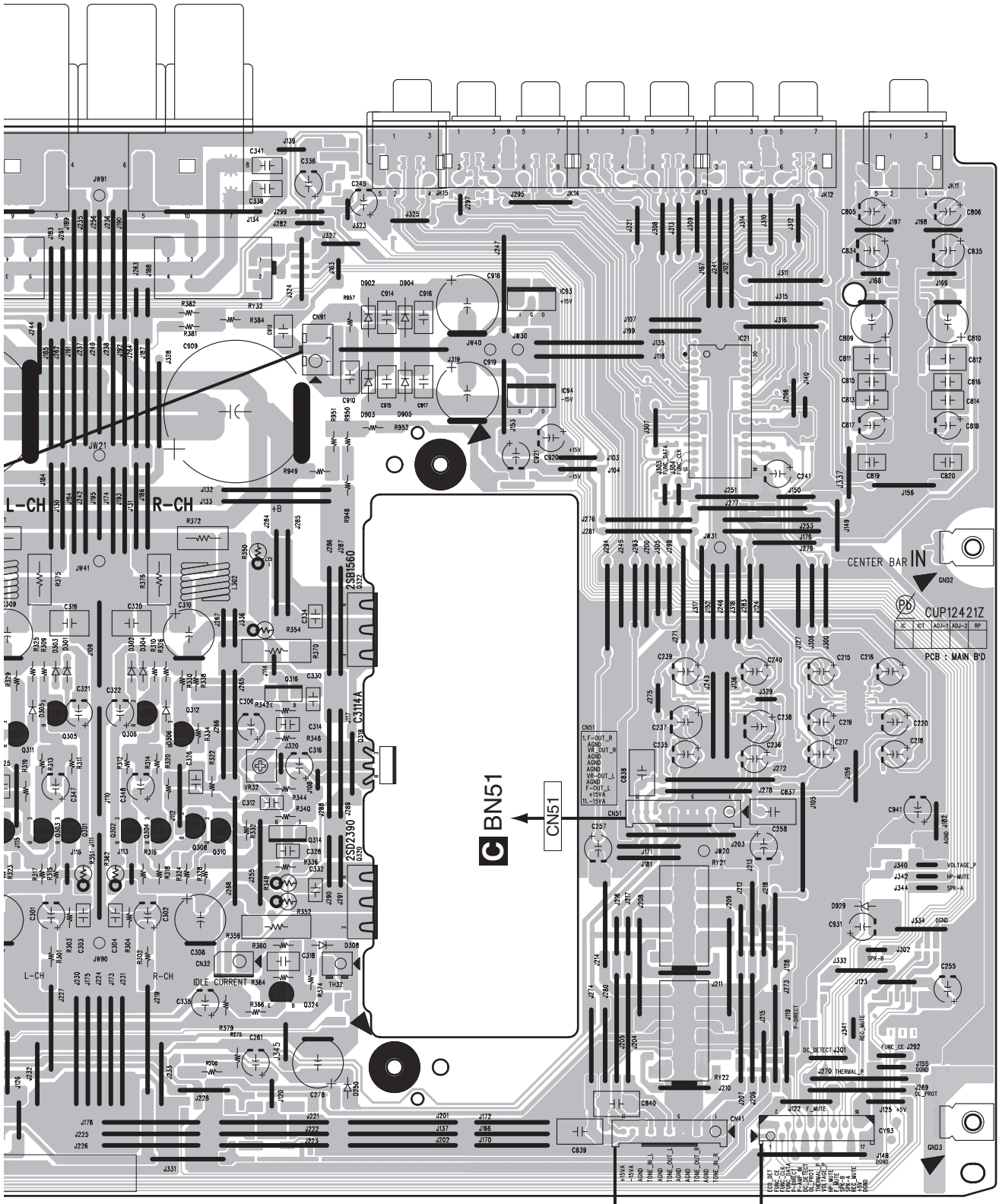

C BN51
CN51

D BN41
A-30-K

B CX93

A
47

SIDE B

A

A MAIN ASSY

B

C

D

E

F

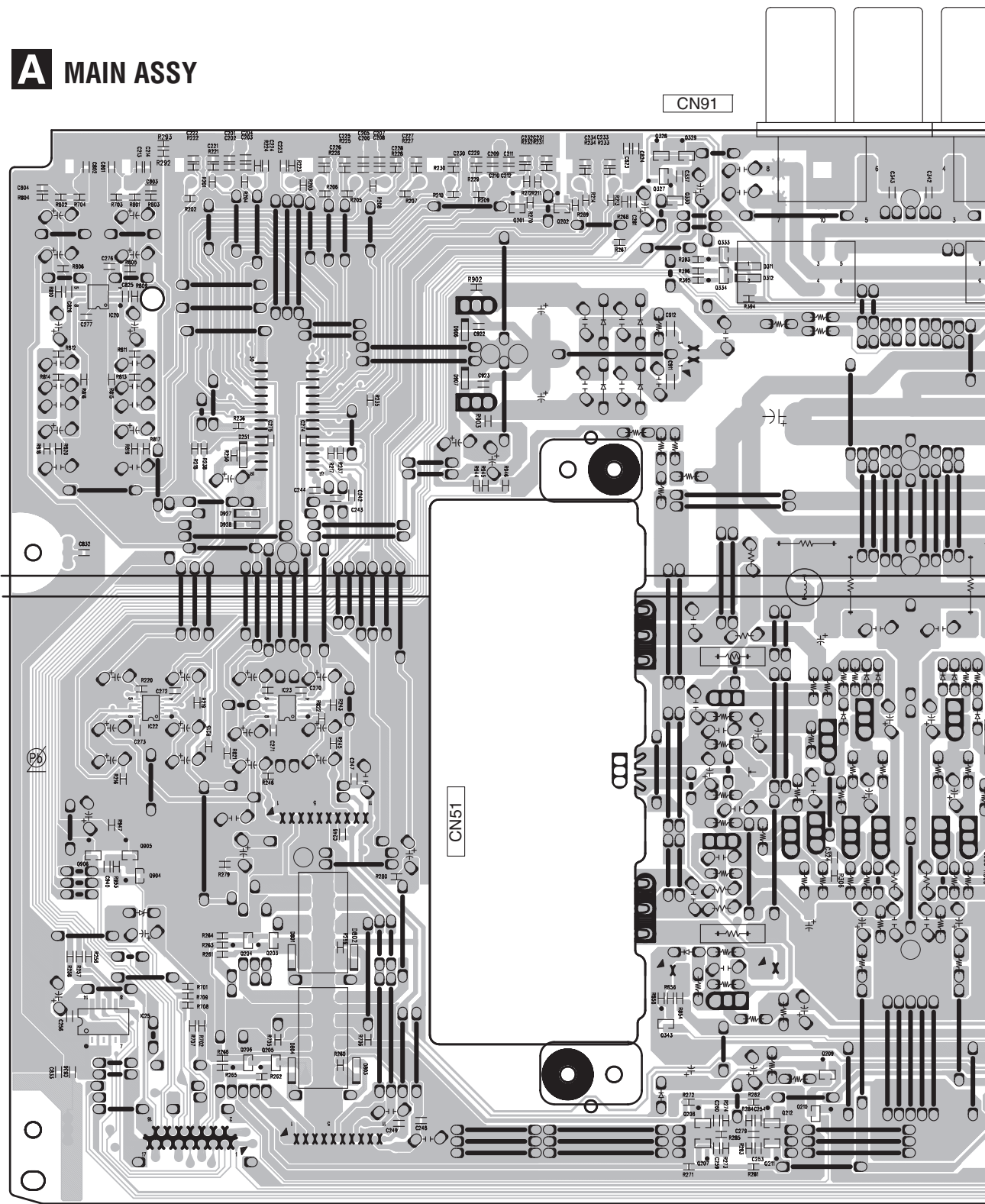

CY93

CN41

A

SIDE B

A

B

C

D

E

F

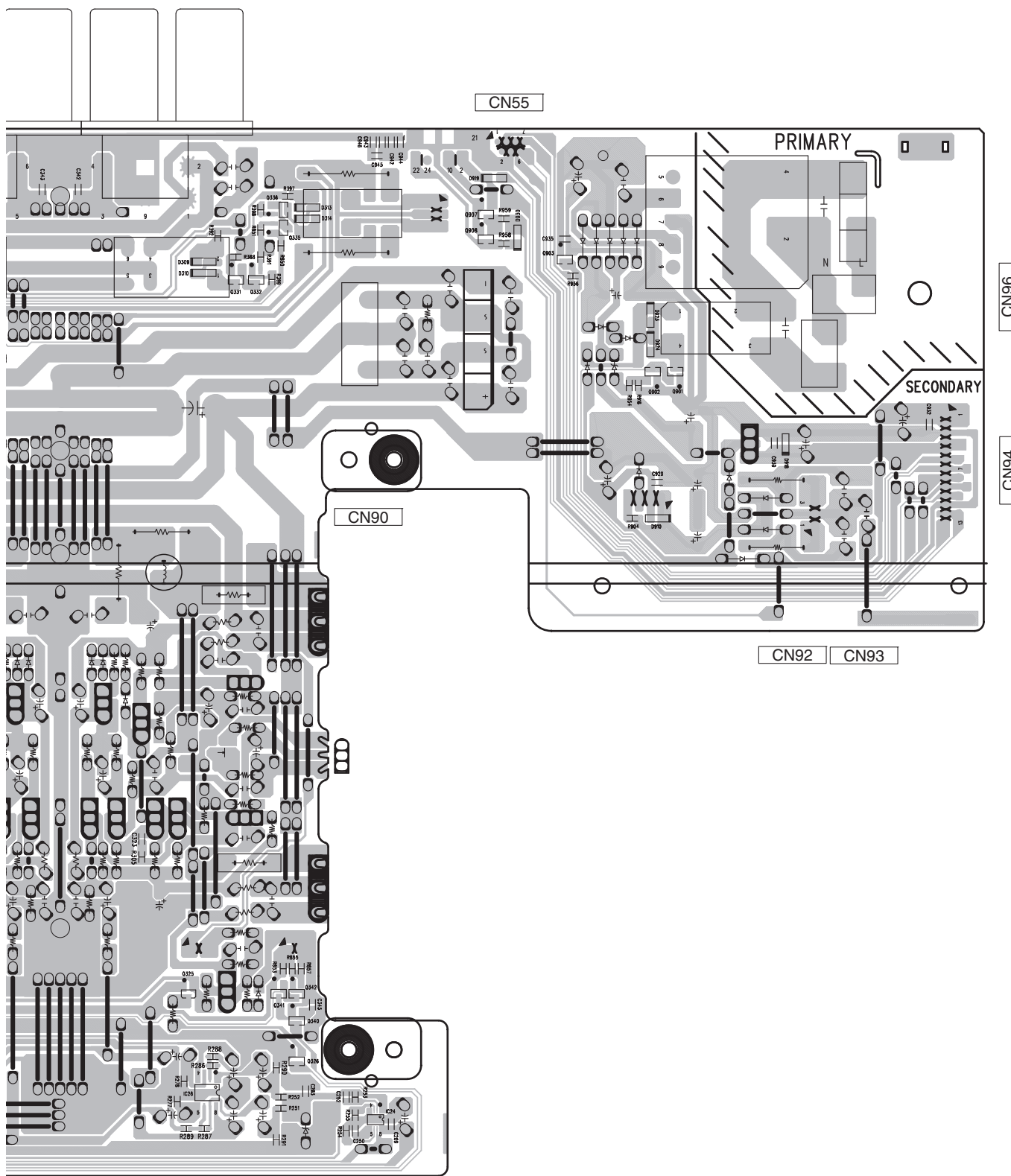

11.2 FRONT ASSY

SIDE A

B FRONT ASSY

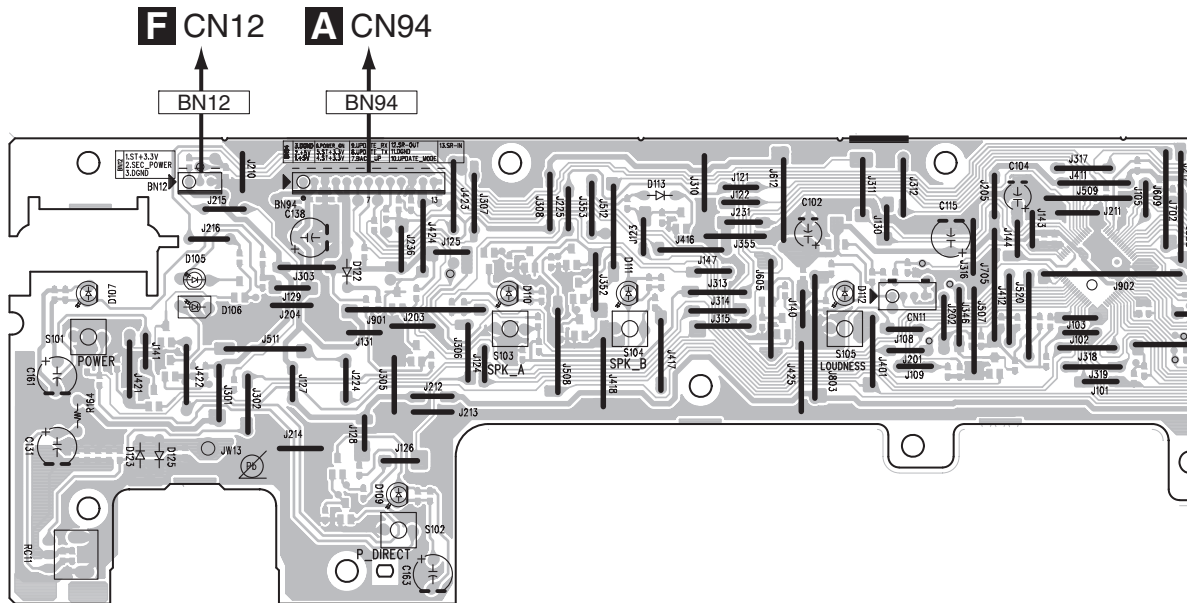

SIDE B

B FRONT ASSY

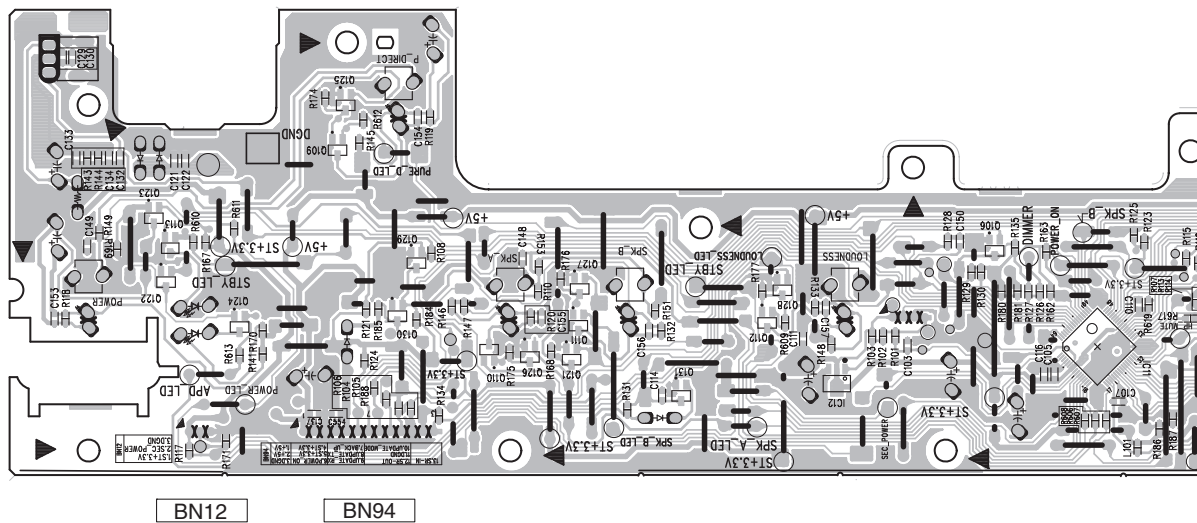

B

SIDE A

A

B

C

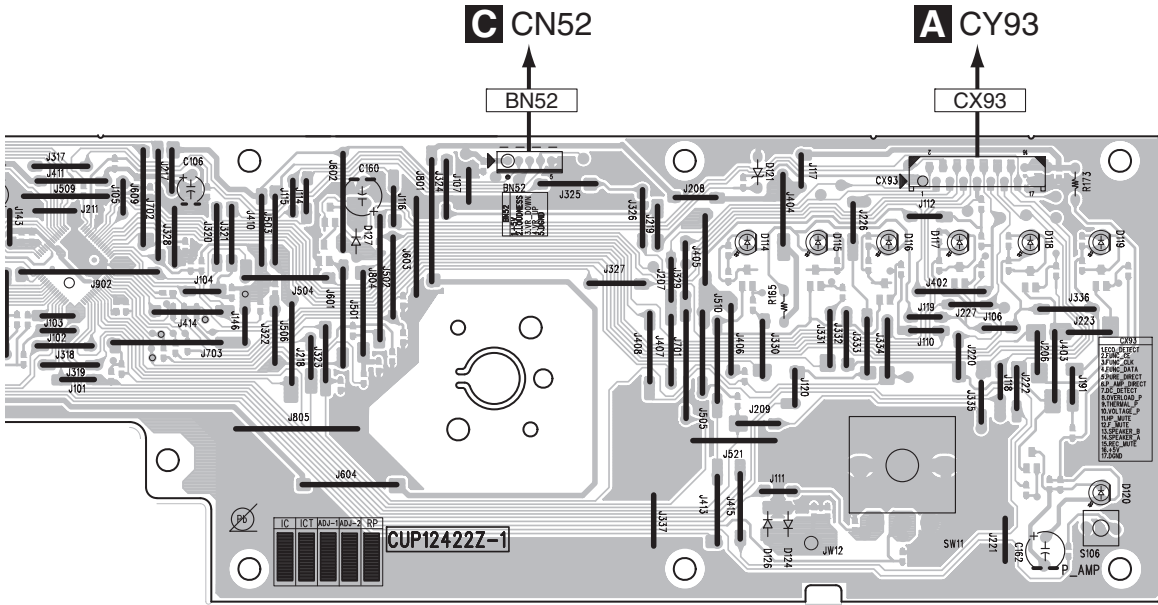

SIDE B

D

E

F

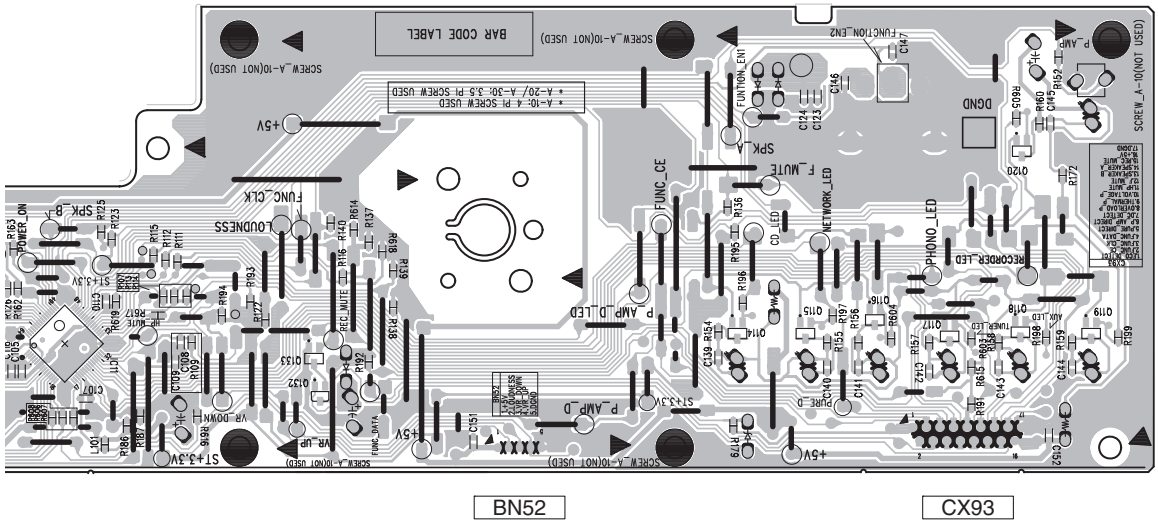

11.3 MASTER VOLUME ASSY

SIDE A

SIDE A

C MASTER VOLUME ASSY

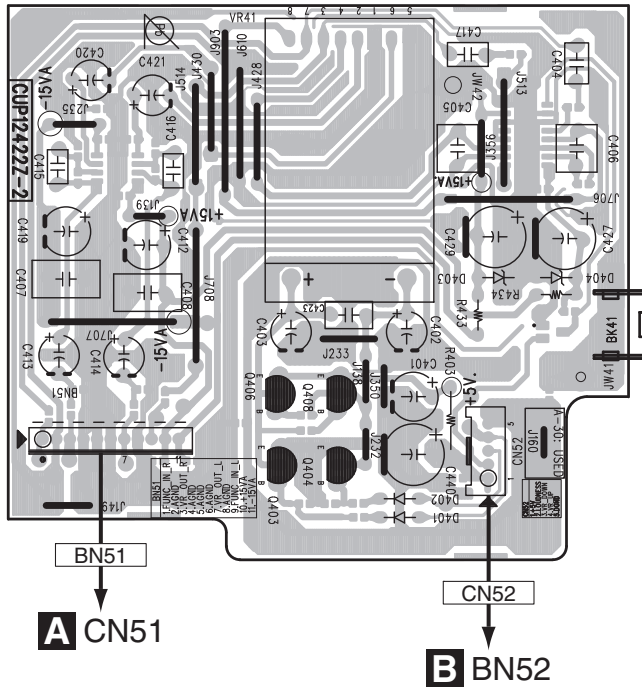

SIDE B

SIDE B

C MASTER VOLUME ASSY

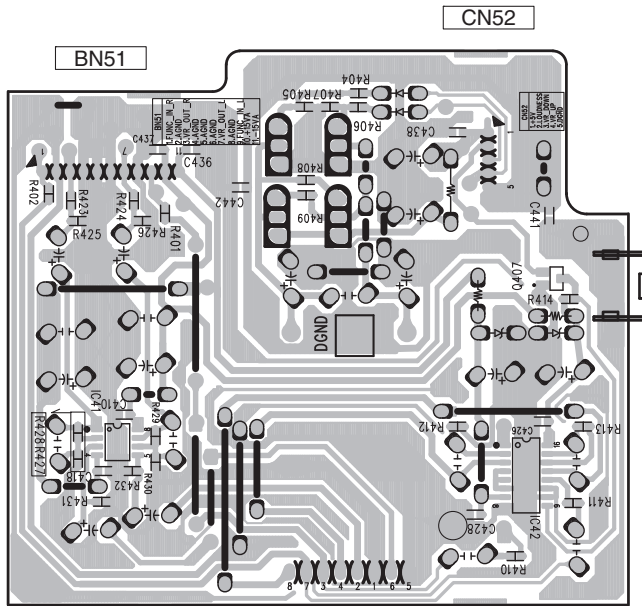

C

C

SIDE A

D TONE ASSY

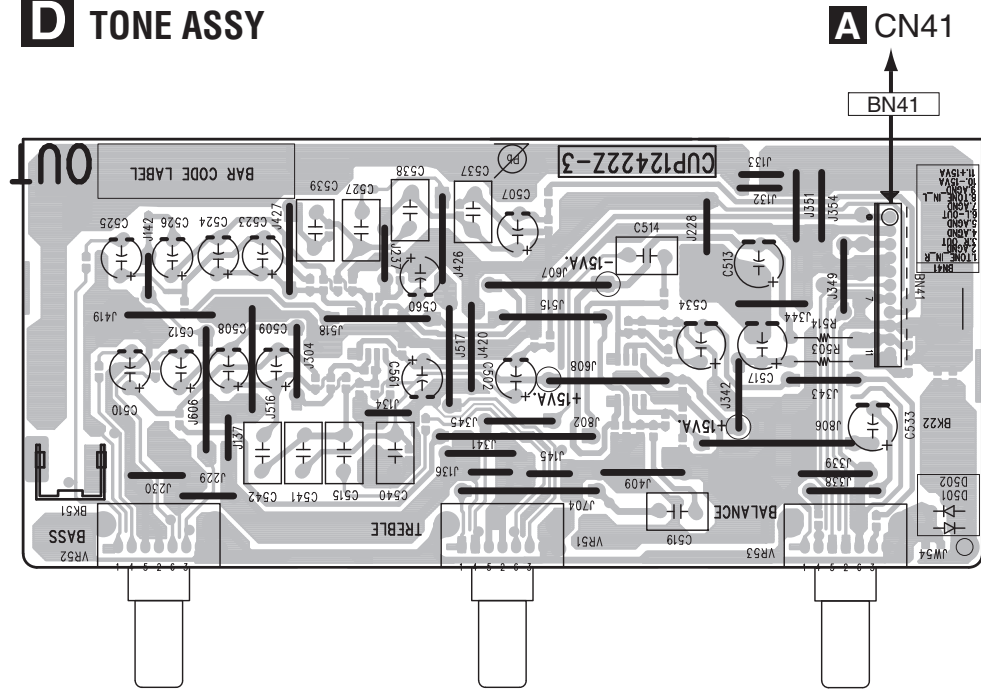

A CN41
BN41

SIDE B

D TONE ASSY

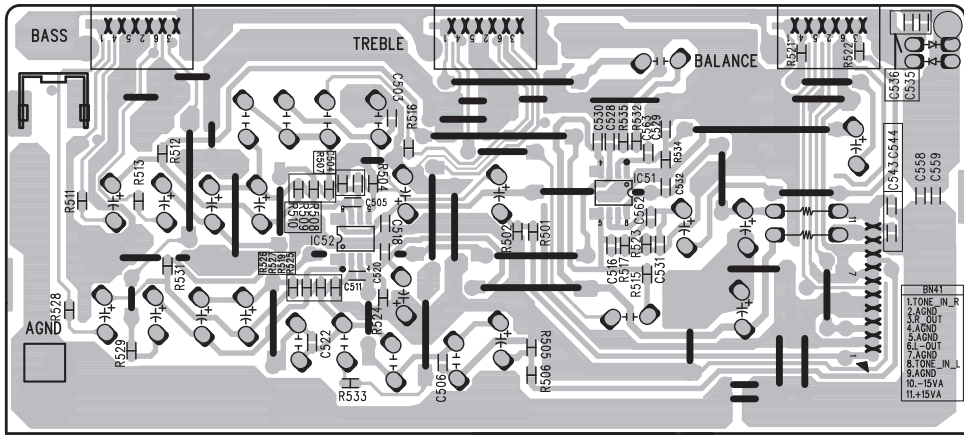

BN41

D

D

11.5 HEADPHONE ASSY and SECOND POWER SW ASSY (A-30/A-20)

SIDE A

SIDE A

E HEADPHONE ASSY

F SECOND POWER SW ASSY

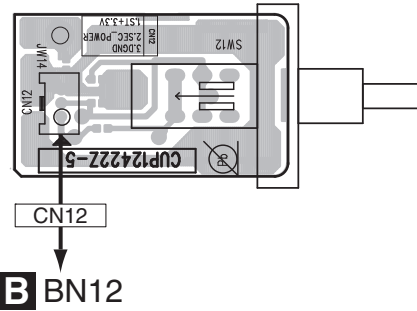
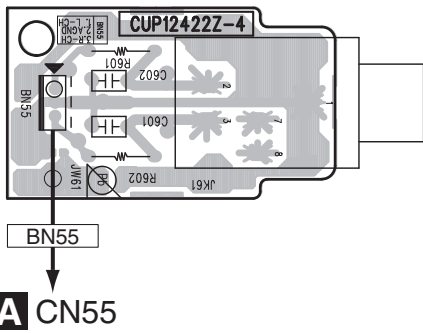

SIDE B

SIDE B

E HEADPHONE ASSY

F SECOND POWER SW ASSY

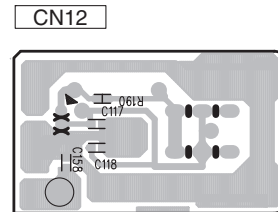
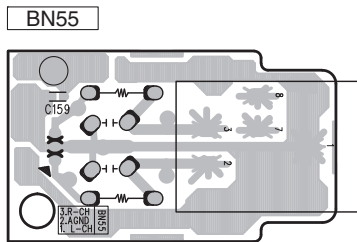

E F

E F

12. PCB PARTS LIST

NOTES: ● Parts marked by "NSP" are generally unavailable because they are not in our Master Spare Parts List.

● The Δ mark found on some component parts indicates the importance of the safety factor of the part. Therefore, when replacing, be sure to use parts of identical designation.

● When ordering resistors, first convert resistance values into code form as shown in the following examples.

Ex.1 When there are 2 effective digits (any digit apart from 0), such as 560 ohm and 47 k ohm (tolerance is shown by J = 5%, and K = 10%).

560 Ω \rightarrow 56 $\times 10^1$ \rightarrow 561 RD1/4PU $\boxed{5}$ $\boxed{6}$ $\boxed{7}$ J

47 k Ω \rightarrow 47 $\times 10^3$ \rightarrow 473 RD1/4PU $\boxed{4}$ $\boxed{7}$ $\boxed{3}$ J

0.5 Ω \rightarrow R50 RN2H \boxed{R} $\boxed{5}$ $\boxed{0}$ K

1 Ω \rightarrow 1R0 RSIP $\boxed{7}$ \boxed{R} $\boxed{0}$ K

Ex.2 When there are 3 effective digits (such as in high precision metal film resistors).

5.62 k Ω \rightarrow 562 $\times 10^1$ \rightarrow 5621 RN1/4PC $\boxed{5}$ $\boxed{6}$ $\boxed{2}$ $\boxed{1}$ F

[Wiring number reading substitute list]

SCHEMATIC DIAGRAM, PCB	Parts List	Parts No.	Name of Assembly
JK11	JA11	CJJ4N034Z	MAIN
JK12	JA12	CJJ4P028Z	MAIN
JK13	JA13	CJJ4P028Z	MAIN
JK14	JA14	CJJ4P028Z	MAIN
JK15	JA15	CJJ4N034Z	MAIN
JK31	JA31	CJJ5Q006Z	MAIN
JK91	JA91	HJJ1D002Z	MAIN
RC11	IC1011	CRVKSM601TE5CA	FRONT
BN12	J12	CWB1B00308047	FRONT
BN52	J52	CWB1B00515047	FRONT
BN94	J94	CWB1B01335047	FRONT
SW11	S11	CSR2A056Z	FRONT
BN51	J51	CWB1C0112004W001	MASTER VOLUME
BN41	J41	CWB1B01120047	TONE
BN55	J55	CWB4B00340047	HEADPHONE
JK61	JA61	CJJ2E020Z	HEADPHONE
SW12	S12	CSH2B024Z	SECOND POWER SW

Mark No.	Description	Part No.	Mark No.	Description	Part No.
LIST OF ASSEMBLIES					
NSP	1..MAIN ASSY (A-30-K/-S) 2..MAIN ASSY	COP12421B AZW7487	NSP	1..FRONT ASSY (A-20) 2..FRONT ASSY 2..MASTER VOLUME ASSY 2..TONE ASSY	COP12422G AZW7484 AZW7481 AZW7477
NSP	1..MAIN ASSY (A-20-K/-S) 2..MAIN ASSY	COP12421D AZW7489	NSP	2..HEADPHONE ASSY 2..SECOND POWER SW ASSY	AZW7479 AZW7478
NSP	1..MAIN ASSY (A-20) 2..MAIN ASSY	COP12421E AZW7490	NSP	1..FRONT ASSY (A-10-K/-S) 2..FRONT ASSY 2..MASTER VOLUME ASSY	COP12422D AZW7485 AZW7481
NSP	1..MAIN ASSY (A-10-K/-S) 2..MAIN ASSY	COP12421F AZW7491	NSP	2..TONE ASSY 2..HEADPHONE ASSY	AZW7477 AZW7479
NSP	1..FRONT ASSY (A-30-K/-S) 2..FRONT ASSY 2..MASTER VOLUME ASSY 2..TONE ASSY 2..HEADPHONE ASSY 2..SECOND POWER SW ASSY	COP12422B AZW7482 AZW7476 AZW7477 AZW7479 AZW7478			
NSP	1..FRONT ASSY (A-20-K/-S) 2..FRONT ASSY 2..MASTER VOLUME ASSY 2..TONE ASSY 2..HEADPHONE ASSY 2..SECOND POWER SW ASSY	COP12422C AZW7483 AZW7481 AZW7477 AZW7479 AZW7478			

A MAIN ASSY

AZW7487, AZW7489, AZW7490 and AZW7491 are constructed the same except for the following:

Mark	Symbol and Description	AZW7487	AZW7489	AZW7490	AZW7491
	JA15	CJJ4N034Z	Not used	Not used	Not used
	RY22	CSL4B022ZE	Not used	Not used	Not used
	RY32	CSL4B023ZE	CSL4B024ZE	CSL4B024ZE	CSL4B024ZE
	RY33	CSL4B023ZE	CSL4B024ZE	CSL4B024ZE	CSL4B024ZE
	T901	CLT5I010ZE	CLT5I010ZE	CLT5I010ZU	CLT5I010ZE
	C908	ACH7378	CCET50VPLP822NCP	CCET50VPLP822NCP	CCET50VPLP822NCP
	C909	ACH7378	CCET50VPLP822NCP	CCET50VPLP822NCP	CCET50VPLP822NCP

B FRONT ASSY

B AZW7482, AZW7483, AZW7484 and AZW7485 are constructed the same except for the following:

Mark	Symbol and Description	AZW7482	AZW7483	AZW7484	AZW7485
	D109	CVDGY34MD22B51CMCACL	CVDGY34SU05R41BJDABJ	CVDGY34SU05R41BJDABJ	CVDGY34SU05R41BJDABJ
	D110	CVDGY34MD22B51CMCACL	CVDGY34SU05R41BJDABJ	CVDGY34SU05R41BJDABJ	CVDGY34SU05R41BJDABJ
	D111	CVDGY34MD22B51CMCACL	CVDGY34SU05R41BJDABJ	CVDGY34SU05R41BJDABJ	CVDGY34SU05R41BJDABJ
	D112	CVDGY34MD22B51CMCACL	CVDGY34SU05R41BJDABJ	CVDGY34SU05R41BJDABJ	CVDGY34SU05R41BJDABJ
	D114	CVDGY34MD22B51CMCACL	CVDGY34SU05R41BJDABJ	CVDGY34SU05R41BJDABJ	CVDGY34SU05R41BJDABJ
	D115	CVDGY34MD22B51CMCACL	CVDGY34SU05R41BJDABJ	CVDGY34SU05R41BJDABJ	CVDGY34SU05R41BJDABJ
	D116	CVDGY34MD22B51CMCACL	CVDGY34SU05R41BJDABJ	CVDGY34SU05R41BJDABJ	CVDGY34SU05R41BJDABJ
	D117	CVDGY34MD22B51CMCACL	CVDGY34SU05R41BJDABJ	CVDGY34SU05R41BJDABJ	CVDGY34SU05R41BJDABJ
	D118	CVDGY34MD22B51CMCACL	CVDGY34SU05R41BJDABJ	CVDGY34SU05R41BJDABJ	CVDGY34SU05R41BJDABJ
	D119	CVDGY34MD22B51CMCACL	CVDGY34SU05R41BJDABJ	CVDGY34SU05R41BJDABJ	CVDGY34SU05R41BJDABJ
	D120	CVDGY34MD22B51CMCACL	Not used	Not used	Not used
	S101	Not used	Not used	Not used	CST1A023ZT
	S106	CST1A023ZT	Not used	Not used	Not used

PCB PARTS LIST FOR A-30-K/-S UNLESS OTHERWISE NOTED

Mark	No.	Description	Part No.	Mark	No.	Description	Part No.
------	-----	-------------	----------	------	-----	-------------	----------

A MAIN ASSY

SEMICONDUCTORS

IC 20	HVINJM2068MDTE1
IC 21	HVILC78212
IC 22,23,26	CVIAZ4580MTR-E1
IC 24	CVINJU7181RB1
IC 25	HVITC74HCT7007F

IC 91	CVINJU7223F33
IC 93,94	CVILM7815FTL
IC 95	CVIISP278R05FTL
Q 301-306,311,312	CVTKSC1845FTA
Q 307-310	CVTKSA992FTA

Q 313,314	HVTKTA1360Y
Q 315,316	HVTKTC3423Y
Q 323,324	HVTKTC3198YT
D 901	HVDGBJ806
D 902-905,908,909	CVD1N4003ST

D 906,907,918	CVDRB521S-30
D 912-917	CVD1N4003ST

MISCELLANEOUS

L 301,302 COIL , SPEAKER(0.5UH)	CLEY0R5KAK
JA 11,15 JACK , IN/OUT	CJJ4N034Z
JA 12-14 JACK , IN/OUT	CJJ4P028Z
JA 31 TERMINAL , SPEAKER	CJJ5Q006Z
JA 91 JACK , STEREO(2P 3.5PIE)	HJJ1D002Z

VR 31,32 RES , SEMI FIXED (220 OHM)	CVN12A221B03T
RY 21,22 RELAY , BC3-24H , DC24V , 2C2P	CSL4B022ZE
RY 31 RELAY , BC3-24H , DC24V , 2C2P	CSL4B022ZE
RY 32,33 RELAY , HL3-2A-24 , DC24V , 2C2P	CSL4B023ZE
RY 91 RELAY,G5PA-1,DC6V,1C1P	CSL1E002ZE

T 901 TRANS , SUB RCD-M37EUR	CLT5I010ZE
------------------------------	------------

RESISTORS

R 347-350	CRG1SANJ3R3RT
R 351-354	CRG1SANJ180RT
R 355,356,369,370	CRF5EKR22H
R 371,372,375,376	CRG1ANJ100H
R 933,934	CRQ1AJR47H

CAPACITORS

C 278	CCEA1EH102ECP
C 918,919	CCEA1EH222ECP
C 927,933,937,950	CCEA1CH102ECP
C 938	CCEA0JH102T
C 947,948	KCKDKS472ME

CAUTIONS

The parts number of Q317, Q318 (BIAS Transistor), Q319, Q320, Q321, Q322 (Power Transistor) and TH31, TH32 (Posistor) are indicated in [9.2 EXTERIOR SECTION (A-30/A-20)] and [9.3 EXTERIOR SECTION (A-10)] of [9. EXPLODED VIEWS AND PARTS LIST]

Mark No. Description _____ **Part No.** _____

B FRONT ASSY

SEMICONDUCTORS

IC 11		CVIANAM1656A
IC 12		CVIML61C282PR
IC 1011		CRVKSM601TE5CA
D 105		CVDGY34MU22Y16BJTAA4
D 106		CVDBLBUF4V5K1AV
D 107,109-112		CVDGY34MD22B51CMCACL
D 114-120		CVDGY34MD22B51CMCACL

MISCELLANEOUS

J 12	ROCKING TYPE WIRE ASSY (3P, 80MM, 2.0MM)	CWB1B00308047
J 52	ROCKING TYPE WIRE ASSY (5P, 150MM, 2.0MM)	CWB1B00515047
J 94	ROCKING TYPE WIRE ASSY (13P, 350MM, 2.0MM)	CWB1B01335047
S 11	VR, ENCODER	CSR2A056Z
S 102-106 SW , TACT		CST1A023ZT

C MASTER VOLUME ASSY

SEMICONDUCTORS

IC 41		CVIAZ4580MTR-E1
IC 42		CVIBU4052BCF

MISCELLANEOUS

J 51	ROCKING TYPE SHIELD WIRE ASSY (11P, 200MM, 2.0MM)	CWB1C0112004W001
VR41	VOLUME , MOTOR	CVV9Y13B503Z

RESISTORS

R 403		CRD25TJ100T
-------	--	-------------

CAPACITORS

C 440		CCEA0JH102TC
-------	--	--------------

D TONE ASSY

SEMICONDUCTORS

IC 51,52		CVIAZ4580MTR-E1
----------	--	-----------------

MISCELLANEOUS

J 41	ROCKING TYPE WIRE ASSY (11P, 200MM, 2.0MM)	CWB1B01120047001
VR 51,52	RES, VARIABLE(ANGLE)	CVV3W01B103Z
VR 53	RES, VARIABLE(ANGLE)	CVV3W02M203Z

RESISTORS

R 503,514		CRD25TJ100T
-----------	--	-------------

Mark No. Description _____ **Part No.** _____

E HEADPHONE ASSY

MISCELLANEOUS

J 55	ROCKING TYPE WIRE ASSY (3P, 400MM, 2.0MM)	CWB4B00340047
JA 61	JACK, PHONES(6.35MM,GOLD)	CJJ2E020Z

RESISTORS

R 601,602		CRD25TJ470T
-----------	--	-------------

F SECOND POWER SW ASSY(A-30/A-20)

MISCELLANEOUS

S 12	SW, PUSH (FOR DC , 2C2P)	CSH2B024Z
------	--------------------------	-----------