

Service Manual

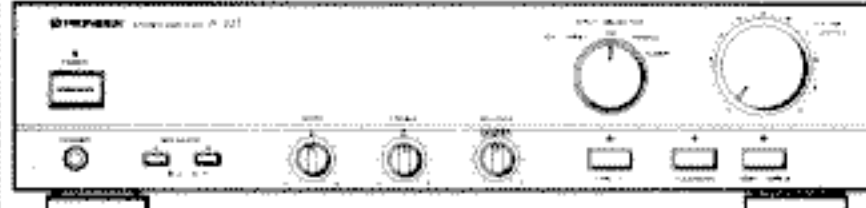

NOTE: The illustration shows model A-225.

ORDER NO.
ARP1765

STEREO AMPLIFIER

A-225

A-225-S

A-115

A-225, A-225-S AND A-115 HAVE FOLLOWING VERSIONS :

Type	Applicable model			Power requirement	Export destination
	A-225	A-225-S	A-115		
HEZ	○	○	○	AC220V, 240V (switchable) *	West Germany
HE	○	—	○	AC220V, 240V (switchable) *	European continent
HB	○	—	○	AC220V, 240V (switchable) *	United Kingdom
SD	○	—	○	AC110V, 120V-127V, 220V, 240V (switchable)	Kingdom of Saudi Arabia and general market
YP	○	—	○	AC240V only	Australia

*Change the primary wiring of the power transformer.

- This manual is applicable to the A-225/HEZ, HE, HB, A-225-S/HEZ, A-115/HEZ, HE and HB types.
- For the A-225/HE, HB and A-225-S/HEZ types, refer to pages 28-29.
- For the A-115/HE and HB types, refer to page 30.
- For the other types, refer to additional service manuals.
- The A-225-S/HEZ type is the same as the A-225/HEZ type except for color.

CONTENTS

1. EXPLODED VIEW AND PARTS LIST.....	2	5. FOR A-225/HE, HB AND	
2. PACKING.....	5	A-225-S/HEZ TYPES.....	28
3. SCHEMATIC AND P. C. BOARDS		6. FOR A-115/HE AND HB TYPES.....	30
CONNECTION DIAGRAM.....	6	7. SPECIFICATIONS.....	31
4. ELECTRICAL PARTS LIST.....	24	8. PANEL FACILITIES.....	32

1. EXPLODED VIEW AND PARTS LIST

NOTES :

- Parts without part number cannot be supplied.
- The Δ mark found on some component parts indicates the importance of the safety factor of the part. Therefore, when replacing, be sure to use parts of identical designation.
- Parts marked by "⊙" are not always kept in stock. Their delivery time may be longer than usual or they may be unavailable.

Parts List of A-225

Mark	No.	Part No.	Description
	1	AWZ2356	AF assembly
	2	AWZ2360	Front assembly
Δ	3	ATS1189	Power transformer (T1)
	4	ASU1023	Remote slide rotary switch (S1)
Δ	5	AEK-018	Fuse (FU1, 1.25A/250V)
Δ	6	ADG1049	AC Power cord
	7	AMR1350	Insulator assembly
	8	AMR1353	Insulator assembly
	9
	10	ABH-052	Coil spring (B)
	11	ABH1034	Coil spring (B)
	12	AEC-882	Strain relife
	13	ABA-298	Screw
	14	ABA1007	Screw
	15	ABA1009	Screw
	16	ABA1048	Screw
	17	ABN-065	Nut
	18	NK70FUC	Nut
	19	NK90FZB	Nut
	20	VMZ30P060FCU	Screw
	21	VPZ30P100FMC	Screw
	22	ANB1263	Front panel
	23	AMB1453	Panel base
	24	AAM1029	Friction plate
	25	AMR1160	LED lens
	26	AAB1068	Volume (S)
	27	AAB1093	Knob (L)
	28	AAB1094	Knob (M)
	29	AAD-418	Knob (B)
	30	AAD1535	Knob (POWER)
	31	AAD1536	Knob
	32	ANE1174	Bonnet
	33	ABA1022	Screw
	101		LED assembly
	102		Power SW assembly
	103		SP SW assembly
	104	
	105		Terminal (GND)
	106		Chassis
	107		Rear panel
	108		Bottom plate
	109		Shield plate
	110		Binder
	111		Name sticker
2	112		Heat sink

Parts List of A-115

Mark	No.	Part No.	Description
	1	AWZ2358	AF assembly
	2	AWZ2361	Front assembly
Δ	3	ATS1191	Power transformer (T1)
	4	ASU1023	Remote slide rotary switch (S1)
Δ	5	AEK-031	Fuse(FU1, 800mH/250V)
Δ	6	ADG1049	AC Power cord
	7
	8
	9	AEC-784	Leg assembly
	10	ABH-052	Coil spring (B)
	11	ABH1034	Coil spring (B)
	12	AEC-882	Strain relife
	13	ABA-298	Screw
	14	ABA1007	Screw
	15	ABA1009	Screw
	16	ABA1048	Screw
	17	ABN-065	Nut
	18	NK70FUC	Nut
	19	NK90FZB	Nut
	20
	21	VPZ30P100FMC	Screw
	22	ANB1262	Front panel
	23	AMB1453	Panel base
	24	AAM1029	Friction plate
	25	AMR1160	LED lens
	26	AAB1068	Volume (S)
	27	AAB1097	Knob (L)
	28	AAB1098	Knob (M)
	29
	30	AAD1535	Knob (POWER)
	31	AAD1536	Knob
	32	ANE1173	Bonnet
	33	ABA1022	Screw
	101		LED assembly
	102		Power SW assembly
	103	
	104		Headphone assembly
	105		Terminal (GND)
	106		Chassis
	107		Rear panel
	108		Bottom plate
	109	
	110		Binder
	111		Name sticker
	112		Heat sink

2. PACKING

Parts List of A-225

Mark	No.	Part No.	Description
	1	AHA1240	Front-rear pad
	2	AHD1596	Packing case
	3	ARC1124	Operating instructions (German)
101			Sheet

Parts List of A-115

Mark	No.	Part No.	Description
	1	AHA1240	Front-rear pad
	2	AHD1595	Packing case
	3	ARC1124	Operating instructions (German)
101			Sheet

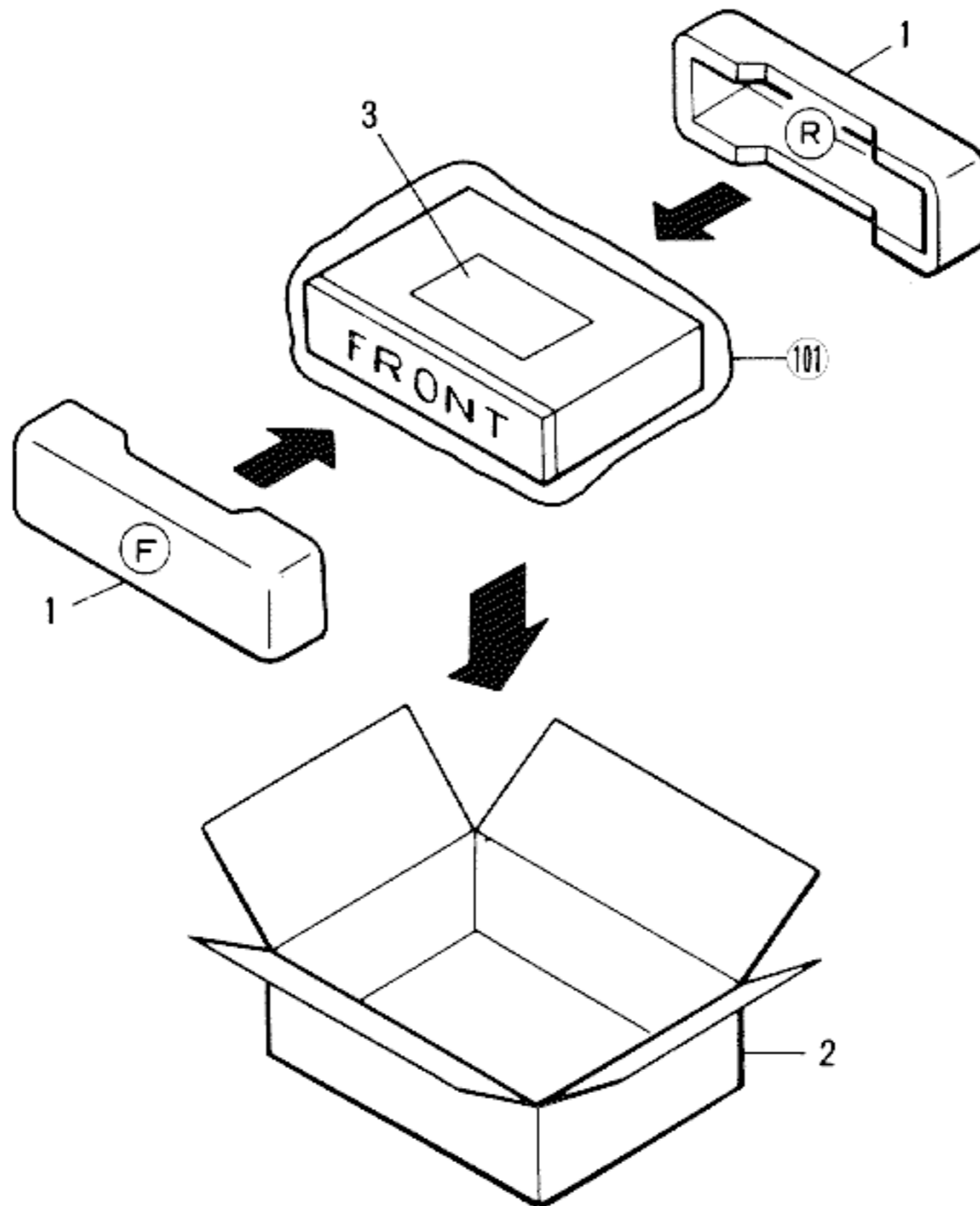

3. SCHEMATIC AND P. C. BOARDS CONNECTION DIAGRAM

3.1 SCHEMATIC DIAGRAM OF A-225

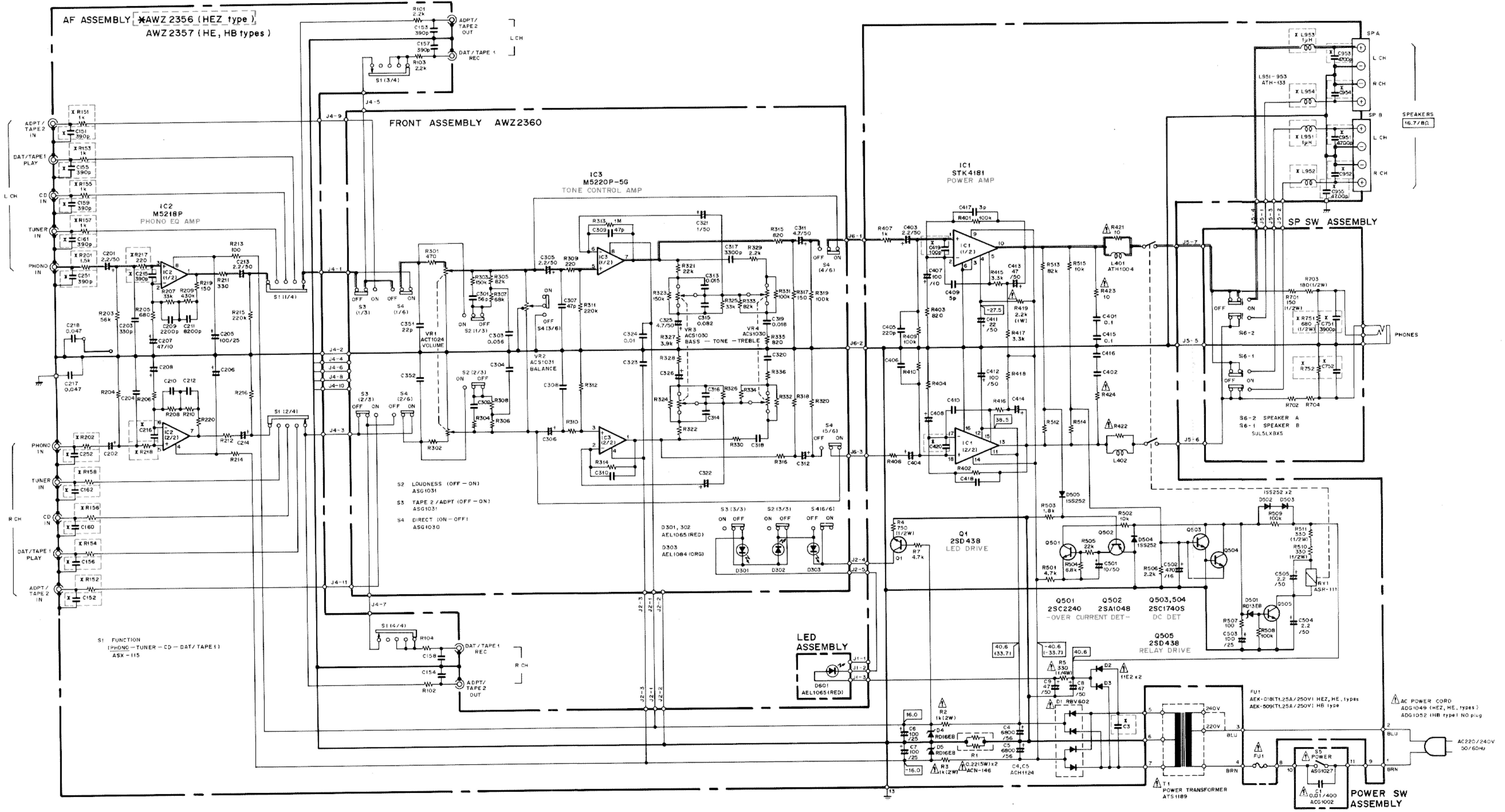

- This circuit diagram is based on the HEZ version.
- Parts with an asterisk (*) are different from this prepared for the HEZ version.
- Refer to the comparison list.

* Marks are difference between two assemblies.		
AF Assembly	HEZ model	HE, HB models
R151-R158	1k Ω	VACANT (JAMPER WIRE)
R201, R202	1.5k Ω	330 Ω
R217, R218	220 Ω	180 Ω
C151, C152, C155, C156, C159-C162, C251, C252	390p	VACANT (OPEN)
C951-C955	4700p	VACANT (OPEN)
C215, C216	390p	220p
C419, C420	100p	VACANT (OPEN)
C3	0.1 μ	0.01 μ (ACG1005)
L951-L954	ATH-133	VACANT (JAMPER WIRE)
SP SW Assembly		
R751, R752	680 Ω (1/2W)	VACANT (OPEN)
C751, C752	3900p	VACANT (OPEN)

- RESISTORS:**
Indicated in Ω, 2W, 1/2W, 1/8W, ±5% tolerance unless otherwise noted k; kΩ, M; MΩ, (F); ±1%, (G); ±2%, (K); ±10%, (M); ±20% tolerance.
- CAPACITORS:**
Indicated in capacity (μF)/voltage (V) unless otherwise noted p, pF. Indication without voltage is 50V except electrolytic capacitor.
- VOLTAGE CURRENT:**
Signal voltage at (35W + 35W, 812) output (1kHz)
DC voltage (V) at no input signal
Value in () is DC voltage at rated power.
- OTHERS:**
Signal route.
Adjusting point.
The mark found on some component parts indicates the importance of the safety factor of the part. Therefore, when replacing, be sure to use parts of identical designation.
* marked capacitors and resistors have parts numbers.
- SWITCHES (Underline indicates switch position)**
S1 : FUNCTION (PHONO-TUNER-CD-DAT/TAPE1)
S2 : LOUDNESS (ON-OFF)
S3 : ADPT/TAPE2 (ON-OFF)
S4 : DIRECT (ON-OFF)
S5 : POWER (ON-OFF)
S6-1 : SPEAKERS B (ON-OFF)
S6-2 : SPEAKERS A (ON-OFF)

Line Voltage Selection (HEZ, HE and HB types)
Line voltage can be changed with following steps.

1. Disconnect the AC power cord.
2. Remove the Bonnet case.
3. Change the connection of the power transformer lead wire.
4. Stick the line voltage label on the rear panel.

Part No.	Description
AAX-193	220v label
AAX-192	240v label

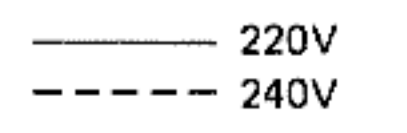

3.2 P. C. BOARDS CONNECTION DIAGRAM OF A-225

• View from component side

- This P. C. Boards Connection diagram is based on the HEZ version.
- Parts with an asterisk (*) are different from this prepared for the HEZ version.
- Refer to the comparison list in the circuit diagram.

NOTE

1. This P.C.B connection diagram is viewed from the parts mounted side.
2. The parts which have been mounted on the board can be replaced with those shown with the corresponding wiring symbols listed in the following Table.

P.C.B. pattern diagram indication	Corresponding part symbol	Part Name
		Transistor
		Radiator type transistor
		Diode
		Resistor
		Capacitor (Polarity)
		Capacitor (Non-polarity)

Others

P.C.B. pattern diagram indication	Part Name
	IC
	Switch
	Relay
	Coil
	Filter
	Variable resistor or Semi-fixed resistor

3. The capacitor terminal marked with ⊕ (double circles) shows negative terminal.
4. The diode terminal marked with ⊕ (double circles) shows cathode side.
5. The transistor terminal to which E is affixed shows the emitter.

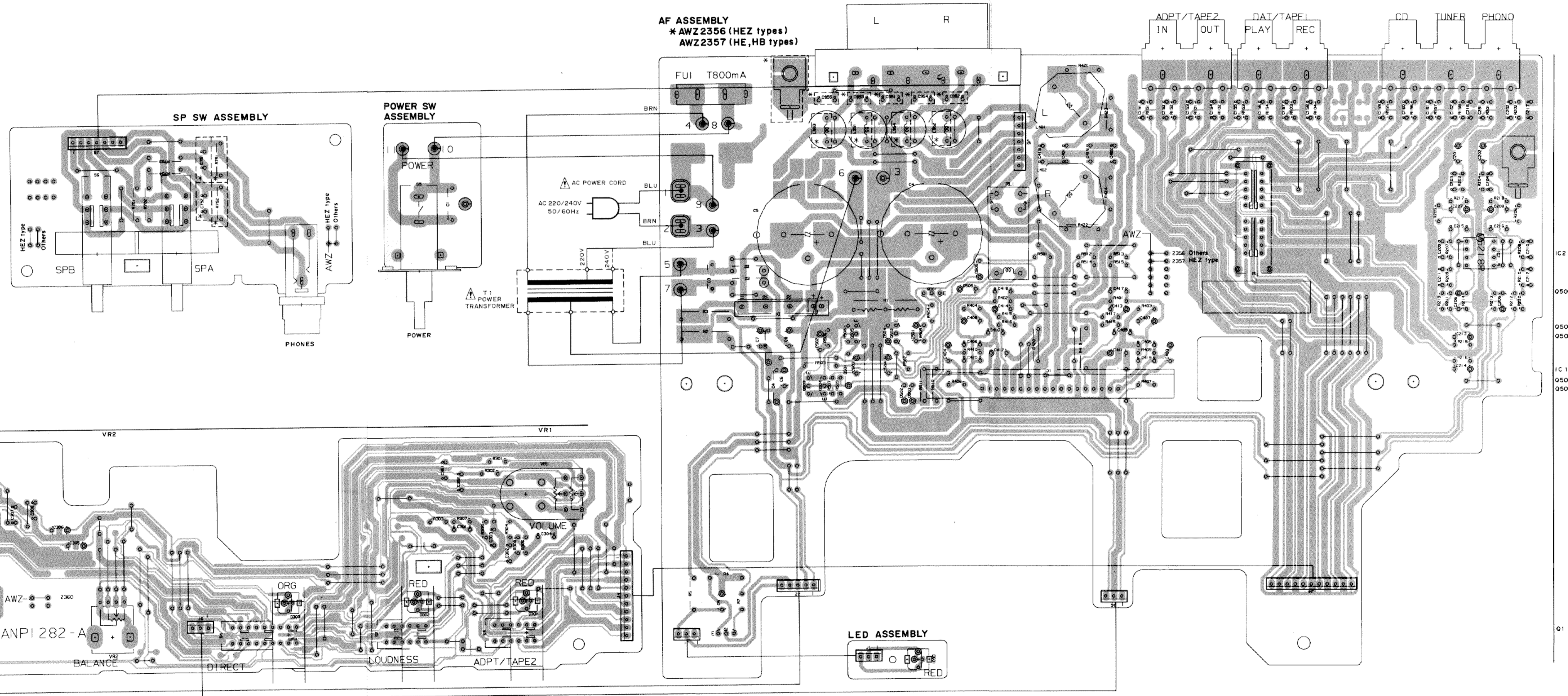

IC2
Q501
Q502
Q505
IC1
Q503
Q504

Q1

3.3 P. C. BOARDS CONNECTION DIAGRAM OF A-115

• View from soldering side

- This P. C. Boards Connection diagram is based on the HEZ version.
- Parts with an asterisk (*) are different from this prepared for the HEZ version.
- Refer to the comparison list in the circuit diagram.

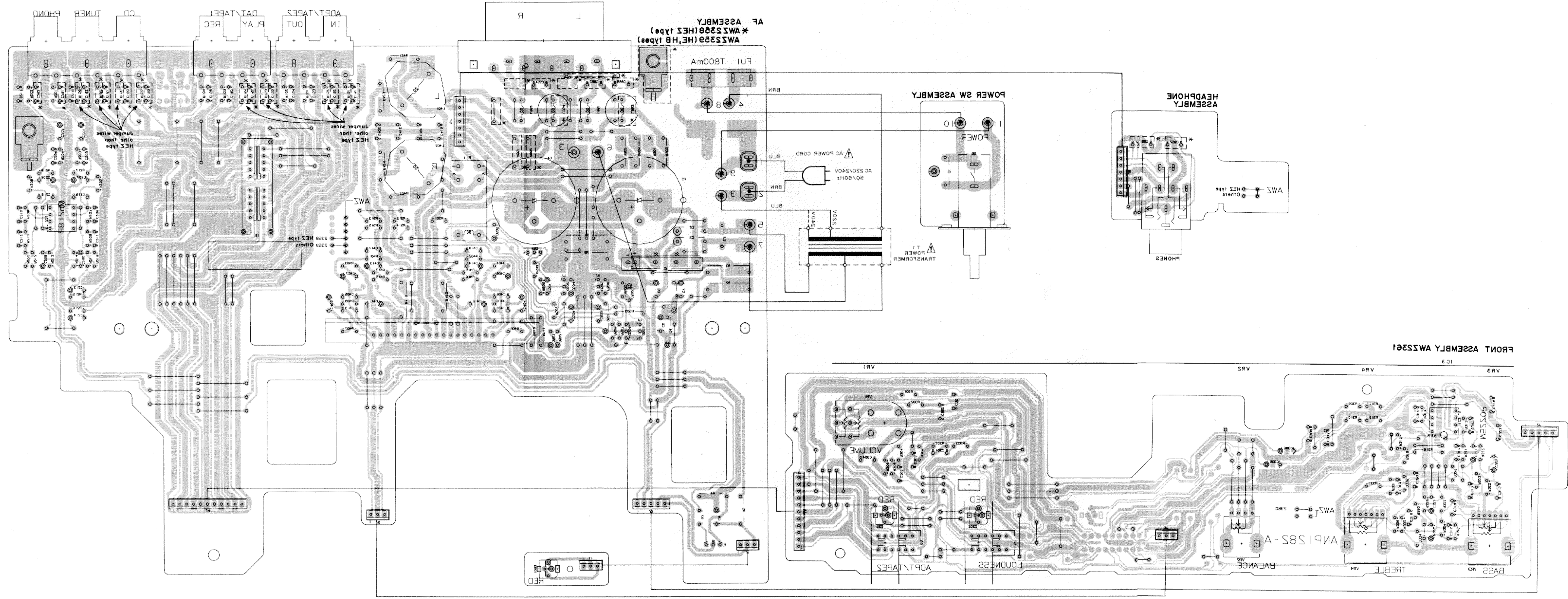

IC5
0202
IC1
0202

0

A

B

C

D

9

8

7

6

5

4

3

2

1

0

8

7

6

5

4

3

2

1

3.3 P. C. BOARDS CONNECTION DIAGRAM OF A-115

• View from component side

- This P. C. Boards Connection diagram is based on the HEZ version.
- Parts with an asterisk (*) are different from this prepared for the HEZ version.
- Refer to the comparison list in the circuit diagram.

- NOTE
1. This P.C.B connection diagram is viewed from the parts mounted side.
 2. The parts which have been mounted on the board can be replaced with those shown with the corresponding wiring symbols listed in the following Table.

P.C.B. pattern diagram indication	Corresponding part symbol	Part Name
		Transistor
		Radiator type transistor
		Diode
		Resistor
		Capacitor (Polarity)
		Capacitor (Non-polarity)

Others

P.C.B. pattern diagram indication	Part Name
	IC
	Switch
	Relay
	Coil
	Filter
	Variable resistor or Semi-fixed resistor

3. The capacitor terminal marked with @ (double circles) shows negative terminal.
4. The diode terminal marked with @ (double circles) shows cathode side.
5. The transistor terminal to which E is affixed shows the emitter.

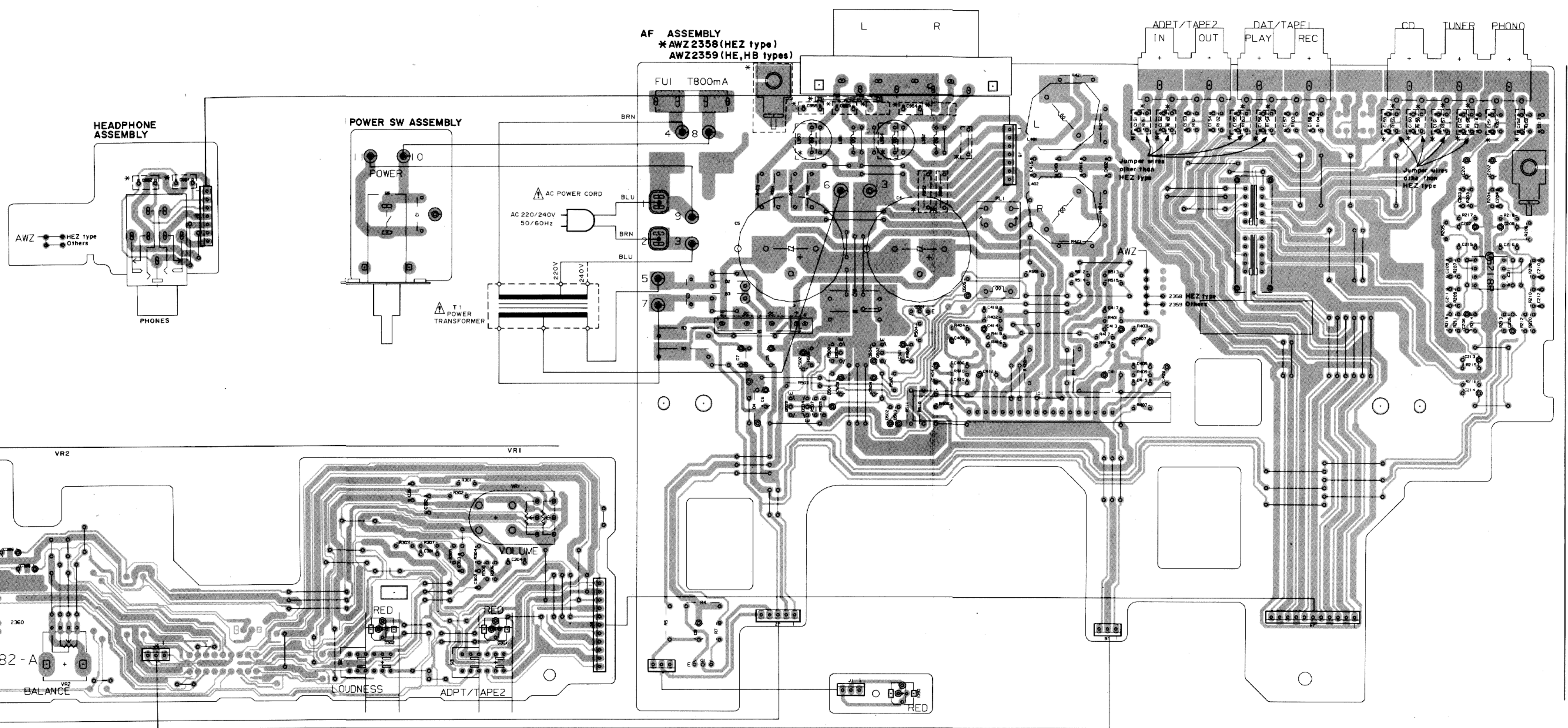
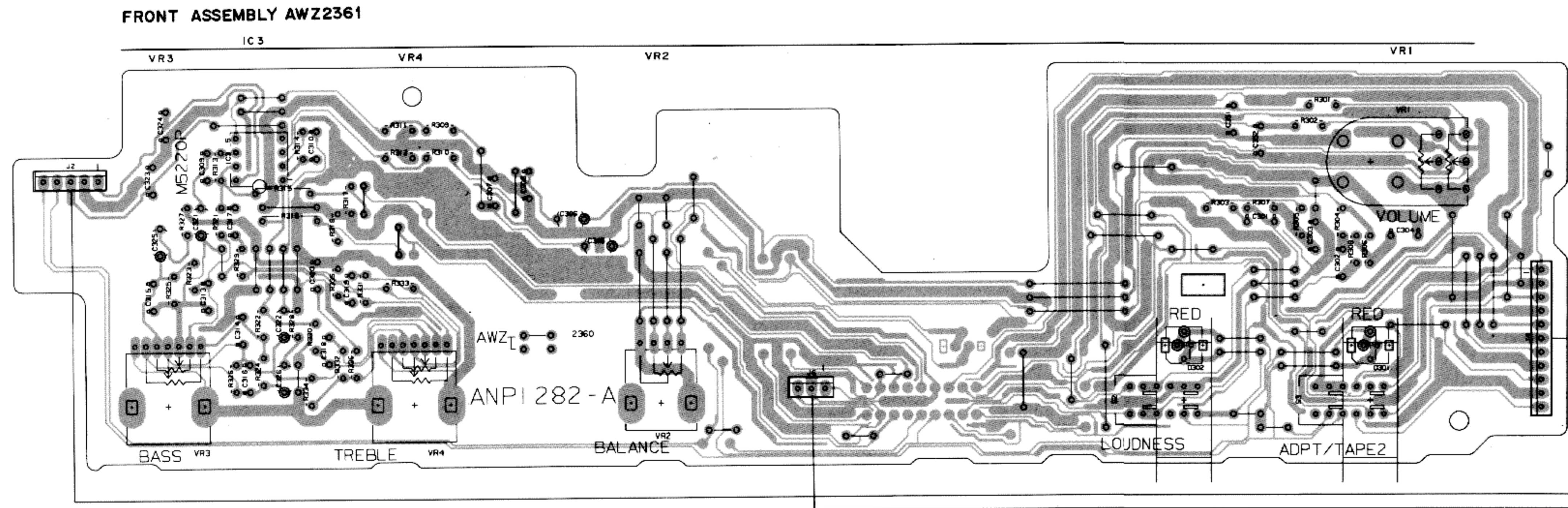

3.4 SCHEMATIC DIAGRAM OF A-115

- This circuit diagram is based on the HEZ version.
- Parts with an asterisk (*) are different from this prepared for the HEZ version.
- Refer to the comparison list.

⊠ Marks are difference between two assemblies.

AF Assembly	HEZ model	HE, HB models
AWZ2358	AWZ2359	
R151-R158	1k Ω	VACANT (JAMPER WIRE)
R201, R202	1.5k Ω	330 Ω
R951, R952	680 Ω (1/2W)	VACANT (OPEN)
R217, R218	220 Ω	180 Ω
C151, C152, C155, C156, C159-C162, C251, C252	390p	VACANT (OPEN)
C953-C955	4700p	220p
C215, C216	390p	
C3	0.1 μ	0.01 μ (ACG1005)
L953, L954	ATH-133	VACANT (JAMPER WIRE)
HEAD PHONE Assembly		
C851, C852	3900p	VACANT (OPEN)

- RESISTORS:**
Indicated in Ω, 2W, 1/2W, 1/8W, ±5% tolerance unless otherwise noted k; kΩ, M; MΩ, (F); ±1%, (G); ±2%, (K); ±10%, (M); ±20% tolerance.
- CAPACITORS:**
Indicated in capacity (μF)/voltage (V) unless otherwise noted p; pF. Indication without voltage is 50V except electrolytic capacitor.
- VOLTAGE CURRENT:**
Signal voltage at (25W + 25W, 8Ω) output (1kHz).
DC voltage (V) at no input signal.
Value in () is DC voltage at rated power.
- OTHERS:**
Signal route.
Adjusting point.
The mark found on some component parts indicates the importance of the safety factor of the part. Therefore, when replacing, be sure to use parts of identical designation.
* marked capacitors and resistors have parts numbers.

- SWITCHES (Underline indicates switch position)**
S1: FUNCTION (PHONO-TUNER-CD-DAT/TAPE1)
S2: LOUDNESS (ON-OFF)
S3: ADPT/TAPE2 (ON-OFF)
S5: POWER (ON-OFF)

This is the basic schematic diagram, but the actual circuit may vary due to improvements in design.

Line Voltage Selection (HEZ, HE and HB types)

Line voltage can be changed with following steps.

1. Disconnect the AC power cord.
2. Remove the Bonnet case.
3. Change the connection of the power transformer lead wire.
4. Stick the line voltage label on the rear panel.

Part No.	Description
AAX-193	220v label
AAX-192	240V label

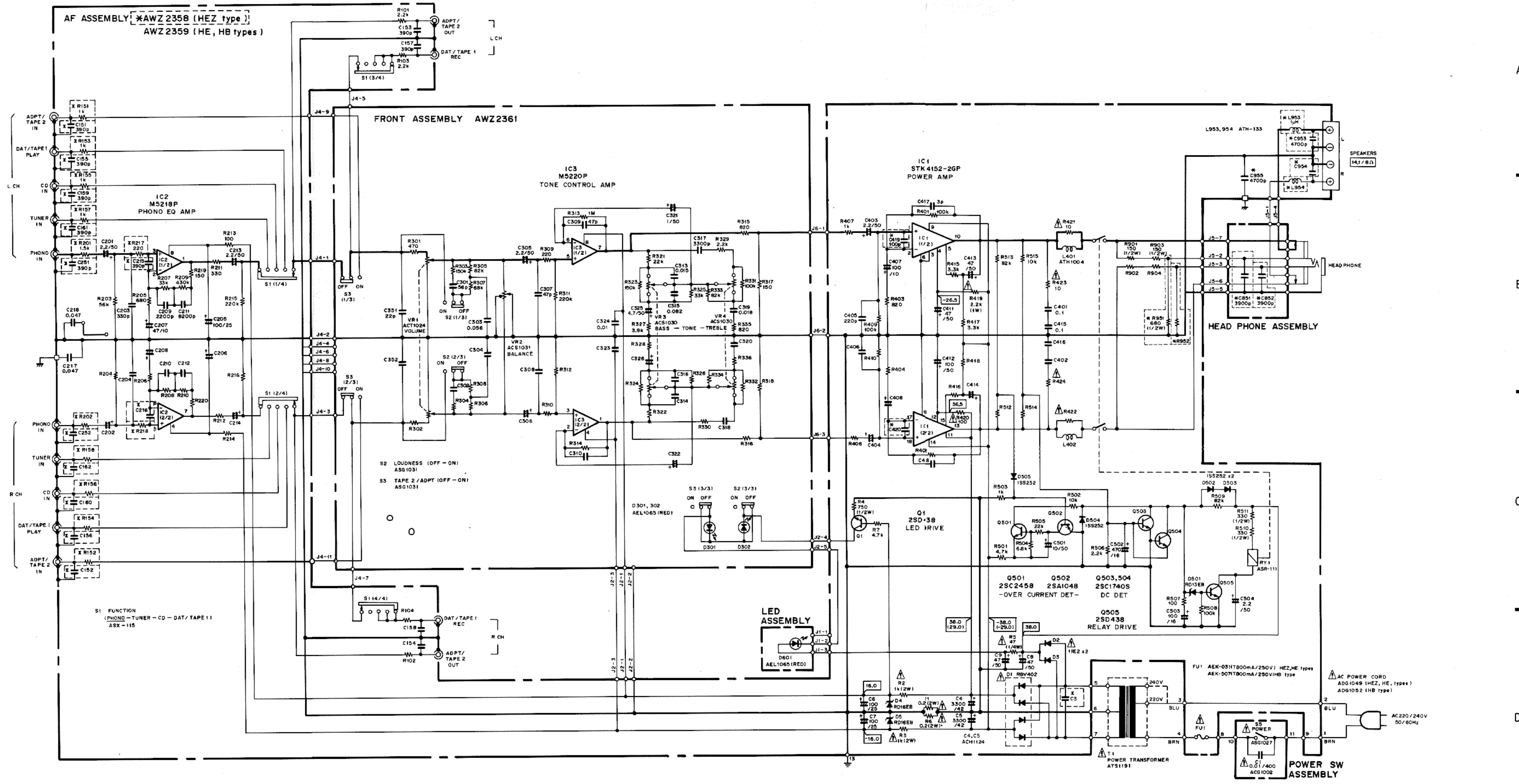

4. ELECTRICAL PARTS LIST

4.1 ELECTRICAL PARTS LIST OF A-225

NOTES :

- Parts without part number cannot be supplied.
- Parts marked by "⊙" are not always kept in stock. Their delivery time may be longer than usual or they may be unavailable.
- The Δ mark found on some component parts indicates the importance of the safety factor of the part. Therefore, when replacing, be sure to use parts of identical designation.
- When ordering resistors, first convert resistance values into code form as shown in the following examples.

Ex.1 When there are 2 effective digits (any digit apart from 0), such as 560 ohm and 47k ohm (tolerance is shown by J=5%, and K=10%).

560 Ω	56 × 10 ¹	561	RD1/4PS	561J
47k Ω	47 × 10 ³	473	RD1/4PS	473J
0.5 Ω	0R5		RN2H	0R5K
1 Ω	010		RS1P	010K

Ex.2 When there are 3 effective digits (such as in high precision metal film resistors).

5.62k Ω	562 × 10 ¹	5621	RN1/4SR	5621F
---------	-----------------------	------	---------	-------

Miscellaneous Parts

P. C. BOARD ASSEMBLIES

Mark	Symbol & Description	Part No.
	AF assembly	AWZ2356
	Front assembly	AWZ2360
	Power SW assembly	
	LED assembly	
	SP SW assembly	

OTHERS

Mark	Symbol & Description	Part No.
Δ	T1 Power transformer	ATS1189
	S1 Remote slide rotary switch	ASU1023
Δ	FU1 Fuse (T1.25A)	AEK-018
Δ	AC Power cord	ADG1049

AF assembly (AWZ2356)

SEMICONDUCTORS

Mark	Symbol & Description	Part No.
	IC2	M5218P
	IC1	STK4181-5G
	Q502	2SA1048
	Q503, Q504	2SC1740S
	Q501	2SC2240
Δ	Q1, Q505	2SD438
	D1	RBV602
	D501	RD13EB
	D4, D5	RD16EB
	D502-D505	1SS252
Δ	D2, D3	11E2

SWITCH AND RELAY

Mark	Symbol & Description	Part No.
	RY1 Relay	ASR-111
	S1 Remote slide switch	ASX-115

COILS

Mark	Symbol & Description	Part No.
	L951-L954 AF choke coil	ATH-133
	L401, L402 AF choke coil	ATH1004

CAPACITORS

Mark	Symbol & Description	Part No.
	C4, C5 (6800 μ F/56V)	ACH1124
	C417, C418	CCDSL030C50
	C409, C410	CCDSL050C50
	C419, C420	CCDSL101J50
	C405, C406	CCDSL221J50
	C501	CEAS100M50
	C407, C408	CEAS101M10
	C6, C7, C205, C206, C503	CEAS101M25
	C412	CEAS101M50
	C201, C202, C213, C214, C403, C404, C504	CEAS2R2M50
	C411	CEAS220M50
	C207, C208	CEAS470M10
	C8, C9, C413, C414	CEAS470M50
	C502	CEAS471M6
	C505	CEJA2R2M50
	C203, C204	CKDYB331K50
	C203, C204, C151-C162, C215, C216, C251, C252	CKDYB391K50
	C951-C955	CKDYB472K50
	C217, C218	CKDYF473Z50
	C401, C402, C415, C416	CQMA104J50
	C209, C210	CQMA222J50
	C211, C212	CQMA822K50
	C3	CQMXA104J100

RESISTORS

Mark	Symbol & Description	Part No.
△	R1	ACN-146
△	R419	RS1LMF222J
△	R2, R3	RS2LMF102J
△	R421-R424	RD $\frac{1}{4}$ PMFL100J
	R5	RFA $\frac{1}{4}$ PS331J
	R4, R510, R511	RD $\frac{1}{2}$ PMF□□□J
	Other resistors	RD $\frac{1}{8}$ PM□□□J

OTHERS

Mark	Symbol & Description	Part No.
	Pin jack 4P	AKB1007
	Pin jack 6P	AKB1008
	Speaker terminal 8P	AKE-111

Front assembly (AWZ2360)**SEMICONDUCTORS**

Mark	Symbol & Description	Part No.
	IC3	M5220P
	D301, D302	AEL1065
	D303	AEL1084

SWITCHES

Mark	Symbol & Description	Part No.
	S4 Switch	ASG1030
	S2, S3 Push switch	ASG1031

CAPACITORS

Mark	Symbol & Description	Part No.
	C351, C352	CCDSL220J50
	C307-C310	CCDSL470J50
	C301, C302	CCDSL560J50
	C321, C322	CEAS010M50
	C305, C306	CEAS2R2M50
	C311, C312, C325, C326	CEAS4R7M50
	C303, C304	CFTXA563J50
	C323, C324	CKDYF103Z50
	C313, C314	CQMA153K50
	C319, C320	CQMA183K50
	C317, C318	CQMA332K50
	C315, C316	CQMA823K50

RESISTORS

Mark	Symbol & Description	Part No.
	VR3, VR4 Variable resistor	ACS1030
	VR2 Variable resistor	ACS1031
	VR1 Variable resistor	ACT1024
	Other resistors	RD $\frac{1}{8}$ PM□□□J

Power SW assembly**SWITCH**

Mark	Symbol & Description	Part No.
	S5 Push switch (POWER)	ASG1027

CAPACITOR

Mark	Symbol & Description	Part No.
△	C1 (0.01 μ F/400V)	ACG1002

LED Assembly**SEMICONDUCTORS**

Mark	Symbol & Description	Part No.
	D601	AEL1065

SP SW Assembly**SWITCH**

Mark	Symbol & Description	Part No.
	S6 Push switch	SUL5LXBXS

CPACITORS

Mark	Symbol & Description	Part No.
	C751, C752	CKDYB392K50

RESISTORS

Mark	Symbol & Description	Part No.
	All resistors	RD $\frac{1}{2}$ PMF□□□J

OTHERS

Mark	Symbol & Description	Part No.
	Jack (PHONES)	AKN1002

4.2 ELECTRICAL PARTS LIST OF A-115

Miscellaneous Parts

P.C.BOARD ASSEMBLY

Mark	Symbol & Description	Part No.
	AF assembly	AWZ2358
	Front assembly	AWZ2361
	Power SW assembly	
	LED assembly	
	Headphone assembly	

OTHERS

Mark	Symbol & Description	Part No.
△	T1 Power transformer	ATS1191
	S1 Remote slide rotary switch	ASU1023
△	FU1 Fuse (T800mA)	AEK-031
△	AC Power cord	ADG1049

AF assembly (AWZ2358)

SEMICONDUCTORS

Mark	Symbol & Description	Part No.
	IC2	M5218P
	IC1	STK4152-2GP
	Q502	2SA1048
	Q503, Q504	2SC1740S
	Q501	2SC2458
△	Q1, Q505	2SD438
	D1	RBV402
	D501	RD13EB
	D4, D5	RD16EB
	D502-D505	1SS252
△	D2, D3	11E2

SWITCH AND RELAY

Mark	Symbol & Description	Part No.
	RY1 Relay	ASR-111
	S1 Remote slide switch	ASX-115

COILS

Mark	Symbol & Description	Part No.
	L953, L954 AF choke coil	ATH-133
	L401, L402 AF choke coil	ATH1004

CAPACITORS

Mark	Symbol & Description	Part No.
	C4, C5 (3300 μ F/42V)	ACH1123
	C417, C418	CCDSL030C50
	C419, C420	CCDSL101J50
	C405, C406	CCDSL221J50
	C501	CEAS100M50

Mark	Symbol & Description	Part No.
	C407, C408	CEAS101M10
	C503	CEAS101M16
	C6, C7, C205, C206	CEAS101M25
	C412	CEAS101M50
	C201, C202, C213, C214, C403, C404, C504	CEAS2R2M50
	C207, C208	CEAS470M10
	C8, C9, C411, C413, C414	CEAS470M50
	C502	CEAS471M6
	C203, C204	CKDYB331K50
	C151-C162, C215, C216, C251, C252	CKDYB391K50
	C953-C955	CKDYB472K50
	C217, C218	CKDYF473Z50
	C401, C402, C415, C416	CQMA104J50
	C209, C210	CQMA222J50
	C211, C212	CQMA822K50
	C3	CQMXA104J100

RESISTORS

Mark	Symbol & Description	Part No.
△	R421-R424	RD¼PMFL100J
△	R420	RFA¼PL101J
	R5	RFA¼PS470J
△	R419	RS1LMF222J
△	R1, R6	RS2LMFR22J
△	R2, R3	RS2LMF102J
	R4, R510, R511, R901-R904, R951, R952	RD½PMF□□□J
	Other resistors	RD½PM□□□J

OTHERS

Mark	Symbol & Description	Part No.
	Pin jack 4P	AKB1007
	Pin jack 6P	AKB1008
	Speaker terminal 4P	AKE-109

Front assembly (AWZ2361)

SEMICONDUCTORS

Mark	Symbol & Description	Part No.
	IC3	M5220P
	D301, D302	AEL1065

SWITCHES

Mark	Symbol & Description	Part No.
	S2, S3 Push switch	ASG1031

CAPACITORS

<u>Mark</u>	<u>Symbol & Description</u>	<u>Part No.</u>
	C351, C352	CCDSL220J50
	C307-C310	CCDSL470J50
	C301, C302	CCDSL560J50
	C321, C322	CEAS010M50
	C305, C306	CEAS2R2M50
	C325, C326	CEAS4R7M50
	C303, C304	CFTXA563J50
	C323, C324	CKDYF103Z50
	C313, C314	CQMA153K50
	C319, C320	CQMA183K50
	C317, C318	CQMA332K50
	C315, C316	CQMA823K50

RESISTORS

<u>Mark</u>	<u>Symbol & Description</u>	<u>Part No.</u>
	VR3, VR4 Variable resistor	ACS1030
	VR2 Variable resistor	ACS1031
	VR1 Variable resistor	ACT1024
	Other resistor	RD $\frac{1}{8}$ PM <input type="checkbox"/> <input type="checkbox"/> <input type="checkbox"/> J

Power SW Assembly**SWITCH**

<u>Mark</u>	<u>Symbol & Description</u>	<u>Part No.</u>
△	S5 Push switch (POWER)	ASG1027

CAPACITOR

<u>Mark</u>	<u>Symbol & Description</u>	<u>Part No.</u>
△	C1 (0.01 μ F/400V)	ACG1002

LED Assembly**SEMICONDUCTORS**

<u>Mark</u>	<u>Symbol & Description</u>	<u>Part No.</u>
	D601	AEL1065

Headphone Assembly**CAPACITORS**

<u>Mark</u>	<u>Symbol & Description</u>	<u>Part No.</u>
	C851, C852	CKDYB392K50

OTHER

<u>Mark</u>	<u>Symbol & Description</u>	<u>Part No.</u>
	Jack (PHONES)	AKN1010

5. FOR A-225/HE, HB AND A-225-S/HEZ TYPES

CONTRAST OF MISCELLANEOUS PARTS

NOTES :

- Parts without part number cannot be supplied.
- The Δ mark found on some component parts indicates the importance of the safety factor of the part. Therefore, when replacing, be sure to use parts of identical designation.
- Parts marked by "⊙" are not always kept in stock. Their delivery time may be longer than usual or they may be unavailable.

The A-225/HE, HB and A-225-S/HEZ types are the same as the A-225/HEZ type with the exception of the following sections.

Mark	Symbol & Description	Part No.				Remarks
		A-225/HEZ type	A-225/HE type	A-225/HB type	A-225-S/HEZ type	
Δ Δ Δ	AF assembly	AWZ2356	AWZ2357	AWZ2357	AWZ2356	
	SP SW assembly	Non supply	Non supply	Non supply	Non supply	
	AC Power cord	ADG1049	ADG1049	ADG1052	ADG1049	
	FU1 Fuse (T1.25A/250V)	AEK-018	AEK-018	AEK-018	
	FU1 Fuse (1.25A/250V)	AEK-509	
	Volume (S)	AAB1068	AAB1068	AAB1068	AAB1069	
	Knob (L)	AAB1093	AAB1093	AAB1093	AAB1095	
	Knob (M)	AAB1094	AAB1094	AAB1094	AAB1096	
	Knob (B)	AAD-418	AAD-418	AAD-418	AAD1368	
	Knob (POWER)	AAD1535	AAD1535	AAD1535	AAD1537	
	Knob	AAD1536	AAD1536	AAD1536	AAD1538	
	Panel base	AMB1453	AMB1453	AMB1453	AMB1454	
	Front panel	ANB1263	ANB1263	ANB1263	ANB1264	
	Bonnet	ANE1174	ANE1174	ANE1174	ANE1175	
	Nut	NK90FZB	NK90FZB	NK90FZB	NK90FUC	
Packing case	AHD1596	AHD1596	AHD1596	AHD1597		
Operating instructions (German)	ARC1124	ARC1124		
Operating instructions (English/German/French/Italian/Swedish/Dutch/Spanish/Portuguese)	ARE1127		
Operating instructions (English)	ARB1161		

NOTE: The SP SW assembly (for A-225/HE type) is the same as the SP SW assembly (for A-225/HB type).

AF ASSEMBLY

The AF assembly (AWZ2357 ; HE and HB types) are the same as the AF assembly (AWZ2356 ; HEZ type) with the exception of the following sections.

Mark	Symbol & Description	Part No.		Remarks
		AWZ2356 HEZ type	AWZ2357 HE and HB types	
	C3	CQMXA104J100	ACG1005	
	C151, C152, C155, C156, C159-C162,	CKDYB391K50	
	C251, C252	CKDYB391K50	CCDSL221J50	
	C215, C216	CCDSL101J50	
	C419, C420	CKDYB472K50	
	C951-C955	ATH-133	
	L951-L954	RD 1/8 PM102J	
	R151-R158	RD 1/8 PM152J	RD 1/8 PM331J	
	R201, R202	RD 1/8 PM221J	RD 1/8 PM181J	
	R217, R218			

SP SW ASSEMBLY

The SP SW assembly (HE and HB types) are the same as the SP SW assembly (HEZ type) with the exception of the following sections.

Mark	Symbol & Description	Part No.		Remarks
		A-225/HEZ type	A-225/HE and HB types	
	C751, C752 R751, R752	CKDYB392K50 RD½PMF681J	

6. FOR A-115/HE AND HB TYPES

CONTRAST OF MISCELLANEOUS PARTS

NOTES :

- Parts without part number cannot be supplied.
- The Δ mark found on some component parts indicates the importance of the safety factor of the part. Therefore, when replacing, be sure to use parts of identical designation.
- Parts marked by "⊙" are not always kept in stock. Their delivery time may be longer than usual or they may be unavailable.

The A-115/HE and HB types are the same as the A-115/HEZ type with the exception of the following sections.

Mark	Symbol & Description	Part No.			Remarks
		A-115/HEZ type	A-115/HE type	A-115/HB type	
Δ	AF assembly	AWZ2358	AWZ2359	AWZ2359	
Δ	Headphone assembly	Non supply	Non supply	Non supply	
Δ	AC Power cord	ADG1049	ADG1049	ADG1052	
Δ	FU1 Fuse (800mA/250V)	AEK-031	AEK-031	
Δ	FU1 Fuse (800A/250V)	AEK-057	
	Operating instructions (German)	ARC1124	
	Operating instructions (English/German/French/Italian/ Swedish/Dutch/Spanish/Portuguese)	ARE1105	
	Operating instructions (English)	ARB1161	

AF ASSEMBLY

The AF assembly (AWZ2359 ; HE and HB types) are the same as the AF assembly (AWZ2358 ; HEZ type) with the exception of the following sections.

Mark	Symbol & Description	Part No.		Remarks
		AWZ2358 HEZ type	AWZ 2359 HE and HB types	
	C3	CQMXA104J100	ACG1005	
	C151, C152, C155, C156, C159-C162,	CKDYB391K50	
	C251, C252	CKDYB391K50	CCDSL221J50	
	C215, C216	CKDYB472K50	
	C953-C955	ATH-133	
	L953, L954	RD $\frac{1}{8}$ PM102J	
	R151-R158	RD $\frac{1}{8}$ PM152J	RD $\frac{1}{8}$ PM331J	
	R201, R202	RD $\frac{1}{8}$ PM221J	RD $\frac{1}{8}$ PM181J	
	R217, R218	RD $\frac{1}{2}$ PMF681J	
	R951, R952			

HEADPHONE ASSEMBLY

The headphone assembly (HE and HB types) are the same as the headphone assembly (HEZ type) with the exception of the following sections.

Mark	Symbol & Description	Part No.		Remarks
		A-115/HEZ type	A-115/HE and HB types	
	C851, C852	CKDYB392K50	

7. SPECIFICATIONS

[A-225]

Amplifier Section

Continuous power output (both channels driven at 20 Hz to 20 kHz) **	
T.H.D. 0.07%, 8 Ω	35W + 35W *
DIN Continuous power output (both channels driven at 1 kHz)	
T.H.D. 1.0%, 8 Ω	40W + 40W
T.H.D. 1.0%, 4 Ω	50W + 50W
Total harmonic distortion **	
20 Hz to 20 kHz, 35W, 8 Ω	0.07% *
Input sensitivity/impedance	
PHONO (MM)	2.5 mV/50 k Ω
CD, TUNER, DAT/TAPE 1, ADPT/TAPE 2	150 mV/50 k Ω
PHONO overload level	
1 kHz, T.H.D. 0.1% (MM)	150 mV
Output level/impedance	
TAPE REC, ADAPTOR OUTPUT	150 mV/2.2 k Ω
Frequency response	
PHONO (MM), 20 Hz to 20 kHz	± 0.5 dB
CD, TUNER, DAT/TAPE 1, ADPT/TAPE 2, 10Hz to 50 kHz	
.....	$+1$ -3 dB *

Tone control (volume control set at - 30 dB position)	
BASS	± 8 dB (100 Hz)
TREBLE	± 8 dB (10 kHz)
Loudness contour (volume control set at - 30 dB position)	
.....	+6dB (100 Hz)/+3 dB (10 kHz)
Signal-to-Noise ratio (IHF short circuit, A network)	
PHONO (MM, 5 mV input)	77 dB *
CD, TUNER, DAT/TAPE 1, ADPT/TAPE 2	100 dB *
Signal-to-Noise ratio (DIN, continuous power/50 mW)	
PHONO (MM)	67 dB/61 dB *
CD, TUNER, DAT/TAPE 1, ADPT/TAPE 2	83 dB/63 dB *

Power Supply/Miscellaneous

Power requirements	
U.K., Australian models	a.c.240V, 50/60 Hz
Other destination models	
.....	AC 110V/120 ~ 127V/220V/240V (switchable), 50/60 Hz
Power consumption	330W
Dimensions (including knobs and other protruding parts)	
.....	420(W) \times 282(D) \times 103(H) mm 16-1/2(W) \times 11-1/8(D) \times 4-1/16(H) in
Weight (without package)	5.6 kg (12 lb 6 oz)

Accessories

Operating instructions	1
------------------------------	---

- Specifications and design subject to possible modification without notice, due to improvements.
- * Measured with the DIRECT switch set to ON.
For ADPT/TAPE 2, however, measured with the DIRECT switch set to OFF and the tone and balance controls in center position.
- ** Measured by Audio Spectrum Analyzer.

[A-115]

Amplifier Section

Continuous power output (both channels driven at 30 Hz to 20 kHz) **	
T.H.D. 0.2%, 8 Ω	25W + 25W *
DIN Continuous power output (both channels driven at 1 kHz)	
T.H.D. 1.0%, 8 Ω	30W + 30W
Total harmonic distortion **	
30 Hz to 20 kHz, 25W, 8 Ω	0.2% *
Input sensitivity/impedance	
PHONO (MM)	2.5 mV/50 k Ω
CD, TUNER, DAT/TAPE 1, ADPT/TAPE 2	150 mV/50 k Ω
PHONO overload level	
1 kHz, T.H.D. 0.1% (MM)	150 mV
Output level/impedance	
TAPE REC, ADAPTOR OUTPUT	150 mV/2.2 k Ω
Frequency response	
PHONO (MM), 30 Hz to 20 kHz	± 0.5 dB
CD, TUNER, DAT/TAPE 1, ADPT/TAPE 2, 10Hz to 50 kHz	
.....	$+1$ -3 dB *
Tone control (volume control set at - 30 dB position)	
BASS	± 8 dB (100 Hz)
TREBLE	± 8 dB (10 kHz)

Loudness contour (volume control set at - 30 dB position)	
.....	+6 dB (100 Hz)/+3 dB (10 kHz)
Signal-to-Noise ratio (IHF short circuit, A network)	
PHONO (MM, 5 mV input)	77 dB *
CD, TUNER, DAT/TAPE 1, ADPT/TAPE 2	95 dB *
Signal-to-Noise ratio (DIN, continuous power/50 mW)	
PHONO (MM)	63 dB/60 dB *
CD, TUNER, DAT/TAPE 1, ADPT/TAPE 2	81 dB/62 dB *

Power Supply/Miscellaneous

Power requirements	
U.K., Australian models	a.c.240V, 50/60 Hz
Other destination models	
.....	AC110V/120 ~ 127V/220V/240V (switchable) 50/60 Hz
Power consumption	210W
Dimensions (including knobs and other protruding parts)	
.....	420(W) \times 282(D) \times 98(H) mm 16-1/2(W) \times 11-1/8(D) \times 3-7/8(H) in
Weight (without package)	4.6 kg (10 lb 2 oz)

Accessories

Operating instructions	1
------------------------------	---

- Specifications and design subject to possible modification without notice, due to improvements.
- * Measured with tone and balance controls set to center position.
- ** Measured by Audio Spectrum Analyzer.

8. PANEL FACILITIES

[FRONT PANEL]

The illustration shows model A-225.
Model A-115 is not equipped with ⑥,
⑩ and ⑪.

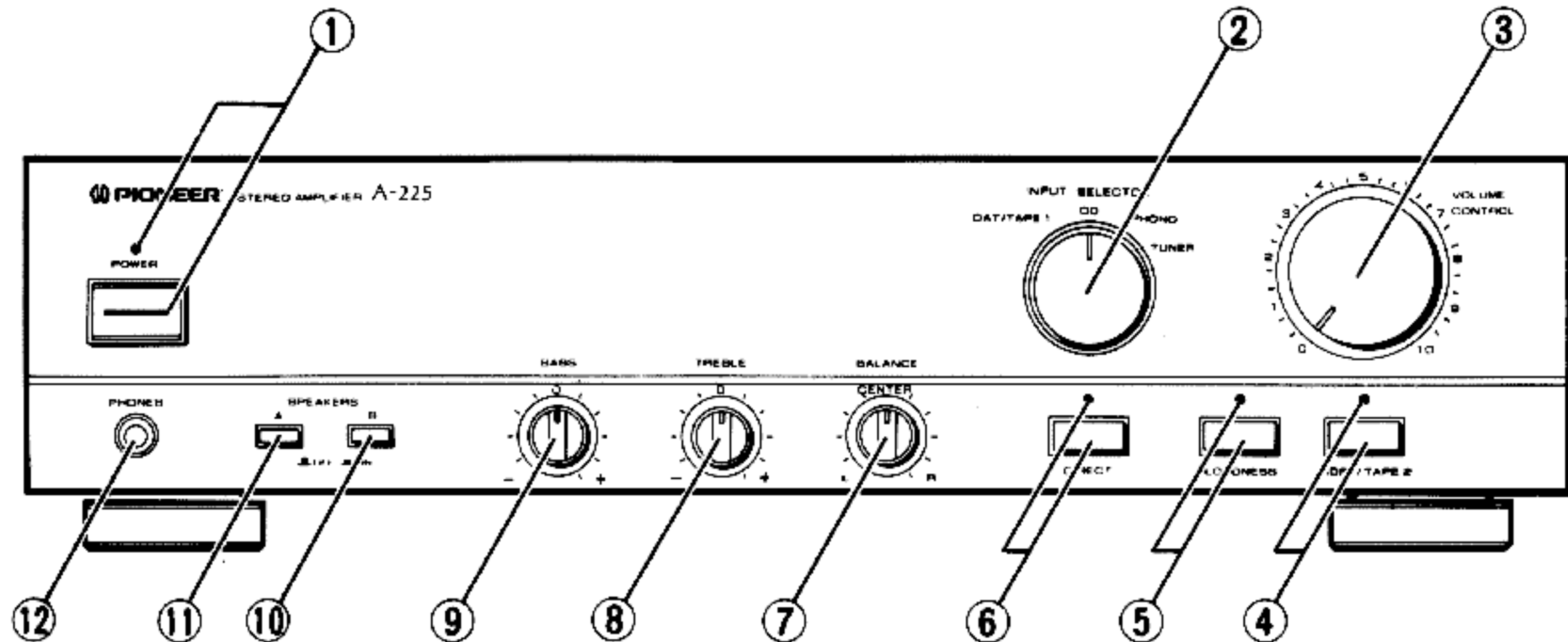

① POWER switch/indicator

Press to turn power to the unit ON and OFF.

ON:

Indicator lights.

OFF:

Indicator goes out.

② INPUT SELECTOR switch

Use to select the playback source.

TUNER:

For AM or FM broadcast reception with a tuner.

PHONO:

For record playback with a turntable.

CD:

For compact disc playback with a CD player.

DAT/TAPE 1:

For playback with a tape deck or digital audio tape deck connected to the DAT/TAPE 1 terminals.

③ VOLUME CONTROL

Use to adjust the volume level.

④ ADPT/TAPE 2 monitor switch/indicator

Use when there is an adaptor component (graphic equalizer, etc.) or tape deck connected to the ADPT/TAPE 2 terminals.

OFF:

Indicator goes out when not in use.

ON:

Indicator lights when using the adaptor component or listening to the tape deck.

NOTE:

- When no connections are made to the ADPT/TAPE 2 terminals, or when they are not in use, be sure to set this switch to the OFF position. (No sound will be heard if it is set to the ON position.)
- When the DIRECT switch is set to ON, the input to be reproduced is always selected with the INPUT SELECTOR, regardless of whether the ADPT/TAPE 2 indicator lights or not. Furthermore, when the ADPT/TAPE 2 indicator is ON, signals input through ADPT/TAPE 2 are output at DAT/TAPE 1 REC OUT. (A-225 only)

⑤ LOUDNESS switch/indicator

Use when listening at low volume levels.

ON:

The indicator lights: Boosts low and high frequencies to give added punch to playback even at low volume levels.

OFF:

The indicator goes off: Should normally be left in this position.

⑥ DIRECT switch/indicator (A-225 only)

Use this switch when you do not wish to pass the output from input terminal equipment through the various frequency adjusting circuits (BASS, TREBLE, BALANCE.)

ON:

The indicator lights: The signals input through the input terminals are reproduced without passing through the various frequency adjusting circuits. This results in flat, pure sound which is a more faithful reproduction of the input source.

OFF:

The indicator goes out: The signal passes through the various frequency adjusting circuits.

⑦ BALANCE control

Should normally be left in the center position. Adjust the balance if the sound is louder from one of the speakers. If the right side is louder, turn toward the L(left) position and if the left side is louder, turn toward the R(right) position.

NOTE:

This control does not operate when the DIRECT switch is in the ON position. (A-225 only)

⑧ TREBLE tone control

Use to adjust the high-frequency tone. The center position is the flat (normal) position. When turned to the right, high-frequency tone is emphasized; when turned to the left, high-frequency tone is de-emphasized.

NOTE:

This control does not operate when the DIRECT switch is in the ON position. (A-225 only)

⑨ BASS tone control

Use to adjust the low-frequency tone. The center position is the flat (normal) position. When turned to the right, low-frequency tone is emphasized; when turned to the left, low-frequency tone is de-emphasized.

NOTE:

This control does not operate when the DIRECT switch is in the ON position. (A-225 only)

⑩ SPEAKERS B selector switch (A-225 only)

Use this switch to listen to the speaker systems connected to the SPEAKERS B terminals.

ON (—):

Depressed position: Sound is heard from the speaker systems.

OFF (■):

Released position: No sound is heard from the speaker systems. Set to this position when listening with headphones.

⑪ SPEAKERS A selector switch (A-225 only)

Use this switch to listen to the speaker systems connected to the SPEAKERS A terminals.

ON (—):

Depressed position: Sound is heard from the speaker systems.

OFF (■):

Released position: No sound is heard from the speaker systems. Set to this position when listening with headphones.

⑫ PHONES jack

When using headphones, insert the plug into this jack. With model A-115 the output to the speakers is cut automatically when connecting headphones.

[A-225 only]

Model A-225 can be placed on another component with less depth by changing the position of the rear feet. (However, a minimum depth of 200 mm is required.)

Change the position of the rear feet as follows:

1. Remove the AC plugs, connection cords etc., connected to the A-225, and turn the unit upside down.
2. Remove the screws holding the rear feet using a (+) screwdriver.
3. Move the rear feet to the holes located towards the center of the unit (see the arrows in the diagram).
4. Secure the feet by tightening the screws removed in step 2 with a (+) screwdriver.

