

ADDITIONAL



PIONEER
The future of sound and vision.

Service Manual

ORDER NO.
ARP1776

STEREO AMPLIFIER

A-X450 HE, HB, HEZ

A-X350 HE, HB, HEZ

A-X450 AND A-X350 HAVE FOLLOWING VERSIONS :

Type	Applicable model		Power requirement	Export destination
	A-X450	A-X350		
HE	○	○	AC220V, 240V (switchable)*	European continent
HB	○	○	AC220V, 240V (switchable)*	United Kingdom
HEZ	○	○	AC220V, 240V (switchable)*	West Germany

*Change the primary wiring of the power transformer.

- Refer to the service manual ARP1577, A-X540, A-X440/HE, A-X340/HE.
- This manual is applicable to the A-X450/HE, HB, HEZ, A-X350/HE, HB and HEZ types.
- The A-X450/HE, HB and HEZ types are the same as the A-X440/HE, HB and HEZ types except for an appearance.
- The A-X350/HE, HB and HEZ types are the same as the A-X340/HE, HB and HEZ types except for an appearance.

PIONEER ELECTRONIC CORPORATION 4-1, Meguro 1-Chome, Meguro-ku, Tokyo 153, Japan

PIONEER ELECTRONICS SERVICE INC. P.O. Box 1760, Long Beach, California 90801 U.S.A.

PIONEER ELECTRONICS OF CANADA, INC. 505 Cochrane Drive, Markham, Ontario L3R 8E3 Canada

PIONEER ELECTRONIC [EUROPE] N.V. Keetberglaan 1, 2740 Beveren, Belgium

PIONEER ELECTRONICS AUSTRALIA PTY. LTD. 178-184 Boundary Road, Braeside, Victoria 3195, Australia TEL: [03] 580-9911

© **PIONEER ELECTRONIC CORPORATION 1989**

SV APR. 1989 Printed in Japan

1. FOR A-X450/HE, HB AND HEZ TYPES

1.1 CONTRAST OF MISCELLANEOUS PARTS

NOTES :

- Parts without part number cannot be supplied.
- The Δ mark found on some component parts indicates the importance of the safety factor of the part. Therefore, when replacing, be sure to use parts of identical designation.
- Parts marked by "⊙" are not always kept in stock. Their delivery time may be longer than usual or they may be unavailable.

The A-X450/HE, HB and HEZ types are the same as the A-X440/HE type with the exception of the following sections.

Mark	Symbol & Description	Part No.				Remarks
		A-X440/HE type	A-X450/HE type	A-X450/HB type	A-X450/HEZ type	
	AF main assembly	AWZ1777	AWZ1777	AWZ1777	AWZ1787	
	SP assembly	Non supply	Non supply	Non supply	Non supply	
	HP assembly	Non supply	Non supply	Non supply	Non supply	
	FILTER assembly	Non supply	
Δ	FU2 Fuse (T2A/250V)	AEK-017	AEK-017	AEK-017	
Δ	FU1 Fuse (T2.5A/250V)	AEK-403	AEK-403	AEK-403	
Δ	FU2 Fuse (T2A/250V)	AEK-511	
Δ	FU1 Fuse (T2.5A/250V)	AEK-512	
Δ	AC socket (3P OUTLET)	AKP-502	AKP-502	AKP-505	AKP-502	
Δ	AC Power cord	ADG1021	ADG1021	ADG-063	ADG1021	
	C1 Capacitor	CQMA473K250	
	Function knob	AAD1382	AAD1564	AAD1564	AAD1564	
*1	Leg assembly	AMR1285	
*1	Insulator assembly	AMR1459	AMR1459	AMR1459	
*1	Screw	ABA1050	ABA1050	AMR1050	
	Screw	ABA-115	
	Front panel	ANB1227	ANB1267	ANB1267	ANB1267	
	Pad	AHA1069	AHA1202	AHA1202	AHA1202	
	Packing case	AHD1415	AHD1649	AHD1649	AHD1649	
	Operating instructions (English/French/German/Italian/Dutch/Swedish/Spanish/Portuguese)	ARE1081	ARE1128	
	Operating instructions (English)	ARB1181	
	Operating instructions (German)	ARC1158	

*1: In A-X450, the insulator assembly is attached instead of the leg assembly in A-X440

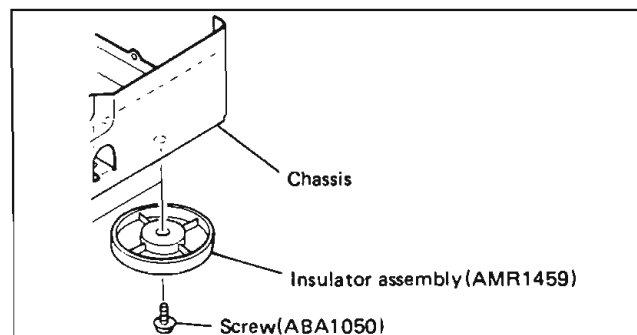

AF MAIN ASSEMBLY

The AF main assembly (AWZ1787) is the same as the AF main assembly (AWZ1777) with the exception of the following sections.

Mark	Symbol & Description	Part No.		Remarks
		AWZ1777	AWZ1787	
	C103, C104 C107, C108 C801-C816 R101, R102 R119-R124, R127, R128, R131, R132	CKMYB221K50 CKMYB221K50 RD $\frac{1}{4}$ PM331J RD $\frac{1}{4}$ PM471J	CKDYB331K50 CKCYB391K50 CKDYB391K50 RD $\frac{1}{4}$ PM152J RD $\frac{1}{4}$ PM102J	

SP ASSEMBLY

The SP assembly (for A-X450/HEZ type) is the same as the SP assembly (for A-X440/HE, A-X450/HE and HB types) with the exception of the following sections.

Mark	Symbol & Description	Part No.		Remarks
		A-X440/HE, A-X450/HE and HB types	A-X450/HEZ type	
	C817-C820 C837, C838 C839-C842 L801-L804 AF choke coil R1-R4 R403, R404 RD $\frac{1}{4}$ PM471J	CKDYB391K50 CKDYB331K50 CQMA103K50 ATH-133 RD $\frac{1}{4}$ PM4R7J RD $\frac{1}{4}$ PM102J	

HP ASSEMBLY

The HP assembly (for A-X450/HEZ type) is the same as the HP assembly (for A-X440/HE, A-X450/HE and HB types) with the exception of the following sections.

Mark	Symbol & Description	Part No.		Remarks
		A-X440/HE, A-X450/HE and HB types	A-X450/HEZ type	
	C843, C844	CQMA472K50	

● ELECTRICAL PARTS LIST**FILTER assembly****FILTER**

<u>Mark</u>	<u>Symbol & Description</u>	<u>Part No.</u>
△	L501 Line filter	ATF-151

Line voltage selection

Line voltage can be changed with following steps.

1. Disconnect the AC power cord.
2. Remove the Bonnet case.
3. Change the connection wire (To power transformer) of Terminal No. 3 or No. 5 (White) as follows.

Voltage	Terminal No. 3	Terminal No. 5
220V	White
240V	White

4. Stick the line voltage label on the rear panel.

<u>Part No.</u>	<u>Description</u>
AAX-193	220V label
AAX-192	240V label

● View from soldering side

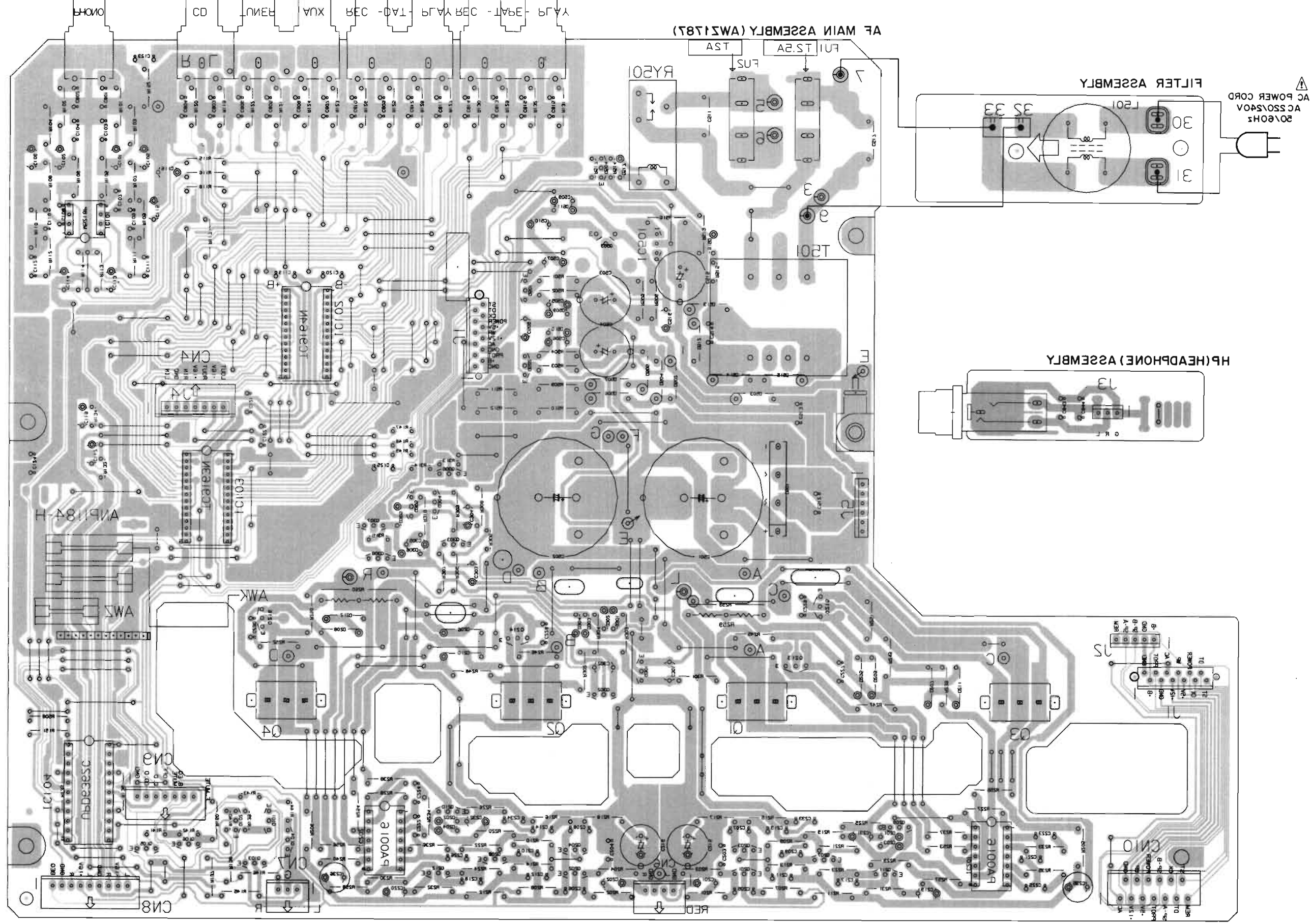
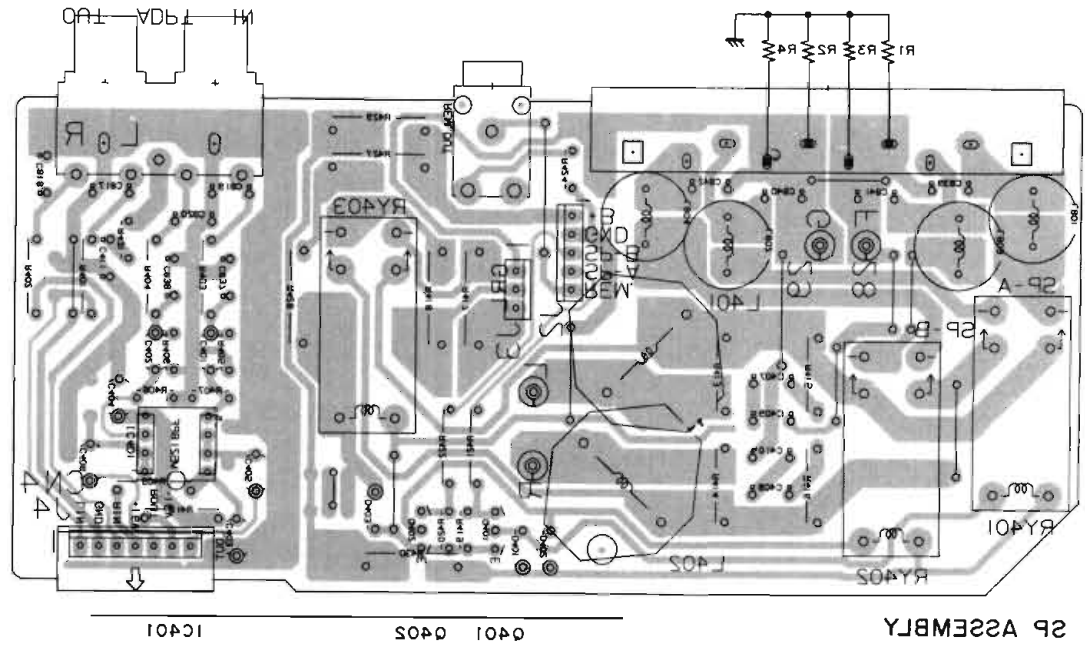

0501	0502	0503	0504	0505	0506	0507	0508	0509	0510	0511	0512	0513	0514	0515	0516	0517	0518	0519	0520	0521	0522	0523	0524	0525	0526	0527	0528	0529	0530	0531	0532	0533	0534	0535	0536	0537	0538	0539	0540	0541	0542	0543	0544	0545	0546	0547	0548	0549	0550
------	------	------	------	------	------	------	------	------	------	------	------	------	------	------	------	------	------	------	------	------	------	------	------	------	------	------	------	------	------	------	------	------	------	------	------	------	------	------	------	------	------	------	------	------	------	------	------	------	------

A B C D

A B C D

1 2 3 4 5 6 7 8 9

1 2 3 4 5 6 7 8 9

1.2 P. C. BOARD PATTERNS (FOR A-X450/HEZ TYPE)

● View from component side

NOTE

1. This P.C.B connection diagram is viewed from the parts mounted side.
2. The parts which have been mounted on the board can be replaced with those shown with the corresponding wiring symbols listed in the following Table.

P.C.B. pattern diagram indication	Corresponding part symbol	Part Name
EO 0504		Transistor
Q215		Radiator type transistor
D203		Diode
R237		Resistor
C513		Capacitor (Polarity)
C518		Capacitor (Non-polarity)

Others

P.C.B. pattern diagram indication	Part Name
IC	IC
S	Switch
RY	Relay
L	Coil
F	Filter
VR	Variable resistor or Semi-fixed resistor

3. The capacitor terminal marked with ⊙ (double circles) shows negative terminal.
4. The diode terminal marked with ⊙ (double circles) shows cathode side.
5. The transistor terminal to which E is affixed shows the emitter.

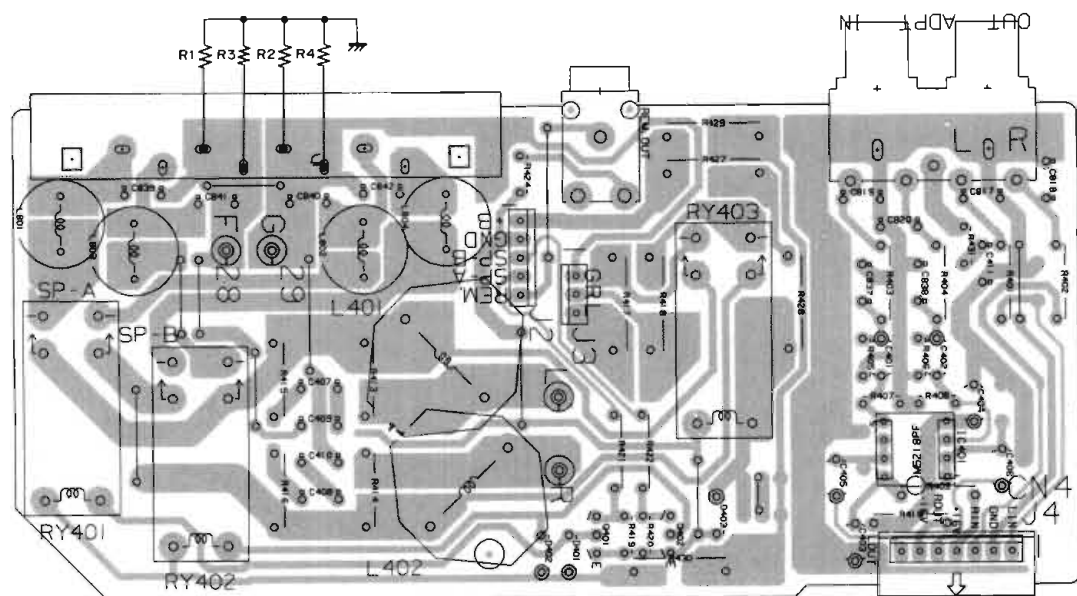

SP ASSEMBLY Q401 Q402 IC401

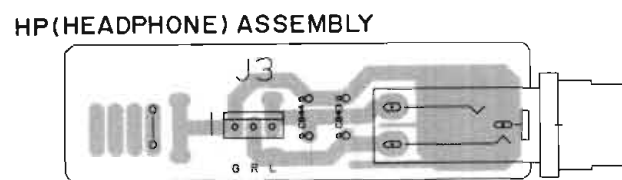
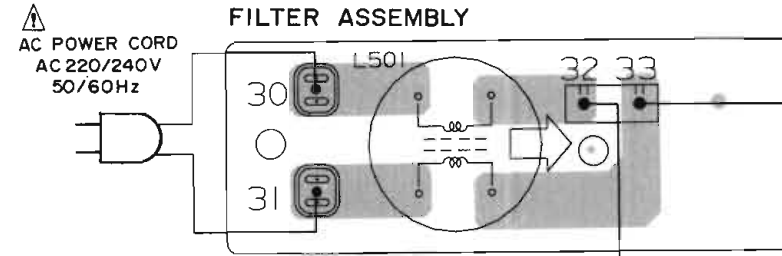
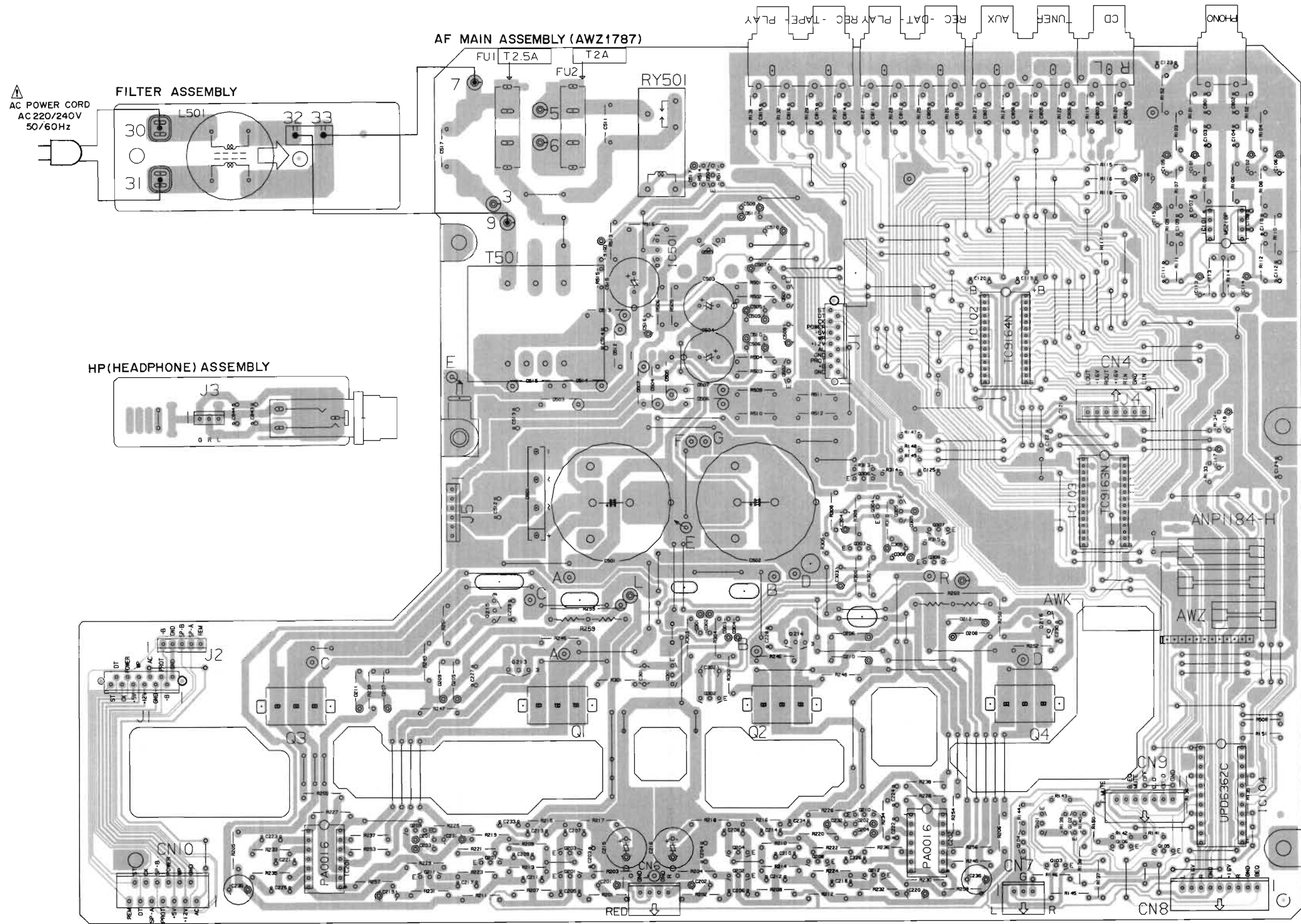

2. FOR A-X350/HE, HB AND HEZ TYPES

2.1 SCHEMATIC DIAGRAM (FOR A-X350/HEZ TYPE)

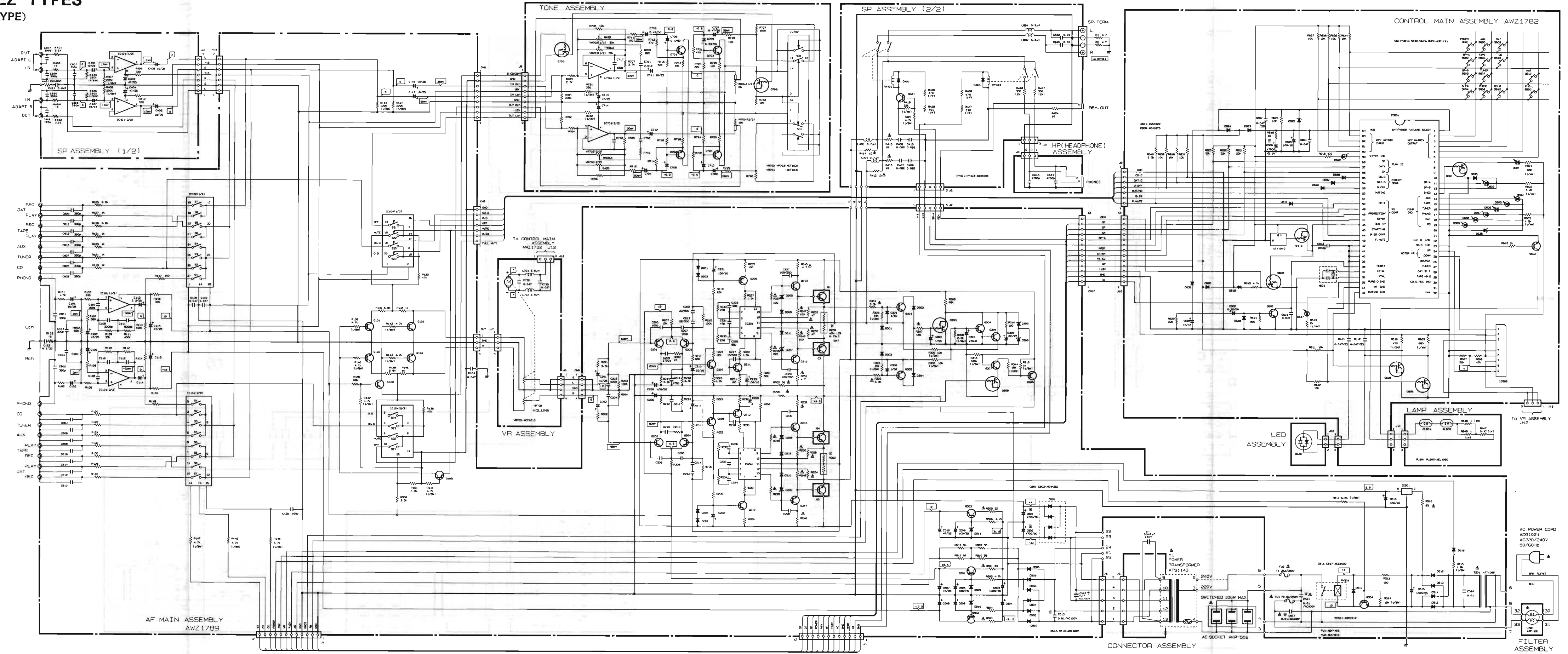

1.3 SCHEMATIC DIAGRAM (FOR A-X450/HEZ TYPE)

A

B

C

D

A

B

C

D

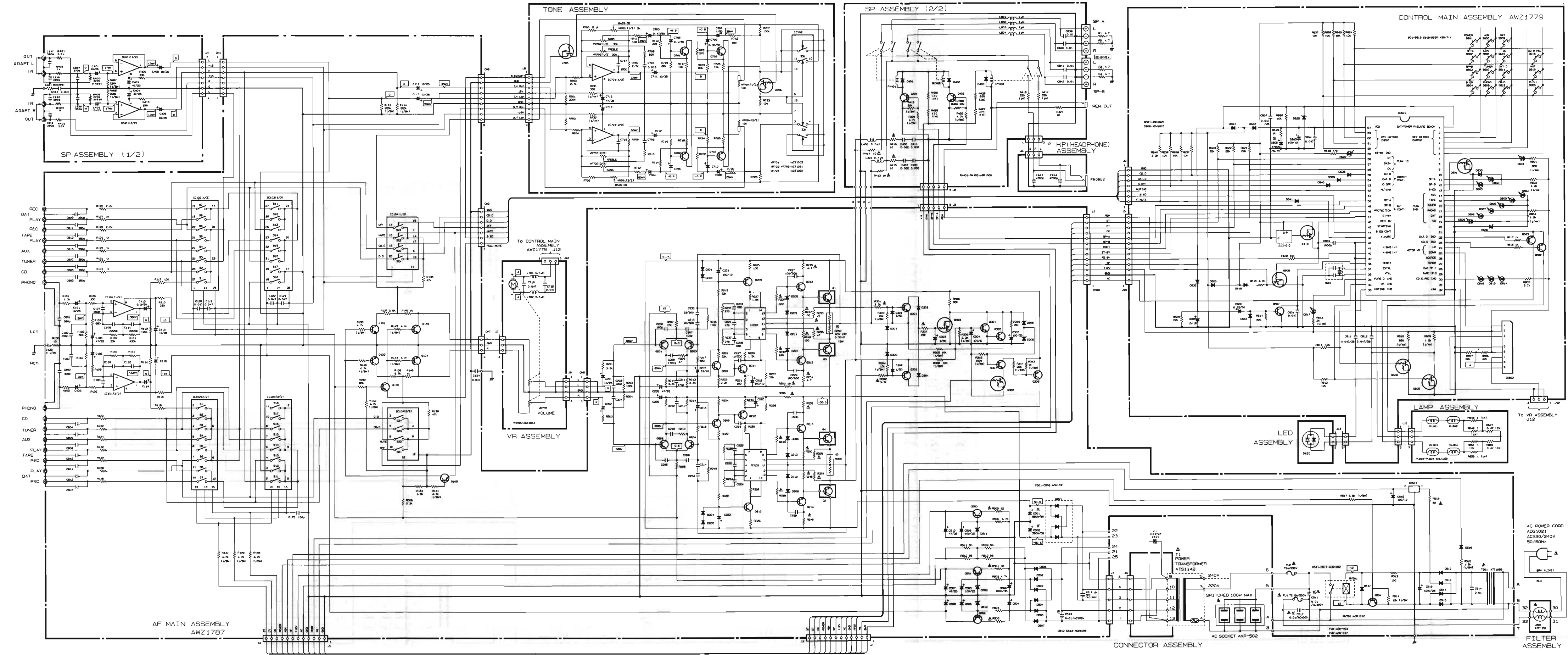

• View from soldering side

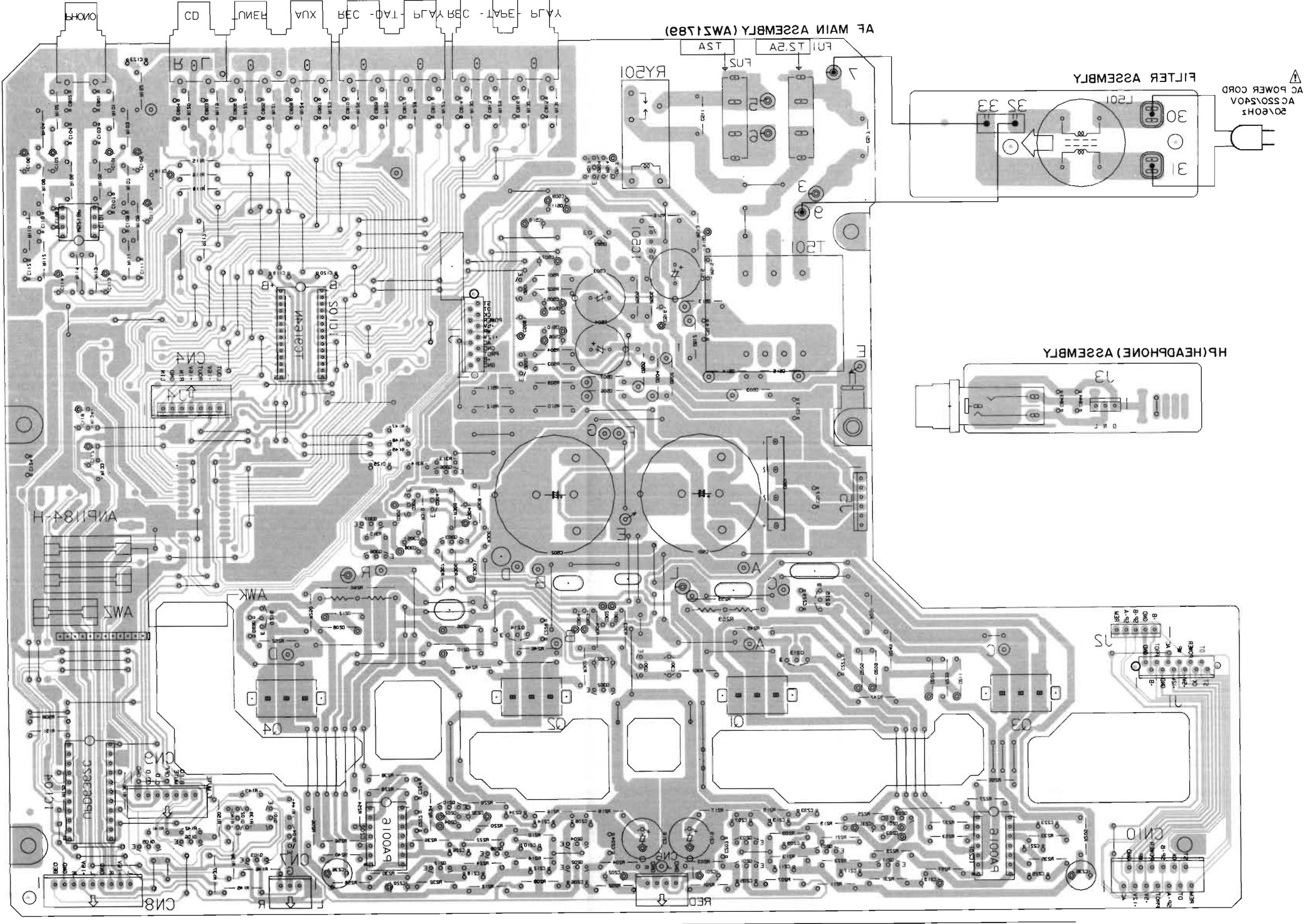
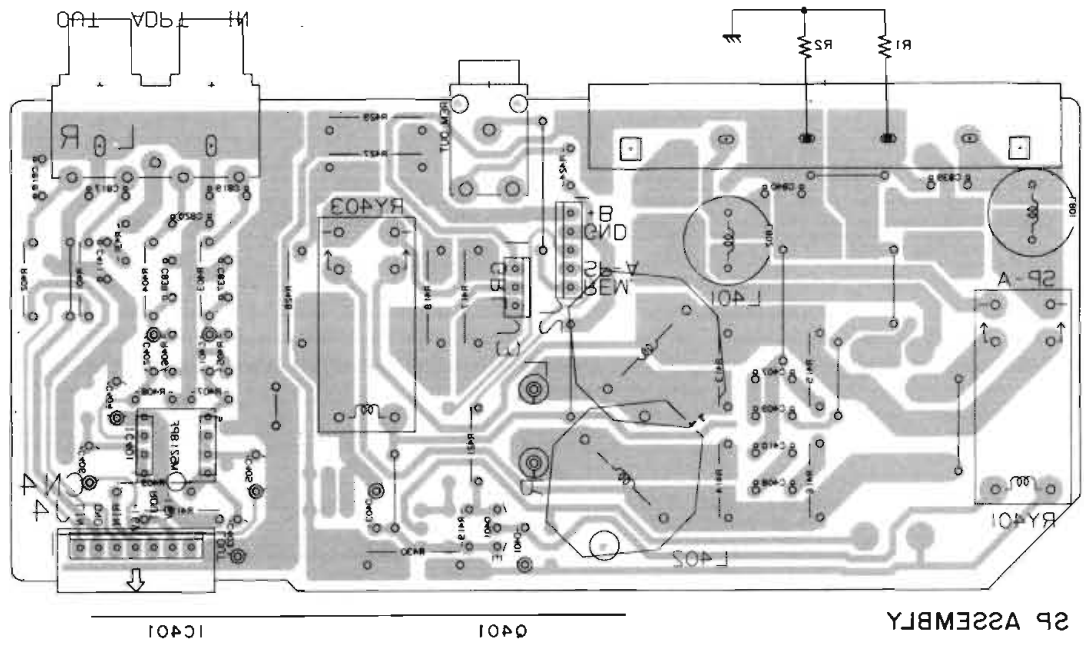

2.2 P. C. BOARD PATTERNS (FOR A-X350/HEZ TYPE)

● View from component side

NOTE

1. This P.C.B connection diagram is viewed from the parts mounted side.
2. The parts which have been mounted on the board can be replaced with those shown with the corresponding wiring symbols listed in the following Table.

P.C.B. pattern diagram indication	Corresponding part symbol	Part Name
		Transistor
		Radiator type transistor
		Diode
		Resistor
		Capacitor (Polarity)
		Capacitor (Non-polarity)

Others

P.C.B. pattern diagram indication	Part Name
IC	IC
S	Switch
RY	Relay
L	Coil
F	Filter
VR	Variable resistor or Semi-fixed resistor

3. The capacitor terminal marked with ⊙ (double circles) shows negative terminal.
4. The diode terminal marked with ⊙ (double circles) shows cathode side.
5. The transistor terminal to which E is affixed shows the emitter.

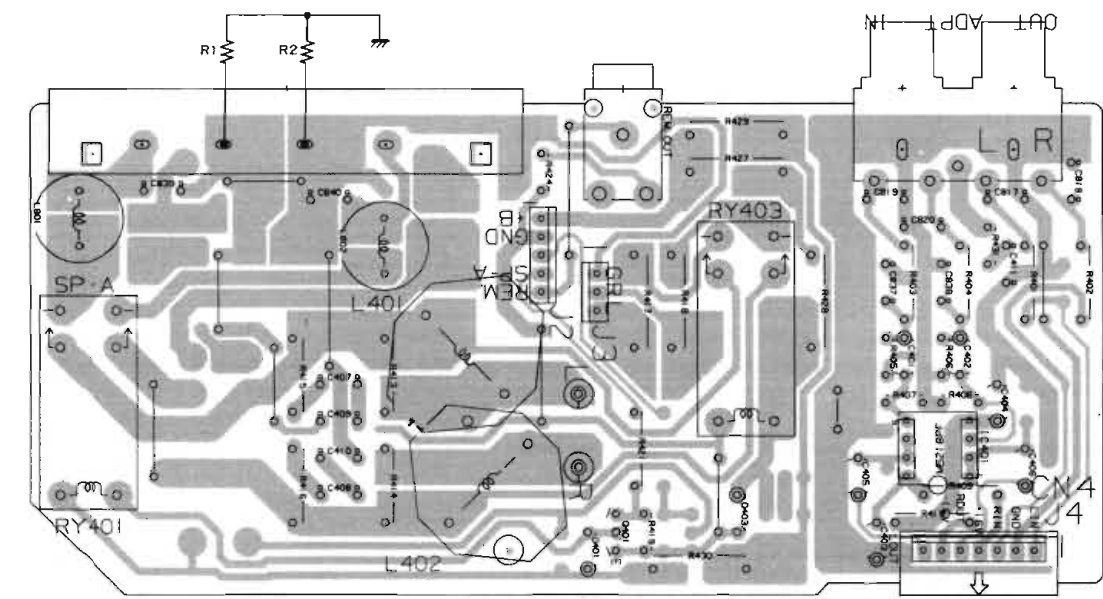
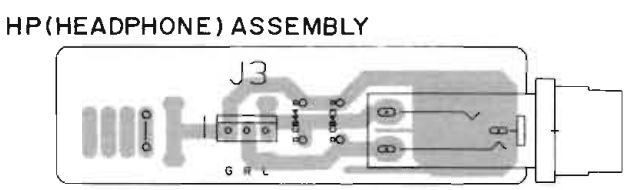
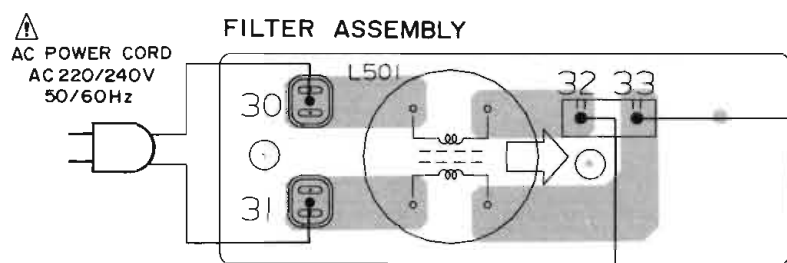
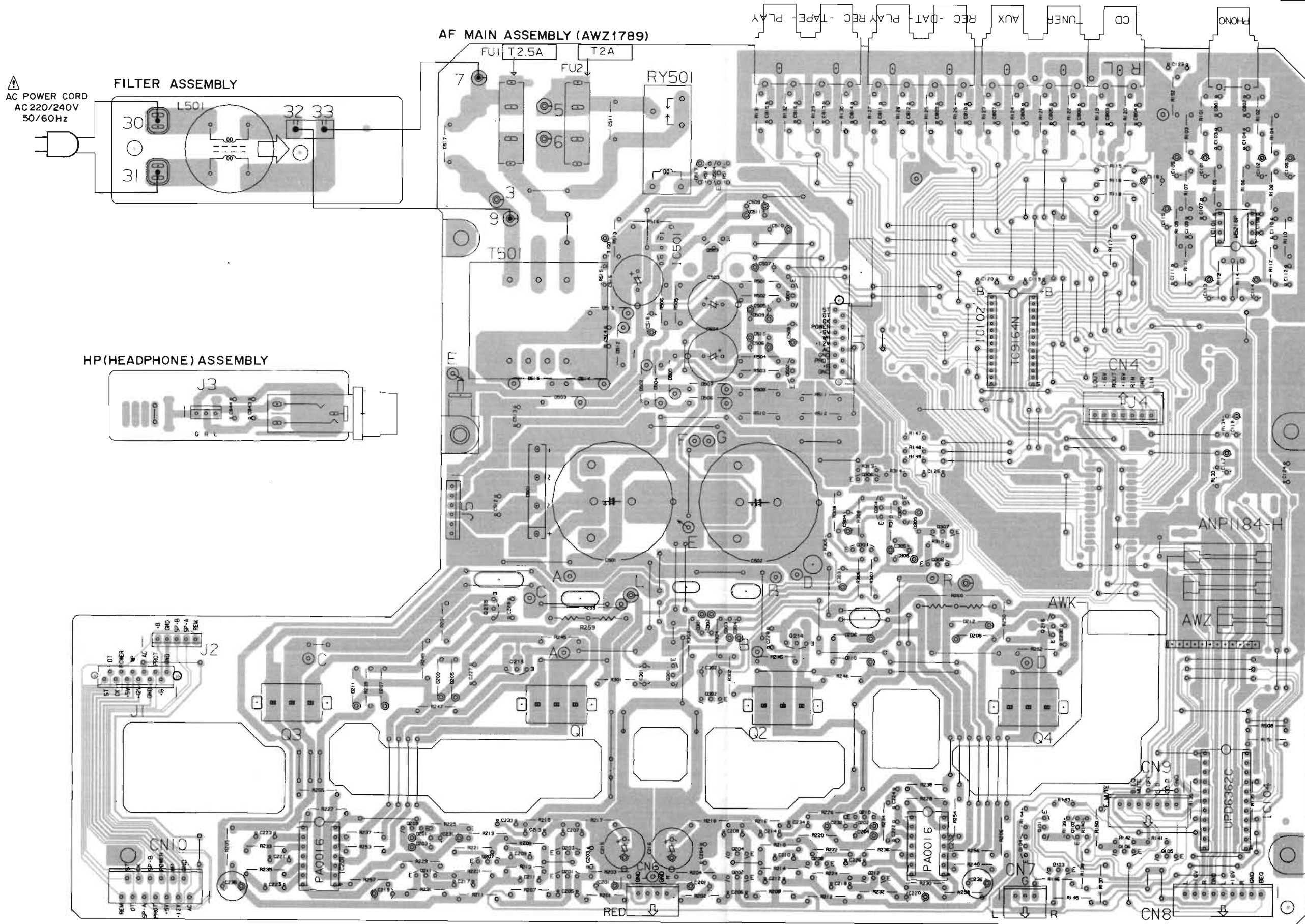

SP ASSEMBLY

Q401

IC401

- Q3 IC201
- Q209 Q211
- Q215 Q207
- Q1 Q203 Q201
- IC501 Q301
- Q504 Q503
- Q302 Q204 Q202
- Q2 Q214 Q208
- Q303 Q210 Q212
- IC102 Q216 Q4
- Q101 Q102 Q106 Q104 Q103
- Q105 IC101 IC104

2.3 CONTRAST OF MISCELLANEOUS PARTS

NOTES :

- Parts without part number cannot be supplied.
- The Δ mark found on some component parts indicates the importance of the safety factor of the part. Therefore, when replacing, be sure to use parts of identical designation.
- Parts marked by "⊙" are not always kept in stock. Their delivery time may be longer than usual or they may be unavailable.

The A-X350/HE, HB and HEZ types are the same as the A-X340/HE type with the exception of the following sections.

Mark	Symbol & Description	Part No.				Remarks
		A-X340 /HE type	A-X350 /HE type	A-X350 /HB type	A-X350 /HEZ type	
	AF main assembly	AWZ1781	AWZ1781	AWZ1781	AWZ1789	
	SP assembly	Non supply	Non supply	Non supply	Non supply	
	HP assembly	Non supply	Non supply	Non supply	Non supply	
	FILTER assembly	Non supply	
Δ	FU2 Fuse (T1.25A/250V)	AEK-018	AEK-018	AEK-018	
Δ	FU1 Fuse (T2.5A/250V)	AEK-403	AEK-403	AEK-403	
Δ	FU2 Fuse (1.25A/250V)	AEK-509	
Δ	FU1 Fuse (T2.5A/250V)	AEK-512	
Δ	AC socket (3P OUTLET)	AKP-502	AKP-502	AKP-505	AKP-502	
Δ	AC Power cord	ADG1021	ADG1021	ADG-063	ADG1021	
	C1 Capacitor	CQMA473K250	
	Function knob	AAD1383	AAD1457	AAD1457	AAD1457	
	Lamp panel	AAK1474	AAK1736	AAK1736	AAK1736	
	*1 Leg assembly	AMR1285	
	*1 Insulator assembly	AMR1459	AMR1459	AMR1459	
	*1 Screw	ABA1050	ABA1050	ABA1050	
	Screw	ABA-115	
	Screw	VBZ30P080FZK	
	Front panel	ANB1228	ANB1268	ANB1268	ANB1268	
	Pad	AHA1069	AHA1202	AHA1202	AHA1202	
	Packing case	AHD1416	AHD1650	AHD1650	AHD1650	
	Operating instructions (English/French/German/Italian/ Dutch/Swedish/Spanish/Portuguese)	ARE1082	ARE1129	
	Operating instructions (English)	ARB1182	
	Operating instructions (German)	ARC1159	

*1: In A-X350, the insulator assembly is attached instead of the leg assembly in A-X340.

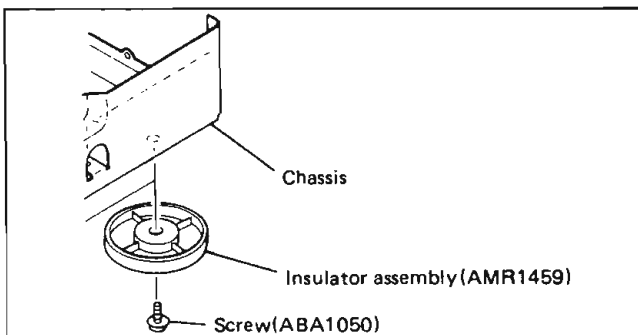

AF MAIN ASSEMBLY

The AF main assembly (AWZ1789) is the same as the AF main assembly (AWZ1781) with the exception of the following sections.

Mark	Symbol & Description	Part No.		Remarks
		AWZ1781	AWZ1789	
	C103, C104 C107, C108 C801-C816 R101, R102 R119-R124, R127, R128, R131, R132 R201, R202	CKMYB221K50 CKMYB221K50 RD¼PM331J RD¼PM471J RD¼PM332J	CKDYB331K50 CKCYB391K50 CKDYB391K50 RD¼PM152J RD¼PM102J RDR¼PM332J	

SP ASSEMBLY

The SP assembly (for A-X350/HEZ type) is the same as the SP assembly (for A-X340/HE, A-X350/HE and HB types) with the exception of the following sections.

Mark	Symbol & Description	Part No.		Remarks
		A-X340/HE, A-X350/HE and HB types	A-X350/HEZ type	
	C817-C820 C837, C838 C839, C840 L801, L802 AF choke coil R1, R2 R403, R404	CKDYB391K50 CKDYB331K50 CQMA103K50 ATH-059 RD¼PM4R7J RD¼PM102J	

HP ASSEMBLY

The HP assembly (for A-X350/HEZ type) is the same as the HP assembly (for A-X340/HE, A-X350/HE and HB types) with the exception of the following sections.

Mark	Symbol & Description	Part No.		Remarks
		A-X340/HE, A-X350/HE and HB types	A-X350/HEZ type	
	C843, C844	CQMA472K50	

● ELECTRICAL PARTS LIST

FILTER assembly

FILTER

Mark	Symbol & Description	Part No.
△	L501 Line filter	ATF-151

Line voltage selection

Line voltage can be changed with following steps.

1. Disconnect the AC power cord.
2. Remove the Bonnet case.
3. Change the connection wire (To power transformer) of Terminal No. 3 or No. 5 (White) as follows.

Voltage	Terminal No. 3	Terminal No. 5
220V	White
240V	White

4. Stick the line voltage label on the rear panel.

Part No.	Description
AAX-193	220V label
AAX-192	240V label