

# Service Manual

**PIONEER**  
The future of sound and vision.

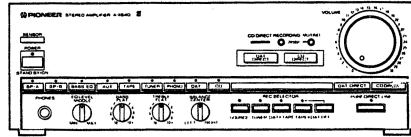

**ORDER NO.  
ARP1577**

**STEREO AMPLIFIER**

# A-X540

## A-X440

## A-X340

**MODELS A-X540, A-X440 AND A-X340 HAVE FOUR VERSIONS:**

Type	Applicable model			Power requirement	Export destination
	A-X540	A-X440	A-X340		
HE	○	○	○	AC220V,240V (switchable)	European continent
HB	○	○	○	AC220V,240V (switchable)	United Kingdom
HEZ	○	○	○	AC220V,240V (switchable)	West Germany
SD	○	○	—	AC110V,120V-127V,220V,240V (switchable)	Kingdom of Saudi Arabia and general market

- This service manual is applicable to the HE and HB types.
- For the HB type, refer to page 48.
- For the other types, refer to additional service manual.

## CONTENTS

1. PACKING .....	2	5. FOR HB TYPE .....	48
2. EXPLODED VIEWS AND PARTS LIST .....	3	6. IC INFORMATION .....	50
3. SCHEMATIC DIAGRAM AND P.C.BOARDS CONNECTION DIAGRAM .....	7	7. SPECIFICATION .....	53
4. ELECTRICAL PARTS LIST .....	40		

**PIONEER ELECTRONIC CORPORATION** 4-1, Meguro 1-Chome, Meguro-ku, Tokyo 153, Japan  
**PIONEER ELECTRONICS SERVICE INC.** P.O. Box 1760, Long Beach, California 90801 U.S.A.  
**PIONEER ELECTRONICS OF CANADA, INC.** 505 Cochrane Drive, Markham, Ontario L3R 8E3 Canada  
**PIONEER ELECTRONIC [EUROPE] N.V.** Keetberglaan 1, 2740 Beveren, Belgium  
**PIONEER ELECTRONICS AUSTRALIA PTY. LTD.** 178-184 Boundary Road, Braeside, Victoria 3195, Australia TEL: [03] 580-9911

YA © MAY. 1988 Printed in Japan

# 1. PACKING

Mark	No.	Parts No.	Description
	1	AHA1069	Pad
	2	AHD1414	Packing case
		AHD1415	Packing case (A-X440)
		AHD1416	Packing case (A-X340)
	3	ARE1080	Operating instruction
		ARE1081	Operating instruction (A-X440)
		ARE1082	Operating instruction (A-X340)
	4	AXD1053	Remote control unit
		AXD1052	Remote control unit (A-X340)
101			Batteries AAAA
102			Sheet
103			Bag

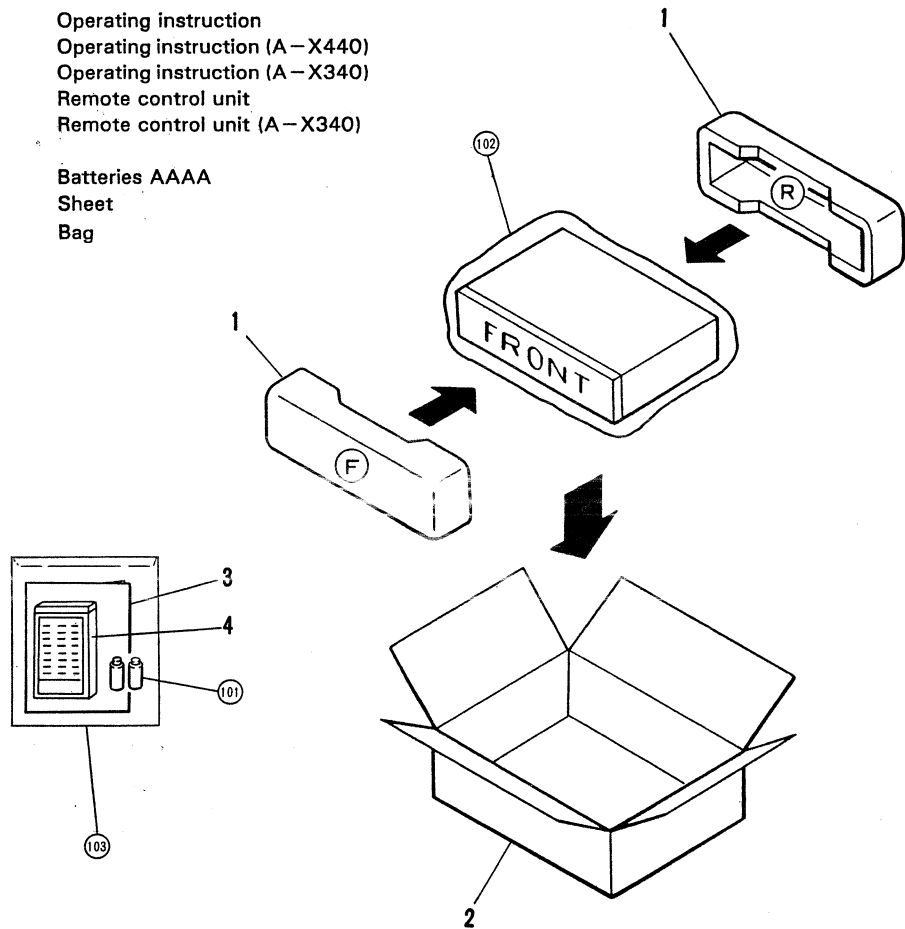

# 2. EXPLODED VIEWS AND PARTS LIST

The configuration of A-440 and A-X340 is different.

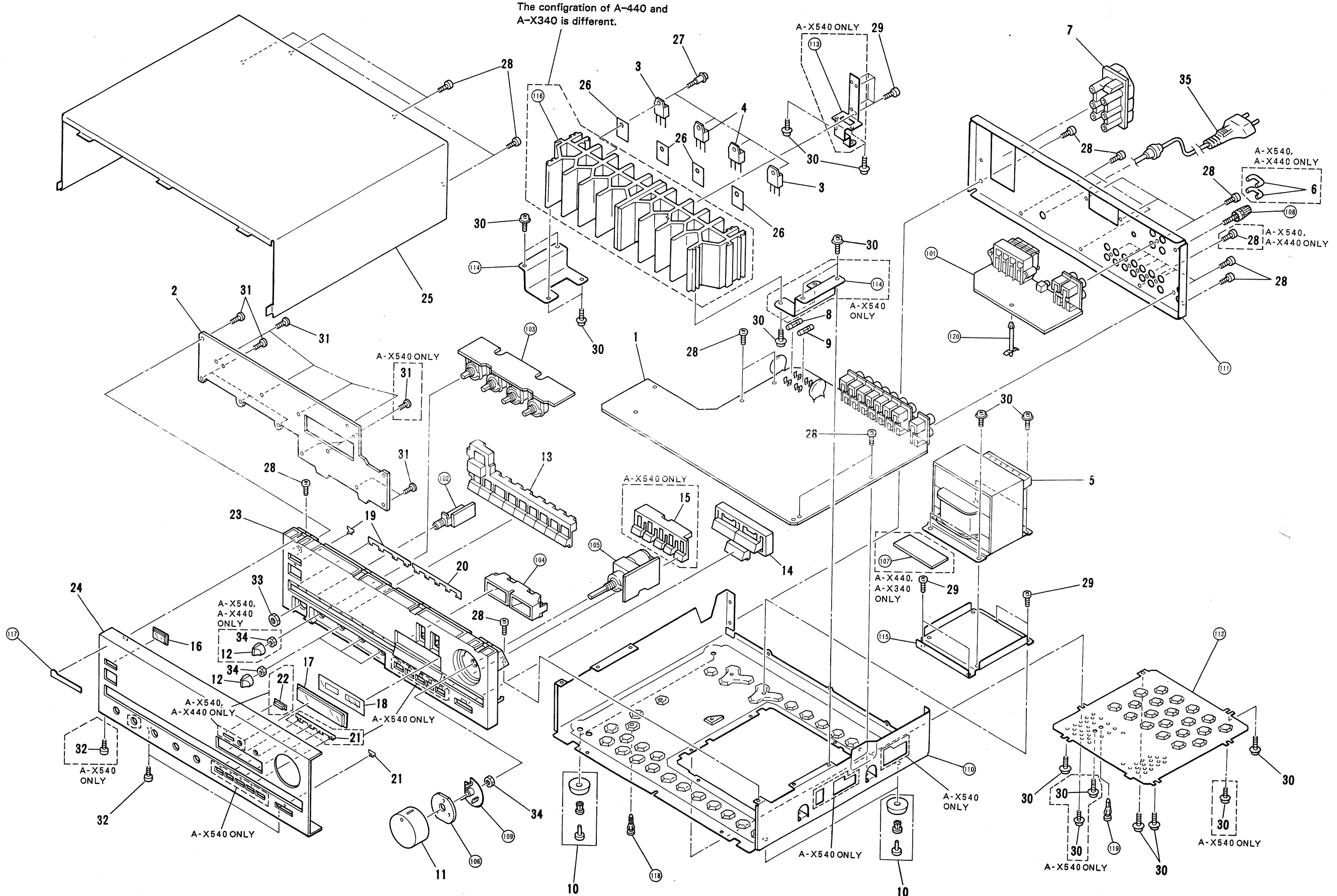

**NOTES:**  
 • Parts with  $\Delta$   
 • The  $\Delta$  mu factor of tu tion.  
 • For your p and \*.  
 • \*\* GEN  
 • This class number, te  
 • Parts mari than usua

**Parts List**

Mark	No.
	1
	2
**	
**	
$\Delta$ *	
$\Delta$ ***	7
$\Delta$ ***	8
$\Delta$ ***	9
	10
	11
	12
	13

**NOTES:**

- Parts without part number cannot be supplied.
- The  $\Delta$  mark found on some component parts indicates the importance of the safety factor of the part. Therefore, when replacing, be sure to use parts of identical designation.
- For your parts Stock Control, the fast moving items are indicated with the marks  $\star\star$  and  $\star$ .
- $\star\star$  **GENERALLY MOVES FASTER THAN  $\star$**   
This classification shall be adjusted by each distributor because it depends on model number, temperature, humidity, etc.
- Parts marked by "●" are not always kept in stock. Their delivery time may be longer than usual or they may be unavailable.

**Parts List**

Mark	No.	Parts No.	Description	Mark	No.	Parts No.	Description
	1	AWZ1770	AF main assembly		14	AAD1384	Direct knob (DAT DIRECT, CD DIRECT, PURE DIRECT LINE)
		AWZ1777	AF main assembly (A-X440)			AAD1385	Direct knob (A-X340)
		AWZ1781	AF main assembly (A-X340)		15	AAD1386	REC SELECTOR knob (SOURCE, TUNER, DAT ▶ TAPE, TAPE ▶ DAT, OFF)
	2	AWZ1772	Control main assembly		16	AAK1333	Sencer acrylic lens
		AWZ1779	Control main assembly (A-X440)		17	AAK1473	Lamp panel
		AWZ1782	Control main assembly (A-X340)			AAK1474	Lamp panel (A-X340)
$\star\star$	3	2SA1302	Transistor (Q3,Q4)		18	AAK1475	Display seat
		2SA1264N	Transistor (Q3,Q4) (A-X440)			AAK1476	Display seat (A-X340)
		2SA1263N	Transistor (Q3,Q4) (A-X340)		19	AAK1482	Indicator lens L
$\star\star$	4	2SC3281	Transistor (Q1,Q2)			AAK1483	Indicator lens L (A-X340)
		2SC3181N	Transistor (Q1,Q2) (A-X440)		20	AAK1484	Indicator lens R
		2SC3180N	Transistor (Q1,Q2) (A-X340)		21	AAK1485	Indicator lens A
$\Delta$ $\star$	5	ATS1141	Power transformer (220V/240V,T1)			AAK1486	Indicator lens A (A-X440, A-X340)
		ATS1142	Power transformer (220V/240V,T1) (A-X440)		22	AAK1487	DILECT REC lens
		ATS1143	Power transformer (220V/240V,T1) (A-X340)		23	AMB1397	Panel base
	6	AKM1019	Jumper plug			AMB1398	Panel base (A-X440)
		AKM1004	Jumper plug (A-X440, A-X340)			AMB1399	Panel base (A-X340)
$\Delta$	7	AKP-502	AC socket (3P,AC OUTLET)		24	ANB1226	Front panel
$\Delta$ $\star\star$	8	AEK-403	Fuse (T2.5A/250V,FU1)			ANB1227	Front panel (A-X440)
$\Delta$ $\star\star$	9	AEK-403	Fuse (T2.5A/250V,FU2)			ANB1228	Front panel (A-X340)
		AEK-017	Fuse (T2A/250V, FU2) (A-X440)		25	AZN1802	Bonnet cover
		AEK-018	Fuse (T1.25A/250V, FU2) (A-X340)			AZN1748	Bonnet cover (A-X440, A-X340)
	10	AMR1285	Leg assembly		26	AEE1014	Mica sheet
						AEC-818	Mica sheet (A-X440, A-X340)
	11	AAB1044	Rotary knob (VOLUME)		27	ABA-297	Screw
		AAB1081	Rotary knob (VOLUME) (A-X440)		28	ABA-298	Screw
		AAB1082	Rotary knob (VOLUME) (A-X340)		29	ABA1009	Screw
					30	ABA1011	Screw
	12	AAB1070	Rotary knob (BASS EQ LEVEL, BASS, TREBLE, BALANCE)		31	BBZ26P080FMC	Screw
					32	BBZ30P080FZK	Screw
	13	AAD1382	Function knob (STAND-BY/ON, SP-A, SP-B, BASS EQ, AUX, TAPE, TUNER, PHONO, DAT, CD)	$\Delta$	33	ABN-065	Nut
		AAD1383	Function knob (A-X340)		34	NK90FUC	Nut
					35	ADG1021	AC power cord

Mark	No.	Parts No.	Description
	101		SP assembly
	102		HEADPHONE assembly
	103		TONE assembly
	104		LAMP assembly
	105		VR assembly
	106		LED assembly
	107		CONNECTOR assembly
	108		Terminal (GND)
	109		VOL PCB holder
	110		Chassis
	111		Rear panel
	112		Bottom plate
	113		Heat sink holder A
	114		Heat sink holder B
	115		Trans holder
	116		Heat sink
	117		Name plate
	118		Spacer
	119		PCB spacer
	120		PCB spacer

**Line voltage selection (HE, HB TYPES)**

Line voltage can be changed with following steps.

1. Descomment the AC power cord.
2. Remove the top cover.
3. Change the connection wire (To Power transformer) of Terminal No. 3 ( White ) as follows.

Voltage	Terminal No. 3	Terminal No. 5
220V	White	.....
240V	.....	White

4. Stick the voltage level on the rear panel.

Part No.	Description
AAX-193	220V level
AAX-192	240V level



# 3. SCHEMATIC DIAGRAM AND P.C.BOARDS CONNECTION DIAGRAM

## 3.1 A-X540

A

B

C

D

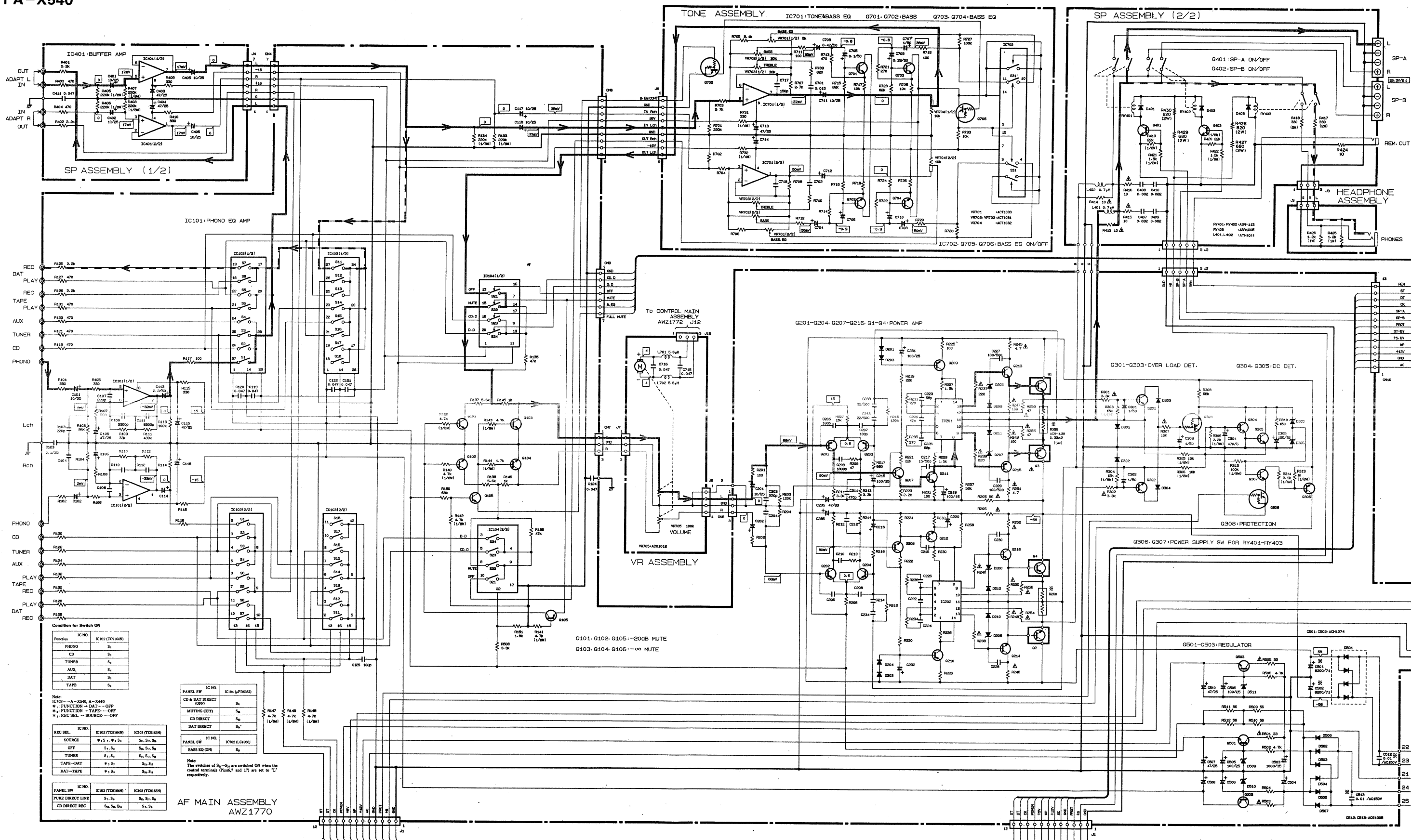



1

2

3

4

5

6

Q610 Q608 Q614 Q613  
Q611 Q609  
Q601

IC601

Q607 Q612  
IC602 Q602 Q603

Q606 Q605

AC POW  
AC 220  
240  
50/60Hz

A

LED ASSEMBLY

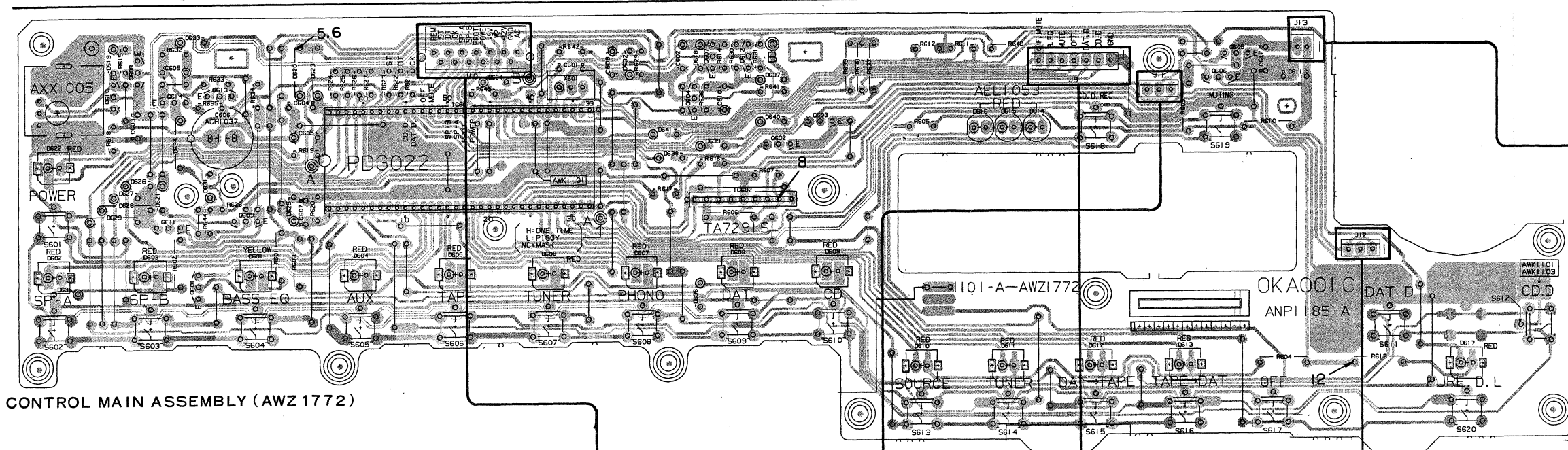

B

AC SOCKET

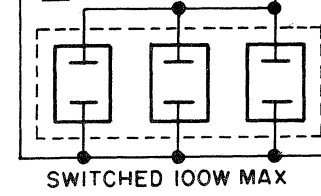

HEADPHONE ASSEMBLY

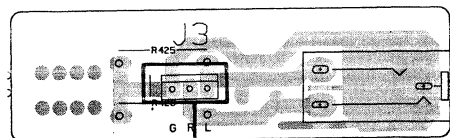

LAMP ASSEMBLY

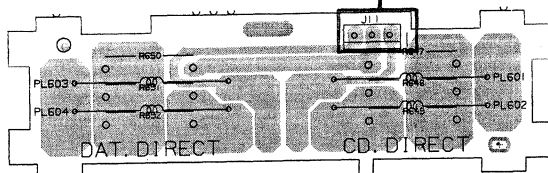

VR ASSEMBLY

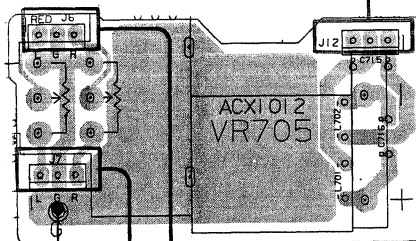

C

SP ASSEMBLY

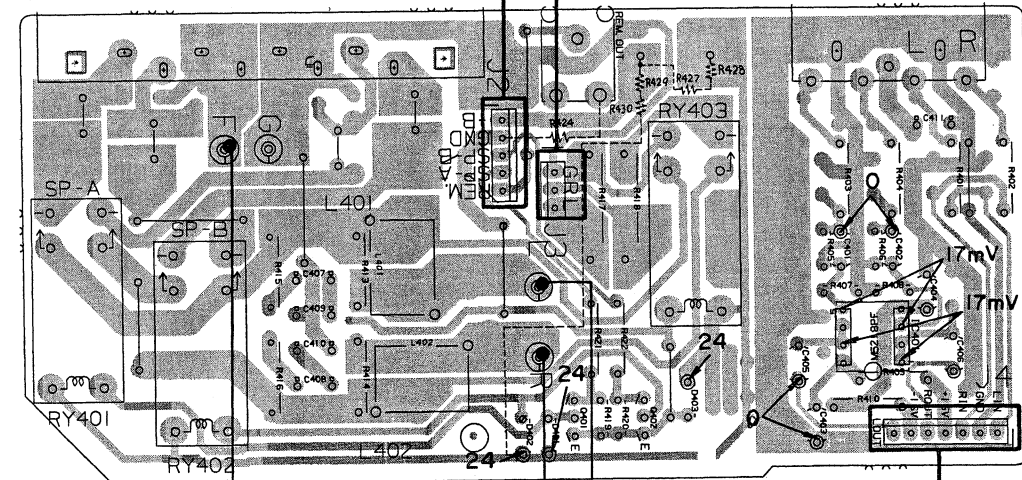

D

TONE ASSEMBLY

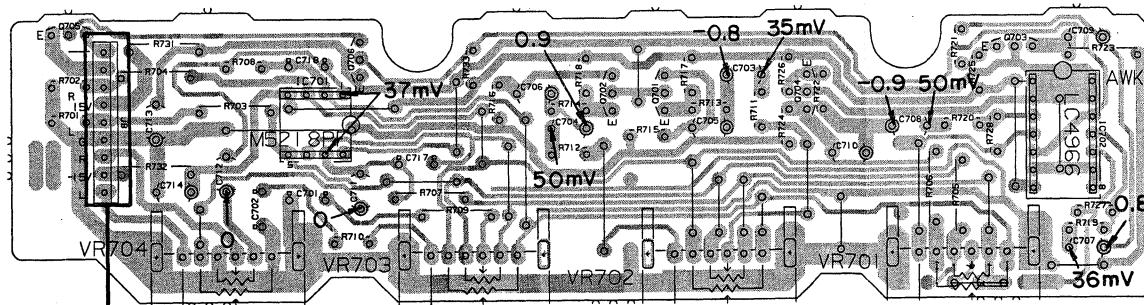

1

2

3

4

5

6

AF



IC201 Q209 Q211 Q215 Q213 Q207 Q203 Q201 IC501 Q501-Q504 Q301 Q302 Q214 Q216 Q208 Q202 Q204 Q210 Q212 IC202 IC102 Q101-Q106 IC103 IC101 IC104

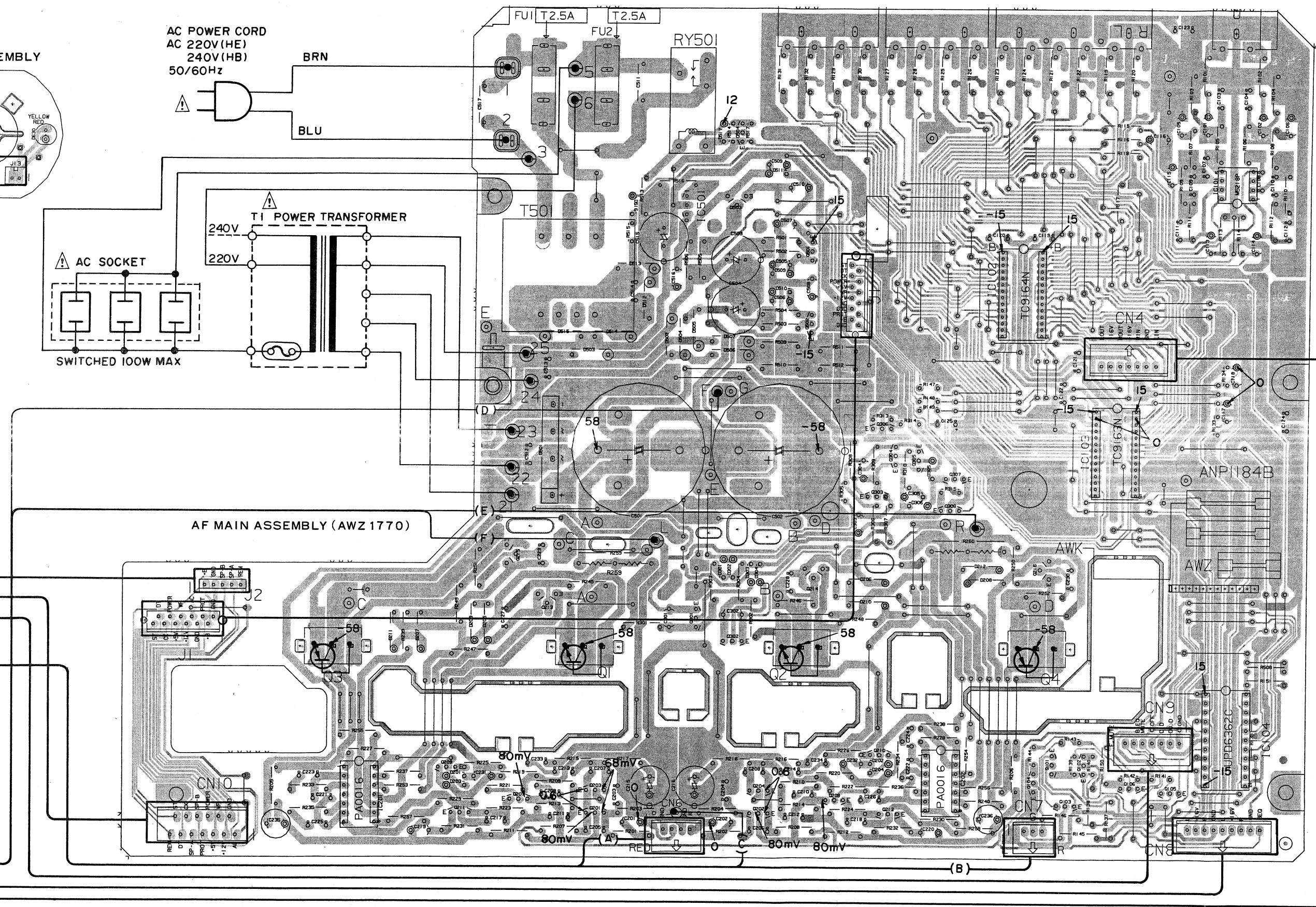
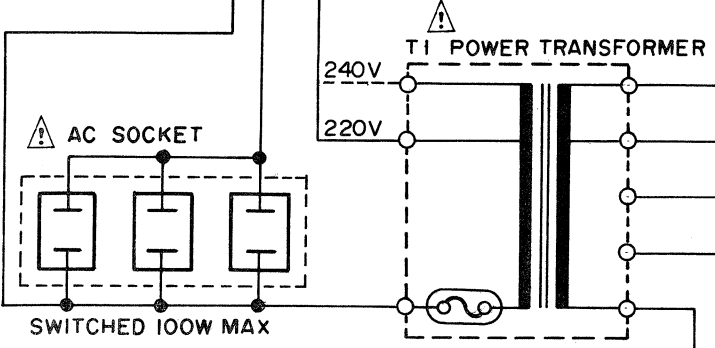
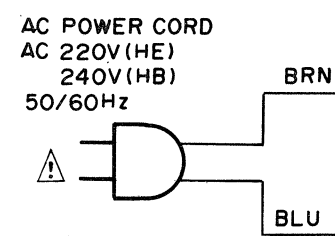
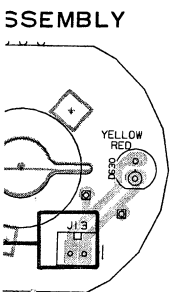

NOTE

- This P.C.B. connection diagram is viewed from the parts mounted side.
- The parts which have been mounted on the board can be replaced with those shown with the corresponding writing symbols listed in the following Table.

P.C.B. pattern diagram indication	Corresponding part symbol	Part Name
		Transistor
		Radiator type transistor
		Diode
		Resistor
		Capacitor (Polarity)
		Capacitor (Non-polarity)

Others

P.C.B. pattern diagram indication	Part Name
IC	IC
S	Switch
RY	Relay
L	Coil
F	Filter
VR	Variable resistor or Semi-fixed resistor

- The capacitor terminal marked with @ (double circles) shows negative terminal.
- The diode terminal marked with @ (double circles) shows cathode side.
- The transistor terminal to which E is affixed shows the emitter.

A

B

C

D



A

B

C

D

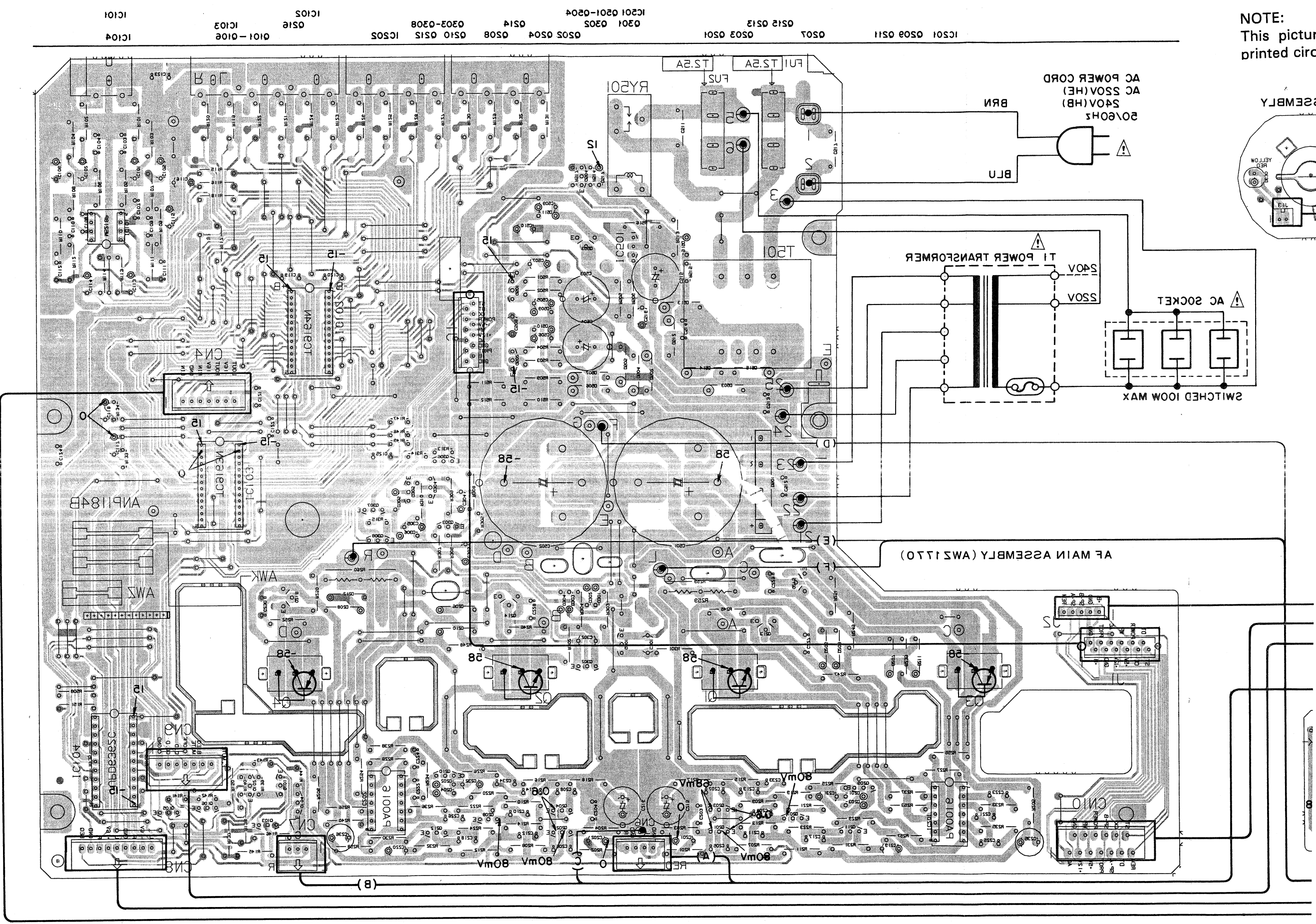

NOTE:  
This picture  
printed circi

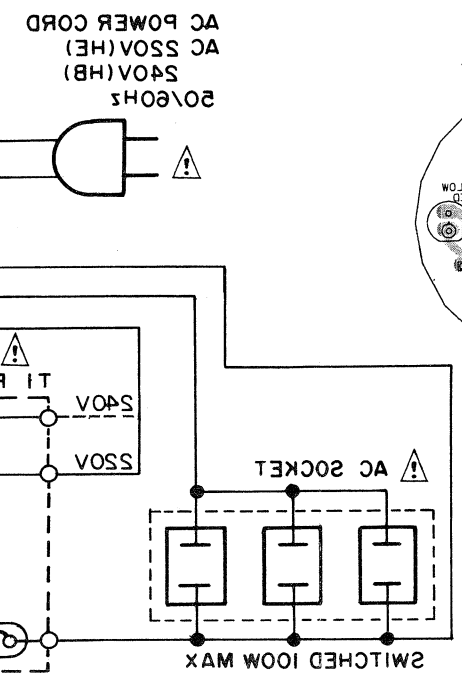
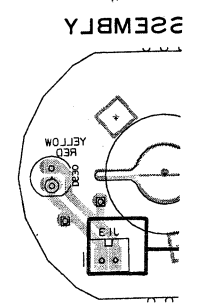

AF MAIN ASSEMBLY (AW3170)

NOTE:  
This picture shows the foil side of the  
printed circuit.

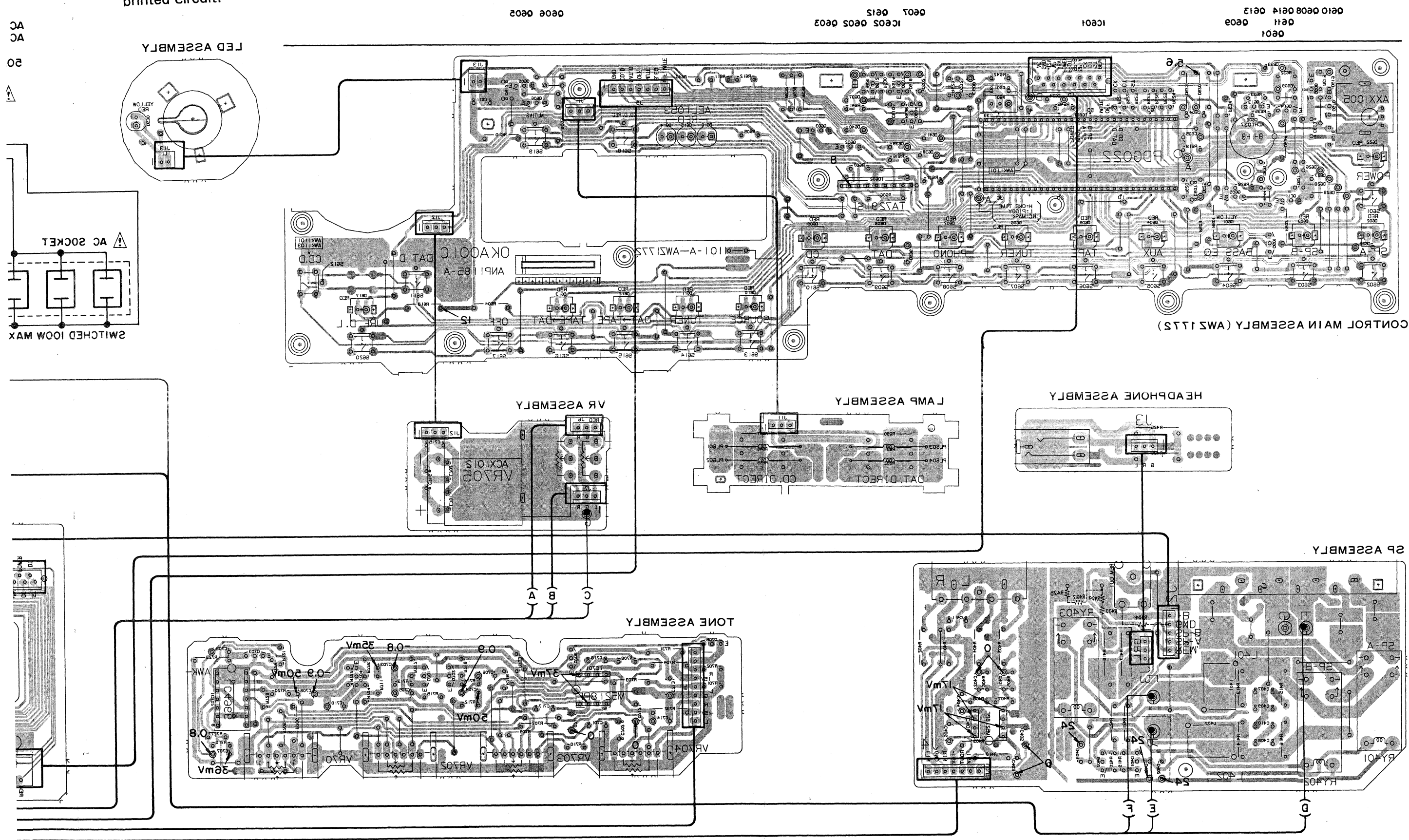

A  
B  
C  
D

1  
2  
3  
4  
5

1  
2  
3  
4  
5

AC  
AC  
20

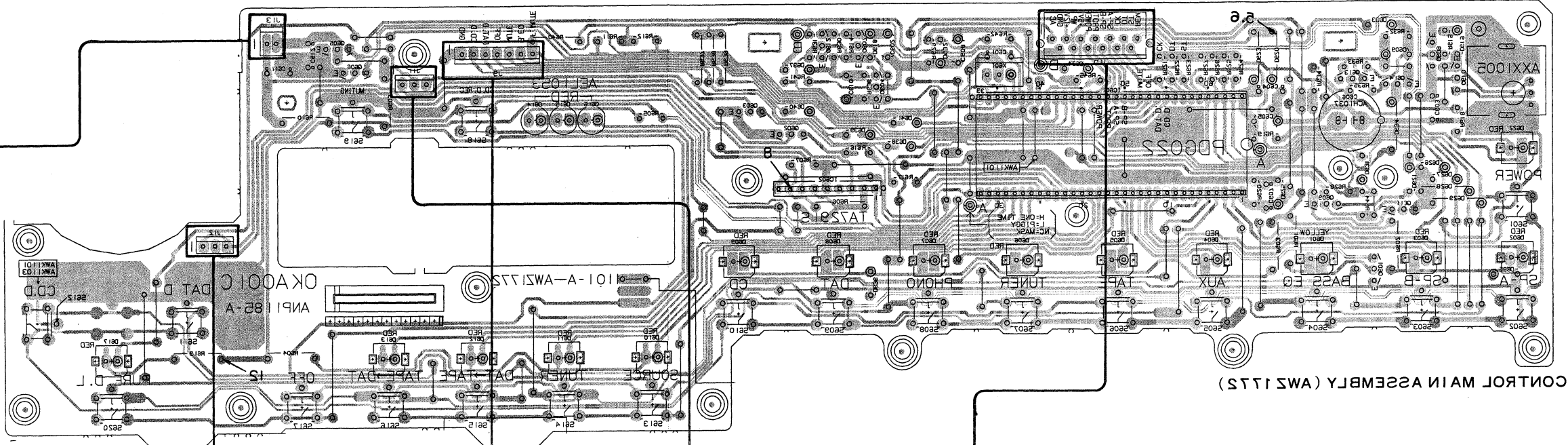
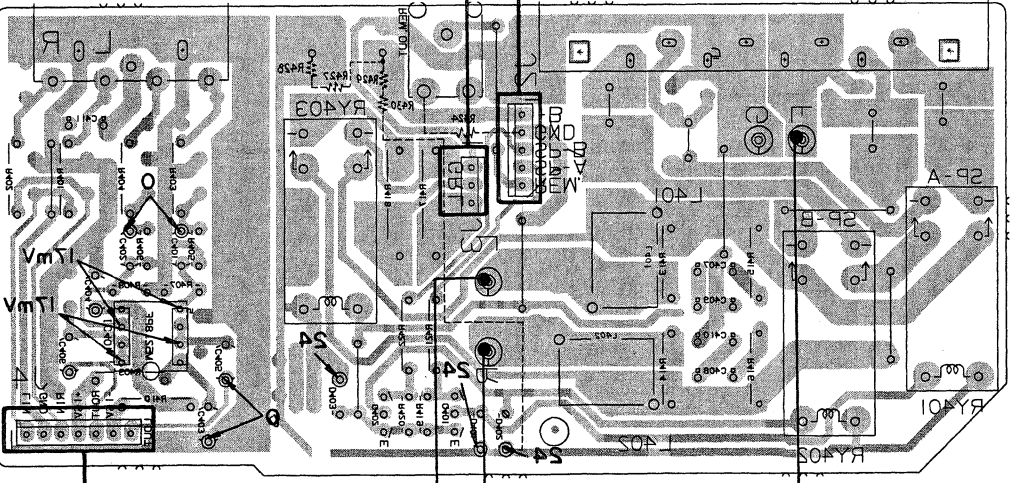
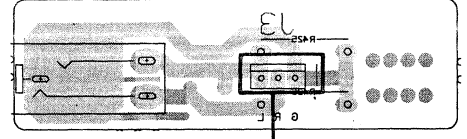
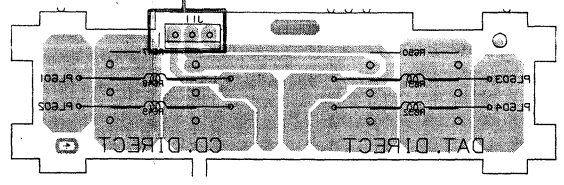
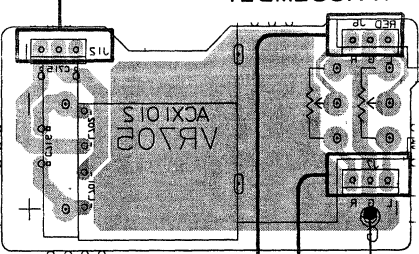
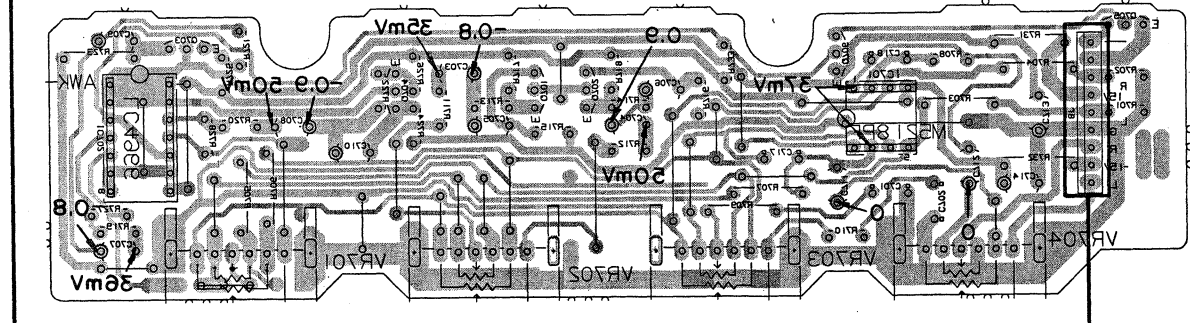
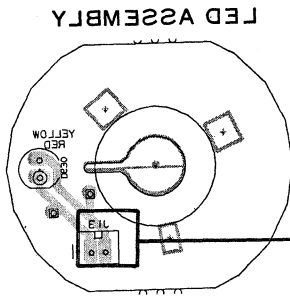
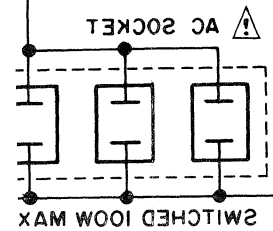







A

B

C

D

12

1

2

3

4

5

6

0E10 0E08

0E01

IC901

IC905 0E05 0E03

0E0E 0E02

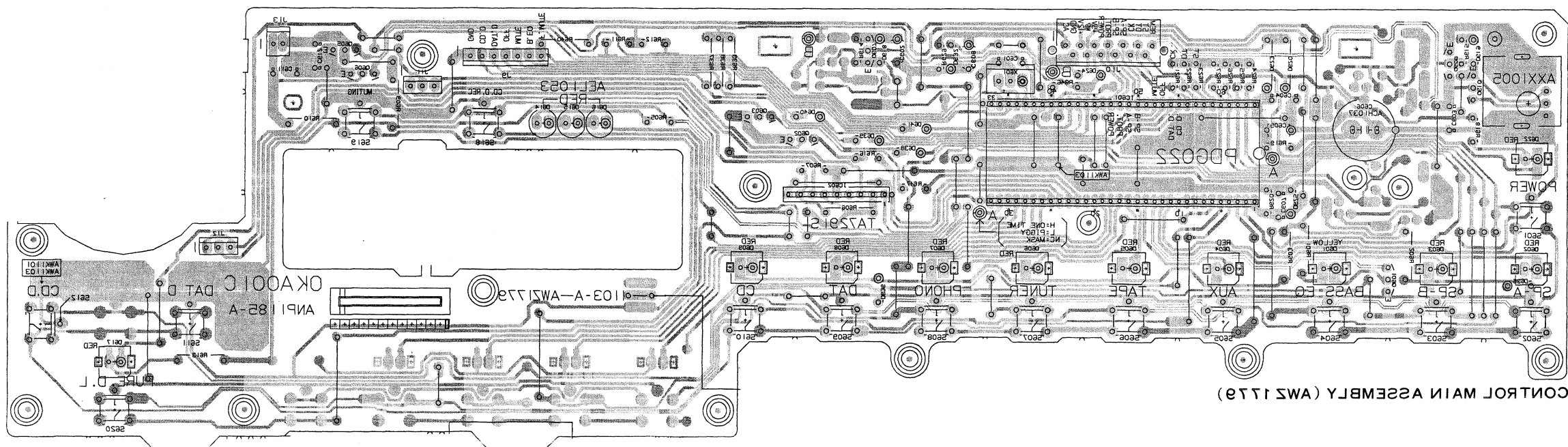

CONTROL MAIN ASSEMBLY (AW3 123)

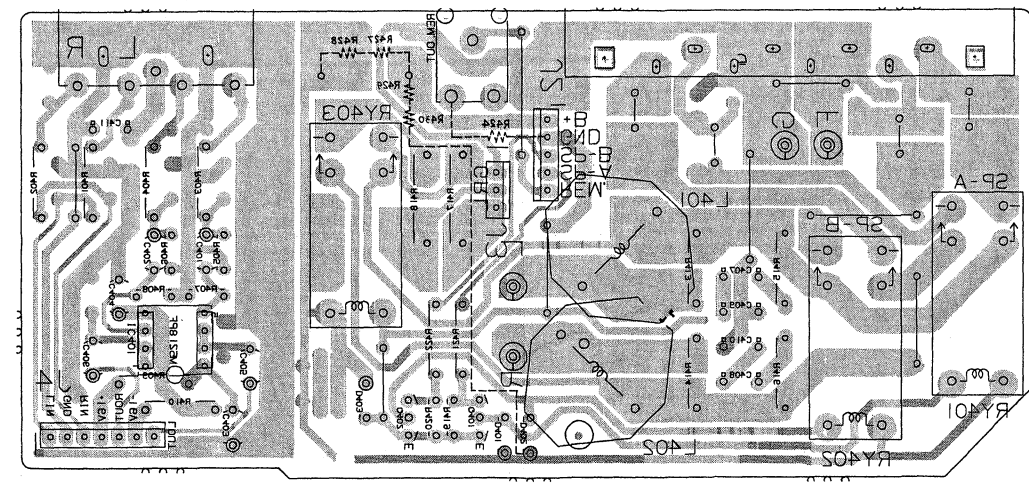

SP ASSEMBLY

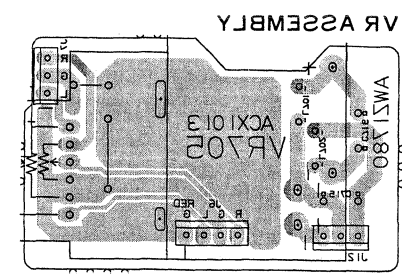

VR ASSEMBLY

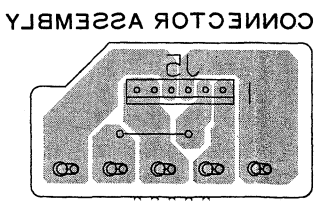

CONNECTOR ASSEMBLY

NOTE:  
This picture shows the foil side of the printed circuit.

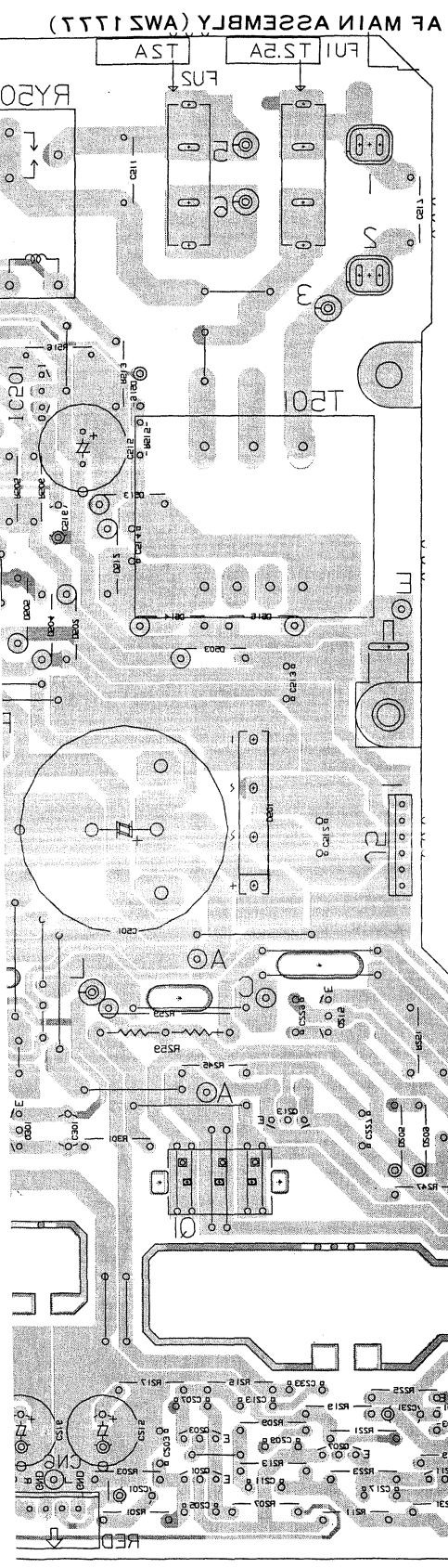

AF MAIN ASSEMBLY (AW3 123)

IC501 0508 0511 0501 0503 0501 0512 0513

1

2

3

4

5

6

12



3.2 A-X440

AF MAIN ASSEMBLY (AWZ 1777)

A

Q610 Q608

IC601

Q607

IC602 Q602 Q603

Q606 Q605

Q601

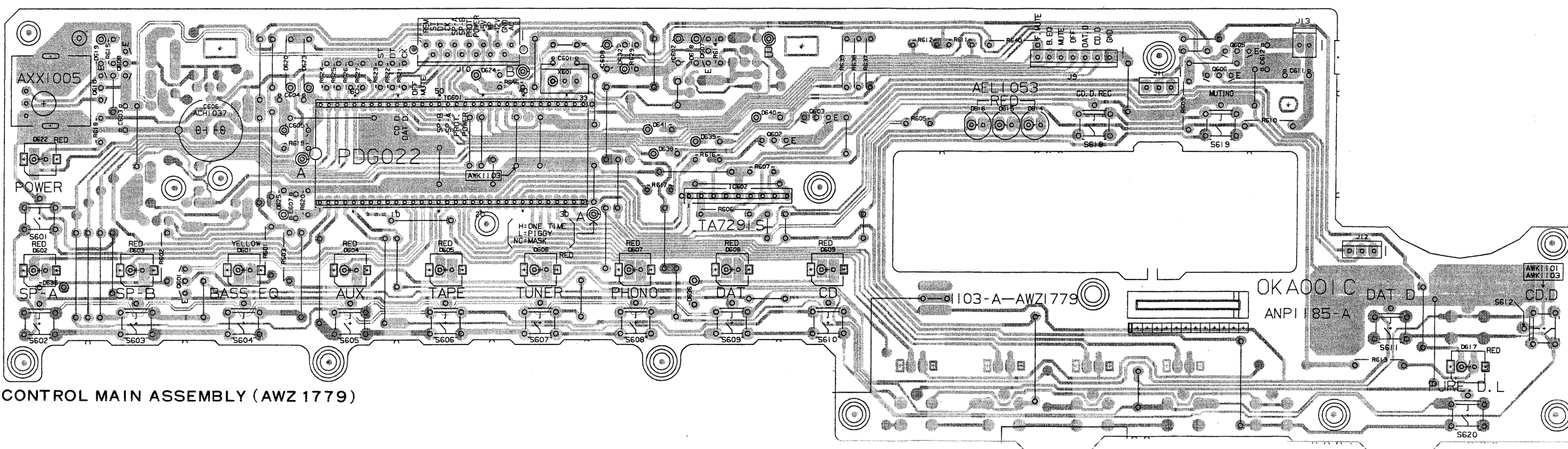

CONTROL MAIN ASSEMBLY (AWZ 1779)

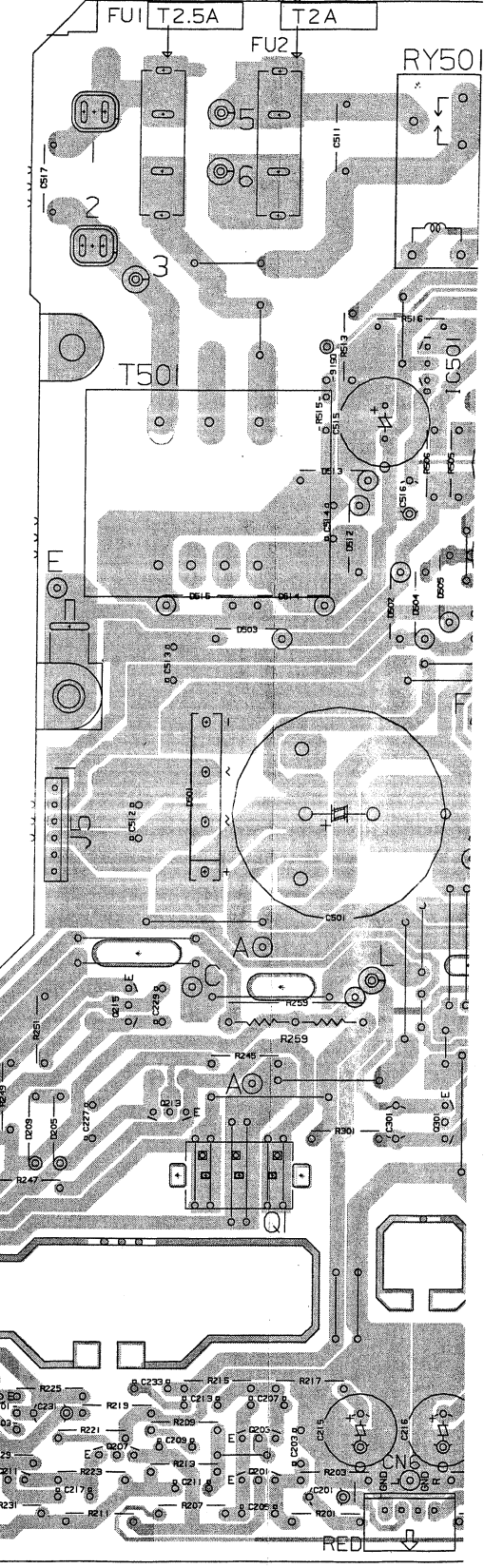

B

C

D

SP ASSEMBLY

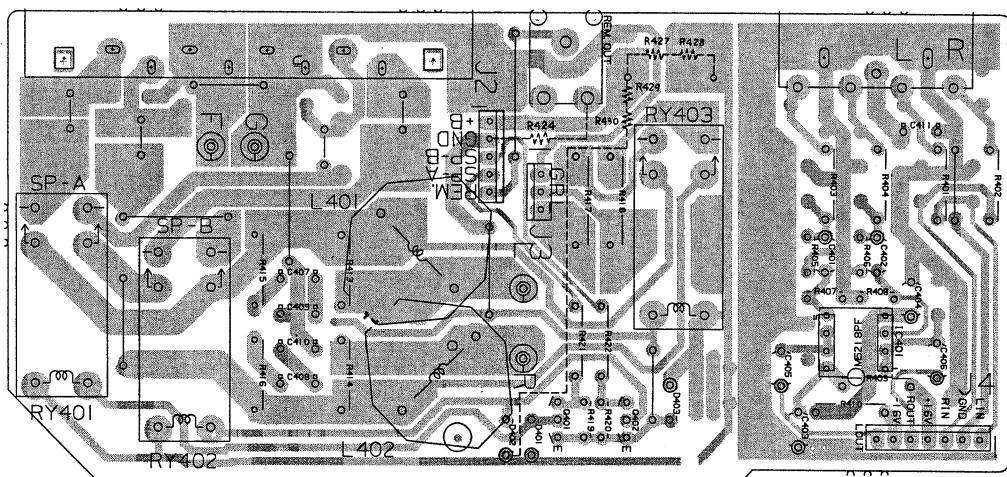

VR ASSEMBLY

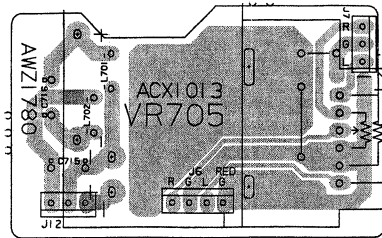

CONNECTOR ASSEMBLY

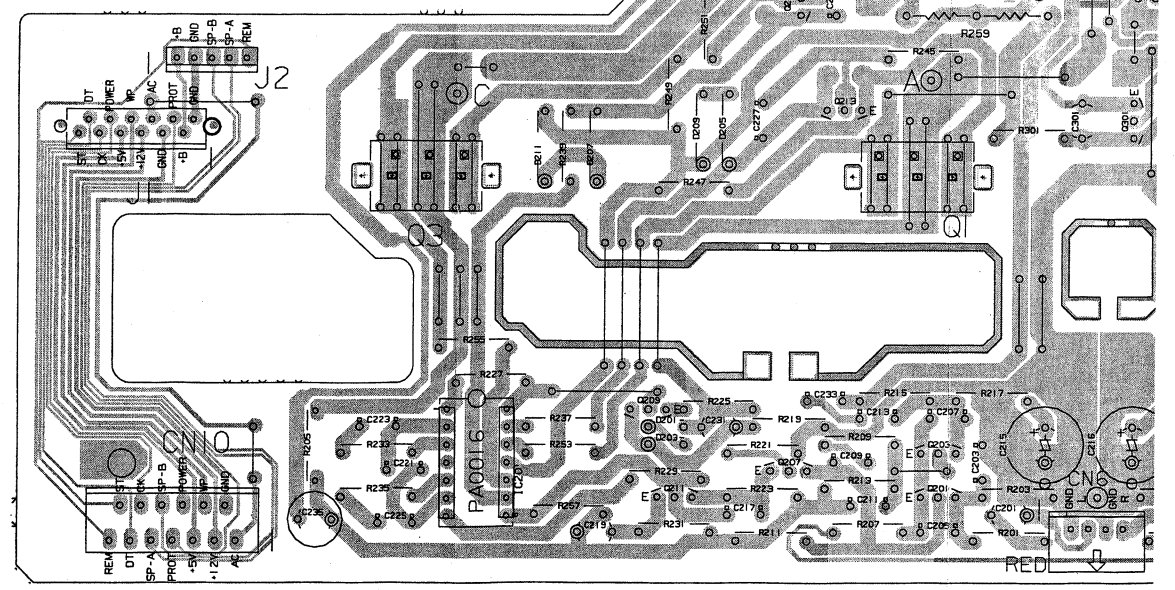
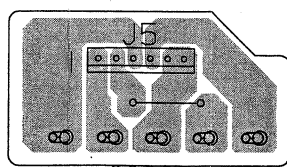

IC201 Q209 Q211 Q207 Q215 Q213 Q203 Q201

IC501 Q301



4

5

6

7

8

9

A

B

C

D

### AF MAIN ASSEMBLY (AWZ 1777)

0606 0605

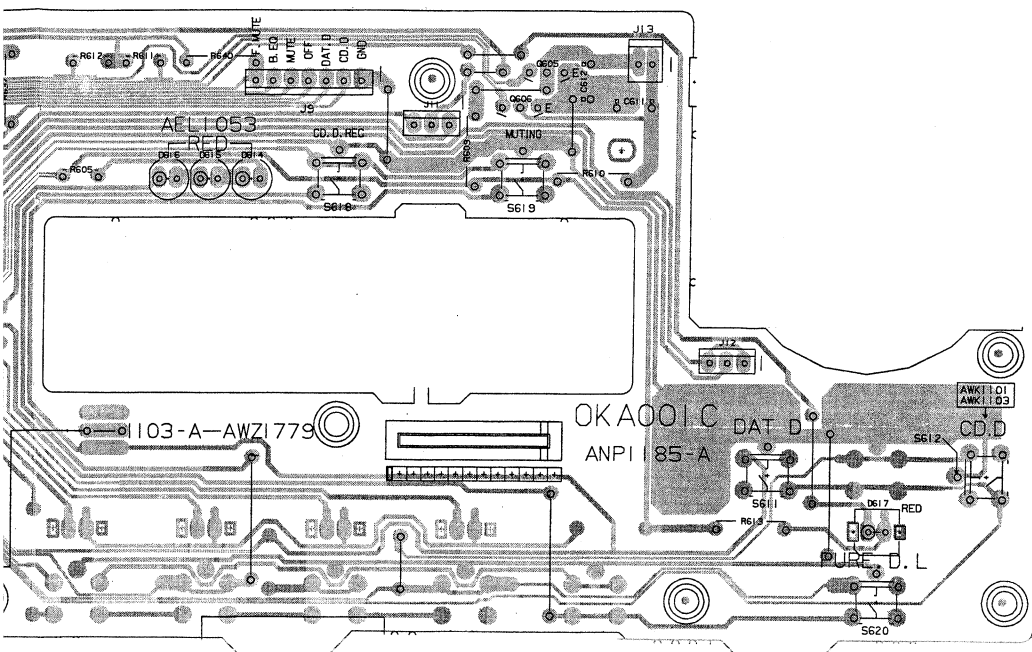

ASSEMBLY

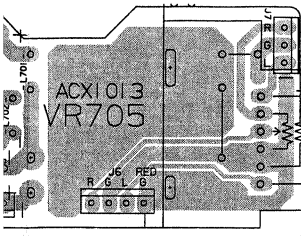

CONNECTOR ASSEMBLY

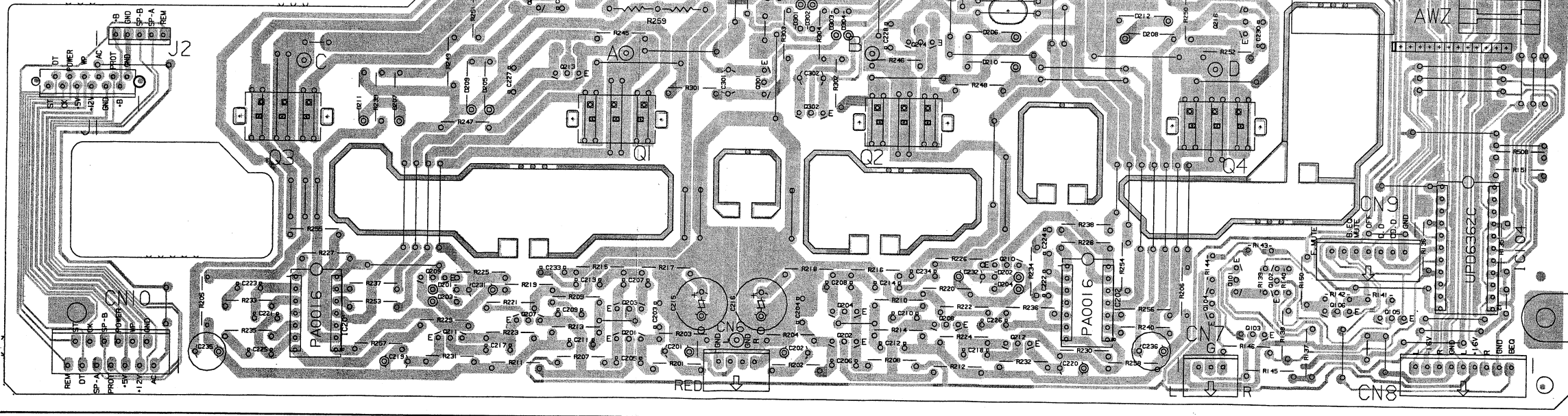
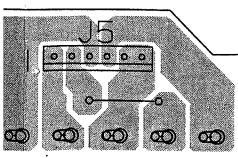

- IC201
- Q209
- Q211
- Q207
- Q215
- Q213
- Q203
- Q201
- IC501
- Q501-Q504
- Q301
- Q302
- Q202
- Q204
- Q208
- Q214
- Q303-Q308
- Q210
- Q212
- IC202
- IC102
- Q216
- IC103
- Q101-Q106
- IC101
- IC104

4

5

6

7

8

9

1

2

3

4

5

6

A

B

C

D

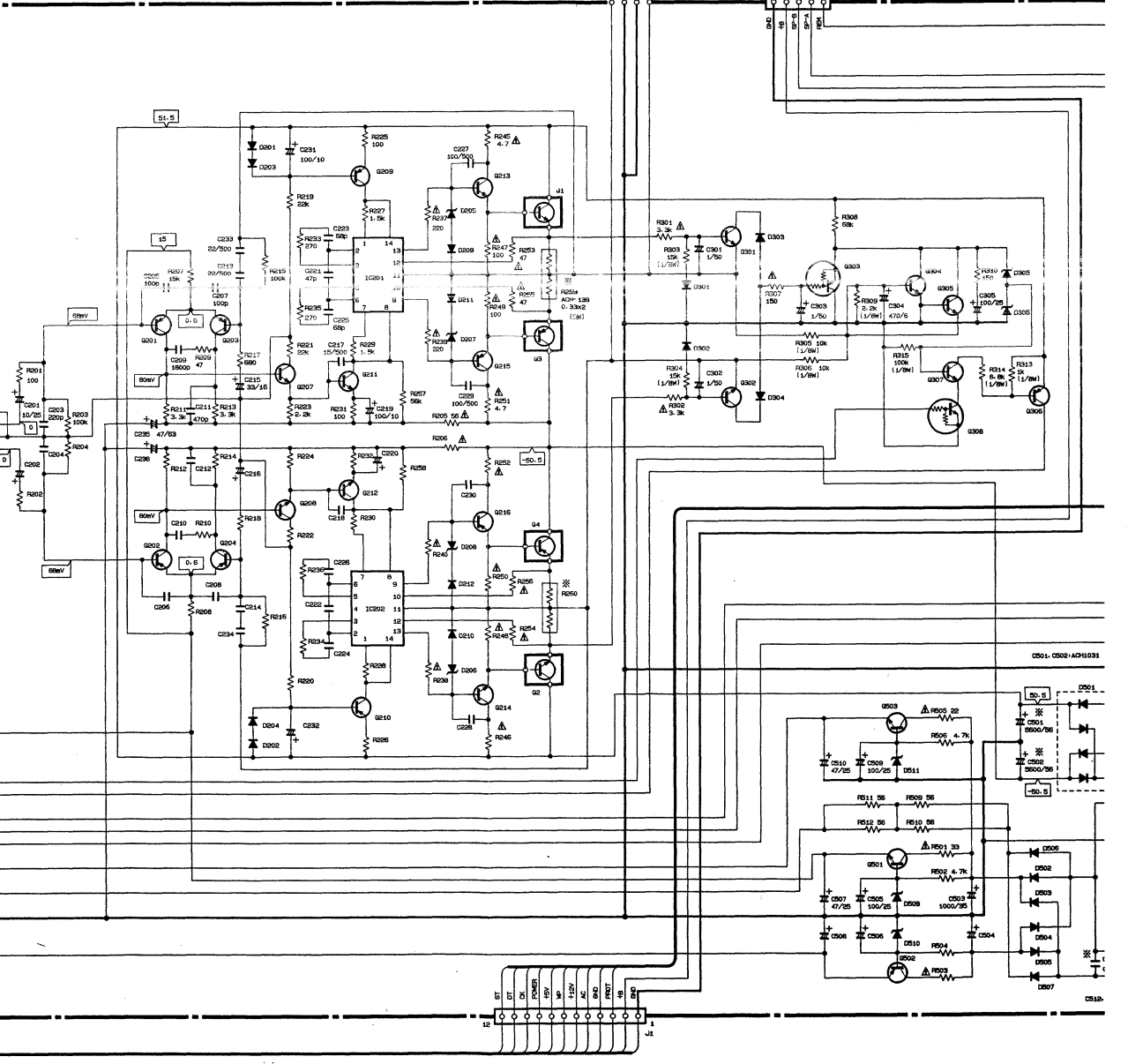
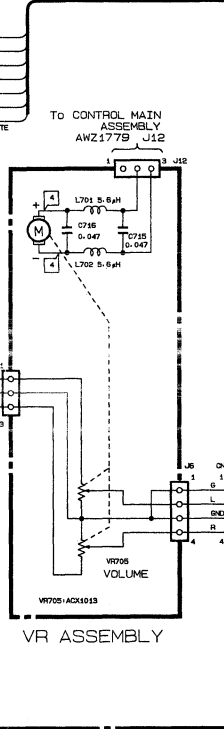
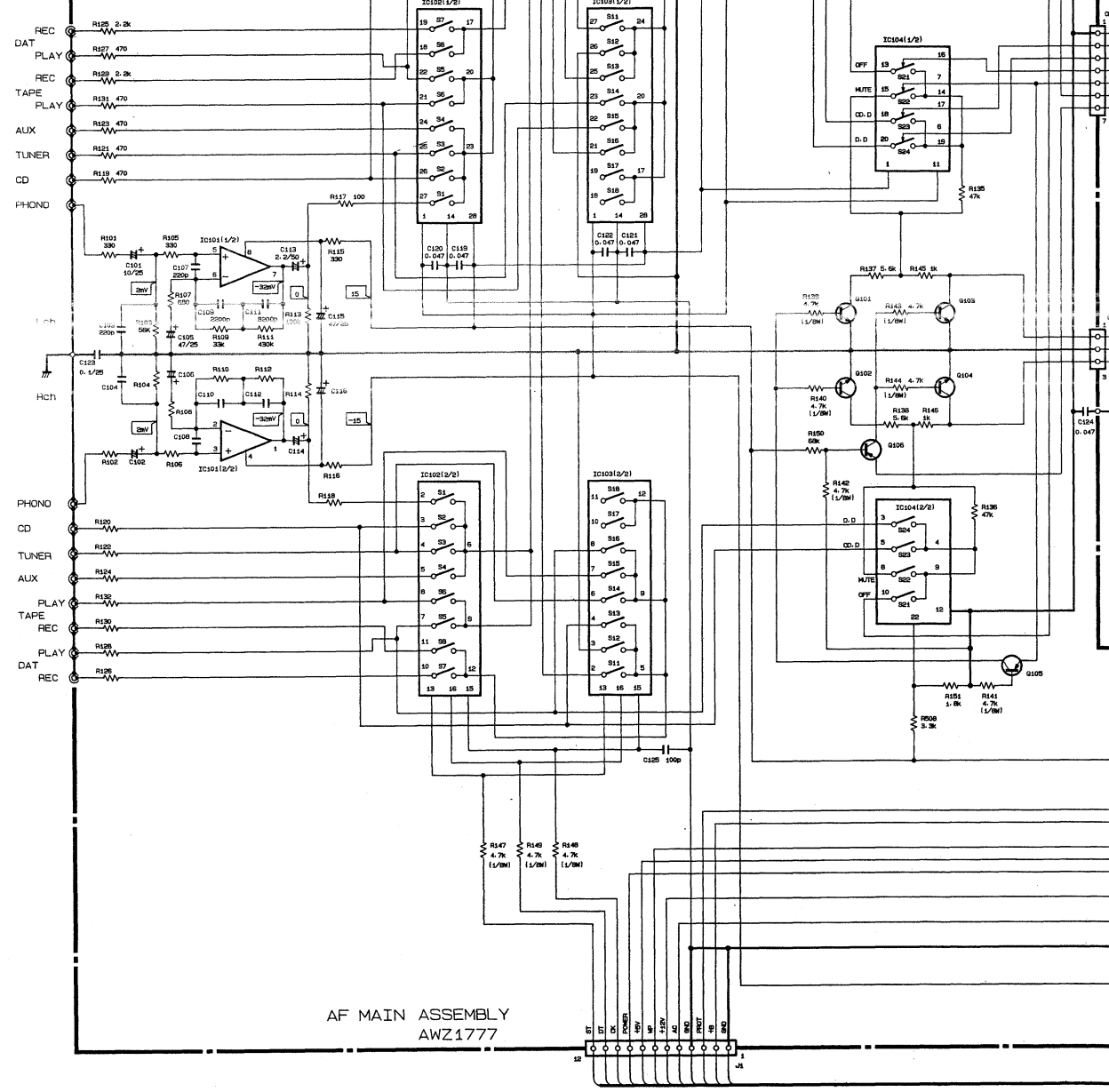
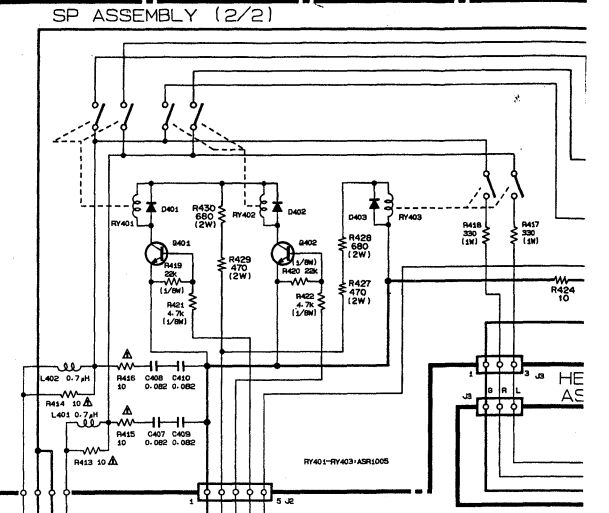
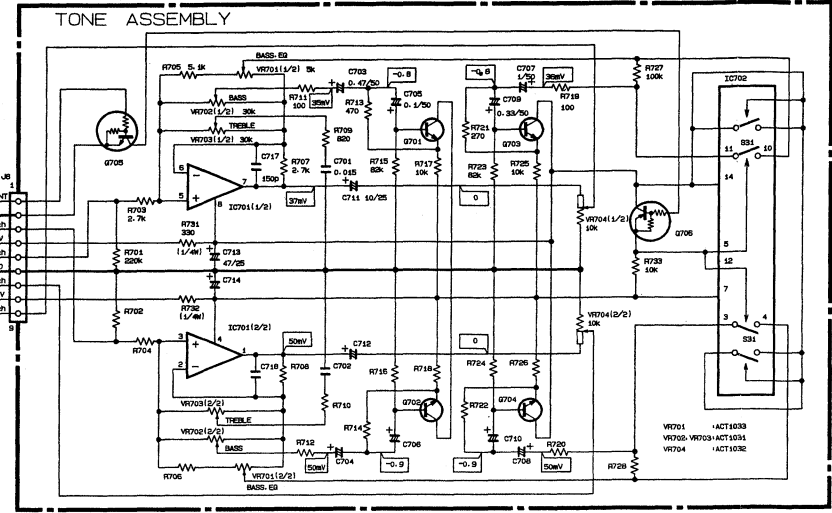
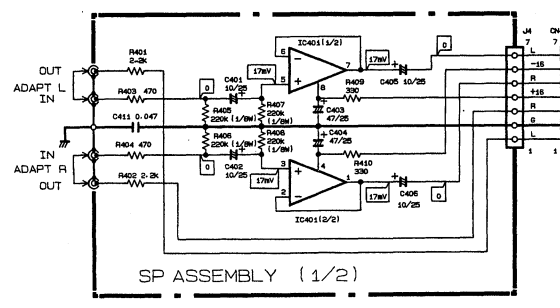

1

2

3

4

5

6

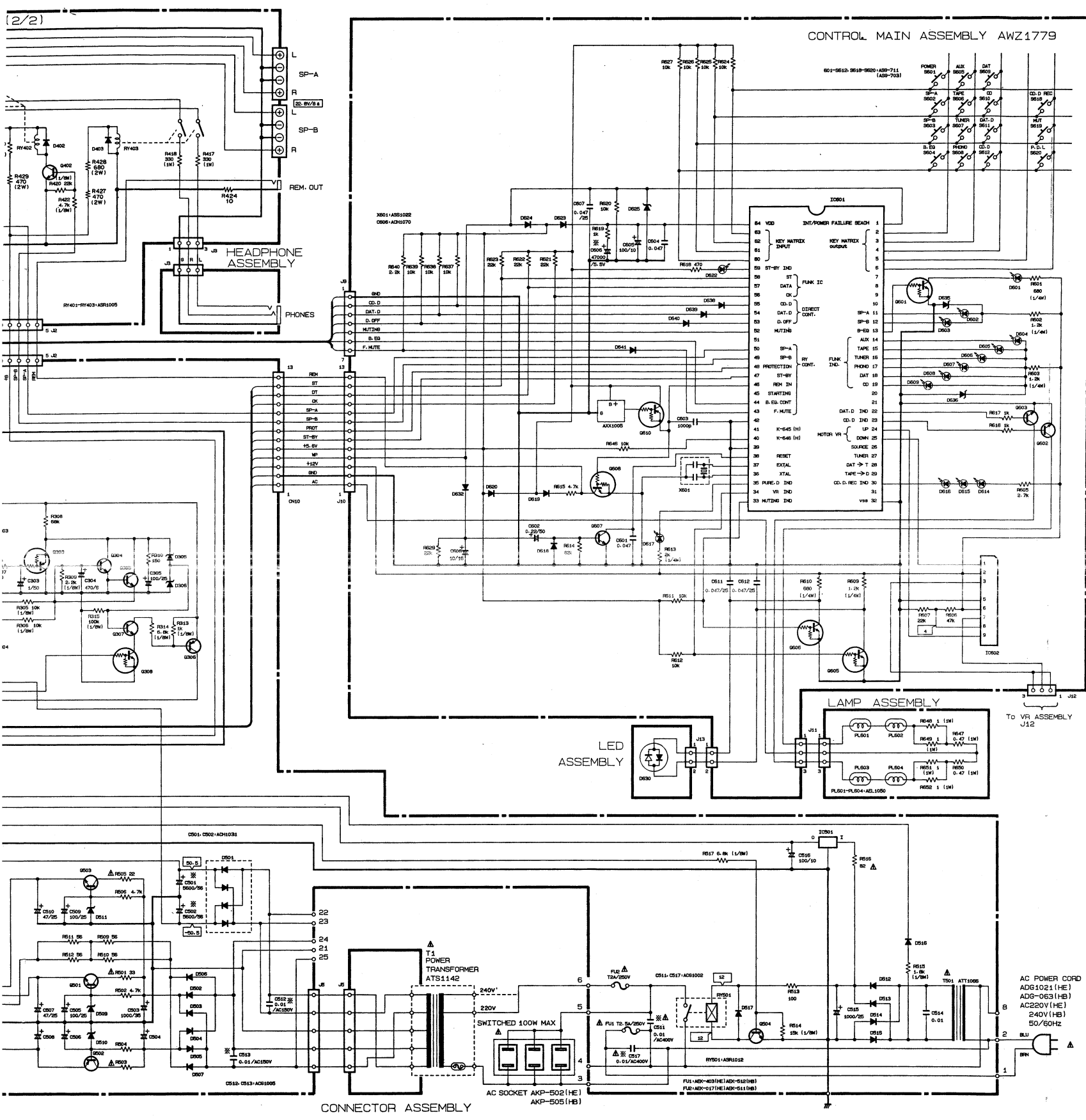

AF main assembly (AWZ1777)

Q3,Q4 Transistor	2SA1264N
Q1,Q2 Transistor	2SC3181N
IC101	M5218P
IC501	M5278L56
IC201,IC202	PA0016
IC103	TC9163N
IC102	TC9164N
IC104	μPD6362C
Q308	RN1201 (DTC143ES)
Q303	RN2203 (DTA124ES)
Q105,Q106	2SA1048
Q215,Q216	2SA5 5
Q201-Q204,Q209, Q210	2SA992
Q306,Q502	2SB560
Q213,Q214	2SC2235
Q207,Q208,Q211,Q212,Q301, Q302,Q307,Q504	2SC2240
Q304,Q305	2SC2458
Q101-Q104	2SC2878
Q501	2SD438
Q503	2SD880
D207,D208	HZS4BLL
D205,D206	HZS5BLL
D501	RBV402
D305	RD13ESB
D511	RD13ESB1
D509,D510	RD16ESB3
D306	RD5.6ESB
D502-D507,D512-D515	S5566 (1IE2)
D201-D204,D209-D212, D301-D304,D516,D517	1SS252

- RESISTORS:**  
Indicated in Ω, ¼W, ½W, ±5% tolerance unless otherwise noted k: kΩ, M: MΩ, (F): ±1%, (G): ±2%, (K): ±10% (M): ±20% tolerance
  - CAPACITORS:**  
Indicated in capacity (μF)/voltage (V) unless otherwise noted p: pF  
Indication without voltage is 50V except electrolytic capacitor.
  - VOLTAGE, CURRENT:**  
    - : Signal voltage at 62 W+ 62 W, 8Ω output (1kHz)
    - : DC voltage (V) at no input signal
    - Value in ( ) is DC voltage at rated power.
    - ← mA: DC current at no input signal
  - OTHERS:**  
    - : Signal route.
    - ⊗: Adjusting point.
    - ⚠: mark found on some component parts indicates the importance of the safety factor of the part. Therefore, when replacing, be sure to use parts of identical designation.
    - \* marked capacitors and resistors have parts numbers.
- This is the basic schematic diagram, but the actual circuit may vary due to improvements in design.

Control main assembly (AWZ1779)

IC601	PDG022
IC602	TA7291S
Q601,Q605,Q606,Q608	RN1201 (DTC143ES)
Q610	RN2201 (DTA143ES)
Q602,Q603	2SC2235
Q607	2SC2458
D614-D616	AEL1053
D602-D609,D617,D622	AEL1072
D601	AEL1073
D635,D636	RD3.0ESB
D625	RD4.7ESB2
D618-D620,D623,D624,D632, D638-D641	1SS252

**SP assembly**

IC401	M5218PF
Q401,Q402	2SC2240
D401-D403	1SS252

**TONE assembly**

IC702	LC4966
IC701	M5218PF
Q705	RN1201 (DTC143ES)
Q706	RN2201 (DTA143ES)
Q701-Q704	2SC1740SLN

**LED assembly**

D630 LED	AEL1071
----------	---------

A  
B  
C  
D



1

2

3

4

5

6

A

B

C

D

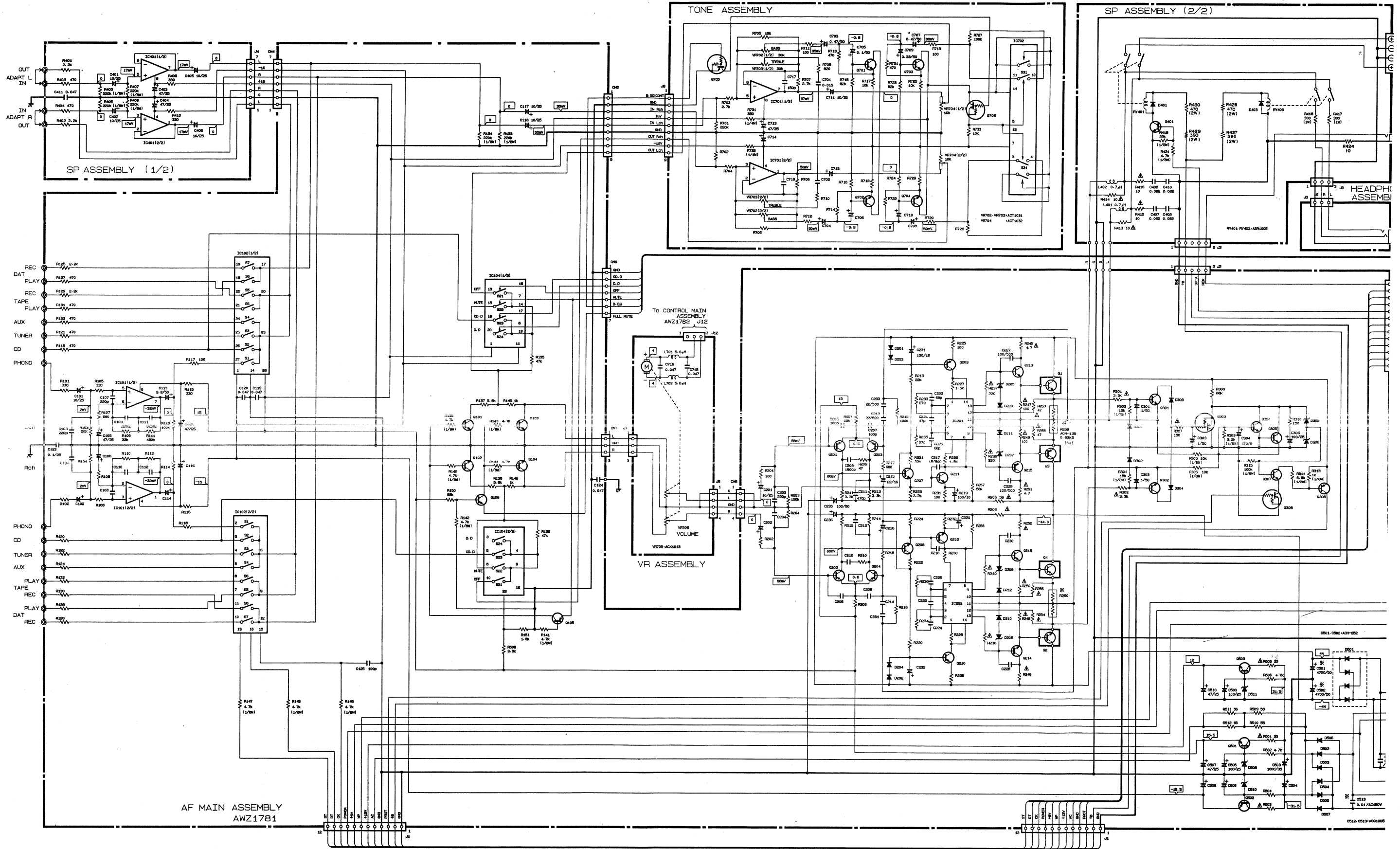

1

2

3

4

5

6

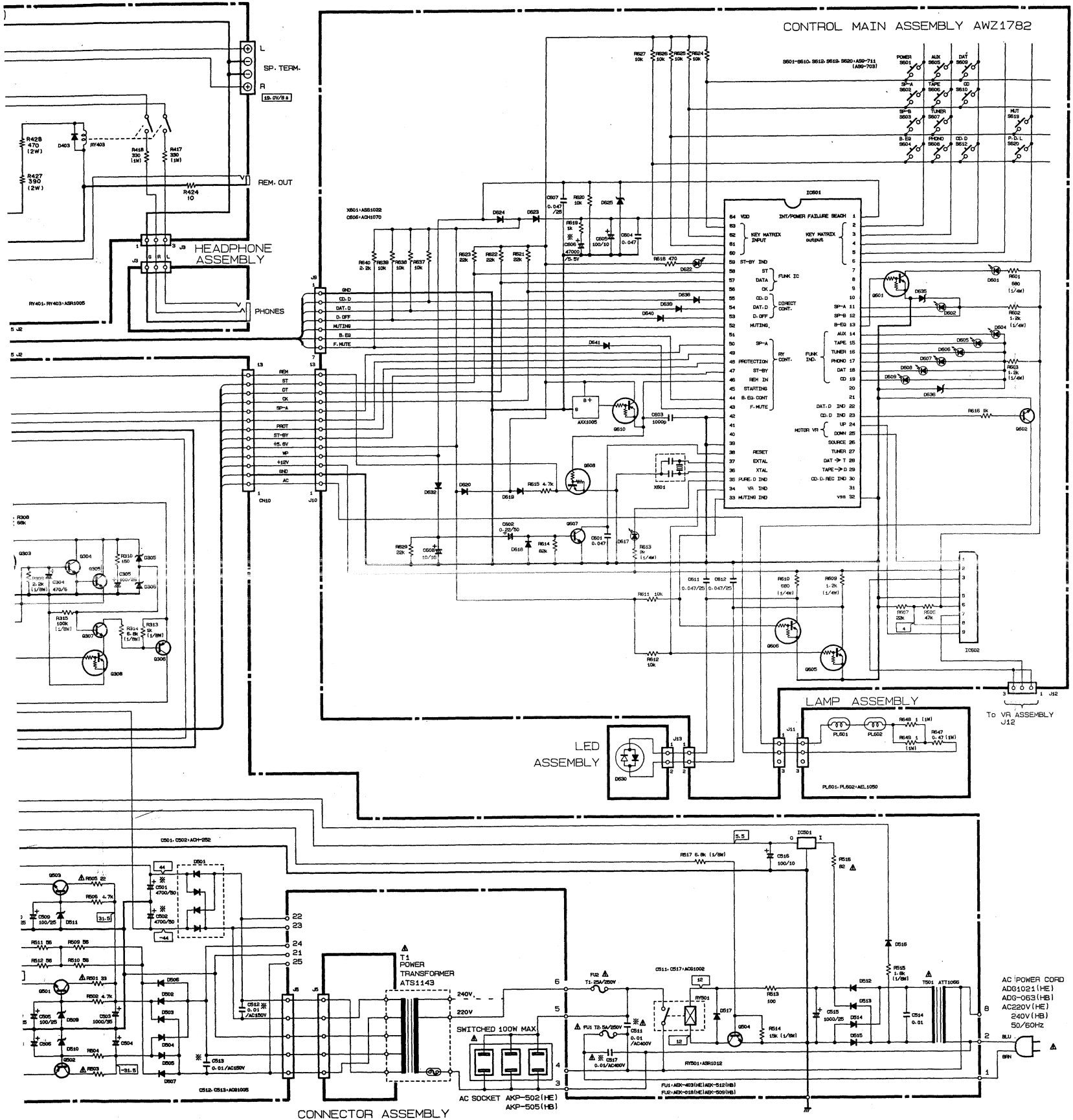

**AF main assembly (AWZ1781)**

Q3,Q4 Transistor	2SA1263N
Q1,Q2 Transistor	2SC3180N
IC101	M5218P
IC501	M5278L56
IC201,IC202	PA0016
IC102	TC9164N
IC104	μPD6362C
Q308	RN1201 (DTC143ES)
Q303	RN2203 (DTA124ES)
Q105,Q106	2SA1048
Q215,Q216	2SA965
Q201,Q202,Q203,Q204,Q209, Q210	2SA992
Q306,Q502	2SB560
Q213,Q214	2SC2235
Q207,Q208,Q211,Q212,Q301, Q302,Q307,Q504	2SC2240
Q304,Q305	2SC2458
Q101-Q104	2SC2878
Q501	2SD438
Q503	2SD880
D207,D208	HZS4BLL
D205,D206	HZS5BLL
D501	RBV402
D305	RD13ESB
D511	RD13ESB1
D509,D510	RD16ESB3
D306	RD5.6ESB
D502-D507,D512-D515	S5566 (11E2)
D201-D204,D209-D212, D301-D304,D516,D517	1SS252

**Control main assembly (AWZ1782)**

IC601	PDG022
IC602	TA7291S
Q601,Q605,Q606,Q608	RN1201 (DTC143ES)
Q610	RN2201 (DTA143ES)
Q602	2SC2235
Q607	2SC2458
D602,D604,D605-D609,D617, D622	AEL1072
D601	AEL1073
D635,D636	RD3.0ESB
D625	RD4.7ESB2
D618-D620,D623,D624,D632, D638-D641	1SS252

- RESISTORS:**  
Indicated in Ω, ¼W, ½W, ±5% tolerance unless otherwise noted k : kΩ, M : MΩ, (F) : ±1%, (G) : ±2%, (K) : ±10% (M) : ±20% tolerance
- CAPACITORS:**  
Indicated in capacity (μF)/voltage (V) unless otherwise noted p : pF  
Indication without voltage is 50V except electrolytic capacitor.

- VOLTAGE, CURRENT:**  
 : Signal voltage at 45 W+ 45 W, 8Ω output (1kHz)  
 : DC voltage (V) at no input signal  
 Value in ( ) is DC voltage at rated power.  
 : DC current at no input signal

- OTHERS:**  
 : Signal route.  
 : Adjusting point.  
 The mark found on some component parts indicates the importance of the safety factor of the part. Therefore, when replacing, be sure to use parts of identical designation.  
 \* marked capacitors and resistors have parts numbers.

This is the basic schematic diagram, but the actual circuit may vary due to improvements in design.

**5. SWITCH**

S601 POWER	S608 PHONO
S602 SP-A	S609 DAT
S603 SP-B	S610 CD
S604 B.EQ	S612 CD.D
S605 AUX	S619 MUT
S606 TAPE	S620 P.D.L
S607 TUNER	

**SP assembly**

IC401	M5218PF
Q401	2SC2240
D401,D403	1SS252

**TONE assembly**

IC702	LC4966
IC701	M5218PF
Q705	RN1201 (DTC143ES)
Q706	RN2201 (DTA143ES)
Q701-Q704	2SC1740SLN

**LED assembly**

D630 LED	AEL1071
----------	---------

1

2

3

4

5

6

AF MAIN ASSEMBLY (AWZ 1781)

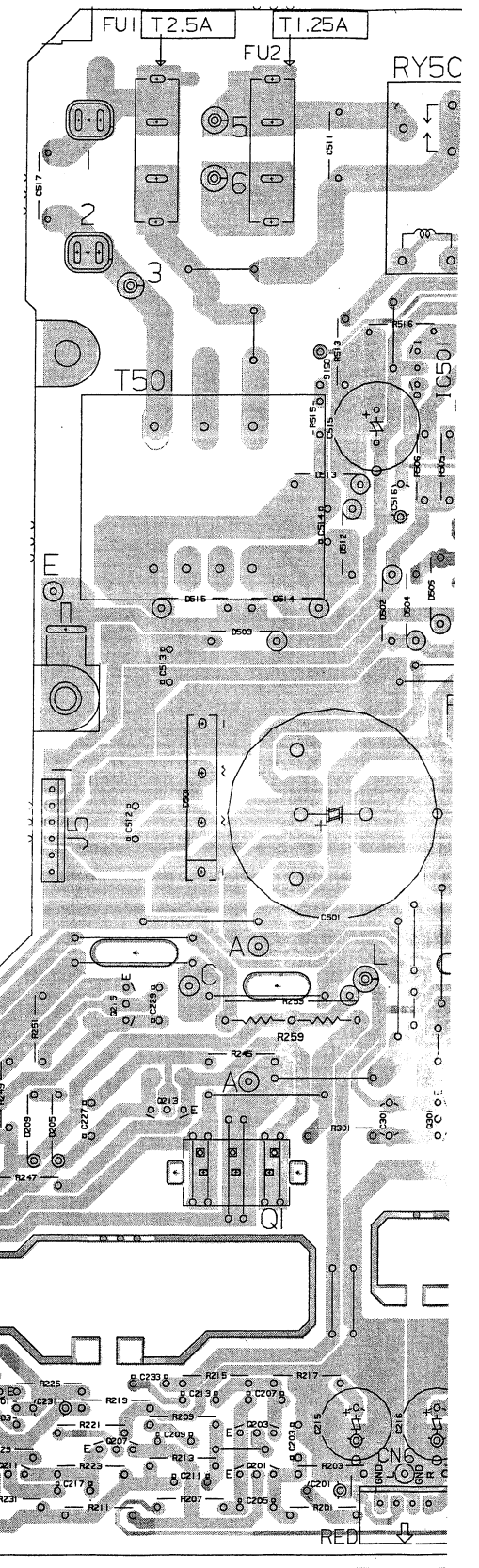

Q610 Q608

IC601

Q607

IC602 Q602

Q606 Q605

Q601

A

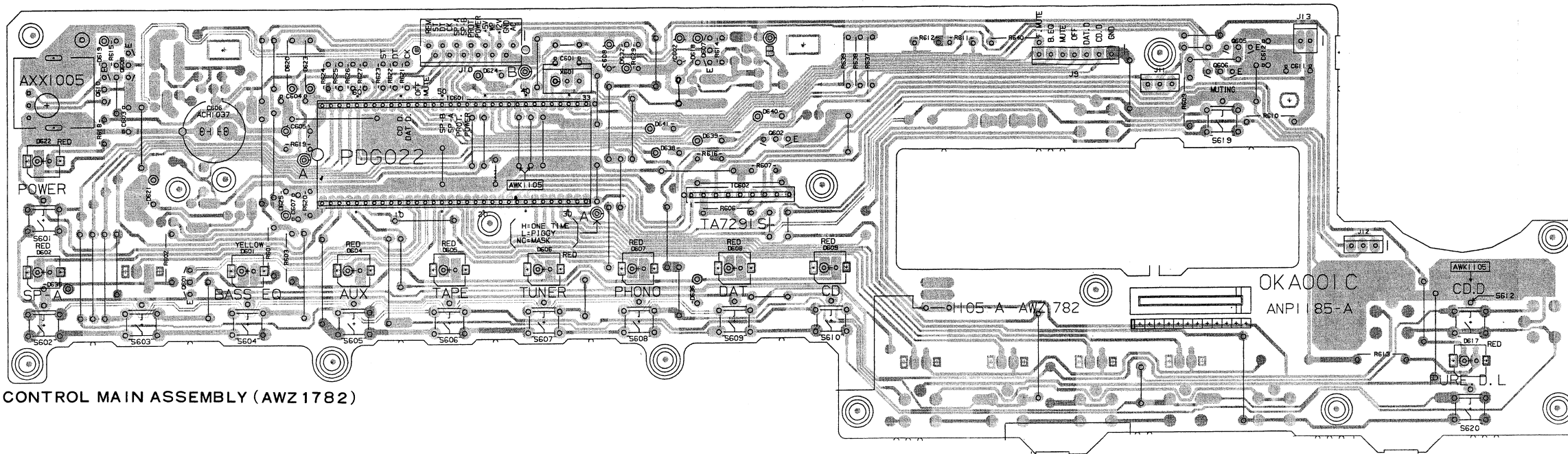

CONTROL MAIN ASSEMBLY (AWZ 1782)

SP ASSEMBLY

VR ASSEMBLY

LAMP ASSEMBLY

CONNECTOR ASSEMBLY

C

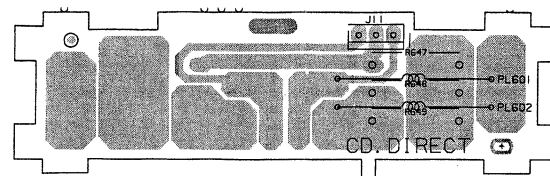
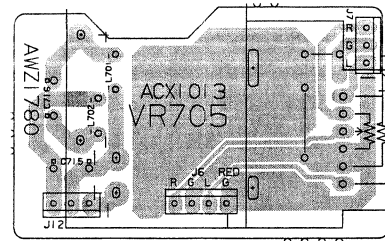
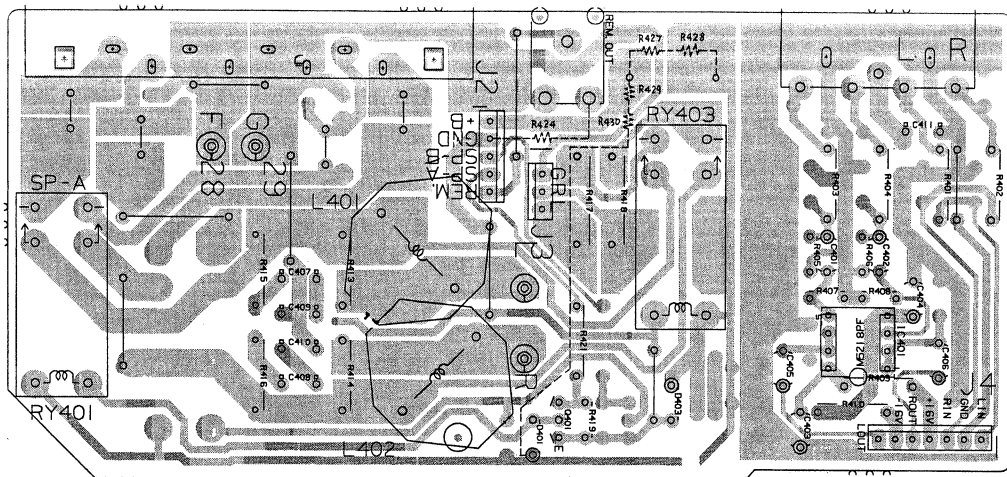

D

TONE ASSEMBLY

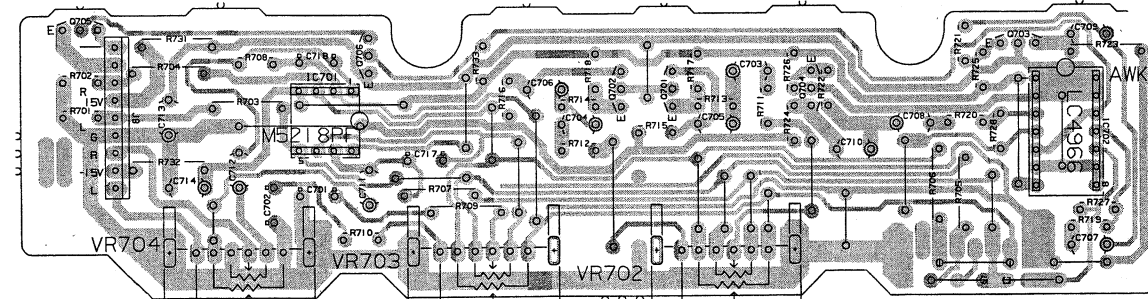

IC201 Q209 Q211

Q207 Q215 Q213

Q203 Q201

IC501 C Q301

1

2

3

4

5

6











NOTE:  
This picture shows the toll side of the printed circuit.

AF MAIN ASSEMBLY (AW2178)

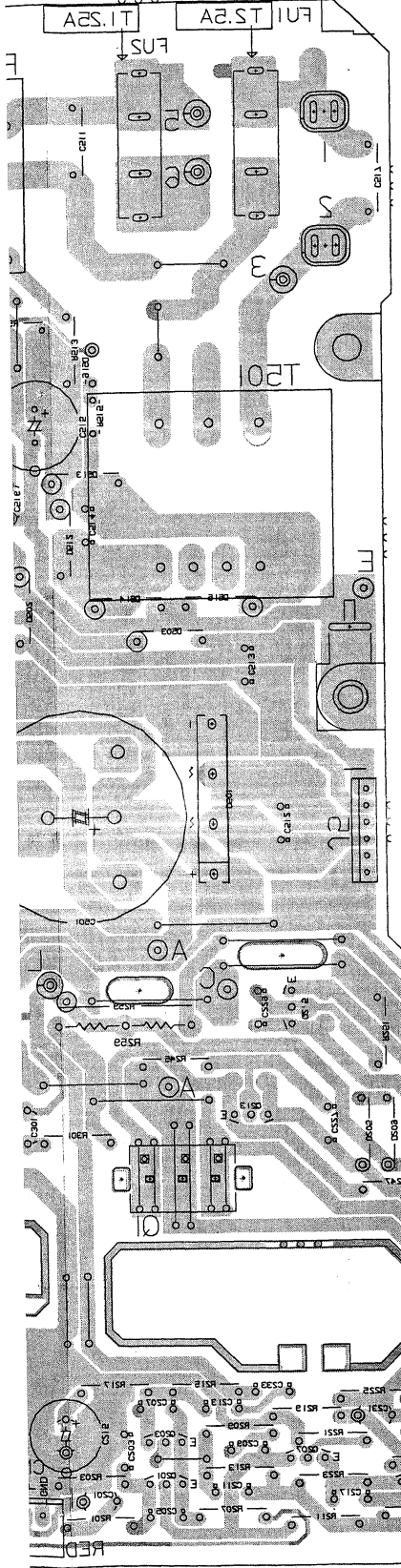

IC501 0508 0511  
0503 0504  
0512 0513

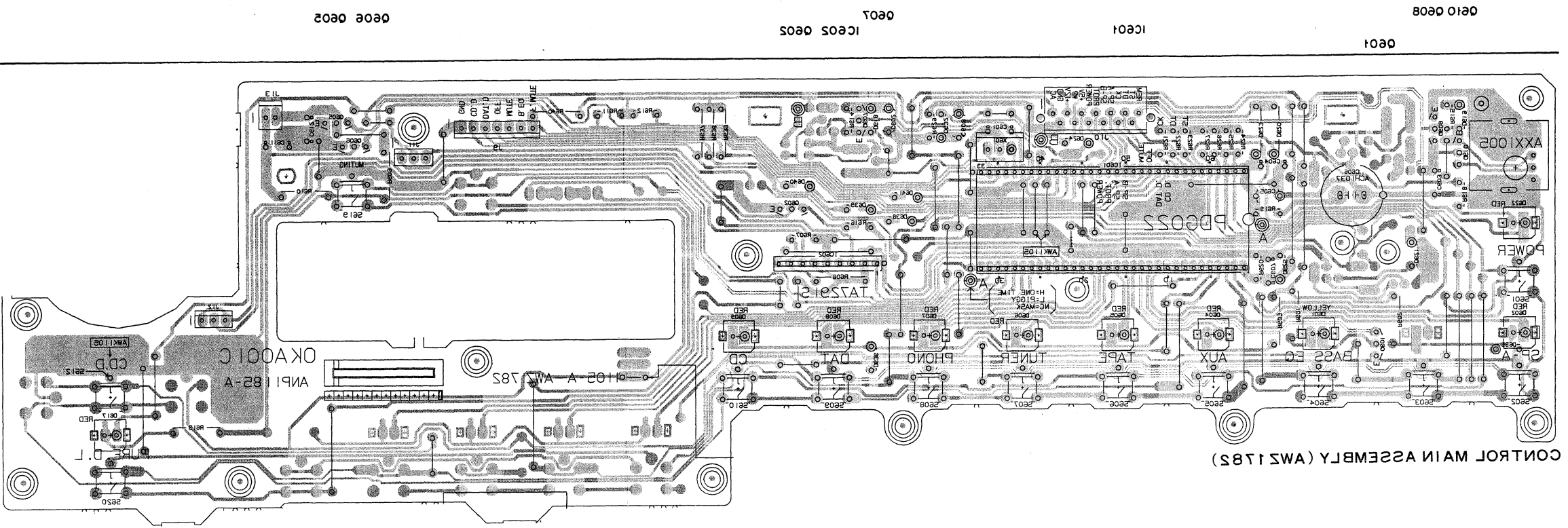

CONTROL MAIN ASSEMBLY (AW2178)

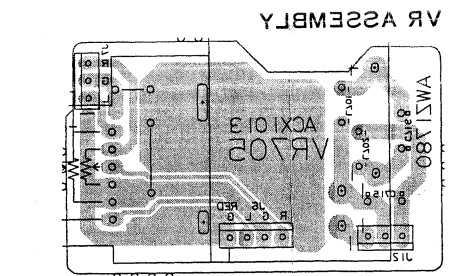

VR ASSEMBLY

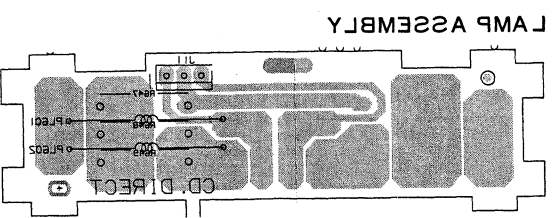

LAMP ASSEMBLY

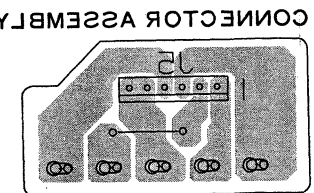

CONNECTOR ASSEMBLY

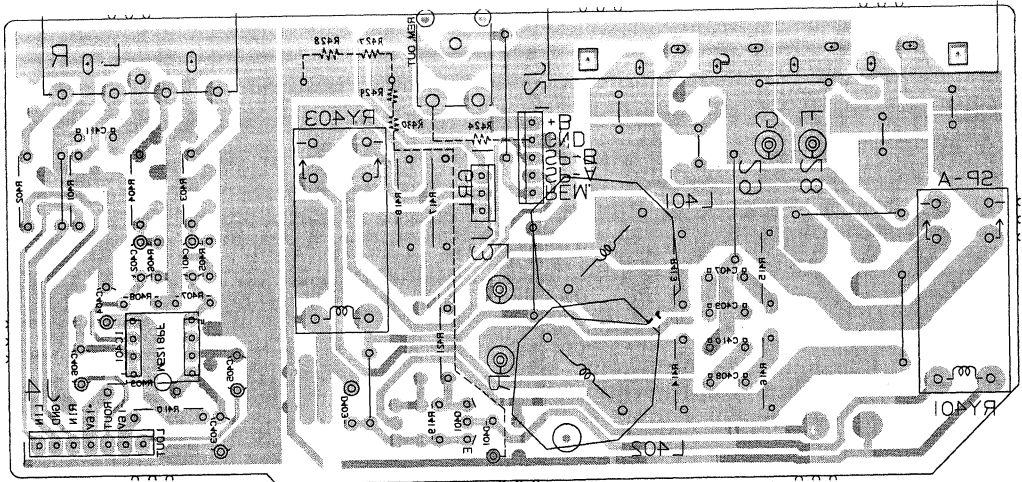

SP ASSEMBLY

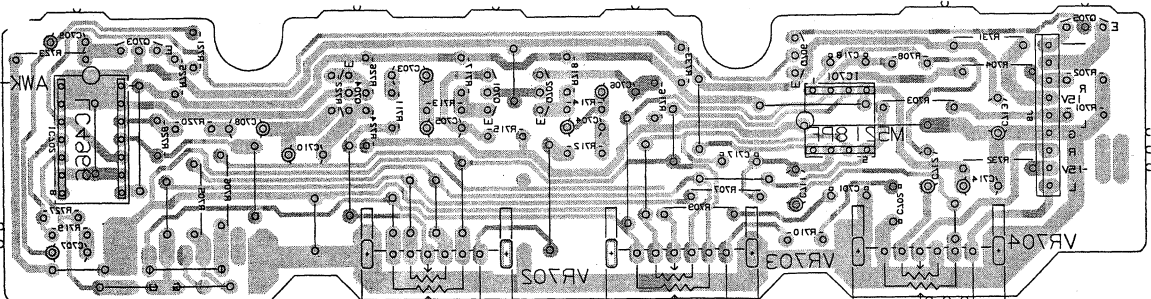

TONE ASSEMBLY

1

2

3

4

5

6

A

B

C

D

1

2

1

2

3

4

5

6

**External Appearances of Transistor and ICs**

**2SA1302  
2SC3281**

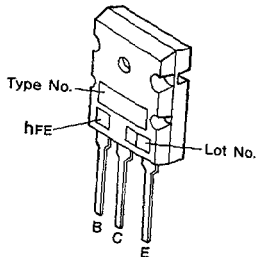

**M5218P  
M5218PF**

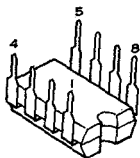

**M5278L56**

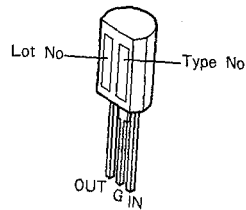

**PA0016  
LC4966**

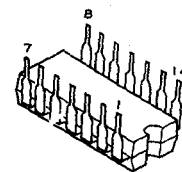

**TC9163N  
TC9164N**

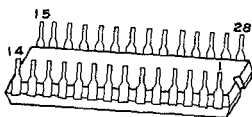

**μPD6362C**

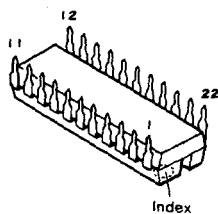

**RN1201  
RN2203  
RN2201**

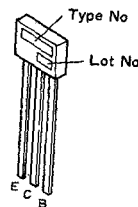

**2SA1048  
2SC2458**

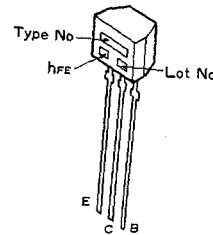

**2SA1145  
2SC2240  
2SC2878  
2SC2705**

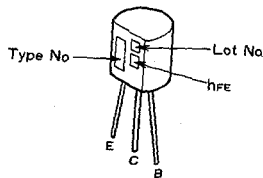

**2SA968  
2SD880  
2SC2238**

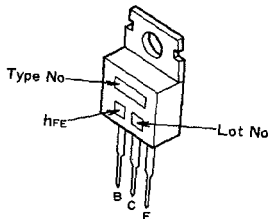

**2SA992  
2SC1845**

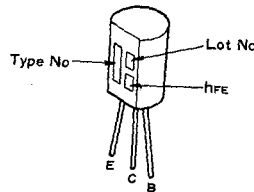

**2SB560  
2SD438**

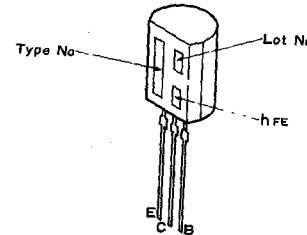

**TA7291S**

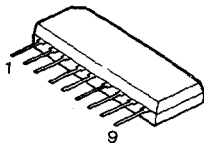

**2SC2235  
2SA965**

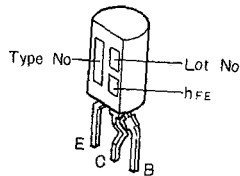

**2SC1740SLN**

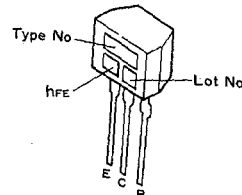

**2SA1263N  
2SC3180N  
2SA1264N  
2SC3181N**



**PDG022**

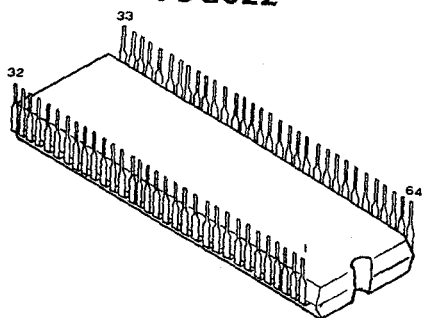

**DTA143ES  
DTC143ES  
DTA124ES**

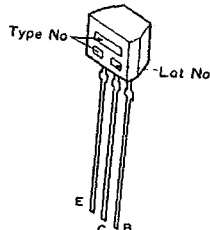

## 4. ELECTRICAL PARTS LIST

**NOTES:**

- Parts without part number cannot be supplied.
- Parts marked by "⊙" are not always kept in stock. Their delivery time may be longer than usual or they may be unavailable.
- The  $\Delta$  mark found on some component parts indicates the importance of the safety factor of the part. Therefore, when replacing, be sure to use parts of identical designation.
- For your parts Stock Control, the fast moving items are indicated with the marks **★★** and **★**.

**★★ GENERALLY MOVES FASTER THAN ★**

This classification shall be adjusted by each distributor because it depends on model number, temperature, humidity, etc.

- When ordering resistors, first convert resistance values into code form as shown in the following examples.

Ex. 1 When there are 2 effective digits (any digit apart from 0), such as 560 ohm and 47k ohm (tolerance is shown by J = 5%, and K = 10%).

560Ω	56 × 10 <sup>1</sup>	561.....	RD1/4PS	Ⓜ	Ⓜ	Ⓜ	J
47kΩ	47 × 10 <sup>3</sup>	473.....	RD1/4PS	Ⓜ	Ⓜ	Ⓜ	J
0.5Ω	0R5.....		RN2H	Ⓜ	Ⓜ	Ⓜ	K
1Ω	010.....		RS1P	Ⓜ	Ⓜ	Ⓜ	K

Ex. 2 When there are 3 effective digits (such as in high precision metal film resistors).

5.62kΩ	562 × 10 <sup>1</sup>	5621.....	RN1/4SR	Ⓜ	Ⓜ	Ⓜ	F
--------	-----------------------	-----------	---------	---	---	---	---

### 4.1 A-X540

#### Miscellaneous Parts List

#### P.C. BOARD ASSEMBLIES

Mark	Symbol & Description	Part No.	Mark	Symbol & Description	Part No.
	AF main assembly	AWZ1770	★★	IC104	μPD6362C
	Control main assembly	AWZ1772	★★	Q308	RN1201
	SP assembly				(DTC143ES)
	HEADPHONE assembly		★★	Q303	RN2203
	TONE assembly				(DTA124ES)
	LAMP assembly		★★	Q105,Q106	2SA1048
	VR assembly		★★	Q209,Q210	2SA1145
	LED assembly		★★	Q215,Q216	2SA968

#### OTHERS

Mark	Symbol & Description	Part No.	Mark	Symbol & Description	Part No.
★★	Q3,Q4 Transistor	2SA1302	★★	Q201-Q204	2SA992
★★	Q1,Q2 Transistor	2SC3281	★★	Q306,Q502	2SB560
$\Delta$ ★	T1 Power transformer (220V/240V)	ATS1141	★★	Q207,Q208,Q301,Q302	2SC1845
	Jumper plug	AKM1019	★★	Q213,Q214	2SC2238
$\Delta$	AC socket (3P OUTLET)	AKP-502	★★	Q307,Q504	2SC2240
$\Delta$ ★★	FU1,FU2 Fuse (T2.5A/250V)	AEK-403	★★	Q304,Q305	2SC2458
$\Delta$	AC power cord	ADG1021	★★	Q211,Q212	2SC2705
	Remote control unit	AXD1053	★★	Q101-Q104	2SC2878
			★★	Q501	2SD438
			★★	Q503	2SD880
			★	D501	D5SB20F
			★	D207,D208	HZS5BLL
			★	D205,D206	HZS5CLL
			★	D305	RD13ESB
			★	D511	RD13ESB1
			★	D509,D510	RD16ESB3

#### AF main assembly (AWZ1770)

#### SEMICONDUCTORS

Mark	Symbol & Description	Part No.	Mark	Symbol & Description	Part No.
★★	IC101	M5218P	★	D306	RD5.6ESB
★★	IC501	M5278L56	★	D502-D507,D512-D515	S5566
★★	IC201,IC202	PA0016			(11E2)
★★	IC103	TC9163N	★	D201-D204,D209-D212, D301-D304,D516,D517	1SS252
★★	IC102	TC9164N			

**RELAY**

Mark	Symbol & Description	Part No.
▲★★	RY501 Relay	ASR-516

**TRANSFORMER**

Mark	Symbol & Description	Part No.
▲★	T501 Power transformer	ATT1066

**CAPACITORS**

Mark	Symbol & Description	Part No.
▲	C511 Power capacitor (0.01/AC400V)	ACG1002
	C512,C513 Power capacitors (0.01/AC150V)	ACG1005
	C501,C502 (8200/71)	ACH1074
	C227-C230	CCCSL101K500
▲	C517 Power capacitor (0.01/AC400V)	ACG1003
	C217,C218	CCCSL150K500
	C213,C214,C233,C234	CCCSL220K500
	C103,C104,C107,C108,C203,C204	CKMYB221K50
	C221,C222	CCCSL470J50
	C223-C226	CCCSL680J50
	C125,C205-C208	CCMSL101J50
	C301,C302	CEANP010M50
	C303	CEAS010M50
	C101,C102,C117,C118	CEAS100M25
	C305,C509,C516	CEAS101M25
	C515	CEAS102M25
	C503,C504	CEAS102M35
	C113,C114	CEAS2R2M50
	C105,C106,C115,C116,C510	CEAS470M25
	C304	CEAS471M6
	C235,C236	CEXA470M63
	C201,C202	CEYA100M25
	C215,C216,C231,C232,C505,C506	CEYA101M25
	C507,C508	CEYA470M25
	C514	CKCYB103K50
	C209,C210	CKCYB182K50
	C211,C212	CKCYB471K50
	C119-C122,C124	CKCYF473Z50
	C123	CKCYX104M25
	C109,C110	CQMA222J50
	C111,C112	CQMA822J50
	C219,C220	CEYA101M16

**RESISTORS**

Mark	Symbol & Description	Part No.
▲	R259,R260 (0.33×2/5W)	ACN-139
	R201,R202,R215-R218	RDR1/4PM□□□J
	R205,R206,R516	RD1/4PMFL□□□J
▲	R247-R250,R307,R237-R240,R301,R302,R253-R256	RD1/4PMF□□□J

Mark	Symbol & Description	Part No.
	R313,R303-R306,R315,R514,R515,R309,R133,R134,R314,R139-R144,R147-R149,R517	RD1/8PM□□□J
▲	R505,R501,R503,R245,R246,R251,R252	RFA1/4PS□□□J

Other resistors RD1/4PM□□□J

**OTHERS**

Mark	Symbol & Description	Part No.
	4P Pin jack (TAPE)	AKB1007
	4P Pin jack (DAT)	AKB1051
	2P Pin jack (PHONO)	AKB1052
	6P Pin jack (CD, TUNER, AUX)	AKB1053
	Transistor socket	AKH-017

**Control main assembly (AWZ1772)**

**SEMICONDUCTORS**

Mark	Symbol & Description	Part No.
★★	IC601	PDG022
★★	IC602	TA7291S
★★	Q601,Q605,Q606,Q608	RN1201 (DTC143ES)
★★	Q609-Q611	RN2201 (DTA143ES)
★★	Q602,Q603	2SC2235
★★	Q607,Q612-Q614,Q604	2SC2458
★	D614-D616	AEL1053
★	D602-D613,D617,D622	AEL1072
★	D601	AEL1073
★	D635,D636	RD3.0ESB
★	D625	RD4.7ESB2
★	D618-D621,D623,D624,D626-D629,D631-D634,D637-D641	1SS252

**SWITCHES**

Mark	Symbol & Description	Part No.
★★	S601-S620 Tact switch (POWER, SP-A, SP-B, BASS EQ, AUX, TAPE, TUNER, PHONO, DAT, CD, DAT D, CD D, SOURCE, TUNER, DAT ▶ TAPE, TAPE ▶ DAT, OFF, CD D REC, MUTING, PURE.D.L)	ASG-711 (ASG-703)

**CAPACITORS**

Mark	Symbol & Description	Part No.
	C606 (47000μF/5.5V)	ACH1037
	C602	CEJAR22M50
	C609,C608	CEJA100M16
	C605	CEJA101M10

Mark	Symbol & Description	Part No.
	C610	CEJA4R7M50
	C603	CKDYB102K50
	C601,C604	CKDYF473Z50
	C607,C611,C612	CKDYX473M25

## RESISTORS

Mark	Symbol & Description	Part No.
	R601 - R604, R609, R613, R610	RD1/4PM□□□J
	Other resistors	RD1/8PM□□□J

## OTHERS

Mark	Symbol & Description	Part No.
★	X601 Ceramic resonator (4.19MHz) Remote control sensor unit	ASS1022 AXX1005

## SP assembly

### SEMICONDUCTORS

Mark	Symbol & Description	Part No.
★★	IC401	M5218PF
★★	Q401, Q402	2SC2235
★	D401 - D403	1SS252

### RELAIES

Mark	Symbol & Description	Part No.
★★	RY401, RY402 Relay	ASR - 112
★★	RY403 Relay	ASR1005

### COILS

Mark	Symbol & Description	Part No.
	L401, L402 AF choke coil (0.7μF)	ATH1011

### CAPACITORS

Mark	Symbol & Description	Part No.
	C401, C402, C405, C406	CEAS100M25
	C403, C404	CEAS470M25
	C407 - C410	CFTXA823J50
	C411	CKCYF473Z50

### RESISTORS

Mark	Symbol & Description	Part No.
⚠	R415, R416	RD1/4PMFL100J
⚠	R413, R414	RD1/4PMF100J
	R401 - R404, R409, R410, R424	RD1/4PM□□□J
	R427, R429	RS2PMF681J
	R428, R430	RS2PMF821J
	R417, R418	RS2LMF331J
	Other resistors	RD1/8PM□□□J

## OTHERS

Mark	Symbol & Description	Part No.
	4P Pin jack (ADAPTOR)	AKB1033
	8P Speaker terminal (SPEAKERS)	AKE - 111
	Mini jack (CONTROL)	AKN - 207

## HEADPHONE assembly

### RESISTORS

Mark	Symbol & Description	Part No.
	R425, R426	RS1PMF122J

## OTHERS

Mark	Symbol & Description	Part No.
	Headphone jack (PHONES)	AKN1002

## TONE assembly

### SEMICONDUCTORS

Mark	Symbol & Description	Part No.
★★	IC702	LC4966
★★	IC701	M5218PF
★★	Q705	RN1201 (DTC143ES)
★★	Q706	RN2201 (DTA143ES)
★★	Q701 - Q704	2SC1740SLN

### CAPACITORS

Mark	Symbol & Description	Part No.
	C709, C710	CEASR33M50
	C703, C704	CEASR47M50
	C705, C706	CEAS0R1M50
	C707, C708	CEAS010M50
	C711, C712	CEAS100M25
	C713, C714	CEAS470M25
	C717, C718	CKMYB151K50
	C701, C702	CQMA153K50

### RESISTORS

Mark	Symbol & Description	Part No.
★	VR702, VR703 Variable resistor (30k × 2)	ACT1031
★	VR704 Variable resistor (10k × 2)	ACT1032
★	VR701 Variable resistor (5k × 2)	ACT1033
	R731, R732	RD1/4PM331J
	Other resistors	RD1/8PM□□□J

**LAMP assembly**

**RESISTORS**

Mark	Symbol & Description	Part No.
	R647,R650	RS1PMFR47J
	R648,R649,R651,R652	RS1PMF010J

**OTHERS**

Mark	Symbol & Description	Part No.
★★	PL601-PL604 Pilot lamp Lamp box	AEL1050 AMR1342

**VR assembly**

**COILS**

Mark	Symbol & Description	Part No.
	L701,L702 Axial inductor (5.6μH)	LAU5R6K

**CAPACITORS**

Mark	Symbol & Description	Part No.
	C715,C716	CKCYF473Z50

**RESISTOR**

Mark	Symbol & Description	Part No.
★	VR705 Variable resistor (100k × 2)	ACX1012

**LED assembly**

**SEMICONDUCTOR**

Mark	Symbol & Description	Part No.
★	D630 LED	AEL1071



**4.2 A - X440**

**Miscellaneous Parts List**

**P.C.BOARD ASSEMBLIES**

Mark	Symbol & Description	Part No.
	AF main assembly	AWZ1777
	Control main assembly	AWZ1779
	SP assembly	
	HEADPHONE assembly	
	CONNECTOR assembly	
	TONE assembly	
	LAMP assembly	
	VR assembly	
	LED assembly	

**OTHERS**

Mark	Symbol & Description	Part No.
★★	Q3,Q4 Transistor	2SA1264N
★★	Q1,Q2 Transistor	2SC3181N

Mark	Symbol & Description	Part No.
△ ★	T1 Power transformer (220V/240V)	ATS1142
△	AC socket (3P OUTLET)	AKP-502
△★★	FU2 Fuse (T2A/250V)	AEK-017
△★★	FU1 Fuse (T2.5A/250V)	AEK-403
△	AC power cord Remote control unit	ADG1021 AXD1053

**AF main assembly (AWZ1777)**

**SEMICONDUCTORS**

Mark	Symbol & Description	Part No.
★★	IC101	M5218P
★★	IC501	M5278L56
★★	IC201,IC202	PA0016
★★	IC103	TC9163N
★★	IC102	TC9164N
★★	IC104	μPD6362C
★★	Q308	RN1201 (DTC143ES)
★★	Q303	RN2203 (DTA124ES)
★★	Q105,Q106	2SA1048
★★	Q215,Q216	2SA965
★★	Q201-Q204,Q209, Q210	2SA992
★★	Q306,Q502	2SB560
★★	Q213,Q214	2SC2235
★★	Q207,Q208,Q211,Q212,Q301, Q302,Q307,Q504	2SC2240
★★	Q304,Q305	2SC2458
★★	Q101-Q104	2SC2878
★★	Q501	2SD438
★★	Q503	2SD880
★	D207,D208	HZS4BLL
★	D205,D206	HZS5BLL
★	D501	RBV402
★	D305	RD13ESB
★	D511	RD13ESB1
★	D509,D510	RD16ESB3
★	D306	RD5.6ESB
★	D502-D507,D512-D515	S5566 (11E2)
★	D201-D204,D209-D212, D301-D304,D516,D517	1SS252

**RELAY**

Mark	Symbol & Description	Part No.
△★★	RY501 Relay	ASR1012

**TRANSFORMER**

Mark	Symbol & Description	Part No.
△ ★	T501 Power transformer	ATT1066

## CAPACITORS

Mark	Symbol & Description	Part No.
⚠	C511,C517 Power capacitors (0.01/AC400V)	ACG1002
	C512,C513 Power capacitors (0.01/AC150V)	ACG1005
	C501,C502 (5600/56) C227-C230	ACH1031 CCCSL101K500
	C217,C218 C213,C214,C233,C234 C103,C104,C107,C108,C203, C204 C221,C222 C223-C226	CCCSL150K500 CCCSL220K500 CKMYB221K50 CCCSL470J50 CCCSL680J50
	C125,C205-C208 C301,C302 C303 C101,C102,C117,C118 C516,C219,C220,C231,C232	CCMSL101J50 CEANP010M50 CEAS010M50 CEAS100M25 CEAS101M10
	C305,C505,C506,C509 C515 C503,C504 C113,C114 C105,C106,C115,C116,C507, C508,C510	CEAS101M25 CEAS102M25 CEAS102M35 CEAS2R2M50 CEAS470M25
	C304 C235,C236 C201,C202 C215,C216 C514	CEAS471M6 CEXA470M63 CEYA100M25 CEYA330M16 CKCYB103K50
	C209,C210 C109,C110 C211,C212 C111,C112 C119-C122,C124 C123	CKCYB182K50 CKCYB222K50 CKCYB471K50 CKCYB822K50 CKCYF473Z50 CKCYX104M25

## RESISTORS

Mark	Symbol & Description	Part No.
	R259,R260 (0.33 x 2/5W) R201,R202 R205,R206,R516,R247-R250, R307,R237-R240,R301,R302, R253-R256	ACN-139 RDR1/4PM101J RD1/4PMF□□□J
	R313,R303-R306,R315,R514, R515,R309,R133,R134,R139- R144,R147-R149,R314,R517	RD1/8PM□□□J
⚠	R505,R501,R503,R245,R246, R251,R252	RFA1/4PS□□□J
	Other resistors	RD1/4PM□□□J

## OTHERS

Mark	Symbol & Description	Part No.
	4P Pin jack (DAT, TAPE)	AKB1007
	6P Pin jack (CD, TUNER, AUX)	AKB1024
	2P Pin jack (PHONO)	AKB1039

## Control main assembly (AWZ1779)

### SEMICONDUCTORS

Mark	Symbol & Description	Part No.
★★	IC601	PDG022
★★	IC602	TA7291S
★★	Q601,Q605,Q606,Q608	RN1201 (DTC143ES)
★★	Q610	RN2201 (DTA143ES)
★★	Q602,Q603	2SC2235
★★	Q607	2SC2458
★	D614-D616	AEL1053
★	D602-D609,D617,D622	AEL1072
★	D601	AEL1073
★	D635,D636	RD3.0ESB
★	D625	RD4.7ESB2
★	D618-D620,D623,D624,D632, D638-D641	1SS252

### SWITCHES

Mark	Symbol & Description	Part No.
★★	S601-S612,S618-S620 Tact switch (POWER, SP-A, SP-B, BASS EQ, AUX, TAPE, TUNER, PHONO, DAT, CD, DAT.D, CD.D, CD.D REC, MUTING, PURE.D.L)	ASG-711 (ASG-703)

### CAPACITORS

Mark	Symbol & Description	Part No.
	C606 (47000μF/5.5V)	ACH1070
	C602	CEJAR22M50
	C608	CEJA100M16
	C605	CEJA101M10
	C603	CKDYB102K50
	C601,C604 C607,C611,C612	CKDYF473Z50 CKDYX473M25

### RESISTORS

Mark	Symbol & Description	Part No.
	R601-R603,R609,R610,R613 Other resistors	RD1/4PM□□□J RD1/8PM□□□J

### OTHERS

Mark	Symbol & Description	Part No.
★	X601 Ceramic resonator (4.19MHz) Remote control sencer unit	ASS1022 AXX1005



**SP assembly  
SEMICONDUCTORS**

Mark	Symbol & Description	Part No.
★★	IC401	M5218PF
★★	Q401,Q402	2SC2240
★	D401-D403	1SS252

**RELAIES**

Mark	Symbol & Description	Part No.
★★	RY401,RY402,RY403 Relay	ASR1005

**COILS**

Mark	Symbol & Description	Part No.
	L401,L402 AF choke coil (0.7μH)	ATH1004

**CAPACITORS**

Mark	Symbol & Description	Part No.
	C401,C402,C405,C406	CEAS100M25
	C403,C404	CEAS470M25
	C411	CKCYF473Z50
	C407-C410	CFTXA823K50

**RESISTORS**

Mark	Symbol & Description	Part No.
△	R415,R416	RD1/4PMFL100J
△	R413,R414	RD1/4PMF100J
	R401-R404,R409,R410,R424	RD1/4PM□□□J
	R417,R418	RS1LMF□□□J
	R427,R429	RS2PMF471J
	R428,R430	RS2PMF681J
	Other resistors	RD1/8PM□□□J

**OTHERS**

Mark	Symbol & Description	Part No.
	4P Pin jack (ADAPTOR)	AKB1033
	8P Speaker terminal (SPEAKERS)	AKE-111
	Mini jack (CONTROL)	AKN-207

**HEADPHONE assembly**

**OTHER**

Mark	Symbol & Description	Part No.
	Headphone jack (PHONES)	AKN1002

**CONNECTOR assembly**

No parts are supplied with the CONNECTOR assembly.

**TONE assembly**

Refer to A-X540.

**LAMP assembly**

Refer to A-X540.

**VR assembly**

**COILS**

Mark	Symbol & Description	Part No.
	L701,L702 Axial inductor (5.6μH)	LAU5R6K

**CAPACITORS**

Mark	Symbol & Description	Part No.
	C715,C716	CKCYF473Z50

**RESISTOR**

Mark	Symbol & Description	Part No.
★	VR705 Variable resistor (100k × 2)	ACX1013

**LED assembly**

Refer to A-X540.

**4.3 A-X340**

**Miscellaneous Parts List**

**P.C. BOARD ASSEMBLIES**

Mark	Symbol & Description	Part No.
	AF main assembly	AWZ1781
	Control main assembly	AWZ1782
	SP assembly	
	HEADPHONE assembly	
	CONNECTOR assembly	
	TONE assembly	
	LAMP assembly	
	VR assembly	
	LED assembly	

**OTHERS**

Mark	Symbol & Description	Part No.
★★	Q3,Q4 Transistor	2SA1263N
★★	Q1,Q2 Transistor	2SC3180N
△ ★	T1 Power transformer (220V/240V)	ATS1143
△	AC socket (3P OUTLET)	AKP-502
△★★	FU2 Fuse (T1.25A/250V)	AEK-018
△★★	FU1 Fuse (T2.5A/250V)	AEK-403
△	AC Power cord	ADG-063
	Remote control unit	AXD1052

## AF main assembly (AWZ1781)

### SEMICONDUCTORS

Mark	Symbol & Description	Part No.
★★	IC101	M5218P
★★	IC501	M5278L56
★★	IC201,IC202	PA0016
★★	IC102	TC9164N
★★	IC104	μPD6362C
★★	Q308	RN1201 (DTC143ES)
★★	Q303	RN2203 (DTA124ES)
★★	Q105,Q106	2SA1048
★★	Q215,Q216	2SA965
★★	Q201,Q202,Q203,Q204,Q209, Q210	2SA992
★★	Q306,Q502	2SB560
★★	Q213,Q214	2SC2235
★★	Q207,Q208,Q211,Q212,Q301, Q302,Q307,Q504	2SC2240
★★	Q304,Q305	2SC2458
★★	Q101-Q104	2SC2878
★★	Q501	2SD438
★★	Q503	2SD880
★	D207,D208	HZS4BLL
★	D205,D206	HZS5BLL
★	D501	RBV402
★	D305	RD13ESB
★	D511	RD13ESB1
★	D509,D510	RD16ESB3
★	D306	RD5.6ESB
★	D502-D507,D512-D515	S5566 (11E2)
★	D201-D204,D209-D212, D301-D304,D516,D517	1SS252

### RELAY

Mark	Symbol & Description	Part No.
△★★	RY501 Relay	ASR1012

### TRANSFORMER

Mark	Symbol & Description	Part No.
△★	T501 Power transformer	ATT1066

### CAPACITORS

Mark	Symbol & Description	Part No.
△	C511,C517 Power capacitors (0.01/AC400V)	ACG1002
	C512,C513 Power capacitors (0.01/AC150V)	ACG1005
	C501,C502 (4700/50)	ACH-252
	C227-C230	CCCSL101K500
	C217,C218	CCCSL150K500
	C213,C214,C233,C234	CCCSL220K500
	C103,C104,C107,C108,C203, C204	CKMYB221K50

Mark	Symbol & Description	Part No.
	C221,C222	CCCSL470J50
	C223-C226	CCCSL680J50
	C125,C205-C208	CCMSL101J50
	C301,C302	CEANP010M50
	C303	CEAS010M50
	C101,C102,C117,C118	CEAS100M25
	C516,C219,C220,C231,C232	CEAS101M10
	C505,C506,C509,C305	CEAS101M25
	C235,C236	CEAS101M50
	C515	CEAS102M25
	C503,C504	CEAS102M35
	C113,C114	CEAS2R2M50
	C105,C106,C115,C116,C507, C508,C510	CEAS470M25
	C304	CEAS471M6
	C215,C216	CEYA220M16
	C201,C202	CEYA100M25
	C514	CKCYB103K50
	C209,C210	CKCYB182K50
	C109,C110	CKCYB222K50
	C211,C212	CKCYB471K50
	C111,C112	CKCYB822K50
	C119,C120,C124	CKCYF473Z50
	C123	CKCYX104M25

### RESISTORS

Mark	Symbol & Description	Part No.
	R259,R260 (0.33 × 2/5W)	ACN-139
△	R205,R206,R516	RD1/4PMFL□□□J
△	R307,R237-R240,R301,R302, R253-R256,R247-R250	RD1/4PMF□□□J
	R313,R303-R306,R514,R515, R309,R133,R134,R139-R144, R147-R149,R314,R517,R315	RD1/8PM□□□J
△	R505,R501,R503,R245,R246, R251,R252	RFA1/4PS□□□J
	Other resistors	RD1/4PM□□□J

### OTHERS

Mark	Symbol & Description	Part No.
	4P Pin jack (TAPE, DAT)	AKB1007
	6P Pin jack (CD, TUNER, AUX)	AKB1024
	2P Pin jack (PHONO)	AKB1039

## Control main assembly (AWZ1782)

### SEMICONDUCTORS

Mark	Symbol & Description	Part No.
★★	IC601	PDG022
★★	IC602	TA7291S

Mark	Symbol & Description	Part No.
★★	Q601,Q605,Q606,Q608	RN1201 (DTC143ES)
★★	Q610	RN2201 (DTA143ES)
★★	Q602	2SC2235
★★	Q607	2SC2458
★	D602,D604,D605-D609,D617, D622	AEL1072
★	D601	AEL1073
★	D635,D636	RD3.0ESB
★	D625	RD4.7ESB2
★	D618-D620,D623,D624,D632, D638-D641	1SS252

**SWITCHES**

Mark	Symbol & Description	Part No.
★★	S601-S610,S612,S619,S620 Tact switch (POWER, SP-A, SP-B, BASS EQ, AUX, TAPE, TUNER, PHONO, DAT, CD, DAT.D, CD.D, CD.D REC, MUTING, PURE.D.L)	ASG-711 (ASG-703)

**CAPACITORS**

Mark	Symbol & Description	Part No.
	C606 (47000 $\mu$ F/5.5V)	ACH1070
	C602	CEJAR22M50
	C608	CEJA100M16
	C605	CEJA101M10
	C603	CKDYB102K50
	C601,C604	CKDYF473Z50
	C607,C611,C612	CKDYX473M25

**RESISTORS**

Mark	Symbol & Description	Part No.
	R601-R603,R609,R610,R613 Other resistors	RD1/4PM□□□J RD1/8PM□□□J

**OTHERS**

Mark	Symbol & Description	Part No.
★	X601 Ceramic resonator (4.19MHz)	ASS1022
	Remote control sencor unit	AXX1005

**SP assembly  
SEMICONDUCTORS**

Mark	Symbol & Description	Part No.
★★	IC401	M5218PF
★★	Q401	2SC2240
★	D401,D403	1SS252

**RELAIES**

Mark	Symbol & Description	Part No.
★★	RY401,RY403 Relay	ASR1005

**COILS**

Mark	Symbol & Description	Part No.
	L401,L402 AF choke coil (0.7 $\mu$ F)	ATH1004

**CAPACITORS**

Mark	Symbol & Description	Part No.
	C401,C402,C405,C406	CEAS100M25
	C403,C404	CEAS470M25
	C411	CKCYF473Z50
	C407-C410	CQMA823K50

**RESISTORS**

Mark	Symbol & Description	Part No.
⚠	R415,R416	RD1/4PMFL100J
⚠	R413,R414	RD1/4PMF100J
	R401-R404,R409,R410,R424	RD1/4PM□□□J
	R417,R418	RS1LMF□□□J
	R427,R429	RS2PMF391J
	R428,R430	RS2PMF471J
	Other resistors	RD1/8PM□□□J

**OTHERS**

Mark	Symbol & Description	Part No.
	4P Pin jack (ADAPTOR)	AKB1033
	4P Speaker terminal (SPEAKERS)	AKE-109
	Mini jack (CONTROL)	AKN-207

**HEADPHONE assembly**

Refer to A-X440.

**CONNECTOR assembly**

Refer to A-X440.

**TONE assembly  
SEMICONDUCTORS**



Mark	Symbol & Description	Part No.
★★	IC702	LC4966
★★	IC701	M5218PF
★★	Q705	RN1201 (DTC143ES)
★★	Q706	RN2201 (DTA143ES)
★★	Q701-Q704	2SC1740SLN





**CAPACITORS**

Mark	Symbol & Description	Part No.
	C709,C710	CEASR33M50



## 6. IC INFORMATION

### MICRO COMPUTER (PDG022)

Terminal No.	Terminal name	I/O	Condition	Terminal status	Remarks										
1	WP	I	Power supply "ON"		If the input frequency is not 50/60Hz the mode will be switched to backup mode.										
2	PA0	O	For A-X540, when control is performed.		Key matrix output										
3	PA1														
4	PA2														
5	PA3														
6	PB0					O									
7	PB1	O			Non used										
8	PB2														
9	PB3														
10	PE0														
11	SP-A	O	SP selector...SP-A	L	SP-A IND illuminates										
12	SP-B	O	SP selector...SP-B	L	SP-B IND illuminates										
13	B-EQ	O	BASS EQ "ON"	H	BASS EQ IND illuminates										
14	AUX	O	When FUNCTION SEL. set at each position.	L	AUX IND illuminates										
15	TAPE			L	TAPE IND illuminates										
16	TUNER			L	TUNER IND illuminates										
17	PHONO			L	PHONO IND illuminates										
18	DAT			L	DAT IND illuminates										
19	CD			L	CD IND illuminates										
20	PC2			O	.....	.....	Non used								
21	PC3	O													
22	DAT.D	O	DAT DIRECT "ON"	H	DAT DIRECT IND illuminates										
23	CD.D	O	CD DIRECT "ON"	H	CD DIRECT IND illuminates										
24	UP	O	VOLUME CONTROL UP/DOWN	<table border="1"> <thead> <tr> <th>Terminal No.</th> <th>24</th> <th>25</th> </tr> </thead> <tbody> <tr> <td>VOL.UP</td> <td>H</td> <td>L</td> </tr> <tr> <td>VOL.DOWN</td> <td>L</td> <td>H</td> </tr> </tbody> </table>			Terminal No.	24	25	VOL.UP	H	L	VOL.DOWN	L	H
Terminal No.	24			25											
VOL.UP	H	L													
VOL.DOWN	L	H													
25	DOWN														
26	SOURCE	O	When REC SEL. set at each position.	L	SURCE IND illuminates										
27	TUNER	O		L	TUNER IND illuminates										
28	DAT→T	O		L	DAT→T IND illuminates										

Terminal No.	Terminal name	I/O	Condition	Terminal status	Remarks												
29	TAPE→D	O	When REC SEL. set at each position.	L	TAPE→D IND. illuminates												
30	CD.D.REC	O	CD DIRECT REC "ON"	L	CD DIRECT IND illuminates												
31	NC	...	.....	.....													
32	V <sub>ss</sub>		GND														
33	MUT IND	O	MUTING "ON"	H	Red IND illuminates												
34	VR IND	O	Power supply "ON"	H	Yellow IND illuminates												
35	PURE DIRECT	O	LINE DIRECT	L													
36	XTAL	O	Connect Crystal resonator (4.19MHz)		CLOCK oscillating terminal (For A-X540, oscillation is made if necessary.)												
37	EXTAL	I															
38	RESET	I	When inputting RESET pulse														
39	PX <sub>0</sub> /SC	I	.....		GND.												
40	PX <sub>1</sub> /SOB	I	<table border="1"> <thead> <tr> <th>Model</th> <th>A-X540</th> <th>A-X440</th> <th>A-X340</th> </tr> </thead> <tbody> <tr> <td>40</td> <td>H</td> <td>L</td> <td>L</td> </tr> <tr> <td>41</td> <td>L</td> <td>H</td> <td>L</td> </tr> </tbody> </table>	Model	A-X540	A-X440	A-X340	40	H	L	L	41	L	H	L		By arranging the terminal levels of Pins 40 and 41 as shown in the table, the program can be adjusted to the each models.
Model	A-X540	A-X440		A-X340													
40	H	L		L													
41	L	H	L														
41	PX <sub>2</sub> /SOA	I															
42	PX <sub>3</sub> /SI	I	.....	.....	GND												
43	F•MUTE	O	When switching over FUNCTION, CD or DAT DIRECT.		Prevents click noise												
			During -∞ MUTING	H													
44	B.EQ CONT.	O	BASS EQ "ON"	H	Activates BASS EQ circuit												
45	PY <sub>2</sub> /WP	I	The IC601 (PDG022) is a "SUPERSILENT" micro computer which oscillates the CLOCK only when necessary (only A-X540). Therefore, this terminal will oscillate the CLOCK when the respective button on the front panel is pressed or when CLOCK oscillation is required. If, for example, a "H" signal is input when pressing the button, the terminal oscillates CLOCK and will determine the function. After the necessary actions, it stops CLOCK again and enters the STOP mode.														
46	REM IN	I															
47	ST-BY	O	Power supply "ON"	H	Relay (RY501) "ON"												
48	PROTECTION	O	Power supply "ON"	H	Controls relay for SP (RY401 and RY402) and relay for HP (RY403).												
			(7 seconds after power Supply ON.)	(L)													
49	SP-B	O	SP SELECTOR "SP-B"	H	Controls relay for SP-B (RY402).												
50	SP-A	O	SP SELECTOR "SP-A"	H	Controls relay for SP-A (RY401).												
51	PMO	O	.....	.....	Non used												
52	MUTING	O	During MUTING (-20dB)	H	ON/OFF of -20dB MUTING.												
53	D.OFF	O	LINE DIRECT "OFF"	L													

# A-X540

Terminal No.	Terminal name	I/O	Condition	Terminal status	Remarks
54	DAT.D	O	DAT DIRECT "ON"	L	
55	CD.D	O	CD DIRECT "ON"	L	
56	CK	O	When FUNCTION was changed.		For controlling FUNCTION.
57	DATA				
58	ST				
59	ST-BY IND	O	During STAND-BY.	L	STAND-BY IND illuminates
60	PJ <sub>0</sub>	I	For A-X540, when the control action is performed.		Key matrix input
61	PJ <sub>1</sub>				
62	PJ <sub>2</sub>				
63	PJ <sub>3</sub>				
64	V <sub>DD</sub>	...	.....		+5V Power supply terminal

## 7. SPECIFICATIONS

### A-X540

#### Amplifier Section

DIN continuous power output (both channels driven)	
1 kHz, 1%, 8Ω	100W + 100W
DIN music power (both channels driven)	
1 kHz, 1%, 8Ω	160W + 160W
Continuous power output (both channel driven)	
20 Hz to 20 kHz, T.H.D 0.3%, 8Ω	85W + 85W
IEC Continuous power output (both channel driven)	
63 Hz to 12.5 kHz, T.H.D 0.7%, 8Ω	95W + 95W
Total harmonic distortion *	
1 kHz, 50W, 8Ω	0.005% *
Input (sensitivity/impedance)	
PHONO	2.5 mV/50 kΩ
TUNER, CD, AUX, TAPE PLAY, DAT PLAY, ADAPTOR	150 mV/50 kΩ
Overload level	
PHONO 1 kHz, 0.1%	150 mV
Output level	
TAPE REC, DAT REC, ADAPTOR OUT	150 mV
Frequency Response	
PHONO	20 Hz to 20 kHz ±0.5 dB
TUNER, CD, AUX, TAPE PLAY, DAT PLAY, ADAPTOR	10 Hz to 100 kHz
	+1 dB
	-3 dB
CD (CD DIRECT ON)	10 Hz to 100 kHz
	+1 dB
	-3 dB
Tone Control	
BASS	±8 dB (100 Hz)
TREBLE	±8 dB (10 kHz)
BASS EQUALIZER	(MAX) +10 dB (60 Hz)
MUTING	-20 dB/-∞
Signal-to-Noise ratio (IHF short circuited, A network)	
PHONO	72 dB
CD (CD DIRECT ON)	102 dB
Signal-to-Noise ratio (DIN, continuous power/50 mW)	
PHONO	68 dB/60 dB
CD (CD DIRECT ON)	82 dB/62 dB
TUNER, CD, AUX, TAPE PLAY, DAT PLAY, ADAPTOR	82 dB/62 dB

#### Power Supply/Miscellaneous

Power requirements	
European model	AC220 V-, 50/60 Hz
U.K. model	AC240 V-, 50/60 Hz
Other destination models	-AC 110 V/120-127 V/ 220 V/240 V (switchable), 50/60 Hz
Power consumption	
European model	480W
U.K. model	480W
AC outlets	
U.K. model	
switched (× 3)	100W
Other destination models	
switched (× 2)	100W
Unswitched (× 1)	100W
Dimensions	360 (W) × 349 (D) × 115 (H) mm 14-1/8 (W) × 13-3/4 (D) × 4-1/2 (H) in
Weight	8.5 kg (18 lb 13 oz)

#### Accessories

Remote control unit	1
Batteries AAA/RO3	2
Operating instructions	1

- Specifications and design subject to possible modification without notice due to improvements.

\* Measured by Audio Spectrum Analyzer.

# A-X440, A-X340

## A-X440

### Amplifier Section

DIN continuous power output (both channels driven)	
1 kHz, 1%, 8 Ω	65 W + 65 W
DIN music power (both channels driven)	
1 kHz, 1%, 8 Ω	120 W + 120 W
Continuous power output (both channels driven)	
20 Hz to 20 kHz, T.H.D 0.3%, 8 Ω	55 W + 55 W
IEC continuous power output (both channels driven)	
63 Hz to 12.5 kHz, T.H.D 0.7%, 8 Ω	60 W + 60 W
Total harmonic distortion	
1 kHz, 35 W, 8 Ω	0.005% *
Input (sensitivity/impedance)	
PHONO	2.5 mV/50 kΩ
TUNER, CD, AUX, TAPE PLAY, DAT PLAY, ADAPTOR	150 mV/50 kΩ
Overload level	
PHONO 1 kHz, 0.1%	150 mV
Output (level/impedance)	
TAPE REC, DAT REC, ADAPTOR OUT	150 mV
Frequency Response	
PHONO	20 Hz to 20 kHz ±0.5 dB
TUNER, CD, AUX, TAPE PLAY, DAT PLAY, ADAPTOR	10 Hz to 70 kHz ± $\frac{1}{3}$ dB
CD (CD DIRECT ON)	10 Hz to 100 kHz ± $\frac{1}{3}$ dB
Tone Control	
BASS	±8 dB 100 Hz
TREBLE	±8 dB 10 kHz
BASS EQUALIZER	+10 dB (60 Hz)
MUTING	-20 dB/-∞
Signal-to-Noise ratio (IHF short circuited, A network)	
PHONO	72 dB
CD (CD DIRECT ON)	100 dB
Signal-to-Noise ratio (DIN, continuous power/50 mW)	
PHONO	68 dB/60 dB
TUNER, CD, AUX, TAPE PLAY, ADAPTOR	82 dB/62 dB
CD (CD DIRECT ON)	82 dB/62 dB

### Power Supply/Miscellaneous

Power requirements	
U.K., Australian models	~ AC 240 V, 50/60 Hz
Other destination models	~ AC 110 V/120 - 127 V/ 220 V/240 V (switchable), 50/60 Hz
Power consumption	
Other destination models	390 W
U.K., Australian models	390 W
AC outlets	
U.K. model	
Switched (× 3)	100 W
Other destination models	
Switched (× 2)	100 W
Unswitched (× 1)	100 W
Dimensions	360 (W) × 346 (D) × 115 (H) mm 14-3/16 (W) × 13-5/8 (D) × 4-9/16 (H) in
Weight	6.6 kg (14 lb 9 oz)

### Accessories

Operating instructions	1
Remote control unit	1
Batteries (AAA/R03)	2

- Specifications and design subject to possible modification without notice due to improvements.
- \*Measured by Audio Spectrum Analyzer.

## A-X340

### Amplifier Section

DIN continuous power output (both channels driven)	
1 kHz, 1%, 8 Ω	45 W + 45 W
DIN music power (both channels driven)	
1 kHz, 1%, 8 Ω	85 W + 85 W
Continuous power output (both channels driven)	
20 Hz to 20 kHz, T.H.D 0.5%, 8 Ω	30 W + 30 W
IEC continuous power output (both channels driven)	
63 Hz to 12.5 kHz T.H.D 0.7%, 8 Ω	40 W + 40 W
Total harmonic distortion	
1 kHz, 25 W, 8 Ω	0.005% *
Input (sensitivity/impedance)	
PHONO	2.5 mV/50 kΩ
TUNER, CD, AUX, TAPE PLAY, ADAPTOR	150 mV/50 kΩ
Overload level	
PHONO 1 kHz, 0.1%	150 mV
Output	
TAPE REC, ADAPTOR OUT	150 mV
Frequency Response	
PHONO	20 Hz to 20 kHz ±0.5 dB
TUNER, CD, AUX, TAPE PLAY, ADAPTOR	10 Hz to 100 kHz ± $\frac{1}{3}$ dB
CD (CD DIRECT ON)	10 Hz to 100 kHz ± $\frac{1}{3}$ dB
Tone Control	
BASS	±8 dB (100 Hz)
TREBLE	±8 dB (10 kHz)
BASS EQUALIZER	+8 dB (60 Hz)
MUTING	-20 dB/-∞
Signal-to-Noise ratio (IHF short circuited, A network)	
PHONO	72 dB
CD (CD DIRECT ON)	100 dB
Signal-to-Noise ratio (DIN, continuous power/50 mW)	
PHONO	68 dB/60 dB
TUNER, CD, AUX, TAPE PLAY, ADAPTOR	82 dB/62 dB
CD (CD DIRECT ON)	82 dB/62 dB

### Power Supply/Miscellaneous

Power requirements	
European model	~ AC 220 V, 50/60 Hz
U.K., Australian models	~ AC 240 V, 50/60 Hz
Power consumption	
European model	250 W
U.K., Australian models	250 W
AC outlets	
Switched (× 3)	100 W
Dimensions	360 (W) × 346 (D) × 115 (H) mm
Weight	5.9 kg

### Accessories

Operating instructions	1
Remote control unit	1
Batteries (AAA/R03)	2

- Specifications and design subject to possible modification without notice due to improvements.
- \*Measured by Audio Spectrum Analyzer.