

# Service Manual

**PIONEER**  
The future of sound and vision.

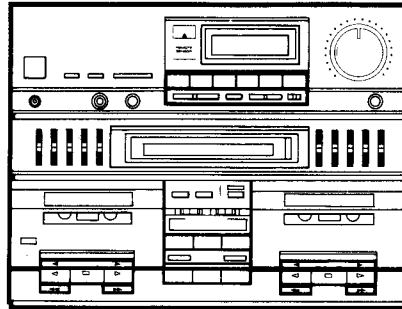

ORDER NO.  
ARP1484

STEREO DOUBLE CASSETTE TAPE DECK AMPLIFIER

# DC-Z91

DC-Z91 HAS FOUR VERSIONS :

TYPE	Power requirement	Export destination
HE	AC220V, 240V (switchable) *	European continent
HB	AC220V, 240V (switchable) *	United Kingdom
SD	AC110V, 120V-127V, 220V, 240V (switchable)	Kingdom of Saudi Arabia and general market
HEZ	AC220V, 240V (switchable) *	West Germany

\*Change the position of the fuse on the power supply assembly.

- This manual is applicable to the HE, HB, and SD types.
- For the HB and SD types, refer to pages 64-66.
- For the HEZ type, refer to the additional service manual (ARP1485).
- Ce manuel pour le service comprend les explications en français de réglage.
- Este manual de servicio trata del método ajuste escrito en español.

## CONTENTS

1. SPECIFICATIONS .....	2
2. PANEL FACILITIES .....	3
3. EXPLODED VIEWS AND PARTS LIST .....	7
4. PACKING .....	17
5. SCHEMATIC DIAGRAM .....	19
6. P.C. BOARDS CONNECTION DIAGRAM .....	27
7. ELECTRICAL PARTS LIST .....	43
8. ADJUSTMENTS .....	49
8. RÉGLAGES .....	54
8. AJUSTE .....	59
9. FOR HB AND SD TYPES .....	64

**PIONEER ELECTRONIC CORPORATION** 4-1, Meguro 1-Chome, Meguro-ku, Tokyo 153, Japan  
**PIONEER ELECTRONICS SERVICE INC.** P.O. Box 1760, Long Beach, California 90801 U.S.A.  
**PIONEER ELECTRONICS OF CANADA, INC.** 505 Cochrane Drive, Markham, Ontario L3R 8E3 Canada  
**PIONEER ELECTRONIC [EUROPE] N.V.** Keetberglaan 1, 2740 Beveren, Belgium  
**PIONEER ELECTRONICS AUSTRALIA PTY. LTD.** 178-184 Boundary Road, Braeside, Victoria 3195, Australia TEL: [03] 580-9911

# 1. SPECIFICATIONS

**Cassette tape deck amplifier: DC-Z91**

**AMPLIFIER SECTION**

Continuous Power Output  
 1 kHz (DIN)..... 60W + 60W (T.H.D. 1% 8 ohms)  
 1 kHz (DIN music power) ..... 90W + 90W  
 (T.H.D. 1% 8 ohms)

Graphic equalizer frequency band..... 100 Hz, 330 Hz,  
 1 kHz, 3,3 kHz, 10 kHz, ± 7 dB

Hum and Noise (IHF, short-circuited, A network)  
 PHONO ..... 72 dB

Hum and Noise (DIN continuous Power/50 mW)  
 PHONO ..... 68 dB/60 dB

Total Harmonic Distortion  
 (40 Hz to 20,000 Hz, 30W, 8 ohms)..... No more than 0.2%

**Tape Deck Section**

Systems ..... 4 track, 2-channel stereo

Heads ..... Recording/playback head x 1  
 Playback head x 1  
 Erasing head x 1

Motor..... DC servo 2 speed motor x 2

Wow and Flutter..... No more than 0.09% (WRMS)

Fast Winding Time ..... Approximately 95 seconds  
 (C-60 tape)

**Frequency Response**

- 20 dB recording:

Normal tape ..... 35 Hz to 14,000 Hz ± 6 dB

Cr O<sub>2</sub> ..... 35 Hz to 15,000 Hz ± 6 dB

Metal tape ..... 35 Hz to 16,000 Hz ± 6 dB

**Signal-to-noise Ratio**

Dolby NR OFF..... 56 dB

**Noise Reduction Effect**

Dolby B type NR ON ..... More than 10 dB (at 5 kHz)

**Furnished Parts**

Operating Instructions ..... 1

Remote control unit ..... 1

Dry cell batteries ..... 2

**Miscellaneous**

Power requirements ..... a.c. 220 Volts ~, 50/60 Hz

Power Consumption ..... 480 W

Dimensions ..... 360 (W) x 271 (H) x 332 (D) mm

Weight (without package) ..... 10 kg

• **CONNECTION DIAGRAM**

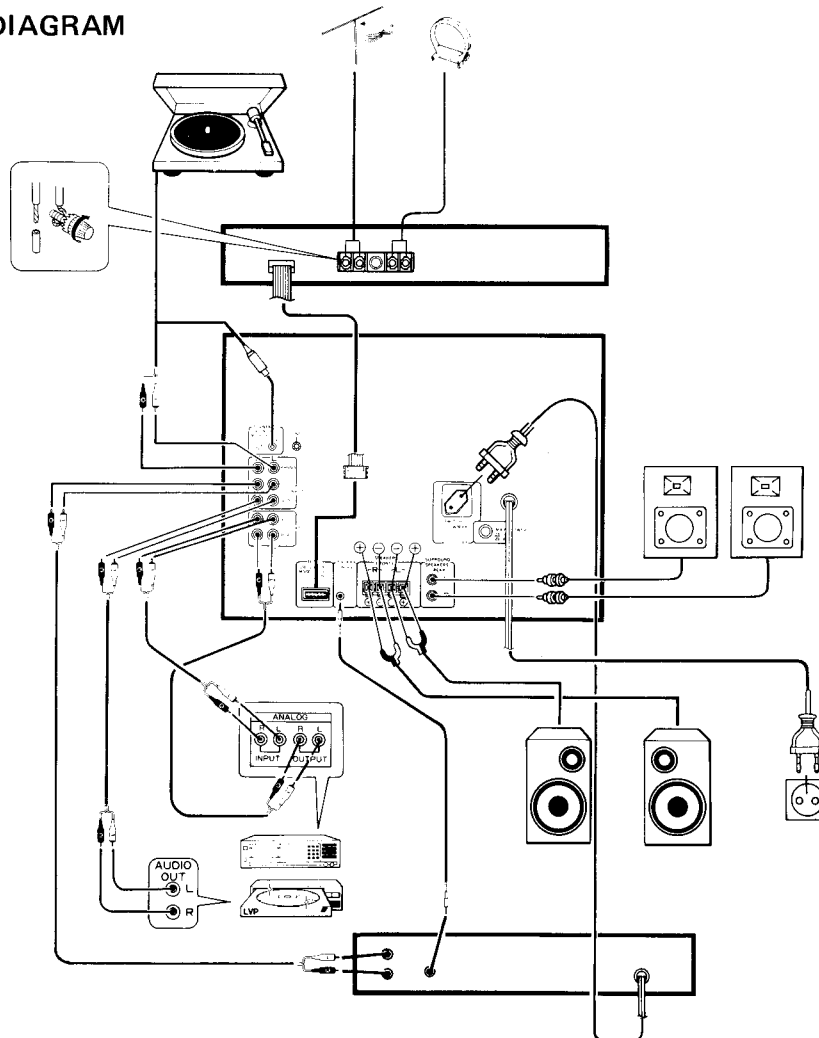

## 2. PANEL FACILITIES

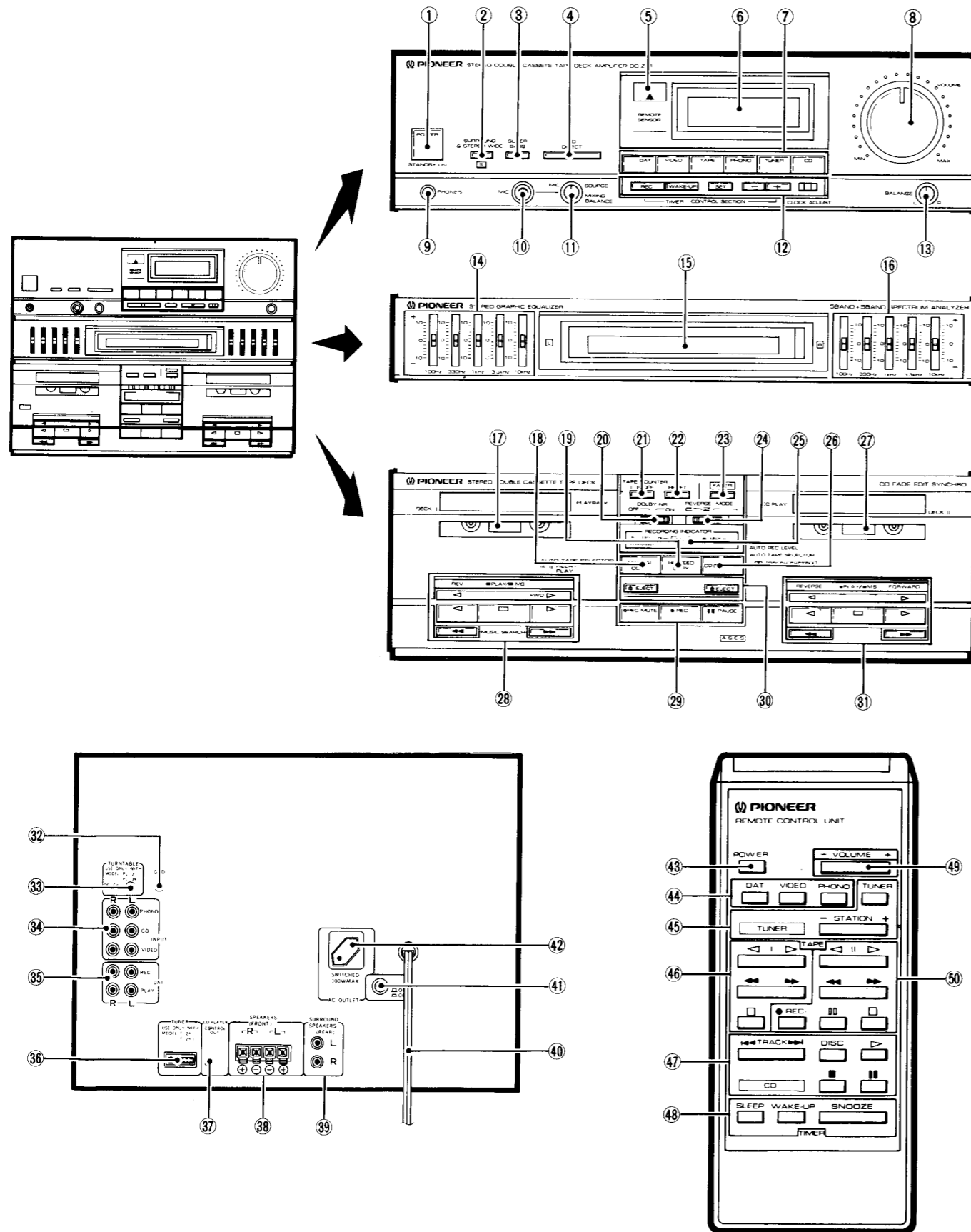

### Cassette deck amplifier DC-Z91

- This unit is provided with an automatic tape selector function.
- Tapes can be played back on deck I; tapes can be played back and recorded on deck II.
- Sound can be recorded with the quality which has been adjusted by the graphic equalizer.

#### Amplifier section

##### ① POWER STANDBY/ON switch

When this switch is pressed power is supplied to the unit. Press the switch again to turn power standby.

##### ② SURROUND & STEREO WIDE switch/indicator

When surround speaker systems are connected to the SURROUND SPEAKERS jacks at the rear:

By turning this switch ON, you can enjoy surround reproduction.

When surround speaker systems are not connected: By turning this switch ON, you can enjoy STEREO WIDE reproduction with greater left-right spread.

#### NOTE:

*In the case of a monaural source, a SURROUND/STEREO WIDE effect cannot be obtained.*

##### ③ SUPER BASS switch

Press this switch to further emphasize the low bass.

##### ④ CD DIRECT switch

Press this switch to listen to the CD without passing the signals through the sound quality adjustment circuit.

##### ⑤ REMOTE SENSOR window

##### ⑥ OPERATING INDICATOR

This displays the various operating modes and the time.

##### ⑦ FUNCTION switches

#### [DAT]

Press when listening to a Digital Audio Tape deck connected to the DAT jacks.

#### [VIDEO]

Press when listening to a stereo component connected to the VIDEO jacks.

#### [TAPE]

Press when listening to a cassette tape.

#### [PHONO]

Press when playing records on a turntable connected to the PHONO jacks.

#### [TUNER]

Press when listening to a radio broadcast.

#### [CD]

Press when listening to a CD player connected to the CD jacks.

##### ⑧ VOLUME control

##### ⑨ Headphone jack (PHONES)

For miniature stereo phone plug.

##### ⑩ MIC jack

This is a standard jack for connecting the microphone.

##### ⑪ MIXING control

This is used to adjust the proportion of the microphone volume and volume of the other sound source for mixing.

##### ⑫ TIMER CONTROL FUNCTION switches

Use these switches for setting the times for timer playback and recording.

#### [REC]

Used for setting time for timer recording.

#### [WAKE UP]

Used for setting time for timer playback.

#### [SET]

Used for continuing on to next operation when setting the time or timer.

#### [-, +]

Used for decreasing (-) or increasing (+) the values when setting the time or timer.

#### [CLOCK ADJ]

Used for setting the current time.

##### ⑬ BALANCE control

Usually set this control to the central position. If turned counterclockwise, the volume of the right channel will decrease.

If turned clockwise, the volume of the left channel will decrease.

#### Graphic Equalizer section

##### ⑭, ⑮ Graphic equalizer controls (GRAPHIC EQUALIZER)

Fine adjustments in sound quality are possible using the 5 controls on the graphic equalizer. The controls on the left side are for the left channel, those on the right side for the right channel.

##### ⑯ SPECTRUM ANALYZER

**Cassette Tape Deck Section**

**17 Cassette door (Deck I)**

**18 NORMAL COPY switch**

Permits you to listen to playback normally during dubbing (normal speed copying).

**19 HI-SPEED COPY switch**

High speed dubbing (double-speed, half-time copying).

**20 DOLBY NR switch**

Set this switch to the ON position to activate the noise reduction system.

- Tapes recorded using Dolby noise reduction should always be played back with the noise reduction system on. Sound quality will be adversely affected if they are played back with the system off, or if tapes recorded using a different noise reduction system are played back with the Dolby NR system on.
- It is recommended that tapes recorded using Dolby B NR be so marked on the label. This will help to prevent incorrect setting of the noise reduction switch during playback.

Dolby noise reduction manufactured under license from Dolby Laboratories Licensing Corporation.

"DOLBY" and the double-D symbol  are trademarks of Dolby Laboratories Licensing Corporation.

**21 COUNTER I/II/OFF switch**

Press this switch to switch the tape counter display between deck I, deck II and off (time).

**22 RESET switch**

Press this switch to reset the tape counter display to 0000.

**23 FADER switch**

This switch is used to gradually fade out a recorded loaded tape in deck II. (The sound will be completely cut off after approximately 10 seconds and the tape will stop.)

**24 REVERSE MODE switch**

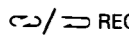
Switch position	During playback	During recording
RELAY PLAY	Deck I ↔ Deck II	—
	Single-side playback	Single-sided recording
 REC	Continuous playback *	Double-sided recording

\* 6 round trips

**25 REC INDICATOR**

This lights when recording, and flashes when copying a tape.

- Slow flashing..... Normal copy
- Rapid flashing..... High speed copy

**26 CD FADE EDIT switch**

Use this for synchro-copying from a CD onto a tape. The sound will fade out at the end of the tape.

**27 Cassette door (Deck II)**

**28 Deck I Operation switches/indicators**

▷ **PLAY (FWD)**..... For playing back a tape in the forward mode.

◁ **PLAY (REV)**..... For playing back a tape in the reverse mode.

□ **STOP**..... For stopping the tape.

▶▶ **FAST**..... Fast forward in forward mode, rewind in reverse mode.

◀◀ **FAST**..... Rewind in forward mode, fast forward in reverse mode.

◁, ▷ **indicators**..... These light during playback, and flash during the music search operation.

**29 Deck II Operation switches**

● **REC MUTE**..... For creating the blanks between tape programs.

● **REC**..... Set to recording standby mode.

■ **PAUSE**..... Temporarily stops tape travel. Cancels pause mode when pressed again or press the PLAY switch.

**30 EJECT buttons**

Push to open the cassette door.

**31 Deck II Operation switches/indicators**

▷ **PLAY (FWD)**..... For playing back a tape in the forward mode.

◁ **PLAY (REV)**..... For playing back a tape in the reverse mode.

□ **STOP**..... For stopping the tape run.

▶▶ **FAST**..... Fast forward in forward mode, rewind in reverse mode.

◀◀ **FAST**..... Rewind in forward mode, fast forward in reverse mode.

◁, ▷ **indicators**..... These light during playback, and flash during the music search operation.

**Rear panel**

**32 Ground terminal (GND)**

Connect this to the ground terminal on the turntable (except for PL-Z91 and PL-Z81).

**33 TURNTABLE OUTPUT jack**

This jack supplies power to the PL-Z81 or PL-Z91.

**34 INPUT jacks**

**PHONO:** Connect the output cord on the turntable to these jacks.

**CD:** Connect the output cord on the compact disc player to these jacks.

**VIDEO:** Connect the audio output cord of the LaserVision player (Video disc player) or hi-fi VCR to these jacks.

**35 DAT jacks**

Use these jacks to connect a digital audio tape deck (DAT) or other stereo component.

**REC:** Connect to the analog audio input terminals of the DAT.

**PLAY:** Connect to the analog audio output terminals of the DAT.

**36 TUNER jacks**

Connect the F-Z91 (L) FM/AM tuner.

**37 CD PLAYER CONTROL OUT jack**

Connect this jack to the CONTROL IN jack of a CD player with  mark.

- This jack enables the remote control unit provided with the deck amplifier to exercise central control over the CD player. It also enables synchronized recording of CDs (for the PD-Z71 and PD-Z81M only).

**38 SPEAKERS terminals**

**L:** Connect the left speaker system as seen from the listening position.

**R:** Connect the right speaker system as seen from the listening position.

**NOTE:**

Connect a speaker system having a nominal impedance ranging from 6 ohms to 16 ohms.

**Remote control unit**

**43 POWER key**

**44 Function keys**

**DAT**..... Sets function to DAT.

**VIDEO**..... Sets function to VIDEO.

**PHONO**..... Sets function to PHONO.

**45 Tuner operation keys**

**TUNER**..... Sets function to TUNER.

**STATION**

• Preset the stations before operating.

+ ... Stations change in order in the upward direction

- ... Stations change in order in the downward direction.

**46 DECK I keys**

▷..... Forward play key

◁..... Reverse play key

□..... Stop key

▶▶..... Fast key

◀◀..... Fast key

**47 CD keys**

Perform the connections so that the CD player is operated by the remote control unit.

▷..... Play key

**DISC**..... DISC selector key (only Multi-play CD player)

■..... STOP key

■..... PAUSE key

◀▶, ▶▶..... TRACK search key

**39 SURROUND SPEAKERS terminals**

Connect the Surround speaker systems

**NOTE:**

Connect a speaker system having a nominal impedance 16 ohms.

**40 Power cord**

Connect this to the AC wall socket.

**41 MAIN POWER switch**

**[ON]** ■

While this unit is in a standby status and the power cord is connected to the wall socket, the circuit of the unit will operated continuously. When not using the unit for a long period, either switch the unit OFF, or remove the power cord from the power socket.

**[OFF]** ■

When the switch is OFF, the power to the unit will be cut off.

**42 AC OUTLET (SWITCHED)**

Power supplied through these outlets is turned on and off by the deck amplifier's POWER switch. Total electrical power consumption of connected equipment should not exceed 100 W.

**NOTE:**

Do not connect appliances with high power consumption such as heaters, irons, or television sets to the AC OUTLET in order to avoid overheating or fire risk.

This can cause this equipment to malfunction.

**NOTE:**

Note that the DISC selector key on the accessory remote control unit may not function, depending on the CD player used.

**48 Timer operation keys**

**SLEEP**..... This key is used to set the sleep timer. The minutes change from 90 to 60 to 30 to 00 each time the key is pressed.

**WAKE UP**..... This key is used to set the timer. It can be used in the same way as the WAKE UP button on the deck amplifier.

**SNOOZE**..... When this key is pressed after timer playback begins, playback will be interrupted momentarily then start again after approximately 5 minutes.

**49 VOLUME up/down key**

**50 DECK II keys**

▷..... Forward play key

◁..... Reverse play key

▶▶..... Fast key

◀◀..... Fast key

□..... Stop key

■..... Pause key

●..... REC key



### 3. EXPLODED VIEWS AND PARTS LIST

NOTES :

- Parts without part number cannot be supplied.
- The  $\Delta$  mark found on some component parts indicates the importance of the safety factor of the part. Therefore, when replacing, be sure to use parts of identical designation.
- For your parts Stock Control, the fast moving items are indicated with the marks  $\star\star$  and  $\star$ .  
 $\star\star$  GENERALLY MOVES FASTER THAN  $\star$ .
- This classification shall be adjusted by each distributor because it depends on model number, temperature, humidity, etc.
- Parts marked by "©" are not always kept in stock. Their delivery time may be longer than usual or they may be unavailable.

#### 3.1 Parts List of Exterior

Mark	No.	Part No.	Description	Mark	No.	Part No.	Description
	1	AWM1087	AF assembly		46	BBZ26P120FMC	Screw
	2	AWZ1732	CONTROL assembly		47	.....	.....
	3	AWZ1742	DISPLAY assembly	$\Delta\star\star$	48	AEK-042	FU6, FU7 Fuse (T3.15A/250V)
$\Delta$	4	AWZ1740	POWER assembly		101		SW-1 assembly
$\Delta\star$	5	ATS1120	Power transformer (T1)		102		SW-2 assembly
$\Delta$	6	AKP1024	AC Socket (AC OUTLET)		103		SW-3 assembly
$\Delta\star\star$	7	AEK-405	FU4, FU5 Fuse (T1.6A/250V)		104		VOLUME assembly
$\Delta\star\star$	8	AEK-017	FU1 Fuse (T2A/250V)		105		MIC, H.P assembly
$\Delta\star\star$	9	AEK-405	FU2 Fuse (T1.6A/250V)		106		SUPER BASS assembly
	10	AMR1295	Eject lever 1	$\Delta$	107		CONNECT assembly
	11	AMR1296	Eject lever 2	$\Delta$	108		POWER SUPPLY assembly
	12	AXA1005	Damper assembly		109		Terminal (GND)
	13	AAB1053	Knob assembly (VOLUME)		110	AWY1023	Mechanism unit 1
	14	AMB1298	Front panel assembly	SI-A44001	111	AWY1024	Mechanism unit 2
	15	AAB1050	Knob (BALANCE)		112		Chassis
	16	AAD-015	Push knob		113		Rear panel
	17	AAD1306	Button (EJECT)		114		Bottom plate
	18	AAE1080	Slide knob		115		Holder A
	19	AAK1410	Cassette plate		116		Holder B
	20	AAK1411	Cassette plate		117		Holder C
	21	AAK1412	Deck panel		118		Holder D
	22	AAK1413	Half pocket panel		119		PCB holder
	23	AAK1418	Amp. panel		120		Shield plate
	24	AAK1415	GE plate	SI-A44020	121	ABK1003	Keep plate
	25	AAK1416	FL filter		122		Gromet
	26	AAK1417	FL filter		123		PCB holder
	27	AAN1064	Half pocket		124		.....
	28	AAN1063	Half pocket		125		Mounting plate
	29	AEC1096	Hole cover		126		Ground lead
	30	AZN1452	Bonnet case		127		Holder E
	31	AAX1054	Fluorescent sheet		128		PCB spacer
	32	ABH1050	Spring 1		129		MUTE assembly
	33	ABH1051	Spring 2		130		.....
	34	AEC-847	Leg assembly		131		Heat sink holder
$\Delta$	35	ADG1021	AC power cord		132		.....
	36	BBZ26P080FMC	Screw		133		Shield plate
	37	BBZ30P080FZK	Screw				
	38	NK90FUC	Nut				
	39	VBZ30P060FMC	Screw				
	40	VBZ30P250FMC	Screw				
	41	VPZ30P060FZK	Screw				
	42	VPZ30P080FMC	Screw				
	43	VPZ30P080FZK	Screw				
	44	VBZ30P100FMC	Screw				
	45	CBZ30P080FMC	Screw				

Exterior

A

B

C

D

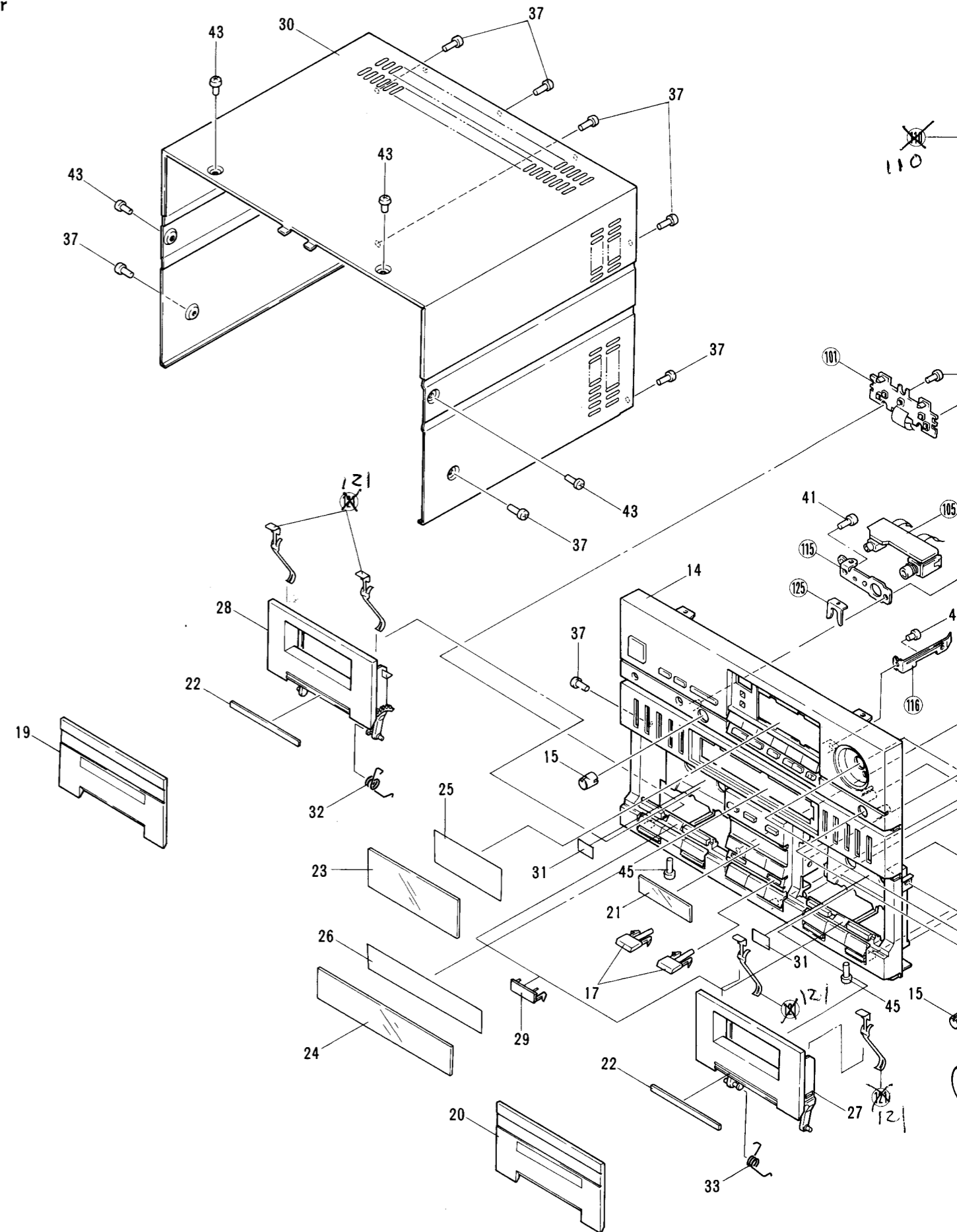

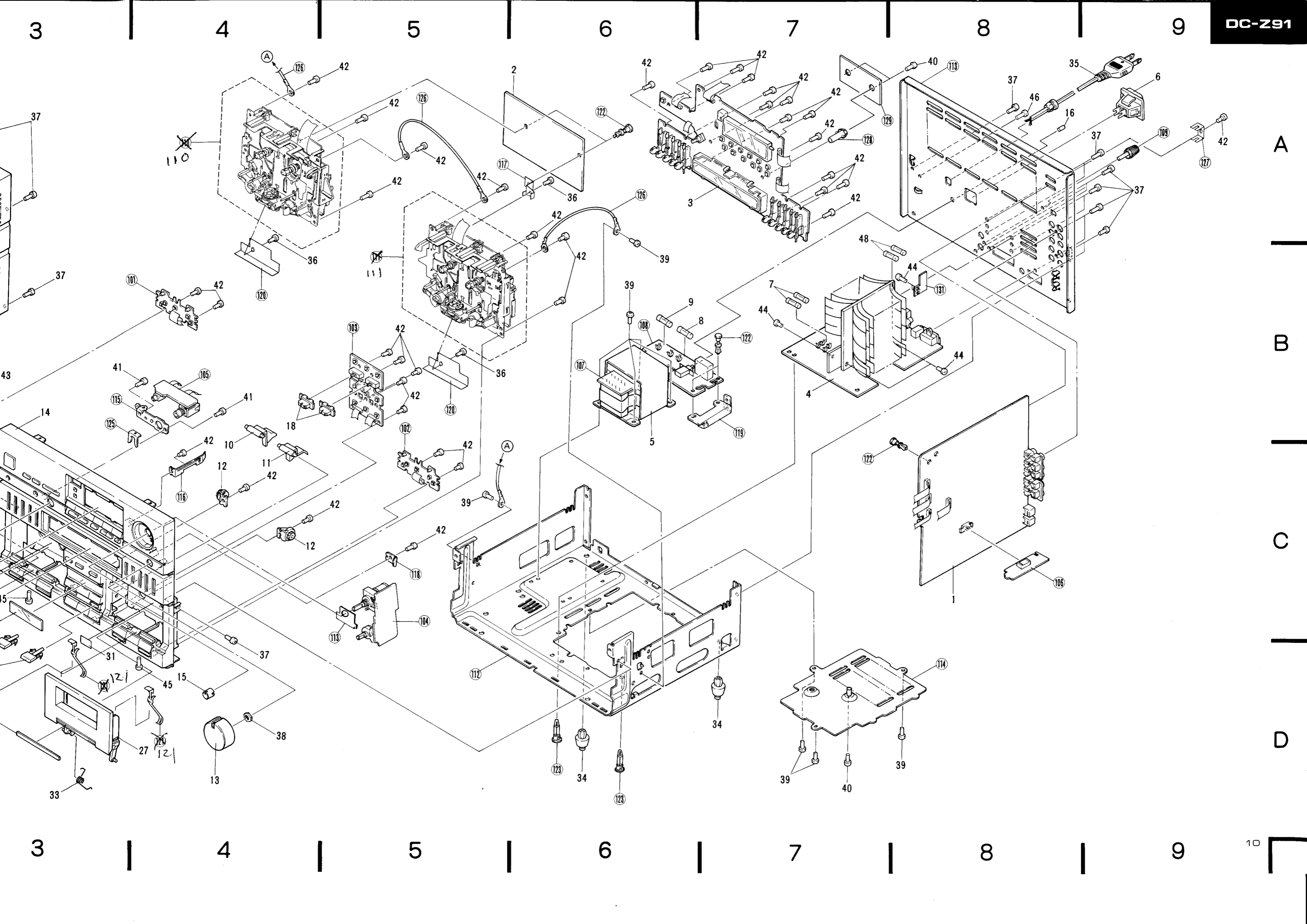

A

B

C

D

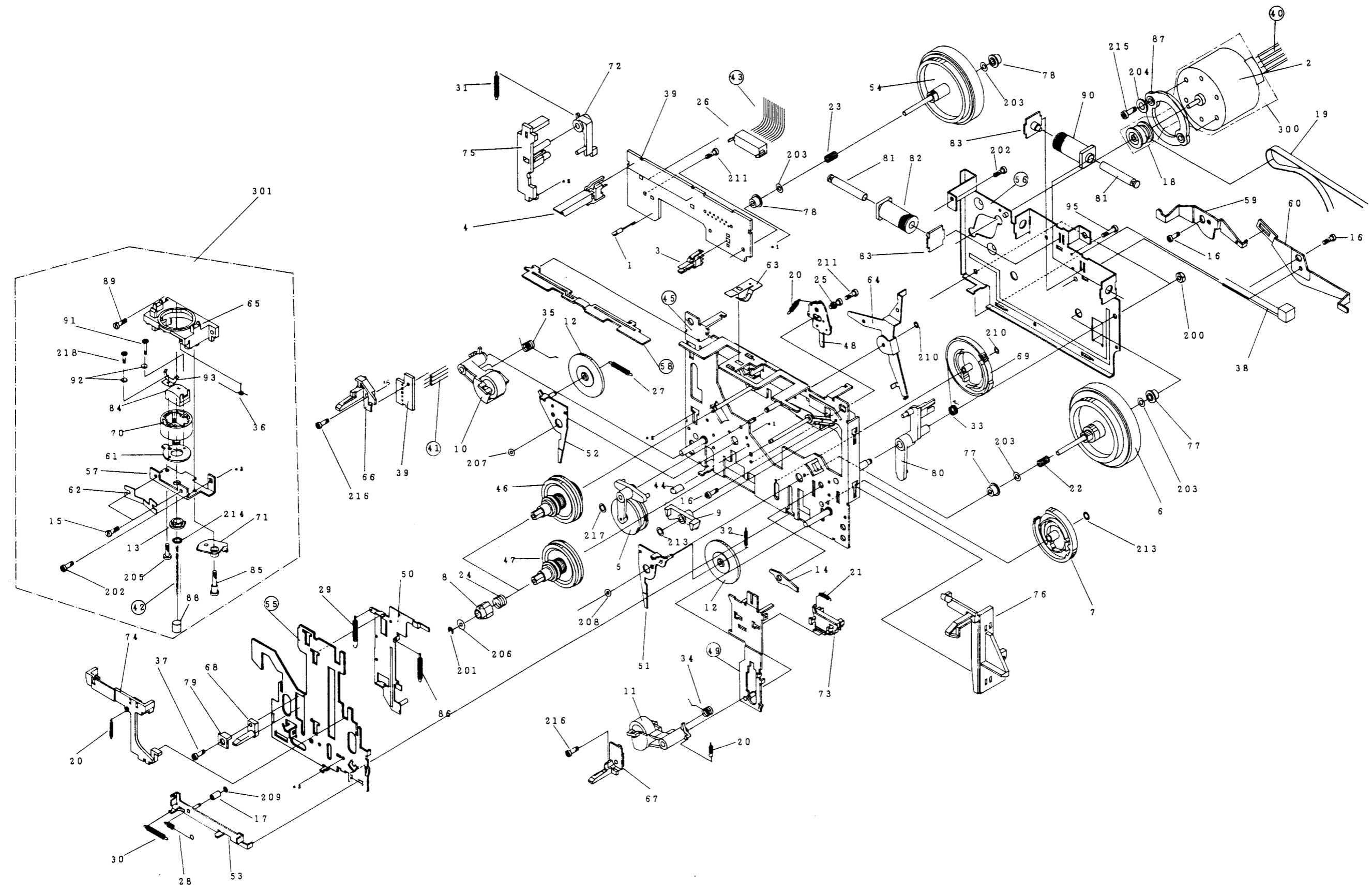

3.2 Parts List

Mark	No.	Part
★★	1	AZE101
★★	2	AZX101
★★	3	AZS105
★★	4	AZS103
★★	5	AZN128
	6	AZN128
	7	AZN128
	8	AZN128
	9	AZN129
	10	AZN129
	11	AZN129
	12	AZN129
	13	AZN129
	14	AZN129
	15	AZB107
	16	AZB108
	17	AZN129
★★	18	AZN129
★★	19	AZN129
	20	AZN129
	21	AZN130
	22	AZN130
	23	AZN130
	24	AZN130
	25	AZB108
	26	AZN146
	27	AZN130
	28	AZN130
	29	AZN130
	30	AZN130
	31	AZN147
	32	AZN131
	33	AZN131
	34	AZN131
	35	AZN131
	36	AZN131
	37	AZB108
	38	AZN131
	39	AZN147
	40	
	41	
	42	
	43	
	44	AZN146
	45	
	46	AZN131
	47	AZN131
	48	AZN131
	49	
	50	AZN131
	51	AZN131
	52	AZN131
	53	AZN131
	54	AZN131
	55	

### 3.2 Parts List of Mechanism Unit I, II

Mark	No.	Part No.	Description	Mark	No.	Part No.	Description	Mark	No.	Part No.	Description		
A	★★	1	AZE1018	Hall IC		56	Fly wheel plate			200	AZB1084	Hex nut	
	★★	2	AZX1019	Motor		57	AZN1328	Azimuth plate			201	AZB1085	E-ring
	★★	3	AZS1054	Leaf switch (MODE)		58		Switch arm			202	AZB1086	Screw
	★★	4	AZS1034	Leaf switch (CrO <sub>2</sub> )		59	AZN1356	Eject arm L			203	AZB1121	Washer
		5	AZN1286	Driving arm assembly		60	AZN1357	Eject arm R			204	AZB1087	Washer
		6	AZN1287	FW assembly A		61	AZN1330	Head arm			205	AZB1089	Screw
		7	AZN1288	Cam gear		62	AZN1331	P azimuth spring			206	AZB1090	Washer
		8	AZN1289	Reel claw		63	AZN1332	Cassette stopper			207	AZB1091	Oil cut
		9	AZN1290	FR arm		64	AZN1333	Play trigger assembly			208	AZB1092	Oil cut
		10	<del>AZN1291</del> <del>AZN1297</del>	Play arm assembly L		65	AZN1334	Head base			209	AZB1093	Washer
		11	<del>AZN1292</del> <del>AZN1298</del>	Play arm assembly R		66	AZN1335	Cassette guide L			210	AZB1094	Washer
		12	AZN1293	Gear		67	AZN1336	Cassette guide R			211	AZB1095	Screw
		13	AZN1294	H gear		68	AZN1337	Cassette guide			212		.....
		14	<del>AZN1295</del> <del>AZN1293</del>	CUE arm		69	AZN1338	Cam gear			213	AZB1097	Washer
		15	AZB1079	Screw		70	AZN1469	Head holder			214	AZB1098	Washer
B		16	AZB1080	Screw		71	AZN1340	Head gear			215	AZB1105	Screw
		17	AZN1296	Collar C		72	AZN1341	Eject arm			216	AZB1106	Screw
	★★	18	AZN1297	Motor pully		73	AZN1342	Select lever			217	AZB1107	Washer
	★★	19	AZN1298	Belt		74	AZN1343	Brake			218	AZB1164	Screw
		20	AZN1299	Spring		75	AZN1344	Eject lever L					
		21	AZN1300	FR lever spring		76	AZN1345	Latch lever R (Unit I only)	★★	300	AZX1020	Motor assembly	
		22	AZN1301	FWF spring			AZN1353	Latch lever L (Unit II only)	★★	301	AZP1023	Head base assembly (Unit I only)	
		23	AZN1302	FWR spring		77	AZN1346	Collar					
		24	AZN1303	Spring		78	AZN1347	Collar					
		25	AZB1088	Collar		79	AZN1348	Cushion					AZP1016 Head base assembly (Unit II only)
		26	AZN1467	Cable holder		80	AZN1349	Trigger arm					
		27	AZN1306	Spring		81	AZN1350	Planger					
		28	AZN1307	Spring		82	AZS1035	Bobbin					
		29	AZN1308	Spring		83	AZN1351	Solenoid plate assembly					
		30	AZN1309	Spring	★★	84	AZP1022	PLAY head (Unit I only)					
	31	<del>AZN1474</del> <del>AZN1310</del>	Spring			AZP1014	REC/PLAY/ERASE head (Unit II only)						
	32	AZN1311	Spring										
	33	AZN1312	Spring		85	AZB1099	Screw						
	34	AZN1313	Spring		86	AZN1352	Spring						
	35	<del>AZN1314</del> <del>AZN1315</del>	Spring		87	AZN1304	Spacer						
	36	AZN1315	Spring		88	AZN1470	Tube						
	37	AZB1081	Screw		89	AZB1100	Screw						
	38	AZN1316	Nylon band		90	AZS1036	Bobbin						
	39	AZN1472	P plate		91	AZB1101	Screw						
	40		Jnmpcr wires		92	AZB1102	Spring washer						
	41		Head lead wires		93	AZN1471	Head spring (Unit I only)						
	42		Lead wire										
	43		Lead wire	★	94	1S2473	Diode (Unit II only)						
	44	AZN1468	Tube		95	AZB1104	Screw						
	45		Chasiss										
	46	AZN1319	REV reel assembly										
	47	AZN1320	FWD reel assembly										
	48	AZN1321	REV arm assembly										
	49		FR lever assembly										
	50	AZN1323	Play lever assembly										
D	51	AZN1324	Gear arm assembly R										
	52	AZN1325	Gear arm assembly L										
	53	AZN1326	Head lever assembly										
	54	AZN1327	FW assembly										
	55		Head chasiss										

166  
**ADDITIONAL**

 **PIONEER®**  
The future of sound and vision.

# Service Manual

**ORDER NO.**  
**ARP1485**

STEREO DOUBLE CASSETTE TAPE DECK AMPLIFIER

# DC-Z91 HEZ

- Refer to the service manual ARP1484, DC-Z91.
- This manual is applicable to the HEZ type.

## 1. CONTRAST OF MISCELLANEOUS PARTS

### NOTES:

- Parts without part number cannot be supplied.
- The  $\Delta$  mark found on some component parts indicates the importance of the safety factor of the part. Therefore, when replacing, be sure to use parts of identical designation.
- For your parts Stock Control, the fast moving items are indicated with the marks **★★** and **★**.  
**★★ GENERALLY MOVES FASTER THAN ★.**  
This classification shall be adjusted by each distributor because it depends on model number, temperature, humidity, etc.
- Parts marked by "⊙" are not always kept in stock. Their delivery time may be longer than usual or they may be unavailable.

The DC-Z91/HEZ type is the same as the DC-Z91/HE type with the exception of the following sections.

Mark	Symbol & Description	Part No.		Remarks
		DC-Z91/ HE type	DC-Z91/ HEZ type	
$\Delta$	AF assembly	AWM1087	AWM1116	
	POWER assembly	AWZ1740	AWZ1922	
	MIC, H.P assembly	Non supply	Non supply	
	AC power cord	ADG1021	ADG1010	
	Operating instructions (Spanish-auxiliary)	ARC1073	ARC1082	
	Operating instructions (English, German, French, Italian)	ARE1068	.....	
	Screw	.....	ABA-115	For heat sink holder

**PIONEER ELECTRONIC CORPORATION** 4-1, Meguro 1-Chome, Meguro-ku, Tokyo 153, Japan  
**PIONEER ELECTRONICS SERVICE INC.** P.O. Box 1760, Long Beach, California 90801 U.S.A.  
**PIONEER ELECTRONICS OF CANADA, INC.** 505 Cochrane Drive, Markham, Ontario L3R 8E3 Canada  
**PIONEER ELECTRONIC [EUROPE] N.V.** Keetberglaan 1, 2740 Beveren, Belgium  
**PIONEER ELECTRONICS AUSTRALIA PTY. LTD.** 178-184 Boundary Road, Braeside, Victoria 3195, Australia TEL: [03] 580-9911

SI © APR. 1988 Printed in Japan

**AF ASSEMBLY (AWM1116)**

The AF assembly (AWM1116) is the same as the AF assembly (AWM1087) with the exception of the following sections.

Mark	Symbol & Description	Part No.		Remarks
		AWM1087 HE type	AWM1116 HEZ type	
	C201-C216 C217, C218 R221, R222	..... ..... RD 1/8 PM102J	CKMYB391K50 CKMYB102K50 RD 1/8 PM222J	

**POWER ASSEMBLY (AWZ1922)**

The power assembly (AWZ1922) is the same as the power assembly (AWZ1740) with the exception of the following sections.

Mark	Symbol & Description	Part No.		Remarks
		AWZ1740 HE type	AWZ1922 HEZ type	
	C126, C131, C132 C127-C130 C169, C194 C192, C193, C197-C199 C196 (0.01 μ F/150V)  C180 L101, L102 AF choke coil (1 μ H) L101-L104 AF choke coil (5.6 μ H)  R127, R128 R181, R182	..... ..... ..... ..... .....  CKCYF103Z50 ATH-133  .....  RD 1/4 PMFL100J .....	CKDYX473M25 CKMYB391K50 CKDYF473Z50 CKDYB103K50 ACG1005  CKDYF473Z50 ..... ATH-059  RD 1/4 PMFL101J RD 1/4 PMF101J	

**MIC, H.P ASSEMBLY**

The MIC, H.P assembly (for HEZ type) is the same as the MIC, H.P assembly (for HE type) with the exception of the following sections.

Mark	Symbol & Description	Part No.		Remarks
		HE type	HEZ type	
	C921 C929, C930 C933 C935 C936  R933	CKDYB681K50 CKMYB102K50 ..... ..... .....  .....	CKDYB102K50 CKDYF473Z50 CKDYF473Z50 CKDYB472K50 CKDYB102K50  RD 1/8 PM102J	

# 2. SCHEMATIC DIAGRAM

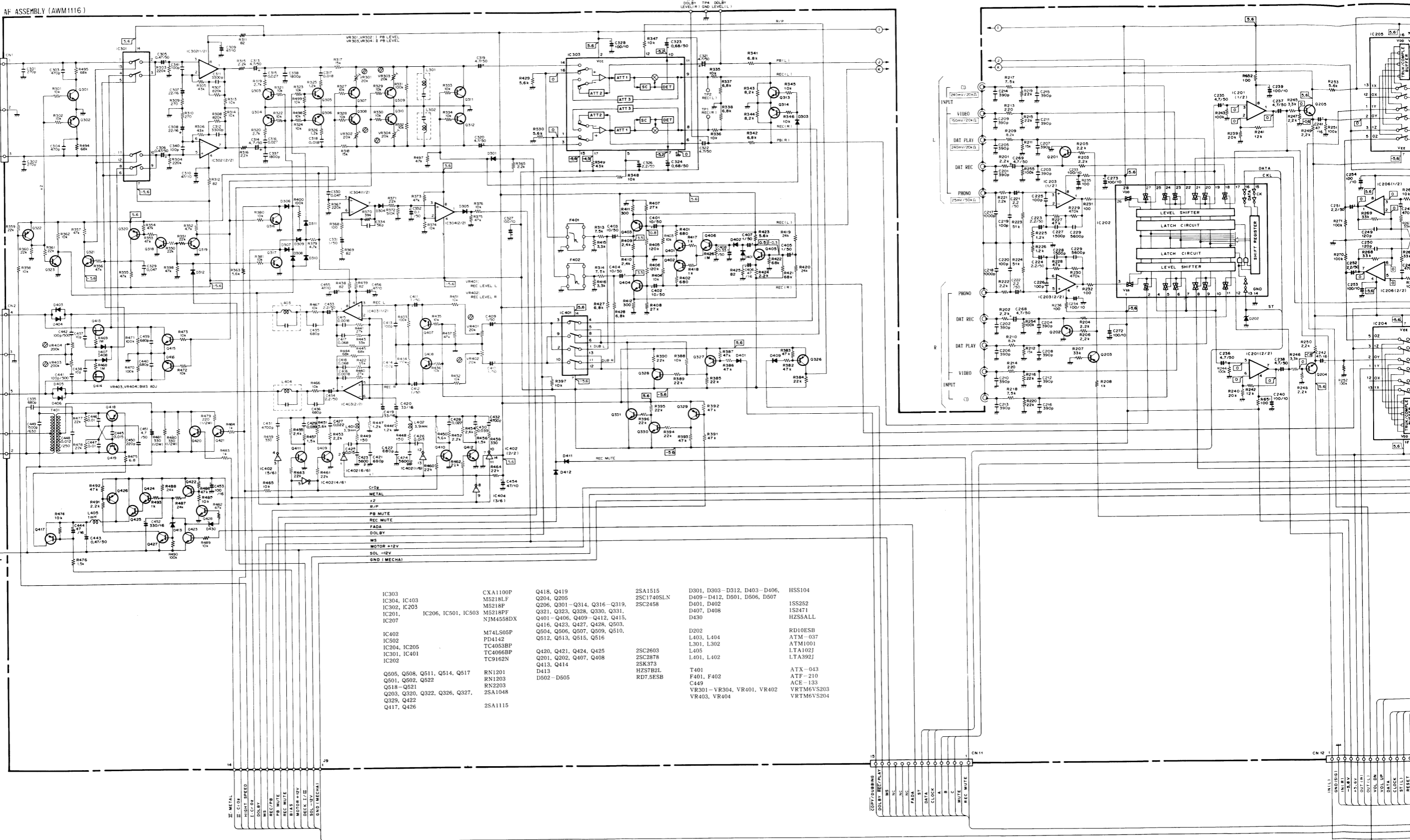

- |                               |           |                                 |            |                                 |            |
|-------------------------------|-----------|---------------------------------|------------|---------------------------------|------------|
| IC303                         | CXA1100P  | Q418, Q419                      | 2SA1515    | D301, D303 - D312, D403 - D406, | HSS104     |
| IC304, IC403                  | M5218LF   | Q204, Q205                      | 2SC1740SLN | D409 - D412, D501, D506, D507   | ISS252     |
| IC302, IC203                  | M5218P    | Q206, Q301 - Q314, Q316 - Q319, | 2SC2458    | D401, D402                      | IS2471     |
| IC201,                        | M5218PF   | Q321, Q323, Q328, Q330, Q331,   |            | D407, D408                      | HZ5SALL    |
| IC207                         | NJM4558DX | Q401 - Q406, Q409 - Q412, Q415, |            | D430                            |            |
|                               |           | Q416, Q423, Q427, Q428, Q503,   |            |                                 |            |
| IC402                         | M74LS05P  | Q504, Q506, Q507, Q509, Q510,   |            | D202                            | RD10ESB    |
| IC502                         | PD4142    | Q512, Q513, Q515, Q516          |            | L403, L404                      | ATM - 037  |
| IC204, IC205                  | TC4053BP  |                                 |            | L301, L302                      | ATM1001    |
| IC301, IC401                  | TC4066BP  | Q420, Q421, Q424, Q425          | 2SC2603    | L405                            | LTA102J    |
| IC202                         | TC9162N   | Q201, Q202, Q407, Q408          | 2SC2878    | L401, L402                      | LTA392J    |
|                               |           | Q413, Q414                      | 2SK373     |                                 |            |
| Q505, Q508, Q511, Q514, Q517  | RN1201    | D413                            | HZ57B2L    | T401                            | ATX - 043  |
| Q501, Q502, Q522              | RN1203    | D502 - D505                     | RD7.5ESB   | F401, F402                      | ATF - 210  |
| Q518 - Q521                   | RN2203    |                                 |            | C449                            | ACE - 133  |
| Q203, Q320, Q322, Q326, Q327, | 2SA1048   |                                 |            | VR301 - VR304, VR401, VR402     | VRTM6VS203 |
| Q329, Q422                    |           |                                 |            | VR403, VR404                    | VRTM6VS204 |
| Q417, Q426                    | 2SA1115   |                                 |            |                                 |            |





DISPLAY ASSEMBLY (AWZ1742)

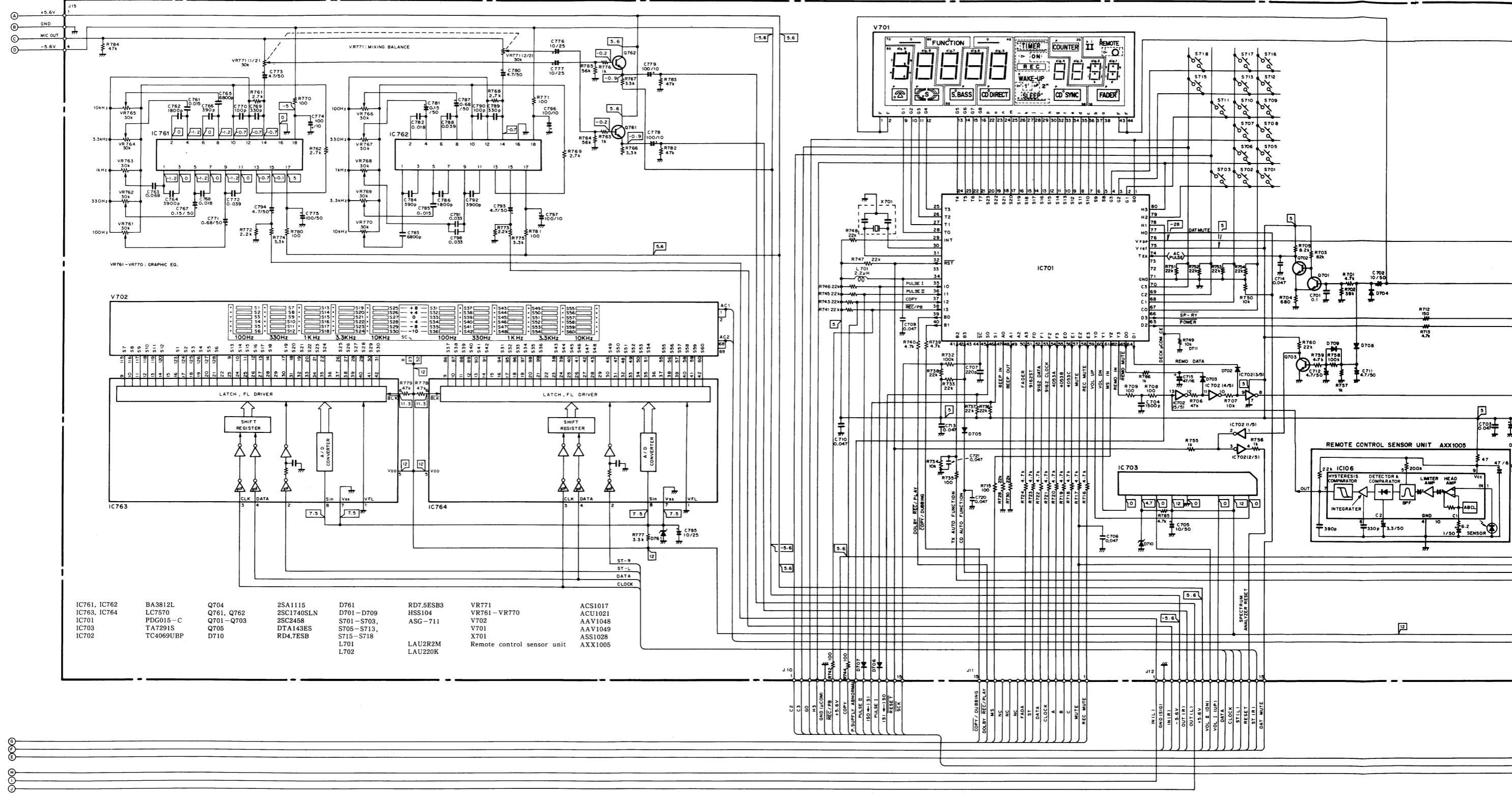

IC761, IC762	BA3812L	Q704	2SA1115	D761	RD7.5ESB3	VR771	ACS1017
IC763, IC764	LC7570	Q762	2SC1740SLN	D701 - D709	HSS104	VR761 - VR770	ACU1021
IC701	PDG015-C	Q701 - Q703	2SC2458	S701 - S703	ASG-711	V702	AAV1048
IC703	TA7291S	Q705	DTA143ES	S705 - S713		V701	AAV1049
IC702	TC4069UBP	D710	RD4.7ESB	S715 - S718		X701	ASS1028
				L701	LAU2R2M	Remote control sensor unit	AXX1005
				L702	LAU220K		

A

B

C

D

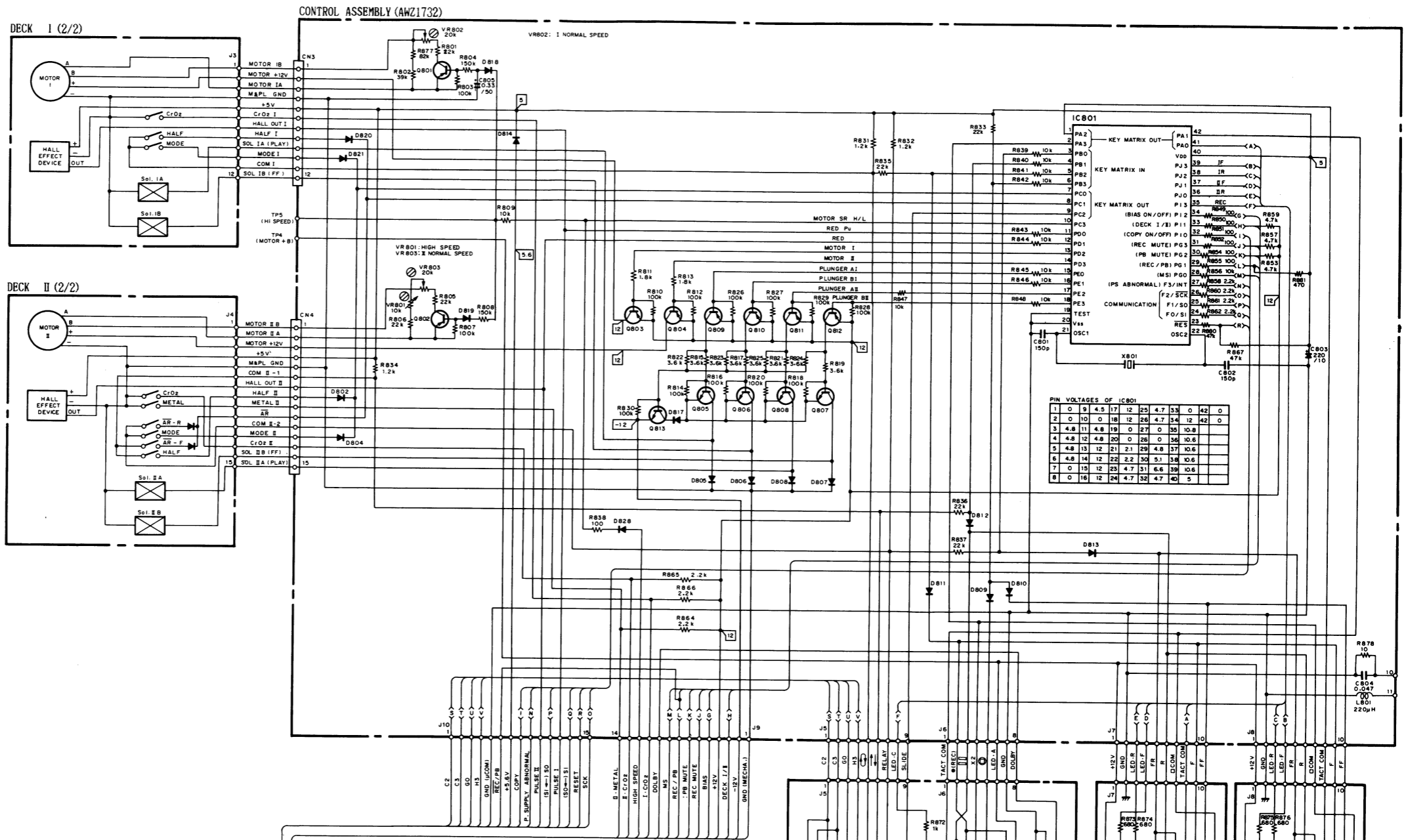
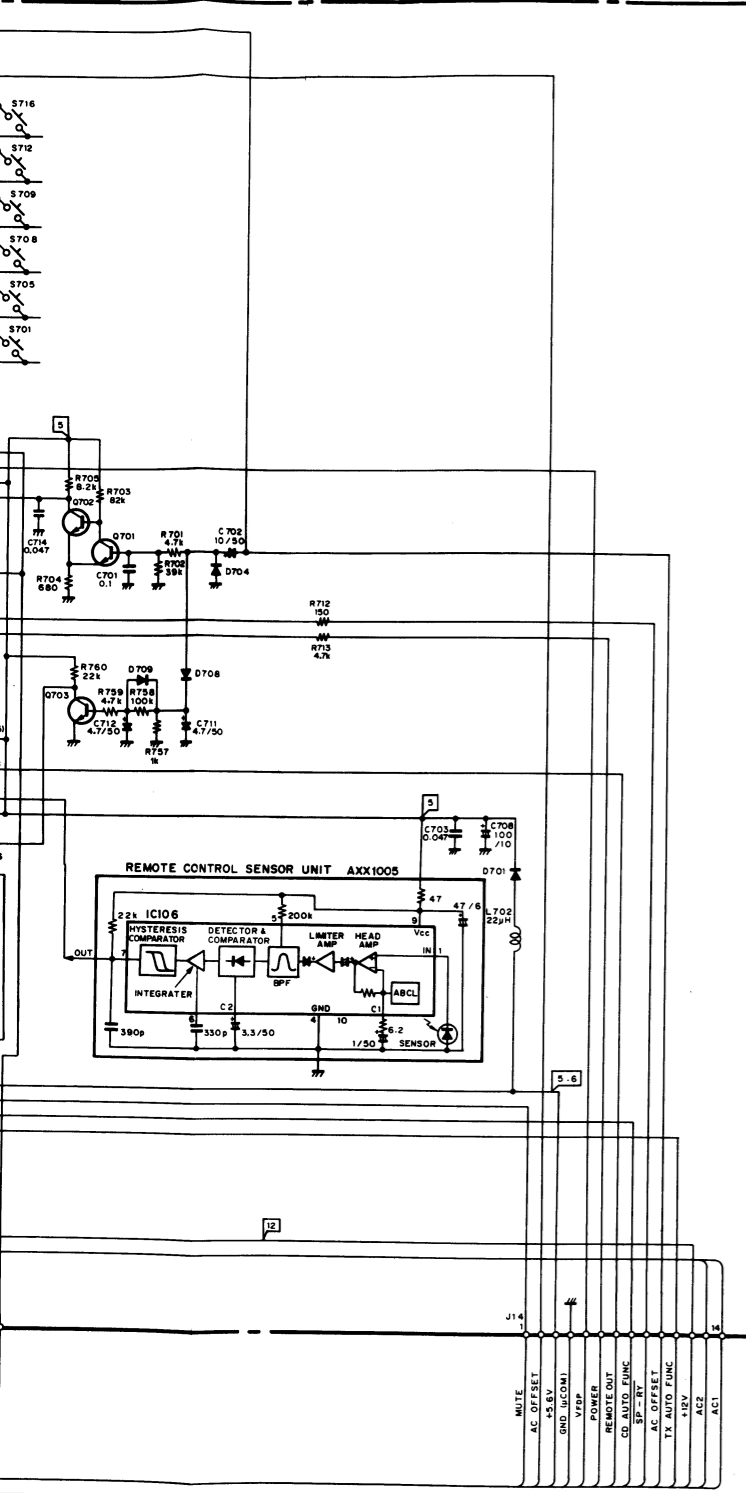

PIN VOLTAGES OF IC801

1	0	9	4.5	17	12	25	4.7	33	0	42	0
2	0	10	0	18	12	26	4.7	34	12	42	0
3	4.8	11	4.8	19	0	27	0	35	10.8		
4	4.8	12	4.8	20	0	28	0	36	10.6		
5	4.8	13	12	21	21	29	4.8	37	10.6		
6	4.8	14	12	22	2.2	30	5.1	38	8.1		
7	0	15	12	23	4.7	31	6.6	39	10.6		
8	0	16	12	24	4.7	32	4.7	40	5		

- CONTROL Assembly
- IC801 PDE025-A
  - Q801, Q802, Q809-Q812 2SA1048
  - Q803, Q804 2SA1515
  - Q805-Q808, Q813 2SC3377
  - D817 S5566
  - D802, D804-D814, D818-D822, HSS104
  - D828 L801
  - L801 LAU221K
  - VR801 VRTM6H103
  - VR802, VR803 VRTM6H203
  - X801 ASS1029

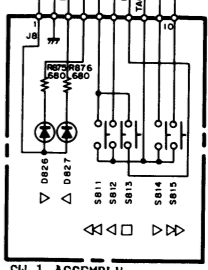
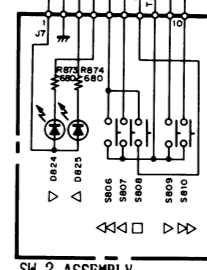
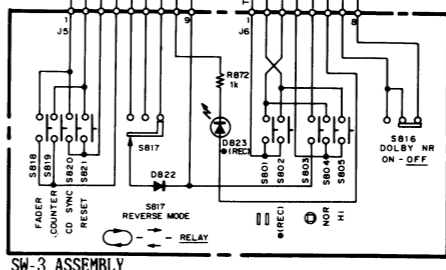

- D823 AEL-443
- S801-S805, S818-S821 ASG-711
- S817 ASH1011
- S816 ASH1014
- D824, D825 AEL1066
- S806-S810 ASG-771
- D826, D827 S811-S815
- AEL1066 ASG-711

A

B

C

D

# 3. P.C. BOARD PTTTERNS

View from component side (1/2)

DECK I (1/2)

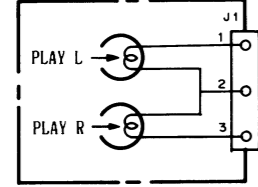

DECK II (1/2)

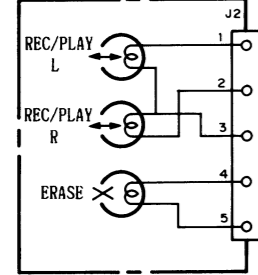

VOLUME ASSEMBLY

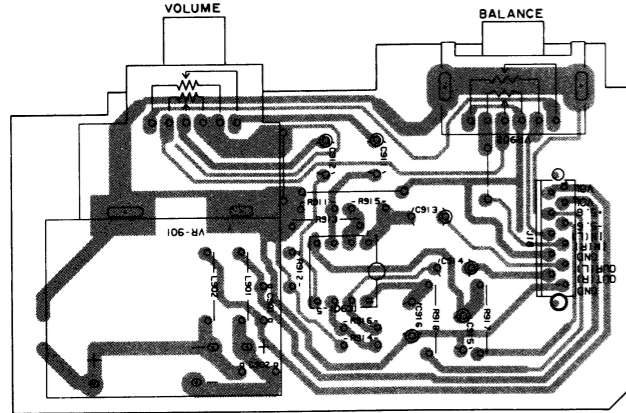

SUPER BASS ASSEMBLY

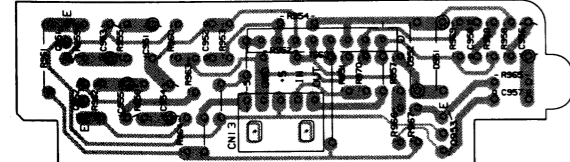

- Q 421 Q 415 Q 301
- Q 417 Q 413 Q 303 Q 305
- Q 420 Q 414 Q 302 Q 310
- Q 418 Q 416 Q 304 Q 307
- Q 419 Q 318 IC301 Q 306
- Q 426 Q 319 IC302 Q 312
- Q 425 Q 321 IC302 Q 311
- Q 423 Q 422 Q 312
- Q 424 Q 427
- Q 326 IC303
- Q 328 IC401
- Q 327 IC401
- Q 331 IC304
- Q 329
- Q 330 Q 407 Q 314
- Q 323 Q 411 Q 313
- Q 428 IC203
- Q 317 Q 408
- Q 409
- Q 322 IC403
- IC402 Q 405
- Q 410
- Q 412 Q 404
- Q 403 IC202
- Q 204 Q 402
- Q 406
- Q 205 Q 202
- Q 401
- IC207 IC204 Q 201
- IC205 IC201
- IC206
- Q 206
- Q 505
- Q 508
- Q 521
- Q 520
- IC305 Q 519 Q 504
- IC501 Q 517
- IC502 Q 514
- Q 501 Q 511
- Q 502 Q 516
- Q 518 Q 518 Q 507
- Q 512 Q 506
- Q 522 Q 513 Q 503
- Q 510
- IC501 Q 509

AF ASSEMBLY (AWM1087)

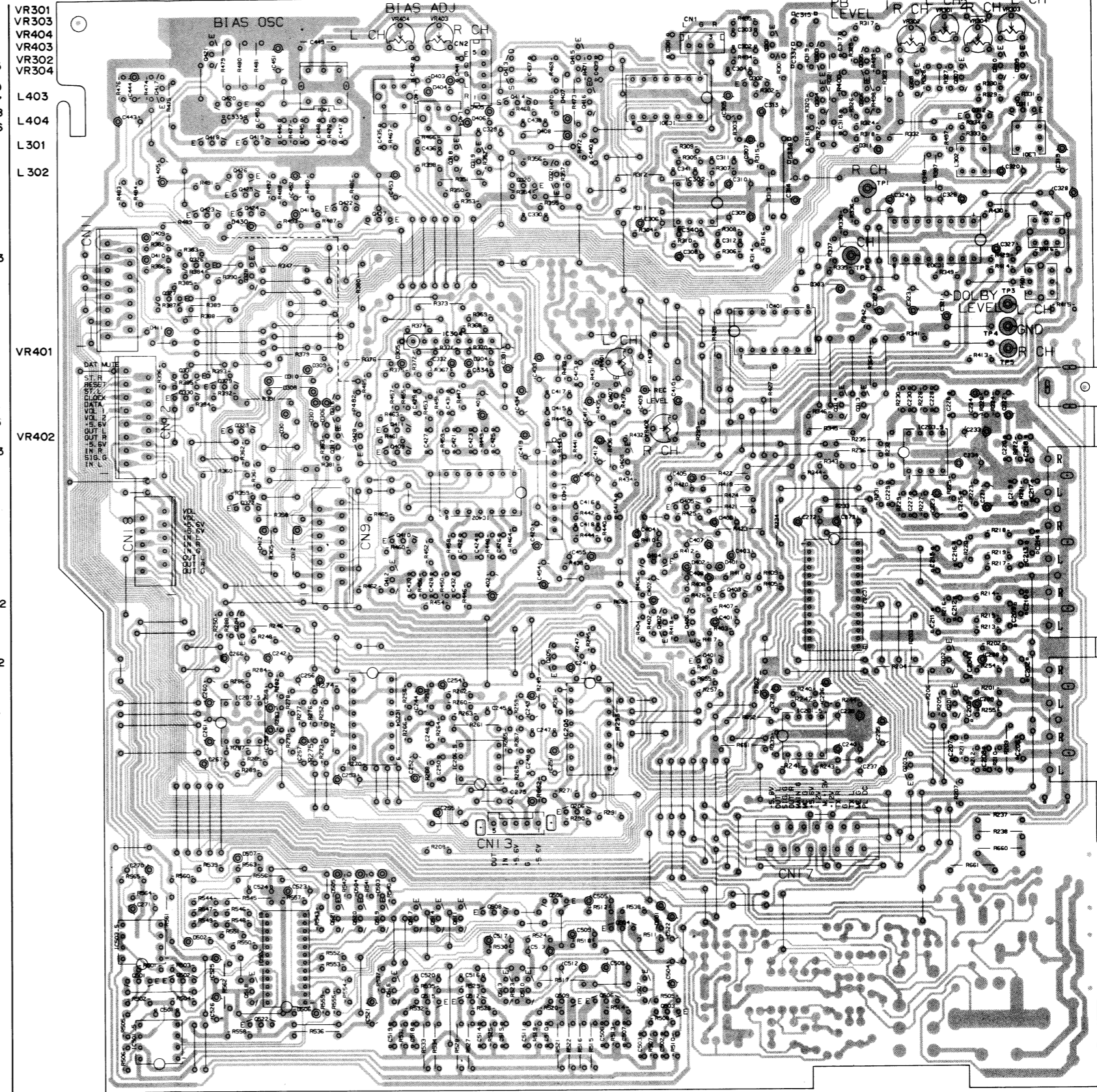

TURNTABLE  
DC12V OUTPUT

PHONO  
CD  
VIDEO  
REC  
PLAY

INPUT  
Q 142  
Q 171  
Q 143  
Q 102  
Q 101  
IC 103

Q 191  
Q 144  
Q 145  
Q 107  
Q 146



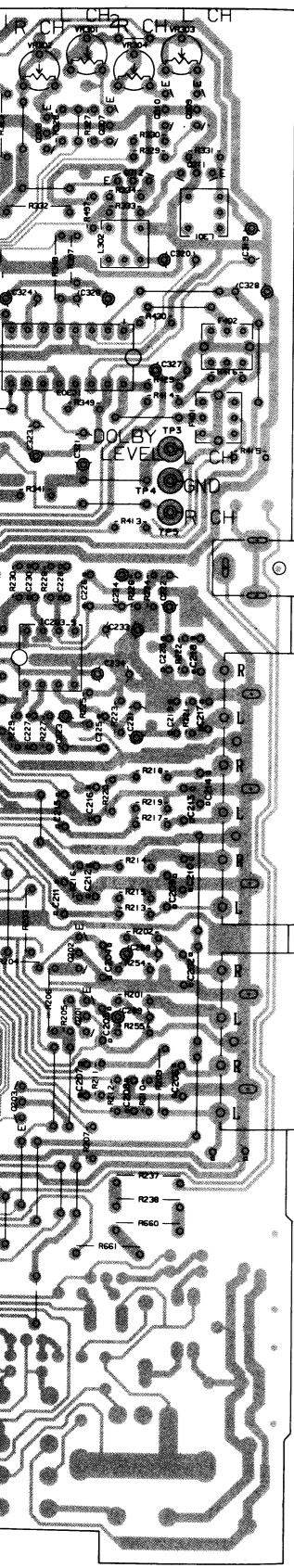

TURNTABLE  
DC12V OUTPUT

PHONO

CD

VIDEO

REC

PLAY

- Q 105
- Q 106
- IC 102
- Q 103
- Q 104
- IC 105
- Q 142
- Q 171
- Q 143
- Q 102
- Q 101
- IC 101
- IC 103
- IC 104
- Q 141
- Q 140
- Q 191
- Q 144
- Q 145
- Q 190
- IC 190
- Q 107
- Q 146

POWER ASSEMBLY (AWZ1740)

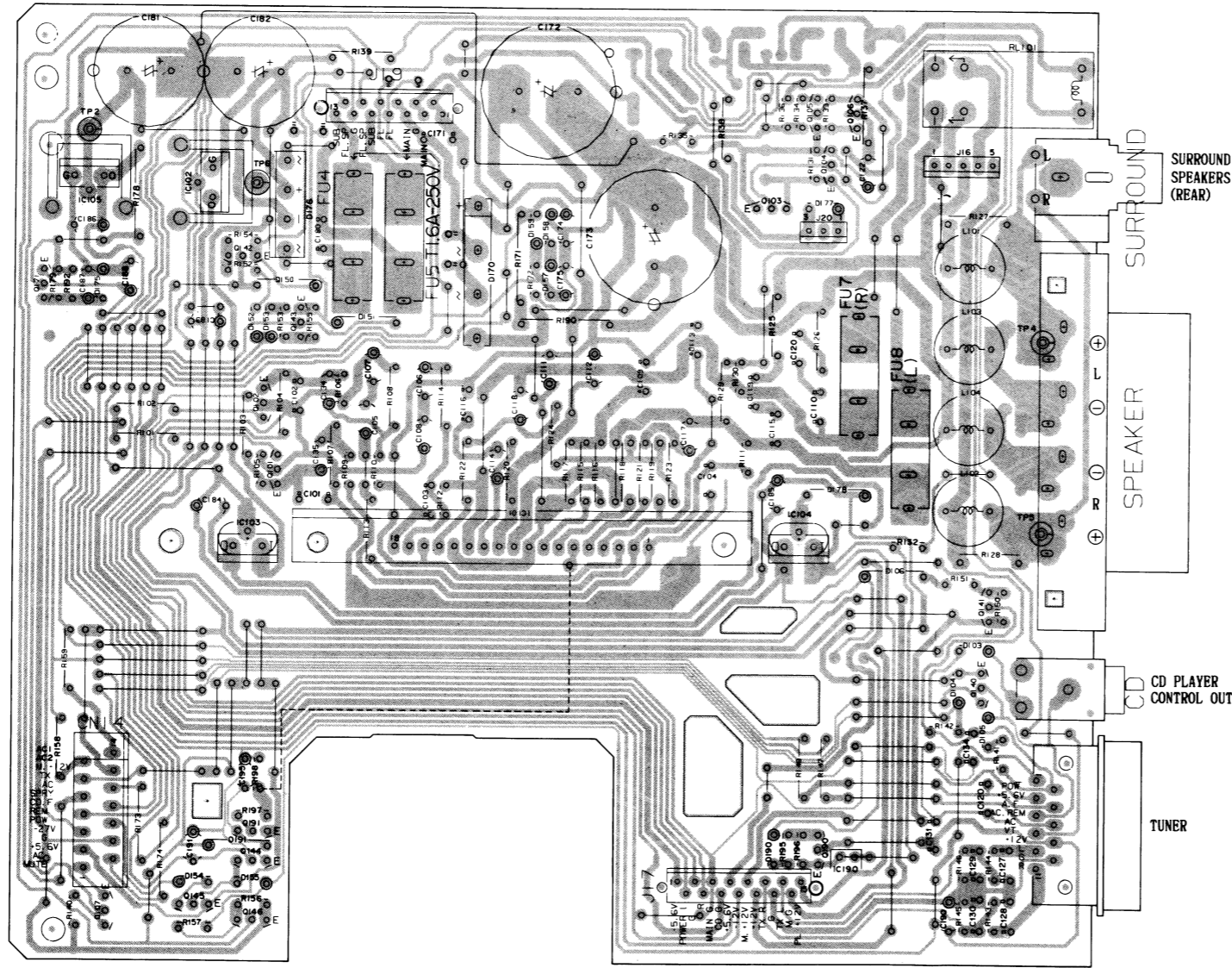

CONNECT ASSEMBLY

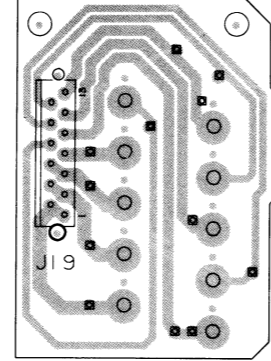

POWER SUPPLY ASSEMBLY

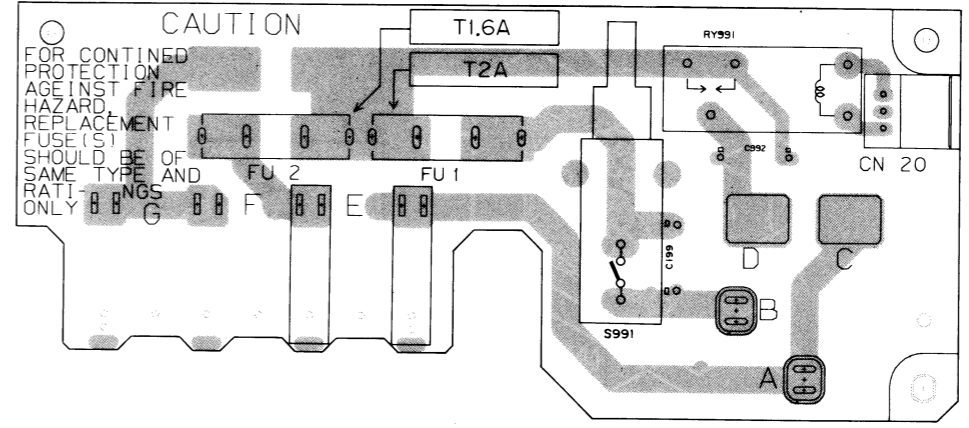

MIC H.P. ASSEMBLY

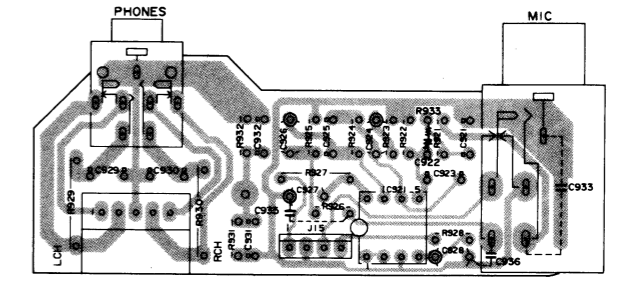

View from component side (2/2)

A

B

C

D

DISPLAY ASSEMBLY (AWZ11)

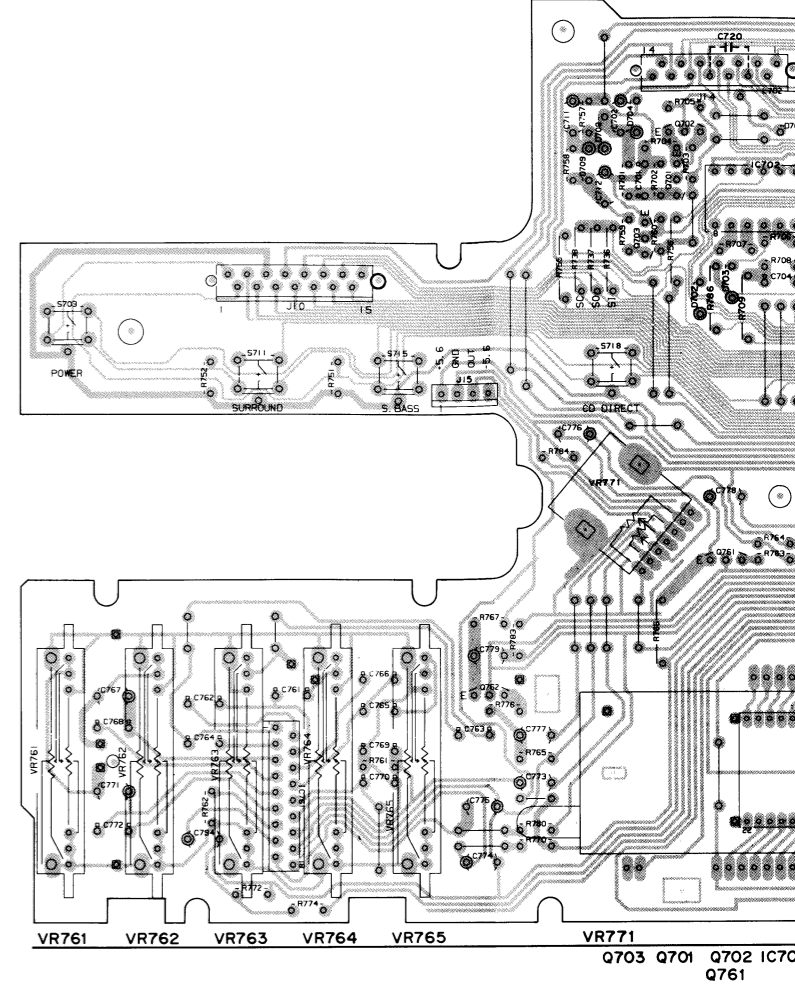

DECK I (2/2)

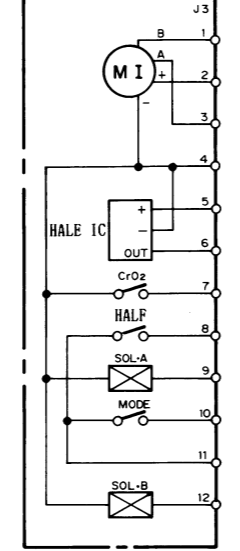

DECK II (2/2)

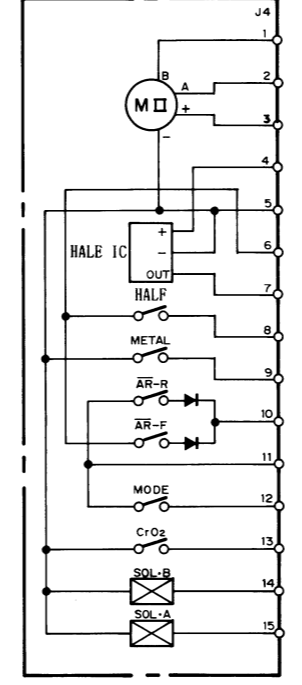

CONTROL ASSEMBLY (AWZ1732)

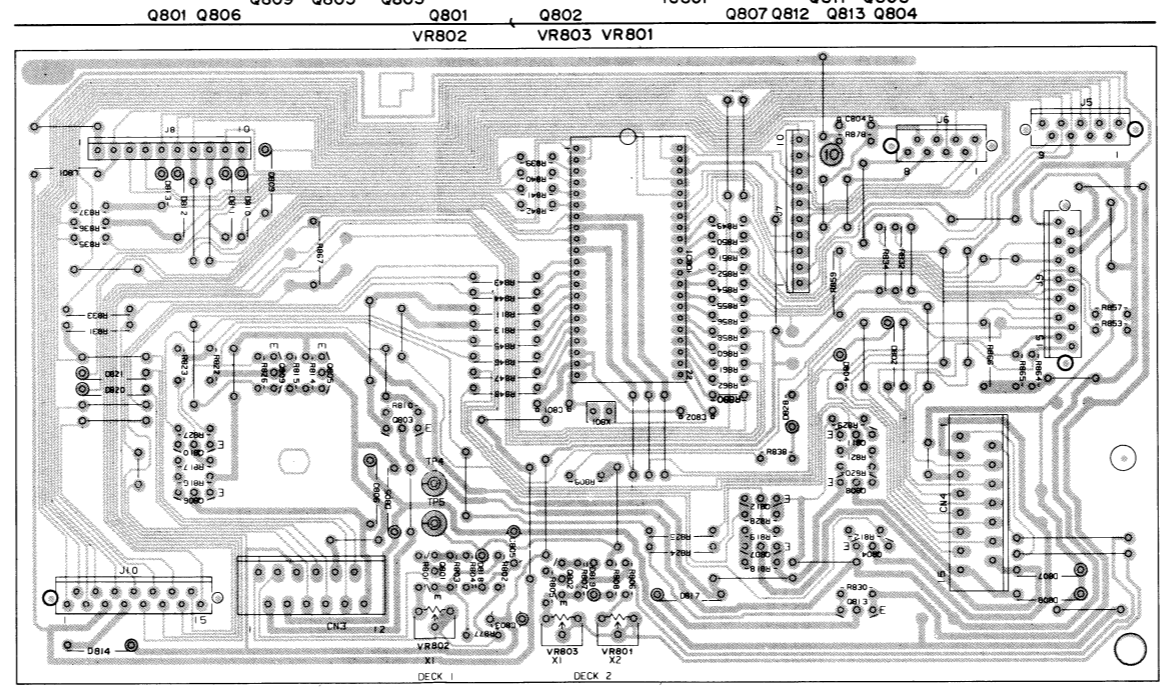

SW-1 ASSEMBLY

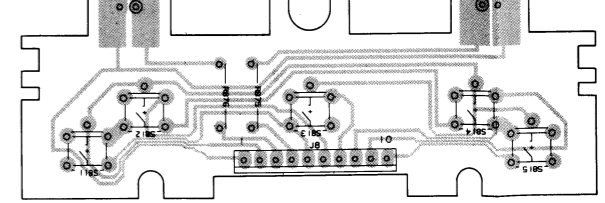

DISPLAY ASSEMBLY (AWZ1742)

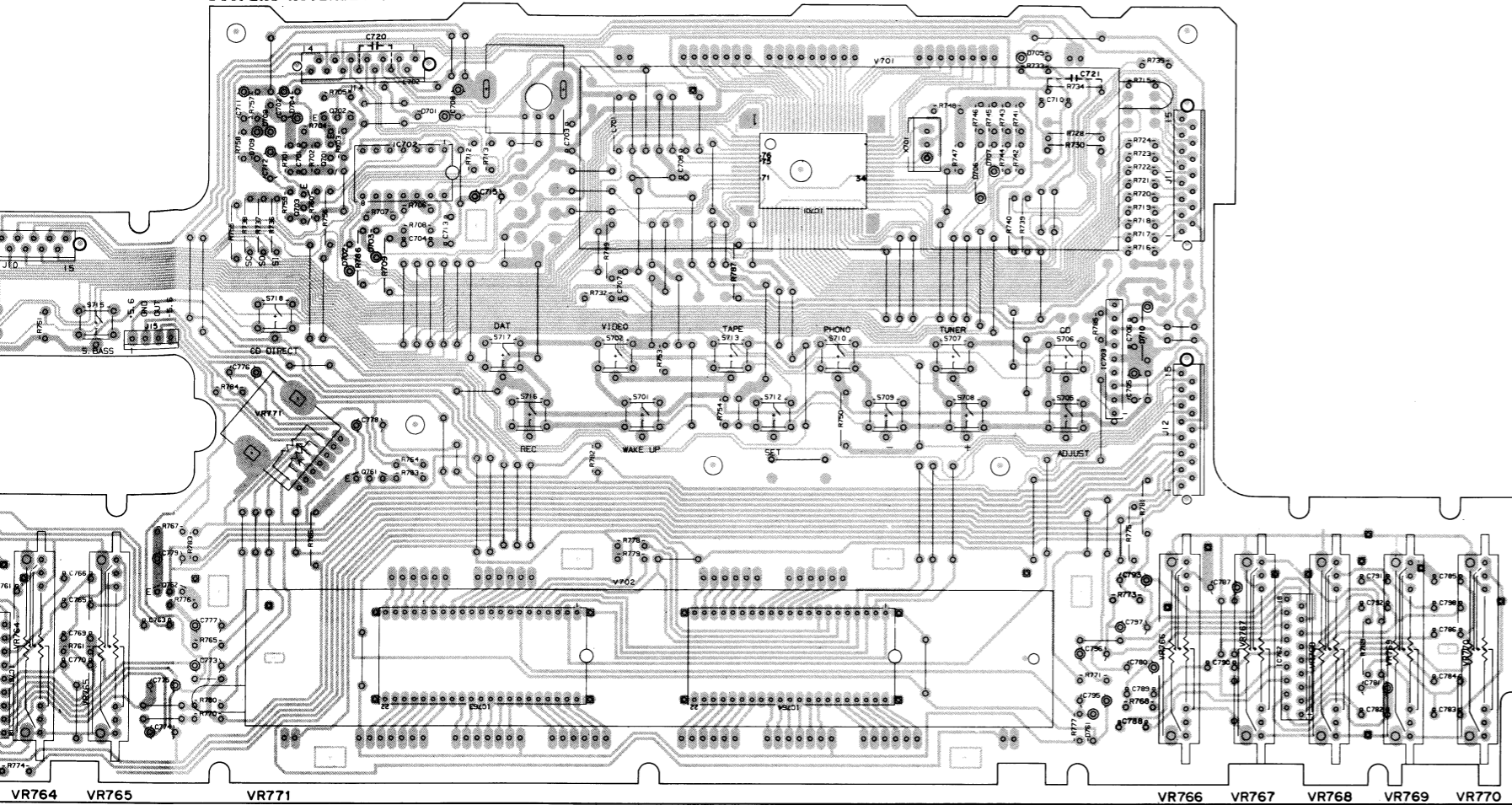

VR764 VR765 VR771  
 Q703 Q701 Q702 IC702  
 Q761  
 IC763 IC764  
 IC701  
 Q704 IC703 Q705  
 VR766 VR767 VR768 VR769 VR770

SW-3 ASSEMBLY

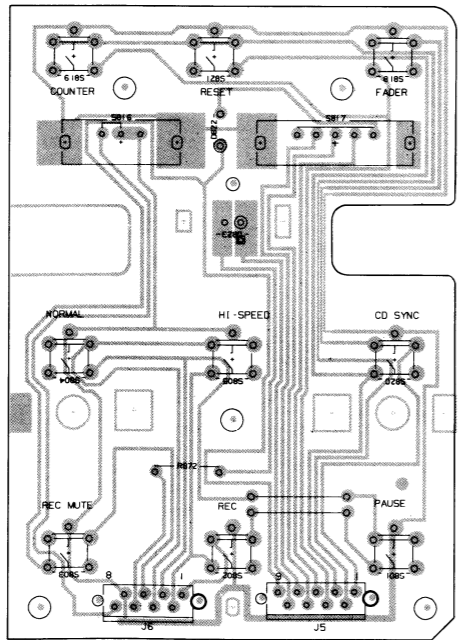

SW-2 ASSEMBLY

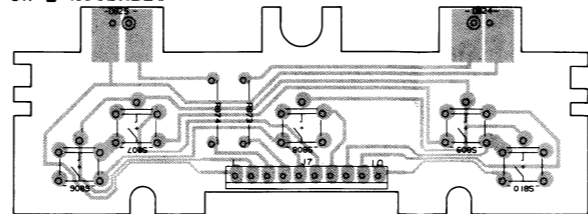

NOTE

1. This P.C.B. connection diagram is viewed from the parts mounted side.
2. The parts which have been mounted on the board can be replaced with those shown with the corresponding wiring symbols listed in the following Table.

P.C.B. pattern diagram indication	Corresponding part symbol	Part Name
		Transistor
		Radiator type transistor
		Diode
		Resistor
		Capacitor (Polarity)
		Capacitor (Non-polarity)

Others

P.C.B. pattern diagram indication	Part Name
IC	IC
S	Switch
RY	Relay
L	Coil
F	Filter
VR	Variable resistor or Semi-fixed resistor

3. The capacitor terminal marked with ⊙ (double circles) shows negative terminal.
4. The diode terminal marked with ⊙ (double circles) shows cathode side.
5. The transistor terminal to which E is affixed shows the emitter.

A

B

C

D

1

2

3

4

5

6

Mechanism unit (DECK II)

4. PA  
Parts Lis  
Mark N

A

A

B

B

C

C

D

D

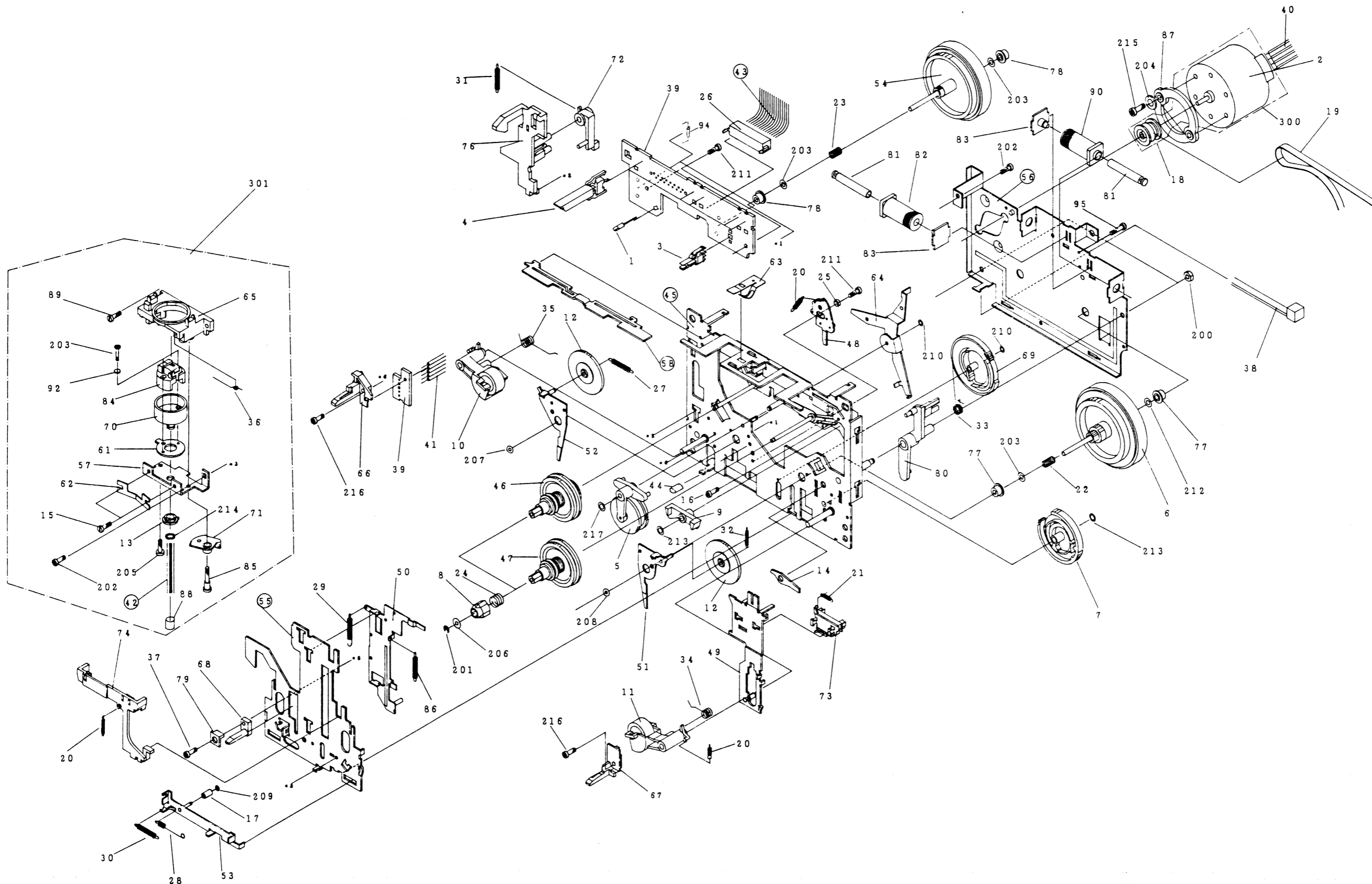

1

2

3

4

5

6



# 4. PACKING

## Parts List

Mark	No.	Part No.	Description
	1	ARE1068	Operating instructions (English, German, French, Italian)
	2	AXD1042	Remote control unit
	3	AHA1126	Front pad
	4	AHA1127	Rear pad
	5	AHD1349	Packing case
	6	ARC1073	Operating instructions (Spanish-auxiliary)
	51		Batteries
	52		Warranty card
	53		Packing sheet

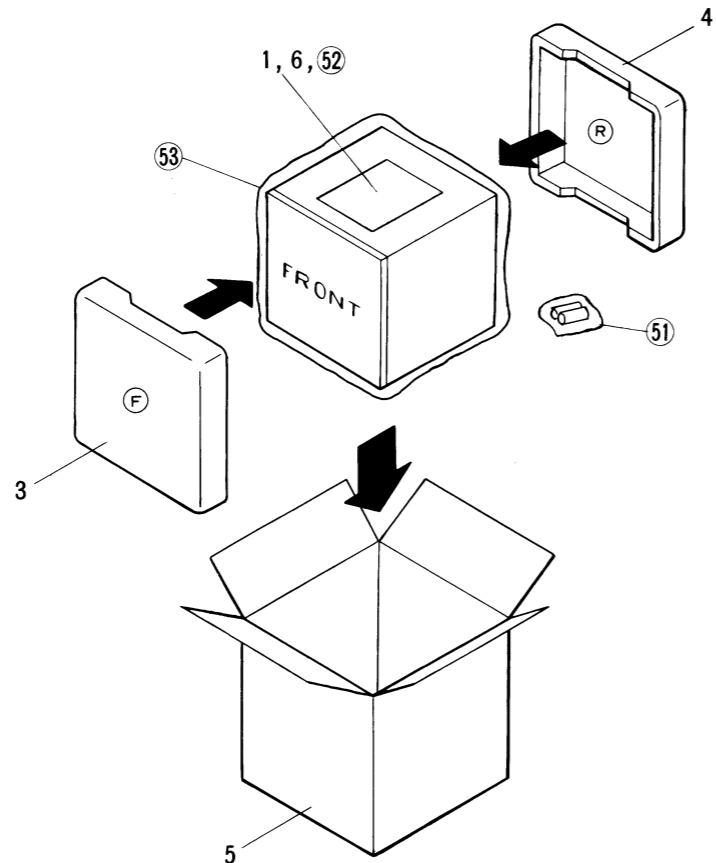
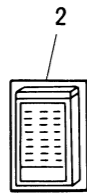
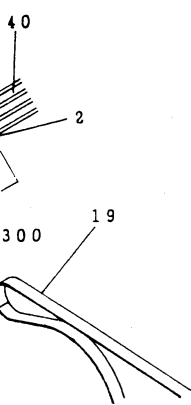

## External appearance of transistors and ICs

2SA1048  
2SC2453  
DTA143ES  
DTA124ES  
DTC124ES

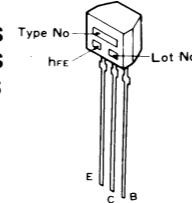

2SK373

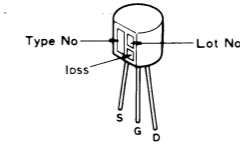

M5F78M05L

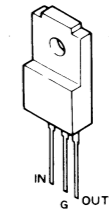

TA7291S

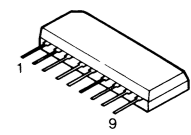

2SA1115  
2SC2603

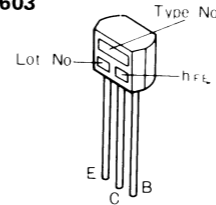

BA3812L

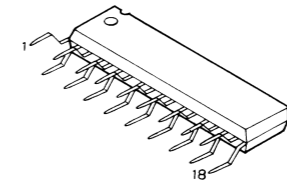

M74LS05P  
TC4066BP  
TC4069UBP

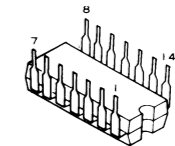

TC9162N

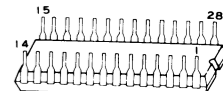

2SA1515

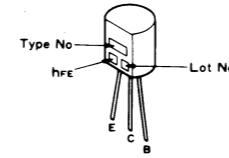

CXA1100P  
TC4053BP

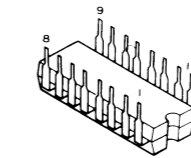

PD4142

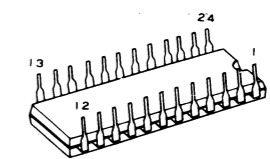

μPC7812H

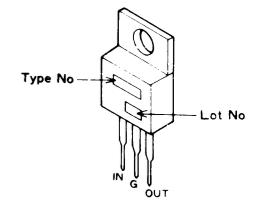

2SB560

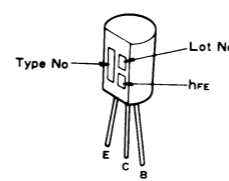

ICP-N10

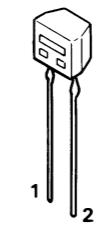

PDE025-A

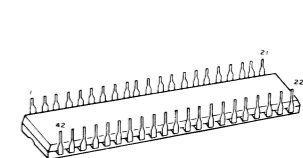

μPC7912H

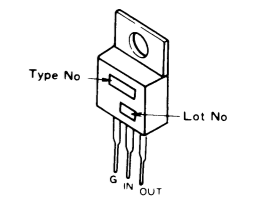

2SC1740SLN

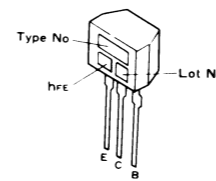

LC7570

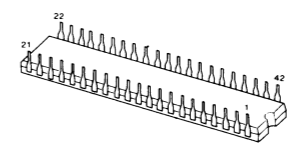

PDG015-B

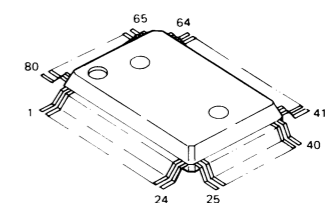

2SC2878

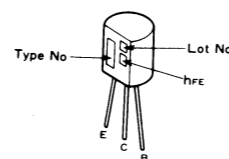

M5218L  
M5218LF

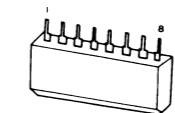

RN1201  
RN1203  
RN2203

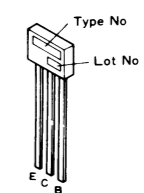

2SC3377  
2SD438

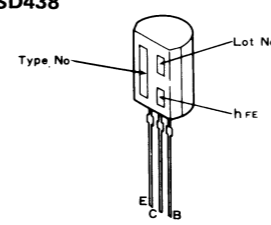

M5218P  
M5218PF  
NJM4558DX

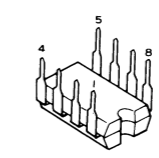

STK4192-2GP

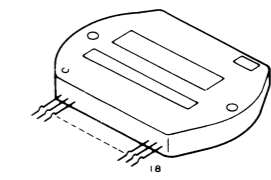





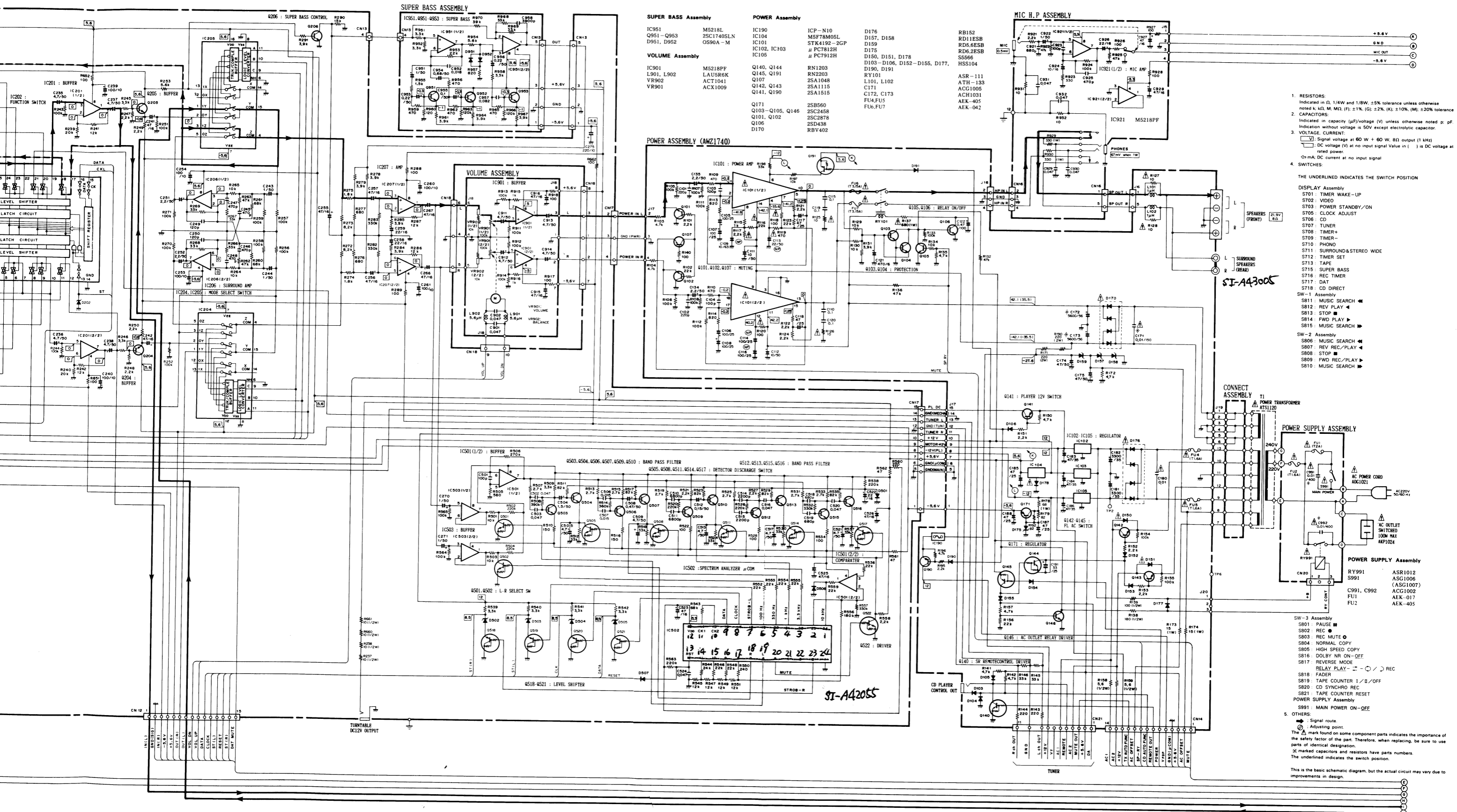

SUPER BASS Assembly		POWER Assembly	
IC951	M5218L	IC190	ICP-N10
C951-Q953	2SC1740SLN	IC104	M5F78M05L
D951, D952	OS90A-M	IC101	ST4192-2GP
		IC102, IC103	PC7812H
		IC105	PC7912H

VOLUME Assembly		MIC H.P. ASSEMBLY	
IC901	M5218PF	Q140, Q144	RB152
L901, L902	LAU9R6K	Q145, Q191	RD1ESB
VR902	ACT1041	Q107	RD6.6ESB
VR901	ACX1009	2SA1048	RD1.2ESB
		2SA1115	SE566
		2SA1515	HSS104
		Q171	ASR-111
		Q103-Q105, Q146	ATH-133
		Q101, Q102	ACG1005
		Q106	ACH1031
		D170	AEK-405
			AEK-042

- RESISTORS: Indicated in Ω, 1/4W and 1/8W. ±5% tolerance unless otherwise noted. K, M, G, ±1%, (G) ±2%, (K) ±10%, (M) ±20% tolerance.
- CAPACITORS: Indicated in capacity (μF)/voltage (V) unless otherwise noted. pF indicated without voltage is 50V except electrolytic capacitor.
- VOLTAGE, CURRENT: □ Signal voltage at 60 W ± 60 W. 8Ω output (1.44A). □ DC voltage (V) at no input signal. Value in ( ) is DC voltage at rated power. □ mA; DC current at no input signal.
- SWITCHES: THE UNDERLINED INDICATES THE SWITCH POSITION.

- DISPLAY Assembly
- S701: TIMER WAKE-UP
  - S702: VIDEO
  - S703: POWER STANDBY/ON
  - S705: CLOCK ADJUST
  - S706: CD
  - S707: TUNER
  - S708: TIMER+
  - S709: TIMER-
  - S710: PHONO
  - S711: SURROUND & STEREO WIDE
  - S712: TIMER SET
  - S713: TAPE
  - S715: SUPER BASS
  - S716: REC TIMER
  - S717: DAT
  - S718: CD DIRECT
- SW-1 Assembly
- S811: MUSIC SEARCH
  - S812: REV. PAUSE
  - S813: STOP
  - S814: FWD. PLAY
  - S815: MUSIC SEARCH
- SW-2 Assembly
- S806: MUSIC SEARCH
  - S807: REV. REC./PLAY
  - S808: STOP
  - S809: FWD. REC./PLAY
  - S810: MUSIC SEARCH

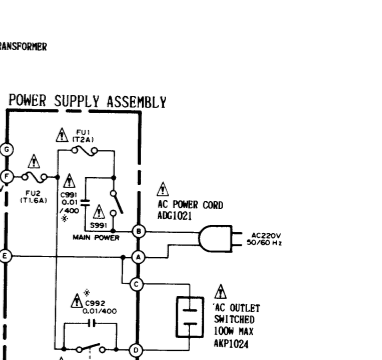

- POWER SUPPLY Assembly
- RY991
  - S991
  - C991, C992
  - FU1
  - FU2
  - ASR1012
  - ASG1006 (ASG1007)
  - ACG1002
  - AEK-017
  - AEK-405
- SW-3 Assembly
- S801: PAUSE
  - S802: REC
  - S803: REC MUTE
  - S804: NORMAL COPY
  - S805: HIGH SPEED COPY
  - S816: DOLBY NR ON-OFF
  - S817: REVERSE MODE
  - RELAY PLAY - [Symbol] REC
  - S818: FADER
  - S819: TAPE COUNTER 1/2/OFF
  - S820: CD SYNCHRO REC
  - S821: TAPE COUNTER RESET
- POWER SUPPLY Assembly
- S991: MAIN POWER ON-OFF

5. OTHERS:  
 □ Signal route  
 ⊕ Adjusting point  
 The Δ mark found on some component parts indicates the importance of the safety factor of the part. Therefore, when replacing, be sure to use parts of identical designation.  
 \* Marked capacitors and resistors have part numbers.  
 The underlined indicates the switch position.

This is the basic schematic diagram, but the actual circuit may vary due to improvements in design.

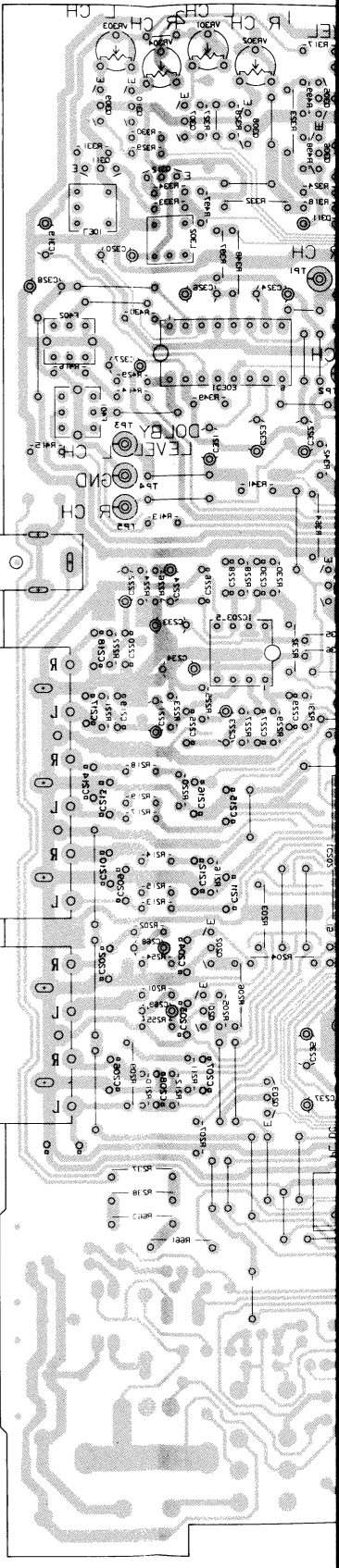

0148 IC102  
 0149 IC103  
 0144 0145 0146 0147  
 0141  
 0140  
 0101 0102 0103 0104  
 0105  
 0143 0144 0145  
 0171 0172  
 0145  
 IC105 IC106  
 0108 0109

PLAY REC VIDEO CD INPUT PHONO  
 DC13A OUTPUT  
 TURNABLE

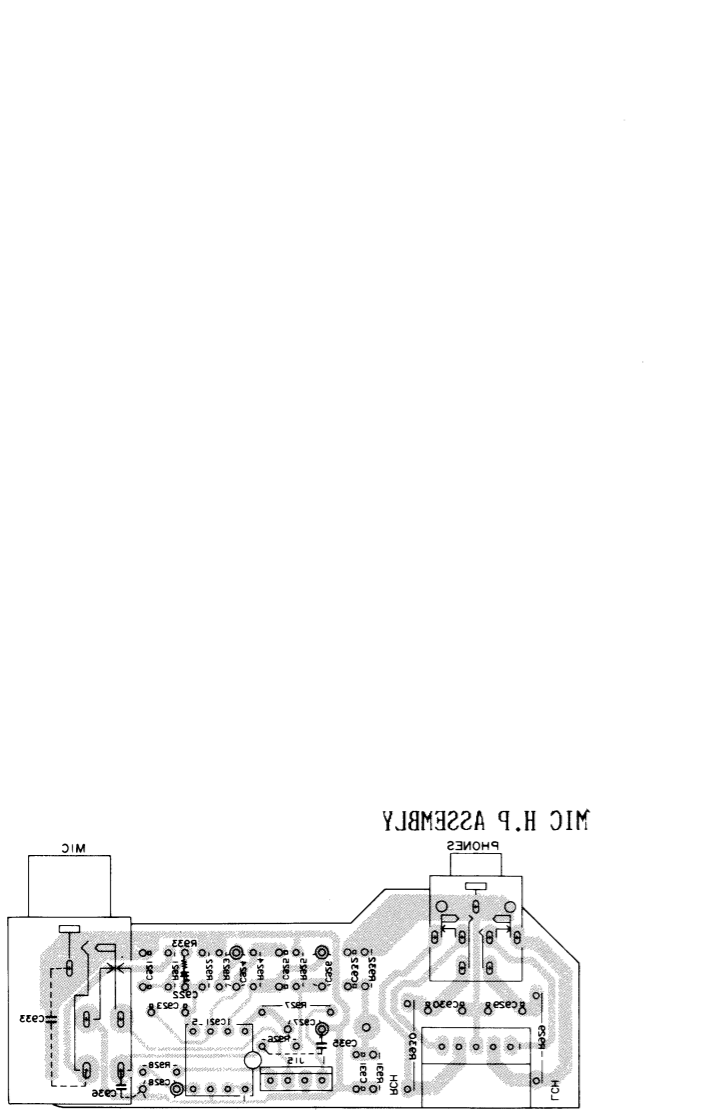
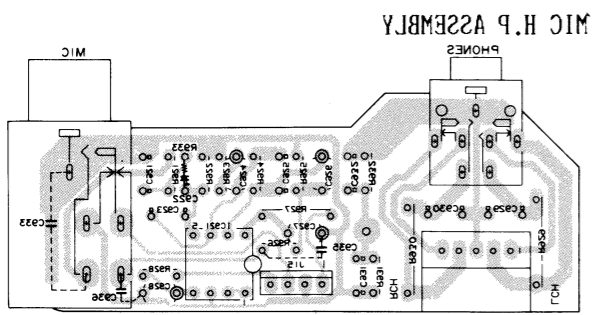
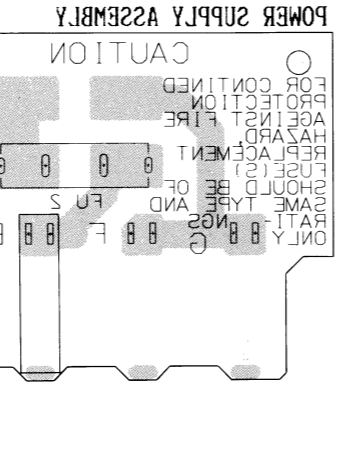
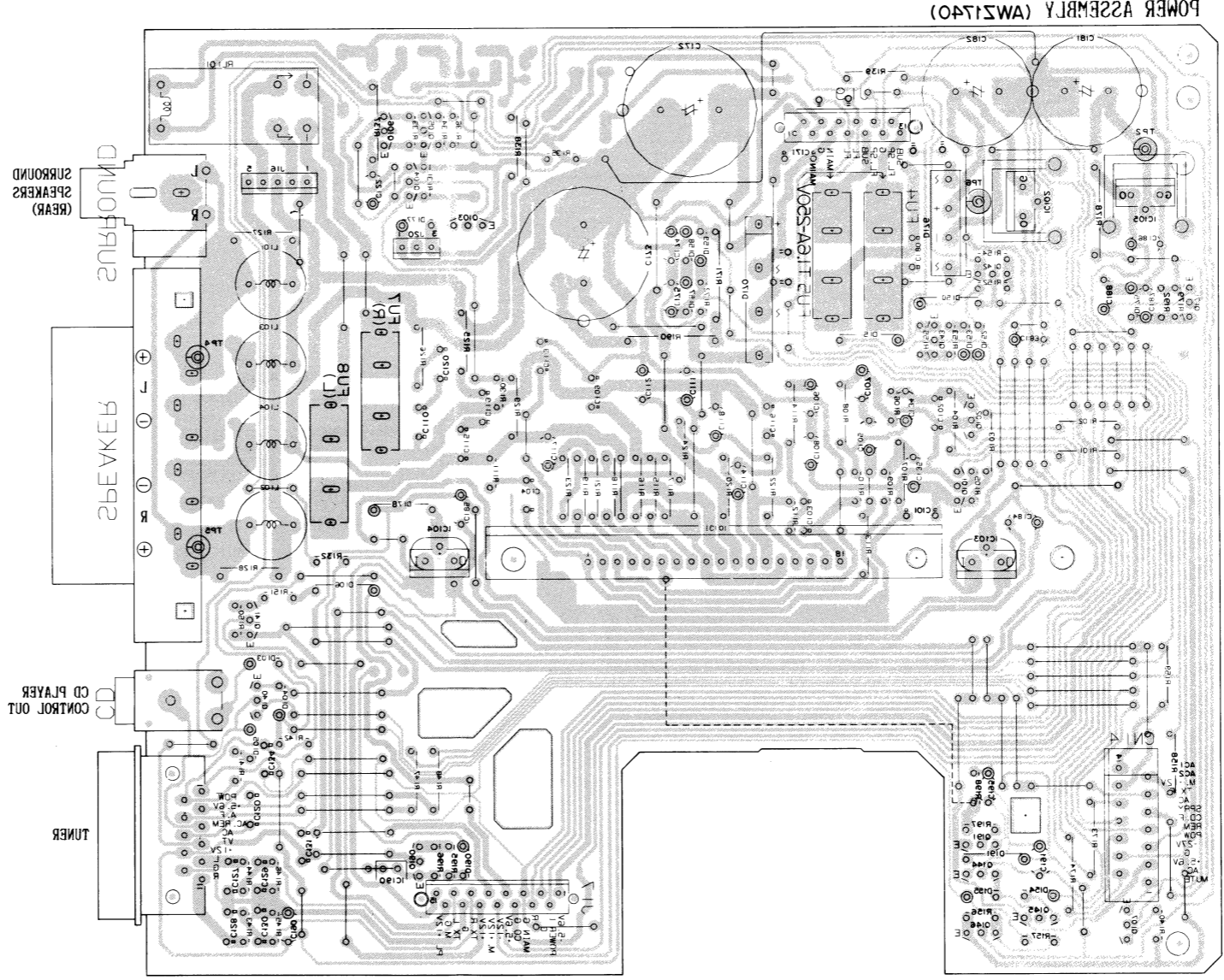
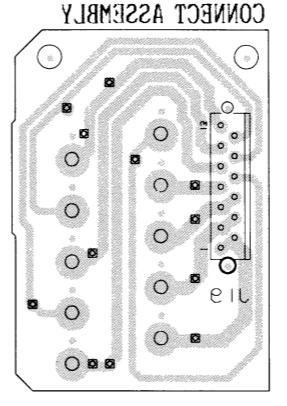

View from soldering side (1/2)

A B C D

6 7 8 9 10 11 12

6 7 8 9 10 11 12





View from soldering side (2/2)

DISPLAY ASSEMBLY (AW5174S)

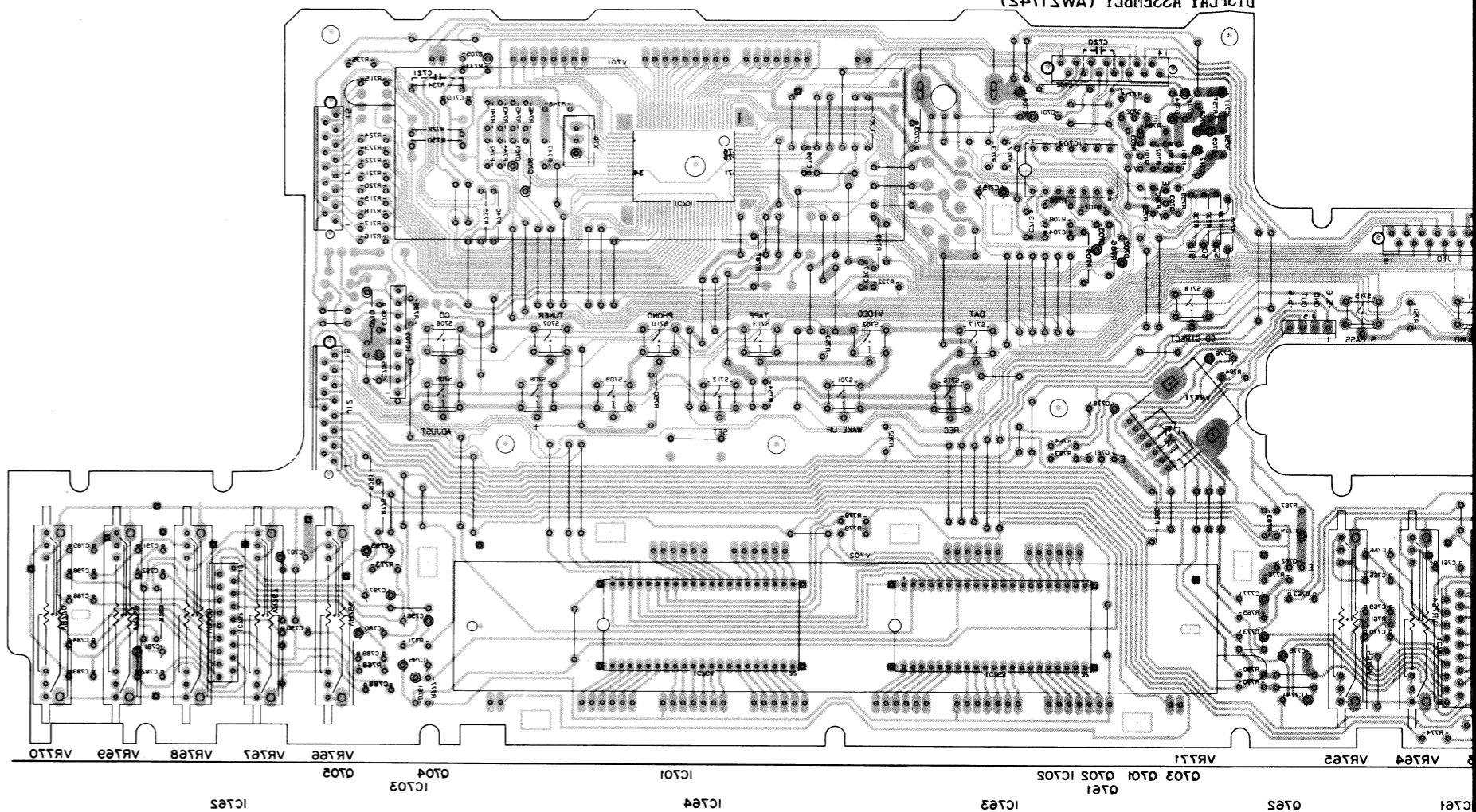

SW-3 ASSEMBLY

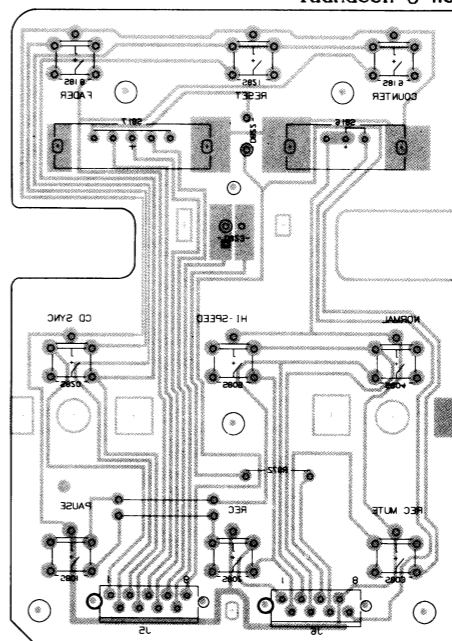

SW-2 ASSEMBLY

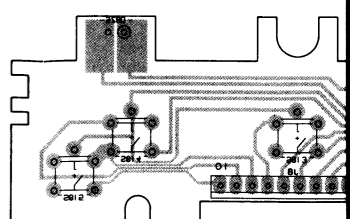
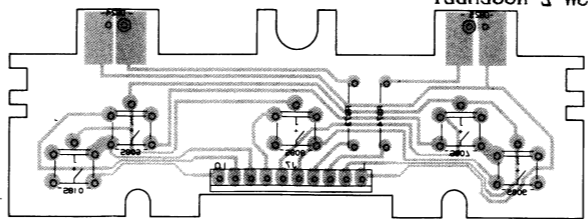

A

B

C

D

A

B

C

D

1

2

3

4

2

6

7

DISPLAY ASSEMBLY (AWA)

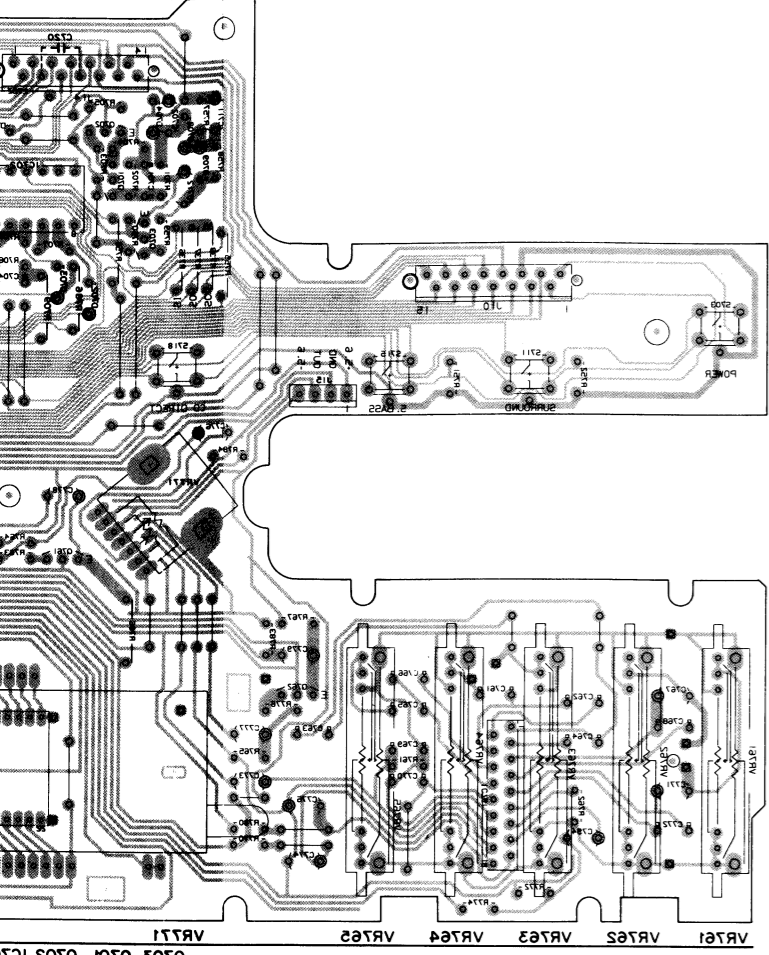

IC161  
IC162  
IC163  
IC164  
IC165  
IC166  
IC167  
IC168  
IC169  
IC170  
IC171  
IC172  
IC173  
IC174  
IC175  
IC176  
IC177  
IC178  
IC179  
IC180  
IC181  
IC182  
IC183  
IC184  
IC185  
IC186  
IC187  
IC188  
IC189  
IC190  
IC191  
IC192  
IC193  
IC194  
IC195  
IC196  
IC197  
IC198  
IC199  
IC200

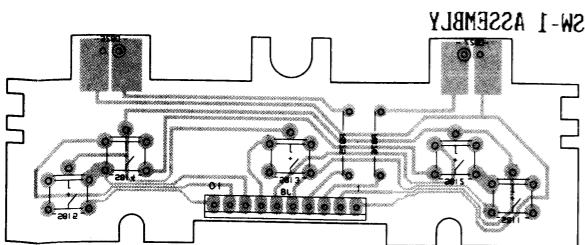

6

7

1

2

3

4

2

CONTROL ASSEMBLY (AWZ1735)

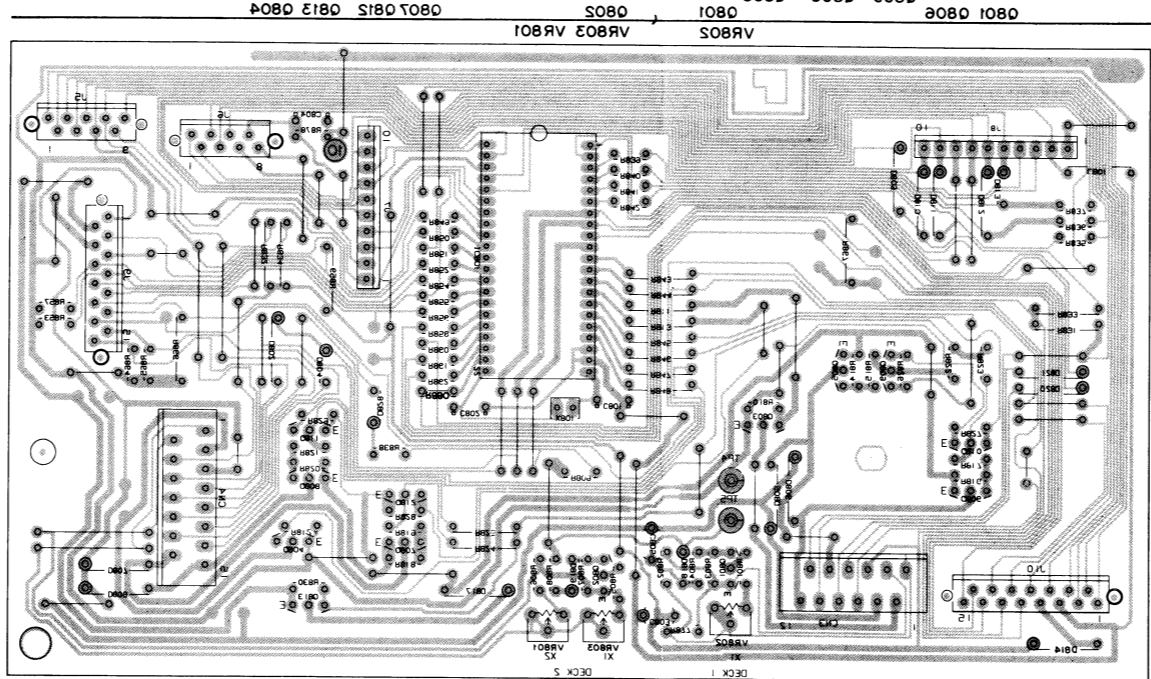

VR801  
VR802  
VR803  
VR804  
VR805  
VR806  
VR807  
VR808  
VR809  
VR810  
VR811  
VR812  
VR813  
VR814  
VR815  
VR816  
VR817  
VR818  
VR819  
VR820  
VR821  
VR822  
VR823  
VR824  
VR825  
VR826  
VR827  
VR828  
VR829  
VR830  
VR831  
VR832  
VR833  
VR834  
VR835  
VR836  
VR837  
VR838  
VR839  
VR840  
VR841  
VR842  
VR843  
VR844  
VR845  
VR846  
VR847  
VR848  
VR849  
VR850  
VR851  
VR852  
VR853  
VR854  
VR855  
VR856  
VR857  
VR858  
VR859  
VR860  
VR861  
VR862  
VR863  
VR864  
VR865  
VR866  
VR867  
VR868  
VR869  
VR870  
VR871  
VR872  
VR873  
VR874  
VR875  
VR876  
VR877  
VR878  
VR879  
VR880  
VR881  
VR882  
VR883  
VR884  
VR885  
VR886  
VR887  
VR888  
VR889  
VR890  
VR891  
VR892  
VR893  
VR894  
VR895  
VR896  
VR897  
VR898  
VR899  
VR900

DECK I (2\5)

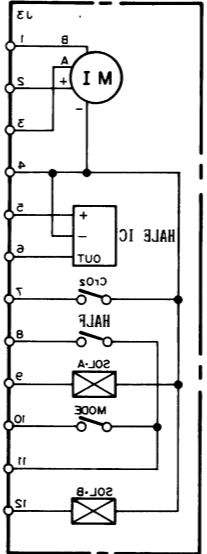

DECK II (2\5)

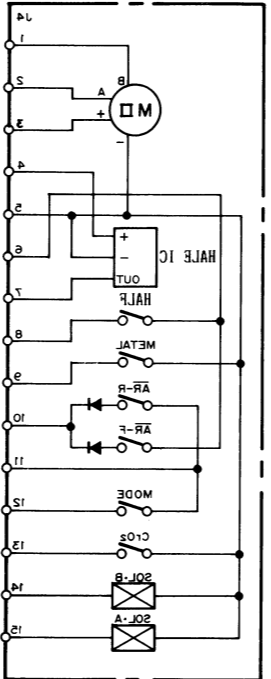



DISPLAY ASSEMBLY (AWZ1742)

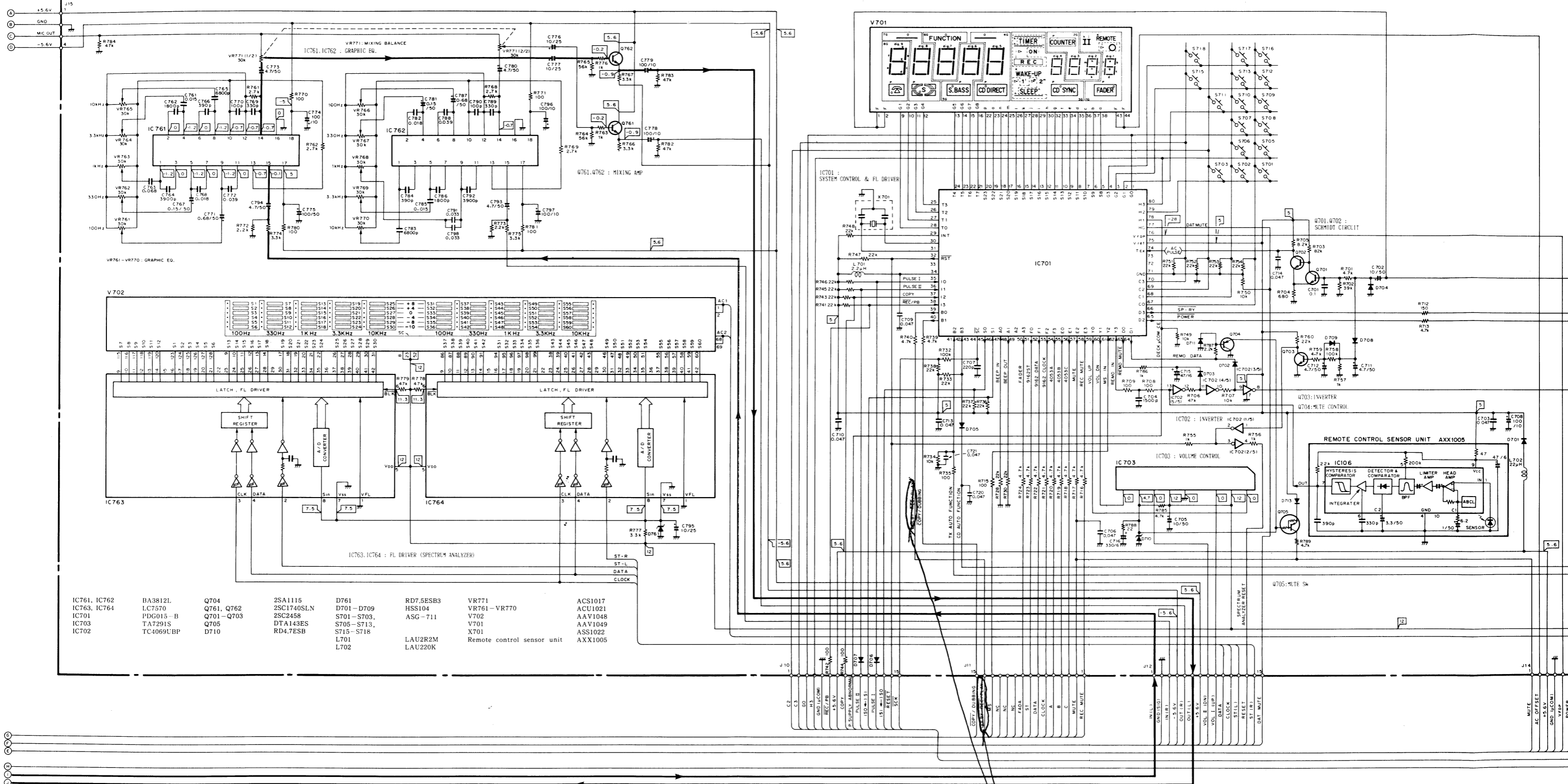

DOLBY  
REC/PLAY

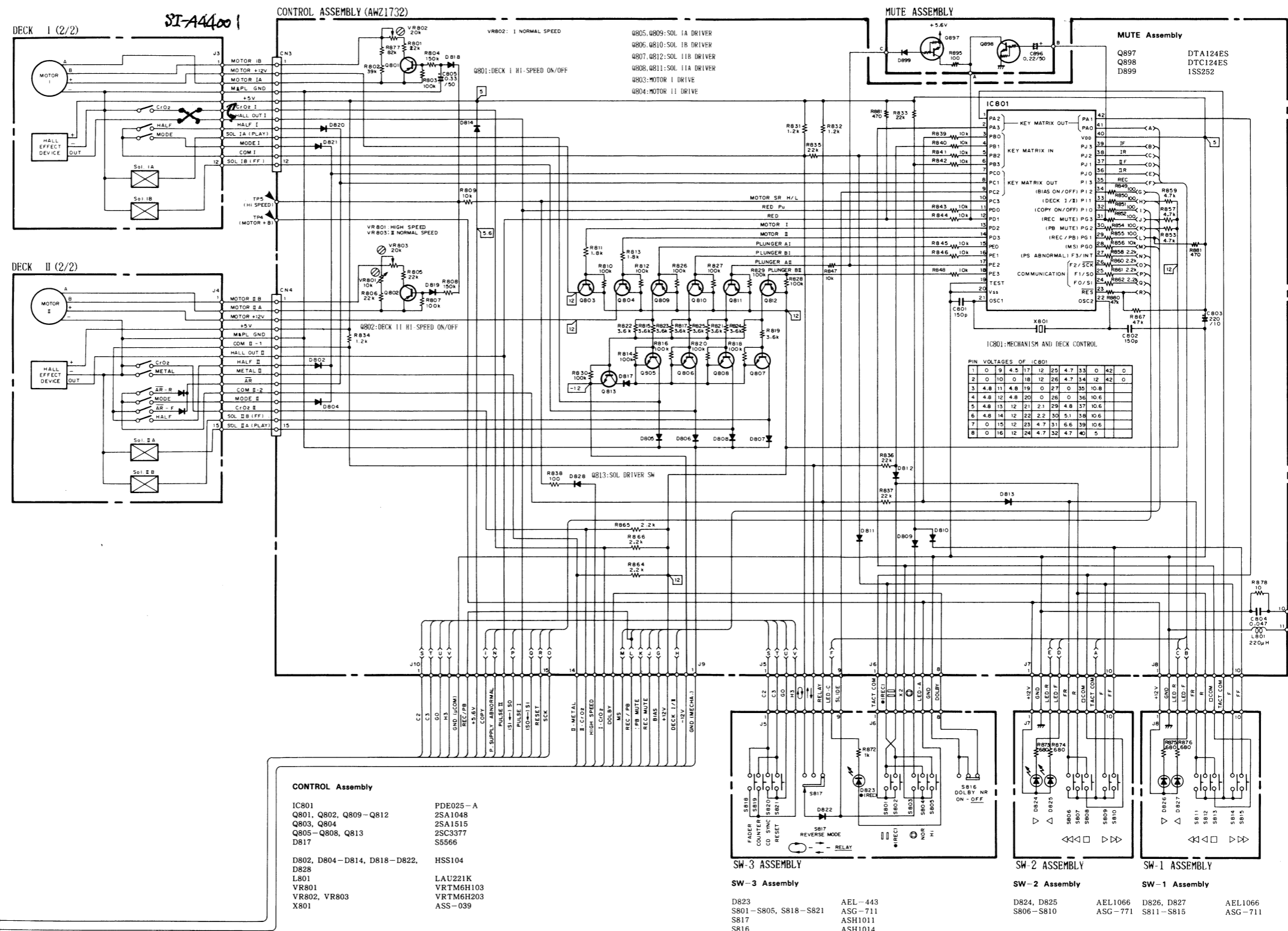
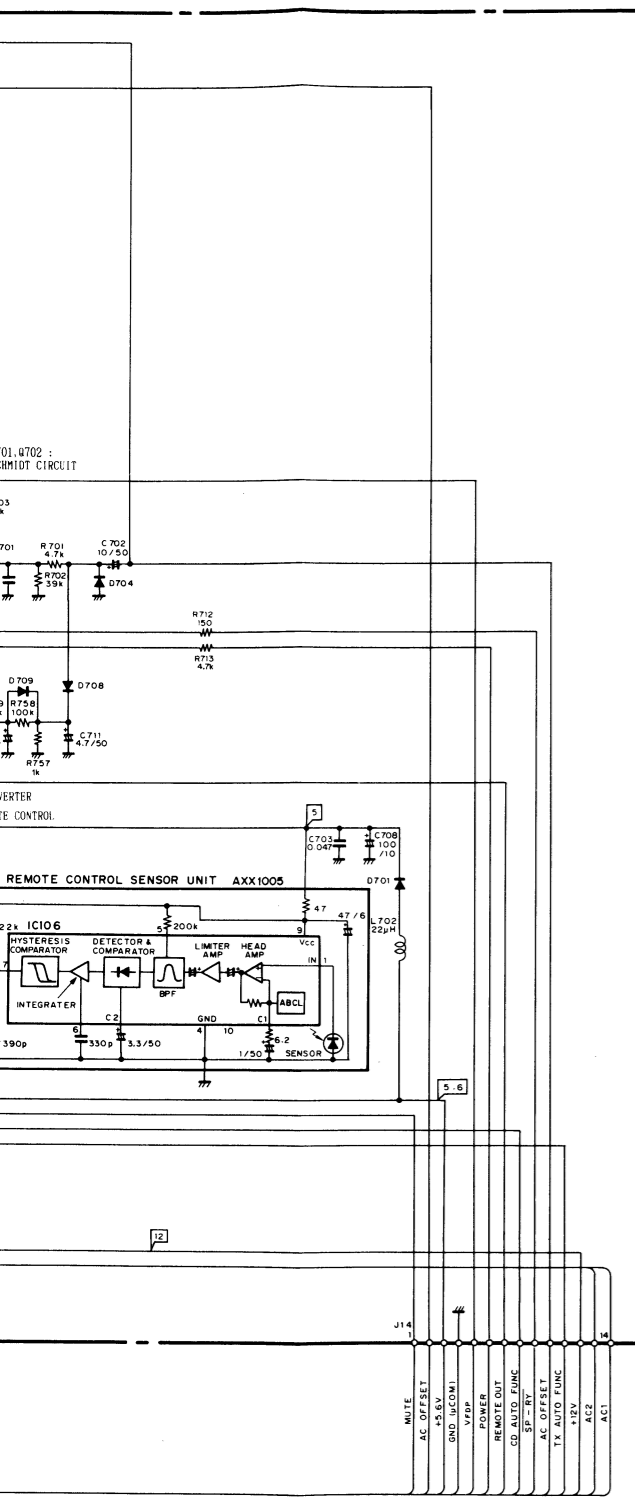

A  
B  
C  
D



# 6. P.C. BOARDS CONNECTION DIAGRAM

A

B

C

D

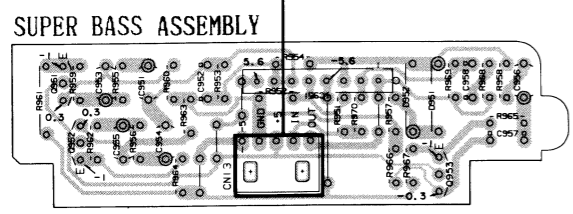
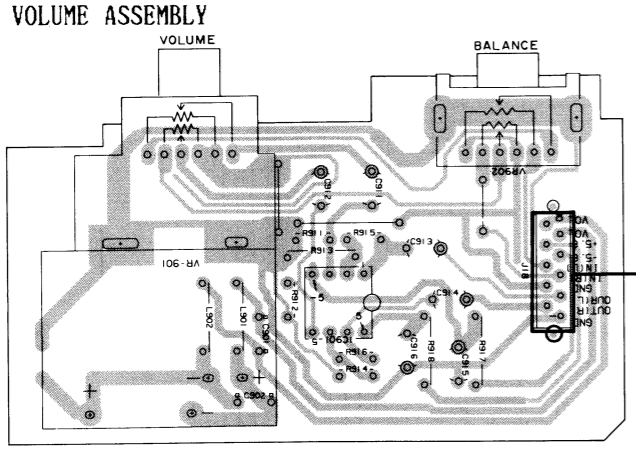
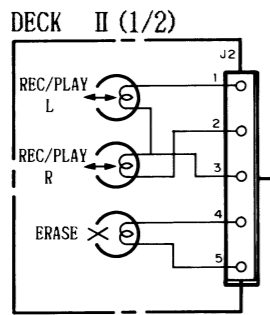
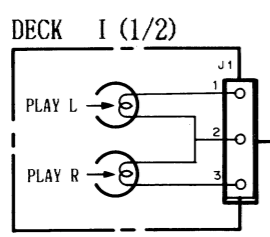

- Q 421 Q 301
- Q 415 Q 303
- Q 417 Q 413 Q 305
- Q 420 Q 302 Q 310
- Q 416 Q 304 Q 309
- Q 418 IC301 Q 308
- Q 419 Q 318 Q 311
- Q 312

- Q 426 Q 319
- Q 425 Q 321 IC302
- Q 423 Q 320
- Q 424 Q 422
- Q 427

- Q 326 IC303
- Q 328
- Q 327 IC401

- IC304

- Q 331
- Q 329
- Q 330 Q 407
- Q 316 Q 314
- Q 428 Q 313
- Q 317 Q 408
- Q 409 IC203

- Q 322 IC403
- IC402 Q 405

- Q 410
- Q 412 Q 404
- Q 403 IC202

- Q 204 Q 402
- Q 406
- Q 205 Q 202
- Q 401

- IC207
- IC204 IC201
- Q 201

- IC205
- IC206

- Q 206

- Q 505
- Q 508
- Q 521
- Q 520
- Q 519 Q 504
- Q 517
- Q 514

- IC305
- IC502
- Q 501 Q 511
- Q 502 Q 516
- Q 518 Q 507
- Q 512 Q 506
- Q 522 Q 513
- Q 510 Q 503
- IC501
- Q 509

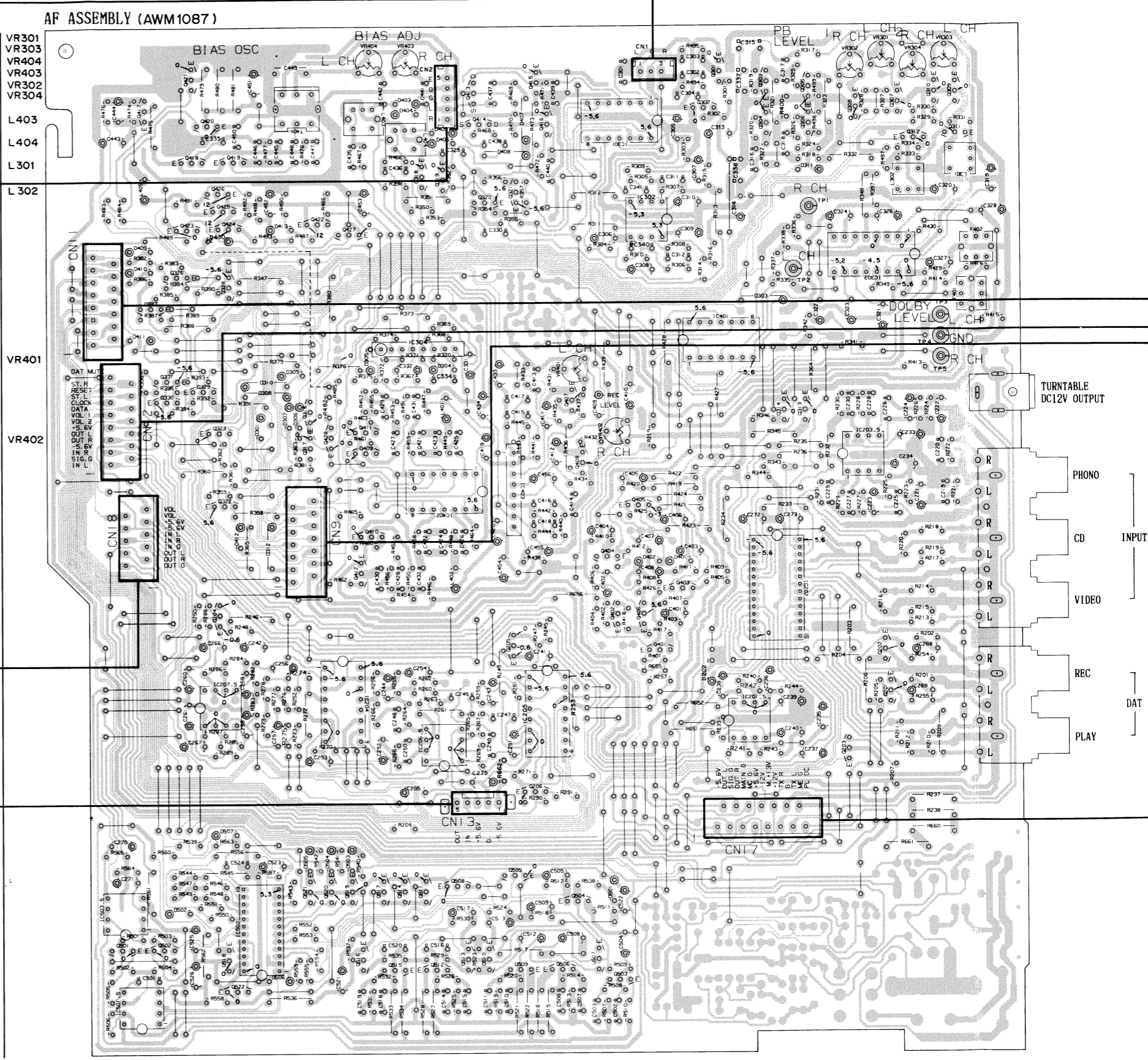

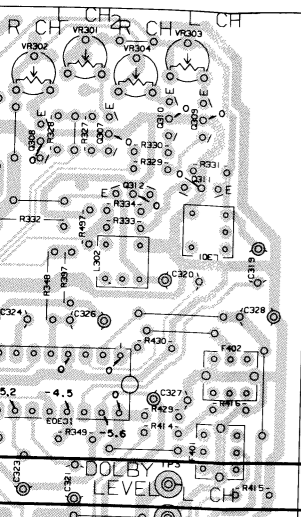

CONNECT ASSEMBLY

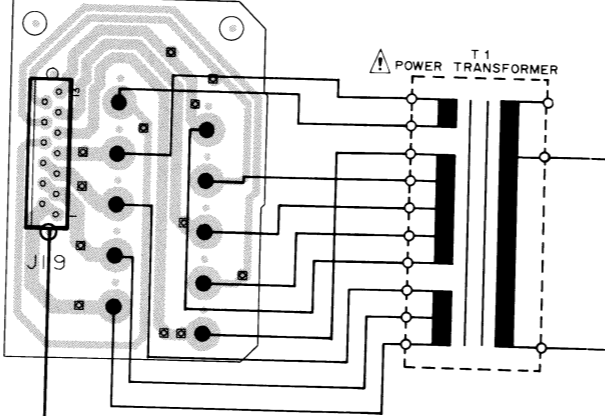

POWER SUPPLY ASSEMBLY

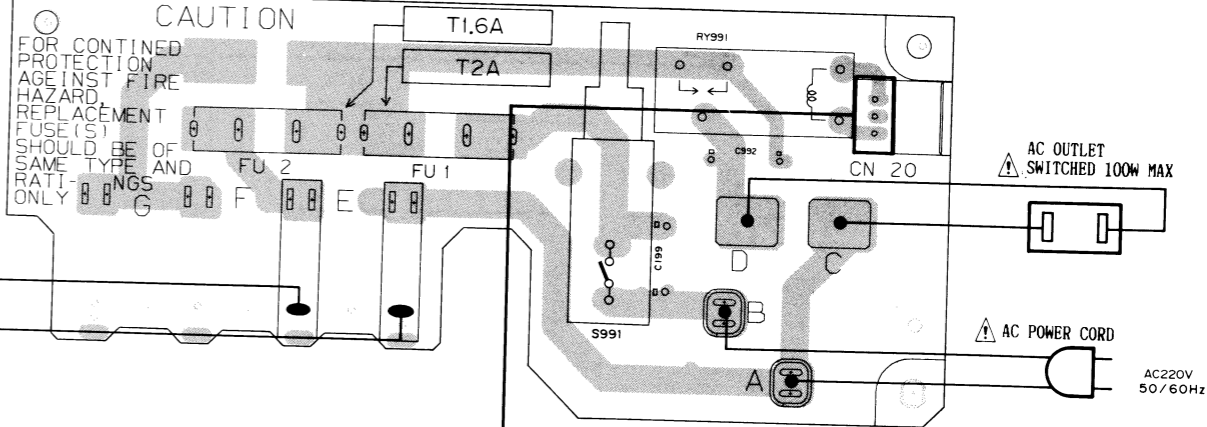

POWER ASSEMBLY (AWZ1740)

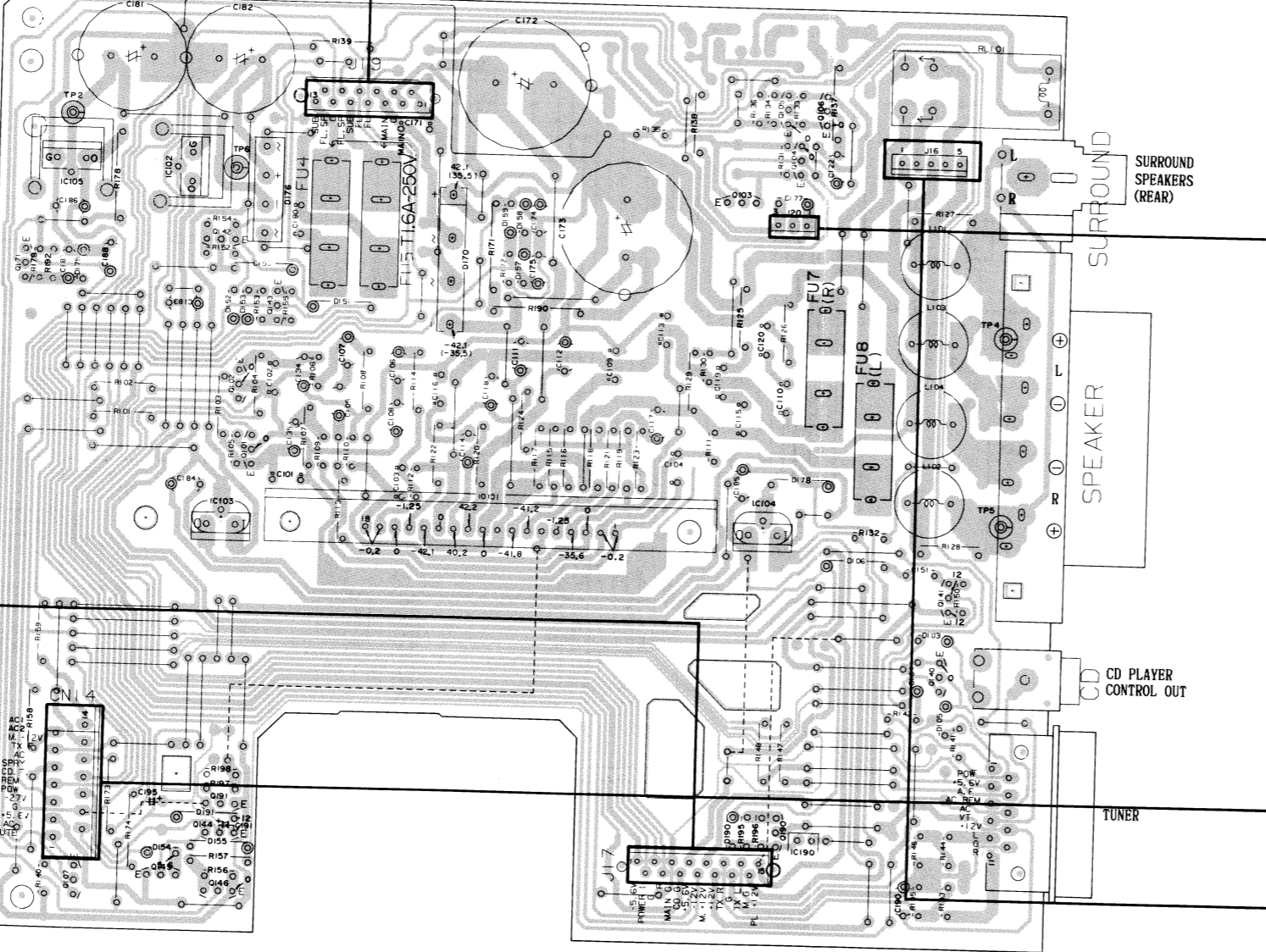

TURNTABLE DC12V OUTPUT

PHONO

CD INPUT

VIDEO

REC

DAT

PLAY

MIC H.P. ASSEMBLY

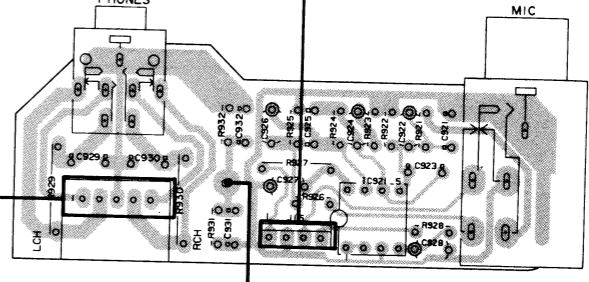

11

12

9

14

15



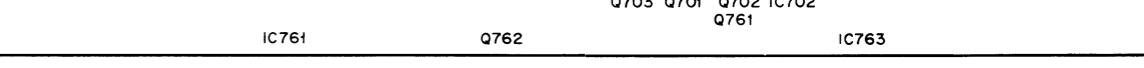
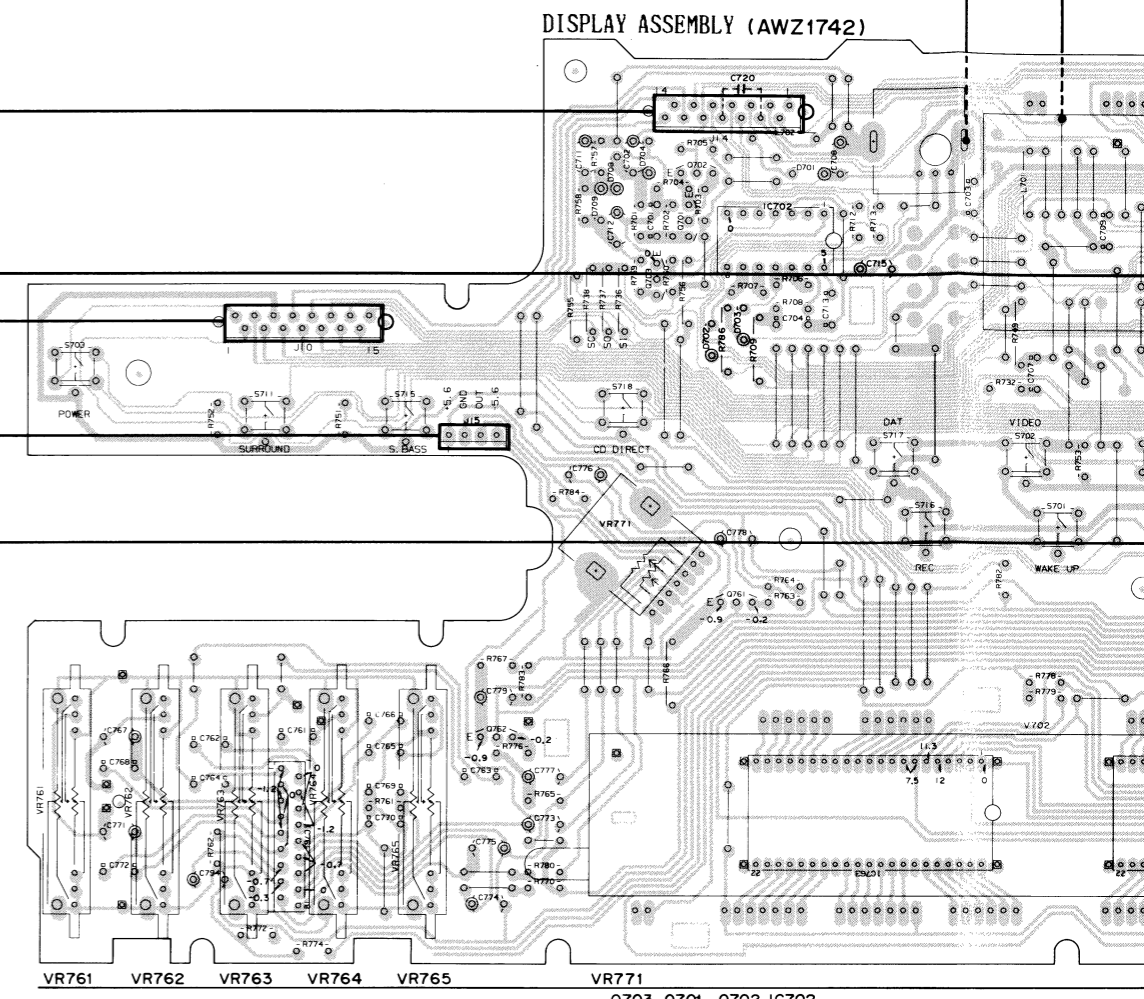
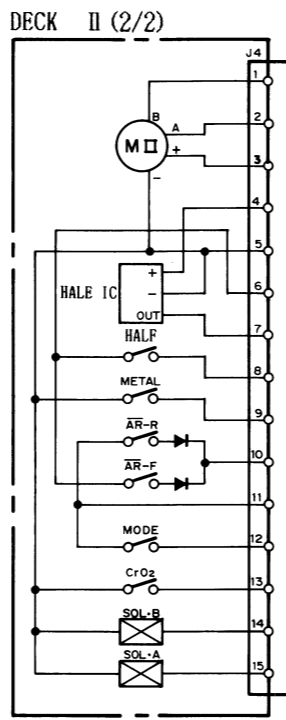
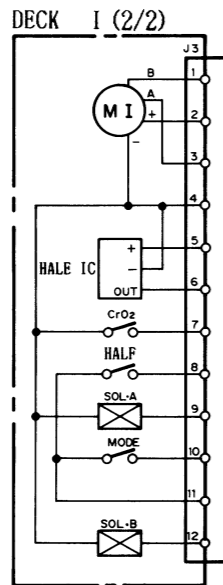

- 11
- 12
- 9
- 14
- 15

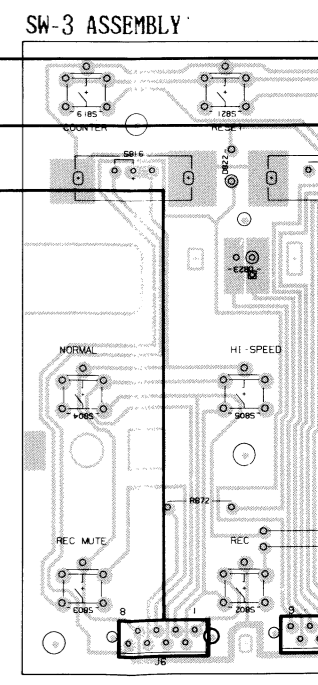
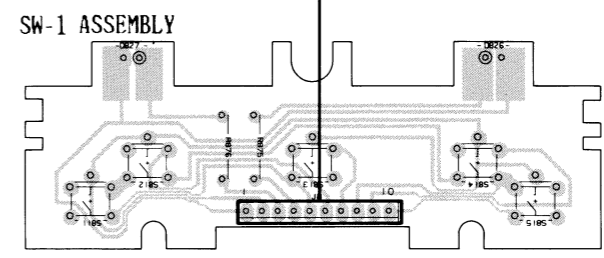
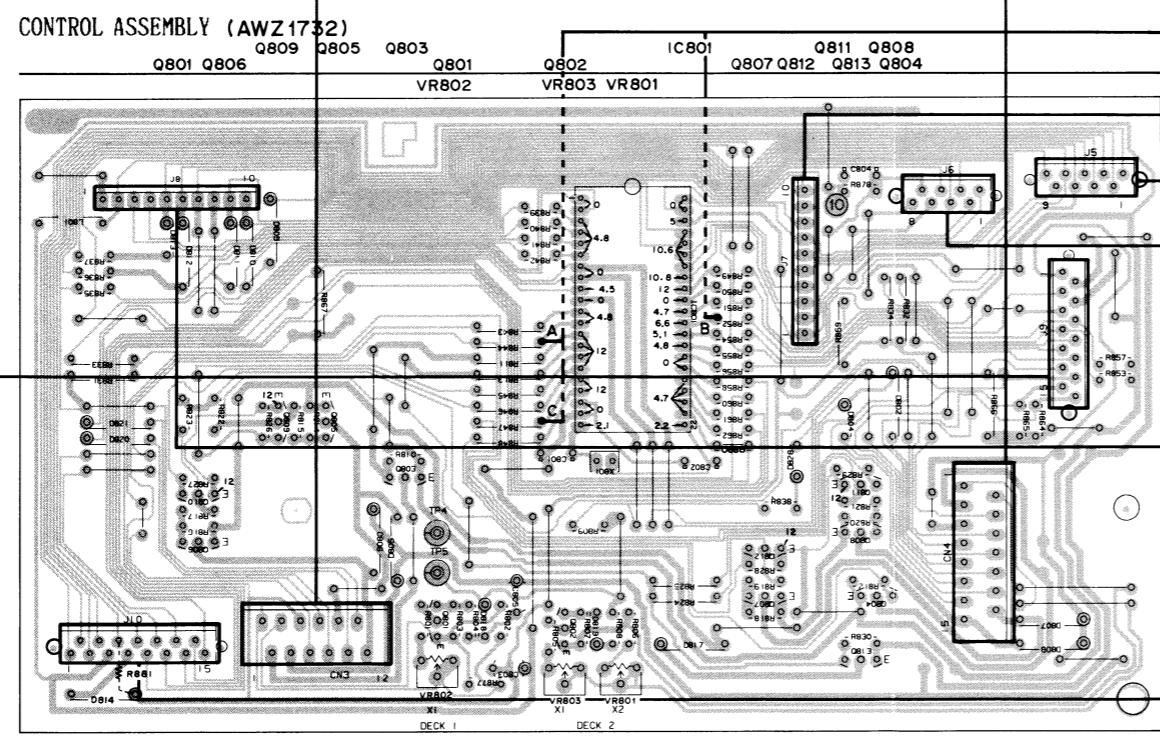

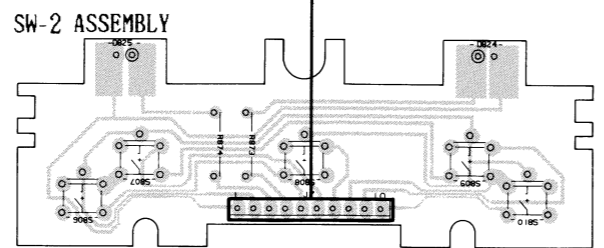
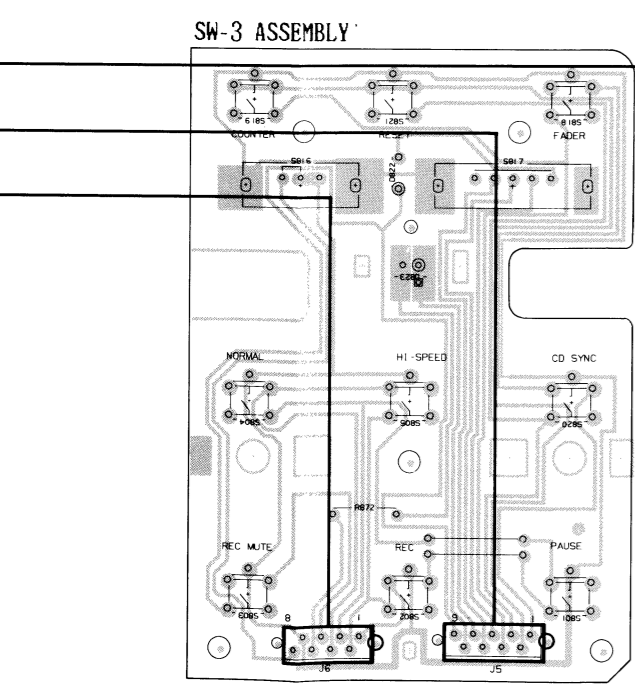
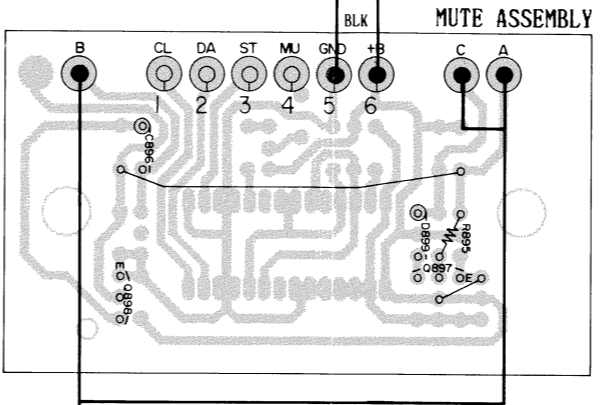
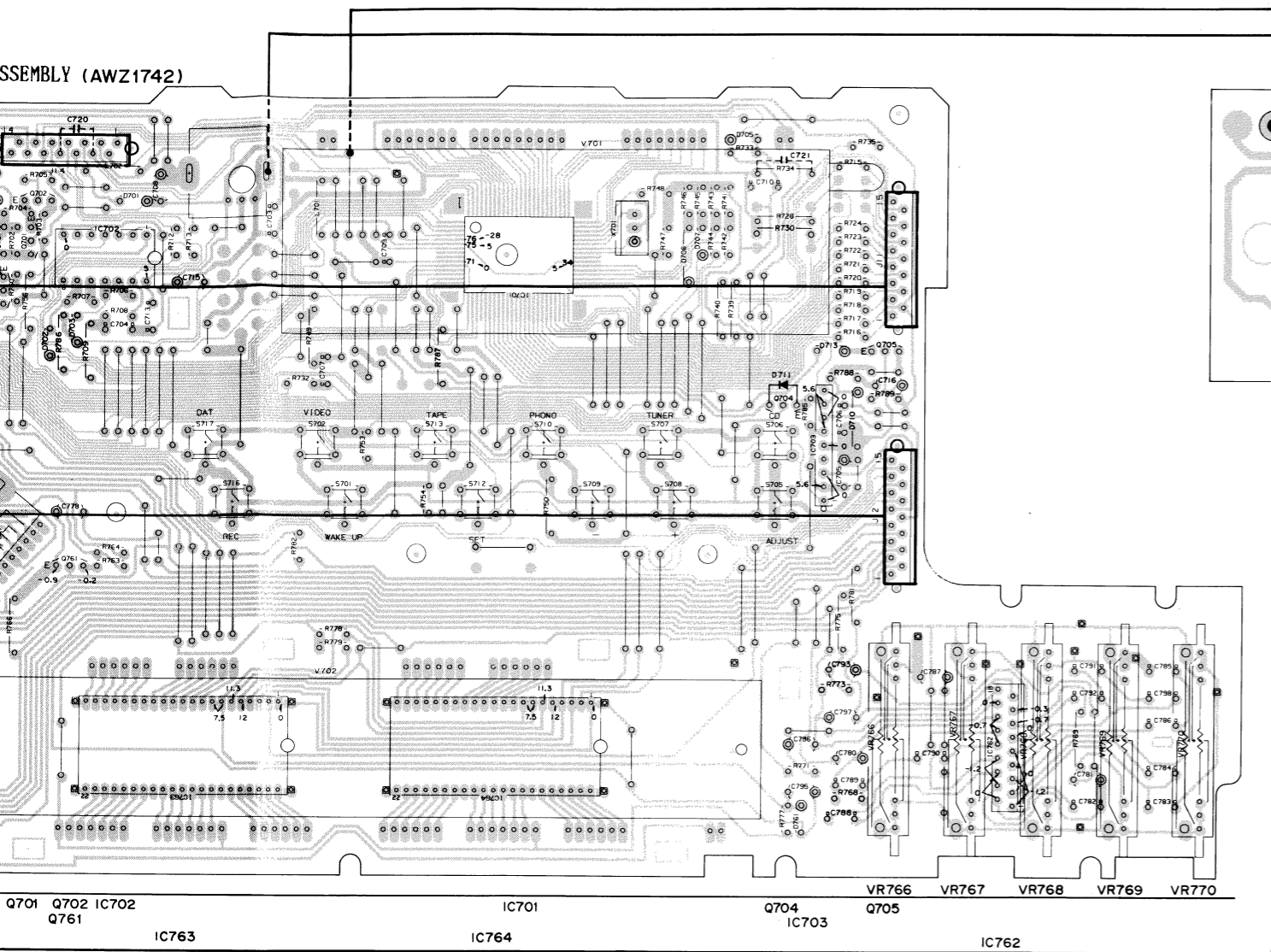

- NOTE
1. This P.C.B connection diagram is viewed from the parts mounted side.
  2. The parts which have been mounted on the board can be replaced with those shown with the corresponding wiring symbols in the following Table.

P.C.B. pattern diagram indication	Corresponding part symbol	Part Name
		Transistor
		Radiator type transistor
		Diode
		Resistor
		Capacitor (Polarity)
		Capacitor (Non-polarity)

Others

P.C.B. pattern diagram indication	Part Name
IC	IC
S	Switch
RY	Relay
L	Coil
F	Filter
VR	Variable resistor or Semi-fixed resistor

3. The capacitor terminal marked with ⊙ (double circles) shows negative terminal.
4. The diode terminal marked with ⊙ (double circles) shows cathode side.
5. The transistor terminal to which E is affixed shows the emitter.

A  
B  
C  
D

This diagram is as seen from foil side.

A

B

C

D

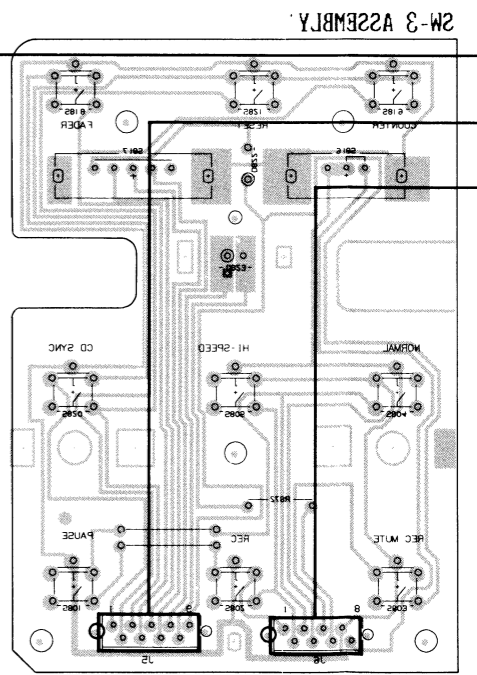
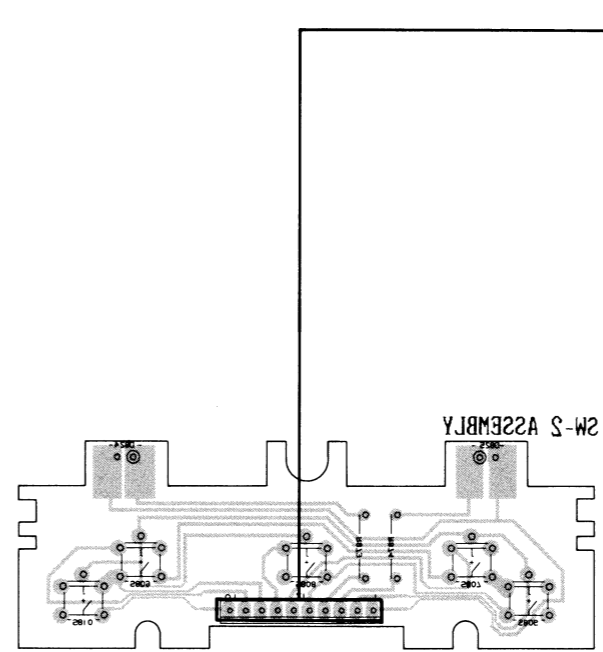
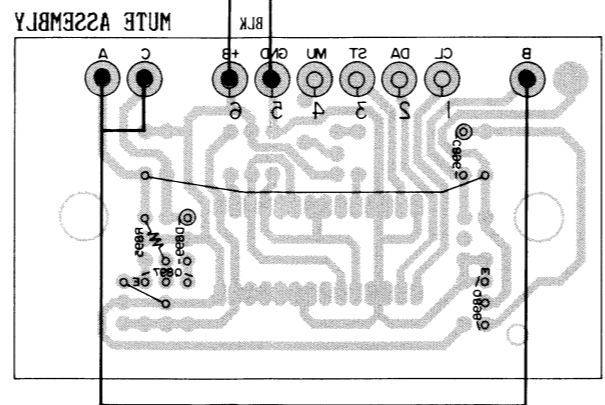
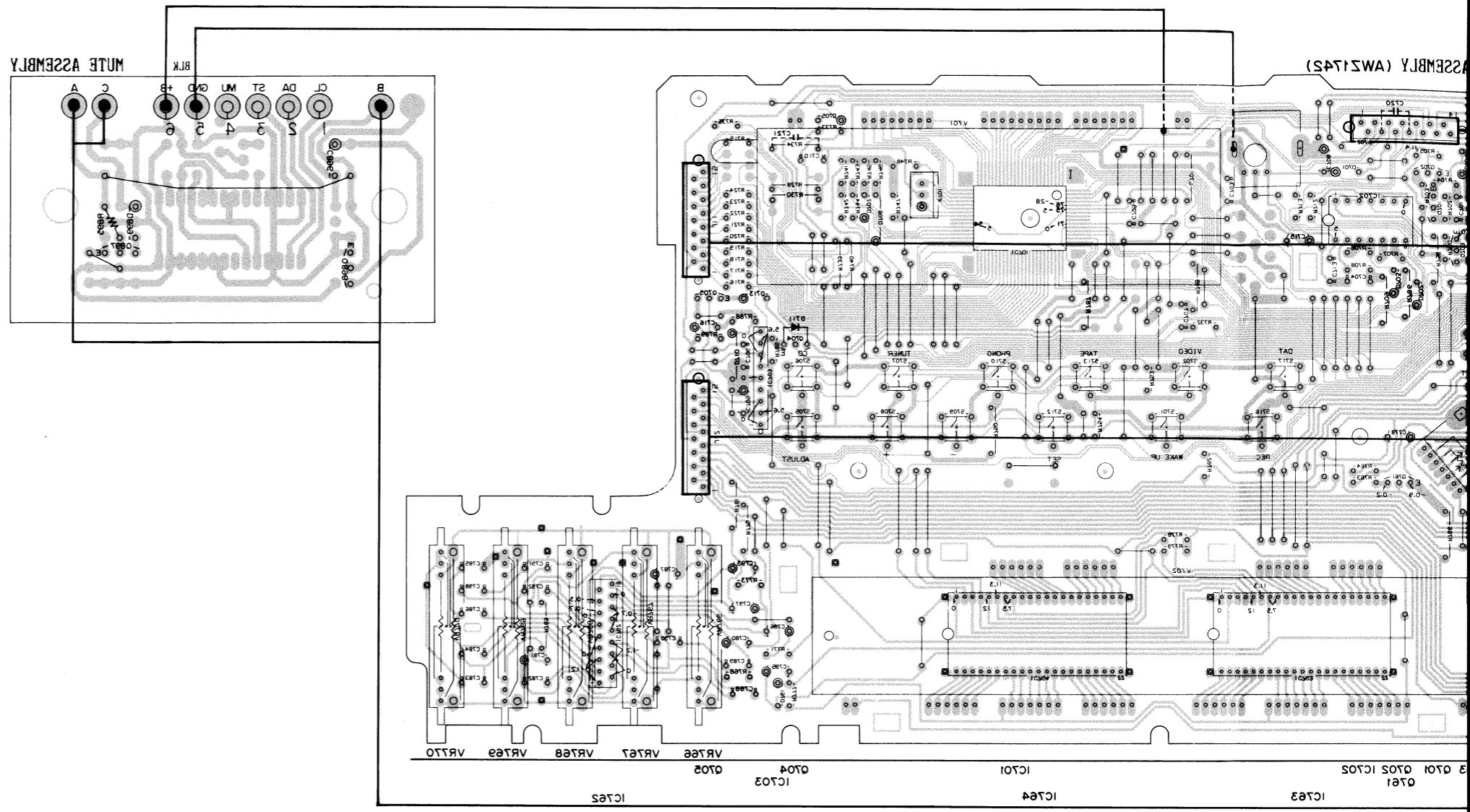



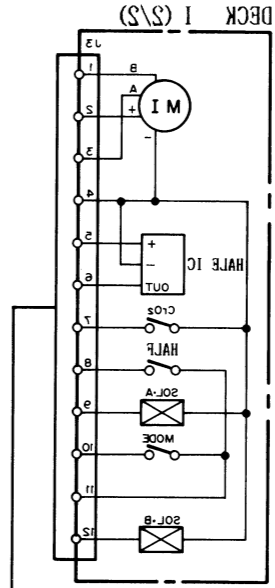
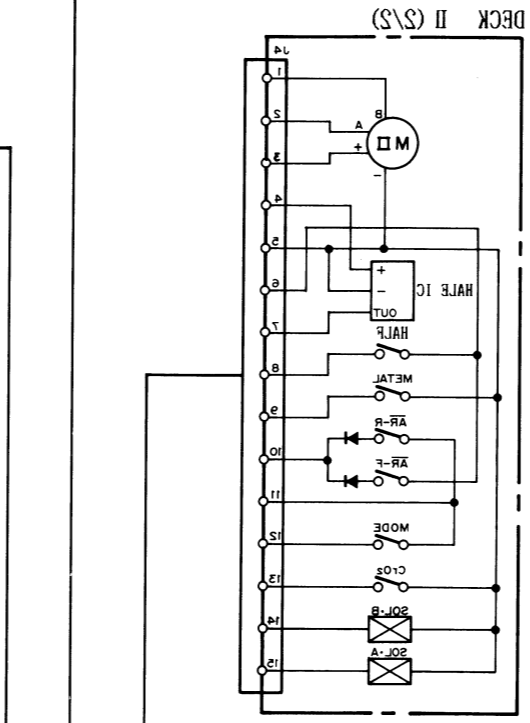
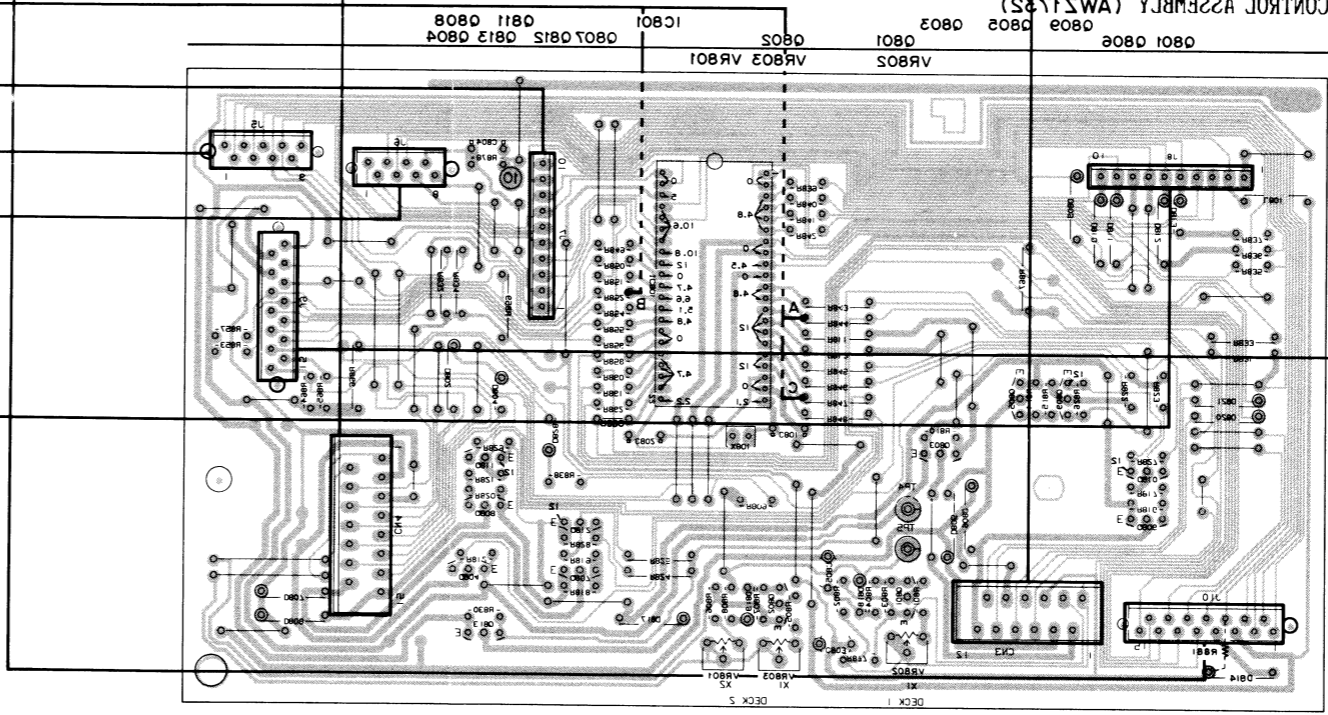
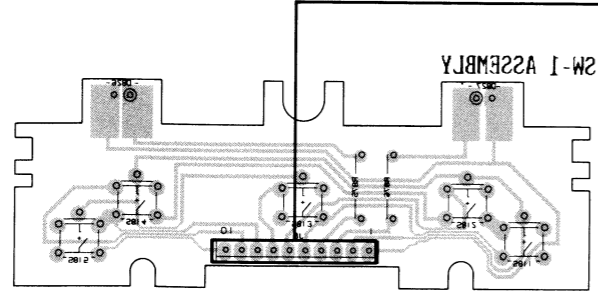
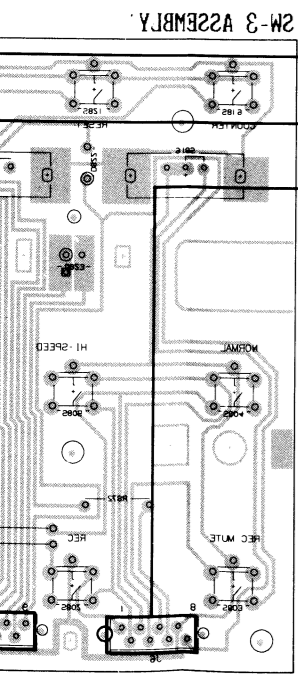
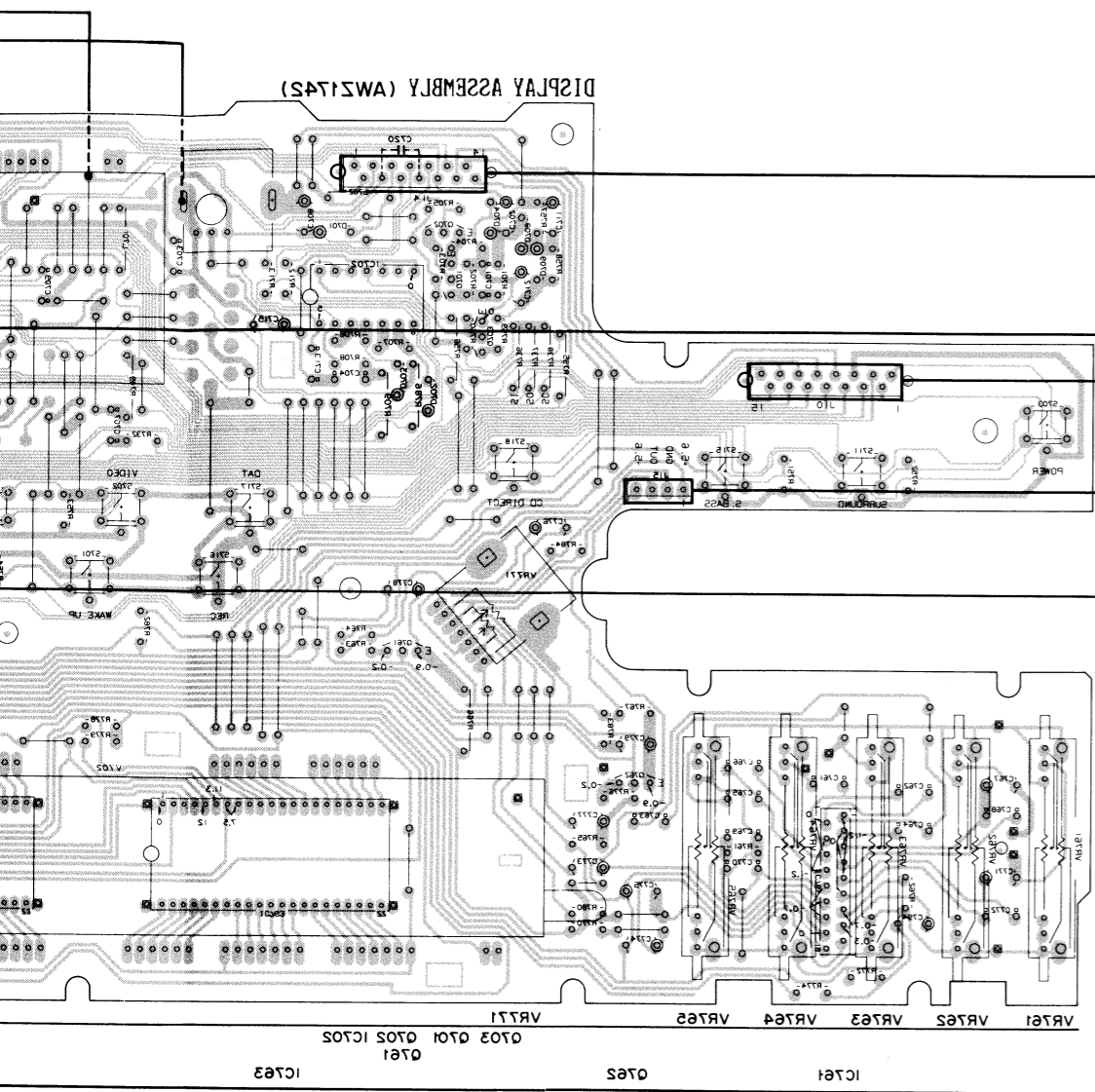

6

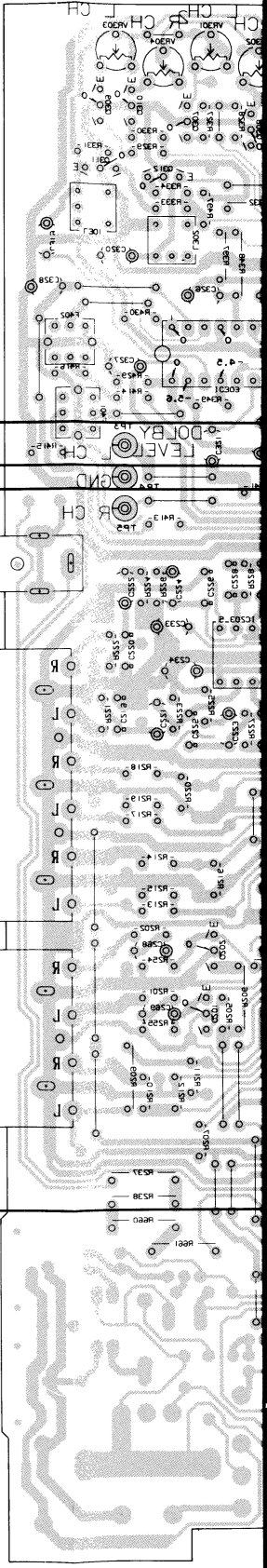

7

0141  
 0140  
 0141  
 0103 IC104  
 IC101  
 0101  
 0105  
 0143  
 0171  
 0145  
 IC105  
 0104  
 0103  
 0102

8

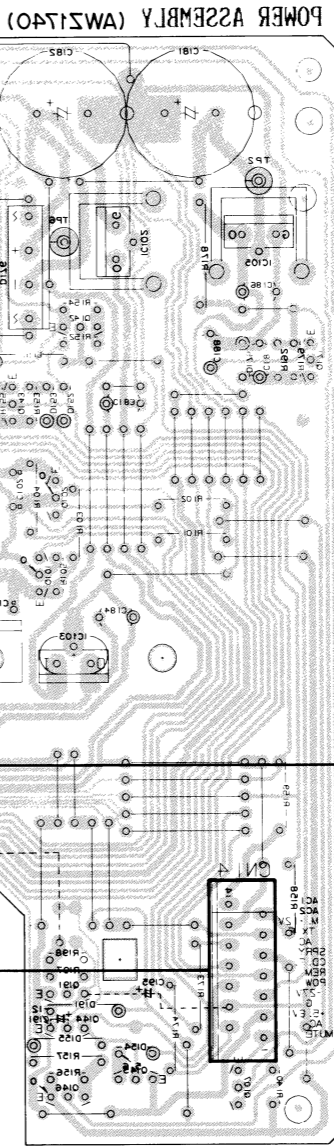

9

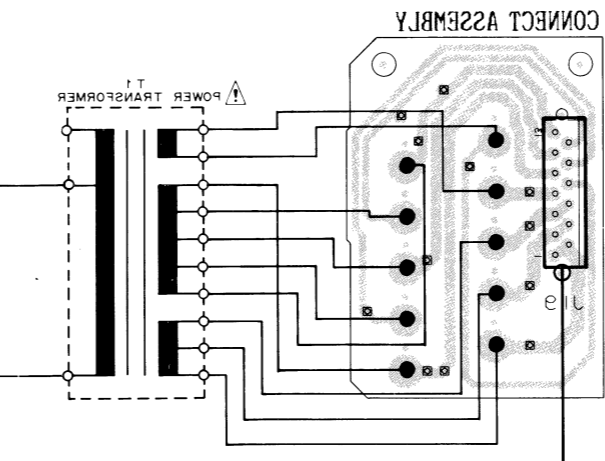

10

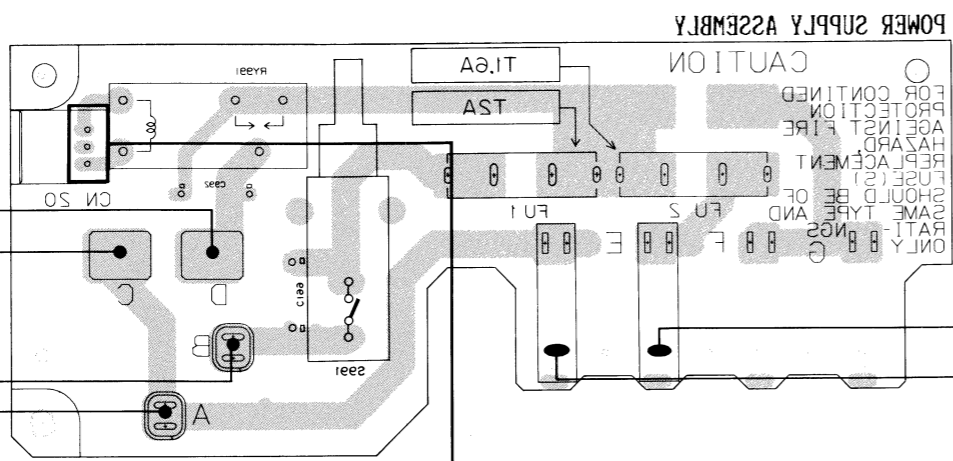

11

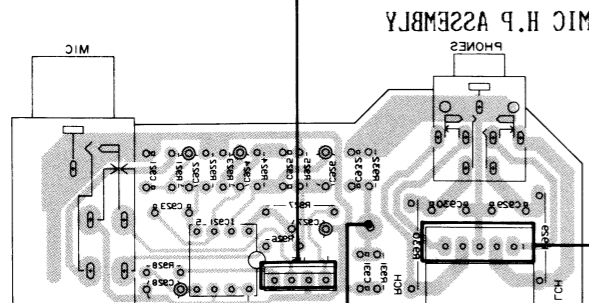

11  
 15  
 a  
 14  
 13

6

7

8

9

10

11

15







# 7. ELECTRICAL PARTS LIST

**NOTES :**

- Parts without part number cannot be supplied.
- Parts marked by "O" are not always kept in stock. Their delivery time may be longer than usual or they may be unavailable.
- The  $\Delta$  mark found on some component parts indicates the importance of the safety factor of the part. Therefore, when replacing, be sure to use parts of identical designation.
- For your parts Stock Control, the fast moving items are indicated with the marks **★★** and **★**.

**★★ GENERALLY MOVES FASTER THAN ★.**

This classification shall be adjusted by each distributor because it depends on model number, temperature, humidity, etc.

- When ordering resistors, first convert resistance values into code form as shown in the following examples.

Ex.1 When there are 2 effective digits (any digit apart from 0), such as 560 ohm and 47k ohm (tolerance is shown by J=5%, and K=10%).

560 $\Omega$	56 $\times 10^1$	561	RD1/4PS	$\begin{matrix} 5 & 6 & 1 \\   &   &   \\ \hline \end{matrix}$ J
47k $\Omega$	47 $\times 10^3$	473	RD1/4PS	$\begin{matrix} 4 & 7 & 3 \\   &   &   \\ \hline \end{matrix}$ J
0.5 $\Omega$	0R5		RN2H	$\begin{matrix} 0 & R & 5 \\   &   &   \\ \hline \end{matrix}$ K
1 $\Omega$	010		RSIP	$\begin{matrix} 0 & 1 & 0 \\   &   &   \\ \hline \end{matrix}$ K

Ex.2 When there are 3 effective digits (such as in high precision metal film resistors).

5.62k $\Omega$	562 $\times 10^1$	5621	RN1/4SR	$\begin{matrix} 5 & 6 & 2 & 1 \\   &   &   &   \\ \hline \end{matrix}$ F
----------------	-------------------	------	---------	--

## Miscellaneous Parts

## P.C BOARD ASSEMBLIES

Mark	Symbol & Description	Part No.
------	----------------------	----------

	AF Assembly	AWM1087
	CONTROL Assembly	AWZ1732
	DISPLAY Assembly	AWZ1742
	POWER Assembly	AWZ1740
	SW-1 Assembly	

	SW-2 Assembly	
	SW-3 Assembly	
	VOLUME Assembly	
	MIC, H·P Assembly	
	SUPER BASS Assembly	

$\Delta$	POWER SUPPLY Assembly	
$\Delta$	MUTE Assembly	
$\Delta$	CONNECT Assembly	

## OTHERS

Mark	Symbol & Description	Part No.
------	----------------------	----------

$\Delta$ ★	T1 Power transformer (AC220/240V)	ATS1120
$\Delta$	AC Socket (AC OUTLET)	AKP1024
$\Delta$ ★★	FU2, FU4, FU5 (T1.6A/250V)	AEK-405
$\Delta$ ★★	FU6, FU7 (T3.15A/250V)	AEK-042
$\Delta$ ★★	FU1 (T2A/250V)	AEK-017
$\Delta$	AC power cord	ADG1021
★★	Hall IC	AZE1018
★★	Motor	AZX1019
★★	Leaf switch (MODE)	AZS1054
★★	Leaf switch (CrO <sub>2</sub> )	AZS1034
★★	PLAY head (Deck I only)	AZP1022
★★	REC/PLAY/ERASE head (Deck II only)	AZP1014
★	Diode (Deck II only)	1S2473

Mark	Symbol & Description	Part No.
------	----------------------	----------

★★	Motor assembly	AZX1020
★★	Head base assembly (Deck I only)	AZP1023
★★	Head base assembly (Deck II only)	AZP1016
	Remote control unit	AXD1042

## AF Assembly (AWM1087)

## SEMICONDUCTORS

Mark	Symbol & Description	Part No.
------	----------------------	----------

★★	IC303	CXA1100P
★★	IC304, IC403	M5218LF
★★	IC302	M5218P
★★	IC201, IC203, IC206, IC501, IC503	M5218PF
★★	IC207	NJM4558DX
★★	IC402	M74LS05P
★★	IC502	PD4142
★★	IC204, IC205	TC4053BP
★★	IC301, IC401	TC4066BP

★★	IC202	TC9162N
★★	Q505, Q508, Q511, Q514, Q517	RN1201
★★	Q501, Q502, Q522	RN1203
★★	Q518-Q521	RN2203
★★	Q203, Q320, Q322, Q326, Q327, Q329, Q422	2SA1048

★★	Q417, Q426	2SA1115
★★	Q418, Q419	2SA1515
★★	Q204, Q205	2SC1740SLN
★★	Q206, Q301-Q314, Q316-Q319, Q321, Q323, Q328, Q330, Q331, Q401-Q406, Q409-Q412, Q415, Q416, Q423, Q427, Q428, Q503, Q504, Q506, Q507, Q509, Q510, Q512, Q513, Q515, Q516	2SC2458

Mark	Symbol & Description	Part No.
------	----------------------	----------

★★	Q420, Q421, Q424, Q425	2SC2603
★★	Q201, Q202, Q407, Q408	2SC2878
★★	Q413, Q414	2SK373
★	D413	HZS7B2L
★	D502-D505	RD7.5ESB
★	D301, D303-D312, D403-D406, D409-D412, D501, D506, D507	HSS104
★	D401, D402	1SS252
★	D407, D408	1S2471
★	D430	HZS5ALL
★	D202	RD10ESB

## COILS, TRANSFORMER, FILTERS

Mark	Symbol & Description	Part No.
------	----------------------	----------

	L403, L404 Trap coil	ATM-037
	L301, L302 Trap coil	ATM1001
	L405 Inductor (1mH)	LTA102J
	L401, L402 Inductor (3.9mH)	LTA392J
	T401 Bias oscillation transformer	ATX-043
	F401, F402 Dolby filter	ATF-210

## CAPACITORS

Mark	Symbol & Description	Part No.
------	----------------------	----------

	C449 (1500p/630V)	ACE-133
	C441, C442	CCCSL101K500
	C437, C438	CCMSL100D50
	C219, C220, C225, C226, C340, C341, C413, C414, C501	CCMSL101J50

	C249, C250	CCMSL121J50
	C512	CEASR15M50
	C443, C508	CEASR47M50
	C323, C324	CEASR68M50
	C221, C222, C332	CEASOR1M50

	C243, C244, C270, C271, C331, C405, C409-C412	CEASO10M50
	C504	CEAS1R5M50
	C408	CEASR33M50
	C401-C404, C407	CEAS100M50

	C233, C234, C239, C240, C253, C254, C260, C261, C272, C273, C327, C328	CEAS101M10
	C453	CEAS101M16
	C251, C252, C326, C433, C434	CEAS2R2M50

	C223, C224	CEAS3R3M50
	C258, C259, C307, C308, C522	CEAS220M16
	C419, C420	CEAS330M16
	C452	CEAS331M16
	C275	CEAS221M10

	C235-C238, C268, C269, C305, C306, C313, C314, C319-C322, C451, C505, C509, C513, C517, C521	CEAS4R7M50
	C241, C242, C255-C257, C226, C267, C309, C310, C406, C444, C454-C456, C523, C525, C526	CEAS470M16

Mark	Symbol & Description	Part No.
------	----------------------	----------

	C229, C230	CKCYB562K50
	C510, C511	CKCYB682K50
	C329, C330	CKCYF473Z50
	C506, C507	CKCYX153M25
	C502, C503, C516, C520, C524	CKCYX473M25

	C337, C338	CKDYB182K50
	C227, C228	CKMYB152K50
	C450	CKMYB221K50
	C301, C302	CKMYB271K50
	C245-C248, C303, C304	CKMYB471K50

	C334	CCCSL560J50
	C435, C436, C439, C440, C518, C519	CKMYB681K50
	C335	CKDYB681K50
	C514, C515	CKMYF222Z50

	C446, C447	CQMA103J50
	C448	CQMA123K250
	C425, C426, C445	CQMA153J50
	C415, C416	CQMA182J50
	C317, C318	CQMA183J50

	C427, C428	CQMA223J50
	C315, C316	CQMA273J50
	C311, C312	CQMA332J50
	C429, C430	CQMA393J50
	C431, C432	CQMA427J50

	C423, C424	CQMA562J50
	C421, C422	CQMA681J50
	C417, C418	CQMA683J50

## RESISTORS

Mark	Symbol & Description	Part No.
------	----------------------	----------

	R237, R238, R660, R661	RD $\frac{1}{2}$ PMFL100J
	R479-R481	RD $\frac{1}{2}$ PM□□□J
	R561, R562	RD $\frac{1}{4}$ PM470J
★	VR301-VR304, VR401, VR402 Semi-fixed (20k)	VRTM6VS203

★	VR403, VR404 Semi-fixed (2M)	VRTM6VS204
	Other resistors	RD $\frac{1}{8}$ PM□□□J

## OTHERS

Mark	Symbol & Description	Part No.
------	----------------------	----------

	Pin jack 4P (DAT REC/PLAY)	AKB1009
	Pin jack 6P (Input-PHONO, CD, VIDEO)	AKB1023
	DC jack (DC12V OUTPUT)	AKN-203

## CONTROL Assembly

### SEMICONDUCTORS

Mark	Symbol & Description	Part No.
------	----------------------	----------

★★	IC801	
★★	Q801, Q802, Q803, Q804	
★★	Q805-Q808, Q809	
★	D817	
★	D802, D804-D808, D828	

### COIL

Mark	Symbol & Description	Part No.
------	----------------------	----------

L801 Inductor

### CAPACITORS

Mark	Symbol & Description	Part No.
------	----------------------	----------

C805  
C803  
C804  
C801, C802

### RESISTORS

Mark	Symbol & Description	Part No.
------	----------------------	----------

★ VR801 Semi-fixed  
★ VR802, VR803 Semi-fixed  
Other resistors

### OTHERS

Mark	Symbol & Description	Part No.
------	----------------------	----------

★ X801 Ceramic resistor

## DISPLAY Assembly

### SEMICONDUCTORS

Mark	Symbol & Description	Part No.
------	----------------------	----------

★★	IC761, IC762	
★★	IC763, IC764	
★★	IC701	
★★	IC703	
★★	IC702	
★★	Q704	
★★	Q761, Q762	
★★	Q701-Q703	
★★	Q705	
★★	D710	

★	D761	
★	D701-D709	

Part No.

CKCYB562K50  
CKCYB682K50  
CKCYF473Z50  
CKCYX153M25  
CKCYX473M25  
CKDYB182K50  
CKMYB152K50  
CKMYB221K50  
CKMYB271K50  
CKMYB471K50

CCCSL560J50  
CKMYB681K50

CKDYB681K50  
CKMYF222Z50

CQMA103J50  
CQMA123K250  
CQMA153J50  
CQMA182J50  
CQMA183J50

CQMA223J50  
CQMA273J50  
CQMA332J50  
CQMA393J50  
CQMA427J50

CQMA562J50  
CQMA681J50  
CQMA683J50

Part No.

RD $\frac{1}{2}$ PMFL100J  
RD $\frac{1}{2}$ PM□□□J  
RD $\frac{1}{4}$ PM470J  
RTM6VS203

RTM6VS204

RD $\frac{1}{2}$ PM□□□J

Part No.

KB1009  
KB1023  
KN-203

**CONTROL Assembly (AWZ1732)**

**SEMICONDUCTORS**

Mark	Symbol & Description	Part No.
★★	IC801	PDE025-A
★★	Q801, Q802, Q809-Q812	2SA1048
★★	Q803, Q804	2SA1515
★★	Q805-Q808, Q813	2SC3377
★	D817	S5566
★	D802, D804-D814, D818-D822, HSS104 D828	

**COIL**

Mark	Symbol & Description	Part No.
	L801 Inductor	LAU221K

**CAPACITORS**

Mark	Symbol & Description	Part No.
	C805	CEASR33M50
	C803	CEAS221M10
	C804	CKDYF473Z50
	C801, C802	CKMYB151K50

**RESISTORS**

Mark	Symbol & Description	Part No.
★	VR801 Semi-fixed (10k)	VRTM6H103
★	VR802, VR803 Semi-fixed (20k)	VRTM6H203
	Other resistors	RD $\frac{1}{2}$ PM□□□J

**OTHERS**

Mark	Symbol & Description	Part No.
★	X801 Ceramic resonator (800kHz) ASS-039	

**DISPLAY Assembly (AWZ1742)**

**SEMICONDUCTORS**

Mark	Symbol & Description	Part No.
★★	IC761, IC762	BA3812L
★★	IC763, IC764	LC7570
★★	IC701	PDG015-B
★★	IC703	TA7291S
★★	IC702	TC4069UBP
★★	Q704	2SA1115
★★	Q761, Q762	2SC1740SLN
★★	Q701-Q703	2SC2458
★★	Q705	DTA143ES
★★	D710	RD4.7ESB
★	D761	RD7.5ESB3
★	D701-D709	HSS104

**SWITCHES**

Mark	Symbol & Description	Part No.
★★	S701-S703, S705-S713, S715-S718 Tact switch (WAKE-UP, VIDEO, POWER, CLOCK ADJUST, CD, TUNER, +, -, PHONO, SURROUND & STEREO WIDE, SET, TAPE, SUPER BASS, REC TIMER, DAT, CD DIRECT)	ASG-711

**COILS**

Mark	Symbol & Description	Part No.
	L701 Inductor	LAU2R2M
	L702 Inductor	LAU220K

**CAPACITORS**

Mark	Symbol & Description	Part No.
	C770, C790	CCMSL101J50
	C702, C705	CEAS100M50
	C708	CEAS101M10
	C711, C712	CEAS4R7M50
	C767, C781	CEJAR15M50
	C716	CEAS331M6
	C771, C787	CEJAR68M50
	C776, C777, C795	CEJA100M25
	C774, C775, C796, C797, C778, C779	CEJA101M10
	C773, C780, C793, C794	CEJA4R7M50
	C715	CEAS470M16
	C792	CKCYB392K50
	C762, C786	CKDYB182K50
	C764	CKDYB392K50
	C701	CKDYX104M25
	C703, C706, C709, C713	CKDYF473Z50
	C714	CKCYF473Z50
	C704	CKMYB152K50
	C707	CKMYB221K50

	C769, C789	CKMYB331K50
	C766, C784	CKMYB391K50
	C761, C785	CQMA153J50
	C768, C782	CQMA183J50
	C791, C798	CQMA333J50
	C772, C788	CQMA393J50
	C765, C783	CQMA682J50
	C763	CQMA683J50

**RESISTORS**

Mark	Symbol & Description	Part No.
★	VR771 Variable resistor (30k $\times$ 2)	ACS1017
★	VR761-VR770	ACU1021
	Slide type variable resistor (30k)	
	Other resistors	RD $\frac{1}{2}$ PM□□□J

**OTHERS**

Mark	Symbol & Description	Part No.
★	V702 Fluorescent indicator	AAV1048
★	V701 Fluorescent indicator	AAV1049
★	X701 Ceramic resonator (4.19MHz) Remote control sensor unit AXX1005	ASS1022

**POWER Assembly (AWZ1740)**

**SEMICONDUCTORS**

Mark	Symbol & Description	Part No.
★★	IC190	ICP-N10
★★	IC104	M5F78M05L
△★★	IC101	STK4192-2GP
★★	IC102, IC103	$\mu$ PC7812H
★★	IC105	$\mu$ PC7912H
★★	Q140, Q144	RN1203
★★	Q145, Q191	RN2203
★★	Q107	2SA1048
★★	Q142, Q143	2SA1115
★★	Q141, Q190	2SA1515
★★	Q171	2SB560
★★	Q103-Q105, Q146	2SC2458
★★	Q101, Q102	2SC2878
★★	Q106	2SD438
△★	D170	RBV402
△★	D176	RB152
★	D157, D158	RD11ESB
★	D159	RD5.6ESB
★	D175	RD6.2ESB
△★	D150, D151, D178	S5566
★	D103-D106, D152-D155, D177, HSS104 D190, D191	

**RELAY**

Mark	Symbol & Description	Part No.
★★	RY101 Relay	ASR-111

**COILS**

Mark	Symbol & Description	Part No.
	L101, L102 AF Choke coil (1 $\mu$ H)	ATH-133

**CAPACITORS**

Mark	Symbol & Description	Part No.
△	C171 (0.01 $\mu$ F/150V) C172, C173 (5600 $\mu$ F/56V) C103, C104 C122 C111, C112	ACG1005 ACH1031 CCMSL101J50 CEASR47M100 CEAS100M50

Mark Symbol & Description Part No.

	C109	CEANP100M63
	C114, C116	CEXANP101M25
	C134, C135	CEAS2R2M50
	C113	CEANP220M50
	C105-C108	CEAS101M25
	C181, C182	CEAS332M35
	C117, C118, C185, C187, C188	CEAS470M25
	C183, C184, C186	CEAS470M35
	C191	CEAS330M25
	C195	CEAS010M50
	C174, C175	CEAS470M50
	C121	CEAS471M6
△	C180	CKCYF103Z50
	C101, C102	CKMYB221K50
	C110, C115, C119, C120	CQMA104J50

**RESISTORS**

Mark	Symbol & Description	Part No.
	R139	RD $\frac{1}{2}$ PMFL101J
	R138, R158, R159	RD $\frac{1}{2}$ PM□□□J
△	R116-R119, R125-R128, R103, R104, R113-R115, R121-R124, R147, R148	RD $\frac{1}{4}$ PMFL□□□J RD $\frac{1}{4}$ PM□□□J
△	R120	RFA $\frac{1}{4}$ PS101J
△	R178	RS1LMF680J
△	R137	RS1LMF681J
△	R173, R174	RS1LMF150J
△	R171, R190	RS2LMF221J
	Other resistors	RD $\frac{1}{2}$ PM□□□J

**OTHERS**

Mark	Symbol & Description	Part No.
	Pin jack 2P (SURROUND SPEAKERS)	AKB1039
	Terminal 4P (SPEAKERS)	AKE-109
	Mini jack (CD PLAYER CONTROL OUT)	AKN-207
	Socket 11P (TUNER)	AKP1025

**SW-1 Assembly**

**SEMICONDUCTORS**

Mark	Symbol & Description	Part No.
★	D826, D827	AEL1066

**SWITCHES**

Mark	Symbol & Description	Part No.
★★	S811-S815 Tact switch ( $\leftarrow$ , $\leftarrow$ , $\blacksquare$ , $\rightarrow$ , $\rightarrow$ )	ASG-711

## RESISTORS

Mark	Symbol & Description	Part No.
	R875, R876	RD $\frac{1}{4}$ PM681J

## SW- 2 Assembly

## SEMICONDUCTORS

Mark	Symbol & Description	Part No.
★	D824, D825	AEL1066

## SWITCHES

Mark	Symbol & Description	Part No.
★★	S806-S810 Tact switch (◀, ◁, ■, ▷, ▶)	ASG-771

## RESISTORS

Mark	Symbol & Description	Part No.
	R873, R874	RD $\frac{1}{4}$ PM681J

## SW- 3 Assembly

## SEMICONDUCTORS

Mark	Symbol & Description	Part No.
★	D823	AEL-443

## SWITCHES

Mark	Symbol & Description	Part No.
★★	S801-S805, S818-S821 Tact switch (PAUSE, REC, REC MUTE, NORMAL COPY, HIGH SPEED COPY, FADER, TAPE COUNTER I / II • OFF, CD SYNCHRO REC, TAPE COUNTER RESET)	ASG-711
★★	S817 Slide switch (REVERSE MODE)	ASH1011
★★	S816 Slide switch (DOLBY NR)	ASH1014

## RESISTORS

Mark	Symbol & Description	Part No.
	R872	RD $\frac{1}{4}$ PM102J

## VOLUME Assembly

## SEMICONDUCTORS

Mark	Symbol & Description	Part No.
★★	IC901	M5218PF

## COILS

Mark	Symbol & Description	Part No.
	L901, L902 Inductor	LAU5R6K

## CAPACITORS

Mark	Symbol & Description	Part No.
	C911-C914 C901, C902 C915, C916	CEAS4R7M50 CKDYF473Z50 CEAS470M16

## RESISTORS

Mark	Symbol & Description	Part No.
★	VR902 Variable resistor (10k×2)	ACT1041
★	VR901 Variable resistor with motor (100k×2)	ACX1009
	Other resistors	RD $\frac{1}{8}$ PM□□□J

## MIC, H . P Assembly

## SEMICONDUCTORS

Mark	Symbol & Description	Part No.
★★	IC921	M5218PF

## CAPACITORS

Mark	Symbol & Description	Part No.
	C923 C922 C924 C926 C927, C928	CCMSL101J50 CEAS010M50 CEAS100M50 CEAS220M16 CEAS470M16
	C925 C921 C931, C932 C929, C930	CKDYB471K50 CKDYB681K50 CKDYF473Z50 CKMYB102K50

## RESISTORS

Mark	Symbol & Description	Part No.
	R929, R930 Other resistors	RS1PMF331J RD $\frac{1}{8}$ PM□□□J

## OTHERS

Mark	Symbol & Description	Part No.
	Mini jack (PHONES) Mic jack (MIC)	AKN1004 AKN1005

**SUPER BASS Assembly**

**SEMICONDUCTORS**

Mark	Symbol & Description	Part No.
★★	IC951	M5218L
★★	Q951-Q953	2SC1740SLN
★	D951, D952	OA90A-M

**CAPACITORS**

Mark	Symbol & Description	Part No.
	C953, C956	CEASR22M50
	C954	CEJAR68M50
	C951	CEJA010M50
	C955	CEAS0R1M50
	C952	CKCYX183M25
	C958	CKDYB392K50
	C957	CQMA823J50

**RESISTORS**

Mark	Symbol & Description	Part No.
	All resistors	RD $\frac{1}{8}$ PM□□□J

**OTHERS**

Mark	Symbol & Description	Part No.
	Socket 5P	AKP1001

**POWER SUPPLY Assembly**

**RELAY & SWITCH**

Mark	Symbol & Description	Part No.
△★★	RY991 Relay (POWER STANDBY/ON)	ASR1012
△★★	S991 Push switch (MAIN POWER ON/OFF)	ASG1006 (ASG1007)

**CAPACITORS**

Mark	Symbol & Description	Part No.
△	C991, C992 (0.01/400V)	ACG1002

**OTHERS**

Mark	Symbol & Description	Part No.
	Joint terminal	AKF1007
	Joint terminal	AKF1008

**MUTE Assembly**

**SEMICONDUCTORS**

Mark	Symbol & Description	Part No.
★★	Q897	DTA124ES
★★	Q898	DTC124ES
★	D899	1SS252

**CAPACITOR**

Mark	Symbol & Description	Part No.
	C896	CEASR22M50

**RESISTOR**

Mark	Symbol & Description	Part No.
	R895	RD $\frac{1}{8}$ PM101J

## 8. ADJUSTMENTS

### Tape Speed Adjustment

1. Connect the frequency counter to the TP terminal (Dolby TP: Lch or Rch) of the AF assembly.
2. Turn the tape switch ON.
3. Insert test tape STD-301 into deck I.
4. Set deck I to the PLAY mode and adjust VR802 of the CONTROL assembly so that the playback signal frequency becomes  $3010\text{Hz} \pm 5\text{Hz}$ .  
(Note 1. Do not turn VR801 when performing the normal speed adjustment.)  
(Note 2. Make sure to perform double speed adjustment for deck II first.)
5. Set deck I to the PLAY mode, and then short between TP4 and TP5 terminals of the CONTROL assembly. (STD-301 will be played back at double speed.)
6. Measure the playback signal frequency of deck I.
7. Insert STD-301 into deck II.
8. Play back the tape in deck II at double speed (shorted between TP4 and TP5), and adjust VR801 so that the frequency becomes the same as deck I double speed playback frequency.
9. Remove short between TP4 and TP5.
10. Play back the tape in deck II, and adjust VR803 to  $3010\text{Hz} \pm 5\text{Hz}$ .
11. At this time, confirm that wow and flutter at normal speed is within 0.25%.

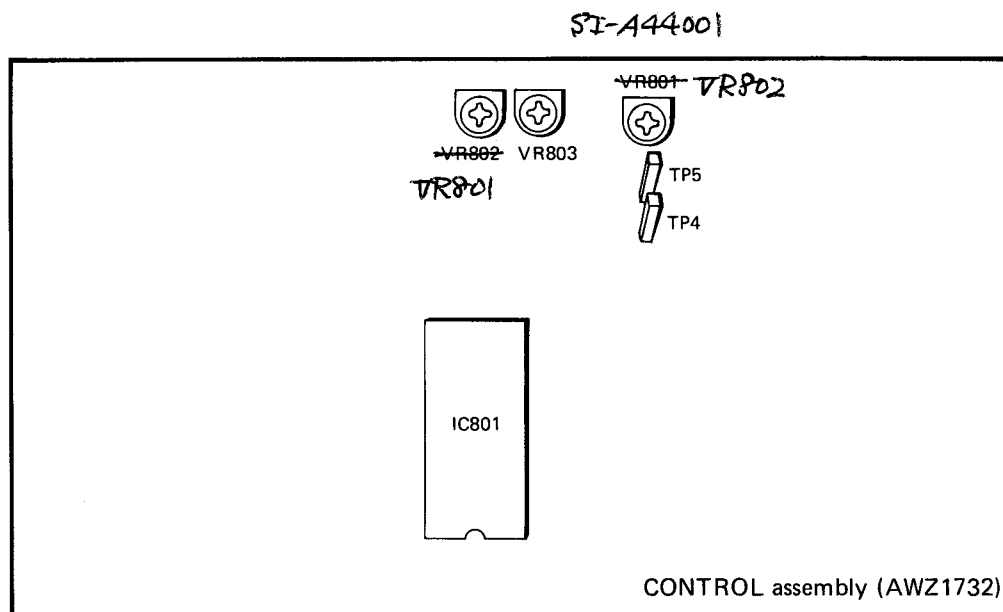

Fig. 8-1. Locations for adjustment

## ELECTRICAL ADJUSTMENTS

- Confirm the following items before performing the electrical adjustments.
1. The mechanical adjustments must be completed first.
  2. The head must be cleaned and demagnetized with a head eraser.
  3. The measurement level is 0dBV=1V.
  4. For adjustment, the specified tape should be used. The test tape has an A side and a B side; use the side labelled A.  
 STD-331B: Playback adjustment  
 STD-608A: NORMAL blank tape  
 STD-620: CrO2 blank tape  
 STD-610: METAL blank tape
  5. Prepare the following measuring instruments: ACmV meter, AF oscillator, attenuator and oscilloscope.
  6. Adjustment should be performed for both L and R channels, unless specified otherwise.
  7. Unless specified otherwise, the DOLBY NR switch is left in the OFF position.

8. Be sure to warm up the unit for a few minutes before adjustment. In particular before performing recording/playback frequency response adjustment, the unit should be run for 3 to 5 minutes in the REC/PLAY mode.
9. For perfect adjustment, be sure to follow the order specified. Otherwise, the performance of the unit might be impaired.

### Deck I

1. Head azimuth adjustment
2. Playback level adjustment

### Deck II

1. Head azimuth adjustment
2. Playback level adjustment
3. Recording and playback frequency response adjustment
4. Recording level adjustment

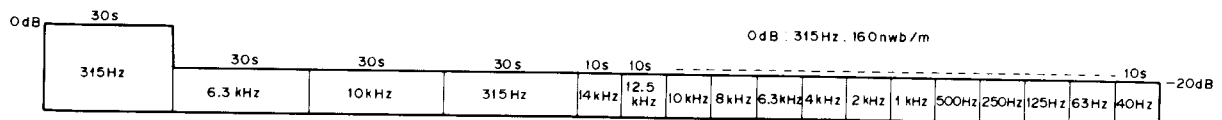

Fig. 8-2. Test tape STD-331B

<b>• Adjustment for Deck I</b> <span style="float: right;">• This deck is provided with an auto-tape-selector mechanism.</span>							
<b>1. Head Azimuth Adjustment</b> <span style="float: right;">• Note: Do not fast forward or rewind the tape while the screwdriver is inserted.</span>							
Procedure	Tape selector	Mode	Input signal/test tape	Adjusting point	Measuring point	Adjustment value	Remarks
1	NORM	PLAY	Play the 10kHz/-20dB section of test tape STD-331B.	Head azimuth adjustment screw (Fig. 8-4.)	TP3 (L CH) TP5 (R CH)	Maximum playback signal level	Lock the screw after adjustment.
<b>2. Playback Level Adjustmet</b> <span style="float: right;">• Perform this adjustment with great care, since it determines the DOLBY NR level.</span>							
Procedure	Tape selector	Mode	Input signal/test tape	Adjusting point	Measuring point	Adjustment value	Remarks
1	NORM	PLAY	Play the 315Hz/0dB section of test tape STD-331B.	VR301 (L) VR302 (R)	TP3 (L CH) TP5 (R CH)	-13.5dBV	
<b>• Adjustment for Deck II</b> <span style="float: right;">• This deck is provided with an auto-tape-selector mechanism.</span>							
<b>1. Head Azimuth Adjustment</b> <span style="float: right;">• Note: Do not fast forward or rewind the tape while the screwdriver is inserted.</span>							
Procedure	Tape selector	Mode	Input signal/test tape	Adjusting point	Measuring point	Adjustment value	Remarks
1	NORM	PLAY	Play the 10kHz/-20dB section of test tape STD-331B.	Head azimuth adjustment screw (Fig. 8-4.)	TP3 (L CH) TP5 (R CH)	Maximum playback signal level	Lock the screw after adjustment.
<b>2. Playback Level Adjustmet</b> <span style="float: right;">• Perform this adjustment with great care, since it determines the DOLBY NR level.</span>							
Procedure	Tape selector	Mode	Input signal/test tape	Adjusting point	Measuring point	Adjustment value	Remarks
1	NORM	PLAY	Play the 315Hz/0dB section of test tape STD-331B.	VR303 (L) VR304 (R)	TP3 (L CH) TP5 (R CH)	-5.2dBV	
<b>3. Recording and Playback Frequency Response Adjustment</b> <span style="float: right;">• When adjusting the recording bias, be careful not to set the bias too low, as this increases distortion.</span>							
Procedure	Tape selector	Mode	Input signal/test tape	Adjusting point	Measuring point	Adjustment value	Remarks
1	NORM	REC	Insert test tape STD-608A and set to REC mode.	_____	Between ④ and ⑤ of Fig. 8-3.	Confirm that the oscillation frequency is 105kHz±1kHz	If it is not in the specified range, adjust with T701.
2	NORM	REC	Apply 315Hz and 10kHz signals to CD terminal and turn CD switch ON.	Input signal level	TP2 (L CH) TP1 (R CH)	-25.2dBV	
3	NORM	REC/ PLAY	Record and play back 315Hz and 10kHz signals to test tape STD-608A.	VR404 (L) VR403 (R)	TP3 (L CH) TP5 (R CH)	Record/play back and adjust repeatedly, until the playback level for the 10kHz signal is 0±0.5dB compared to the 315Hz signal.	
• Select the test tape, tape selector, and Dolby NR switch and satisfy the frequency response zone as shown in Figs. 8-5 and 8-6.							
<b>4. Recording Level Adjustment</b> <span style="float: right;">• Set the graphic equalizer and balance controls to their center positions and the mic mixing control to SOURCE.</span>							
Procedure	Tape selector	Mode	Input signal/test tape	Adjusting point	Measuring point	Adjustment value	Remarks
1	NORM	REC	Apply 315Hz signal to CD terminal and turn CD switch ON.	Input signal level	TP2 (L CH) TP1 (R CH)	-5.2dBV	
2	NORM	REC/ PLAY	Record and play back the 315Hz signal to test tape STD-608A.	VR401 (L) VR402 (R)	TP3 (L CH) TP5 (R CH)	Record/play back and adjust repeatedly, until the playback level of the 315Hz signal becomes -5.2dBV.	
3	CrO2	REC/ PLAY	Record and play back the 315Hz signal to test tape STD-620.	_____	TP3 (L CH) TP5 (R CH)	Confirm that the playback level of the 315Hz signal becomes -5.2dBV.	
4	METAL	REC/ PLAY	Record and play back the 315Hz signal to test tape STD-610.	_____	TP3 (L CH) TP5 (R CH)	Confirm that the playback level of the 315Hz signal becomes -5.2dBV.	

Note: The signal will not be output to the TP terminal, unless the unit is set to REC/PLAY. (When set to REC PAUSE, no signal is output to TP.)

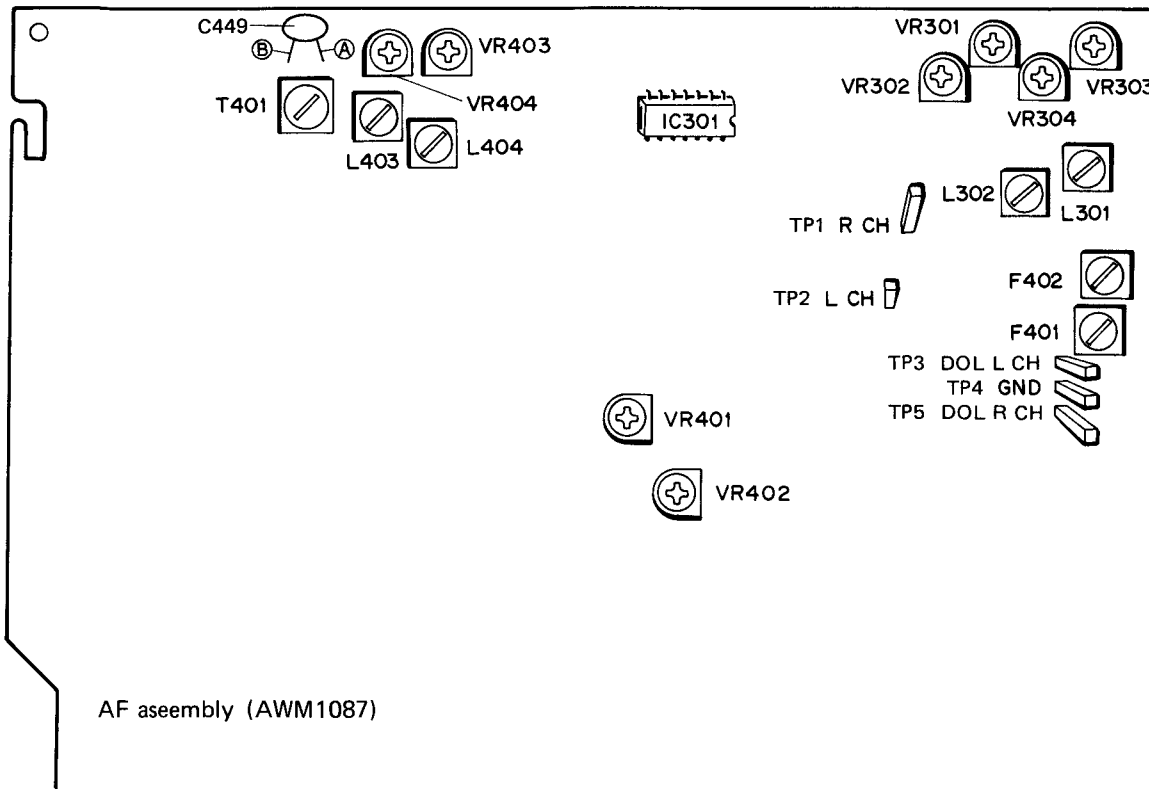

Fig. 8-3. Adjusting and measuring point of the AF assembly

• Azimuth adjustment

For azimuth adjustment, remove the mechanism cover (AEC1096) by pulling it out towards the front side.

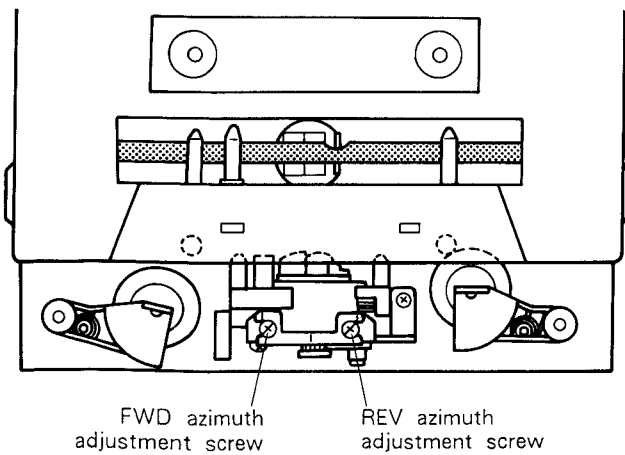

Fig. 8-4. Head azimuth adjustment

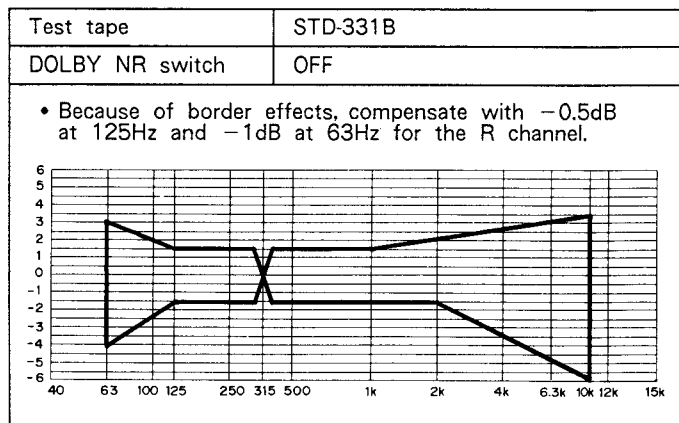

Fig. 8-5. Allowable playback frequency response zone



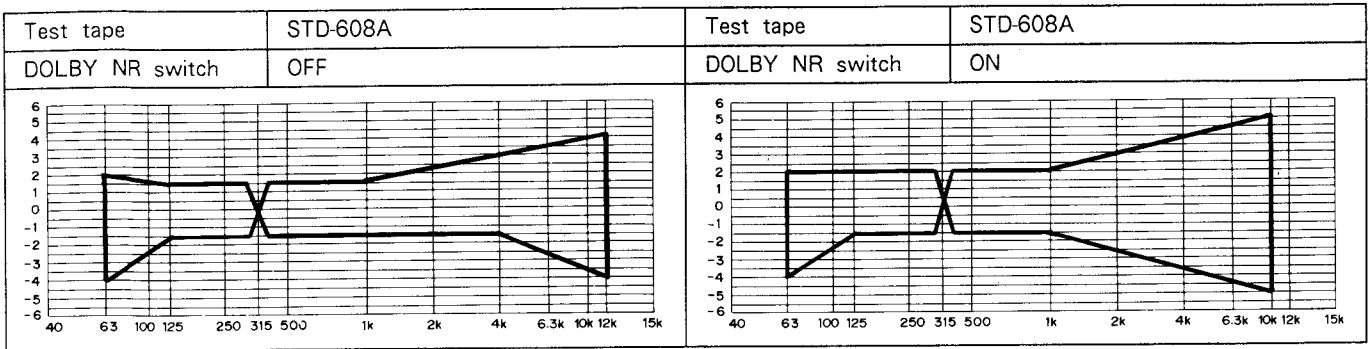

Fig. 8-6. Allowable recording/playback frequency response zone (NORM)

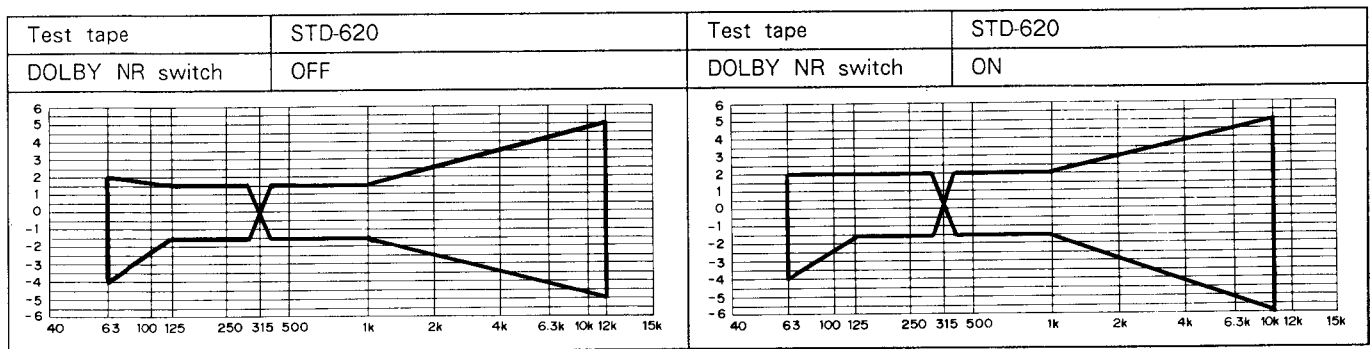

Fig. 8-7. Allowable recording/playback frequency response zone (CrO<sub>2</sub>)

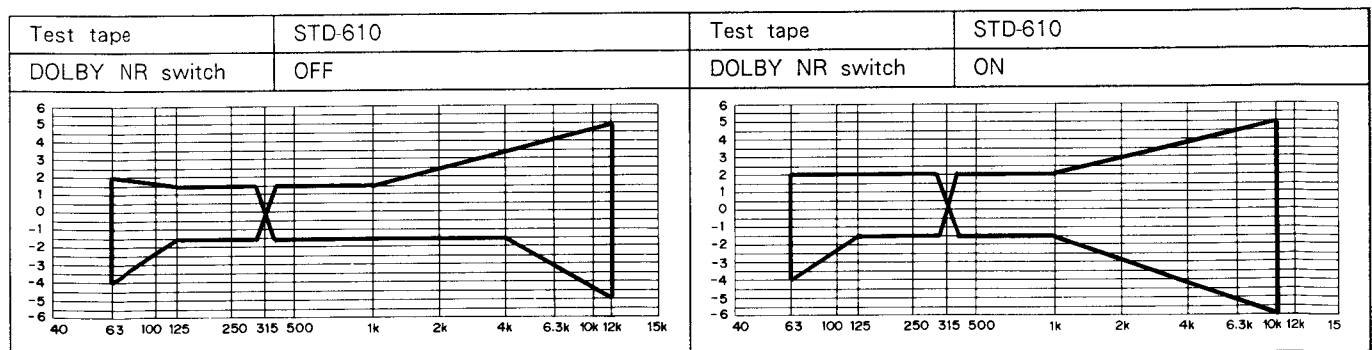

Fig. 8-8. Allowable recording/playback frequency response zone (METAL)

## 8. REGLAGE

### Réglage de la vitesse de bande

1. Brancher le compteur de fréquence à la borne TP (Dolby TP: can. gauche ou can. droit) de l'ensemble AF.
2. Enclencher (ON) la touche de bande.
3. Insérer la bande d'essai STD-301 dans la Platine I.
4. Régler la Platine I sur le mode de lecture (PLAY) et régler VR802 de l'ensemble de commande (CONTROL) de sorte que la fréquence du signal de lecture devienne  $3.010 \text{ Hz} \pm 5 \text{ Hz}$ . (Remarque 1. Ne pas tourner VR801 lors du réglage de la vitesse normale). (Remarque 2. Toujours effectuer le réglage de la vitesse double tout d'abord pour la Platine II).
5. Régler la Platine I sur le mode de lecture (PLAY) puis court-circuiter les bornes TP4 et TP5 de l'ensemble de commande (CONTROL). (La bande STD-301 sera reproduite à double vitesse).
6. Mesurer la fréquence du signal de lecture de la Platine I.
7. Insérer la bande STD-301 dans la Platine II.
8. Reproduire la bande de la Platine II à double vitesse (court-circuit entre TP4 et TP5) et régler VR801 de sorte que la fréquence devienne la même que la fréquence de lecture à double vitesse de la Platine I.
9. Retirer le court-circuit entre TP4 et TP5.
10. Reproduire la bande de la Platine II et régler VR803 sur  $3.010 \text{ Hz} \pm 5 \text{ Hz}$ .
11. Vérifier, à ce moment-là, que le pleurage et scintillement à la vitesse normale est dans la limite de 0,25%

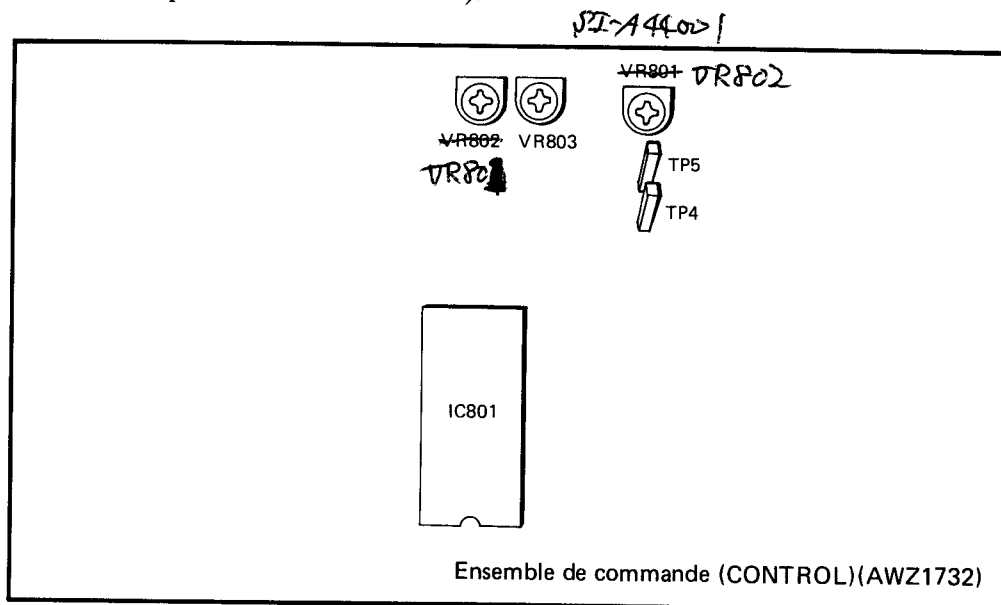

Fig. 8-1. Points de réglage

## REGLAGES ELECTRIQUES

- Vérifier les points suivants avant d'effectuer les réglages électriques.
1. Les réglages mécaniques doivent tout d'abord être terminés.
  2. La tête doit être nettoyée et démagnétisée avec un démagnétiseur de tête.
  3. Le niveau de mesure est de 0 dBV = 1 V.
  4. La bande spécifiée doit être utilisée pour le réglage. La bande d'essai a une face A et une face B; utiliser la face étiquetée A.
    - STD-331B: Réglage de la lecture
    - STD-608A: Bande vierge NORMAL
    - STD-620: Bande vierge CrO<sub>2</sub>
    - STD-610: Bande vierge METAL
  5. Préparer les instruments de mesure suivants: Compteur CAMV, oscillateur à basse fréquence, atténuateur et oscilloscope.
  6. Le réglage doit être effectué pour les deux canaux L (gauche) et R (droit), sauf spécification contraire.
  7. Sauf spécification contraire, le commutateur DOLBY NR est laissé sur la position OFF.
  8. Toujours laisser chauffer l'appareil pendant quelques minutes avant le réglage. En particulier avant d'effectuer le réglage de la réponse en fréquence d'enregistrement/lecture, l'unité doit fonctionner pendant 3 à 5 minutes dans le mode d'enregistrement/lecture (REC/PLAY).
  9. Pour que le réglage soit parfait, toujours suivre l'ordre spécifié. Dans le cas contraire, les performances de l'appareil pourraient être altérées.

### Platine I

1. Réglage de l'azimutage de la tête
2. Réglage du niveau de lecture

### Platine II

1. Réglage de l'azimutage de la tête
2. Réglage du niveau de lecture
3. Réglage de la réponse en fréquence d'enregistrement/lecture
4. Réglage du niveau d'enregistrement

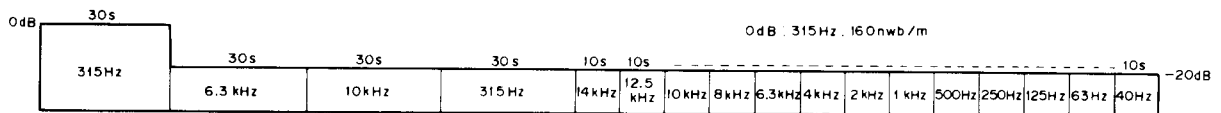

Fig. 8-2. Bande d'essai STD-331B

<b>• Réglage de la Platine I</b> • Cet appareil est équipé d'un mécanisme de sélection automatique de bande.							
<b>1. Réglage de l'azimutage de la tête</b> • Remarque: Ne pas avancer rapidement ou rembobiner la bande pendant que le tournevis est inséré.							
Procédure	Sélecteur de bande	Mode	Signal d'entrée/ bande d'essai	Point de réglage	Point de mesure	Valeur de réglage	Remarques
1	NORM	Lecture (PLAY)	Reproduire la section 10 kHz/-20 dB de la bande d'essai STD-331B.	Vis de réglage de l'azimutage de la tête (Fig. 8-4.)	TP3 (can. gauche) TP5 (can. droit)	Niveau du signal de lecture maximum	Bloquer la vis après le réglage.
<b>2. Réglage du niveau de lecture</b> • Effectuer ce réglage avec beaucoup de soin car il détermine le niveau DOLBY NR.							
Procédure	Sélecteur de bande	Mode	Signal d'entrée/ bande d'essai	Point de réglage	Point de mesure	Valeur de réglage	Remarques
1	NORM	Lecture (PLAY)	Reproduire la section 315 Hz/0 dB de la bande d'essai STD-331B.	VR301 (gauche) VR302 (droite)	TP3 (can. gauche) TP5 (can. droit)	- 13,5 dBV	

• **Réglage de la Platine II** • Cet appareil est équipé d'un mécanisme de sélection automatique de bande.

1. Réglage de l'azimutage de la tête • Remarque: Ne pas avancer rapidement ou rembobiner la bande pendant que le tournevis est inséré.

Procédure	Sélecteur de bande	Mode	Signal d'entrée/ bande d'essai	Point de réglage	Point de mesure	Valeur de réglage	Remarques
1	NORM	Lecture (PLAY)	Reproduire la section 10 kHz/ - 20 dB de la bande d'essai STD-331B.	Vis de réglage de l'azimutage de la tête (Fig. 8-4.)	TP3 (can. gauche) TP5 (can. droit)	Niveau du signal de lecture maximum	Bloquer la vis après le réglage.

2. Réglage du niveau de lecture • Effectuer ce réglage avec beaucoup de soin car il détermine le niveau DOLBY NR.

Procédure	Sélecteur de bande	Mode	Signal d'entrée/ bande d'essai	Point de réglage	Point de mesure	Valeur de réglage	Remarques
1	NORM	Lecture (PLAY)	Reproduire la section 315 Hz/0 dB de la bande d'essai STD-331B.	VR303 (gauche) VR304 (droite)	TP3 (can. gauche) TP5 (can. droit)	- 5,2 dBV	

3. Réglage de la réponse en fréquence de l'enregistrement et de la lecture • Lors du réglage de la polarisation d'enregistrement, faire attention de ne pas régler la polarisation trop bas car cela augmente la distorsion.

Procédure	Sélecteur de bande	Mode	Signal d'entrée/ bande d'essai	Point de réglage	Point de mesure	Valeur de réglage	Remarques
1	NORM	Enregistrement (REC)	Insérer la bande d'essai STD-608A et régler sur le mode d'enregistrement (REC).	Entre A et B de la Fig. 8-3.	Vérifier que la fréquence d'oscillation est 105 kHz $\pm$ 1 kHz.	Si elle n'est pas dans la gamme spécifiée, régler avec T701.	
2	NORM	Enregistrement (REC)	Appliquer des signaux de 315 Hz et 10 kHz à la borne CD et enclencher (ON) la touche CD.	Niveau du signal d'entrée	TP2 (can. gauche) TP1 (can. droit)	- 25,2 dBV	
3	NORM	Enregistrement/ lecture (REC/PLAY)	Enregistrer et reproduire les signaux 315 Hz et 10 kHz sur la bande d'essai STD-608A.	VR404 (gauche) VR403 (droite)	TP3 (can. gauche) TP5 (can. droit)	Enregistrer/reproduire et régler de manière répétée, jusqu'à ce que le niveau de lecture pour le signal 10 kHz soit $0 \pm 0,5$ dB comparé au signal 315 Hz.	

• Changer les bandes d'essai et les réglages du sélecteur de bande et du commutateur Dolby NR pour satisfaire aux zones de réponse en fréquence indiquées sur les Figs. 8-5. et 8-6.

4. Réglage du niveau d'enregistrement • Régler les commandes d'égaliseur graphique et d'équilibre sur leurs positions centrales et la commande de mixage microphone sur la position SOURCE.

Procédure	Sélecteur de bande	Mode	Signal d'entrée/ bande d'essai	Point de réglage	Point de mesure	Valeur de réglage	Remarques
1	NORM	Enregistrement (REC)	Appliquer un signal de 315 Hz à la borne CD et enclencher (ON) la touche CD.	Niveau de signal d'entrée	TP2 (can. gauche) TP1 (can. droit)	- 5,2 dBV	
2	NORM	Enregistrement/ lecture (REC/PLAY)	Enregistrer et reproduire le signal 315 Hz sur la bande d'essai STD-608A.	VR401 (gauche) VR402 (droite)	TP3 (can. gauche) TP5 (can. droit)	Enregistrer/reproduire et régler de manière répétée, jusqu'à ce que le niveau de lecture du signal 315 Hz devienne - 5,2 dBV.	
3	CrO2	Enregistrement/ lecture (REC/PLAY)	Enregistrer et reproduire le signal 315 Hz sur la bande d'essai STD-620.		TP3 (can. gauche) TP5 (can. droit)	Vérifier que le niveau de lecture du signal 315 Hz devient - 5,2 dBV.	
4	METAL	Enregistrement/ lecture (REC/PLAY)	Enregistrer et reproduire le signal 315 Hz sur la bande d'essai STD-610.		TP3 (can. gauche) TP5 (can. droit)	Vérifier que le niveau de lecture du signal 315 Hz devient - 5,2 dBV.	

Remarque: Le signal ne sera pas sorti à la borne TP, à moins que l'appareil soit réglé sur le mode enregistrement/lecture (REC/PLAY.)

(Lorsqu'il est réglé sur le mode de pause à l'enregistrement (REC PAUSE), aucun signal n'est sorti à TP).

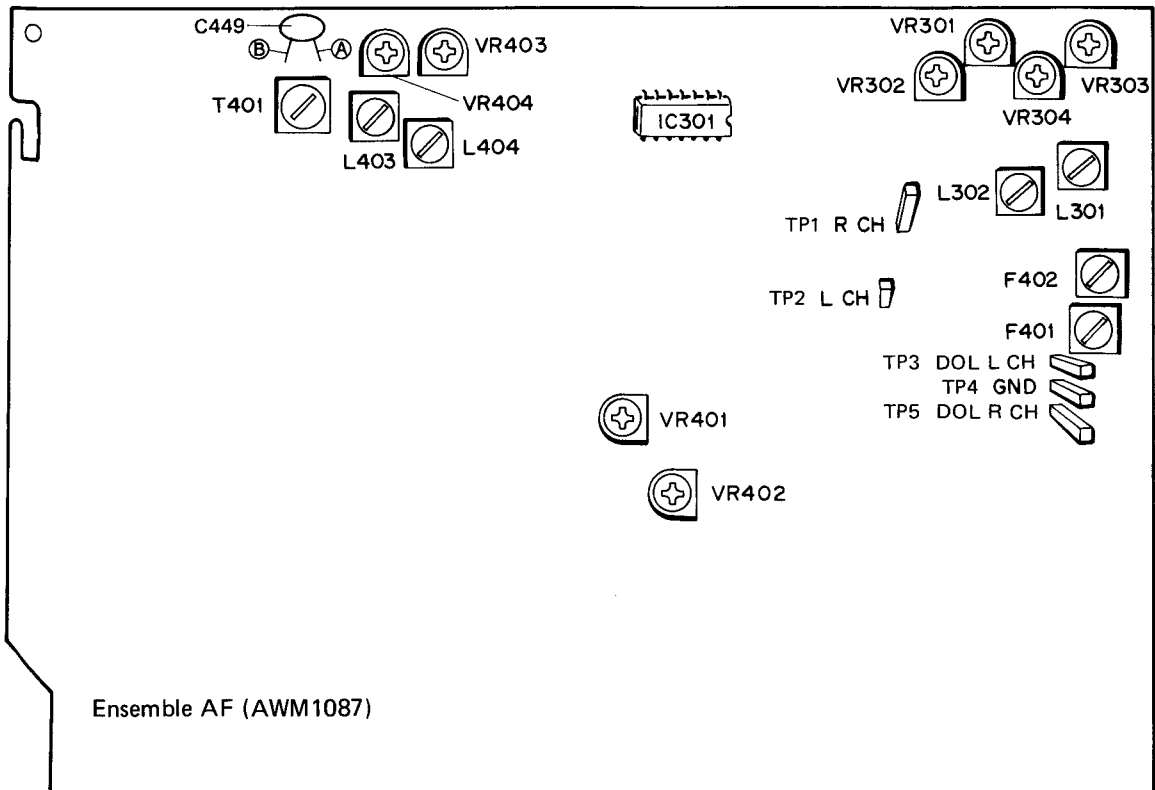

Fig. 8-3. Point de réglage et de mesure de l'ensemble AF.

• Réglage de l'azimutage

Pour le réglage de l'azimutage, déposer le couvercle du mécanisme (AEC1096) en le tirant vers l'avant.

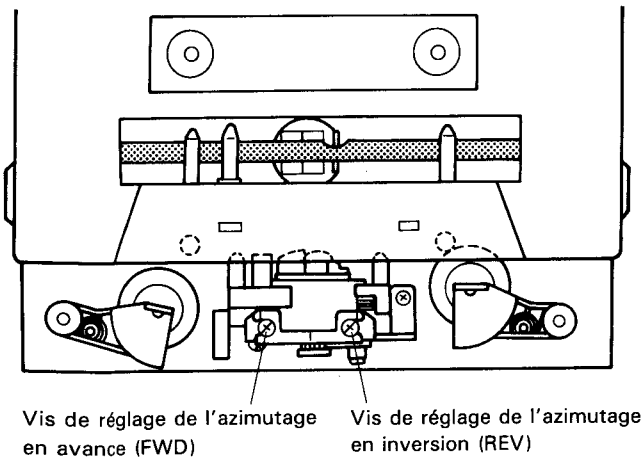

Fig. 8-4. Réglage de l'azimutage de la tête

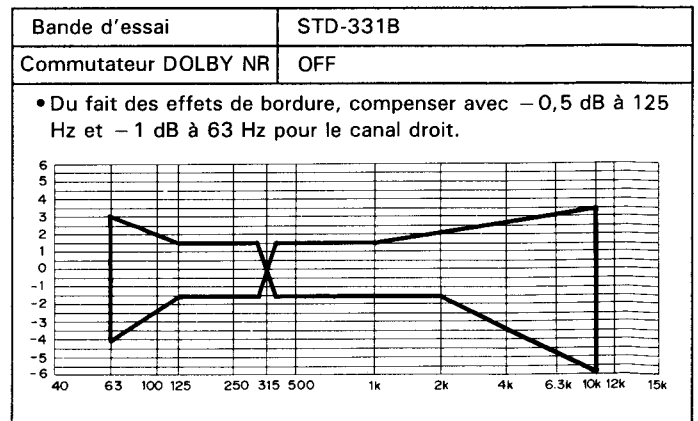

Fig. 8-5. Zone de réponse en fréquence de lecture admissible



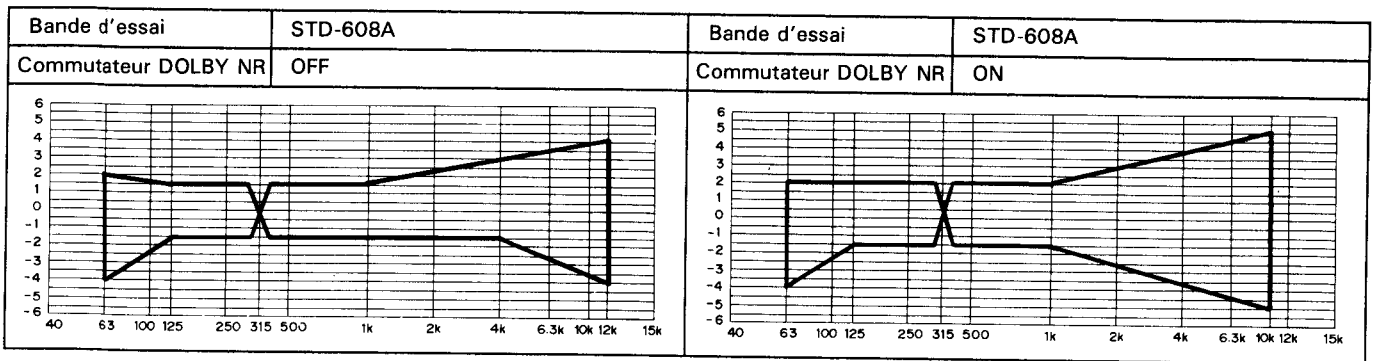

Fig. 8-6. Zone de réponse en fréquence d'enregistrement/lecture admissible (NORM)

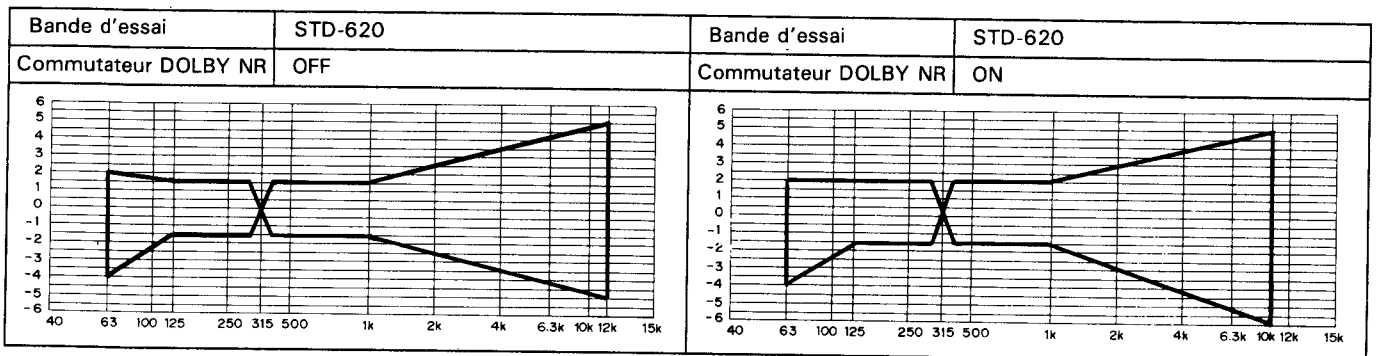

Fig. 8-7. Zone de réponse en fréquence d'enregistrement/lecture admissible (CrO<sub>2</sub>)

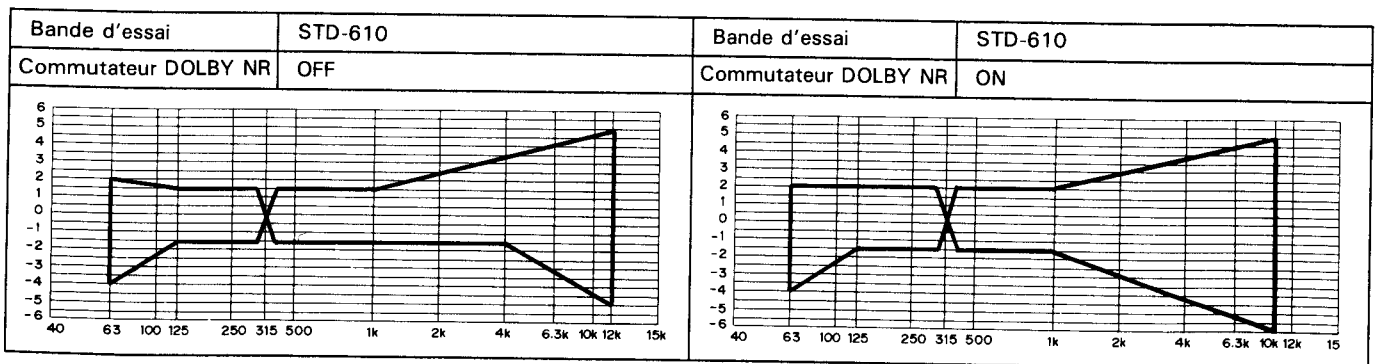

Fig. 8-8. Zone de réponse en fréquence d'enregistrement/lecture admissible (METAL)

## 8. AJUSTE

### Ajuste de velocidad de cinta

1. Conecte el frecuencímetro en el terminal TP (Dolby TP: canal izquierdo o canal derecho) del conjunto AF.
2. Conecte el interruptor del deck.
3. Introduzca la cinta de prueba STD-301 en el deck I.
4. Ponga el deck I en el modo PLAY y ajuste VR802 del conjunto CONTROL para que la frecuencia de la señal de reproducción sea de  $3.010\text{Hz} \pm 5\text{Hz}$ .  
(Nota 1. No gire el VR801 cuando haga el ajuste de velocidad normal.)  
(Nota 2. Cerciórese de hacer el ajuste de velocidad doble en el deck II primero.)
5. Ponga el deck I en el modo PLAY y luego, cortocircuite los terminales TP4 y TP5 del conjunto CONTROL. (STD-301 se reproducirá al doble de la velocidad normal.)
6. Mida la frecuencia de la señal de reproducción del deck I.
7. Introduzca la STD-301 en el deck II.
8. Reproduzca la cinta del deck II al doble de la velocidad normal (cortocircuito entre los terminales TP4 y TP5) y ajuste el VR801 de forma que la frecuencia sea la misma que la del deck I cuando éste reproduzca al doble de la velocidad normal.
9. Elimine el cortocircuito entre TP4 y TP5.
10. Reproduzca la cinta en el deck II y ajuste el VR803 a  $3.010\text{Hz} \pm 5\text{Hz}$ .
11. Asegúrese en este momento que la fluctuación y el trémolo a la velocidad normal no excedan el 0,25%



Figura 8-1. Ubicaciones para el ajuste

## AJUSTES ELÉCTRICOS

- Confirme los ítemes indicados a continuación antes de realizar los ajustes eléctricos.
1. Primero deben completarse los ajustes mecánicos.
  2. La cabeza debe estar limpia y desmagnetizada con un desmagnetizador de cabezas.
  3. El nivel de medición debe ser de  $0\text{dBV} = 1\text{V}$ .
  4. Para realizar los ajustes debe utilizar la cinta especificada. La cinta de prueba tiene un lado A y un lado B. Utilice el lado A.  
 STD-331B: Ajuste de reproducción  
 STD-608A: Cinta virgen NORMAL  
 STD-620: Cinta virgen de  $\text{CrO}_2$   
 STD-610: Cinta virgen de METAL
  5. Prepare los instrumentos de medición siguientes: Medidor de CAMV, oscilador de baja frecuencia, atenuador y osciloscopio.
  6. El ajuste deberá realizarlo para ambos canales, el izquierdo y el derecho, a menos que se especifique lo contrario.
  7. A menos que se especifique lo contrario, el conmutador DOLBY NR debe dejarlo en la posición OFF.
  8. Cerciórese de calentar el aparato durante unos pocos minutos antes de realizar el ajuste. Especialmente, antes de realizar el ajuste de respuesta de frecuencia para grabación y reproducción, el aparato debe haber funcionado de 3 a 5 minutos en el modo REC/PLAY.
  9. Para realizar un ajuste perfecto, cerciórese de seguir el orden especificado. De lo contrario, el rendimiento del aparato podría empeorar.

### Deck I

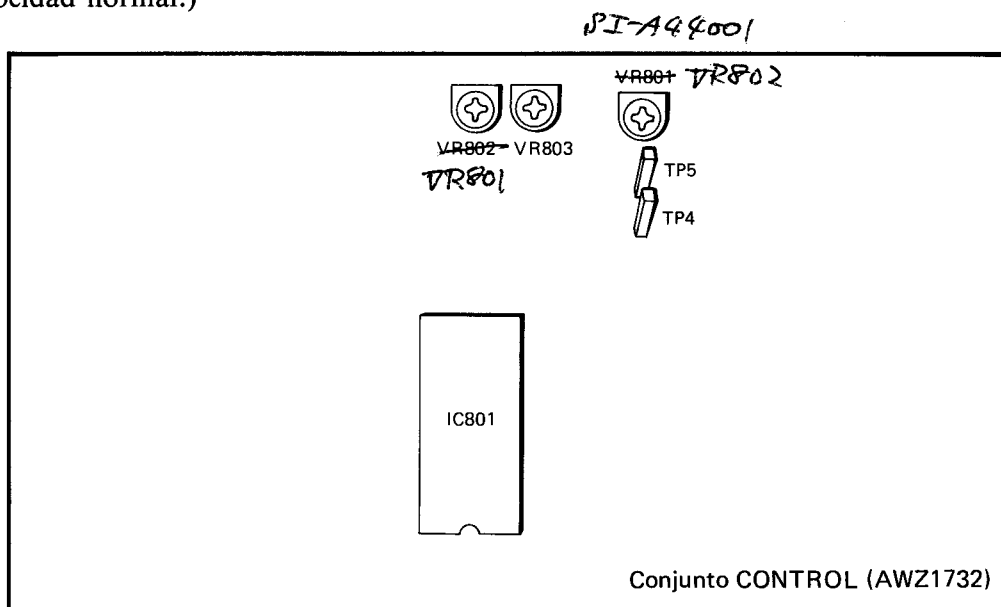
1. Ajuste del azimut de la cabeza
2. Ajuste del nivel de reproducción

### Deck II

1. Ajuste del azimut de la cabeza
2. Ajuste del nivel de reproducción
3. Ajuste de respuesta de frecuencia para la grabación y la reproducción
4. Ajuste del nivel de grabación



Figura 8-2. Cinta de prueba STD-331B

<b>• Ajuste para el deck I</b> • Este aparato está equipado con un mecanismo selector automático de cinta.							
<b>1. Ajuste del azimut de la cabeza</b> • Nota: No haga que la cinta avance rápidamente o se rebobine estando introducido el destornillador.							
Procedimiento	Selector de cinta	Modo	Señal de entrada/cinta de prueba	Ubicación de ajuste	Ubicación de medición	Valor de ajuste	Observaciones
1	NORM	PLAY	Reproduzca la sección de 10kHz/ - 20 dB de la cinta de prueba STD-331B.	Tornillo de ajuste del azimut de la cabeza (Figura 8-4.)	TP3 (L CH) TP5 (R CH)	Nivel máximo de la señal de reproducción	Bloquee el tornillo después del ajuste.
<b>2. Ajuste del nivel de reproducción</b> • Haga este ajuste con mucho cuidado porque determina el nivel de DOLBY NR.							
Procedimiento	Selector de cinta	Modo	Señal de entrada/cinta de prueba	Ubicación de ajuste	Ubicación de medición	Valor de ajuste	Observaciones
1	NORM	PLAY	Reproduzca la sección de 315Hz/0dB de la cinta de prueba STD-331B.	VR301 (L) VR302 (R)	TP3 (L CH) TP5 (R CH)	- 13,5dBV	

<b>• Ajuste para el deck II</b> • Este aparato está equipado con un mecanismo selector automático de cinta.							
<b>1. Ajuste del azimut de la cabeza</b> • Nota: No haga que la cinta avance rápidamente o se rebobine estando introducido el destornillador.							
Procedimiento	Selector de cinta	Modo	Señal de entrada/cinta de prueba	Ubicación de ajuste	Ubicación de medición	Valor de ajuste	Observaciones
1	NORM	PLAY	Reproduzca la sección de 10kHz/ - 20dB de la cinta de prueba STD-331B.	Tornillo de ajuste del azimut de la cabeza (Figura 8-4.)	TP3 (L CH) TP5 (R CH)	Nivel máximo de la señal de reproducción	Bloquee el tornillo después del ajuste.
<b>2. Ajuste del nivel de reproducción</b> • Haga este ajuste con mucho cuidado porque determina el nivel de DOLBY NR.							
Procedimiento	Selector de cinta	Modo	Señal de entrada/cinta de prueba	Ubicación de ajuste	Ubicación de medición	Valor de ajuste	Observaciones
1	NORM	PLAY	Reproduzca la sección de 315Hz/0dB de la cinta de prueba STD-331B.	VR303 (L) VR304 (R)	TP3 (L CH) TP5 (R CH)	- 5,2dBV	
<b>3. Ajuste de la respuesta de frecuencia de la grabación y de la reproducción</b> • Cuando ajuste la polarización de grabación, tenga cuidado de no ajustarla demasiado baja porque en ese caso aumenta la distorsión.							
Procedimiento	Selector de cinta	Modo	Señal de entrada/cinta de prueba	Ubicación de ajuste	Ubicación de medición	Valor de ajuste	Observaciones
1	NORM	REC	Introduzca la cinta de prueba STD-608A y ponga el modo REC.	Entre A y B de la figura 8-3.	Confirme si la frecuencia de oscilación es de 105kHz $\pm$ 1kHz.	Si no está dentro del margen especificado, ajuste con T701.	
2	NORM	REC	Aplique las señales de 315 Hz y 10kHz al terminal CD y conecte el conmutador CD.	Nivel de la señal de entrada	TP2 (L CH) TP1 (R CH)	- 25,2dBV	
3	NORM	REC/PLAY	Grabe y reproduzca las señales de 315 Hz y 10 kHz en la cinta de prueba STD-608A.	VR404(L) VR403 (R)	TP3 (L CH) TP5 (R CH)	Grabe/reproduzca y ajuste repetidamente hasta que el nivel de reproducción para la señal de 10kHz sea de $0 \pm 0,5$ dB comparada con la señal de 315Hz.	
• Prepare las cintas de prueba, selector de cinta y conmutador Dolby NR para cumplir con las zonas de respuesta de frecuencia mostradas en las figuras 8-5. y 8-6.							
<b>4. Ajuste del nivel de grabación</b> • Ponga los controles del ecualizador gráfico y de balance en sus posiciones centrales y el control de mezcla microfónica en la posición SOURCE.							
Procedimiento	Selector de cinta	Modo	Señal de entrada/cinta de prueba	Ubicación de ajuste	Ubicación de medición	Valor de ajuste	Observaciones
1	NORM	REC	Aplique una señal de 315Hz al terminal CD y conecte el conmutador CD.	Nivel de la señal de entrada	TP2 (L CH) TP1 (R CH)	- 5, 2 dBV	
2	NORM	REC/PLAY	Grabe y reproduzca la señal de 315 Hz en la cinta de prueba STD-608A.	VR401 (L) VR402 (R)	TP3 (L CH) TP5 (R CH)	Grabe/reproduzca y ajuste repetidamente hasta que el nivel de reproducción de la señal de 315Hz sea de - 5,2dBV.	
3	CrO <sub>2</sub>	REC/PLAY	Grabe y reproduzca la señal de 315Hz en la cinta de prueba STD-620.		TP3 (L CH) TP5 (R CH)	Asegúrese que el nivel de reproducción de la señal de 315Hz sea de - 5,2dBV.	
4	METAL	REC/PLAY	Grabe y reproduzca la señal de 315 Hz en la cinta de prueba STD-610.		TP3 (L CH) TP5 (R CH)	Asegúrese que el nivel de reproducción de la señal de 315Hz sea de - 5,2dBV.	

Nota: La señal no saldrá al terminal TP a menos que el aparato esté en el modo REC/PLAY.  
(En REC PAUSE, no sale señal al TP.)

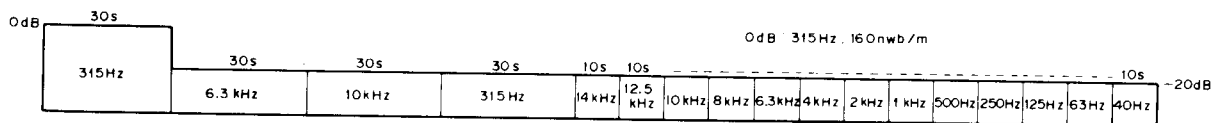

Figura 8-3. Punto de ajuste y medición del conjunto AF

• Ajuste de azimut

Para realizar el ajuste de azimut, retire la tapa del mecanismo (AEC1096) tirando de ella hacia delante para sacarla.

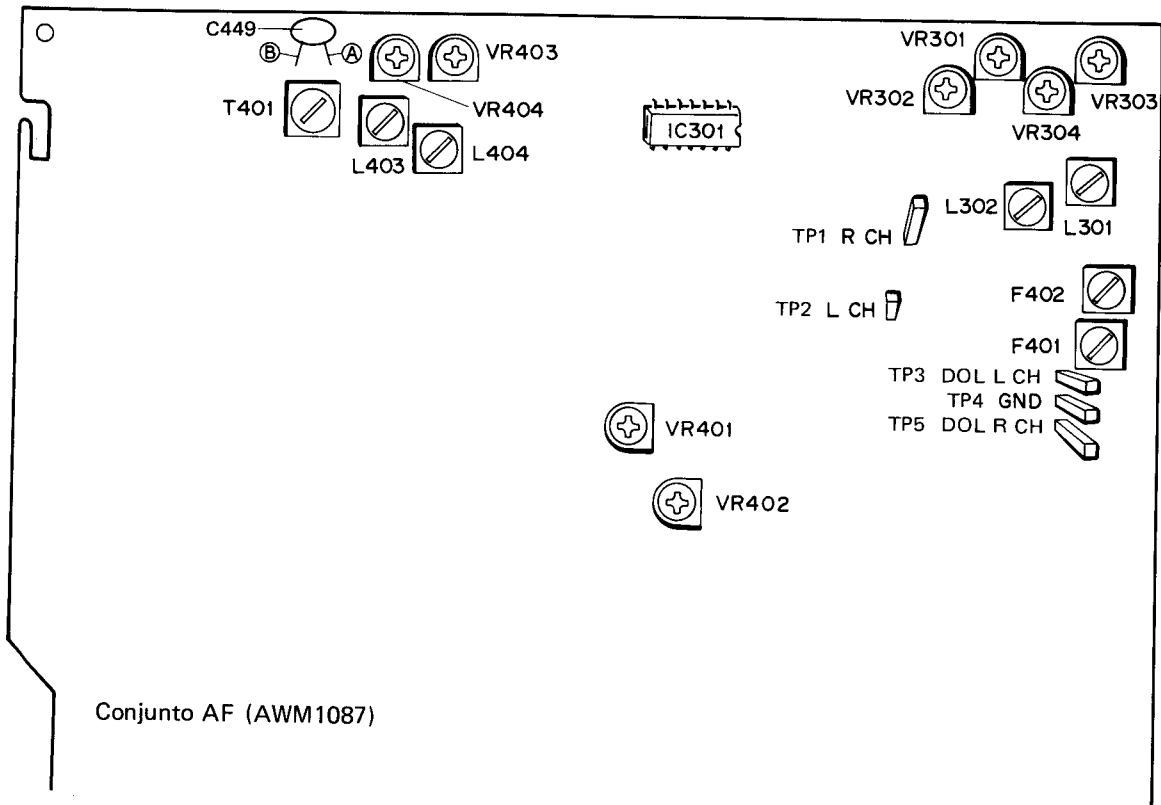

Figura 8-4. Ajuste de azimut de la cabeza



Figura 8-5. Zona de respuesta de la frecuencia de reproducción permisible



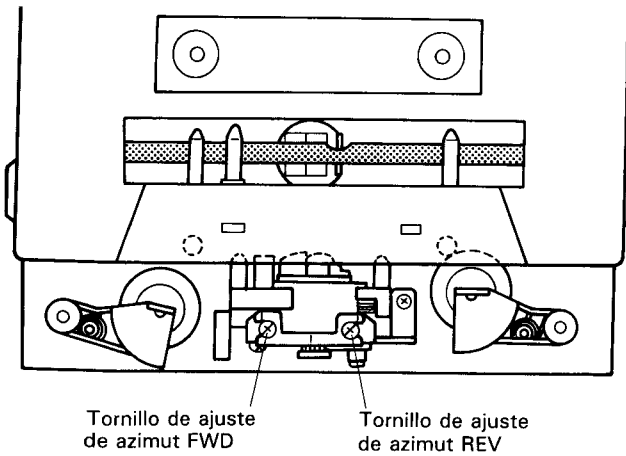

Figura 8-6. Zona de respuesta de frecuencia de grabación/reproducción permisible (NORM)

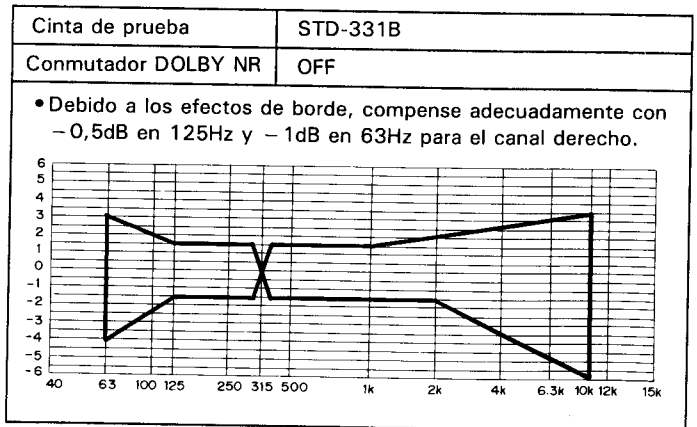

Figura 8-7. Zona de respuesta de frecuencia de grabación/reproducción permisible (CrO<sub>2</sub>)

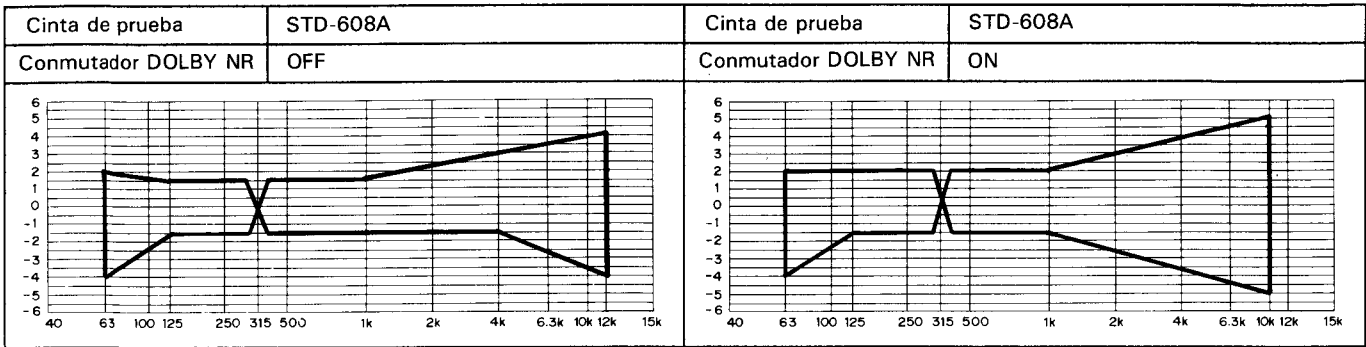

Figura 8-8. Zona de respuesta de frecuencia de grabación/reproducción permisible (METAL)

## 9. FOR HB AND SD TYPES

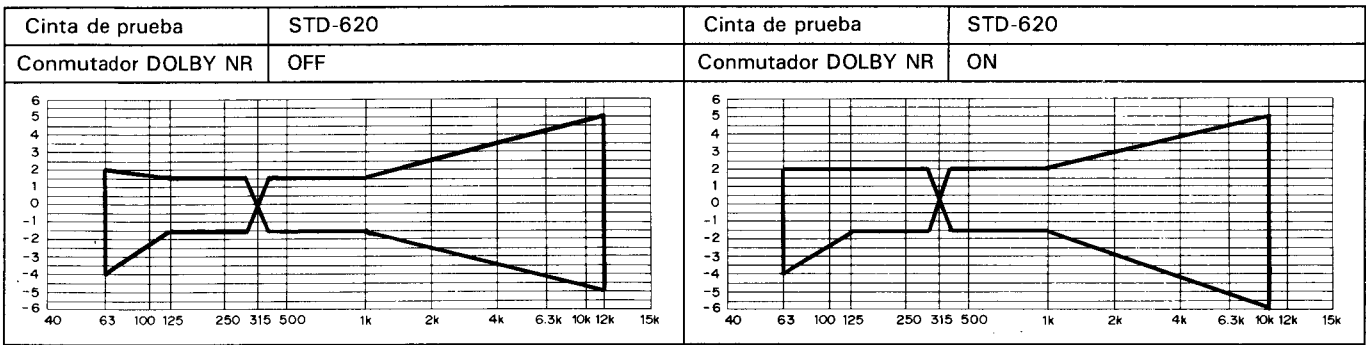
### NOTES :

- Parts without part number cannot be supplied.
- The  $\Delta$  mark found on some component parts indicates the importance of the safety factor of the part. Therefore, when replacing, be sure to use parts of identical designation.
- For your parts Stock Control, the fast moving items are indicated with the marks **★★** and **★**.  
**★★ GENERALLY MOVES FASTER THAN ★.**  
 This classification shall be adjusted by each distributor because it depends on model number, temperature, humidity, etc.
- Parts marked by "⊙" are not always kept in stock. Their delivery time may be longer than usual or they may be unavailable.

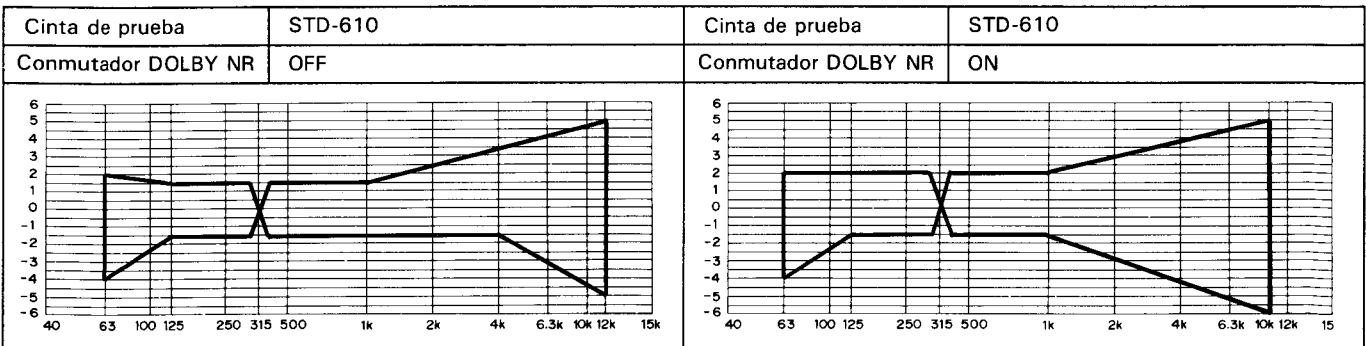
### CONTRAST OF MISCELLANEOUS PARTS

The DC-Z91/HB and SD types are the same as the DC-Z91/HE type with the exception of the following sections.

Mark	Symbol & Description	Part No.			Remarks
		DC-Z91/ HE type	DC-Z91/ HB type	DC-Z91/ SD type	
$\Delta$	Power supply assembly	Non supply	Non supply	Non supply	
$\Delta$	AC power cord	ADG1021	ADG-063	ADG1015	
$\Delta$ ★★	FU1 Fuse (T2A/250V)	AEK-017	AEK-511	.....	
$\Delta$ ★★	FU2 Fuse (T1.6A/250V)	AEK-405	.....	AEK-405	
$\Delta$ ★★	FU3 Fuse (T1.6A/250V)	.....	AEK-510	AEK-405	
$\Delta$ ★★	FU4, FU5 Fuse (T1.6A/250V)	AEK-405	AEK-510	AEK-405	
$\Delta$ ★★	FU6, FU7 Fuse (T3.15A/250V)	AEK-042	AEK-513	AEK-042	
$\Delta$ ★★	FU1 Fuse (T4A/250V)	.....	.....	AEK-400	
$\Delta$	AC socket (AC OUTLET)	AKP1024	AKP1023	AKP1022	
$\Delta$ ★★	S1 Voltage selector switch (AC110/120-127/220/240V)	.....	.....	AKX-507	
$\Delta$ ★	T1 Power transformer (AC220/240V)	ATS1120	ATS1120	.....	
$\Delta$ ★	T1 Power transformer (AC110/120-127/220/240V)	.....	.....	ATS1122	
	Operating instructions (English, German, French, Italian)	ARE1068	.....	.....	
	Operating instructions (English)	.....	ARB1099	ARB1099	
	Operating instructions (Spanish-auxiliary)	ARC1073	.....	ARC1075	

### POWER SUPPLY ASSEMBLY

The power supply assembly of DC-Z91/HB and SD types are the same as the power supply assembly of DC-Z91/HE type with the exception of the following section.

Mark	Symbol & Description	Part No.			Remarks
		DC-Z91/ HE type	DC-Z91/ HB type	DC-Z91/ SD type	
	Wrapping terminal	.....	.....	Non supply	

Schematic diagram for HB type

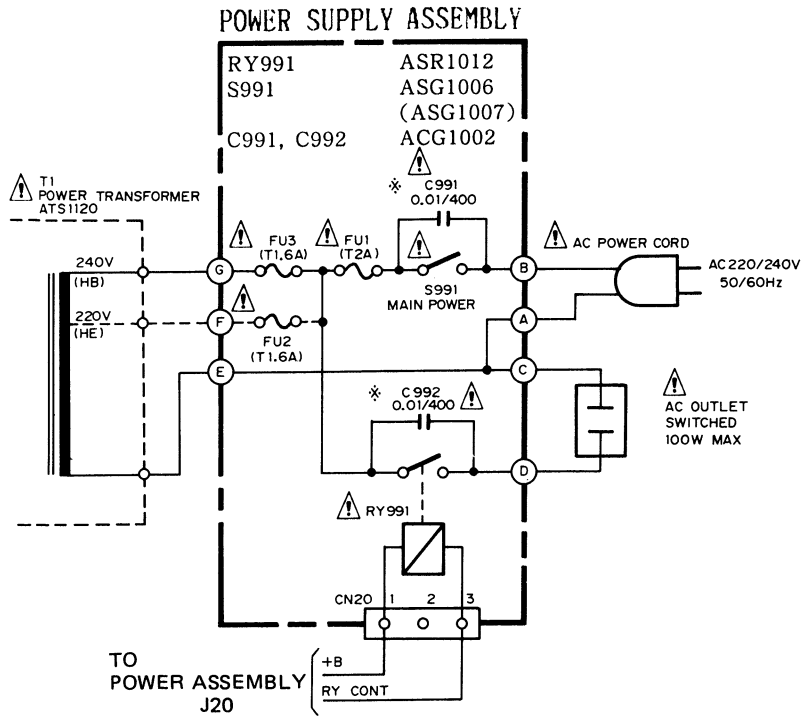

Line Voltage Selection

Line voltage can be changed with the following steps.

1. Disconnect the AC power cord.
2. Remove the top cover.
3. Change the position of the fuse **(A)** or **(B)** as follows.

Voltage	Fuse <b>(A)</b> or <b>(B)</b> position
220V	<b>(A)</b> (FU2: HE type only)
240V	<b>(B)</b> (FU3: HB type only)

4. Stick the line voltage label on the rear panel.

Part NO.	Description
AAX-193	220V label
AAX-192	240V label

P.C.Board patterns for HB type

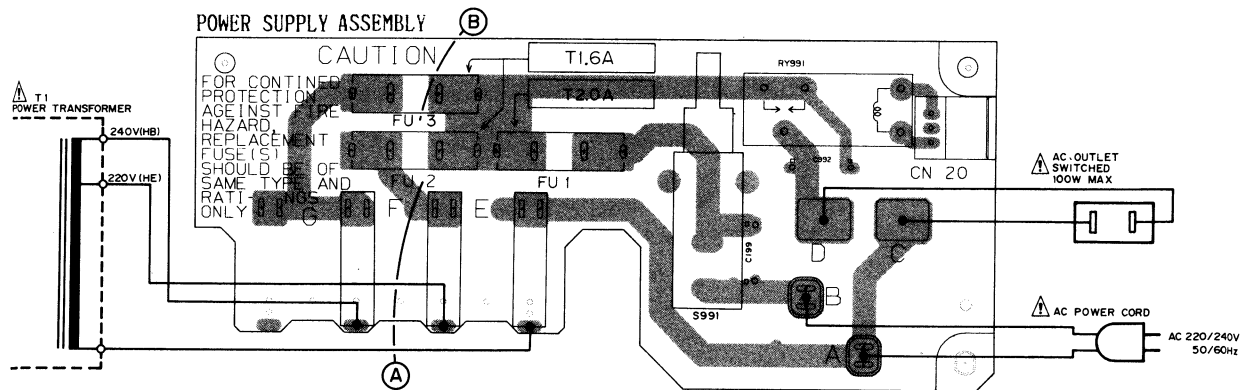

Schematic diagram for SD type

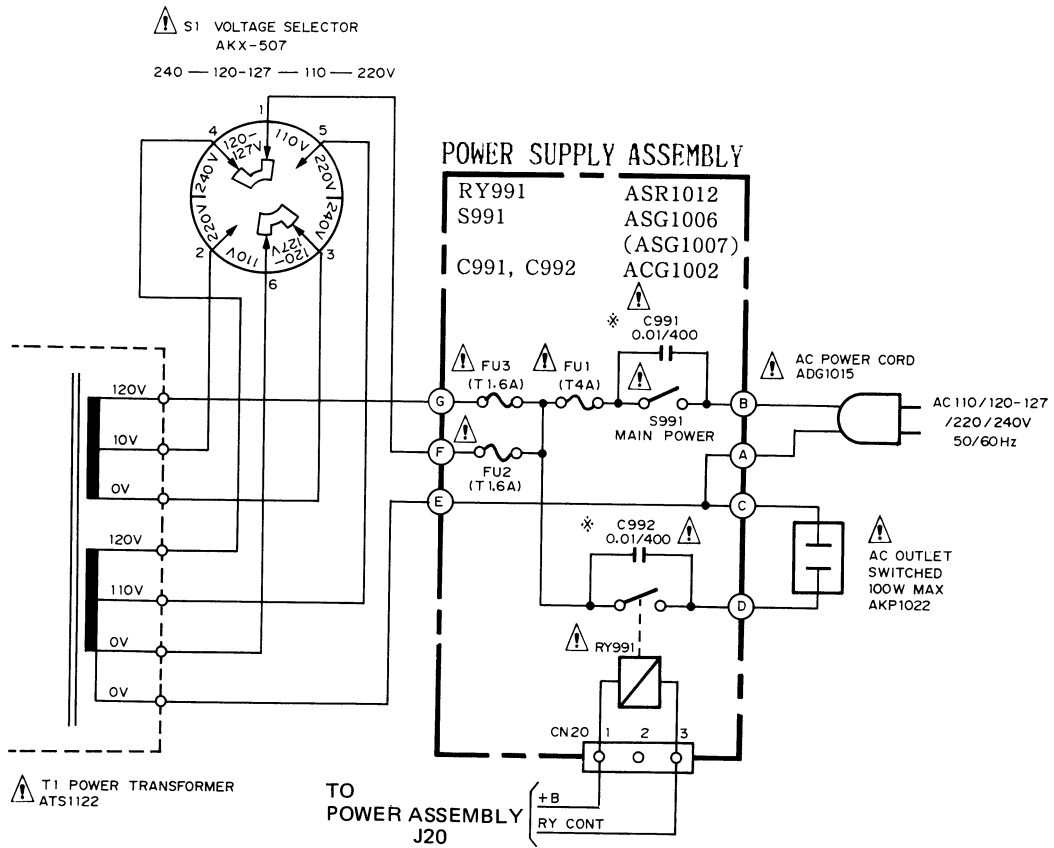

P.C.Board patterns for SD type

