

Service Manual

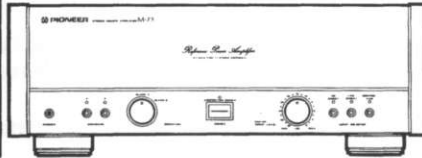

ORDER NO.
ARP2101

STEREO POWER AMPLIFIER **M-73**

MODEL M-73 HAS FOLLOWING VERSIONS :

Type	Power requirement	Export destination
HEZ	AC220V,240V (switchable) *	West Germany
HB	AC220V,240V (switchable) *	United Kingdom

* Change the connection of the power transformers (T1 and T2) lead wire.

- This manual is applicable to the M-73/HEZ and HB types.
- As to the HB type, refer to page 25.
- Ce manuel pour le service comprend les explications de réglage en français.
- Este manual de servicio trata del método ajuste escrito en español.

CONTENTS

1. EXPLODED VIEWS, PACKING AND PARTS LIST	2	4. RÉGLAGE	23
2. SCHEMATIC AND P.C.BOARDS CONNECTION DIAGRAM	6	4. AJUSTE	24
3. P.C.B 's PARTS LIST	17	5. FOR HB TYPE	25
4. ADJUSTMENTS	22	6. PANEL FACILITIES	26
		7. SPECIFICATIONS	28

1. EXPLODED VIEWS, PACKING AND PARTS LIST

NOTES:

- Parts without part number cannot be supplied.
- The Δ mark found on some component parts indicates the importance of the safety factor of the part. Therefore, when replacing, be sure to use parts of identical designation.
- Parts marked by "⊙" are not always kept in stock. Their delivery time may be longer than usual or they may be unavailable.

Parts list of Exterior and packing

Mark	No.	Description	Parts No.	Mark	No.	Description	Parts No.
	1	INPUT Assembly	AWZ3065	41	SPACER		
	2	PS Assembly	AWZ3066	42	COLOR	AEC1165	
	3	KNOB	AAB1175	43	BARRIER		
	4	PUSH KNOB	AAD1366	44	BARRIER		
	5	KNOB (POWER)	AAD1835	45	SHEET	AEE1014	
	6	SP-LCH Assembly	AWZ3067	46	VOL-F Assembly		
	7	NAME PLATE (METAL)	AAM1001	47	REG Assembly		
	8	SP-RCH Assembly	AWZ3068	48	HEAD PHONE Assembly		
	9	FRONT Assembly	AWZ3069	49	STYROL PROTECTOR	AHA1033	
	10	POWER L Assembly	AWZ3076	50	STYROL PROTECTOR	AHA1034	
	11	SCREW	ABA-298	51	PACKING CASE	AHD1925	
	12	SCREW (STEEL)	ABA1004	52	SW Assembly		
	13	SCREW (STEEL)	ABA1009	53	PACKING SHEET		
	14	SCREW (STEEL)	ABA1011	54	TERMINAL SCREW		
	15	SCREW (STEEL)	ABA1014	55	SHORT PIN PLUG	AKM-050	
	16	SCREW (STEEL)	ABA1047	56	PANEL BASE	AMB1685	
	17	SCREW (STEEL)	ABA1048	57	FOOT	AMR1158	
	18	SCREW (STEEL)	ABA1050	58	FOOT	AMR1159	
	19	SCREW	ABA1082	59	INDICATING LENS	AMR1160	
	20	SCREW (STEEL)	ABA1086	60	JOINT	AMR1178	
	21	SCREW	ABA1088	61	HEAT SINK HOLDER	AMR2193	
	22	WASHER	ABE1009	62	SIDE BOARD R	AMS1049	
	23	WASHER	ABF1017	63	SIDE BOARD L	AMS1050	
	24	COIL SPRING A	ABH1056	64	SIDE FRAME R		
	25	FLANGE NUT M9	ABN-048	65	SIDE FRAME L		
	26	NUT	ABN-065	66	TRANS. FRAME		
	27	PULG CORD	ADE1013	67	FRONT PANEL	ANB1419	
Δ	28	AC POWER CORD	ADG1036	68	REAR PANEL		
	29	GROUND LEAD		69	PANEL STAY		
	30	LEAD WIRE		70	METAL BONNET	ANE1253	
	31	LEAD WIRE		71	BOTTOM PLATE		
	32	SPACER SET	AEA1010	72	PCB HOLDER	ANG1474	
	33	CUSHION C (RUBBER)		73	EARTH PLATE		
	34	CUSHION (RUBBER)		74	HEAT SINK A		
	35	CUSHION C (RUBBER)		75	HEAT SINK B		
	36	POWER R Assembly	AWZ3078	76	HEAT SINK C		
	37	COVER		77	SHIELD CASE		
	38	STRAIN RELIEF	AEC-882	78	SHAFT	ANL1033	
	39	BINDER		79	OPERATING INSTRUCTIONS	ARE1166	
	40	PCB HOLDER		80	PIN JACK Assembly		

Mark	No.	Description	Parts No.	Mark	No.	Description	Parts No.
	81	BIAS 1 Assembly			96	TRANSISTOR (Q3)	2SA1302
	82	REINFORCE L Assembly		⚠	97	TRANSISTOR (Q4)	2SA1302
	83	SCREW	BBZ40P080FZK	⚠	98	TRANSISTOR (Q5)	2SA1302
	84	NUT	NK90FCU	⚠	99	TRANSISTOR (Q6)	2SA1302
	85	SCREW	VMZ30P060FCU	⚠	100	TRANSISTOR (Q7)	2SC3281
⚠	86	ELECTROLYTIC CAPACIT, C1	ACH1160	⚠	101	TRANSISTOR (Q8)	2SC3281
⚠	87	CKA (0.01/AC400V, C2)	ACG1003	⚠	102	PUSH SWITCH (POWER, S1)	ASG-553
⚠	88	FUSE (T800MA, FU1)	AEK-031	⚠	103	POWER TRANSFORMER (T1)	ATS1298
⚠	89	FUSE (T800MA, FU2)	AEK-031	⚠	104	POWER TRANSFORMER (T2)	ATS1299
⚠	90	FUSE (T5A, FU3)	AEK-015	⚠	105	REINFORCE R Assembly	
⚠	91	FUSE (T5A, FU4)	AEK-015		106	BIAS 3 Assembly	
⚠	92	FUSE (T3.15A, FU5)	AEK-042		107	SCREW (STEEL)	ABA1115
⚠	93	FUSE (T3.15A, FU6)	AEK-042		108	SCREW	BBZ30P050FZK
⚠	94	TRANSISTOR (Q1)	2SC3281				
⚠	95	TRANSISTOR (Q2)	2SC3281				

packing

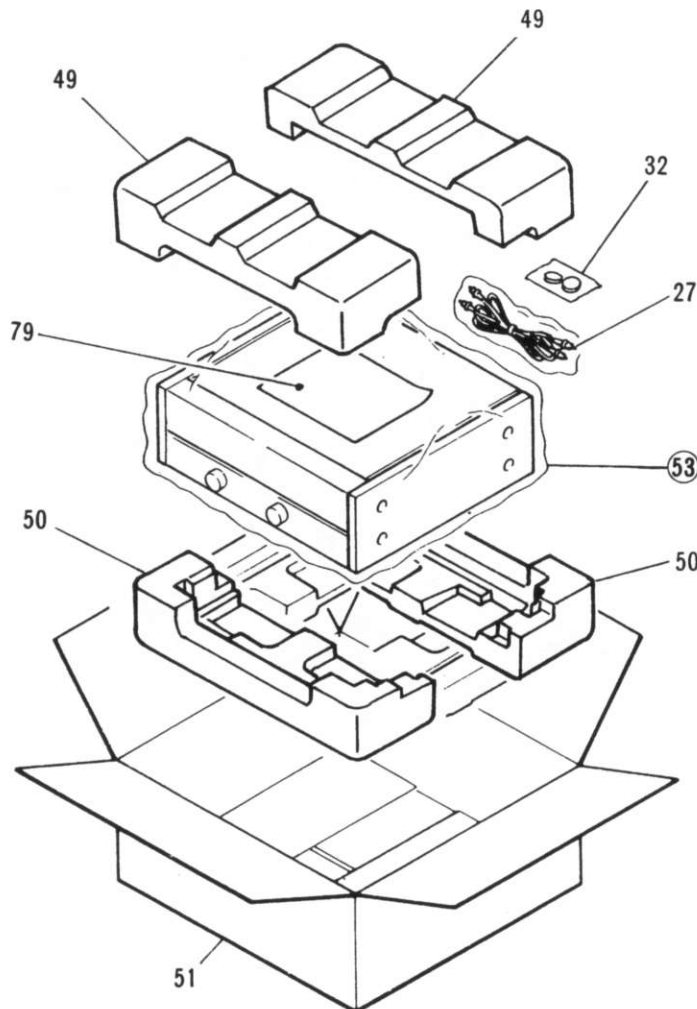

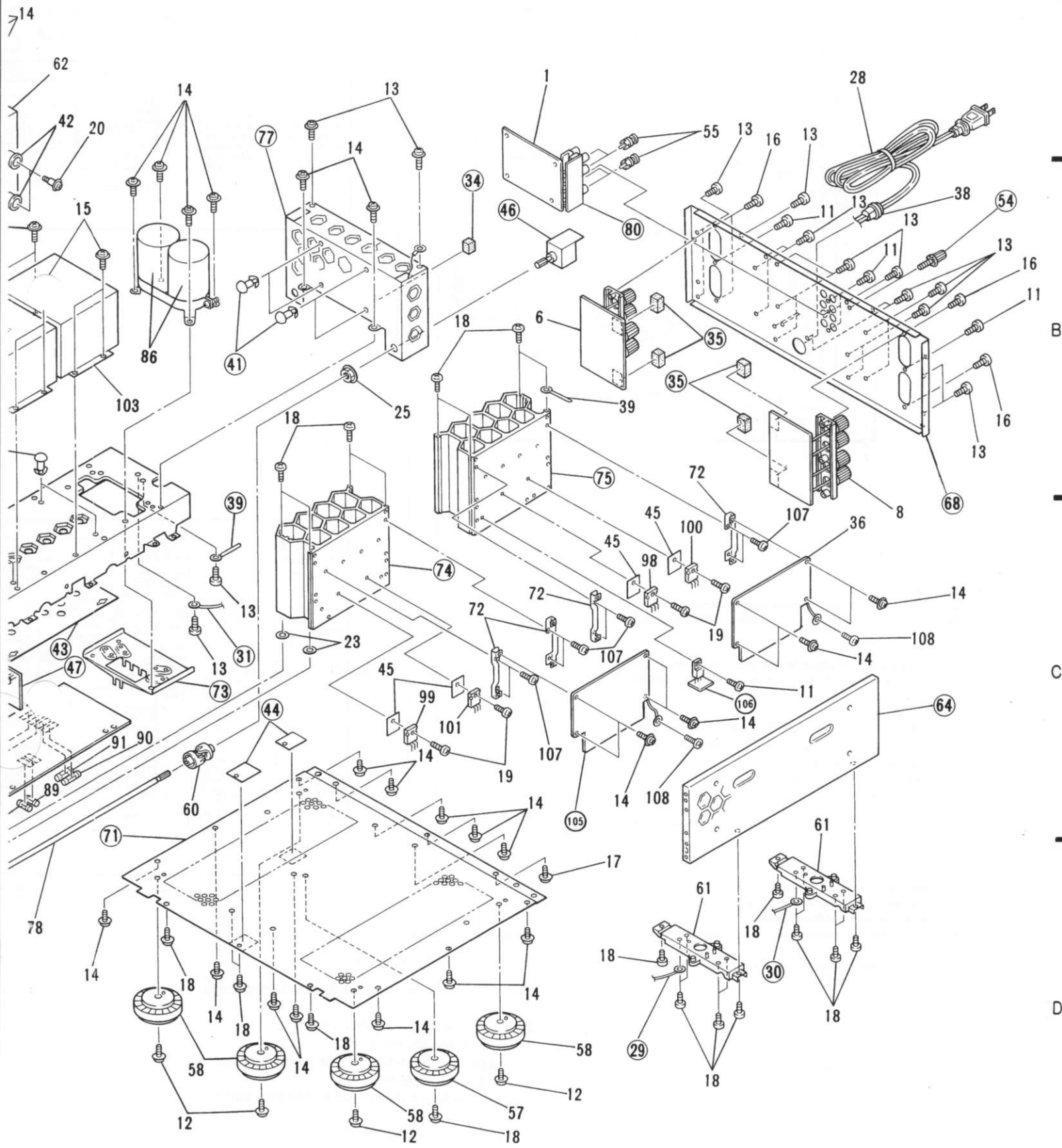

2. SCHEMATIC AND P.C.BOARDS CONNECTION DIAGRAM

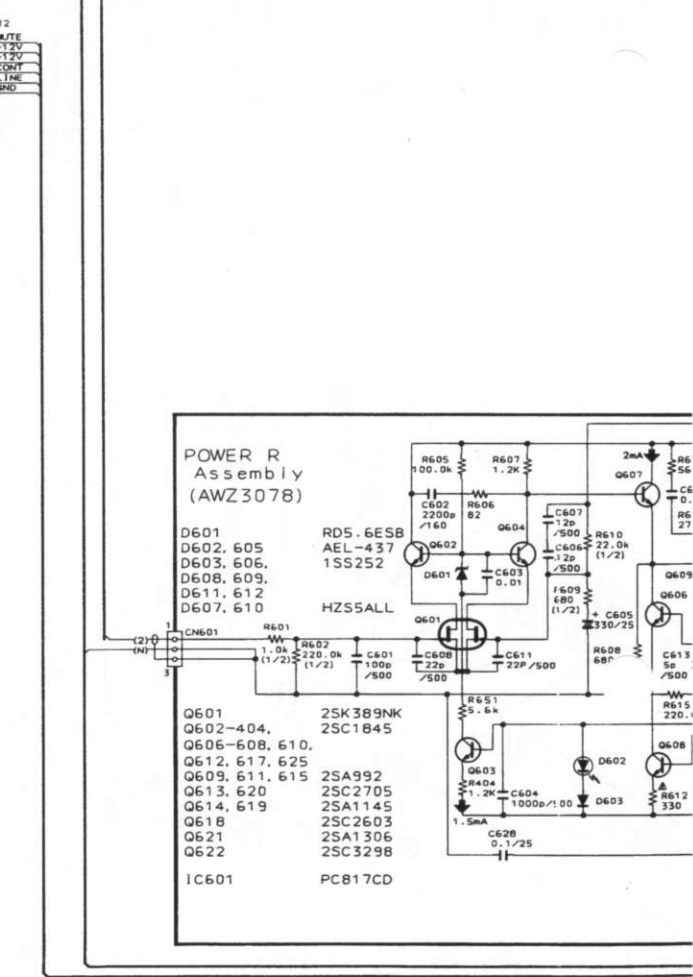
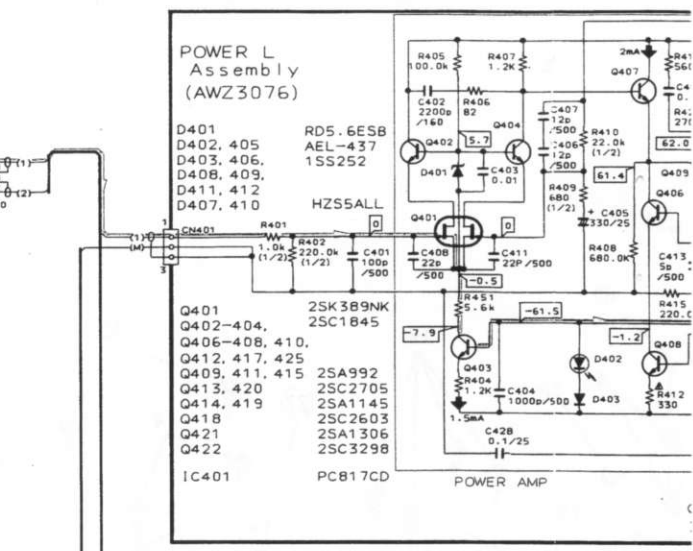
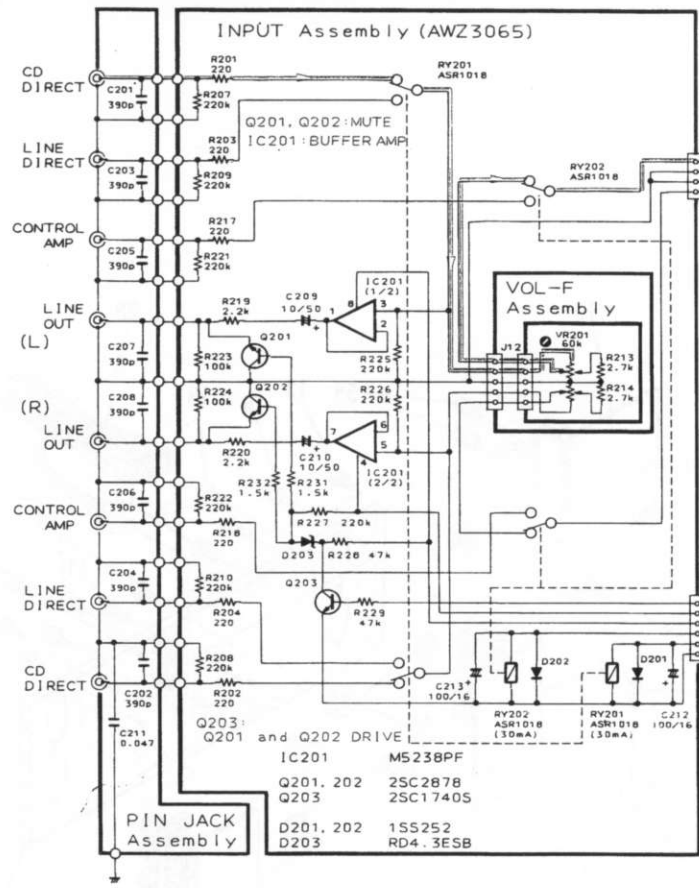

- RESISTORS:**
Indicated in Ω, ¼W, ½W, ±5% tolerance unless otherwise noted k: kΩ, M: MΩ, (F): ±1%, (G): ±2%, (K): ±10% (M): ±20% tolerance.
- CAPACITORS:**
Indicated in capacity (µF)/voltage (V) unless otherwise noted p: pF. Indication without voltage is 50V except electrolytic capacitor.
- VOLTAGE, CURRENT:**
 - \square V: Signal voltage at [125W + 125W 8Ω (Class B), 25W + 25W 8Ω (Class A)] output(1kHz).
 - \square DC voltage (V) at no input signal.
 - Value in () is DC voltage at rated power.
 - ← mA: DC current at no input signal.

NOTE: Voltage and current are shown in the CLASS B mode.

4. OTHERS:
 →: Signal route.
 ⊗: Adjusting point.
 The Δ mark found on some component parts indicates the importance of the safety factor of the part. Therefore, when replacing, be sure to use parts of identical designation.
 * marked capacitors and resistors have parts numbers.

This is the basic schematic diagram, but the actual circuit may vary due to improvements in design.

5. SWITCHES
- S1: POWER SW
- FRONT Assembly
- S301: CD DIRECT ON-OFF
 LINE DIRECT ON-OFF
 CONTROL AMP ON-OFF
- S302: SP-A ON-OFF
 SP-B ON-OFF

LINE VOLTAGE SELECTION (For HEZ and HB types)

Line voltage can be changed with following steps.

1. Disconnect the AC power cord.
2. Remove the top cover.
3. Change the connection of the power transformers (T1 and T2) lead wire.
4. Stick the line voltage label on the rear panel.

Part No.	Description
AAX-193	220V level
AAX-192	240V level

SI. A46028

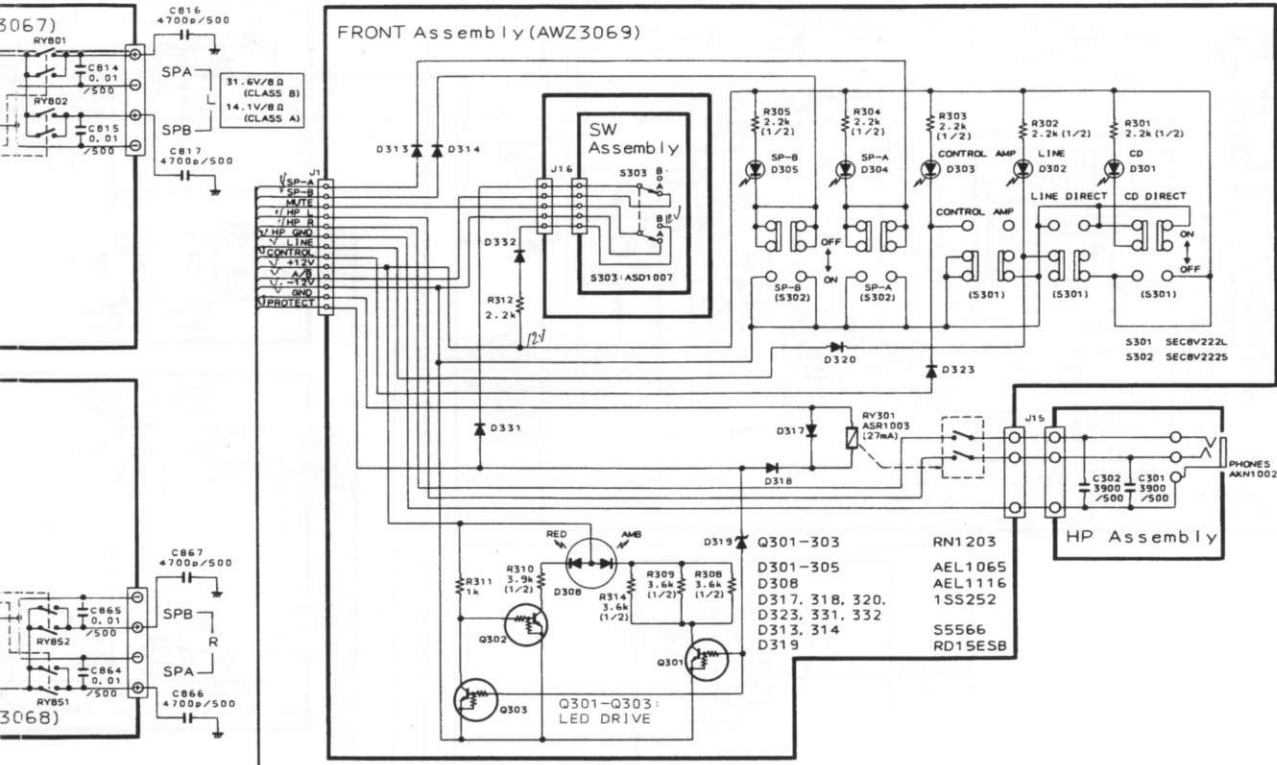

IC101, IC102: REGULATOR

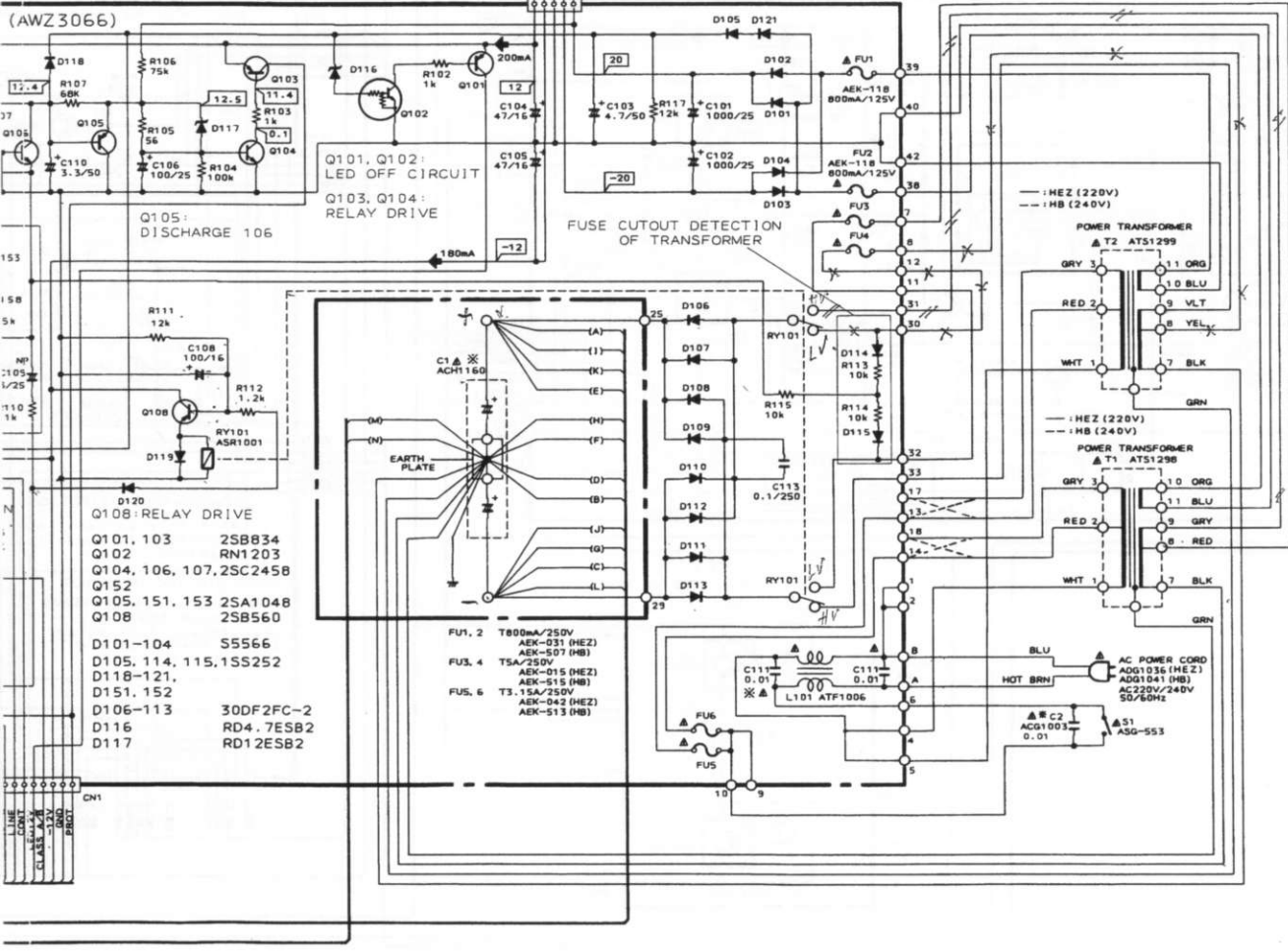
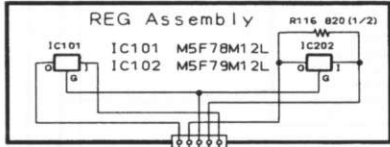

POWER L Assembly (AWZ3076)

NOTE

1. This P.C.B. connection diagram is viewed from the parts mounted side.
2. The parts which have been mounted on the board can be replaced with those shown with the corresponding wiring symbols listed in the following Table.

A

P.C.B. pattern diagram indication	Corresponding part symbol	Part Name	P.C.B. pattern diagram indication	Part Name
		Transistor	IC	IC
		Radiator type transistor	S	Switch
		Diode	RY	Relay
		Resistor	L	Coil
		Capacitor (Polarity)	F	Filter
		Capacitor (Non-polarity)	VR	Variable resistor or Semi fixed resistor

Others

3. The capacitor terminal marked with (⊖) (double circles) shows negative terminal.
4. The diode terminal marked with (⊖) (double circles) shows cathode side.
5. The transistor terminal to which E is affixed shows the emitter.

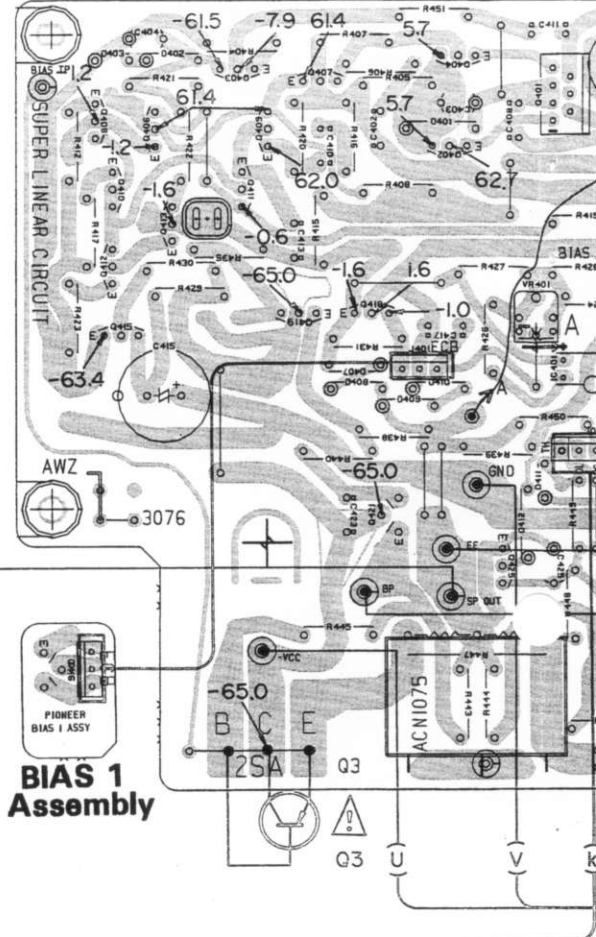

B

SP-LCH Assembly (AWZ3067)

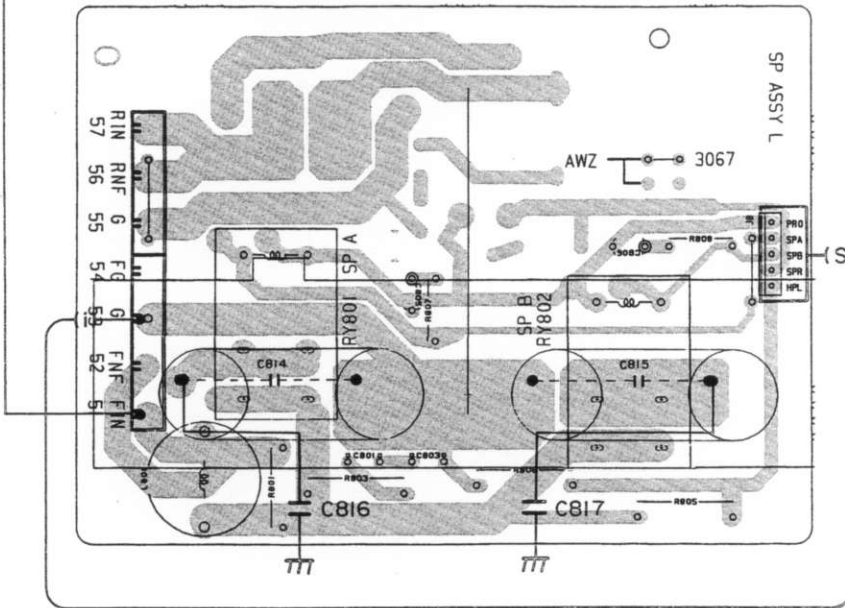

C

SP-RCH Assembly (AWZ3068)

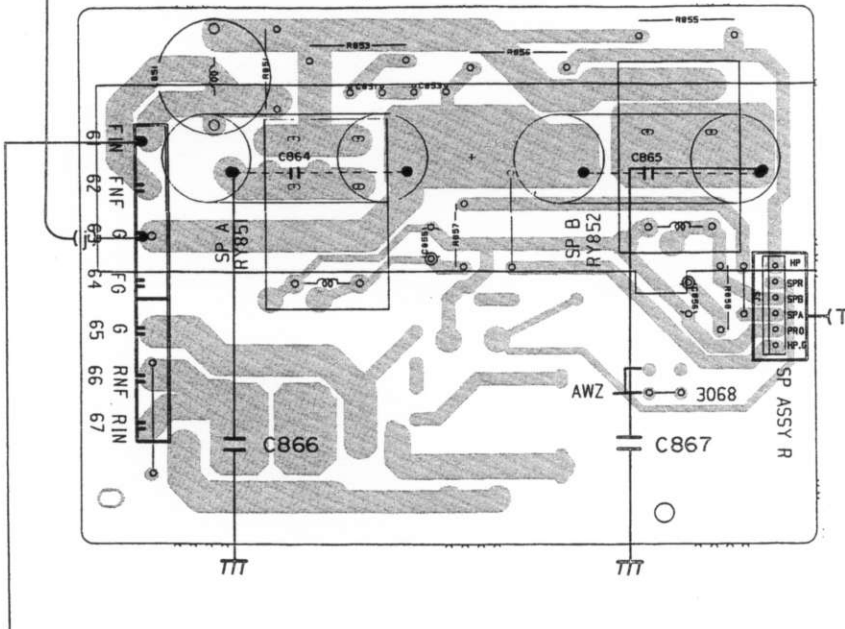

D

REINFORCE R Assembly

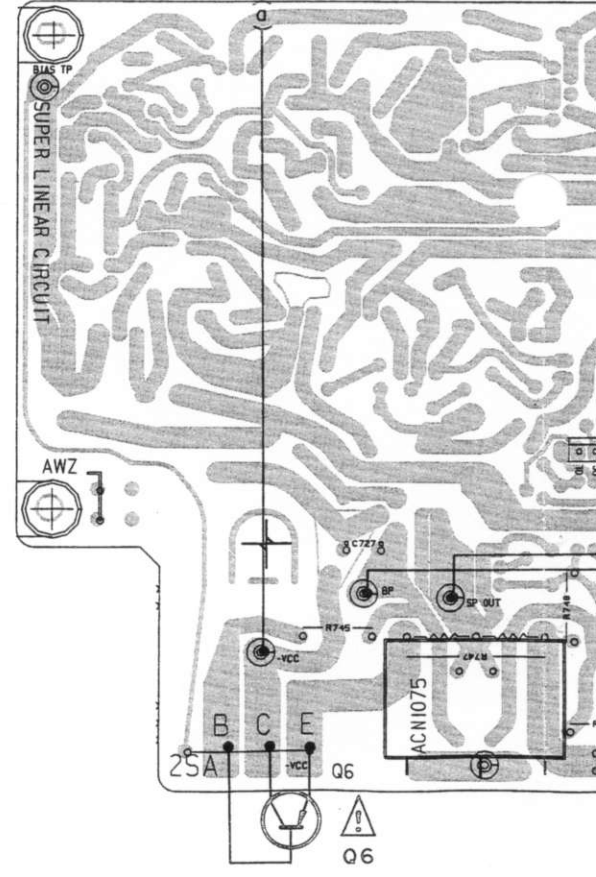

REINFORCE L Assembly

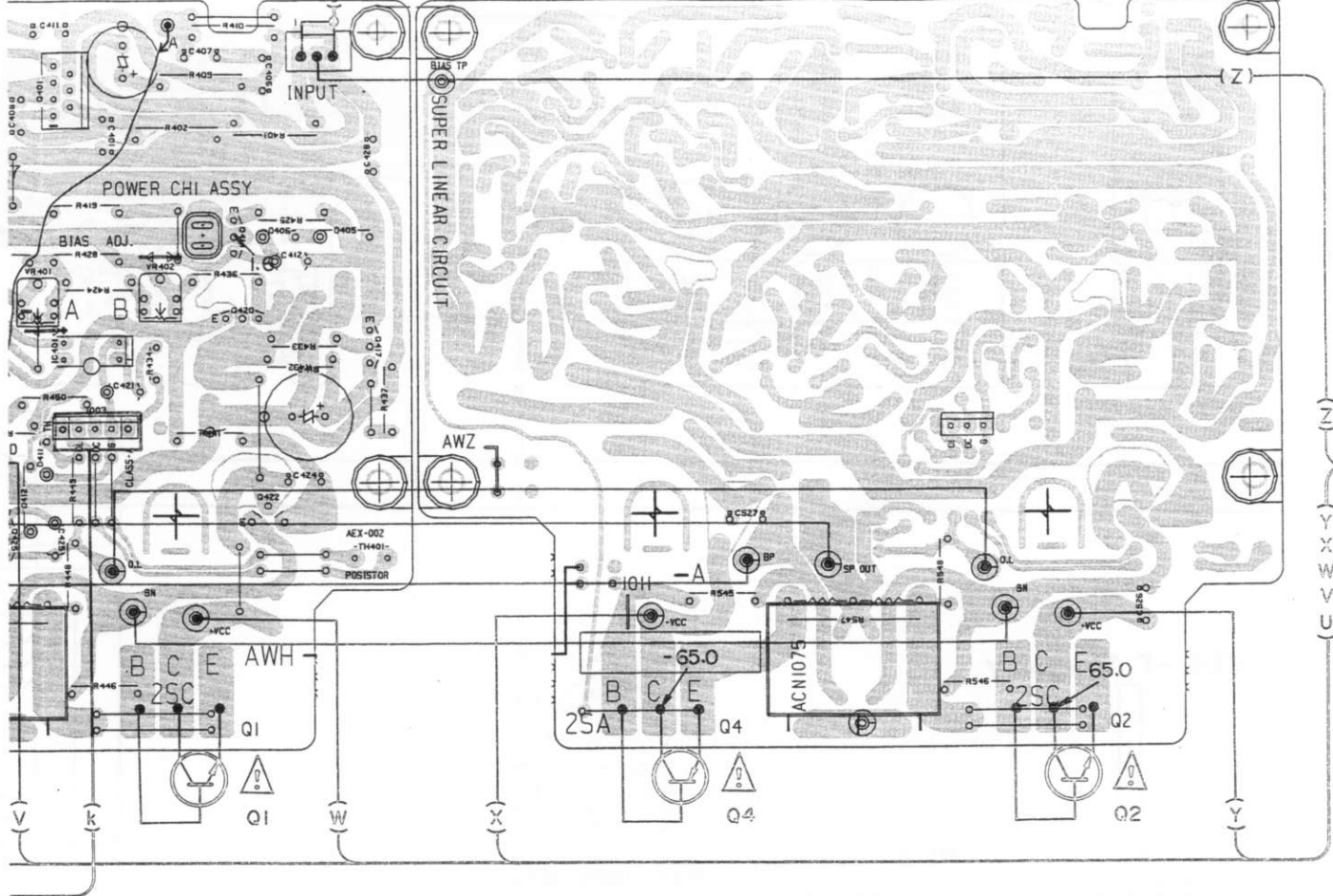

Assembly

POWER R Assembly (AWZ3078)

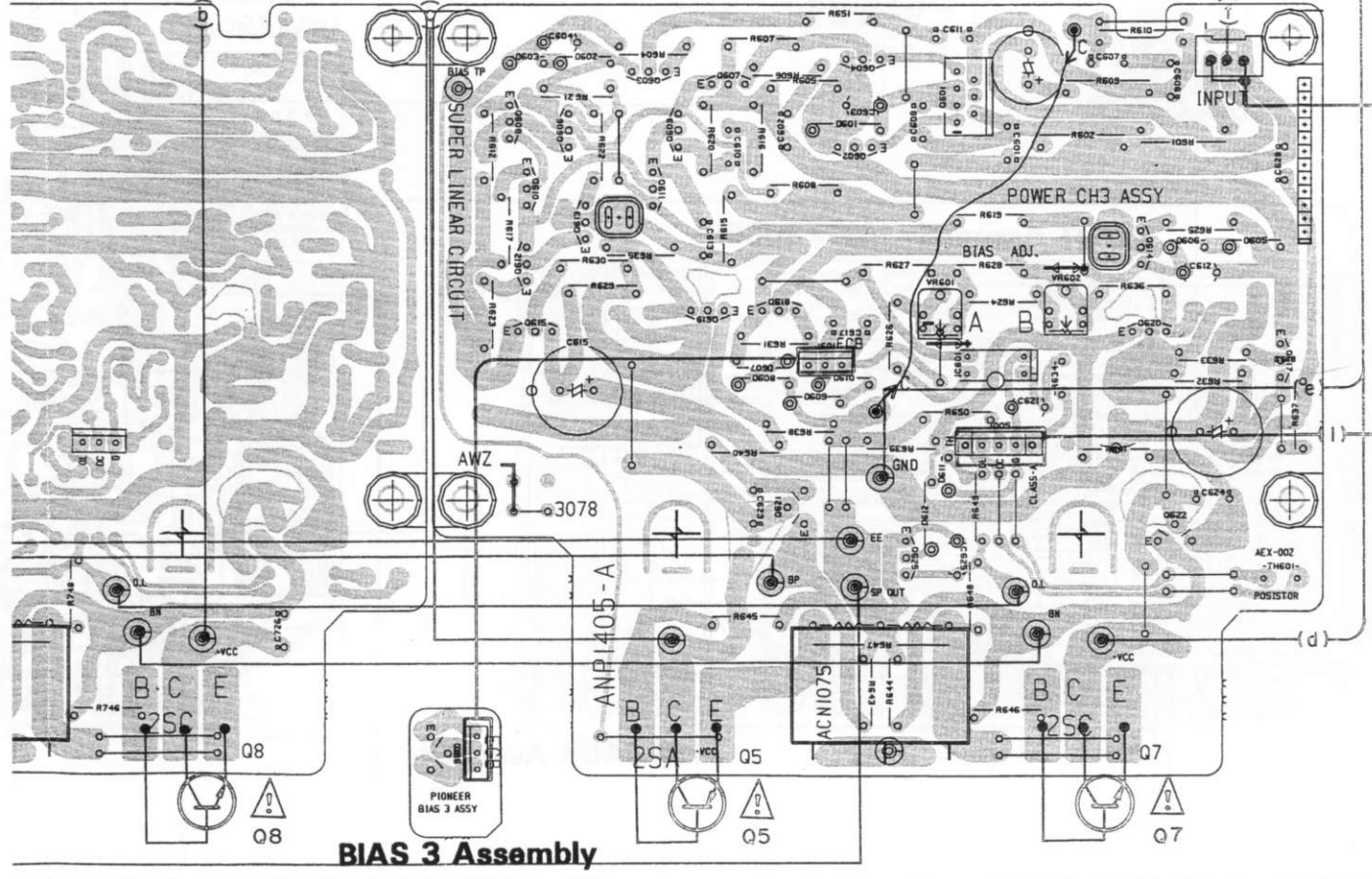

BIAS 3 Assembly

HEAD PHONE Assembly

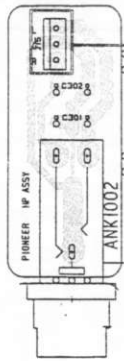

FRONT Assembly (AWZ3069)

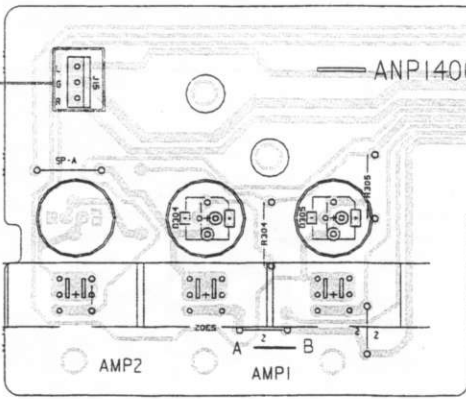

VOL - F Assembly

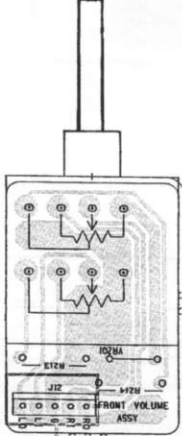

REG Assembly

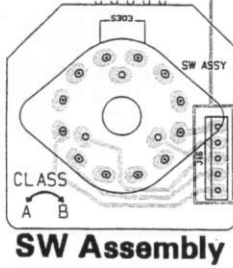
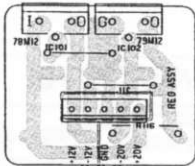

INPUT Assembly (AWZ3065)

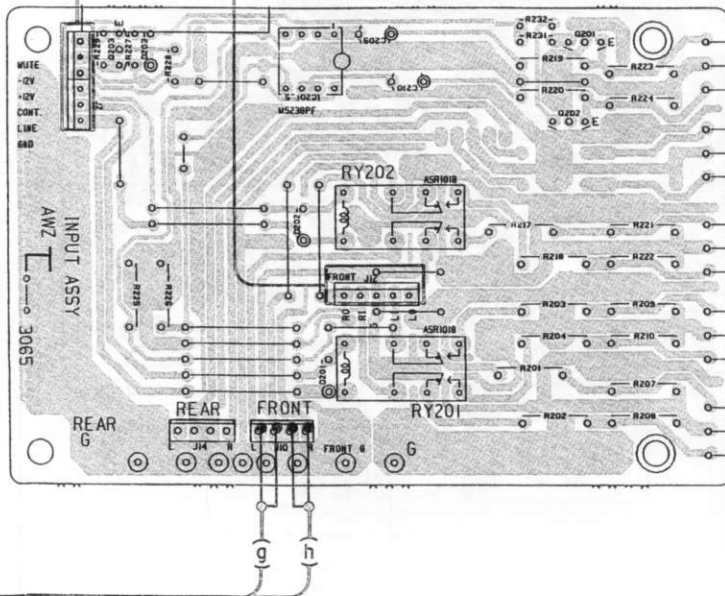

PIN JACK Assembly

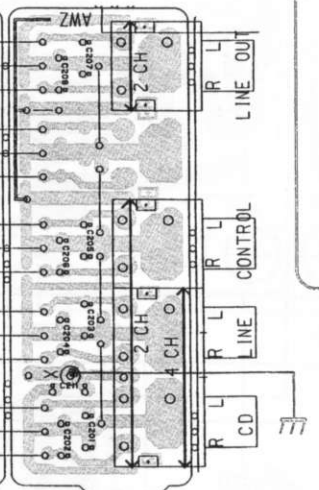

PS Assembly (AWZ3066)

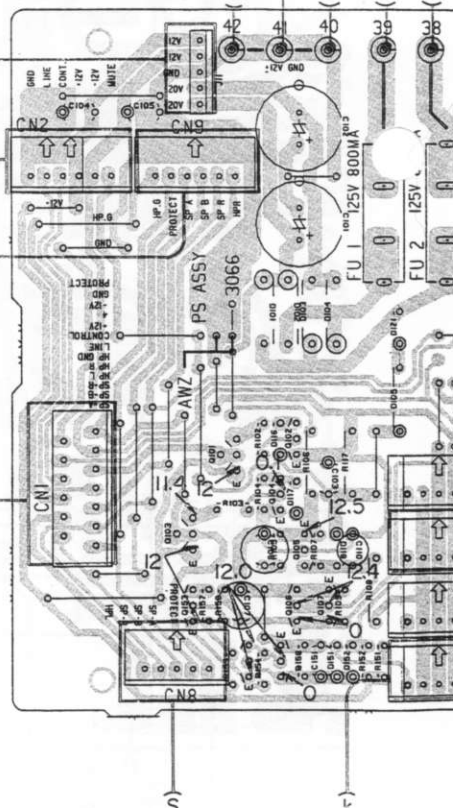

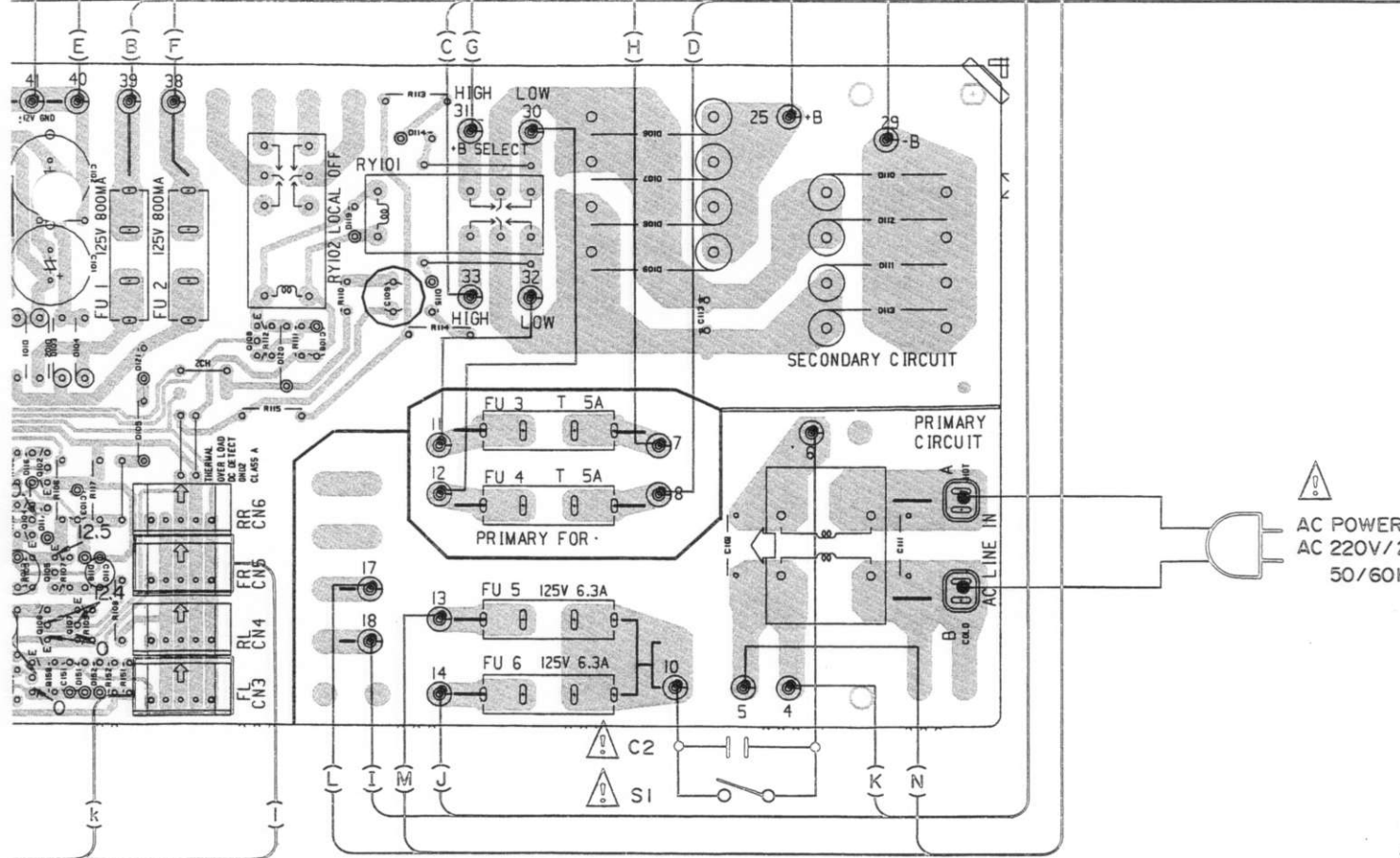
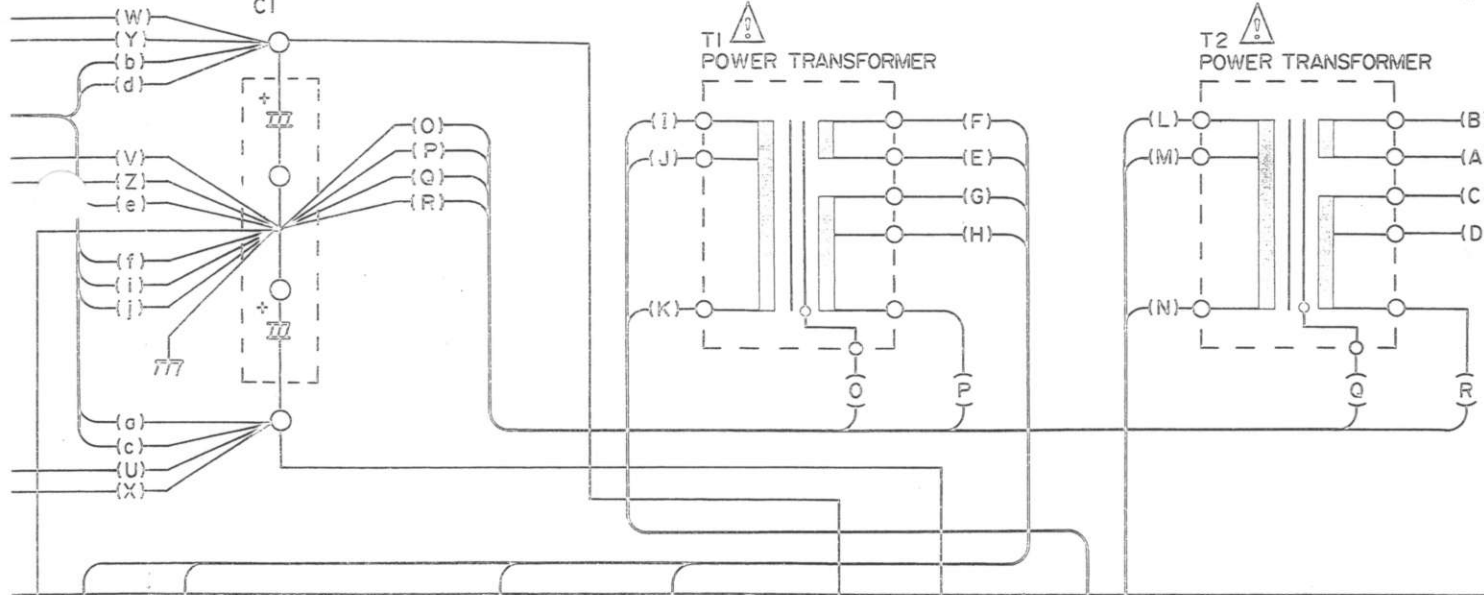
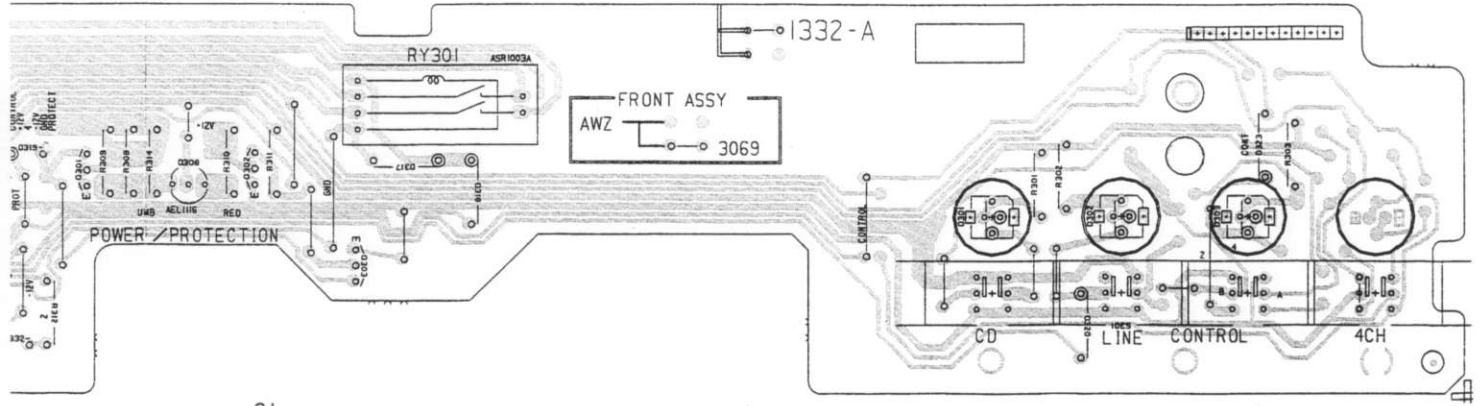

A

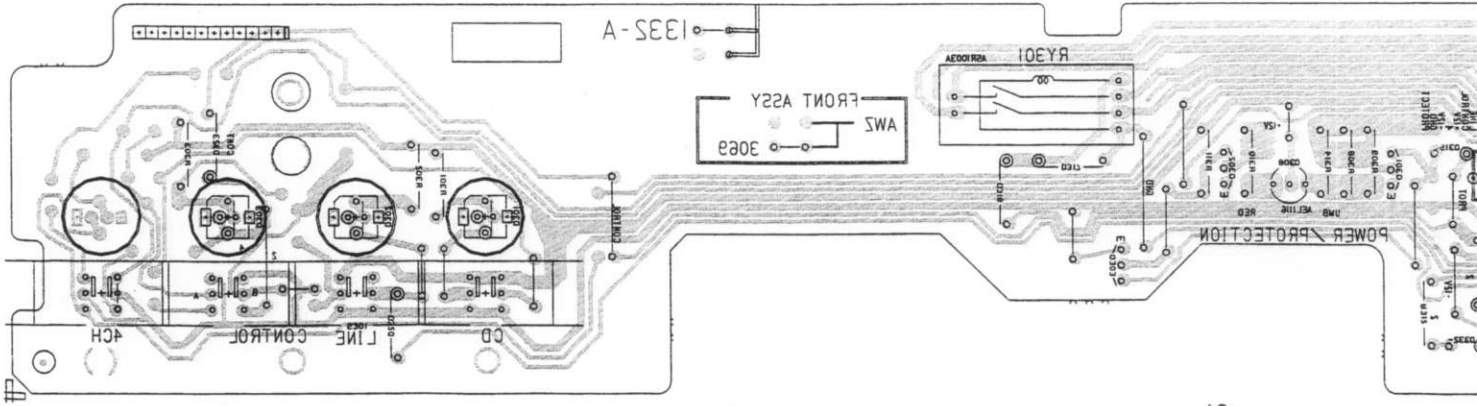

B

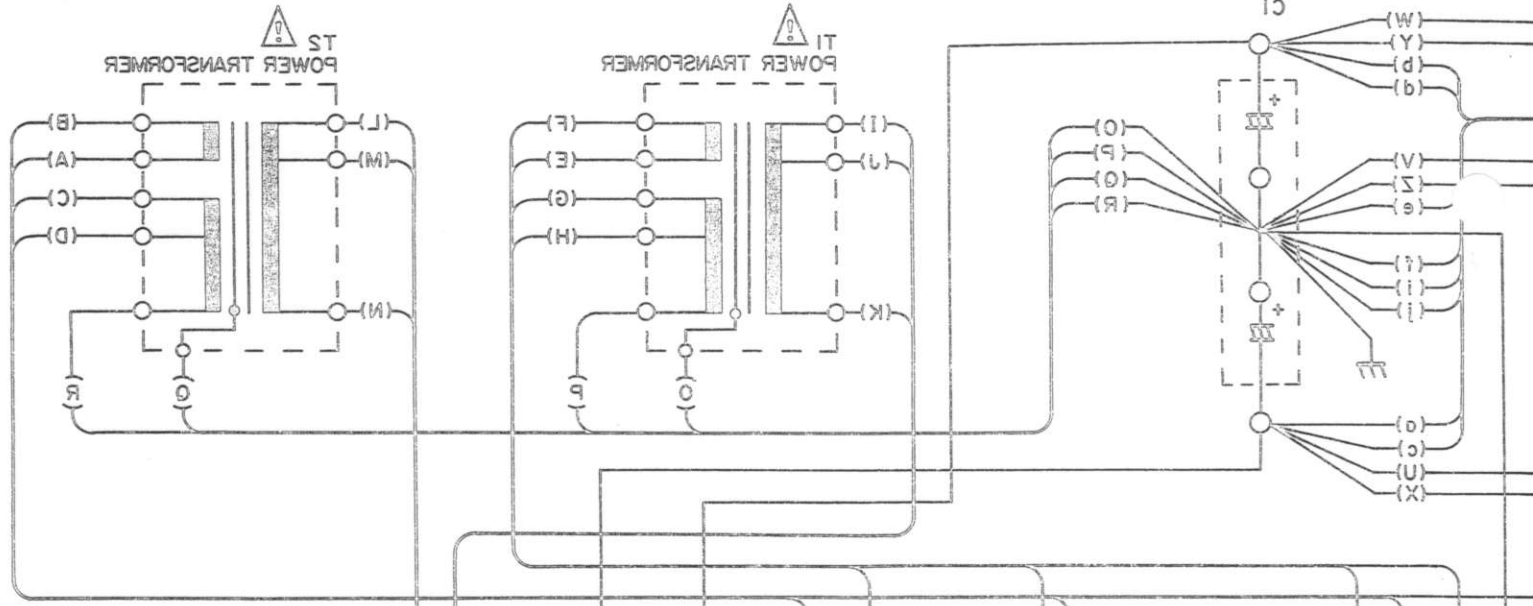

C

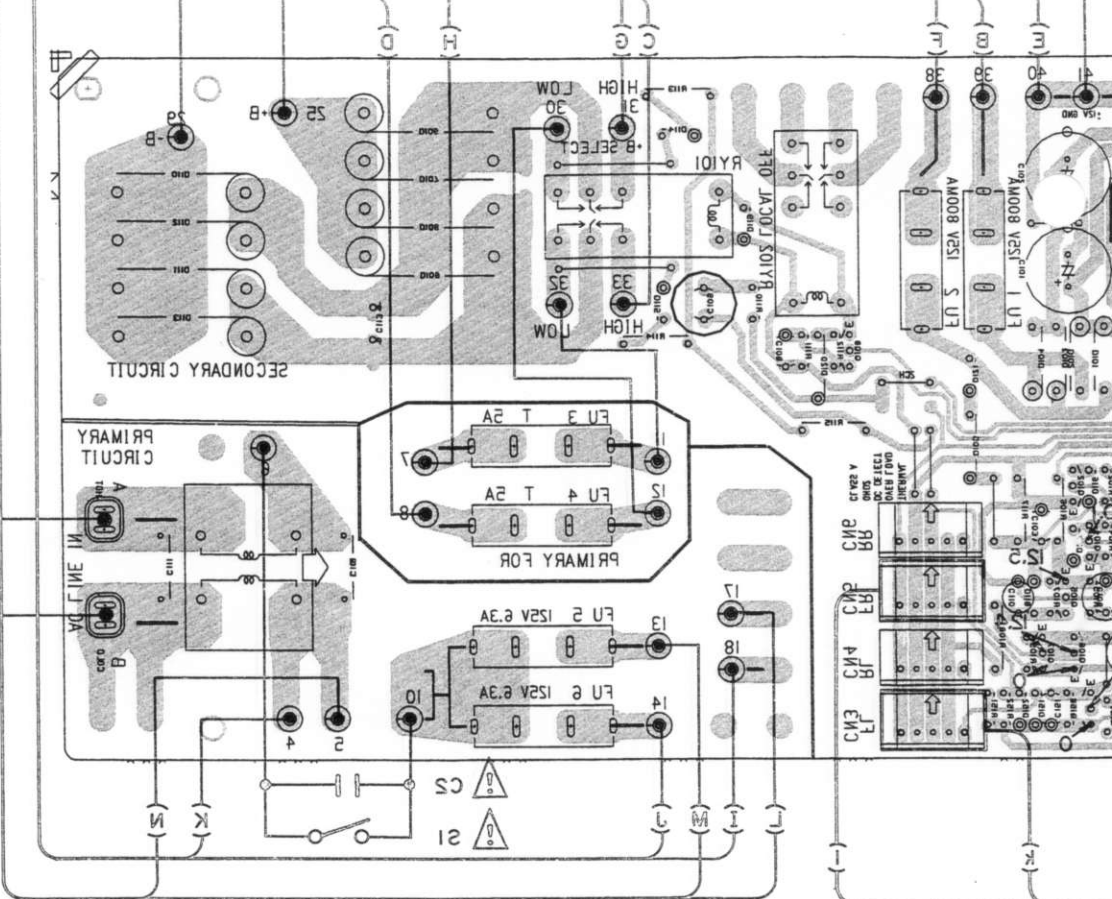

D

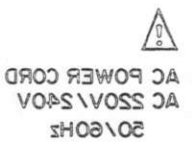

**HEAD PHONE
Assembly**

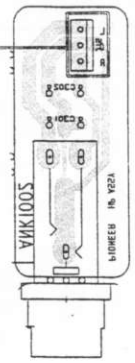

FRONT Assembly (AW3065)

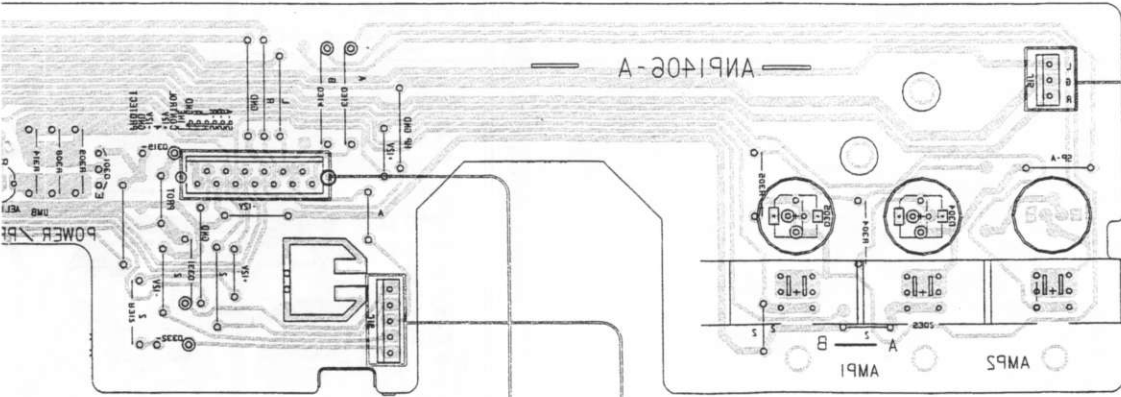

VOL - F Assembly

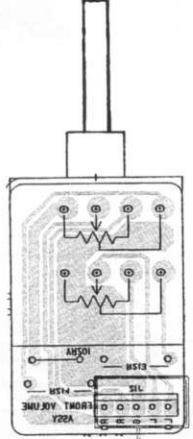

REG Assembly

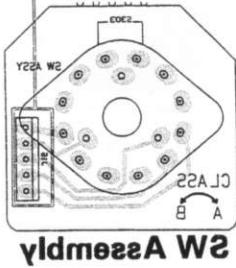
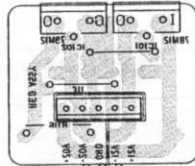

SW Assembly

INPUT Assembly (AW3065)

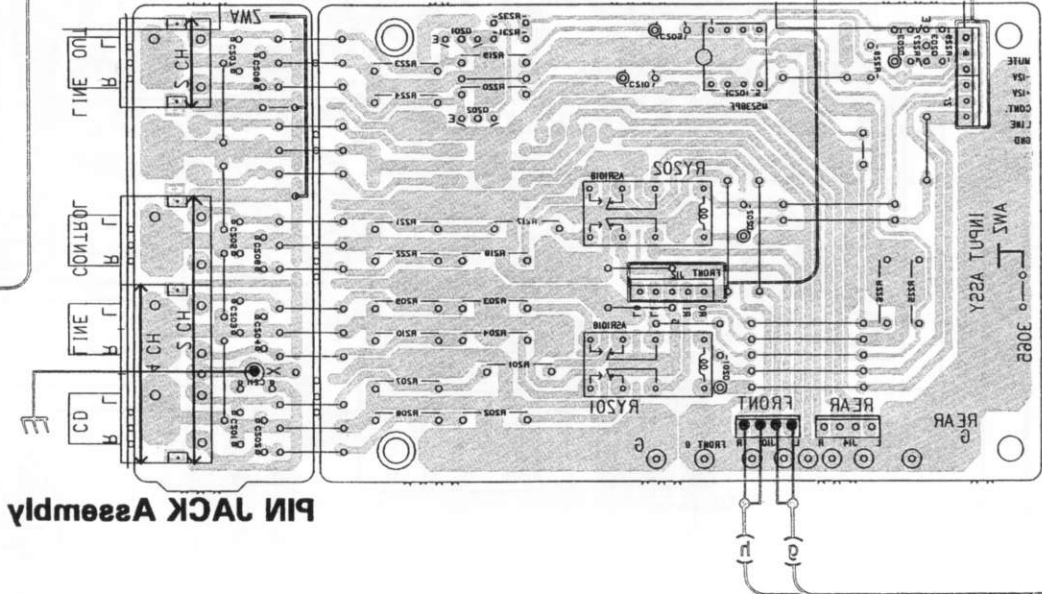

PS Assembly (AW3066)

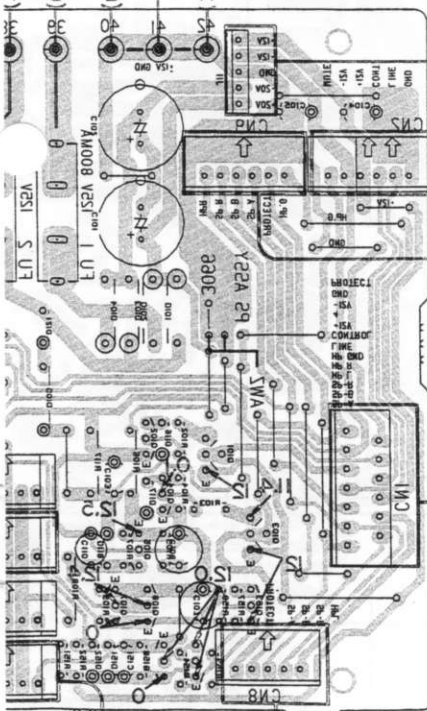

PIN JACK Assembly



REINFORCE I Assembly

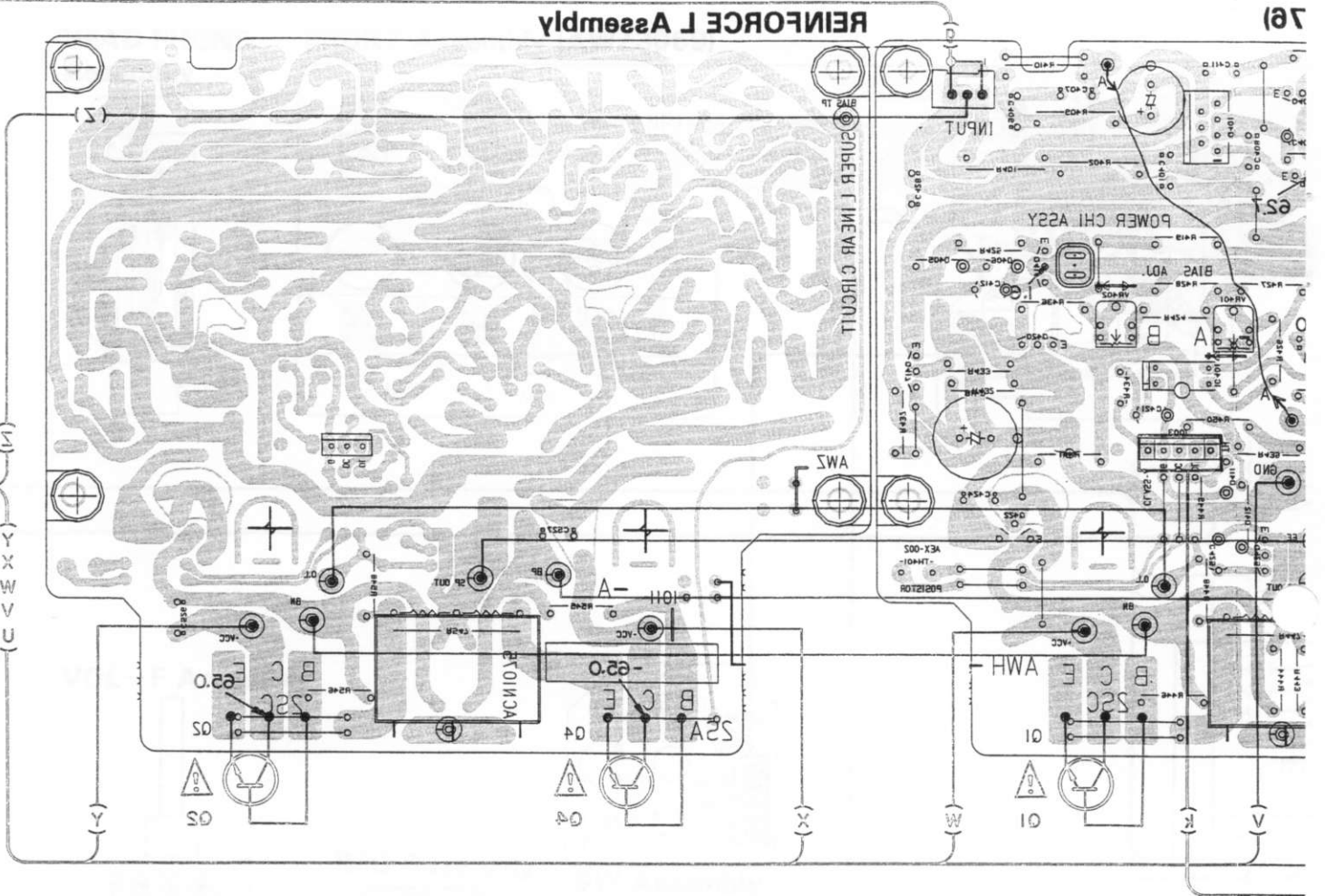

R Assembly

POWER R Assembly (AW3078)

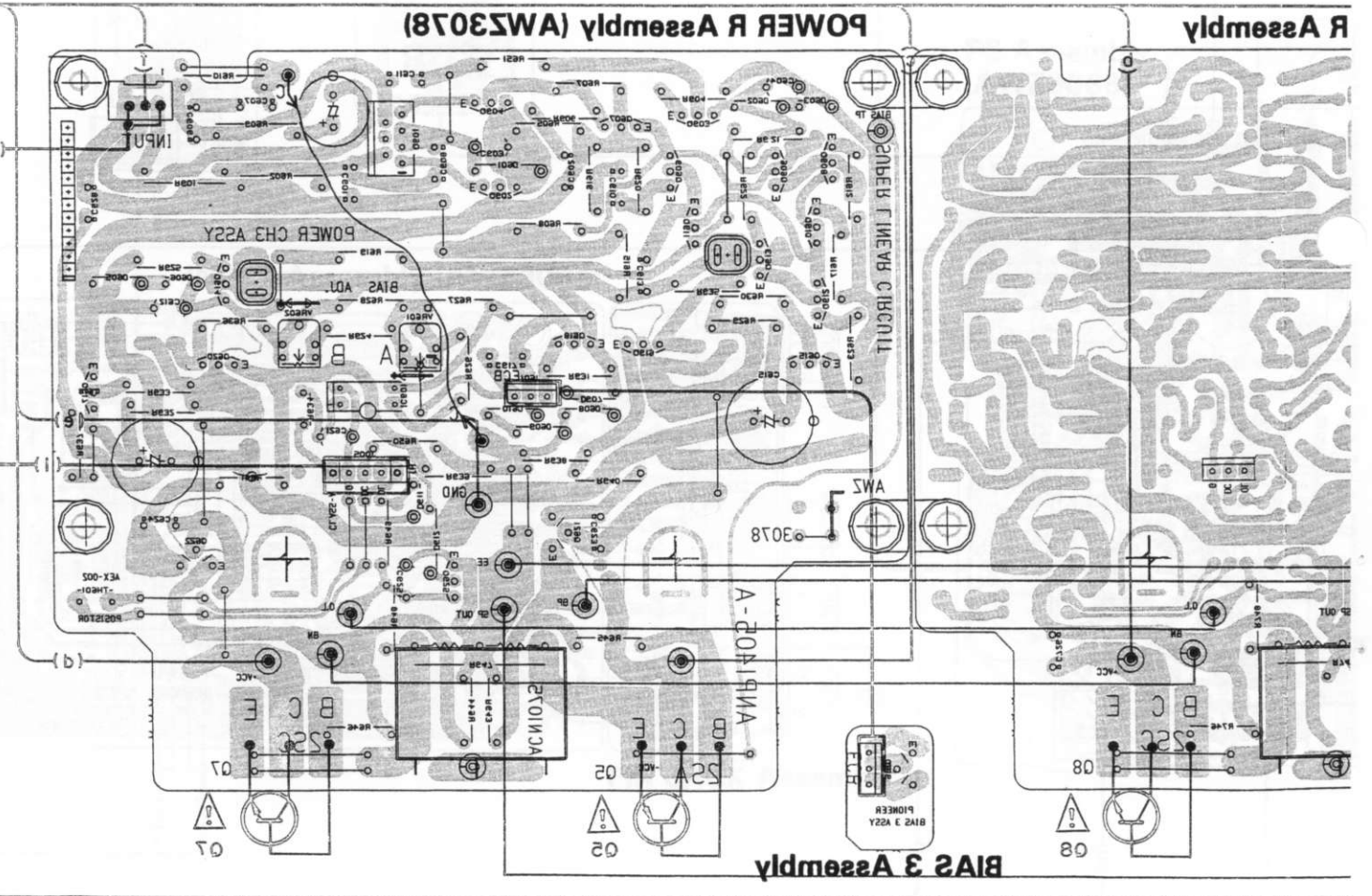

BIAS 3 Assembly

3. P.C.B 's PARTS LIST

NOTES:

- Parts without part number cannot be supplied.
- Parts marked by "●" are not always kept in stock. Their delivery time may be longer than usual or they may be unavailable.
- The Δ mark found on some component parts indicates the importance of the safety factor of the part. Therefore, when replacing, be sure to use parts of identical designation.
- When ordering resistors, first convert resistance values into code form as shown in the following examples.

Ex. 1 When there are 2 effective digits (any digit apart from 0), such as 560 ohm and 47k ohm (tolerance is shown by J = 5%, and K = 10%).

560 Ω	56 $\times 10^1$	561.....	RD1/4PS	\square \square \square J
47k Ω	47 $\times 10^3$	473.....	RD1/4PS	\square \square \square J
0.5 Ω	0R5.....		RN2H	\square \square \square K
1 Ω	010.....		RS1P	\square \square \square K

Ex. 2 When there are 3 effective digits (such as in high precision metal film resistors).

5.62k Ω	562 $\times 10^1$	5621.....	RN1/4SR	\square \square \square \square F
----------------	-------------------	-----------	---------	---

Mark No.	Description	Parts No.	Mark No.	Description	Parts No.
BIAS 1 ASSEMBLY			CAPACITORS		
SEMICONDUCTOR			C401	MICA CAPACITOR	CMA101J500
Q416	TRANSISTOR	2SC3298	C402	PL.STYRENE CAPACITOR	CQSXA222J160
POWER L ASSEMBLY (AWZ3078)			C403	AUDIO FILM CAPACITOR	CFTXA103J50
SEMICONDUCTORS			C404	CERAMIC CAPACITOR	CKDYB102K500
IC401	PHOTOCUPLER	PC817CD	C405	ELECTROLYTIC CAPACIT	CEXA331M25
Q401	N-DUAL-FET	2SK389NK	C406,407	MICA CAPACITOR	CMA120J500
Q402-404	TRANSISTOR	2SC1845	C408	MICA CAPACITOR	CMA220J500
Q406-408	TRANSISTOR	2SC1845	C410	AUDIO FILM CAPACITOR	CFTXA103J50
Q409	TRANSISTOR	2SA992	C411	MICA CAPACITOR	CMA220J500
Q410	TRANSISTOR	2SC1845	C412	CERAMIC CAPACITOR	CKDYB102K500
Q411	TRANSISTOR	2SA992	C413	MICA CAPACITOR	CMA050D500
Q412	TRANSISTOR	2SC1845	C415	ELECTROLYTIC CAPACIT	CEXA101M2A
Q413	TRANSISTOR	2SC2705	C417	PL.STYRENE CAPACITOR	CQSXA471J160
Q414	TRANSISTOR	2SA1145	C418	ELECTROLYTIC CAPACIT	CEXA101M2A
Q415	TRANSISTOR	2SA992	C420	ELECTR.CAPACITOR	CEXA100M50
Q417	TRANSISTOR	2SC1845	C421	ELECTR.CAPACITOR	CEAS220M50
Q418	TRANSISTOR	2SC2603	C423,424	MICA CAPACITOR	CMA680J500
Q419	TRANSISTOR	2SA1145	C425	ELECTROLYTIC CAPACIT	CEHAQ3R3M2A
Q420	TRANSISTOR	2SC2705	C428	CERAMIC CAPACITOR	CKCYX104M25
Q421	TRANSISTOR	2SA1306	RESISTORS		
Q422	TRANSISTOR	2SC3298	R401	CARBON FILM RESISTOR	RDR1/2PM102J
Q425	TRANSISTOR	2SC1845	R402	CARBON FILM RESISTOR	RDR1/2PM224J
D401	ZENER DIODE	RD5.6ESB	R404	CARBON FILM RESISTOR	RD1/4PM122J
D402	LED(RED)	AEL-437	R405	CARBON FILM RESISTOR	RD1/4PM104J
D403	DIODE	1SS252	R406	CARBON FILM RESISTOR	RD1/4PM820J
D405	LED(RED)	AEL-437			
D406	DIODE	1SS252			
D407	ZENER DIODE	HZS5ALL			
D408,409	DIODE	1SS252			
D410	ZENER DIODE	HZS5ALL			
D411,412	DIODE	1SS252			

Mark No.	Description	Parts No.
R407	CARBON FILM RESISTOR	RD1/4PM122J
R408	CARBON FILM RESISTOR	RD1/4PM684J
R409	CARBON FILM RESISTOR	RDR1/2PM681J
R410	CARBON FILM RESISTOR	RDR1/2PM223J
R415	CARBON FILM RESISTOR	RDR1/4PM224J
R416	CARBON FILM RESISTOR	RD1/4PM561J
R419,421	CARBONFILM RESISTOR	RD1/2PM223J
R422	CARBON FILM RESISTOR	RD1/4PM470J
R424	CARBON FILM RESISTOR	RD1/4PM512J
R426	CARBON FILM RESISTOR	RD1/4PM332J
R427	CARBON FILM RESISTOR	RD1/4PM222J
R428	CARBON FILM RESISTOR	RD1/4PM512J
R431	CARBON FILM RESISTOR	RD1/4PM122J
R434	CARBONFILM RESISTOR	RD1/8PM102J
R437	CARBON FILM RESISTOR	RD1/4PM473J
R447	RESISTOR (0.33, 5W)	ACN1075
R448	CARBON FILM RESISTOR	RD1/4PMF392J
R449	CARBONFILM RESISTOR	RD1/8PM153J
R450	CARBONFILM RESISTOR	RD1/4PM103J
R451	CARBON FILM RESISTOR	RD1/4PM562J
TH401		AEX-002
VR401	VR	ACP1043
VR402	VR	ACP1045
	Other resistors	RFA1/4PS□□□J

REINFORCE L ASSEMBLY

CAPACITORS

C526,527 MICA CAPACITOR CMA221J500

RESISTORS

R545,546 FUSLIBLE RESISTOR RFA1/4PS4R7J
 R547 RESISTOR (0.33, 5W) ACN1075
 R548 CARBON FILM RESISTOR RD1/4PMF392J

Mark No.	Description	Parts No.
POWER R ASSEMBLY (AWZ3078)		
SEMICONDUCTORS		
IC601	PHOTOCOPLER	PC817CD
Q601	N-DUAL-FET	2SK389NK
Q602-604	TRANSISTOR	2SC1845
Q606-608	TRANSISTOR	2SC1845
Q609	TRANSISTOR	2SA992
Q610	TRANSISTOR	2SC1845
Q611	TRANSISTOR	2SA992
Q612	TRANSISTOR	2SC1845
Q613	TRANSISTOR	2SC2705
Q614	TRANSISTOR	2SA1145
Q615	TRANSISTOR	2SA992
Q617	TRANSISTOR	2SC1845
Q618	TRANSISTOR	2SC2603
Q619	TRANSISTOR	2SA1145
Q620	TRANSISTOR	2SC2705
Q621	TRANSISTOR	2SA1306
Q622	TRANSISTOR	2SC3298
Q625	TRANSISTOR	2SC1845
D601	ZENER DIODE	RD5.6ESB
D602	LED(RED)	AEL-437
D603	DIODE	1SS252
D605	LED(RED)	AEL-437
D606	DIODE	1SS252
D607	ZENER DIODE	HZS5ALL
D608,609	DIODE	1SS252
D610	ZENER DIODE	HZS5ALL
D611,612	DIODE	1SS252
CAPACITORS		
C601	MICA CAPACITOR	CMA101J500
C602	PL.STYRENE CAPACITOR	CQSXA222J160
C603	AUDIO FILM CAPACITOR	CFTXA103J50
C604	CERAMIC CAPACITOR	CKDYB102K500
C605	ELECTROLYTIC CAPACIT	CEXA331M25
C606,607	MICA CAPACITOR	CMA120J500
C608	MICA CAPACITOR	CMA220J500
C610	AUDIO FILM CAPACITOR	CFTXA103J50
C611	MICA CAPACITOR	CMA220J500
C612	CERAMIC CAPACITOR	CKDYB102K500
C613	MICA CAPACITOR	CMA050D500
C615	ELECTROLYTIC CAPACIT	CEXA101M2A
C617	PL.STYRENE CAPACITOR	CQSXA471J160
C618	ELECTROLYTIC CAPACIT	CEXA101M2A
C620	ELECTROLYTIC CAPACIT	CEXA100M50

Mark	No.	Description	Parts No.
	C621	ELECTR.CAPACITOR	CEAS220M50
	C623,624	MICA CAPACITOR	CMA680J500
	C625	ELECTROLYTIC CAPACIT	CEHAQ3R3M2A
	C628	CERAMIC CAPACITOR	CKCYX104M25
RESISTORS			
	R601	CARBON FILM RESISTOR	RDR1/2PM102J
	R602	CARBON FILM RESISTOR	RDR1/2PM224J
	R604	CARBON FILM RESISTOR	RD1/4PM122J
	R605	CARBON FILM RESISTOR	RD1/4PM104J
	R606	CARBON FILM RESISTOR	RD1/4PM820J
	R607	CARBON FILM RESISTOR	RD1/4PM122J
	R608	CARBON FILM RESISTOR	RD1/4PM684J
	R609	CARBON FILM RESISTOR	RDR1/2PM681J
	R610	CARBON FILM RESISTOR	RDR1/2PM223J
	R615	CARBON FILM RESISTOR	RDR1/4PM224J
	R616	CARBON FILM RESISTOR	RD1/4PM561J
	R619	CARBONFILM RESISTOR	RD1/2PM223J
	R621	CARBONFILM RESISTOR	RD1/2PM223J
	R622	CARBON FILM RESISTOR	RD1/4PM470J
	R624	CARBON FILM RESISTOR	RD1/4PM512J
	R626	CARBON FILM RESISTOR	RD1/4PM332J
	R627	CARBON FILM RESISTOR	RD1/4PM222J
	R628	CARBON FILM RESISTOR	RD1/4PM512J
	R631	CARBON FILM RESISTOR	RD1/4PM122J
	R634	CARBONFILM RESISTOR	RD1/8PM102J
	R637	CARBON FILM RESISTOR	RD1/4PM473J
	R647	RESISTOR (0.33, 5W)	ACN1075
	R648	CARBON FILM RESISTOR	RD1/4PMF392J
	R649	CARBONFILM RESISTOR	RD1/8PM153J
	R650	CARBONFILM RESISTOR	RD1/4PM103J
	R651	CARBON FILM RESISTOR	RD1/4PM562J

Mark	No.	Description	Parts No.
	TH601	PTC THERMISTOR	AEX-002
	VR601	VR	ACP1043
	VR602	VR	ACP1045
		Other resistors	RFA1/4PS□□□J
REINFORCE R ASSEMBLY			
CAPACITORS			
	C726,727	MICA CAPACITOR	CMA221J500
RESISTORS			
	R745,746	FUSIBLE RESISTOR	RFA1/4PS4R7J
	R747	RESISTOR (0.33, 5W)	ACN1075
	R748	CARBON FILM RESISTOR	RD1/4PMF392J
BIAS 3 ASSEMBLY			
SEMICONDUCTOR			
	Q616	TRANSISTOR	2SC3298
VOL - F ASSEMBLY			
RESISTORS			
	R213,214	CARBON FILM RESISTOR	RDR1/4PM272J
	VR201	VR	ACW1006
REG ASSEMBLY			
SEMICONDUCTORS			
	IC101	REGULATOR IC	M5F78M12L
	IC102	REGULATOR IC	M5F79M12L
RESISTORS			
	R116	CARBON FILM RESISTOR	RD1/2PM821J
HEAD PHONE ASSEMBLY			
CAPACITORS			
	C301,302	CERAMIC CAPACITOR	CKCYB392K500
OTHERS			
		JACK	AKN1002

Mark No.	Description	Parts No.
INPUT ASSEMBLY (AWZ3065)		
SEMICONDUCTORS		
IC201	OP AMP	M5238PF
Q201,202	TRANSISTOR	2SC2878
Q203	TRANSISTOR	2SC1740S
D201,202	DIODE	1SS252
D203	ZENER DIODE	RD4.3ESB
RELAYS		
RY201,202	RELAY	ASR1018
CAPACITORS		
C209,210	ELECTROLYTIC CAPACIT	CEYA100M50
RESISTORS		
R201-204	CARBON FILM RESISTOR	RDR1/4PM221J
R207-210	CARBON FILM RESISTOR	RDR1/4PM224J
R217,218	CARBON FILM RESISTOR	RDR1/4PM221J
R219,220	CARBON FILM RESISTOR	RDR1/4PM222J
R221,222	CARBON FILM RESISTOR	RDR1/4PM224J
R223,224	CARBON FILM RESISTOR	RDR1/4PM104J
R225,226	CARBON FILM RESISTOR	RDR1/4PM224J
	Other resistors	RD1/8PM□□□J
PS ASSEMBLY (AWZ3066)		
SEMICONDUCTORS		
Q101	TRANSISTOR	2SB834
Q102	TRANSISTOR	RN1203
Q103	TRANSISTOR	2SB834
Q104	TRANSISTOR	2SC2458
Q105	TRANSISTOR	2SA1048
Q106,107	TRANSISTOR	2SC2458
Q108	TRANSISTOR	2SB560
Q151	TRANSISTOR	2SA1048
Q152	TRANSISTOR	2SC2458
Q153	TRANSISTOR	2SA1048
D101-104	DIODE	S5566
D105	DIODE	1SS252
D106-113	DIODE	30DF2FC-2
D114,115	DIODE	1SS252
D116	ZENER DIODE	RD4.7ESB2
D117	ZENER DIODE	RD12ESB2
D118-121	DIODE	1SS252
D151,152	DIODE	1SS252

Mark No.	Description	Parts No.
RELAY		
RY101	RELAY	ASR1001
COIL		
L101	LINE FILTER	ATF1006
CAPACITORS		
C101,102	ELECTR.CAPACITOR	CEAS102M25
C103	ELECTR.CAPACITOR	CEAS4R7M50
C104,105	ELECTR.CAPACITOR	CEAS470M16
C106	ELECTR.CAPACITOR	CEAS101M25
C107	ELECTROLYTIC CAPACIT	CEAS471M6
C108	ELECTR.CAPACITOR	CEAS101M16
C109	ELECTROLYTIC CAPACIT	CEANP330M25
C110	ELECTR.CAPACITOR	CEAS3R3M50
C111	CKA (0.01/AC400V)	ACG1002
C112	CKA (0.01/AC400V)	
C113	MYLOR FILM CAPACITOR	CQMA104K250
C151	ELECTR.CAPACITOR	CEAS100M50
RESISTORS		
R108	CARBON FILM RESISTOR	RD1/4PMF221J
R113-115	CARBONFILM RESISTOR	RD1/4PM103J
R117	CARBON FILM RESISTOR	RD1/4PM123J
	Other resistors	RD1/8PM□□□J
OTHERS		
CN1	CONNECTOR(13P)	KPE13
CN2	JUMPER CONNECTOR	KPC6
CN3,5,8	CONNECTOR(5P)	KPC5
CN9	JUMPER CONNECTOR	KPC6
SP-LCH ASSEMBLY(AWZ3067)		
RELAYS		
RY801,802	RELAY	ASR1026
COIL		
L801	COIL	ATH1001
CAPACITORS		
C801,803	AUDIO FILM CAPACITOR	CFTXA473J50
C805,806	ELECTR.CAPACITOR	CEASR47M50
C814,815	CERAMIC CAPACITOR	CKDYB103K500
C816,817	CERAMIC CAPACITOR	CKDYB472K500

Mark No.	Description	Parts No.	Mark No.	Description	Parts No.
RESISTORS			SWITSHES		
R801	METAL OXIDE RESISTOR	RS1PMF100J	S301	PUSH SWITCH	SEC8V222L
R803	METAL OXIDE RESISTOR	RS2LMF100J	S302	PUSH SWITCH	SEC8V22S
R805,806	METAL OXIDE RESISTOR	RS2LMF331J	RELAY		
R807,808	CARBON FILM RESISTOR	RD1/4PM100J	RY301	RELAY	ASR1003
OTHER			RESISTORS		
	SPEAKER TERMINAL 4-P	AKE1017	R301-305	CARBON FILM RESISTOR	RD1/2PM222J
SP-RCH ASSEMBLY(AWZ3068)			R308,309	CARBON FILM RESISTOR	RD1/2PM362J
RELAIES			R310	CARBON FILM RESISTOR	RD1/2PM392J
RY851,852	RELAY	ASR1026	R311	CARBON FILM RESISTOR	RD1/4PM102J
COIL			R312	CARBON FILM RESISTOR	RD1/4PM222J
L851	COIL	ATH1001	R314	CARBON FILM RESISTOR	RD1/2PM362J
CAPACITORS			SW ASSEMBLY		
C851,853	AUDIO FILM CAPACITOR	CFTXA473J50	SWITCH		
C855,856	ELECTR.CAPACITOR	CEASR47M50	S303	SWITCH	ASD1007
C864,865	CERAMIC CAPACITOR	CKDYB103K500	PIN JACK ASSEMBLY		
C866,867	CERAMIC CAPACITOR	CKDYB472K500	CAPACITORS		
RESISTORS			C201-208	CERAMIC CAPACITOR	CKDYB391K50
R851	METAL OXIDE RESISTOR	RS1PMF100J	C211	AUDIO FILM CAPACITOR	CFTXA473J50
R853	METAL OXIDE RESISTOR	RS2LMF100J	OTHERS		
R855,856	METAL OXIDE RESISTOR	RS2LMF331J	PHONO JACK 2-P		
R857,858	CARBON FILM RESISTOR	RD1/4PM100J	PHONO JACK 6-P		
OTHER			AKB1151		
	SPEAKER TERMINAL 4-P	AKE1017	AKB1154		
FRONT ASSEMBLY (AWZ3069)					
SEMICONDUCTORS					
Q301-303	TRANSISTOR	RN1203			
D301-305	LED(RED)	AEL1065			
D308	LED(RED,AMBER)	AEL1116			
D313,314	DIODE	S5566			
D317,318	DIODE	1SS252			
D319	ZENER DIODE	RD15ESB			
D320,323	DIODE	1SS252			
D331,332	DIODE	1SS252			

4. ADJUSTMENTS

1. Set to the class B mode
2. Wait ten minutes after the power has been turned on.
3. Adjust VR402 so that the voltage difference between BIAS TP and the output JP wire on the Power L assembly becomes 8.8mV ($+11\text{mV}/-3.3\text{mV}$). Also adjust VR602 on the Power R assembly using the same procedure.
4. Set to the class A mode.
5. Wait ten minutes.
6. Adjust VR401 so that the voltage difference between BIAS TP and the output JP wire on the Power L assembly becomes $137\text{mV} \pm 14\text{mV}$. Also adjust VR601 on the Power R assembly using the same procedure.
7. Check that the voltage difference between BIAS TP and the output JP wire on the Power L assembly is the same as that between BIAS TP on the reinforced L assembly and the output JP wire on the Power L assembly.
8. Check that the voltage difference between BIAS TP and the output JP wire on the Power R assembly is the same as that between BIAS TP on the reinforce R assembly and the output JP wire on the Power L assembly.

Note :

Steps 1 to 3 should be conducted before steps 4 to 7 and not after it.

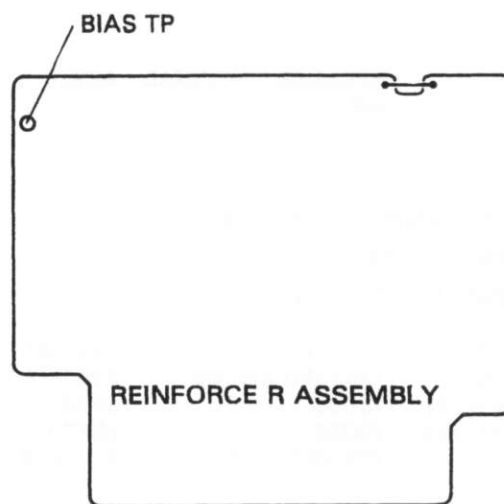
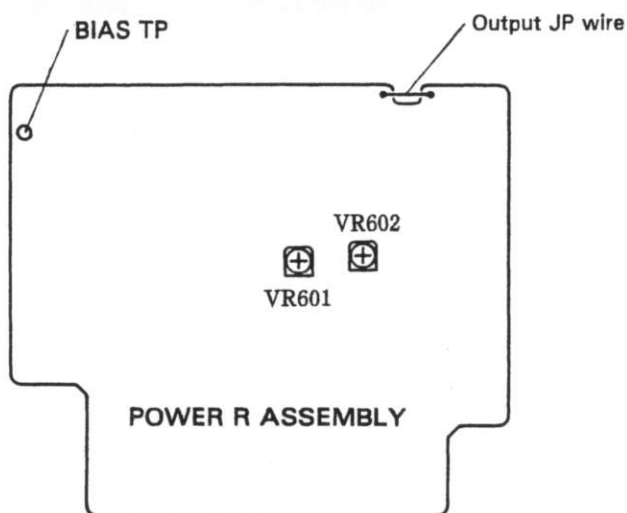
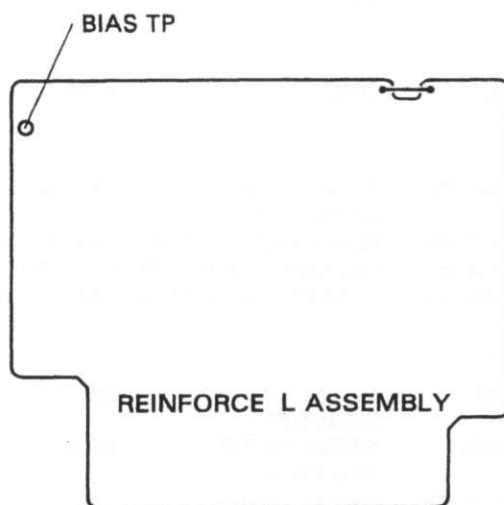
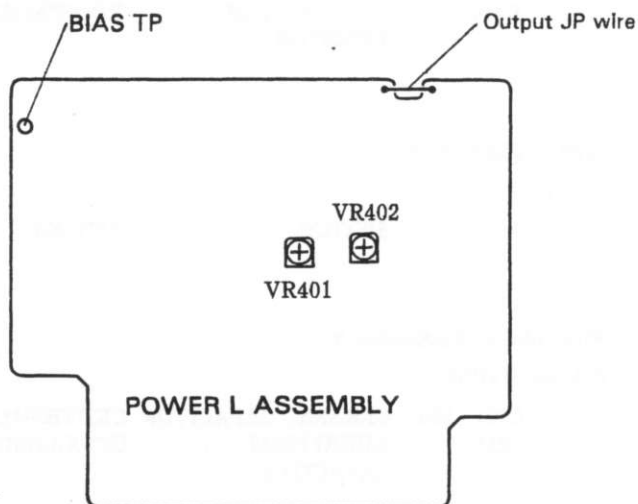

Fig. 4-1 adjustment point

4. RÉGLAGE

1. Mettre sur le mode de classe B.
2. Attendre dix minutes après la mise sous tension.
3. Régler VR402 de manière que la différence de tension entre le point d'essai de polarisation et le cavalier de sortie de l'ensemble gauche d'alimentation devienne égale à $8,8\text{mV}(+11\text{mV}/-3,3\text{mV})$. Régler également VR602 sur l'ensemble droit d'alimentation en procédant de la même manière.
4. Mettre sur le mode de classe A.
5. Attendre dix minutes.
6. Régler VR401 de manière que la différence de tension entre le point d'essai de polarisation et le cavalier de sortie de l'ensemble gauche d'alimentation devienne égale à $137\text{mV} \pm 14\text{mV}$. Régler également VR601 sur l'ensemble droit d'alimentation en procédant de la même manière.

7. Contrôler que la différence de tension entre le point d'essai de polarisation et le cavalier de sortie de l'ensemble gauche d'alimentation est égale à la différence de tension entre le point d'essai de polarisation de l'ensemble gauche de renfort et le cavalier de sortie de l'ensemble gauche d'alimentation.
8. Contrôler que la différence de tension entre le point d'essai de polarisation et le cavalier de sortie de l'ensemble droit d'alimentation est égale à la différence de tension entre le point d'essai de polarisation de l'ensemble droit de renfort et le cavalier de sortie de l'ensemble droit d'alimentation.

Remarque :

Les étapes 1 à 3 devront être effectuées avant les étapes 4 à 7, et non pas après.

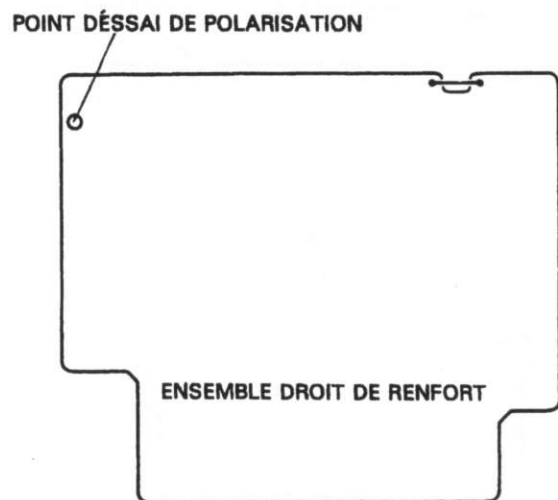
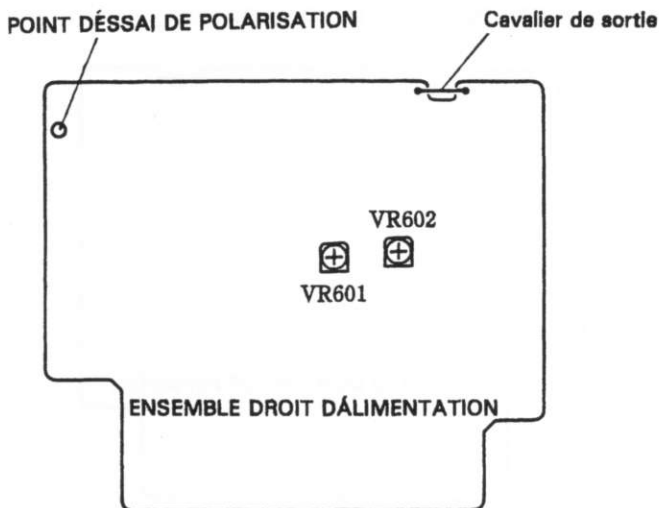
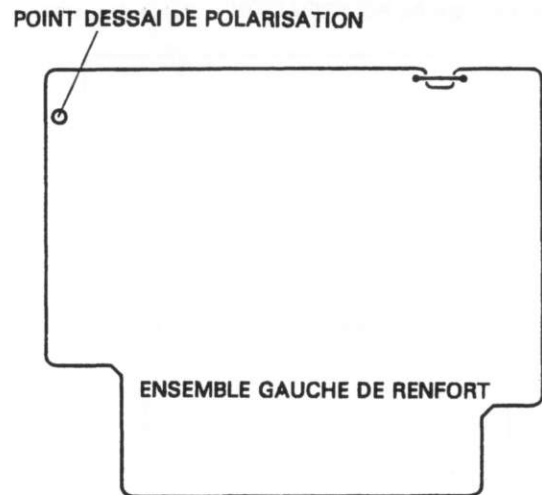
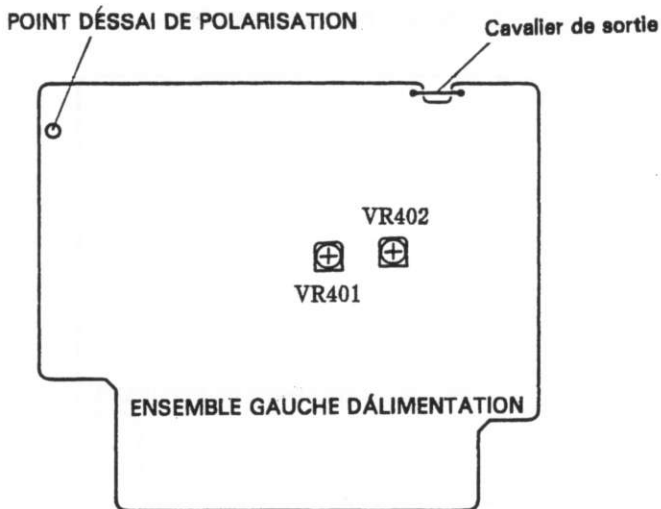

Fig. 4-1 Points de réglage

4. AJUSTE

1. Ajuste al modo de clase B.
2. Espere cinco minutos después de activar la alimentación.
3. Ajuste VR402 de modo que la diferencia de tensión entre el punto de prueba de polarización, y el cable de puentado de salida en el conjunto derecho de alimentación se convierta en 8.8mV (11mV/−3.3mV). También ajuste VR602 en el conjunto derecho de alimentación usando el mismo procedimiento.
4. Ajuste al modo de clase A.
5. Espere cinco minutos.
6. Ajuste VR401 de modo que la diferencia de tensión entre el punto de prueba de polarización Y el cable de puentado de salida en el conjunto izquierdo sea de 137mV ± 14mV. También ajuste VR601 en el conjunto derecho de alimentación usando el mismo procedimiento.

7. Compruebe que la diferencia de tensión entre el punto de prueba de polarización Y el cable de puentado de salida en el conjunto izquierdo de alimentación, sea similar como la que existe entre el punto de prueba de polarización en el conjunto derecho de refuerzo, Y el cable de puentado de salida en el conjunto izquierdo de alimentación.
8. Compruebe que la diferencia de tensión entre el punto de prueba Y el cable de puentado de salida en el conjunto derecho de alimentación, sea similar como la que existe entre el punto de prueba en el conjunto derecho de refuerzo, Y el cable de puentado de salida en el conjunto izquierdo de alimentación.

Nota :

Los pasos 1 a 3 deben realizarse antes de los pasos 4 a 7 y no después de los mismos.



Fig. 4-1 Puntos de ajuste

5. FOR HB TYPE

NOTES:

- Parts without part number cannot be supplied.
- The \triangle mark found on some component parts indicates the importance of the safety factor of the part. Therefore, when replacing, be sure to use parts of identical designation.
- Parts marked by "●" are not always kept in stock. Their delivery time may be longer than usual or they may be unavailable.

CONTRAST OF MISCELLANEOUS PARTS

The M-73/HB type is the same as the M-73/HEZ type with the exception of the following sections.

Mark	Symbol & Description	Part No.		Remarks
		M-73/HEZ type	M-73/HB type	
\triangle	FU1,FU2 (T800mA/250V)	AEK-031	AEK-507	
\triangle	FU3,FU4 (T5A/250V)	AEK-015	AEK-515	
\triangle	FU5,FU6 (T3.15A/250V)	AEK-042	AEK-513	
\triangle	AC Power cord	ADG1036	ADG1041	
	Screw (EARTH)	ABA1047	
	Operating instructions (English/German/French/Italian/ Spanish/Dutch/Portuguese/ Swedish)	ARE1166	
	Operating instructions (English)	ARB1267	

6. PANEL FACILITIES

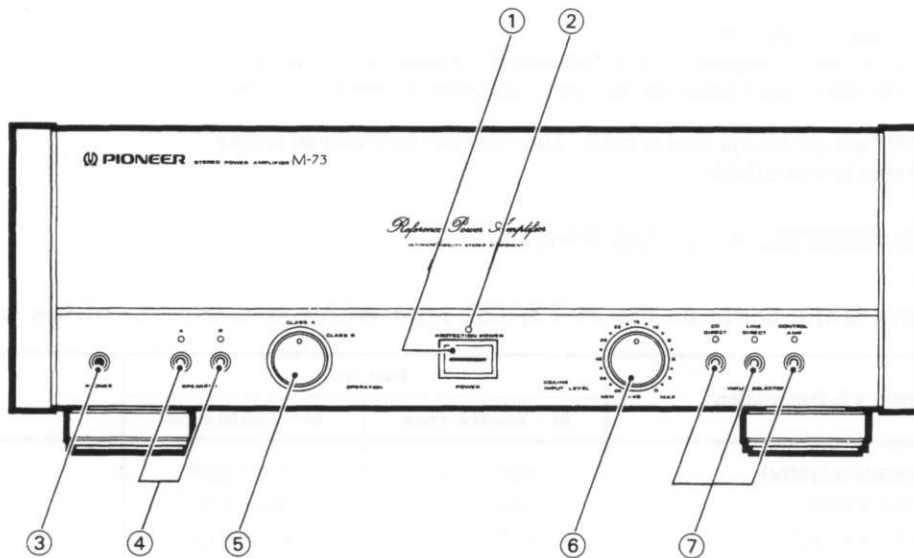

① POWER switch

Press to turn power to this unit ON/OFF.

② PROTECTION/POWER indicator

Lights when the power is turned ON.

Red (protection): Lights immediately after turning on the power, or in the event of a malfunctioning input from the control amplifier. When illuminated, the amplifier will not operate.

Yellow (power): Indicates normal operating condition.

③ PHONES jack

When using headphones, connect their plug here.

④ SPEAKERS switch

Use to select the speaker system used.

[A] - Sound is heard from the speaker systems connected to the SPEAKERS A terminals.

[B] - Sound is heard from the speaker systems connected to the SPEAKERS B terminals.

Turn this switch OFF when using headphones.

⑤ OPERATION Selector (CLASS A/CLASS B)

This selector lets you to switch between Class A and Class B amplifier circuits.

Class A delivers high sound quality, while switching to Class B provides higher power output.

NOTE:

If you switch between Class A and Class B during play, the sound will be muted for a short time and the PROTECTION/POWER indicator will become red. Wait a few seconds until it changes to yellow.

⑥ CD/LINE INPUT LEVEL Control

Use this to regulate input levels from the CD DIRECT INPUT and LINE DIRECT INPUT terminals on the rear panel.

⑦ INPUT SELECTOR Buttons and Indicators

Use these to choose your listening source component. Each button has an indicator above it which lights when the button is pressed.

[CD DIRECT] - This button selects the compact disc player connected to the CD DIRECT INPUT terminals on the rear panel.

[LINE DIRECT] - This button selects the audio component connected to the LINE DIRECT INPUT terminals on the rear panel.

[CONTROL AMP] - This button selects a component connected to the control amplifier.

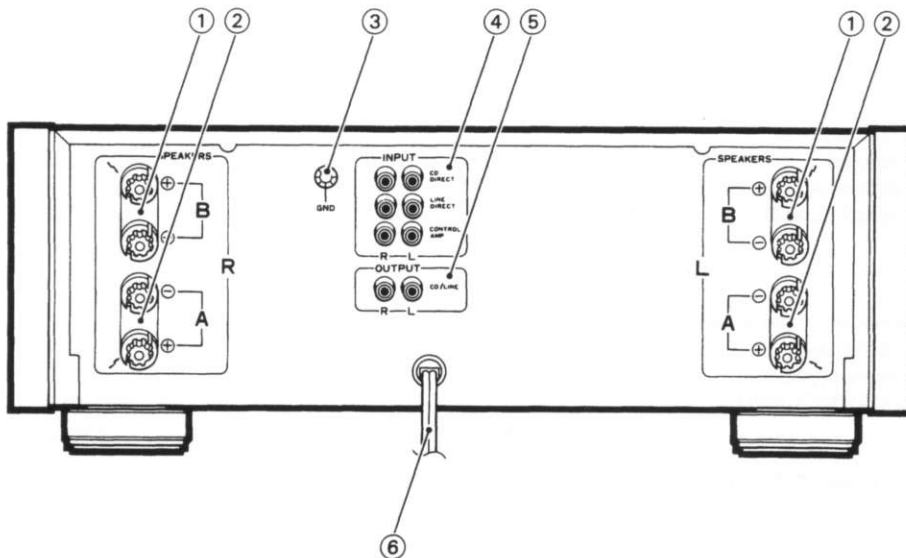

① SPEAKERS B terminals

Connect R to the right-side speakers of speaker system B (second speaker system), and connect L to the left-side speakers.

② SPEAKERS A terminals

Connect R to the right-side speakers of speaker system A (first speaker system), and connect L to the left-side speakers.

When using two sets of speakers (A and B), be sure that your speakers have a nominal impedance rating of $8\ \Omega - 16\ \Omega$.
When using only one set of speakers, (A or B) use speakers with a nominal impedance rating of $4\ \Omega - 16\ \Omega$.

③ Ground terminal (GND)

④ INPUT Terminals

[CD DIRECT] - For playback of a compact disc player

[LINE DIRECT] - For listening directly to the output of an audio component.

[CONTROL AMP] - For use with the control amplifier.

NOTE:

The LINE DIRECT and CONTROL AMP terminals are provided with shorting pin plugs (two each). Before connecting equipment to these terminals, therefore, remove the shorting pin plugs and insert them into unused terminals.

⑤ CD/LINE OUTPUT terminals

The playback signals from the compact disc player or other audio component connected to the rear panel CD DIRECT INPUT or LINE DIRECT INPUT terminals currently in use are output here.

Connect to the control amplifier CD INPUT terminals. (This allows recording of the CD playback on a tape deck connected to the control amplifier.)

⑥ Power cord

POWER-CORD CAUTION

Handle the power cord by the plug. Do not pull out the plug by tugging the cord and never touch the power cord when your hands are wet as this could cause a short circuit or electric shock. Do not place the unit, a piece of furniture, etc., on the power cord, or pinch the cord. Never make a knot in the cord or tie it with other cords. The power cords should be routed such that they are not likely to be stepped on. A damaged power cord can cause fire or give you an electrical shock. Check the power cord once in a while. When you find it damaged, ask your nearest PIONEER authorized service center or your dealer for a replacement.

7. SPECIFICATIONS

Amplifier Section

Continuous power output (both channel driven, measured by Audio Spectrum Analyzer)

20 Hz to 20 kHz,

THD 0.009 % 8 Ω Class B/Class A..... 110 W x 2/20 W x 2

DIN power (both channels driven)

1 kHz, 0.7%, 8 Ω Class B/Class A..... 125 W x 2/25 W x 2

Dynamic power (EIA test signal) Class B

8 Ω 170 W

4 Ω 300 W

2 Ω 325 W

Harmonic distortion (Measured by Audio Spectrum Analyzer)

20 Hz — 20 kHz, 50 W, 8 Ω Class B 0.005%

Input terminals (sensitivity/input impedance)

CONTROL AMP INPUT, CD DIRECT INPUT,

LINE DIRECT INPUT 1 V/40 k Ω

Frequency response

CONTROL AMP INPUT, CD DIRECT INPUT,

LINE DIRECT INPUT, 5 Hz — 150 kHz..... $\pm \frac{9}{3}$ dB

SN ratio (short circuit, A network)

CONTROL AMP INPUT, CD DIRECT INPUT,

LINE DIRECT INPUT 120 dB

Power section, etc.

Power requirements a.c. 220 V ~, 50/60 Hz

Power consumption 1,000 W

External dimensions 459 (W) x 424 (D) x 163 (H) mm

Weight 20.9 kg

Accessories

Operating Instructions 1

Pin-plug cord 1

Spacer set..... 1

NOTE:

- Specifications and design subject to possible modification without notice, due to improvements.