

# Service Manual

**CIRCUIT DESCRIPTIONS  
REPAIR & ADJUSTMENTS**



**ORDER NO.  
ARP1185-A**

**STEREO POWER AMPLIFIER**

# M-90(BK)

**MODEL M-90 (BK) COMES IN FIVE VERSIONS DISTINGUISHED AS FOLLOWS:**

Type	Power requirement	Export destination
KU	AC120V only	U.S.A.
HE	AC220V, 240V (switchable) *	European continent
HEZ	AC220V, 240V (switchable) *	West Germany
HB	AC220V, 240V (switchable) *	United Kingdom
S/G	AC110V, 120V, 220V, 240V (switchable)	U.S. Military

\*Change the primary wiring of the power transformer.

- This service manual is applicable to the HEZ type.
- As to the HE, HB, KU and S/G types, please refer to the additional service manual (ARP1206).

## CONTENTS

1. SPECIFICATIONS .....	2	8. BLOCK DIAGRAM .....	25
2. PANEL FACILITIES .....	3	9. CIRCUIT DESCRIPTION .....	27
3. PARTS LOCATIONS .....	4	10. IC DESCRIPTIONS .....	28
4. EXPLODED VIEWS AND PARTS LIST .....	6	11. PACKING .....	29
5. P.C. BOARDS CONNECTION DIAGRAM .....	11	12. SAFETY INFORMATION .....	29
6. SCHEMATIC DIAGRAM .....	15		
7. ELECTRICAL PARTS LIST .....	20		

# 1. SPECIFICATIONS

## Amplifier Section

Continuous average power output is 200 watts\* per channel, min., at 8 ohms from 20 Hertz to 20,000 Hertz with no more than 0.003% total harmonic distortion.

DIN power (both channels driven)	
1 kHz, 0.7%, 8 Ω	250 W + 250 W
Dynamic power (EIA test signal)	
8 Ω	300 W + 300 W
4 Ω	550 W + 550 W
2 Ω	800 W + 800 W
Harmonic distortion	
20 Hz — 20 kHz, 200 W, 8 Ω	0.003%
Cross modulation distortion (50 Hz: 7 kHz = 4:1)	
During effective output	0.002%
Input terminals (sensitivity/input impedance)	
CONTROL AMP IN, CD DIRECT IN, LINE DIRECT IN	1 V/50 kΩ
Frequency response	
CONTROL AMP IN, CD DIRECT IN, LINE DIRECT IN, 20 Hz — 20 kHz	+0 dB/ -0.1 dB
SN ratio (short circuit, A network)	
CONTROL AMP IN, CD DIRECT IN, LINE DIRECT IN	125 dB

## Power section, etc.

Power requirements	
European model	AC 220 V~, 50/60 Hz
U.K., Australian models	AC 240 V~, 50/60 Hz
U.S., Canadian models	AC 120 V, 60 Hz
Other destination models	~AC 110 V/120 V/ 220 V/240 V (switchable), 50/60 Hz
Power consumption	
European, U.K., Australian models	1,300 W
U.S., Model	430 W
Other destination models	430 W
External dimensions	
	457 (W) x 430 (D) x 154 (H) mm. 18 (W) x 16-7/8 (D) x 6-1/16 (H) in
Weight	22.6 kg (49 lb 13 oz)

## Accessories

Operating Instructions	1
Pin-plug cord	1

### NOTE:

- Specifications and design subject to possible modification without notice due to improvements.
- \*Measured pursuant to the Federal Trade Commission's Trade Regulation rule on Power Claims for Amplifier.

## Precautions for installation

To ensure optimum sound quality, observe the following precautions.

- This unit is heavy. Be sure to install it on a firm base which can support its weight. Also, to prevent the flow of cooling air from being blocked off, do not place the unit on soft material such as a carpet or cushion, or install it in a confined space. When installing the unit in a rack, provide adequate space around it to allow heat to dissipate.
- To prevent the control amplifier from picking up noise due to leakage flux from the power amplifier when the control amplifier and power amplifier are installed adjacent to each other, install the control amplifier on the right of the power amplifier. Also, if you install the control amplifier above or below the power amplifier, place a partition between them to separate them by at least 10 cm from each other.
- Install the unit on a level surface so that the feet of the unit are all touching the installation surface.

## 2. PANEL FACILITIES

### FRONT PANEL

#### INPUT SELECTOR

Use to select the component you wish to play back (amplify).

[CONTROL AMP]—The component connected to the control amplifier.

[CD DIRECT]— The compact disc player connected to the rear panel CD DIRECT IN terminals.

[LINE DIRECT]—The audio component connected to the rear panel LINE DIRECT IN terminals.

#### POWER switch

Press to turn power to this unit ON/OFF.

#### PROTECTION/POWER indicator

Lights when the power is turned ON.

Red (protection): Lights immediately after turning on the power, or in the event of a malfunctioning input from the control amplifier. When lighted, the amplifier will not operate.

Yellow (power): Indicates normal operating condition.

#### Power level meters

When the display selector switch is in the ON position, these meters display the power level. The meters feature a "peak hold" function which allows the meters to remain lighted for 0.2 to 0.3 seconds after reaching a peak value.

#### INPUT indicator

Indicates the position of the input selector control.

#### PHONES jack

When using headphones, connect their plug here.

#### SPEAKERS selector switch

Use to select the speaker system used.

[A]— Sound is heard from the speaker systems connected to the SPEAKERS A terminals.

[B]— Sound is heard from the speaker systems connected to the SPEAKERS B terminals.

Turn this switch OFF when using headphones.

#### DISPLAY selector switch

Use to turn the power level meters ON/OFF.

In the OFF condition, the meters will not be displayed.

#### CD/LINE INPUT LEVEL control

Use to adjust the input level connected to the rear panel CD DIRECT IN and LINE DIRECT IN terminals.

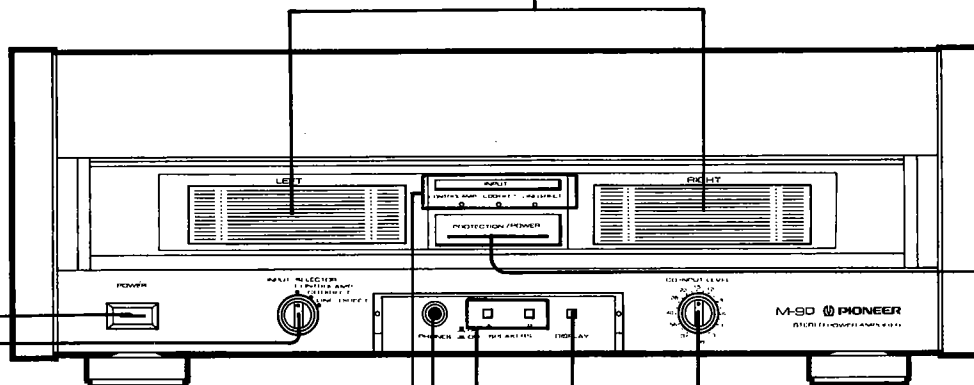

Method of opening cover

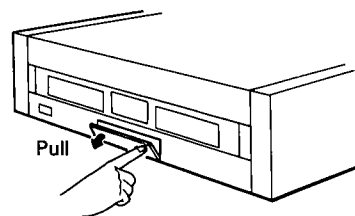

### 3. PARTS LOCATION

**NOTES:**

- Parts without part number cannot be supplied.
- The  $\Delta$  mark found on some component parts indicates the importance of the safety factor of the part. Therefore, when replacing, be sure to use parts of identical designation.
- For your Parts Stock Control, the fast moving items are indicated with the marks **★★** and **★**.  
**★★ GENERALLY MOVES FASTER THAN ★**  
 This classification shall be adjusted by each distributor because it depends on model number, temperature, humidity, etc.
- Parts marked by "  $\odot$  " are not always kept in stock. Their delivery time may be longer than usual or they may be unavailable.

**Front Panel View**

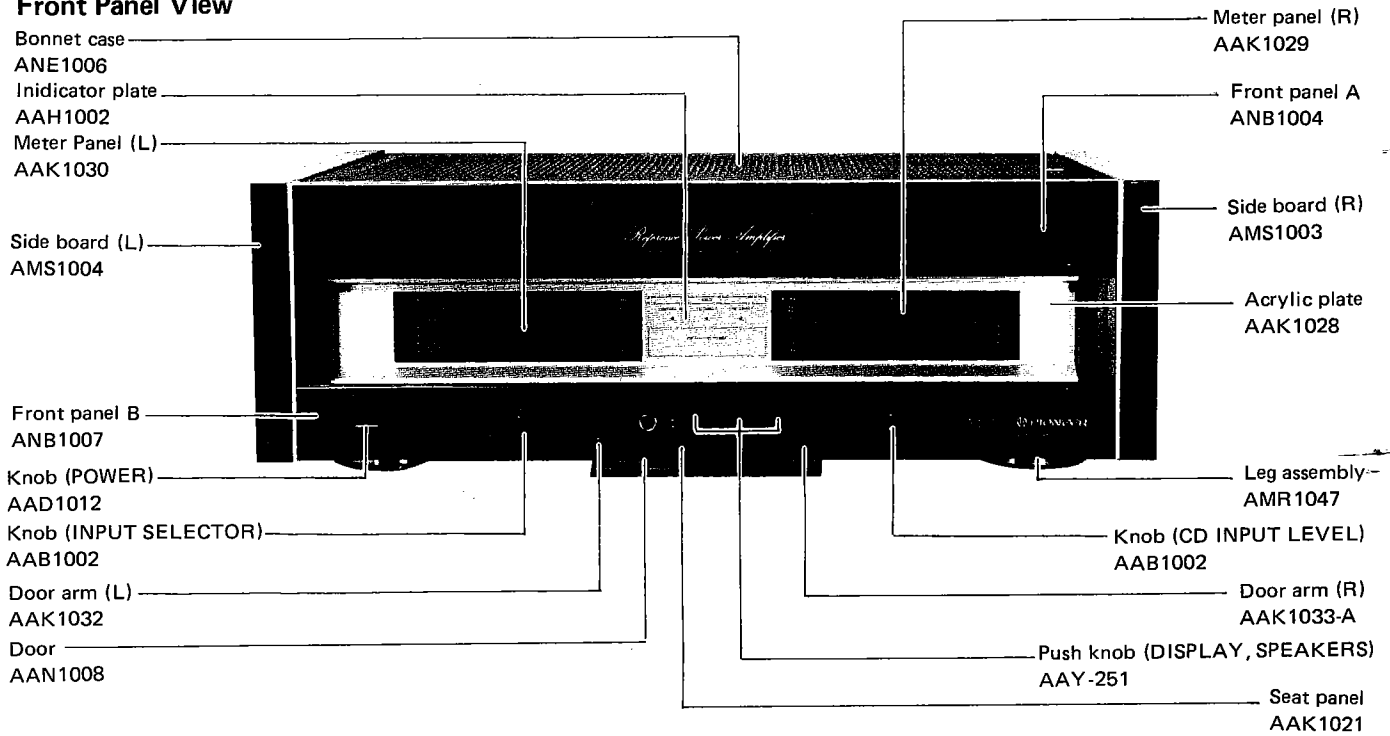

**Side View with Bonnet Case Removed**

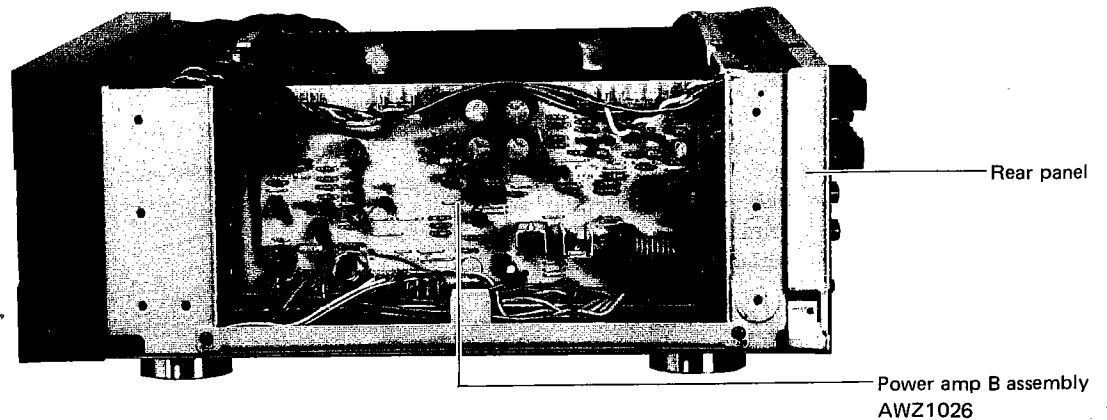

Top View with Bonnet Case Removed

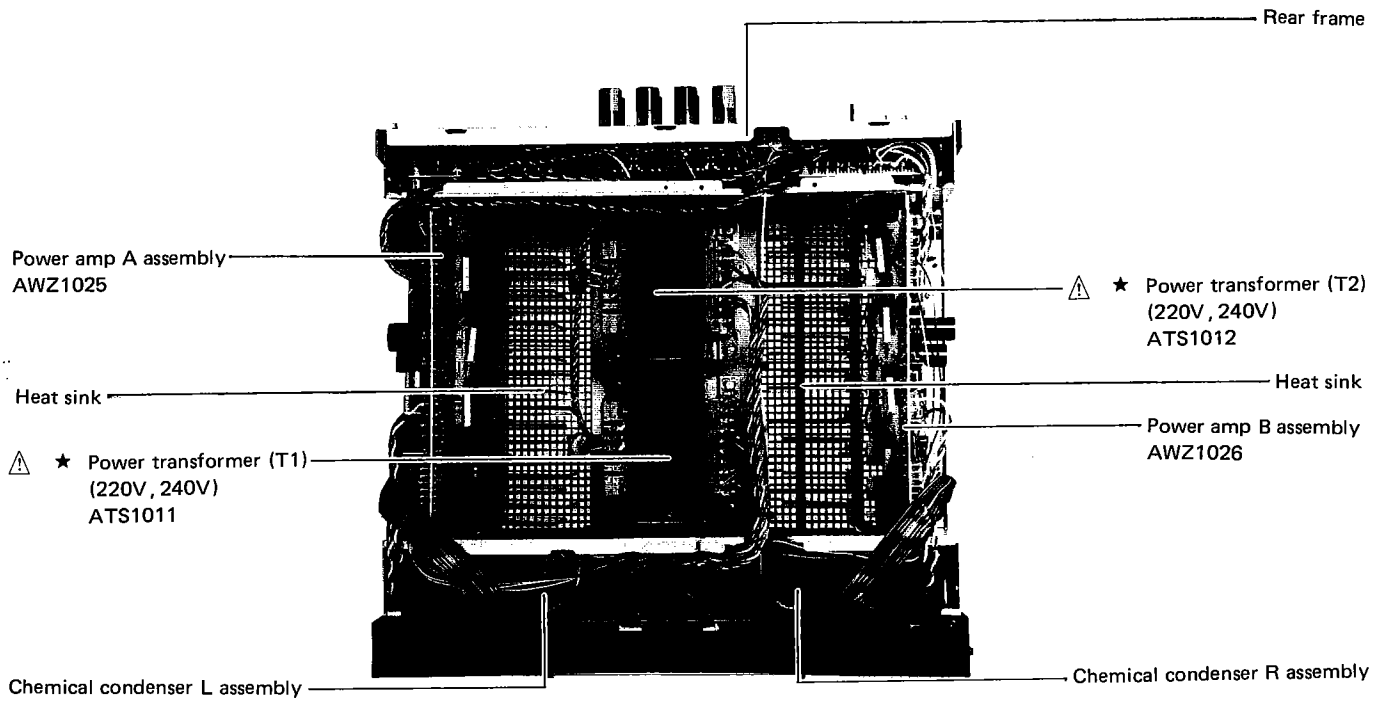

Rear Panel View

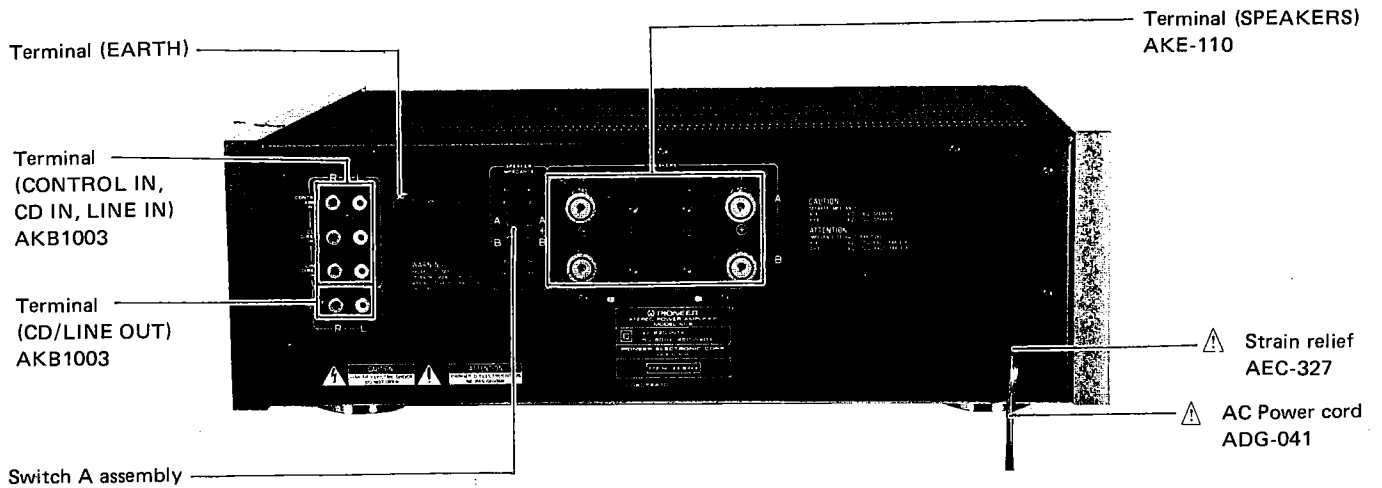

## 4. EXPLODED VIEWS AND PARTS LIST

### NOTES:

- Parts without part number cannot be supplied.
- The  $\Delta$  mark found on some component parts indicates the importance of the safety factor of the part. Therefore, when replacing, be sure to use parts of identical designation.
- For your Parts Stock Control, the fast moving items are indicated with the marks **\*\*** and **\***.  
**\*\* GENERALLY MOVES FASTER THAN \***  
*This classification shall be adjusted by each distributor because it depends on model number, temperature, humidity, etc.*
- Parts marked by "  $\odot$  " are not always kept in stock. Their delivery time may be longer than usual or they may be unavailable.

### Parts List of Exterior

Mark	No.	Part No.	Description
	1	AWZ1037	FL assembly
	2	AMR1047	Leg assembly
	3	AAB1002	Knob (INPUT SELECTOR, CD INPUT LEVEL)
	4	AAD1012	Knob (POWER)
	5	AAH1002	Indicator plate
	6	AAK1021	Seat panel
	7	AAK1028	Acrylic plate
	8	AAK1029	Meter panel (R)
	9	AAK1030	Meter panel (L)
	10	AAK1031	Filter
	11	AAK1032	Door arm (L)
	12	AAK1033	Door arm (R)
	13	AAK1036	Indicator lens A
	14	AAK1075	Lens
	15	AAM1001	Name plate
	16	AAN1008	Door
	17	AAY-251	Knob (DISPLAY, SPEAKERS)
	18	ABH1005	Coil spring
	19	AMB1014	Panel bass
	20	AMS1003	Side board R
	21	AMS1004	Side board L
	22	ANB1004	Front panel A
	23	ANB1007	Front panel B
	24	ANE1006	Bonnet case
	25	FBT40P080FZK	Screw
	26	ABA1002	Decorative screw
	27	ABA1006	Screw
	28	CMZ30P060FZK	Screw
	29	ABA-298	Screw
	30	ABE1002	Washer
	31	ABE1003	Washer
	32	ABA1007	Screw
	33	VMZ30P120FCU	Screw
	34	ABA1011	Screw
	35	VMZ30P060FMC	Screw
	36	VMZ30P080FMC	Screw
	37	AMR1102	Leg assembly
	51		Bottom plate

Exterior

Interior

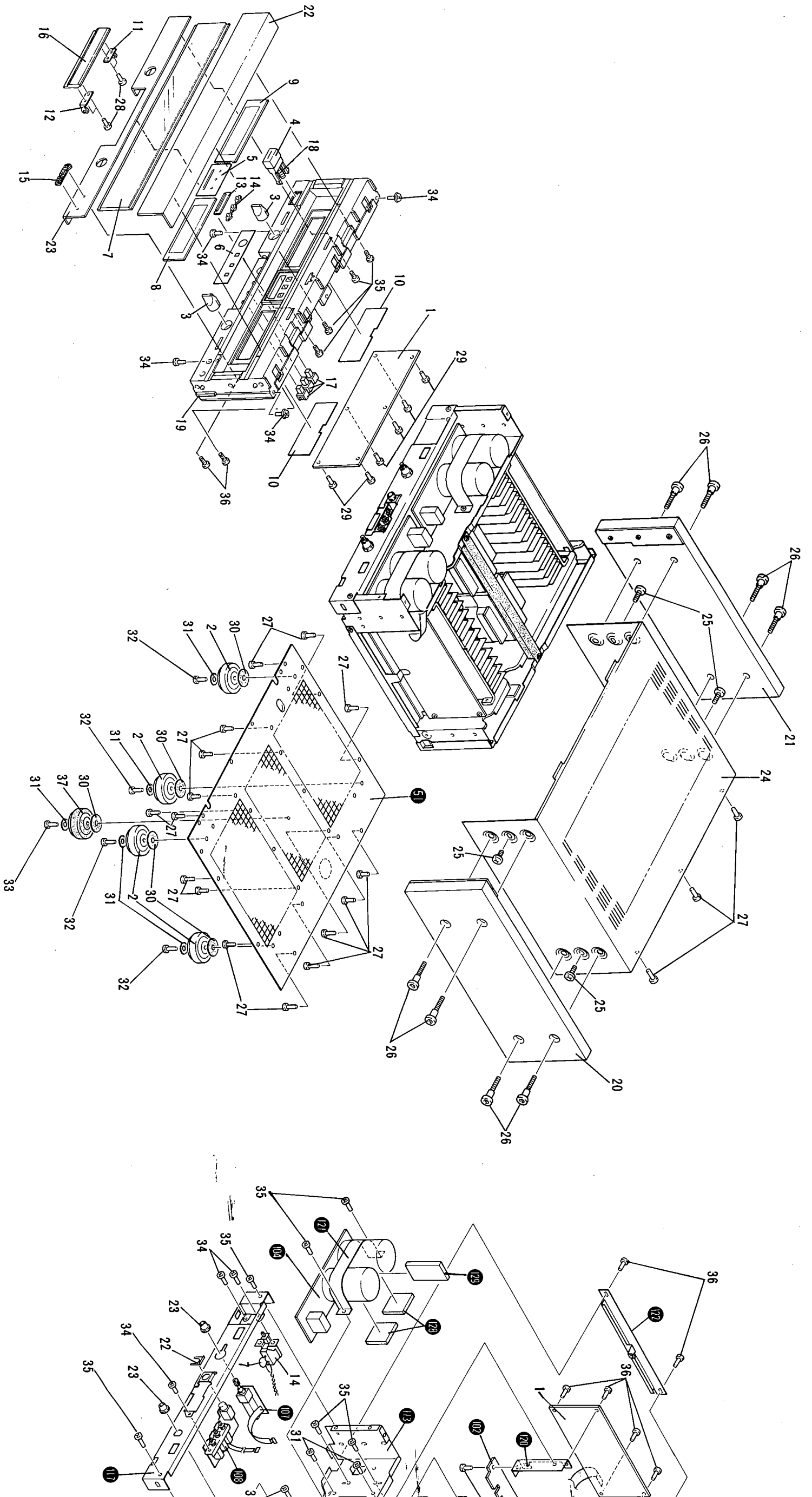

**NOTE:**  
 The sound quality of parts with the  mark denotes that these are fail-safe parts. Be sure that the designated parts are in the positions prescribed.

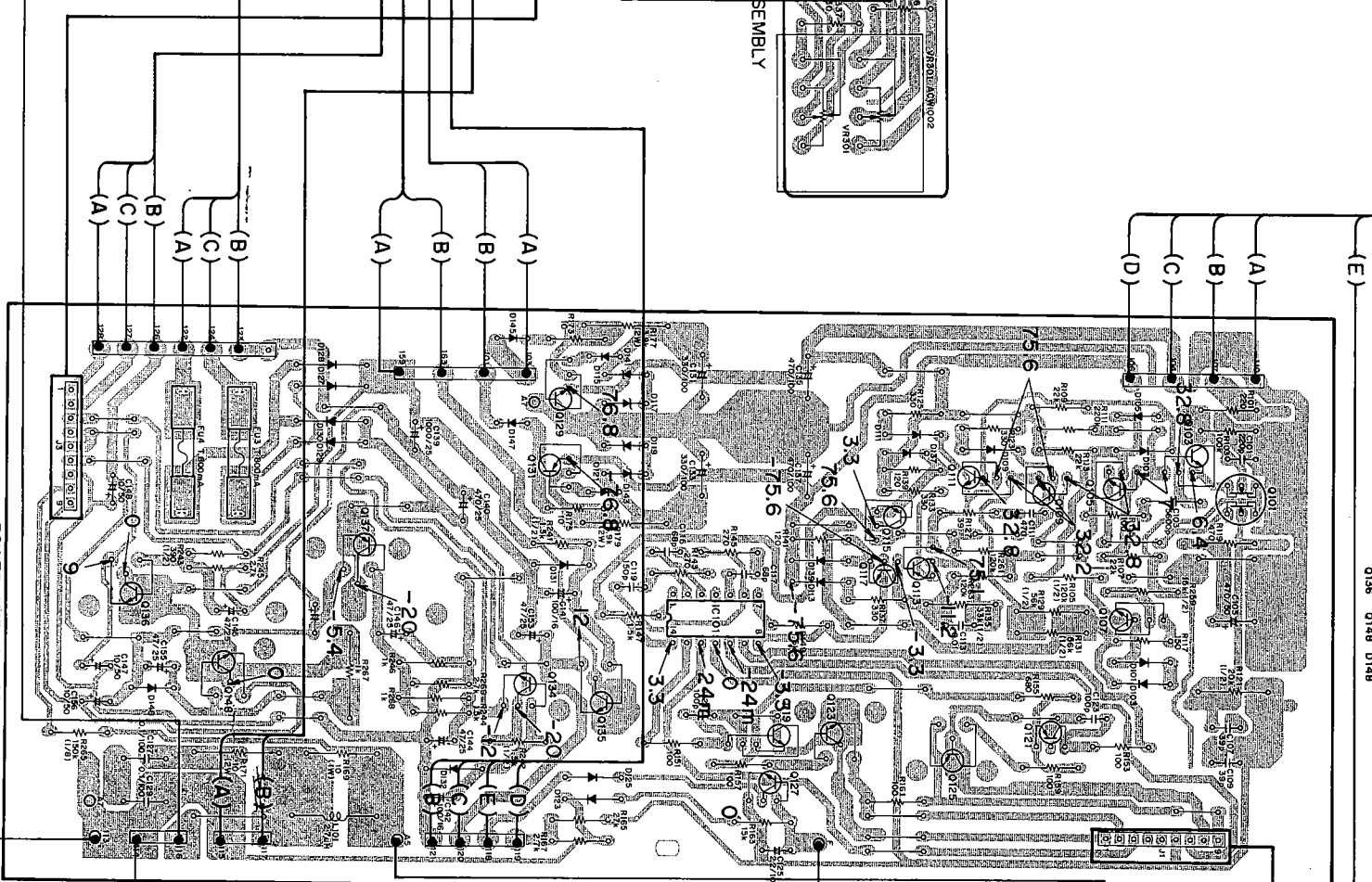
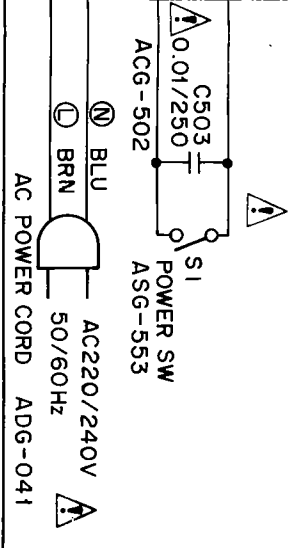
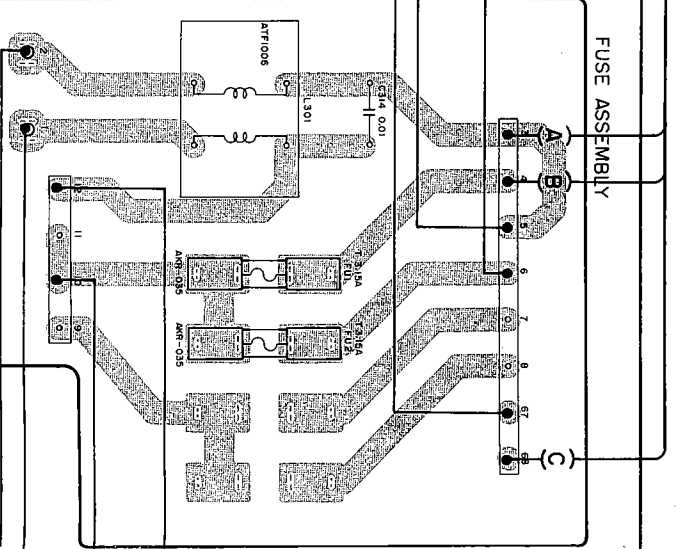
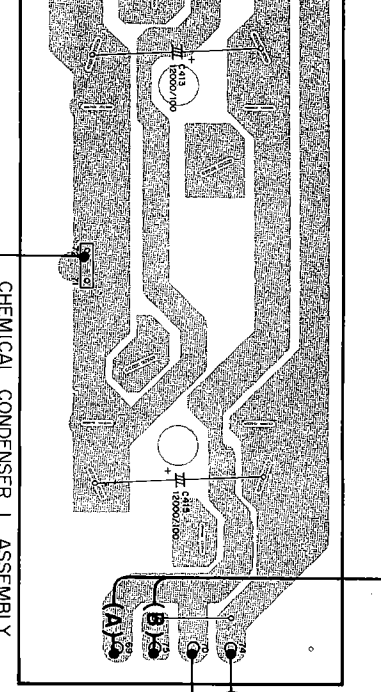
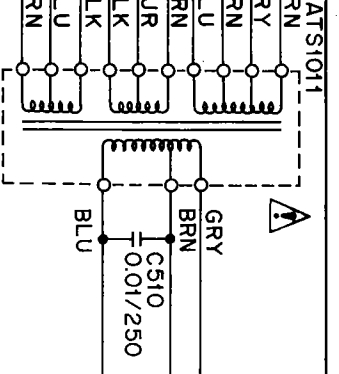
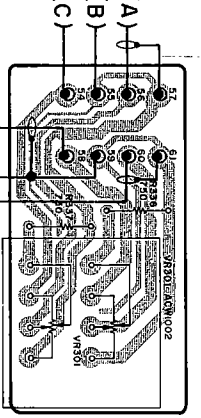
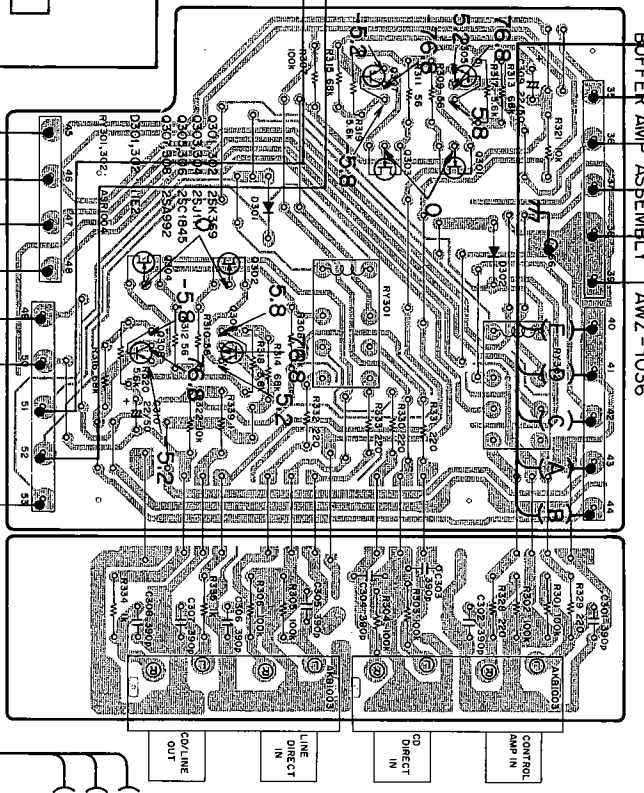
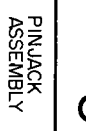
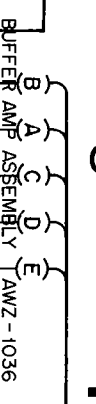
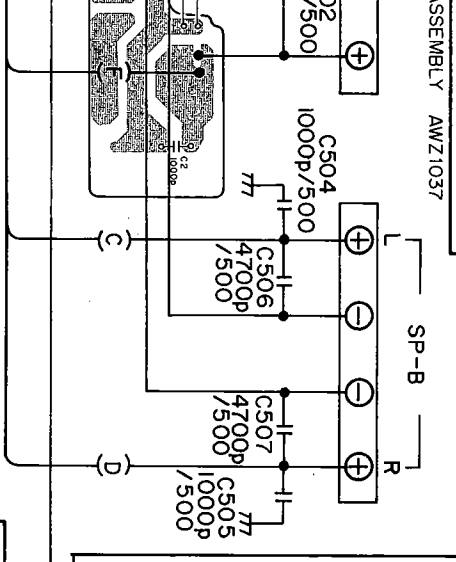
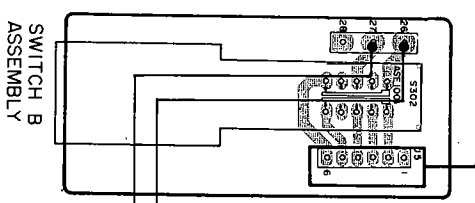
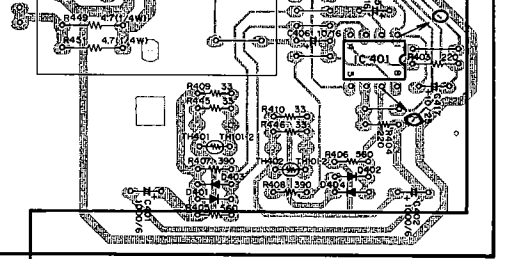

- D105 Q103 D107 Q101 Q105
- D111 D109 D117 Q111 Q109 Q115 Q113 Q117 D139 D113 Q121 Q123 Q125
- D141 D115 Q129 D117 Q119 Q131 D121 D143 D131 IC101 Q135 Q119 Q127 D125 D123
- D145 D128 D147 D127 D130 D129 Q137 Q136 Q148 D148
- Q107 D101 D103
- Q134
- D132

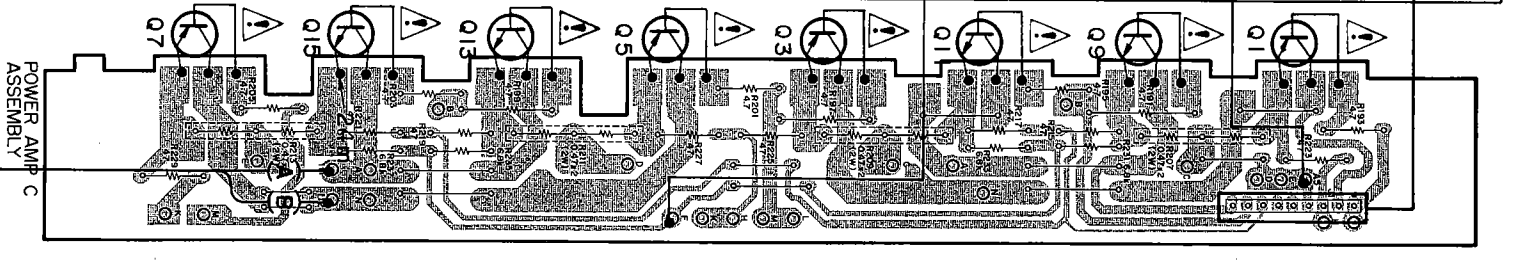



Parts List of Interior

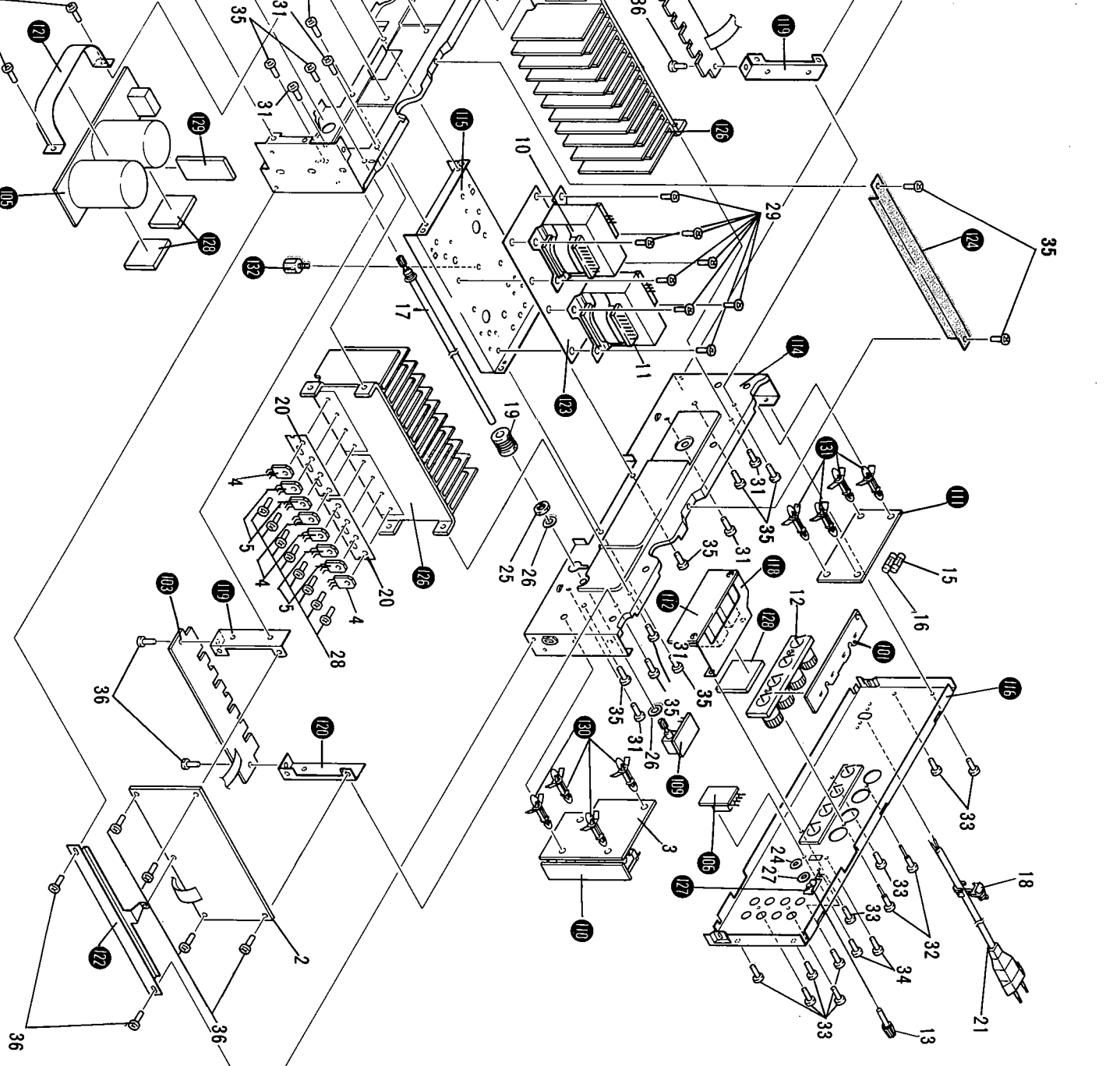

Mark	No.	Part No.	Description	Mark	No.	Part No.	Description
	1	AWZ1025	Power amp A assembly		101		SP Terminal A assembly
	2	AWZ1026	Power amp B assembly		102		Power amp C assembly
	3	AWZ1036	Buffer amp assembly		103		Power amp D assembly
***	4	2SA1516P(A)	Transistor (Q1-Q8)		104		Chemical condenser L assembly
***	5	2SC3907P(A)	Transistor (Q9-Q16)		105		Chemical condenser R assembly
	6	ACG-019	Capacitor (C509)(0.01μF/150V)				
	7	ACG-502	Capacitor (C503, C508, C510)		106		Switch A assembly
	8	CKDYB102K500	Ceramic capacitor (C504, C505)		107		Switch B assembly
	9	CKDYB472K500	Ceramic capacitor (C501, C502, C506, C507)		108		Switch C assembly
△	10	ATS1011	Power transformer (T1)		109		Volume assembly
△	11	ATS1012	Power transformer (T2)		110		Terminal assembly
△	12	AKE-110	Power transformer (T2)		111		Fuse assembly
△	13	AKM-039	(220V/240V)		112		Relay assembly
△	14	ASG-553	Terminal 4P (SPEAKER)		113		Front frame
△	15	AEK-031	Terminal		114		Rear frame
△	16	AEK-042	Switch (POWER)		115		Frame (Transformer frame)
△	17	AXA1001	Fuse (FU3, FU4)(7800mA)				
△	18	AEC-327	Fuse (FU1, FU2)(T3, 15A)		116		Rear panel
△	19	AEP-098	Long shaft assembly		117		Panel stay
△	20	AMR1021	Strain relief		118		P.C.B. Holder-F
	21	ADG-041	Unibersal joint		119		P.C.B. Holder-A
	22	AKF-102	Mica sheet		120		P.C.B. Holder-B
	23	ABN-028	AC Power cord		121		Holder (Chemical condenser)
	24	NK70FUC	Mount plate		122		Side frame
	25	NK90FUC	Nut		123		Damper plate
	26	ABE1001	Nut		124		Center frame
	27	WG70FUC	Nut		125		.....
	28	ABA-297	Washer		126		Heat sink
	29	ABA1016	Washer		127		Earth plate
	31	ABA1007	Screw		128		Shield cushion
	32	ABA1008	Screw (3x10)		129		Cushion
	33	ABA1006	Screw (3x12)		130		P.C.B. Support
	34	VMZ30P060FCU	Screw		131		P.C.B. Support
	35	ABA1009	Screw		132		Sound pillar
	36	ABA1011	Screw				
	37	VMZ30P120FCV	Screw				

**NOTE:**  
The sound quality of parts with the  mark denotes that these are failsafe parts. Be sure that the designated parts are in the positions prescribed.

External Appearance of Transistors and ICs

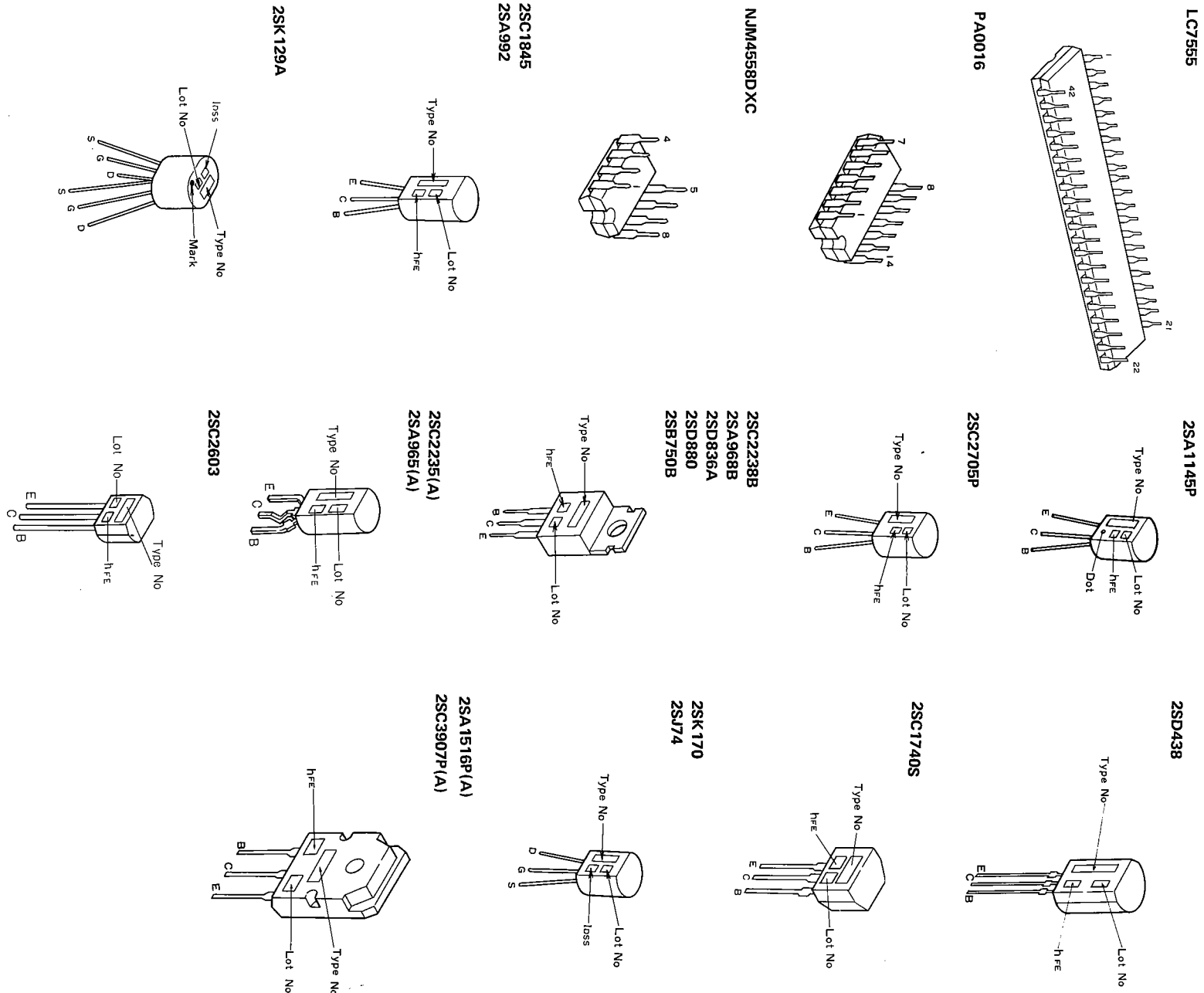

7. ELECTRICAL PARTS LIST

- NOTES:**
- When ordering resistors, first convert resistance values into code form as shown in the following examples.
  - Ex. 1 When there are 2 effective digits (any digit apart from 0), such as 560 ohm and 47k ohm (tolerance is shown by J=5%, and K=10%).
 

560Ω	56 × 10 <sup>1</sup>	561	RD½PS 5 6 1 J
47kΩ	47 × 10 <sup>3</sup>	473	RD½PS 4 7 3 J
0.5Ω	0.5	0R5	RN2H 0 5 K
1Ω	1	010	RS1P 0 1 0 K
  - Ex. 2 When there are 3 effective digits (such as in high precision metal film resistors).
 

5.62kΩ	562 × 10 <sup>1</sup>	5621	RN½SR 5 6 2 1 F
--------	-----------------------	------	-----------------
  - The  $\Delta$  mark found on some component parts indicates the importance of the safety factor of the part. Therefore, when replacing, be sure to use parts of identical designation.
  - For your Parts Stock Control, the fast moving items are indicated with the marks **★★** and **★**.
  - ★★ **GENERALLY MOVES FASTER THAN ★**
  - This classification shall be adjusted by each distributor because it depends on model number, temperature, humidity, etc.
  - Parts marked by "  $\odot$  " are not always kept in stock. Their delivery time may be longer than usual or they may be unavailable.

Miscellaneous Parts

P.C. BOARD ASSEMBLIES

Mark	Symbol & Description	Part No.
	Power amp A assembly	AWZ1025
	Power amp B assembly	AWZ1026
	FL assembly	AWZ1037
	Buffer amp assembly	AWZ1036
	SP Terminal A assembly	Non supply
	Power amp C assembly	Non supply
	Power amp D assembly	Non supply
	Chemical condenser L assembly	Non supply
	Chemical condenser R assembly	Non supply
	Switch A assembly	Non supply
	Switch B assembly	Non supply
	Switch C assembly	Non supply
	Volume assembly	Non supply
	Terminal assembly	Non supply
	Fuse assembly	Non supply
	Relay assembly	Non supply

TRANSFORMERS

Mark	Symbol & Description	Part No.
$\Delta$	T1 Power transformer (Lch) (220V, 240V)	ATS1011
$\Delta$ ★	T2 Power transformer (Rich) (220V, 240V)	ATS1012

CAPACITORS

Mark	Symbol & Description	Part No.
$\Delta$	C509 Ceramic capacitor (0.01μF/150V)	ACG-019
$\Delta$	C503, C508, C510 Ceramic capacitor (0.01μF/400V)	ACG-502
$\Delta$	C504, C505 Ceramic capacitor	CKDYB102K500
$\Delta$	C501, C502, C506, C507 (Ceramic capacitor)	CKDYB472K500

SEMICONDUCTORS

Mark	Symbol & Description	Part No.
$\Delta$ ★★	O1-O8	2SA1516P(A)
$\Delta$ ★★	O9-O16	2SC3907P(A)

FUSES

Mark	Symbol & Description	Part No.
$\Delta$ ★★	FU3, FU4 Fuse (T800mA)	AEK-031
$\Delta$ ★★	FU1, FU2 Fuse (T3.15A)	AEK-042

SWITCH

Mark	Symbol & Description	Part No.
$\Delta$ ★★	S1 Push switch (POWER)	ASG-553

OTHERS

Mark	Symbol & Description	Part No.
$\Delta$	Terminal 4P (SPEAKERS)	AKE-110
$\Delta$	Terminal (GND)	AKM-039
$\Delta$	AC Power cord	ADG-041

# 6. SCHEMATIC DIAGRAM

1

2

3

4

5

6

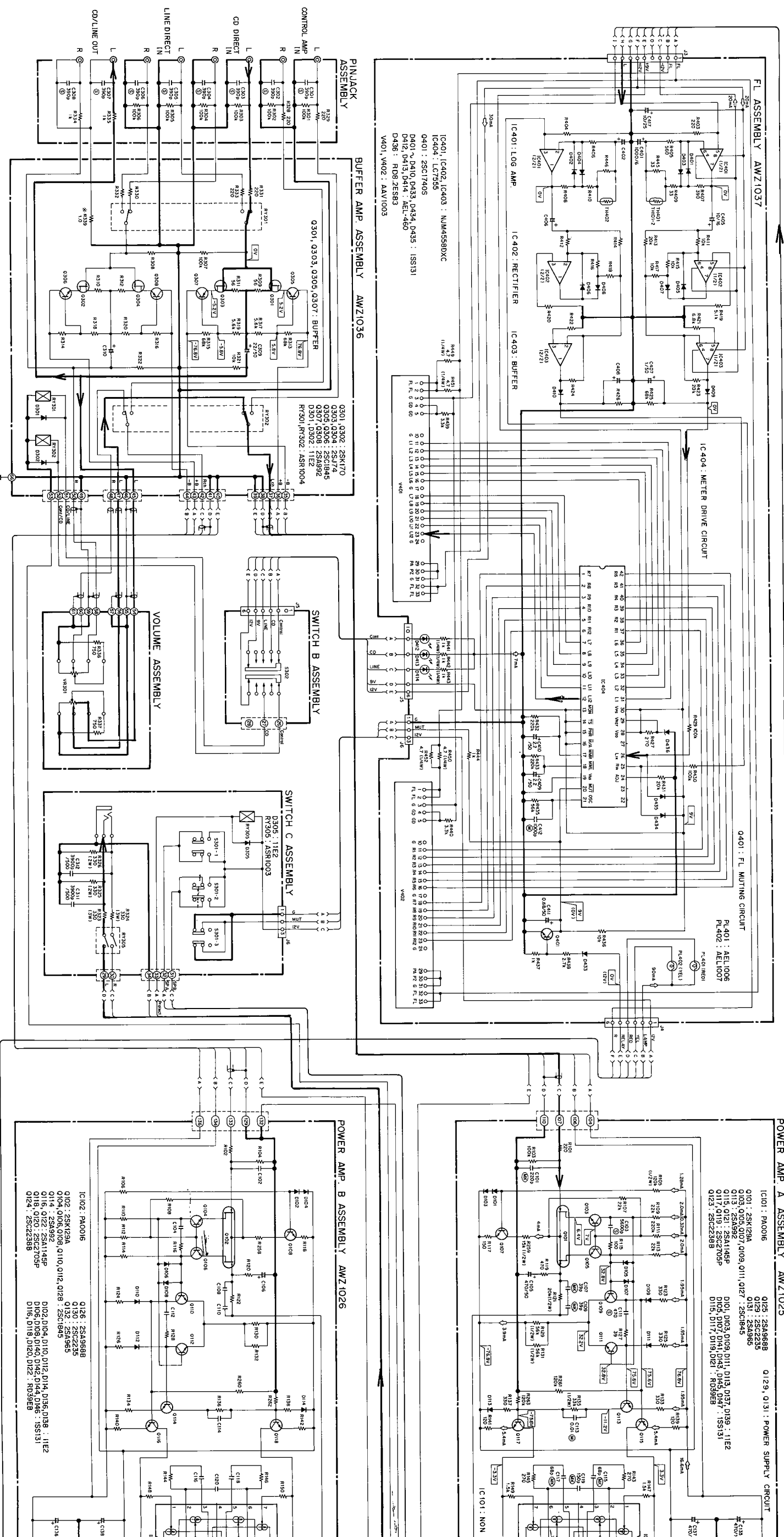

1

2

3

4

5

6

**Amp B Assembly (AWZ1026)**

**INDUCTORS**

Symbol & Description	Part No.
IC102 NSC2 IC	PA0016
Q102	2SK129A
Q104, Q106, Q108, Q110, Q112,	2SC1845
Q128, Q138-Q141	2SA992
Q114, Q142	2SA1145P
Q116, Q122	2SC2705P
Q118, Q120	2SC2238B
Q124	2SA968B
Q126	2SC2235(A)
Q130	2SA965(A)
Q132	2SA965(A)
Q133	2SD836(A)
Q143	2SC1845
Q144, Q146, Q147	2SC2603
Q145	2SD438
D102, D104, D110, C112, D114,	11E2
D133, D135	ISS131
D106, D108, D136, D138, C140,	RD39EB
D142, D144, D146, D150, D152	IS2471
D116, D118, C120, C122	KZL061
D124, D126	
D134	

**Power Amp A Assembly (AWZ1025)**

Mark	Symbol & Description	Part No.
**	IC101 NSC2 IC	PA0016
**	Q101	2SK129A
**	Q103, Q105, Q107, Q109, Q111,	2SC1845
**	Q127	2SA992
**	Q113	2SA1145P
**	Q115, Q121, Q134	2SC2705P
**	Q117, Q119	2SC2238B
**	Q123	2SA968B
**	Q125	2SC2235
**	Q129	2SA965
**	Q131	2SD880
**	Q135, Q148	2SD836A
**	Q136	2SB750B
**	Q137	

**CAPACITORS**

Mark	Symbol & Description	Part No.
	C101	CMA221J500
	C103	COSXA562J160
	C105 (470μF/50V)	ACH-455
	C107, C109	CMA390J500
	C111	COSXA471J160
	C113 (0.01μF/100V)	ACE-066
	C115, C117	CMA680J500
	C119	CMA151J500
	C121, C123	CMA101J500
	C125	CEANP2R2M100
	C127, C129 (0.1μF/100V)	ACE-067
	C131, C133	CEXA331M2A
	C135, C137	CEXA471M2A
	C139	CEAS102M25
	C140	CEAS471M25
	C141, C142	CEAS101M16
	C144, C145, C146, C153, C155	CEAS470M25
	C147, C148, C156	CEAS100M50

**RESISTORS**

Note: When ordering resistors, convert the resistance value into code form, and then rewrite the part no. as before.

Mark	Symbol & Description	Part No.
	R105, R121, R129, R131, R135,	RDR1/2PM□□□J
	R259	R241-2PM□□□J
	R241-R243	RD1/2PM□□□J
	R155	RD1/4PM□□□J
	R244-R246, R268, R269	RD1/4PM□□□J
	R151, R153, R157, R159, R161,	RFA1/4PS□□□J
	R173, R175, R123, R125, R133,	
	R137	RS1LMF100J
	R169	RS2LMF□□□J
	R171, R177, R179, R267	RDR1/4PM□□□J
	Other resistors	

**FL Assembly (AWZ1037)**

**SEMICONDUCTORS**

Mark	Symbol & Description	Part No.
**	IC401, IC402, IC403	NJM4558DXC
**	IC404	LCT555
**	Q401	2SC1740S
**	TH401, TH402	TH101
*	D401-D410	1SS131
*	D412-D414	AEL-460
*	D433-D435	1SS131
*	D436	RD8.2ESB3

**CAPACITORS**

Mark	Symbol & Description	Part No.
	C401, C402	CEAS102M6
	C405, C406	CEJA100M16
	C407, C408	CEAS010M50
	C409, C410	CEAS2R2M50
	C411	CEASR68M50
	C412	COMA102J50
	C417	CEAS100M25

**RESISTORS**

Note: When ordering resistors, convert the resistance value into code form, and then rewrite the part no. as before.

Mark	Symbol & Description	Part No.
	R449-R452	RD1/4PM4R7J
	R441-R443	RD1/4PM102J
	Other resistors	RD1/8PM□□□J

**OTHERS**

Mark	Symbol & Description	Part No.
*	V401, V402 Fluorescent Indicator tube	AAV1003
*	PL401 Lamp (Red)	AEL1006
*	PL402 Lamp (Yellow)	AEL1007

**Buffer Amp Assembly (AWZ1036)**

**SEMICONDUCTORS**

Mark	Symbol & Description	Part No.
**	Q301, Q302	2SK170
**	Q303, Q304	2SJ74
**	Q305, Q306	2SC1845
**	Q307, Q308	2SA992
*	D301, D302	11E2

**RELAYS**

Mark	Symbol & Description	Part No.
**	RY301, RY302 Relay (INPUT SELECTOR)	ASR1004

**CAPACITORS**

Mark	Symbol & Description	Part No.
	C309, C310	CEYA220M50

**RESISTORS**

Note: When ordering resistors, convert the resistance value into code form, and then rewrite the part no. as before.

Mark	Symbol & Description	Part No.
	R307-R322, R330-R333	RDR1/4PM□□□J
	R339	RD1/4PM010J

**INDUCTORS**

Symbol & Description	Part No.
L102 (2.7μH)	ATH1001
C102	CMA221J500
C104	COSXA562J160
C106 (470μF/50V)	ACH-455
C108, C110	CMA390J500
C112	COSXA471J160
C114	ACE-066
C116, C118	CMA680J500
C120	CMA151J500
C122, C124	CMA101J500
C126	CEANP2R2M100
C128, C130	ACE-067
C132, C134	CEXA331M2A
C136, C138	CEXA471M2A
C143	CEAS470M25
C149, C150	CEAS331M10
C151	CEAS330M16
C152	CEAS3R3M50
C154	CKCYB102K50
C157	CEAS220M25

**COIL**

Mark	Symbol & Description	Part No.
	L101 (2.7μH)	ATH1001

**SP Terminal Assembly**

**CAPACITORS**

Mark	Symbol & Description	Part No.
	C1, C2, C5, C6	CKDYB102K500

**RESISTORS**

Mark	Symbol & Description	Part No.
	R1, R2	RD1/4PM100J

**Power amp C Assembly**

**RESISTORS**

*Note: When ordering resistors, convert the resistance value into code form, and then rewrite the part no. as before.*

Mark	Symbol & Description	Part No.
	R207, R209, R211, R213 (2W+2W, 0.47x2)	ACN-118
	R191, R193, R195, R197, R199, R201, R203, R205 Other resistors	RFA1/4PS4R7J RD1/4PMF□□□J

**Power amp D Assembly**

**RESISTORS**

*Note: When ordering resistors, convert the resistance value into code form, and then rewrite the part no. as before.*

Mark	Symbol & Description	Part No.
	R208, R210, R212, R214 (2W+2W, 0.47x2)	ACN-118
	R192, R194, R196, R198, R200, R202, R204, R205 Other resistors	RFA1/4PS4R7J RD1/4PMF□□□J

**Chemical Condenser L Assembly**

**SEMICONDUCTORS**

Mark	Symbol & Description	Part No.
★	D415, D417, D419, D421, D423, D425, D427, D429	31DF2FC
★	D431	10E2FD

**RELAY**

Mark	Symbol & Description	Part No.
★★	RY401 Relay (4Ω/8Ω)	ASR1001

**CAPACITORS**

Mark	Symbol & Description	Part No.
	C413, C415 (1200μF/100V)	ACH1004

**Chemical Condenser R Assembly**

**SEMICONDUCTORS**

Mark	Symbol & Description	Part No.
★	D416, D418, R420, D422, D424, D426, D428, D430	31DF2FC
★	D432	10E2FD

**RELAY**

Mark	Symbol & Description	Part No.
★★	RY402 Relay (4Ω/8Ω)	ASR1001

**CAPACITORS**

Mark	Symbol & Description	Part No.
	C414, C416 (1200μF/100V)	ACH1004

**Switch A Assembly**

**SEMICONDUCTORS**

Mark	Symbol & Description	Part No.
★★	Q309	2SC2603
★★	Q310	2SC1740S
★	D306	11E2
★	D307	RD5.6EB

**SWITCH**

Mark	Symbol & Description	Part No.
★★	S303 Slide switch (SPEAKER IMPEDANCE)	ASH-015

**CAPACITOR**

Mark	Symbol & Description	Part No.
	C313	CEJA100M50

**RESISTOR**

Mark	Symbol & Description	Part No.
	R327	RD1/4PM274J

**Switch B Assembly**

**SWITCH**

Mark	Symbol & Description	Part No.
★★	S302 Rotary switch (INPUT SELECTOR)	ASE1001

**Switch C Assembly**

**SEMICONDUCTOR**

Mark	Symbol & Description	Part No.
★	D305	11E2

**RELAY AND SWITCH**

Mark	Symbol & Description	Part No.
★★	RY305 Relay (HEADPHONE ON/ OFF)	ASR1003
★★	S301 Push switch (SPEAKERS A/B, DISPLAY ON/OFF)	SULBLXXXX

**CAPACITORS**

Mark	Symbol & Description	Part No.
	C311, C312	CKCYB392K500

**RESISTORS**

Mark	Symbol & Description	Part No.
	R323, R324 R325, R326	RS3LMF331J RS2LMF331J

**OTHERS**

Mark	Symbol & Description	Part No.
	PHONE JACK (HEAD PHONE)	AKN1002

**Volume Assembly**

**RESISTORS**

Mark	Symbol & Description	Part No.
★	VR301 Volume (CD/LINE INPUT LEVEL) -R336, R337	ACW1002 RD1/4PM751J

**Fuse Assembly**

**COILS**

Mark	Symbol & Description	Part No.
△	L301 (300μH)	ATF1006

**CAPACITORS**

Mark	Symbol & Description	Part No.
△	C314 Ceramic capacitor (0.01μF/400V)	ACG-502

**Terminal Assembly**

**CAPACITORS**

Mark	Symbol & Description	Part No.
	C301-C308	COSXA391J1

**RESISTORS**

*Note: When ordering resistors, convert the resistance value into code form, and then rewrite the part no. as before.*

Mark	Symbol & Description	Part No.
	R301-R306, R328, R329, R334, R335	RD1/4PM□□ R335

**OTHERS**

Mark	Symbol & Description	Part No.
	Terminal 4P (CONTROL IN, CD/ LINE OUT)	AKB1003

**RELAY Assembly**

**SEMICONDUCTORS**

Mark	Symbol & Description	Part No.
★	D303, D304	11E2

**RELAYS**

Mark	Symbol & Description	Part No.
	RY303, RY304 Relay (SPEAKERS A/B)	ASR1002

# CK DIAGRAM

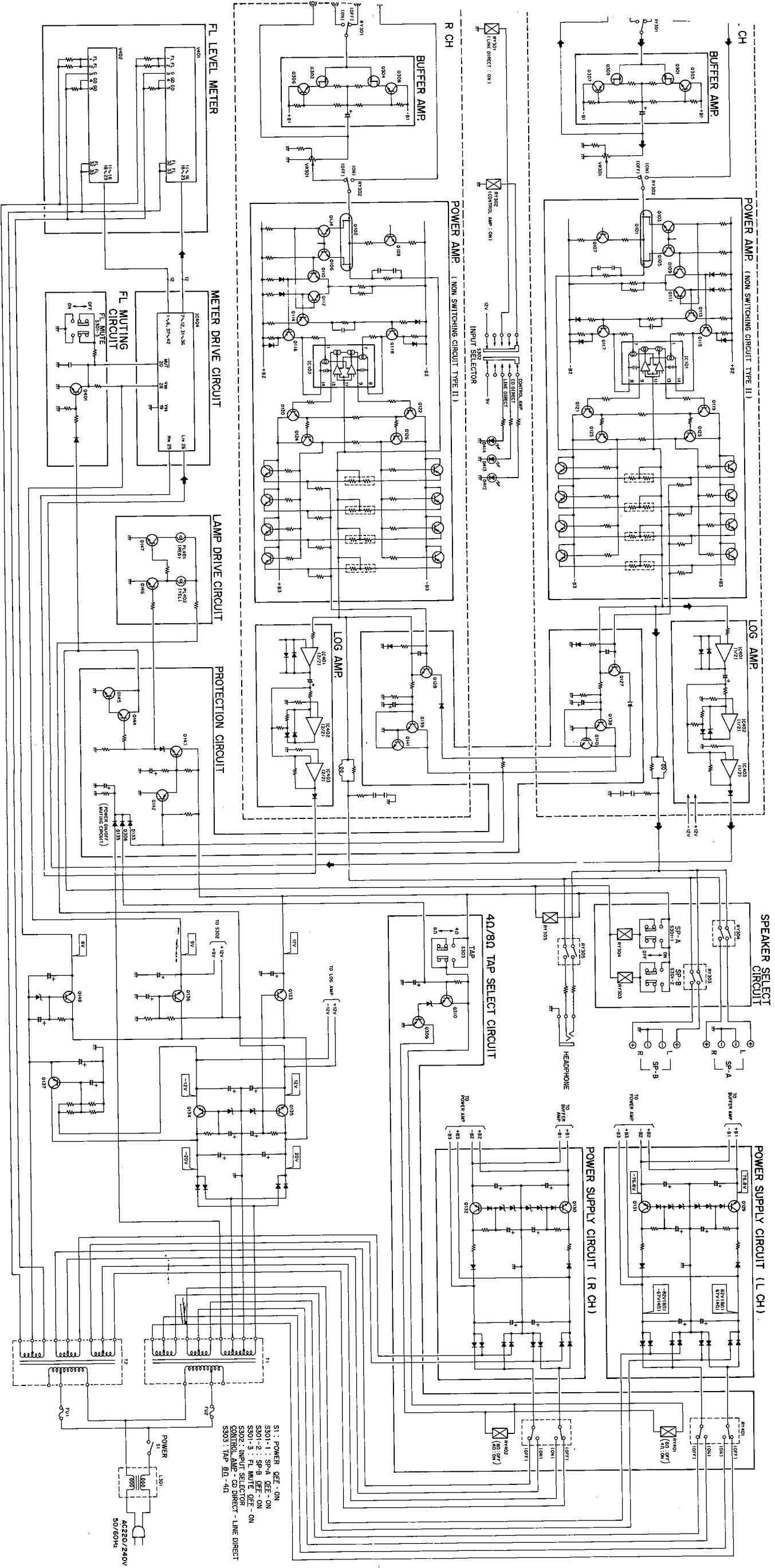

## 9. CIRCUIT DESCRIPTIONS

### INPUT SYSTEM

There are 3 input terminals comprising CONTROL AMP CD DIRECTION IN and LINE DIRECT IN selection of signals from CD DIRECT IN and LINE DIRECT IN input are made by the switch and after being routed through the buffer amp and CD INPUT level volume are once again selected by the SW together with the signal from the Control Amp. If CD/LINE signals are also used for such components as pre-amp and tape deck, the above buffer amp output is routed through the LINE OUT terminal.

### POWER AMP SECTION

Selected signals from the input SW (S302) are input to the power amp which comprises a 2 stage differential Non Switching Circuit TYPE II and a 3 stage Darlington.

Due to use of the Non Switching Circuit TYPE II:

- Low distortion  
Distortion at the output stage has been suppressed by 1/30 over previous models.
- Fluctuations in idle current just after switching POWER ON and also at the time of changes in signal level can be immediately stabilized with the present model.
- Non switching distortion can be suppressed.

The kind of circuitry used in the M-90 has the high power and low load drive performance for (20Hz~20kHz 0.003%) 200W/8Ω.

### OUTPUT SYSTEM

Output from the power amp is routed through the Protection relay (RY303, RY304) and output to the speaker terminals A, B. For output to the headphone terminal, power amp output is passed through the special muting relay (RY305).

### POWER METER (FL) ACTIVATOR CIRCUIT

Power amp output is compressed by the LOG AMP and input to the PEAK HOLD circuit which drives a 12 point bar display.

### PROTECTOR CIRCUIT

When there is overload and direct current output at the power amp output, the protector circuit will detect it, open the Protection relay and prevent to the amp and speakers. The Protection relay is also opened during POWER ON/OFF so there is no sudden loud emission.

### POWER SYSTEM

The power source to the power amp and CD buffer amp is perfectly separated for Lch and Rch as are the transformers. Power to the control system is also supplied by special transformer coils and the coils for the FL heater are separate too, so mutual interference is prevented.

# 10. IC DESCRIPTIONS

Peak Hold Level Meter IC.

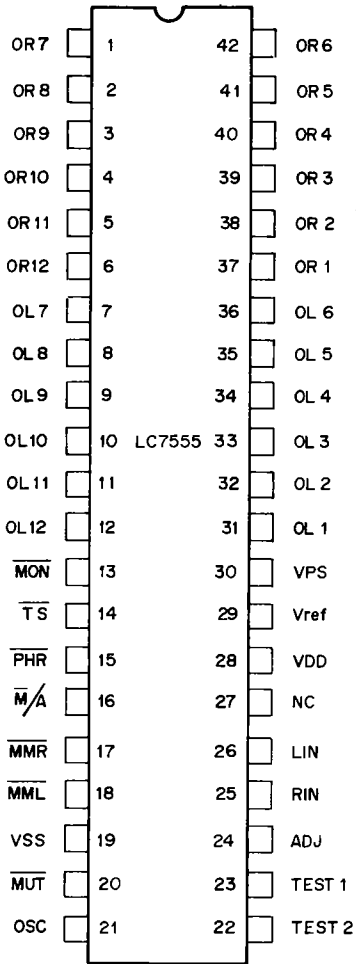

(Note) : NC Terminal should be open

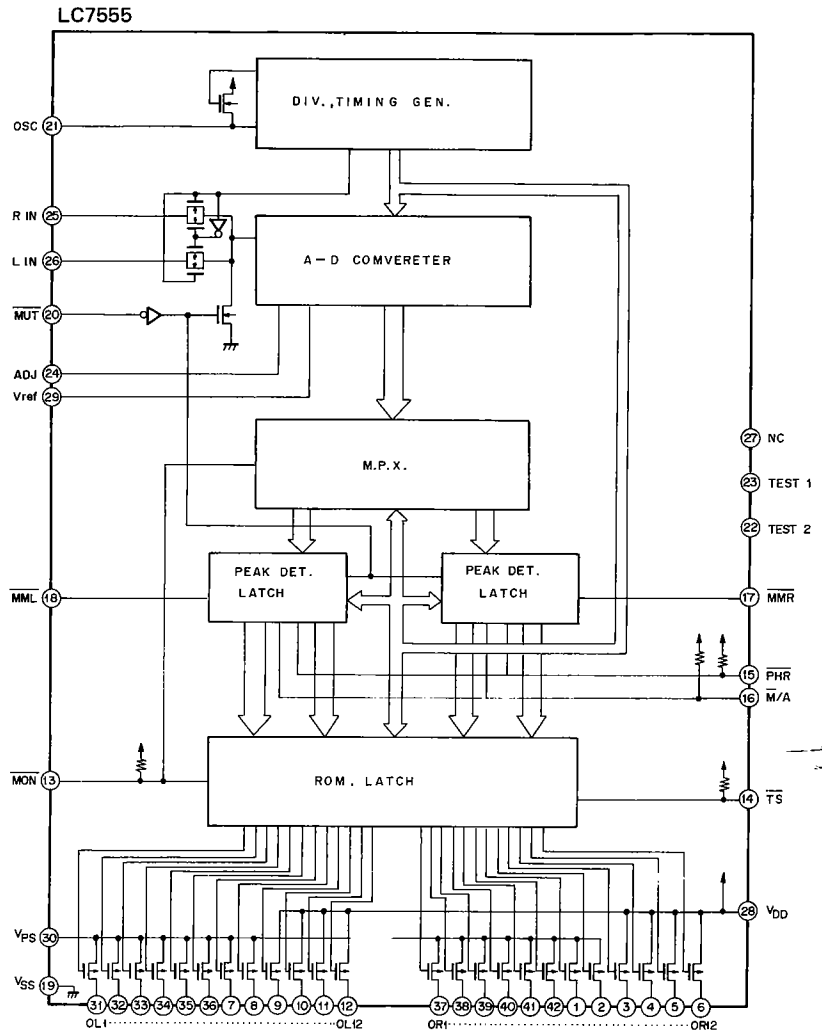

Fig. 10-1 Distribution of pins and block diagram for LC7555



# 11. PACKING

## Parts List of Packing

Mark	No.	Part No.	Description
	1	AHA1003	Top pad
	2	AHA1034	Bottom pad
	3	AHD1013	Packing case
	4	ADE1012	Connection cord with plug
	5	ARC1002	Operating instruction
51			Vinyl
52			Seat

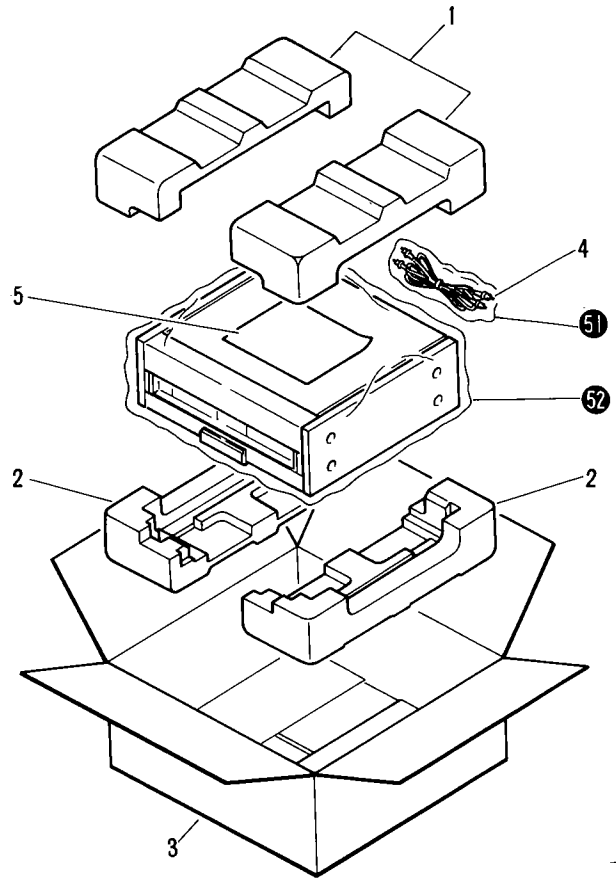

# 12. SAFETY INFORMATION

## 1. SAFETY PRECAUTIONS

The following check should be performed for the continued protection of the customer and service technician.

### LEAKAGE CURRENT CHECK

Measure leakage current to a known earth ground (water pipe, conduit, etc.) by connecting a leakage current tester such as Simpson Model 229-2 or equivalent between the earth ground and all exposed metal parts of the appliance (input/output terminals, screwheads, metal overlays, control shaft, etc.). Plug the AC line cord of the appliance directly into a 120V AC 60Hz outlet and turn the AC power switch on. Any current measured must not exceed 0.5mA.

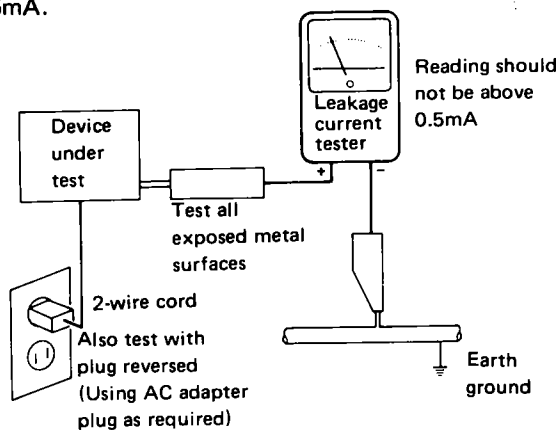

AC Leakage Test

ANY MEASUREMENTS NOT WITHIN THE LIMITS OUTLINED ABOVE ARE INDICATIVE OF A POTENTIAL SHOCK HAZARD AND MUST BE CORRECTED BEFORE RETURNING THE APPLIANCE TO THE CUSTOMER.

## 2. PRODUCT SAFETY NOTICE

Many electrical and mechanical parts in the appliance have special safety related characteristics. These are often not evident from visual inspection nor the protection afforded by them necessarily can be obtained by using replacement components rated for voltage, wattage, etc. Replacement parts which have these special safety characteristics are identified in this Service Manual.

Electrical components having such features are identified by marking with a  $\Delta$  on the schematics and on the parts list in this Service Manual.

The use of a substitute replacement component which does not have the same safety characteristics as the PIONEER recommended replacement one, shown in the parts list in this Service Manual, may create shock, fire, or other hazards.

Product Safety is continuously under review and new instructions are issued from time to time. For the latest information, always consult the current PIONEER Service Manual. A subscription to, or additional copies of, PIONEER Service Manual may be obtained at a nominal charge from PIONEER.

