

Service Manual

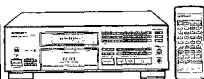

ORDER NO.
ARP 2 2 2 8

COMPACT DISC PLAYER

PD-31

PD-8700 PD-8700-S

PD-7700 PD-7700-S

PD-31, PD-8700, PD-8700-S, PD-7700 AND PD-7700-S HAVE THE FOLLOWING :

Type	Model					Power Requirement	Remarks
	PD-31	PD-8700	PD-8700-S	PD-7700	PD-7700-S		
KU	○	—	—	○	—	AC120V only	
KC	—	—	—	○	—	AC120V only	
HEM	—	○	—	—	—	AC220-230V, AC230-240V(switchable)*	
HB	—	○	—	○	—	AC220-230V, AC230-240V(switchable)*	
SD	—	○	—	○	—	AC110V, 120-127V, 220V, 240V(switchable)	
HEWM	—	—	○	—	○	AC220-230V, AC230-240V(switchable)*	
HPW	—	—	—	○	—	AC220-230V, AC230-240V(switchable)*	

* : Change the primary wiring of the power transformer.

- This manual is applicable to the PD-31/KU, PD-8700/HEM, HB, SD, PD-8700-S/HEWM, PD-7700/KU, KC, HEM, HB, SD, HPW and PD-7700-S/HEWM types.
- As to the PD-8700/HEM, HB, SD AND PD-8700-S/HEWM types, refer to page 81.
- As to the PD-7700/KU, KC, HEM, HB, SD, HPW and PD-7700-S/HEWM types, refer to page 83.
- Ce manuel pour le service comprend les explications de réglage en français.
- Este manual de servicio trata del método ajuste escrito en español.

CONTENTS

1. SAFETY INFORMATION	2	6. AJUSTE	65
2. EXPLODED VIEWS AND PARTS LIST	4	7. FL INFORMATION	80
3. P.C.B.'s PARTS LIST	11	8. FOR PD-8700/HEM, HB, SD AND PD-8700-S/HEWM TYPES	81
4. PACKING	14	9. FOR PD-7700/KU, KC, HEM, HB, SD, HPW AND PD-7700-S/HEWM TYPES	83
5. SCHEMATIC DIAGRAM AND P.C. BOARDS CONNECTION DIAGRAM	15	10. PANEL FACILITIES	101
6. ADJUSTMENTS	35	11. SPECIFICATIONS	103
6. RÉGLAGE	50		

PIONEER ELECTRONIC CORPORATION 4-1, Meguro 1-Chome, Meguro-ku, Tokyo 153, Japan
PIONEER ELECTRONICS SERVICE INC. P.O. Box 1760, Long Beach, California 90801 U.S.A.
PIONEER ELECTRONICS OF CANADA, INC. 505 Cochrane Drive, Markham, Ontario L3R 8E3 Canada
PIONEER ELECTRONIC (EUROPE) N.V. Keetberglaan 1, 9120 Beveren, Belgium
PIONEER ELECTRONICS AUSTRALIA PTY. LTD. 178-184 Boundary Road, Braeside, Victoria 3195, Australia TEL: (03) 580-8911
 © PIONEER ELECTRONIC CORPORATION 1991

FI APR. 1991 Printed in Japan

This service manual is intended for qualified service technicians; it is not meant for the casual do-it-yourselfer. Qualified technicians have the necessary test equipment and tools, and have been trained to properly and safely repair complex products such as those covered by this manual.

Improperly performed repairs can adversely affect the safety and reliability of the product and may void the warranty. If you are not qualified to perform the repair of this product properly and safely, you should not risk trying to do so and refer the repair to a qualified service technician.

WARNING

Lead in solder used in this product is listed by the California Health and Welfare agency as a known reproductive toxicant which may cause birth defects or other reproductive harm (California Health & Safety Code, Section 25249.5).

When servicing or handling circuit boards and other components which contain lead in solder, avoid unprotected skin contact with the solder. Also, when soldering do not inhale any smoke or fumes produced.

1. SAFETY INFORMATION

(FOR USA MODEL ONLY)

1. SAFETY PRECAUTIONS

The following check should be performed for the continued protection of the customer and service technician.

LEAKAGE CURRENT CHECK

Measure leakage current to a known earth ground (water pipe, conduit, etc.) by connecting a leakage current tester such as Simpson Model 229-2 or equivalent between the earth ground and all exposed metal parts of the appliance (input/output terminals, screwheads, metal overlays, control shaft, etc.). Plug the AC line cord of the appliance directly into a 120V AC 60Hz outlet and turn the AC power switch on. Any current measured must not exceed 0.5mA.

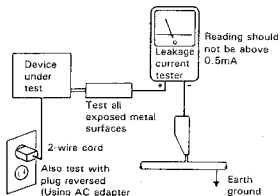

AC Leakage Test

ANY MEASUREMENTS NOT WITHIN THE LIMITS OUTLINED ABOVE ARE INDICATIVE OF A POTENTIAL SHOCK HAZARD AND MUST BE CORRECTED BEFORE RETURNING THE APPLIANCE TO THE CUSTOMER.

2. PRODUCT SAFETY NOTICE

Many electrical and mechanical parts in the appliance have special safety related characteristics. These are often not evident from visual inspection nor the protection afforded by them necessarily can be obtained by using replacement components rated for voltage, wattage, etc. Replacement parts which have these special safety characteristics are identified in this Service Manual.

Electrical components having such features are identified by marking with a Δ on the schematics and on the parts list in this Service Manual.

The use of a substitute replacement component which does not have the same safety characteristics as the PIONEER recommended replacement one, shown in the parts list in this Service Manual, may create shock, fire, or other hazards.

Product Safety is continuously under review and new instructions are issued from time to time. For the latest information, always consult the current PIONEER Service Manual. A subscription to, or additional copies of, PIONEER Service Manual may be obtained at a nominal charge from PIONEER.

(FOR EUROPEAN MODEL ONLY)

VARO!

AVATTAESSA JA SUOJALUKITUS
OHITETTAESSA OLET ALTHINA
NAKYMATOMALLE LASERSÄTELYLLE.
ÄLÄ KATSO SÄTEESEEN.

ADVARSEL:

USYNLIG LASERSTRÅLING VED ÅBNING
NÅR SIKKERHEDSAFBRYDERE ER UDE AF
FUNKTION UDGÅR UDSÆTTELSE FOR
STRÅLING.

VARNING!

OSYNLIG LASERSTRÅLING NÅR DENNA
DEL ÄR ÖPPNAD OCH SPÄRREN
ÄR URKÖPPLAD. BETRakta EJ STRÅLEN.



LASER
Kuva 1
Lasersäteilyn
varoituserkki

WARNING!

DEVICE INCLUDES LASER DIODE WHICH
EMITS INVISIBLE INFRARED RADIATION
WHICH IS DANGEROUS TO EYES. THERE IS
A WARNING SIGN ACCORDING TO PICTURE
1 INSIDE THE DEVICE CLOSE TO THE LASER
DIODE.



LASER
Picture 1
Warning sign for
laser radiation

IMPORTANT

THIS PIONEER APPARATUS CONTAINS
LASER OF HIGHER CLASS THAN 1.
SERVICING OPERATION OF THE APPARATUS
SHOULD BE DONE BY A SPECIALLY
INSTRUCTED PERSON.

LASER DIODE CHARACTERISTICS
MAXIMUM OUTPUT POWER: 5 mw
WAVELENGTH: 780-785 nm

LABEL CHECK

HB, HEM and HEWM types



HEM and HEWM types

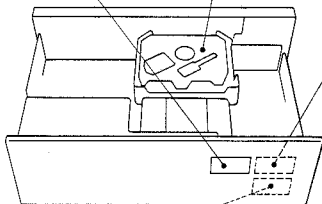
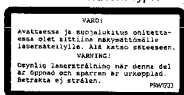

Additional Laser Caution

1. Laser Interlock Mechanism

The ON/OFF (ON: low level, OFF: high level) status of the LPS1 (S601) and LPS2 (S602) switches for detecting the loading state is detected by the system microprocessor, and the design prevents laser diode oscillation when both switches LPS1 and LPS2 are not ON (low level) (clamped state). Thus, interlock will no longer function if switches LPS1 (S601) and LPS2 (S602) are deliberately shorted. Also, in the test mode*, the interlock mechanism does not operate too.

Laser diode oscillation will continue if pins 2 and 3 of CXA14715 (IC101) are connected to ground or pin 20 is connected to high level (ON) or the terminals of Q101 are shorted to each other (fault condition).

2. When the cover is opened with the servo mechanism block removed to be turned over, close viewing of the objective lens with the naked eye will cause exposure to a Class 1 or higher laser beam.

ADVARSEL

USYNLIG LASERSTRÅLING VED ÅBNING NÅR SIKKERHEDSAFBRYDERE SÅR
FUNKTION UDGÅR UDSÆTTELSE FOR STRÅLING.

VARO!

OSYNLIG LASERSTRÅLING NÅR DENNA DEL ÄR ÖPPNAD OCH SPÄRREN
ÄR URKÖPPLAD. BETRakta EJ STRÅLEN.

CAUTION
INVISIBLE LASER
RADIATION WHEN OPEN,
AVOID EXPOSURE
TO BEAM

PRW1018

HEM and HEWM types

HB type

* Refer to page 36.

2. EXPLODED VIEWS AND PARTS LIST

NOTES:

- Parts without part number cannot be supplied.
- Parts marked by "⊙" are not always kept in stock. Their delivery time may be longer than usual or they may be unavailable.
- The Δ mark found on some component parts indicates the importance of the safety factor of the part. Therefore, when replacing, be sure to use parts of identical designation.

2.1 EXTERIOR

Parts List of Exterior

Mark	No.	Description	Parts No.	Mark	No.	Description	Parts No.
⊙	1	Mother board assembly	PWM1448		101	Name plate(ABS)	
Δ	2	Strain relief	CM-22C		102	SW board assembly	
	3	AC power cord	PDG1015		103	Under base	
Δ	4	Power transformer S(AC120V)	PTT1179		104	Audio angle	
Δ	5	Power transformer A(AC120V)	PTT1183		105	Rear base	
	6	Stopper	PNM1134		106	Headphone angle	
	7	Insulator	PNW2020		107	Spacer	
	8	Cord clamber	RNH-184		108	Loading mechanism assembly	
	9	Power button	PAC1569		109	Front panel	
	10	Select button	PAC1570		110	Headphone board assembly	
	11	Play button	PAC1571		111	Jack board assembly	
	12	Search button	PAC1572		112	S trans board assembly	
	13	Display window	PAM1503		113	A trans board assembly	
	14	Control panel	PNW1948				
	15	Tray lens	PNW1950				
	16	LED lens	PNW2019				
	17	Tray panel	PNW2025				
	18	Slide knob	RAC1428				
	19	Knob C	RAC1608				
	20	BIAS lens	RNK1674				
	21	Front panel assembly	PEA1164				
	22	Beonet	PYY1148				
⊙	23	Audio board assembly	PWZ2118				
⊙	24	Operate board assembly	PWZ2112				
	25	Screw	BBT30P080FZK				
	26	Screw	BBZ30P060FMC				
	27	Screw	BBZ30P080FCC				
	28	Screw	BBZ30P080FCC				
	29	Screw	BBZ30P120FMC				
	30	Screw	BBZ30P120FMC				
	31	Screw	FBT40P080FZK				
	32	Screw	IBZ30P060FCC				
	33	Screw	IBZ30P080FCC				
	34	Screw	IBZ30P150FCC				
	35	Screw	PDZ30P060FCC				

* The stopper consist of the big ring part and the small ring part.

If you stick the stopper to the leg, stick the big ring part to the front leg, and the small ring part to the rear leg.

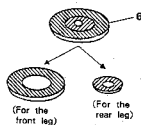

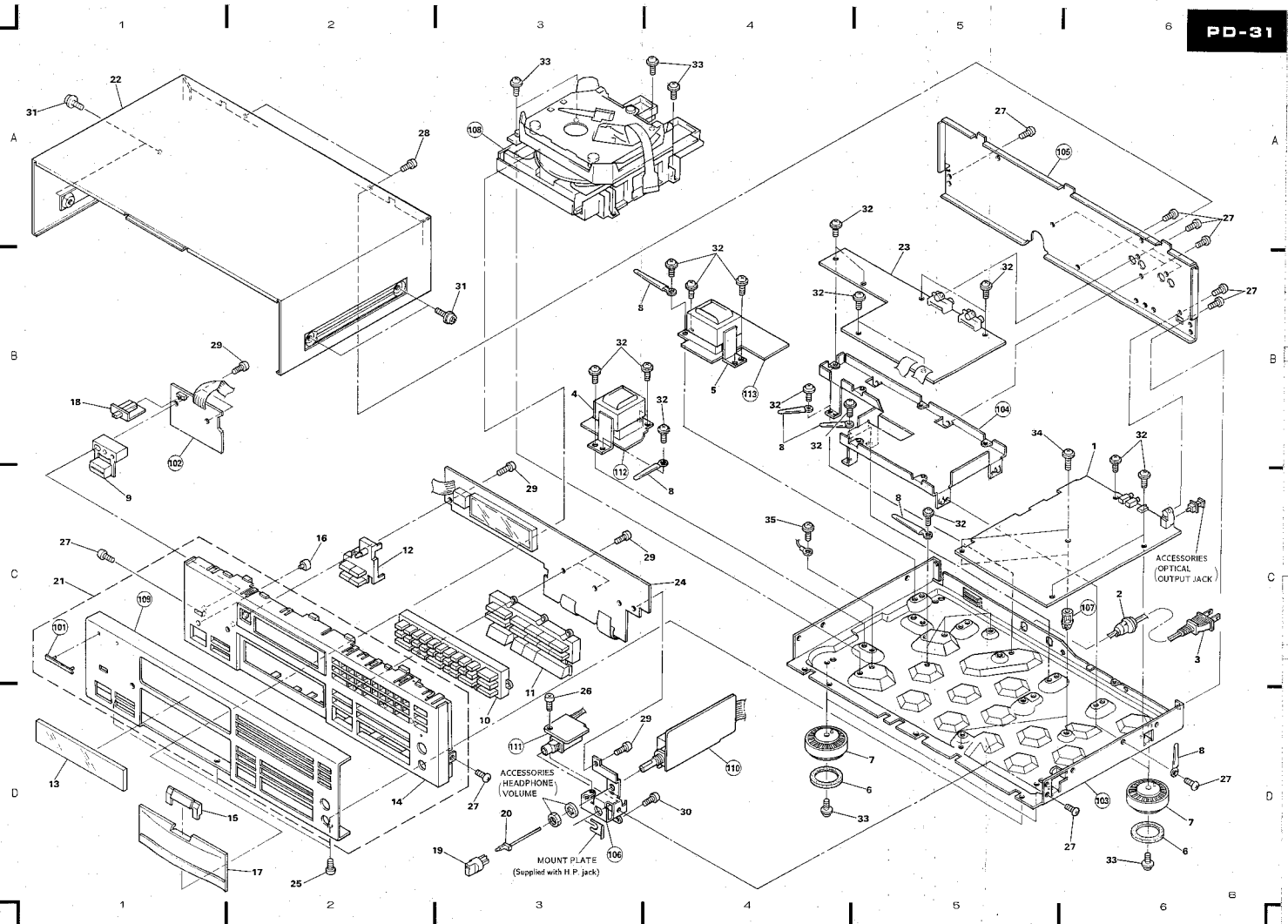

ACCESSORIES HEADPHONE VOLUME

ACCESSORIES OPTICAL (OUTPUT JACK)

MOUNT PLATE
(Supplied with H.P. jack)

2.2 MECHANISM SECTION

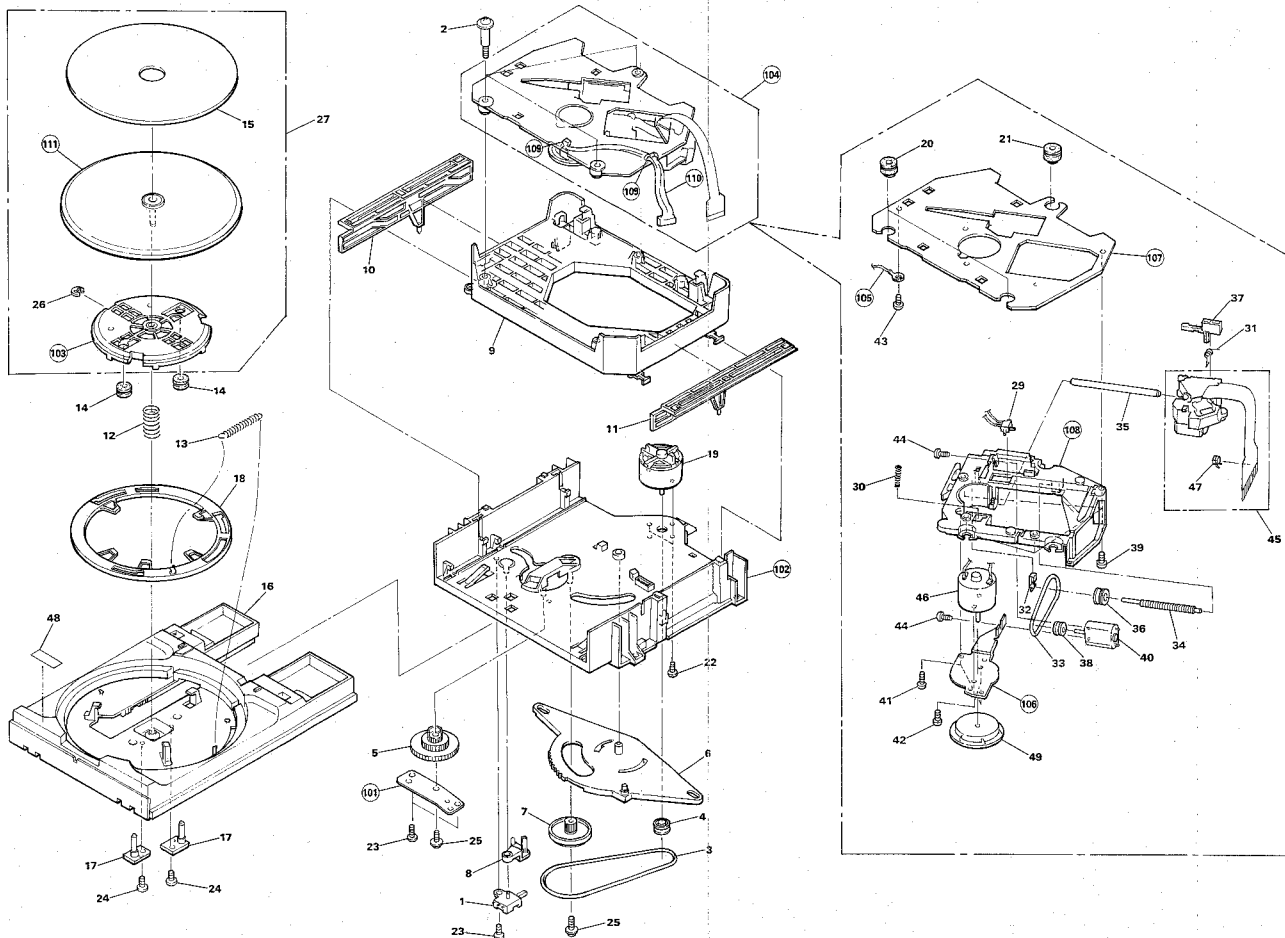

A
B
C
D

Parts List of Mechanism section

Mark No.	Description	Parts No.	Mark No.	Description	Parts No.
1	Lever switch	DSK1003	101	Shaft holder	
2	Screw(steel)	PBA1027	102	Loading base	
3	Rubber belt	PEB1186	103	Table bearings assembly	
4	Motor pulley	PNW1634	104	Servo mechanism assembly	
5	Drive gear	PNW1996	105	Earth lead unit(300V)	
6	Timing lever	PNW1997	106	Motor base	
7	Gear pulley	PNW1998	107	Mechanism base	
8	SW head	PNW1999	108	Mechanism chassis	
9	Float base	PNW2000	109	Clamper	
10	Left cam	PNW2001	110	Connector assembly	
11	Right cam	PNW2002	111	Turn table(AL)	
12	Compression spring	PBH1120			
13	Tention spring	PBH1121			
14	Float(rubber)	PEB1014			
15	Table rubber sheet	PEB1181			
16	Tray	PNW2003			
17	Table guide	PNW2004			
18	Lock plate	PNW2005			
19	DC motor(0.75W)	PXM1010			
20	Rubber bush	PEB1031			
21	Rubber bush	PEB1170			
22	Screw	BMZ26P040FMC			
23	Screw	BPZ26P060FMC			
24	Screw	BPZ26P060FMC			
25	Screw	IPZ20P080FMC			
26	Stop ring	YE20S			
27	Turn table assembly	PEA1165			
29	Push switch	DSG1014			
30	Spring	PBH1009			
31	Spring	PBH1084			
32	Plate spring	PBK1057			
33	Belt(square)	PEB1072			
34	Screw	PLA1003			
35	Guide bar	PLA1071			
36	Pulley	PNW1066			
37	Half nut	PNW1605			
38	Motor pulley	PNW1634			
39	Screw	PBZ30P080FMC			
40	DC motor(1.7W)	PXM1013			
41	Screw	BPZ20P080FZK			
42	Screw	JFZ20P025FMC			
43	Screw	PBZ30P080FMC			
44	Screw	PMZ20P030FMC			
45	Pick up assembly	PEA1030			
46	DC motor assembly (With oil)	PEA1156			
47	Semi-fixed VR(3.3K)	PCP1008			
48	Caution label	PRW1244			
49	Disc table	PNW1067			

• How to install the disc table

- 1 Use nippers or other tool to cut the two sections marked ① in figure 1. Then remove the spacer.
- 2 While supporting the spindle motor shaft with the stopper, put spacer on top of the motor base (angled so it doesn't touch section ②), and stick the disc table on top (takes about 9kg pressure). Take off the spacer.

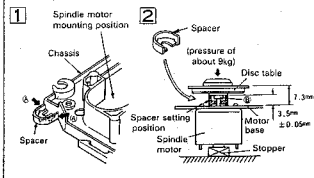

2.3 REMOVE THE TRAY PANEL AND THE TRAY LENS

Hold the tray panel with your hands as the figure shown right, and grasp the tray with your thumbs and then lift the tray panel up while pulling it toward you with the other fingers. (Figs. 1 and 2)

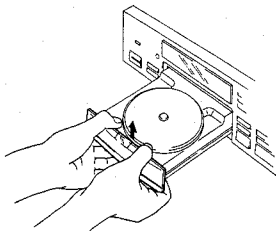

Fig. 1

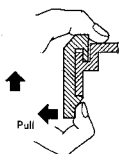

Fig. 2

2.4 INSTALL THE TRAY PANEL AND THE TRAY LENS

Align the tray panel with the grooves located at both edges of the tray while holding the tray lens with your fingers, and then press it down till it stops. (Fig. 3)

Hold the tray panel and the tray as shown in Fig. 4 and slide them down till you hear a click sound while pressing strongly with your thumbs. (Figs. 4 and 5)

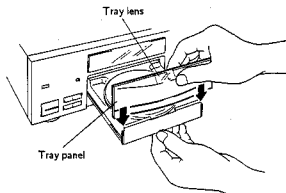

Fig. 3

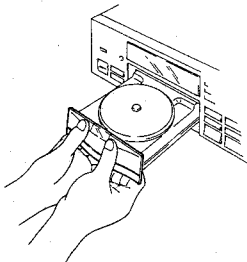

Fig. 4

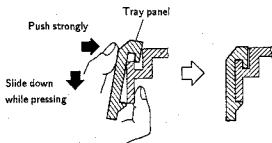

Fig. 5

3. P.C.B.'s PARTS LIST

NOTES :

- Parts without part number cannot be supplied.
- Parts marked by "Ⓢ" are not always kept in stock. Their delivery time may be longer than usual or they may be unavailable.
- The Δ mark found on some component parts indicates the importance of the safety factor of the part. Therefore, when replacing, be sure to use parts of identical designation.
- When ordering resistors, first convert resistance values into code form as shown in the following examples.

Ex.1 When there are 2 effective digits (any digit apart from 0), such as 560 ohm and 47k ohm (tolerance is shown by J = 5%, and K = 10%).

560 Ω	56 $\times 10^3$	561	RD1/4PS	5	6	1	J
47k Ω	47 $\times 10^3$	473	RD1/4PS	4	7	3	J
0.5 Ω	0R5		RD2H	0	R	5	K
1 Ω	010		RD1P	0	1	0	K

Ex.2 When there are 3 effective digits (such as in high precision metal film resistors).

5.62k Ω	562 $\times 10^3$	5621	RD1/4SR	5	6	2	1	F
----------------	-------------------	------	---------	---	---	---	---	---

Mark No.	Description	Parts No.	Mark No.	Description	Parts No.
Ⓢ MOTHER BOARD ASSEMBLY					
(PWM1448 : PD-31/KU type)					
(PWM1449 : PD-8700/HEM, HB, SD and PD-8700-S/HEWM types)					
SEMICONDUCTORS					
Δ	IC20 REGULATOR IC	M5298P	C104	ELECTR.CAPACITOR	CEAS101M10
	IC101 PRE AMP IC	CXA1471S	C110	CERAMIC CAPACITOR	CKCYF103Z50
	IC151 SERVO IC	CXA1372S	C151-C153	ELECTR.CAPACITOR	CEAS101M10
Δ	IC201,IC202 POWER OP-AMP,IC	LA6520	C155	CERAMIC CAPACITOR	CKCYB182K50
	IC301 EFM DEMODULATION IC	CXD2500AQ	C156	CERAMIC CAPACITOR	CGCYX333K25
	Q101 TRANSISTOR	2SA854S	C157	CERAMIC CAPACITOR	CGCYX103K25
	Q321,Q351 TRANSISTOR	DTC124ES	C158,C159	CERAMIC CAPACITOR	CGCYX104K25
	Q391 TRANSISTOR	2SC1740S	C160	ELECTR. CAPACITOR	CEAS4R7M50
	Q406 TRANSISTOR	DTA124ES	C161	CERAMIC CAPACITOR	CGCYX104K25
			C162	ELECTR.CAPACITOR	CEAS010M50
Δ	D11-D14,D52 DIODE	11ES2	C163	CERAMIC CAPACITOR	CGCYX104K25
	D84 ZENNER DIODE	MTZJ18B	C164	CERAMIC CAPACITOR	CGCYX103K25
	D301 DIODE	1SS254	C167	CERAMIC CAPACITOR	CKCYF103Z50
	D391-D394 DIODE(PWM1448 only)	1SS254	C168	CERAMIC CAPACITOR	CGCYX333K25
	D395-D397 DIODE	1SS254	C169	CERAMIC CAPACITOR	CGCYX103K25
COILS					
	L391,L392 AXIAL INDUCTOR	LAUR22K	C170	CERAMIC CAPACITOR	CKCYB332K50
	L393,L394 AXIAL INDUCTOR	LAU010K	C171,C172	CERAMIC CAPACITOR	CKCYB472K50
CAPACITORS					
	C11,C13 CERAMIC CAPACITOR	CKCYF103Z50	C202,C207	CERAMIC CAPACITOR	CKCYF103Z50
	C15,C16 CERAMIC CAPACITOR	CKCYF103Z50	C212	CERAMIC CAPACITOR	CKCYB272K50
	C25 ELECTR. CAPACITOR	CEAS32M16	C216,C217	ELECTR.CAPACITOR	CEAS30M16
	C26 ELECTR. CAPACITOR	CEAS222M16	C301	CERAMIC CAPACITOR	CGCYX104K25
	C27 ELECTROLYTIC CAPACIT	CEAS471M6R3	C302	ELECTROLYTIC CAPACIT	CEAS471M6R3
	C28 ELECTR. CAPACITOR	CEAS101M10	C306	CERAMIC CAPACITOR	CKCYB152K50
	C52 ELECTR. CAPACITOR	CEAS101M35	C307	CERAMIC CAPACITOR	CGCYX473K25
	C60 ELECTR. CAPACITOR	CEAS010M50	C308	CERAMIC CAPACITOR	CGCYX103K25
	C101,C102 ELECTR. CAPACITOR	CEAS101M10	C309	ELECTR. CAPACITOR	CEAS4R7M50
	C103 CERAMIC CAPACITOR	COCC8200J50	C310	CERAMIC CAPACITOR	CKCYF103Z50
			C321	CERAMIC CAPACITOR	CGCYX104K25
			C324	CERAMIC CAPACITOR	CGCYX103Z50
			C361	CERAMIC CAPACITOR	CKCYF103Z50
			C362	CERAMIC CAPACITOR	CKCYB102K50
			C397	CERAMIC CAPACITOR	CKCYF103Z50
RESISTORS					
			VR102	VR	VRTB6VS223
			VR103	VR	VRTB6VS102
			VR151,VR152	VR	VRTB6VS223
				Other resistors	RD1/6PM□□□□

Mark No.	Description	Parts No.
OTHERS		
CN101	CONNECTOR	52045-1610
CN404	CONNECTOR(7P)	KPC7
JA301	OPTICAL OUTPUT JACK	TOTX178
JA391, JA392	JACK/12V	PKN1004 (PWM1448 only)
JA393	JACK	PKN1005

●OPERATE BOARD ASSEMBLY (PWZ2112)

SEMICONDUCTORS		
IC701	MICROCOMPUTER, IC	PD4329A
Q801, Q802	TRANSISTOR	2SD2144S
Q803, Q804	TRANSISTOR	2SB1296
Q805, Q806	TRANSISTOR	2SD2144S
Q807, Q809	TRANSISTOR	DTA124ES
Q810	TRANSISTOR	DTC124ES
D701-D714	DIODE	1SS254

SWITCHES

S701-S742	SWITCH	PSG1006
1-20, PGM. DELETE, CHECK, CLEAR, >20, RESERVE, REPEAT, TIME, RND, PEAK SEARCH, O/L, HI LITE SCAN, AUTO SPACE, COMPU, TIME FADE, ♪, ♫, ♬, ♯, STOP(□), PLAY(>)		

CAPACITORS

C701	ELECTR. CAPACITOR	CEAS330M16
C702-C714	AXIAL CAPACITOR	CKPUYB221K50

RESISTORS

All resistors RD1/6PM□□□□

OTHERS

PHOTO SENSOR UNIT		
V701	FL INDICATOR TUBE	GP1U50X
X701	CERAMIC RESONATOR	PEL1057 VSS1014

SW BOARD ASSEMBLY

SEMICONDUCTORS

D715	LED	PCX1018
------	-----	---------

SWITCHES

S743-S748	SWITCH	PSG1006
ON/STN BY, FADE IN(↖), FADE OUT(↘), ←, →, DISPLAY OFF		

S749		RSH1017
------	--	---------

RESISTORS

RT10	CARBON FILM RESISTOR	RD1/6PM103J
------	----------------------	-------------

HEADPHONE BOARD ASSEMBLY

SEMICONDUCTORS

IC501	OP-AMP, IC	M5218AL
-------	------------	---------

Mark No.	Description	Parts No.
CAPACITORS		
C803, C804	CERAMIC CAPACITOR	CKCYF103Z50
RESISTORS		
VR501	VARIABLE RESISTOR WITH MOTOR 20KB	PCS1006
Other resistors		RD1/6PM□□□□

JACK BOARD ASSEMBLY

COILS

L501-L503	AXIAL INDUCTOR	LAU010K
-----------	----------------	---------

CAPACITORS

C805-C807	CERAMIC CAPACITOR	CKCYF103Z50
-----------	-------------------	-------------

OTHERS

JA501	JACK	PKN1001
-------	------	---------

●AUDIO BOARD ASSEMBLY (PWZ2118)

SEMICONDUCTORS

IC801, IC802	D/A CONVERTER, IC	PD2026A
IC803	LOGIC IC	TC74HCU04AP
IC808, IC809	OP-AMP IC	NJM5532DD
IC901	REGULATOR IC	NJM78L12A
IC902	REGULATOR IC	NJM78L12A
IC903	REGULATOR IC	NJM7805FA

△ D802-D804, D806 DIODE

D901-D906	DIODE	1SS254 11E82
-----------	-------	-----------------

CAPACITORS

C801, C802	CERAMIC CAPACITOR	CCCH120J50
C805, C807	AUDIO FILM CAPACITOR	CFTXA104J50
C809, C811	AUDIO FILM CAPACITOR	CFTXA104J50
C812, C813	CERAMIC CAPACITOR	CCCH390J50
C819, C820	CERAMIC CAPACITOR	CCCH390J50

C821	AUDIO FILM CAPACITOR	CFTXA681J50
C822	AUDIO FILM CAPACITOR	CFTXA562J50
C824	ELECTR. CAPACITOR	CEAS470M50
C825	PL. STYRENE CAPACITOR	CQSA102J50
C828, C830	AUDIO FILM CAPACITOR	CFTXA104J50

C832, C834	AUDIO FILM CAPACITOR	CFTXA104J50
C835, C836	CERAMIC CAPACITOR	CCCH390J50
C839, C840	CERAMIC CAPACITOR	CCCH390J50
C841	AUDIO FILM CAPACITOR	CFTXA562J50
C842	AUDIO FILM CAPACITOR	CFTXA681J50

C843	ELECTR. CAPACITOR	CEAS470M50
C844-C846	PL. STYRENE CAPACITOR	CQSA102J50
C860, C861	ELECTR. CAPACITOR	CEAS330M16
C863, C864	CERAMIC CAPACITOR	CKCYF103Z50
C870	ELECTROLYTIC CAPACIT	CEAS471M6R3

C901, C902	ELECTR. CAPACITOR	CEAS102M25
C903, C904	ELECTR. CAPACITOR	CEAS471M16
C905	ELECTR. CAPACITOR	CEAS332M16
C906	ELECTR. CAPACITOR	CEAS102M16
C914-C919	CERAMIC CAPACITOR	CKCYF103Z50

Mark No.	Description	Parts No.
----------	-------------	-----------

RESISTORS

All resistors

RD1/6PM□□□□

OTHERS

CN801 CONNECTOR(9P)

KPC9

JA801 JACK

PKB1010

JA802 JACK

PKB1010

X801 XTAL RES (OSC)

PSS1006

S. TRANS BOARD ASSEMBLY

No electrical parts are supplied this assembly.

A. TRANS BOARD ASSEMBLY

No electrical parts are supplied this assembly.

4. PACKING

Mark No.	Description	Parts No.
1	
2	Cord with plug (mini plug)	PDE-319
3	Cord with plug	PDE1001
4	Operating instructions (English)	PRB1151
5	Remote control unit (CU-PD053)	PWW1069
6	Battery lid	PZN1001
7	Styrol protector F	PHA1163
8	Styrol protector R	PHA1164
9	CD Packing case	PHG1679
10	
11	Sheet	Z23-007
101	Mangan battery (R03, AAA)	

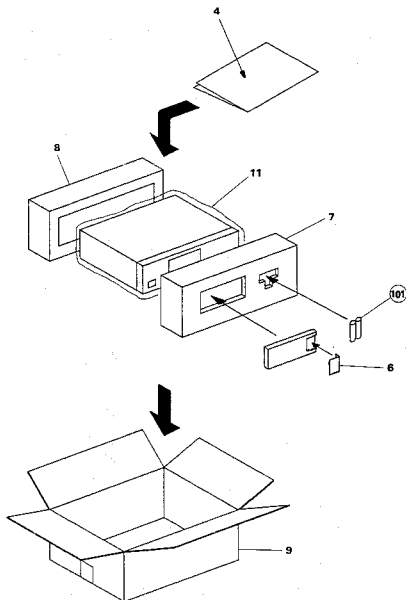
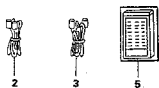

A
B
C
D
E
F

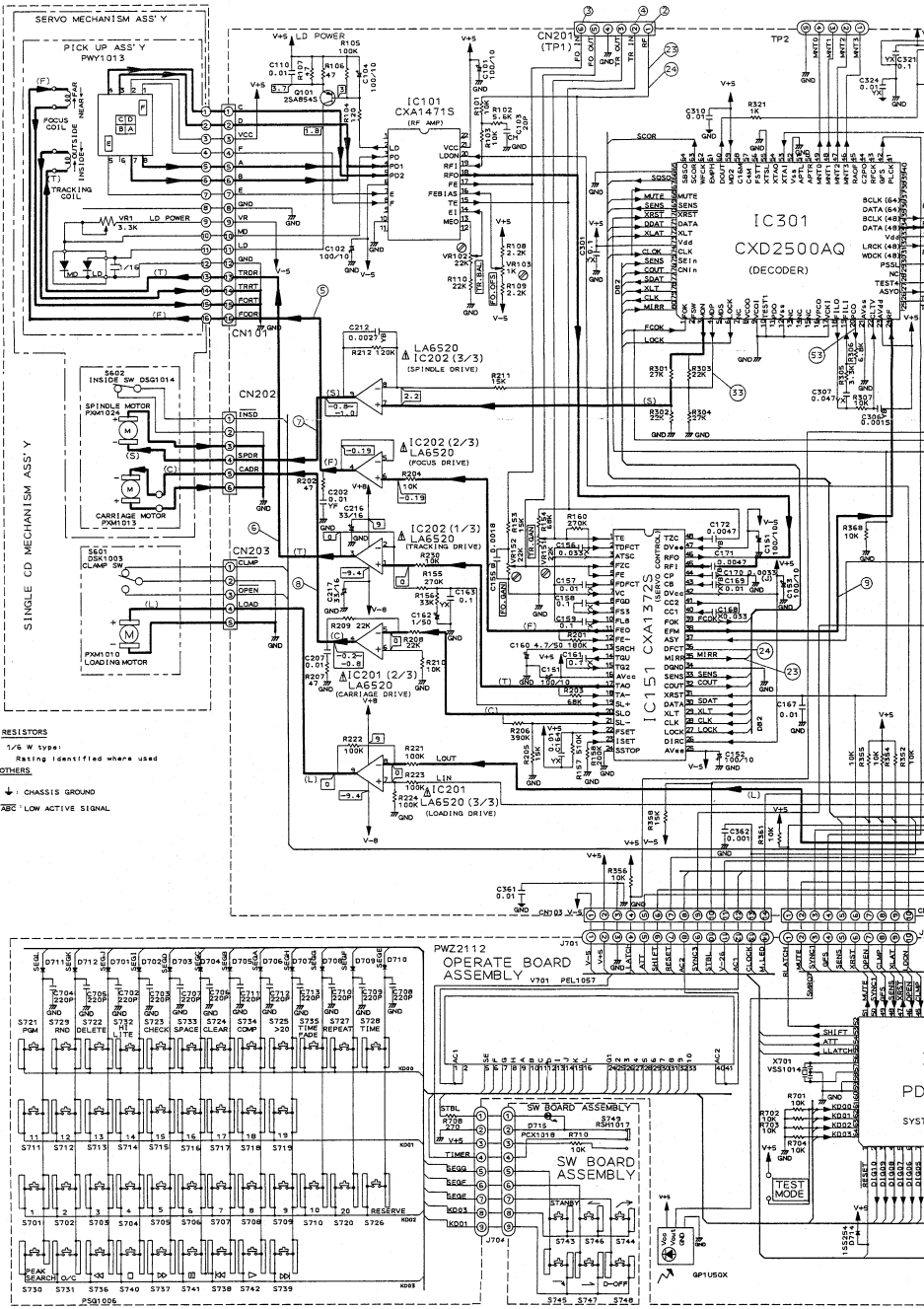

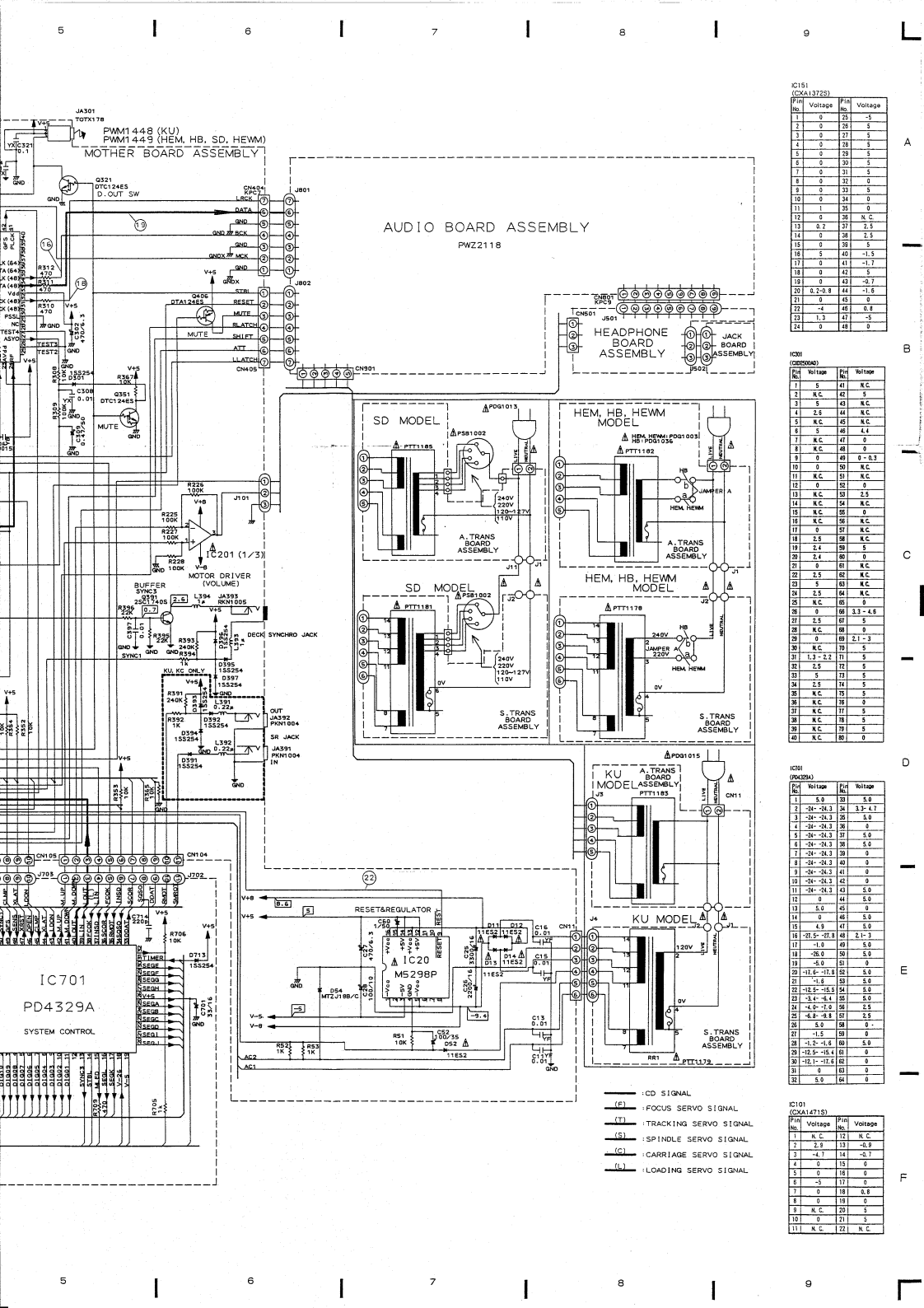

AUDIO BOARD ASSEMBLY
PWZ2118

(C151)
(CXAL13723)

Pin No.	Voltage	Pin No.	Voltage
1	0	23	-5
2	0	24	5
3	0	27	5
4	0	28	0
5	0	29	5
6	0	30	5
7	0	31	5
8	0	32	0
9	0	33	5
10	0	34	0
11	1	35	0
12	0	38	N.C.
13	0.2	37	2.5
14	0	38	1.5
15	0	39	5
16	5	40	-1.5
17	0	41	-1.7
18	0	42	5
19	0	43	-0.7
20	0.2-0.8	44	-1.6
21	0	45	0
22	-4	46	0.8
23	1.3	47	-5
24	0	48	0

(K20)
(C20C040)

Pin No.	Voltage	Pin No.	Voltage
1	5	41	N.C.
2	N.C.	42	5
3	5	43	N.C.
4	2.8	44	N.C.
5	N.C.	45	N.C.
6	5	46	1.4
7	N.C.	47	0
8	N.C.	48	0
9	5	49	0.3
10	0	50	N.C.
11	N.C.	51	N.C.
12	5	52	0
13	N.C.	53	2.5
14	N.C.	54	N.C.
15	N.C.	55	0
16	N.C.	56	N.C.
17	0	57	N.C.
18	2.5	58	N.C.
19	0	59	5
20	2.4	60	0
21	0	61	N.C.
22	2.5	62	N.C.
23	5	63	N.C.
24	2.5	64	N.C.
25	N.C.	65	5
26	5	66	3.3-4.5
27	2.5	67	5
28	N.C.	68	0
29	5	69	2.1-3
30	N.C.	70	5
31	1.3-2.2	71	5
32	2.5	72	5
33	5	73	5
34	2.5	74	5
35	N.C.	75	5
36	N.C.	76	0
37	N.C.	77	5
38	N.C.	78	5
39	N.C.	79	5
40	N.C.	80	0

(K20)
(P420A)

Pin No.	Voltage	Pin No.	Voltage	
1	5	34	3.3-4.7	
2	-24	-26.3	26	5.0
3	-24	-26.3	26	5.0
4	-24	-26.3	26	0
5	-24	-26.3	27	5.0
6	-24	-26.3	28	0
7	-24	-26.3	29	0
8	-24	-26.3	40	0
9	-24	-26.3	41	0
10	-24	-26.3	42	5.0
11	-24	-26.3	43	5.0
12	-4	44	0.0	
13	5	45	0	
14	0	46	5.0	
15	4.5	47	3.0	
16	-21.5	-71.8	21.3	
17	-1.0	49	5.0	
18	-20.0	50	5.0	
19	-5.0	51	0	
20	-11.6	-17.8	55	0.0
21	-11.5	-15.3	54	0.0
22	-3.4	-4.4	55	0.0
23	-14.0	-17.0	55	2.5
24	0	60	0	
25	4.2	-4.8	57	2.5
26	5.0	58	0	
27	5.0	59	0	
28	-1.2	-1.6	60	5.0
29	-12.5	-15.4	61	0
30	-12.1	-17.6	62	0
31	0	63	0	
32	5.0	64	0	

(K20)
(CXAL13715)

Pin No.	Voltage	Pin No.	Voltage
1	N.C.	13	N.C.
2	2.9	13	-0.9
3	-4.7	14	-0.7
4	0	15	0
5	0	16	0
6	-3	17	0
7	0	18	0.8
8	0	19	0
9	N.C.	20	5
10	0	21	5
11	N.C.	22	N.C.

- IC D SIGNAL
- (F) FOCUS SERVO SIGNAL
- (T) TRACKING SERVO SIGNAL
- (S) SPINDLE SERVO SIGNAL
- (C) CARRIAGE SERVO SIGNAL
- (L) LOADING SERVO SIGNAL

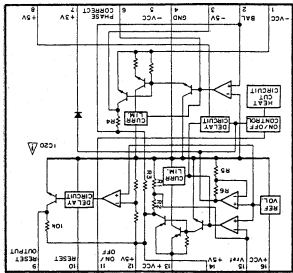

IC20
MCS298P

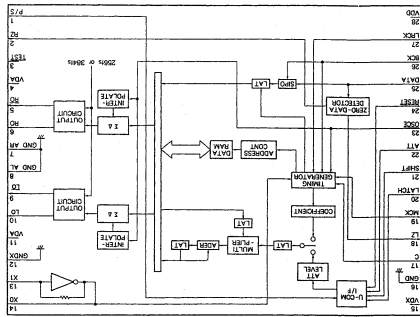

IC20
PD2026A

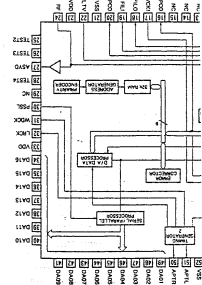

5. SCHEMATIC DIAGRAM AND P.C. BOARDS CONNECTION DIAGRAM

5.1 Wave Forms

Note: The encircled numbers denote measuring in the schematic diagram.

*1 50T - JUMP: After switching to the pause mode, press the manual search key.
*2 FOCUS - IN: Press the key without loading a disc.

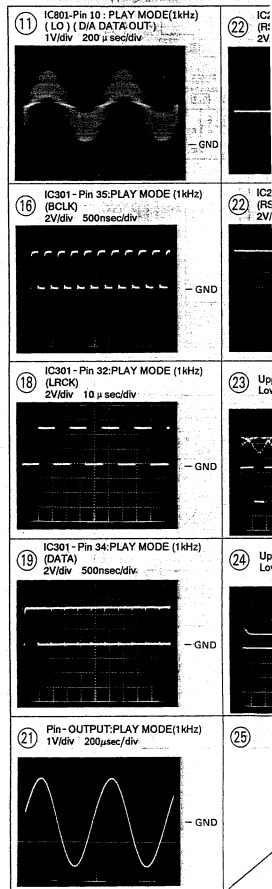
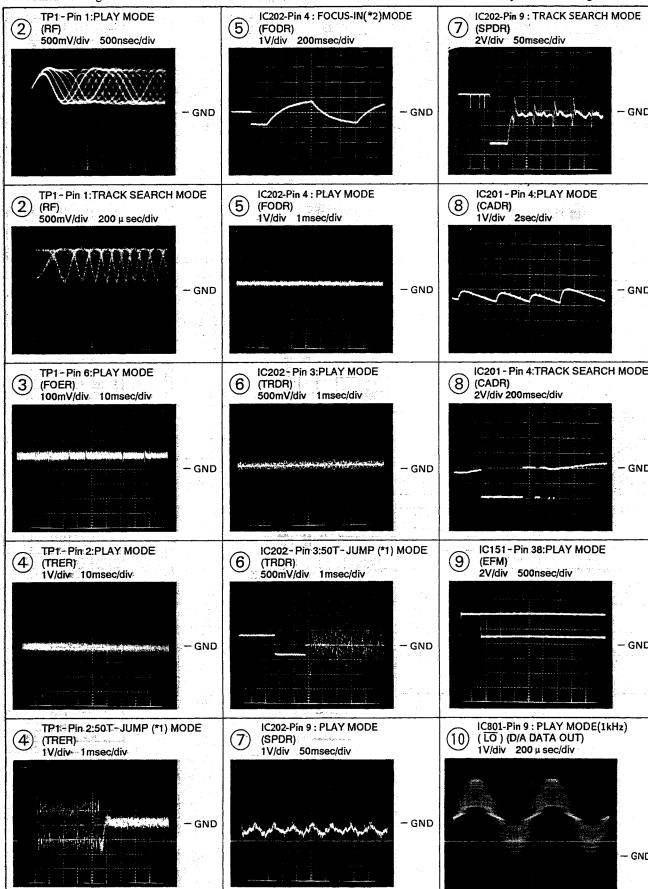

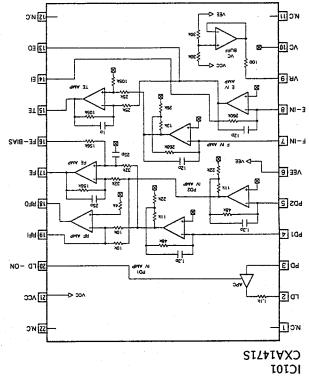
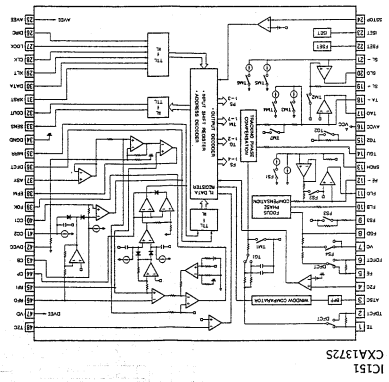
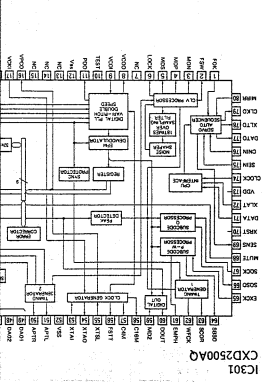

● IC BLOCK DIAGRAM

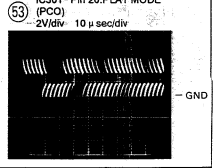
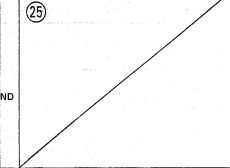
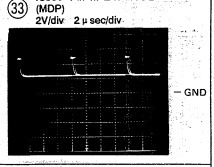
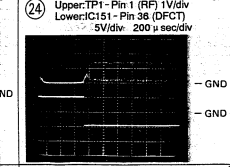
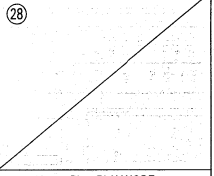
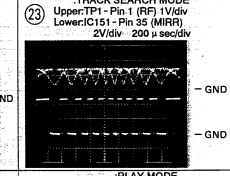
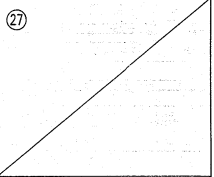
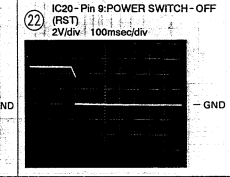
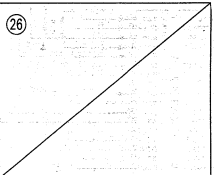
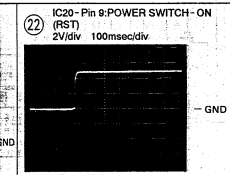

1. RESISTORS:
Indicated in R, 1/4W, 1/6W and 1/8W, ±5% tolerance unless otherwise noted
k; M; ±1% (G); ±2% (K); ±10% (M); ±20% tolerance.

2. CAPACITORS:
Indicated in capacity (μF)/voltage(V) unless otherwise noted; p: pF. Indication without voltage is 50V except electrolytic capacitor.

3. VOLTAGE, CURRENT:
□ : DC voltage (V) at play state.
□mA : DC current at play state.
Value in () is DC current at stop state.

4. OTHERS:
◆ : Signal route.
⊙ : Adjusting point.
The Δ mark found on some component parts indicates the importance of the safety factor of the part. Therefore, when replacing, be sure to use parts of identical designation.
※ marked capacitors and resistors have parts numbers.

This is the basic schematic diagram, but the actual circuit may vary due to improvements in design.

5. SWITCHES: (The underlined indicates the switch position)
SWITCH BOARD ASSEMBLY
S743: POWER ON-OFF

OPERATE BOARD ASSEMBLY

- | | |
|--------------|-------------------------|
| S701: 1 | S728: >00 |
| S702: 2 | S729: RESERVE |
| S703: 3 | S727: REPEAT |
| S704: 4 | S728: TIME |
| S705: 5 | S729: RND |
| S706: 6 | S730: PEAK SEARCH |
| S707: 7 | S731: O/L |
| S708: 8 | S732: HI LITE SCAN |
| S709: 9 | S733: AUTO SPACE |
| S710: 10 | S734: COMPU } EDIT |
| S711: 11 | S735: TIME FADE } EDIT |
| S712: 12 | S736: ◀ } MANUAL SEARCH |
| S713: 13 | S737: ▶ } MANUAL SEARCH |
| S714: 14 | S738: ⌘ } TRACK SEARCH |
| S715: 15 | S739: ⌘ } TRACK SEARCH |
| S716: 16 | S740: STOP(□) |
| S717: 17 | S741: PAUSE(⊞) |
| S718: 18 | S742: PLAY(▶) |
| S719: 19 | (S743: ON/STN BY) |
| S720: 20 | S744: FADE IN(↖) |
| S721: PGM | S745: FADE OUT(↗) |
| S722: DELETE | S746: ← } INDEX |
| S723: CHECK | S747: → } INDEX |
| S724: CLEAR | S748: DISPLAY OFF |

Line Voltage Selection (For HB, HEM and HEWM types)

Line voltage can be changed with the following steps.

1. Disconnect the AC power cord.
2. Remove the top cover.
3. Change the position of the jumper wire A as follows

Voltage	Jumper wire A position
220V	a
240V	b

4. Stick the line voltage label on the rear panel.

Parts No.	Description
AXX-193	220V label
AXX-192	240V label

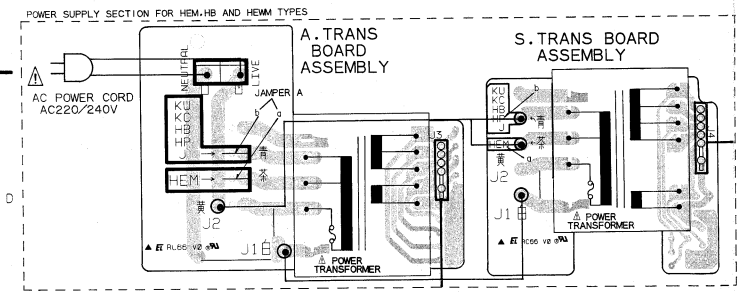
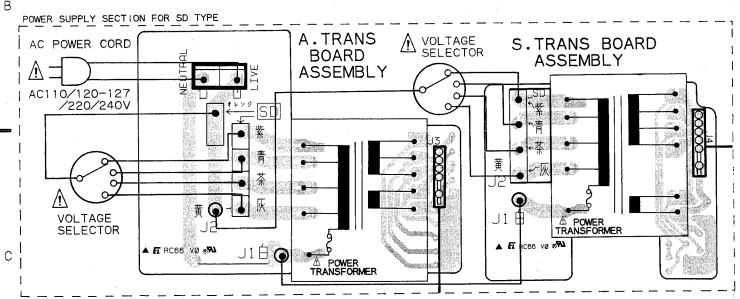
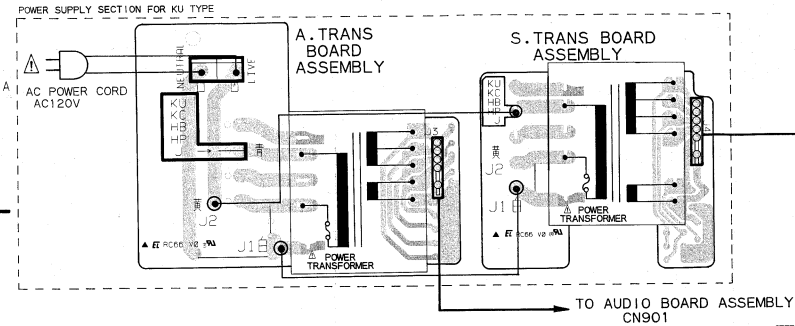

MOTHER BOARD ASSEMBLY
(PWM1448:KU TYPE)
(PWM1449:HEM,HB,SD AND HEWM TYPES)

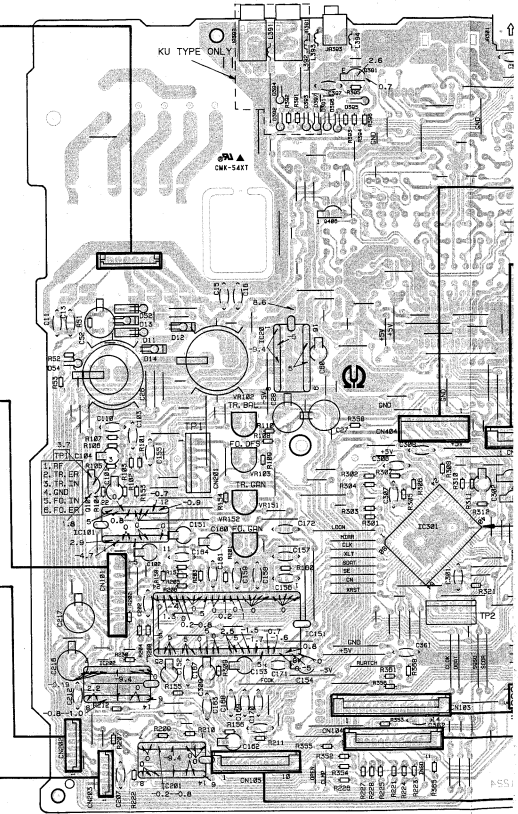
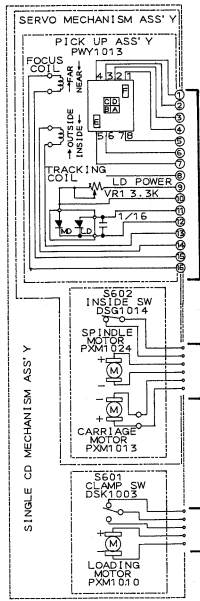

TYPES)

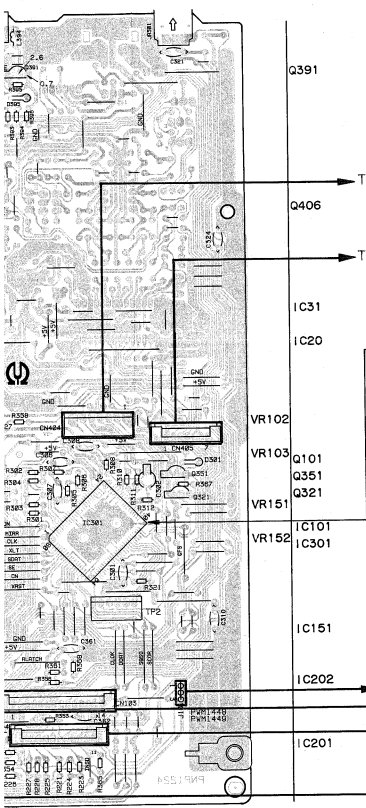

IC31
(CONTINUED)

Pin	Function	IC	Value
1	S	41	N.C.
2	N.C.	42	S
3	S	43	N.C.
4	2.5	44	N.C.
5	N.C.	45	N.C.
6	S	46	4.4
7	N.C.	47	0
8	N.C.	48	0
9	0	49	5 - 5.3
10	0	50	N.C.
11	N.C.	51	N.C.
12	0	52	0
13	N.C.	53	2.5
14	N.C.	54	N.C.
15	N.C.	55	0
16	N.C.	56	N.C.
17	0	57	N.C.
18	2.5	58	N.C.
19	2.4	59	0
20	2.4	60	0
21	0	61	N.C.
22	2.5	62	N.C.
23	0	63	N.C.
24	2.5	64	N.C.
25	N.C.	65	0
26	0	66	3.1 - 4.1
27	2.5	67	S
28	N.C.	68	0
29	0	69	2.1 - 3
30	N.C.	70	S
31	1.3 - 2.3	71	S
32	2.5	72	S
33	0	73	S
34	2.5	74	S
35	N.C.	75	0
36	N.C.	76	0
37	N.C.	77	S
38	N.C.	78	S
39	N.C.	79	S
40	N.C.	80	S

SW BOARD ASSEMBLY

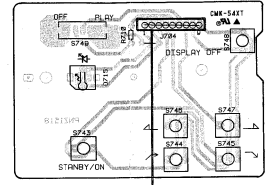

IC701
(CONTINUED)

Pin	Function	IC	Value
1	S	53	5.0
2	-24 -24.2	54	3.9 - 4.1
3	-24 -24.3	55	5.0
4	-24 -24.3	56	0
5	-24 -24.3	57	5.0
6	-24 -24.3	58	5.0
7	-24 -24.3	59	0
8	-24 -24.3	60	0
9	-24 -24.3	61	0
10	-24 -24.3	62	0
11	-24 -24.3	63	5.0
12	0	64	5.0
13	0	65	5.0
14	0	66	5.0
15	4.9	67	5.0
16	-23.2 -23.2	68	2.1 - 3
17	-1.4	69	5.0
18	-20.0	70	5.0
19	-6.0	71	0
20	-11.6 -11.8	72	5.0
21	-1.6	73	5.0
22	-15.5 -15.5	74	5.0
23	-3.4 -3.4	75	5.0
24	-4.0 -4.0	76	2.5
25	-4.8 -4.8	77	2.5
26	5.0	78	0
27	-1.5	79	0
28	1.2 -1.2	80	5.0
29	16.5 -16.5	81	0
30	-15.1 -15.1	82	0
31	5	83	0
32	5.0	84	0

OPERATE BOARD ASSEMBLY (PWZ2112)

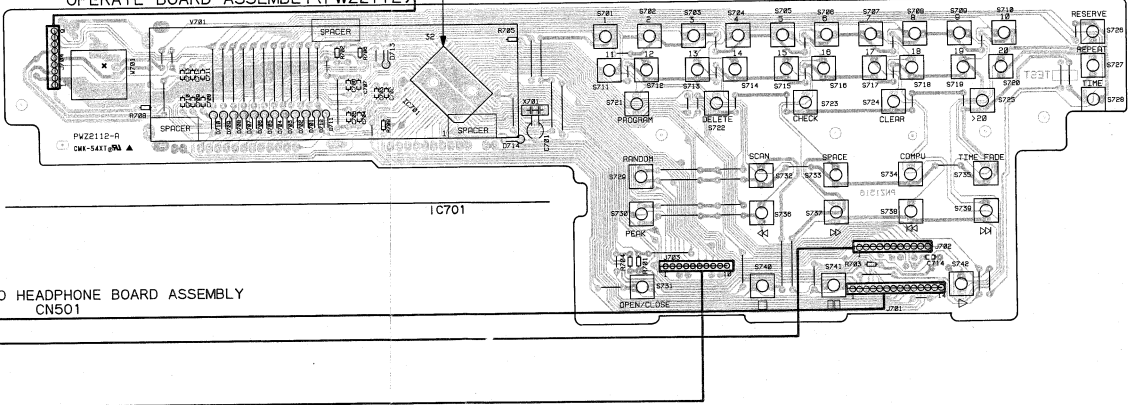

P.C.B. pattern diagram indication	Corresponding part symbol	Part name	P.C.B. pattern diagram indication	Corresponding part symbol	Part name
		Transistor			Ceramic capacitor
		FEF			Mylar capacitor
					Styrol capacitor
		Diode			Electrolytic capacitor (Non polarized)
		Zener diode			Electrolytic capacitor (Polarized)
		LED			Power capacitor
		Varactor			Semi-fixed resistor
		Tact switch			Resistor array
		Inductor			Resistor
		Coil			Resonator
		Transformer			Thermistor
		Filter			Filter

1. This P.C.B. connection diagram is viewed from the parts mounted side.
2. The parts which have been mounted on the board can be replaced with those shown with the corresponding wiring symbols listed in the above table.
3. The capacitor terminal marked with shows negative terminal.
4. The diode marked with shows cathode side.
5. The transistor terminal marked with shows emitter.

A
B
C
D

(TYPES)

This P.C.B. connection diagram is viewed from the foil side.

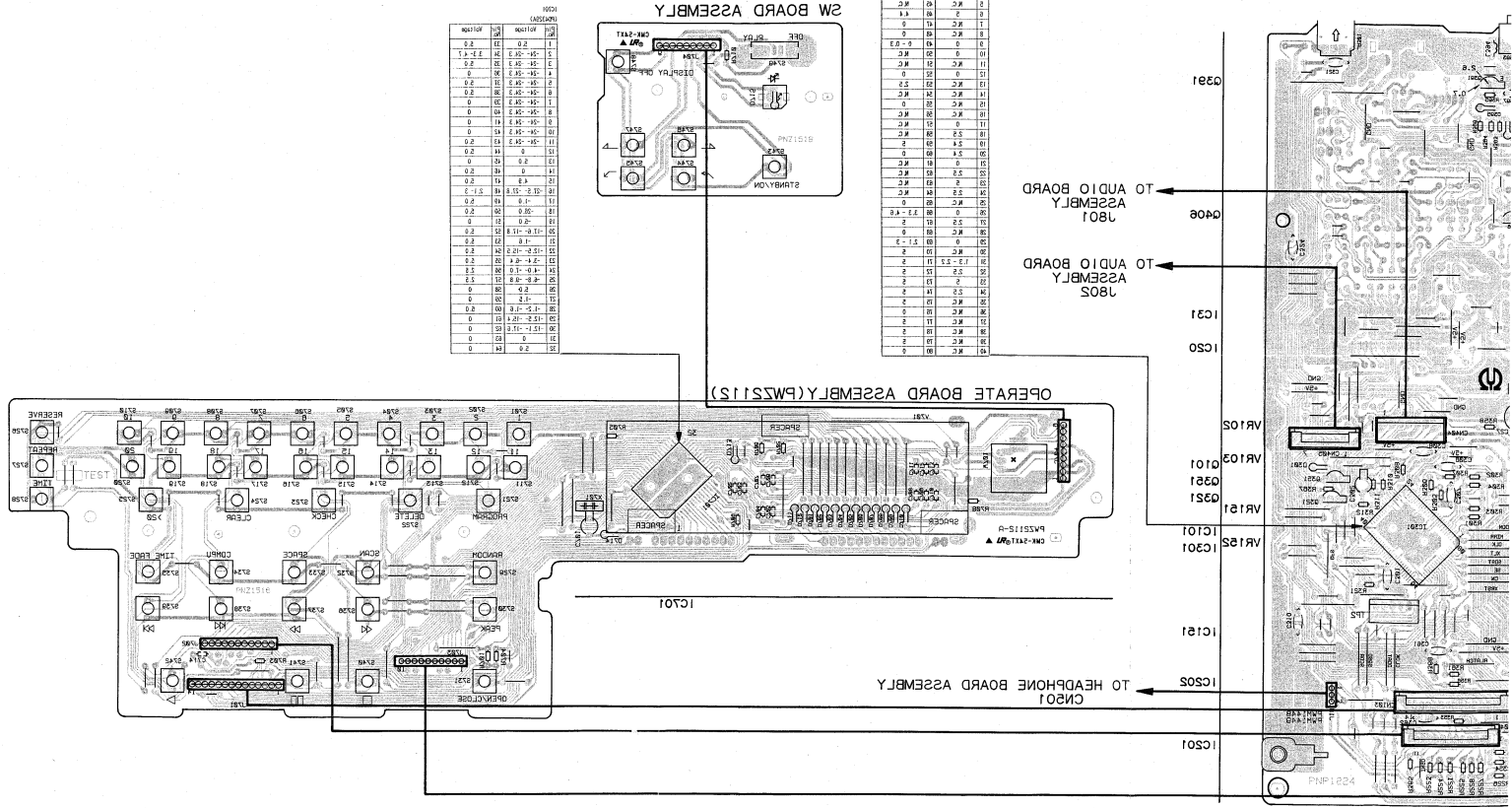

SW BOARD ASSEMBLY

PC	PC	PC	PC
1	1	1	1
2	2	2	2
3	3	3	3
4	4	4	4
5	5	5	5
6	6	6	6
7	7	7	7
8	8	8	8
9	9	9	9
10	10	10	10
11	11	11	11
12	12	12	12
13	13	13	13
14	14	14	14
15	15	15	15
16	16	16	16
17	17	17	17
18	18	18	18
19	19	19	19
20	20	20	20
21	21	21	21
22	22	22	22
23	23	23	23
24	24	24	24
25	25	25	25
26	26	26	26
27	27	27	27
28	28	28	28
29	29	29	29
30	30	30	30
31	31	31	31
32	32	32	32
33	33	33	33
34	34	34	34
35	35	35	35
36	36	36	36
37	37	37	37
38	38	38	38
39	39	39	39
40	40	40	40
41	41	41	41
42	42	42	42
43	43	43	43
44	44	44	44
45	45	45	45
46	46	46	46
47	47	47	47
48	48	48	48
49	49	49	49
50	50	50	50
51	51	51	51
52	52	52	52
53	53	53	53
54	54	54	54
55	55	55	55
56	56	56	56
57	57	57	57
58	58	58	58
59	59	59	59
60	60	60	60
61	61	61	61
62	62	62	62
63	63	63	63
64	64	64	64
65	65	65	65
66	66	66	66
67	67	67	67
68	68	68	68
69	69	69	69
70	70	70	70
71	71	71	71
72	72	72	72
73	73	73	73
74	74	74	74
75	75	75	75
76	76	76	76
77	77	77	77
78	78	78	78
79	79	79	79
80	80	80	80
81	81	81	81
82	82	82	82
83	83	83	83
84	84	84	84
85	85	85	85
86	86	86	86
87	87	87	87
88	88	88	88
89	89	89	89
90	90	90	90
91	91	91	91
92	92	92	92
93	93	93	93
94	94	94	94
95	95	95	95
96	96	96	96
97	97	97	97
98	98	98	98
99	99	99	99
100	100	100	100

OPERATE BOARD ASSEMBLY (PW2212)

PC	PC	PC	PC
1	1	1	1
2	2	2	2
3	3	3	3
4	4	4	4
5	5	5	5
6	6	6	6
7	7	7	7
8	8	8	8
9	9	9	9
10	10	10	10
11	11	11	11
12	12	12	12
13	13	13	13
14	14	14	14
15	15	15	15
16	16	16	16
17	17	17	17
18	18	18	18
19	19	19	19
20	20	20	20
21	21	21	21
22	22	22	22
23	23	23	23
24	24	24	24
25	25	25	25
26	26	26	26
27	27	27	27
28	28	28	28
29	29	29	29
30	30	30	30
31	31	31	31
32	32	32	32
33	33	33	33
34	34	34	34
35	35	35	35
36	36	36	36
37	37	37	37
38	38	38	38
39	39	39	39
40	40	40	40
41	41	41	41
42	42	42	42
43	43	43	43
44	44	44	44
45	45	45	45
46	46	46	46
47	47	47	47
48	48	48	48
49	49	49	49
50	50	50	50
51	51	51	51
52	52	52	52
53	53	53	53
54	54	54	54
55	55	55	55
56	56	56	56
57	57	57	57
58	58	58	58
59	59	59	59
60	60	60	60
61	61	61	61
62	62	62	62
63	63	63	63
64	64	64	64
65	65	65	65
66	66	66	66
67	67	67	67
68	68	68	68
69	69	69	69
70	70	70	70
71	71	71	71
72	72	72	72
73	73	73	73
74	74	74	74
75	75	75	75
76	76	76	76
77	77	77	77
78	78	78	78
79	79	79	79
80	80	80	80
81	81	81	81
82	82	82	82
83	83	83	83
84	84	84	84
85	85	85	85
86	86	86	86
87	87	87	87
88	88	88	88
89	89	89	89
90	90	90	90
91	91	91	91
92	92	92	92
93	93	93	93
94	94	94	94
95	95	95	95
96	96	96	96
97	97	97	97
98	98	98	98
99	99	99	99
100	100	100	100

MOTHER BOARD ASSEMBLY
 (PMM1448: KU TYPE)
 (PMM1449: HEM, HB, 2D AND HEMW TYPES)

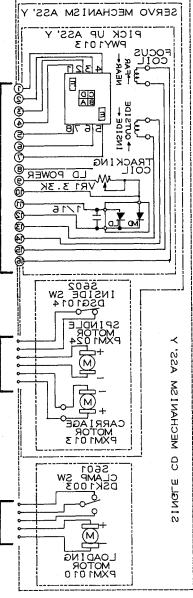
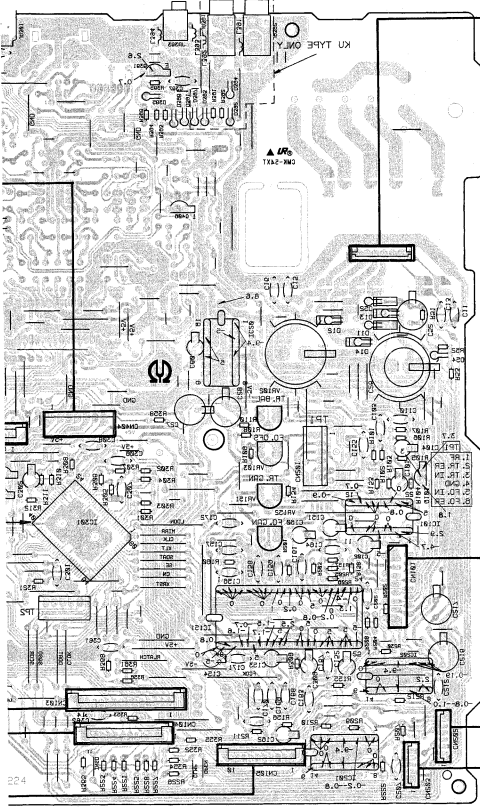

2181E CD MECHANISM ASSY

TO AUDIO BOARD ASSEMBLY
 CHAOT

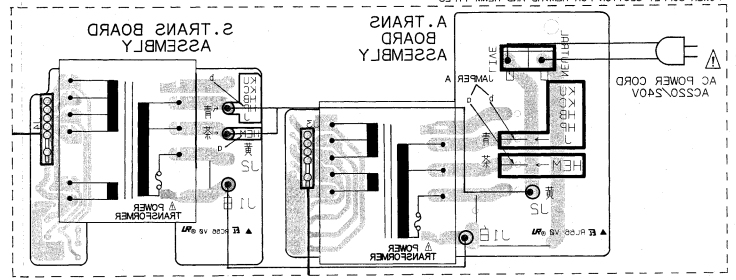

POWER SUPPLY SECTION FOR HEM, HB AND HEMW TYPES

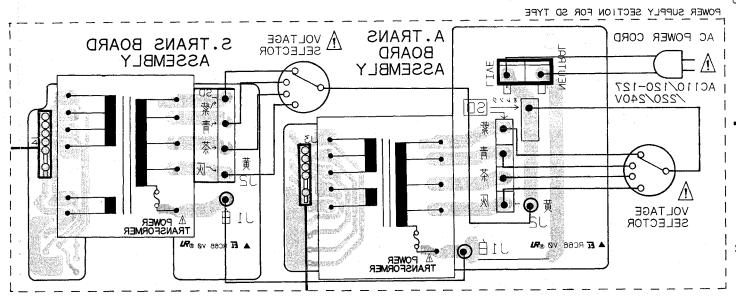

POWER SUPPLY SECTION FOR SD TYPE

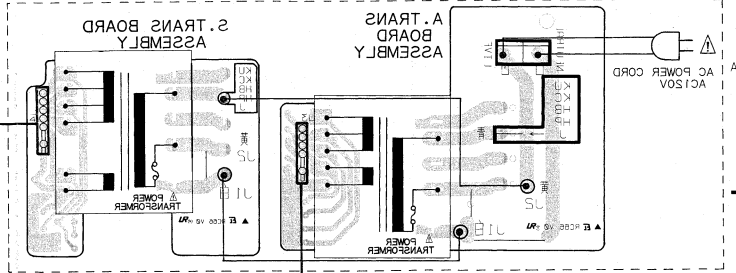

POWER SUPPLY SECTION FOR KU TYPE

This P.C.B. connection diagram is viewed from the foil side.

AUDIO BOARD ASSEMBLY (PW25118)

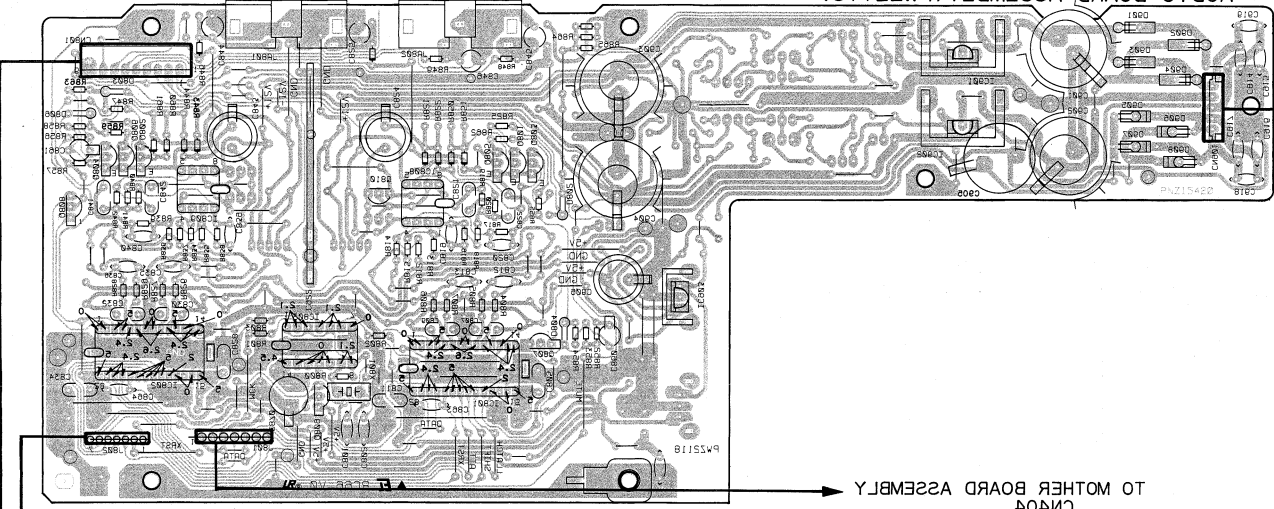

TO
MOTHER BOARD ASSEMBLY

TO MOTHER BOARD ASSEMBLY

IC901 IC905
IC902 IC906
IC903 IC907
IC904 IC908
IC909 IC909
IC910 IC910
IC911 IC911
IC912 IC912
IC913 IC913
IC914 IC914
IC915 IC915
IC916 IC916
IC917 IC917
IC918 IC918
IC920 IC920
IC921 IC921
IC922 IC922
IC923 IC923
IC924 IC924
IC925 IC925
IC926 IC926
IC927 IC927
IC928 IC928

TO MOTHER BOARD ASSEMBLY

JACK BOARD ASSEMBLY

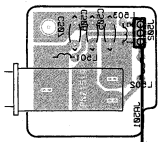

HEADPHONE BOARD ASSEMBLY

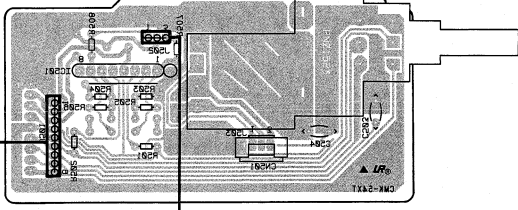

IC901

AUDIO BOARD ASSEMBLY (PWZ2118)

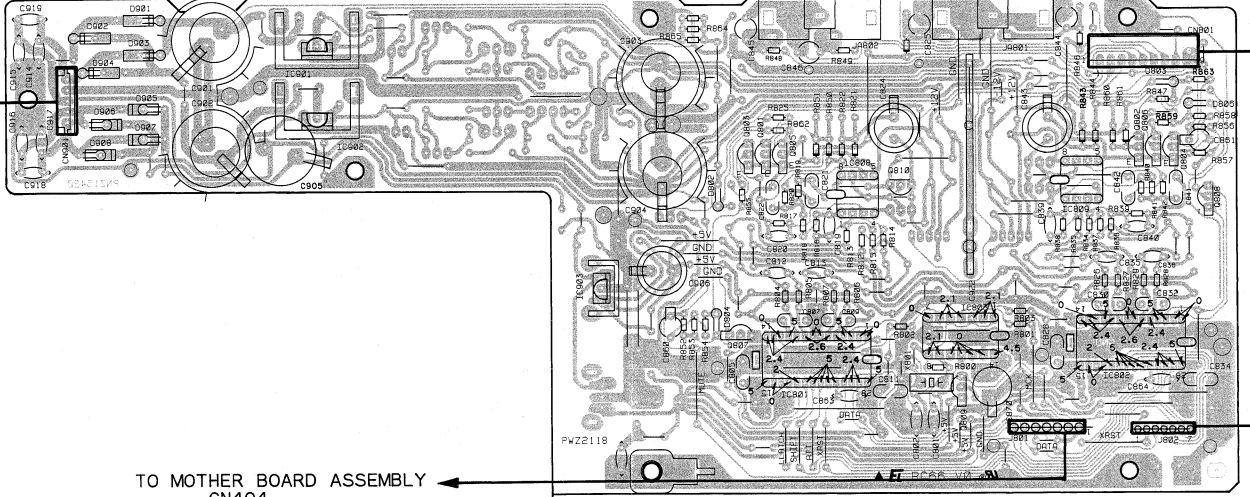

JACK BOARD ASSEMBLY

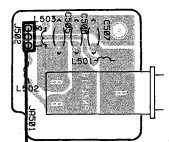

HEADPHONE BOARD ASSEMBLY

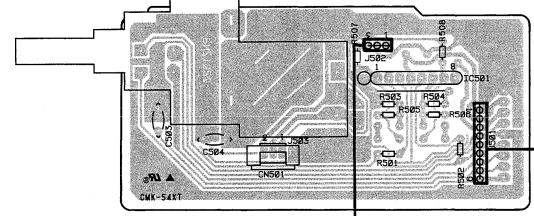

IC501

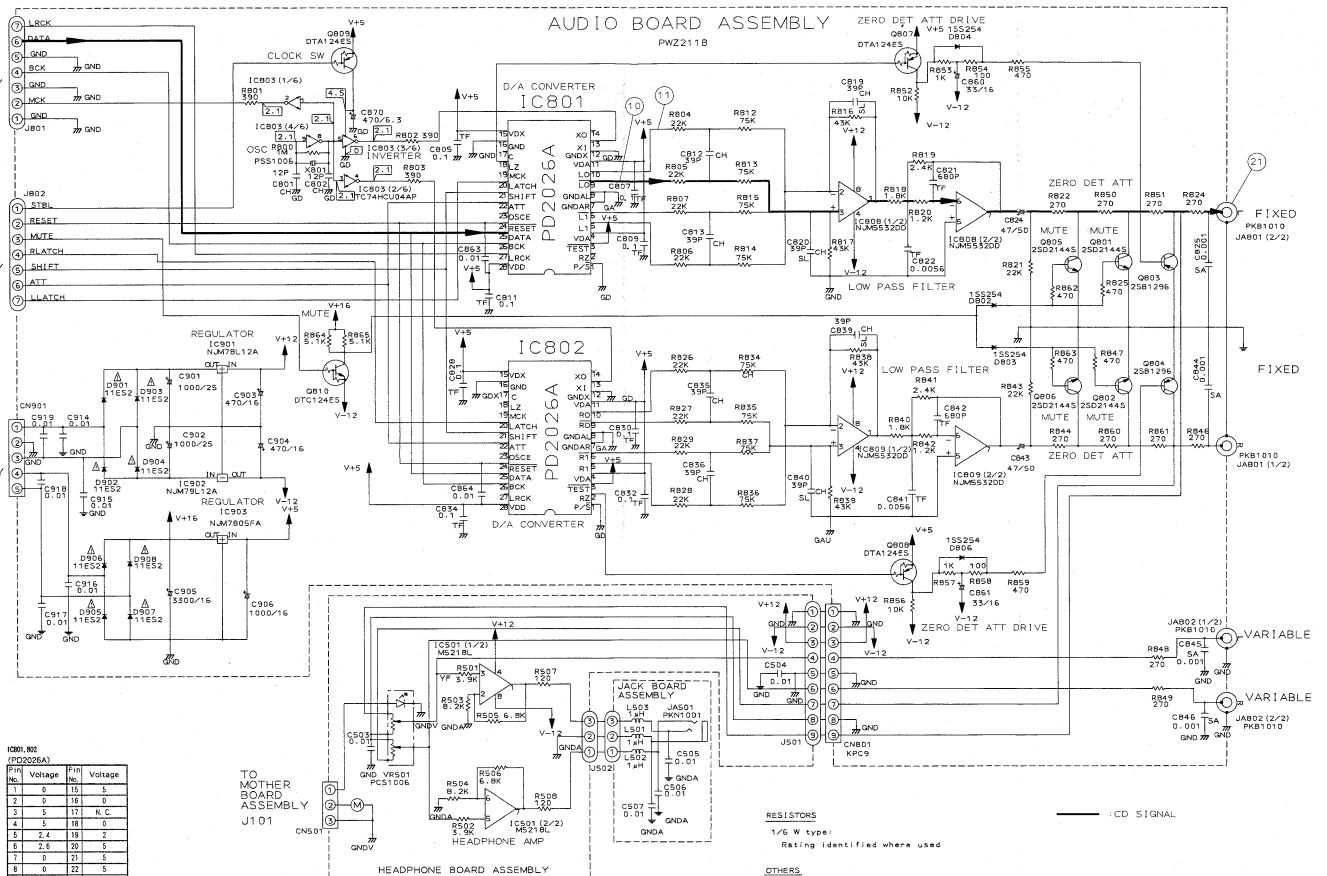

IC901, 902 (PD2025A)

Pin	Voltage	Pin	Voltage
1	0	15	5
2	0	16	0
3	5	17	N.C.
4	5	18	0
5	2.4	19	2
6	2.6	20	5
7	0	21	5
8	0	22	5
9	2.6	23	5
10	2.4	24	5
11	5	25	2.4
12	0	26	2.4
13	2.4	27	2.4
14	2.4	28	5

[Release from test mode]

Here is the procedure for releasing the test mode:

1. Press the STOP key and stop all operations.
2. Unplug the power cord from the AC socket.

[Operations of the keys in test mode]

Code	Key name	Function in test mode	Explanation
	PROGRAM	Focus servo close	<p>The laser diode is lit up and the focus actuator is lowered, then raised slowly and the focus servo is closed at the point where the objective lens is focused on the disc.</p> <p>With the player in this state, if you lightly rotate the stopped disc by hand, you can hear the sound the focus servo.</p> <p>If you can hear this sound, the focus servo is operating correctly. If you press this key with no disc mounted, the laser diode lights up, the focus actuator is pulled down, then the actuator is raised and lowered twice and returned to its original position.</p>
▷	PLAY	Spindle servo ON	<p>Starts the spindle motor in the clockwise direction and when the disc rotation reaches the prescribed speed (about 500 rpm at the inner periphery), sets the spindle servo in a closed loop.</p> <p>Be careful. Pressing this key when there is no disc mounted makes the spindle motor run at the maximum speed.</p> <p>If the focus servo does not go correctly into a closed loop or the laser light shines on the mirror section at the outermost periphery of the disc, the same symptom is occurred.</p>
□□	PAUSE	Tracking servo close/open	<p>Pressing this key when the focus servo and spindle servo are operating correctly in closed loops puts the tracking servo into a closed loop, displays the track number being played back and the elapsed time on the front panel, and outputs the playback signal.</p> <p>If the elapsed time is not displayed or not counted correctly or the audio is not played back correctly, it may be that the laser is shining on the section with no sound recorded at the outer edge of the disc, that something is out of adjustment, or that there is some other problem.</p> <p>This key is a toggle key and open/close the tracking servo alternately. This key has no effect if no disc is mounted.</p>

Code	Key name	Function In test mode	Explanation
◀◀	MANUAL SEARCH REV	Carriage reverse (inwards)	Moves the pickup position toward the inner diameter of the disc. When this key is pressed with the tracking servo in a closed loop, the tracking servo automatically goes into an open loop. Since the motor does not automatically stop at the mechanical end point in test mode, be careful with this operation.
▶▶	MANUAL SEARCH FWD	Carriage forward (outwards)	Moves the pickup position toward the outer diameter of the disc. When this key is pressed with the tracking servo in a closed loop, the tracking servo automatically goes into an open loop. Since the motor does not automatically stop at the mechanical end point in test mode, be careful with this operation.
□	STOP	Stop	Switches off all the servos and initialized. The pickup remains where it was when this key was pressed.
△	OPEN/CLOSE	Disc tray open/close	Open/close the disc tray. This key is a toggle key and open/close tray alternately. Pressing this key when the disc is turning stops the disc, then opens the tray. This key operation does not affect the position of the pickup.

[How to play back a disc in test mode]

In test mode, since the servos operate independently, playing back a disc requires that you operate the keys in the correct order to close the servos.

Here is the key operation sequence for playing back a disc in test mode.

PROGRAM	Lights up the laser diode and closes the focus servo.
↓	
PLAY ▶	Starts the spindle motor and closes the spindle servo.
↓	
PAUSE ⏸	Closes the tracking servo.

Wait at least 2-3 seconds between each of these operations.

1. Focus Offset Adjustment

<ul style="list-style-type: none"> ● Objective ● Symptom when out of adjustment 	Sets the DC offset for the focus error amp. The model does not focus in and the RF signal is dirty.		
<ul style="list-style-type: none"> ● Measurement instrument connections 	Connect the oscilloscope to TP1, Pin 6 (FCS. ERR) [Settings] 5 mV/division 10 ms/division DC mode	<ul style="list-style-type: none"> ● Player state ● Adjustment location ● Disc 	Test mode, stopped (just the Power switch on) VR103 (FCS. OFS) None needed

[Procedure]

Adjust VR103 (FCS. OFS) so that the DC voltage at TP1, Pin 6 (FCS. ERR) is -150 ± 50 mV.

2. Grating Adjustment

● Objective	To align the tracking error generation laser beam spots to the optimum angle on the track.		
● Symptom when out of adjustment	Play does not start, track search is impossible, tracks are skipped.		
● Measurement instrument connections	Connect the oscilloscope to TP1, Pin 2 (TRK. ERR) via a low pass filter. (See Figure 2)	● Player state	Test mode, focus and spindle servos closed and tracking servo open
	[Settings] 50 mV/division 5 ms/division DC mode	● Adjustment location	Pickup grating adjustment slit
		● Disc	12-cm disc. (YEDS-7 can not be used.)

[Procedure]

1. Move the pickup to the outer edge of the disc with the MANUAL SEARCH FWD \triangleright or REV \triangleleft key.
2. Press the PROGRAM key, then the PLAY \triangleright key in that order to close the focus servo then the spindle servo.
3. Insert an ordinary screwdriver into the grating adjustment slit and adjust the grating to find the null point. For more details, see the next page.
4. If you slowly turn the screwdriver clockwise from the null point, the amplitude of the wave gradually increases, then if you continue turning the screwdriver, the amplitude of the wave becomes smaller again. Turn the screwdriver clockwise from the null point and set the grating to the first point where the wave amplitude reaches its maximum.

Reference : Figure 3 shows the relation between the angle of the tracking beam with the track and the waveform.

Note : The amplitude of the tracking error signal is about 3 Vp-p (when a $39\text{ k}\Omega + 0.001\ \mu\text{F}$ low pass filter is used). If this amplitude is extremely small (2 Vp-p or less), the objective lens or the pickup malfunction may be the cause. If the difference between the amplitude of the error signal at the innermost edge and outermost edge of the disc is more than 10%, the grating is not adjusted to the optimum point, so adjust it again.

5. Return the pickup to more or less midway across the disc with the MANUAL SEARCH REV \triangleleft key, press the PAUSE \square key and double check that the track number and elapsed time are displayed on the front panel. If they are not displayed at this time or the elapsed time changes irregularly, double check the null point and adjust the grating again.

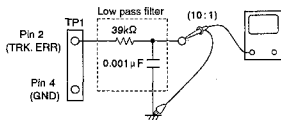
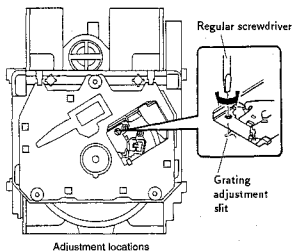

Figure 2



[How to find the null point]

When you insert the regular screwdriver into the slit for the grating adjustment and change the grating angle, the amplitude of the tracking error signal at TP1, Pin 2 changes. Within the range for the grating, there are five or six locations where the amplitude of the wave reaches a minimum. Of these five or six locations, there is only one at which the envelope of the waveform is smooth. This location is where the three laser beams divided by the grating are all right above the same track. (See Figure 3.)

This point is called the null point. When adjusting the grating, this null point is found and used as the reference position.

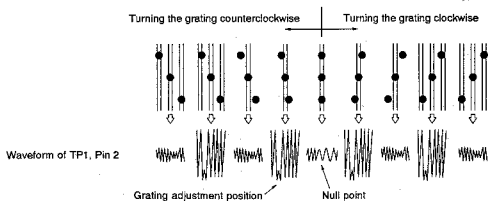
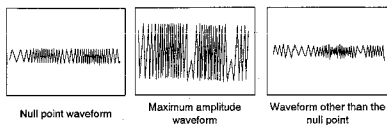

Figure 3



3. Tracking Error Balance Adjustment

● Objective	To correct for the variation in the sensitivity of the tracking photodiode.		
● Symptom when out of adjustment	Play does not start or track search is impossible.		
● Measurement instrument connections	Connect the oscilloscope to TP1, Pin 2 (TRK. ERR). This connection may be via a low pass filter.	● Player state	Test mode, focus and spindle servos closed and tracking servo open
	[Settings] 50 mV/division 5 ms/division DC mode	● Adjustment location	VR102 (TRK. BAL)
		● Disc	YEDS-7

[Procedure]

1. Move the pickup to midway across the disc (R=35 mm) with the MANUAL SEARCH FWD \triangleright or REV \triangleleft key.
2. Press the PROGRAM key, then the PLAY \triangleright key in that order to close the focus servo then the spindle servo.
3. Line up the bright line (ground) at the center of the oscilloscope screen and put the oscilloscope into DC mode.
4. Adjust VR102 (TRK. BAL) so that the positive amplitude and negative amplitude of the tracking error signal at TP1, Pin 2 (TRK. ERR) are the same (in other words, so that there is no DC component).

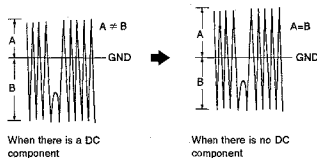

4. Pickup Radial/Tangential Tilt Adjustment

● Objective	To adjust the angle of the pickup relative to the disc so that the laser beams are shone straight down into the disc for the best read out of the RF signals.		
● Symptom when out of adjustment	Sound broken; some discs can be played but not others.		
● Measurement instrument connections	Connect the oscilloscope to TPI, Pin 1 (RF). [Settings] 20 mV/division 200 ns/division AC mode	● Player state ● Adjustment location ● Disc	Test mode, play Pickup radial tilt adjustment screw and tangential tilt adjustment screw 12-cm disc. (YEDS-7 can not be used.)

[Procedure]

1. Press the MANUAL SEARCH FWD >> or REV << key so that the radial/tangential tilt screws can be adjusted. Press the PROGRAM key, the PLAY > key, then the PAUSE || key in that order to close the focus servo then the spindle servo and put the player into play mode.
2. First, adjust the radial tilt adjustment screw with a Phillips screwdriver so that the eye pattern (the diamond shape at the center of the RF signal) can be seen the most clearly.
3. Next, adjust the tangential tilt adjustment screw with a Phillips screwdriver so that the eye pattern (the diamond shape at the center of the RF signal) can be seen the most clearly (Figure 5).
4. Adjust the radial tilt adjustment screw and the tangential tilt adjustment screw again so that the eye pattern can be seen the most clearly. As necessary, adjust the two screws alternately so that the eye pattern can be seen the most clearly.

Note: Radial and tangential mean the directions relative to the disc shown in Figure 4.

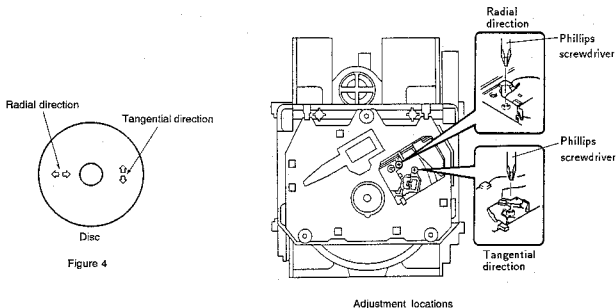

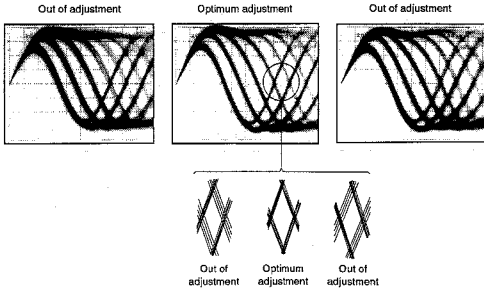

Figure 5 Eye pattern

5. RF Level Adjustment

● Objective	To optimize the playback RF signal amplitude		
● Symptom when out of adjustment	No play or no search		
● Measurement instrument connections	Connect the oscilloscope to TP1, Pin 1 (RF).	● Player state	Test mode, play
	[Settings] 50 mV/division 10 ms/division AC mode	● Adjustment location	VR1(laser power)
		● Disc	YEDS-7
[Procedure]			
<ol style="list-style-type: none"> 1. Move the pickup to midway across the disc (R=35 mm) with the MANUAL SEARCH FWD ▷▷ or REV ◁◁ key, then press the PROGRAM key, then the PLAY ▷ key in that order to close the respective servos and put the player into play mode. 2. Adjust VR1 (laser power) so that the RF signal amplitude is $1.2 \text{ V}_{p-p} \pm 0.1 \text{ V}$. 			

6. Focus Servo Loop Gain Adjustment

● Objective	To optimize the focus servo loop gain.		
● Symptom when out of adjustment	Playback does not start or focus actuator noisy.		
● Measurement instrument connections	See figure 6. [Settings] CH1 CH2 20 mV/division 5 mV/division X-Y mode	● Player state ● Adjustment location ● Disc	Test mode, play VR152 (FCS. GAN) YEDS-7

[Procedure]

1. Set the AF generator output to 1.2 kHz and 1 V_{p-p}.
2. Press the MANUAL SEARCH FWD $\triangleright\triangleright$ or REV $\triangleleft\triangleleft$ key to move the pickup to halfway across the disc (R=35 mm), then press the PROGRAM key, the PLAY \triangleright key, then the PAUSE $\square\square$ key in that order to close the corresponding servos and put the player into play mode.
3. Adjust VR152 (FCS. GAN) so that the Lissajous waveform is symmetrical about the X axis and the Y axis.

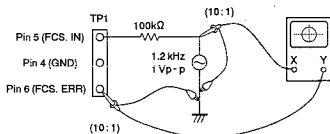
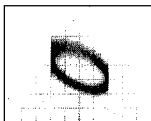
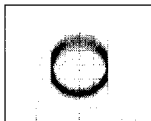

Figure 6

Focus Gain Adjustment



Higher gain



Optimum gain

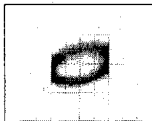

Lower gain

7. Tracking Servo Loop Gain Adjustment

● Objective	To optimize the tracking servo loop gain.		
● Symptom when out of adjustment	Playback does not start, during searches the actuator is noisy, or tracks are skipped.		
● Measurement instrument connections	See Figure 7.	● Player state	Test mode, play
	[Settings] CH1 50 mV/division X-Y mode	● Adjustment location ● Disc	VR151 (TRK. GAN) YEDS-7

[Procedure]

1. Set the AF generator output to 1.2 kHz and 2 V_{p-p}.
2. Press the MANUAL SEARCH FWD \triangleright or REV \triangleleft key to move the pickup to halfway across the disc (R=35 mm), then press the PROGRAM key, the PLAY \triangleright key, then the PAUSE \square key in that order to close the corresponding servos and put the player into play mode.
3. Adjust VR151 (TRK. GAN) so that the Lissajous waveform is symmetrical about the X axis and the Y axis.

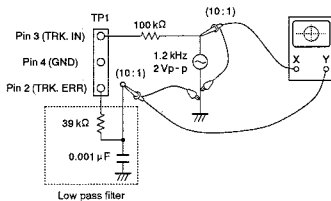
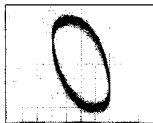
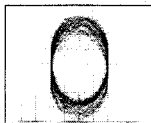

Figure 7

Tracking Gain Adjustment



Higher gain



Optimum gain

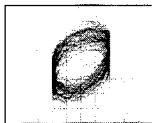

Lower gain

8. Focus Error Signal (Focus S Curve) Verification

● Objective	To judge whether the pickup is ok or not by observing the focus error signal. The pickup is judged from the amplitude of the tracking error signal (as discussed in the section on adjusting the tracking error balance) and the waveform for the focus error signal.		
● Symptom when out of adjustment			
● Measurement instrument connections	Connect the oscilloscope to TPI, Pin 6 (FCS. ERR). [Settings] 100 mV/division 5 ms/division. DC mode	● Player state ● Adjustment location ● Disc	Test mode, stop None YEDS-7

[Procedure]

1. Connect TPI Pin 5 to ground.
2. Mount the disc.
3. While watching the oscilloscope screen, press the PROGRAM key and observe the waveform in Figure 8 for a moment. Verify that the amplitude is at least $2.5 V_{p-p}$ and that the positive and negative amplitude are about equal. Since the waveform is only output for a moment when the PROGRAM key is pressed, press this key over and over until you have checked the waveform.

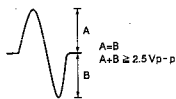

Figure 8

[Judging the pickup]

Do not judge the pickup until all the adjustments have been made correctly. In the following cases, there may be something wrong with the pickup.

1. The tracking error signal amplitude is extremely small (less than $2 V_{p-p}$).
2. The focus error signal amplitude is extremely small (less than $2.5 V_{p-p}$).
3. The positive and negative amplitudes of the focus error signal are extremely asymmetrical (2 : 1 ratio or more).
4. The RF signal is too small (less than $0.8 V_{p-p}$) and even if VR1 (laser power) is adjusted, the RF signal can not be brought up to the standard level.

7. FL INFORMATION

EXTERNAL VIEWS

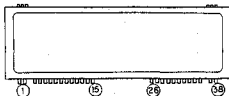

DISPLAY PATTERN ANODE GRID ASSIGNMENT

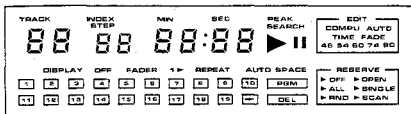

ANODE GRID ASSIGNMENT AND PIN ASSIGNMENT

	G1	G2	G3	G4	G5	G6	G7	G8	G9	G10
a	a	a	a	a	a	a	a	/	▶	a
b	b	b	b	b	b	b	b	SCAN		b
c	c	c	c	c	c	c	c	▶ OPEN	54	c
d	d	d	d	d	d	d	d	reserve	46	d
e	e	e	e	e	e	e	e	▶ (single)	60	e
f	f	f	f	f	f	f	f	▶ (scan)	90	f
g	g	g	g	g	g	g	g	SINGLE	74	g
h	/	DISPLAY	OFF	FADER	1 ▶	REPEAT	AUTO SPACE	▶ OFF	TIME FADE	/
i	1	2	4	5	7	8	10	▶ (ALL)	AUTO	/
j	TRACK	3	STEP	6	/	9	PGM	ALL	EDIT	:
k	/	12	INDEX	15	MIN	18	▶	▶ (RND)	PEAK SEARCH	SEC
l	11	13	14	16	17	19	DEL	RND	COMPU	/

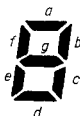

PIN ASSIGNMENT

Pin No.	1	2	3	4	5	6	7	8	9	10	11	12	13
Assignment	F	F	NP	e	f	g	h	a	b	c	d	i	j
Pin No.	14	15	16	17	18	19	20	21	22	23	24	25	26
Assignment	k	l	NP	NP	NP	NP	NP	NP	NP	NP	NP	NP	G1
Pin No.	27	28	29	30	31	32	33	34	35	36	37	38	
Assignment	G2	G3	G4	G5	G6	G7	G8	G9	G10	NP	F	F	

F: Filament G1-G10: Grid a-l: Anode NP: No pin

8. FOR PD-8700/HEM, HB, SD AND PD-8700-S/HEWM TYPES

NOTES:

- Parts without part number cannot be supplied.
- Parts marked by "⊗" are not always kept in stock. Their delivery time may be longer than usual or they may be unavailable.
- The ⊗ mark found on some component parts indicates the importance of the safety factor of the part. Therefore, when replacing, be sure to use parts of identical designation.

CONTRAST OF MISCELLANEOUS PARTS

The PD-8700/HEM, HB, SD and PD-8700-S/HEWM types are the same as the PD-31/KU type with the exception of the following sections.

Mark	Symbol & Description	Part No.					Remarks
		PD-31/KU	PD-8700/HEM	PD-8700/HB	PD-8700/SD	PD-8700-S/HEWM	
⊗	Mother board assembly	PWM1448	PWM1449	PWM1449	PWM1449	PWM1449	*1
⊗	S trans board assembly	Non supply	Non supply	Non supply	Non supply	Non supply	*2
⊗	A trans board assembly	Non supply	Non supply	Non supply	Non supply	Non supply	*2
⊗	AC power cord	PDG1015	PDG1003	PDG1036	PDG1013	PDG1003	
⊗	Power transformer S(AC120V)	PTT1179					
⊗	Power transformer S(AC220,240V)		PTT1178	PTT1178		PTT1178	
⊗	Power transformer S (AC110, 120-127, 220, 240V)				PTT1181		
⊗	Power transformer A(AC120V)	PTT1183					
⊗	Power transformer A(AC220,240V)		PTT1182	PTT1182		PTT1182	
⊗	Power transformer A (AC110, 120-127, 220, 240V)				PTT1185		
⊗	Voltage selector				PSB1002		
⊗	Strain relief	CM-22C	CM-22B	CM-22B		CM-22B	
⊗	Cord with plug (mini plug)	PDE-310					
	Front panel assembly	PEA1164	PEA1132	PEA1132	PEA1132	PEA1152	
	Control panel	PNW1948	PNW1948	PNW1948	PNW1948	PNW2009	
	Power button	PAC1569	PAC1569	PAC1569	PAC1569	PAC1590	
	Select button	PAC1570	PAC1570	PAC1570	PAC1570	PAC1591	
	Play button	PAC1571	PAC1571	PAC1571	PAC1571	PAC1592	
	Search button	PAC1572	PAC1572	PAC1572	PAC1572	PAC1593	
	Headphone knob S					PAC1597	
	Knob C	RAC1608	RAC1608	RAC1608	RAC1608		
	Slide knob	RAC1428	RAC1428	RAC1428	RAC1428	PAC1599	
	Tray panel	PNW2025	PNW1949	PNW1949	PNW1949	PNW2011	
	Display window	PAM1503	PAM1488	PAM1488	PAM1503	PAM1488	
	Bonnet	PYY1148	PYY1148	PYY1148	PYY1148	PYY1154	
	CD packing case	PHG1679	PHG1678	PHG1678	PHG1678	PHG1680	For packing

*1 : As to the parts list of the Mother board assembly, refer to page 12.

*2 : These assemblies are the same as the PD-31/KU type for the service supply parts.

Mark	Symbol & Description	Part No.					Remarks
		PD-31/KU	PD-8700/HEM	PD-8700/HB	PD-8700/SD	PD-8700-S/HEWM	
	Operating instructions(English)	PRB1151		PRB1139	PRB1139		
	Operating instructions (English/French)		PRE1142				
	Operating instructions (German/Italian/Dutch/Swedish/Spanish/Portuguese)		PRF1042			PRF1042	
	Operating instructions (Spanish)				PRC1035		

9. FOR PD-7700/KU, KC, HEM, HB, SD, HPW AND PD-7700-S/HEWM TYPES

9.1 CONTRAST OF MISCELLANEOUS PARTS

NOTES:

- Parts without part number cannot be supplied.
- Parts marked by "⊗" are not always kept in stock. Their delivery time may be longer than usual or they may be unavailable.
- The ⊗ mark found on some component parts indicates the importance of the safety factor of the part. Therefore, when replacing, be sure to use parts of identical designation.

The PD-7700/KU, KC, HEM, HB, SD, HPW and PD-7700-S/HEWM types are the same as the PD-31/KU type with the exception of the following sections.

Mark	Symbol & Description	Part No.									Remarks
		PD-31/KU	PD-7700 /KU	PD-7700 /KC	PD-7700 /HEM	PD-7700 /HB	PD-7700 /SD	PD-7700 /HPW	PD-7700-S /HEWM	PD-7700-S /HEWM	
⊗	Mother board assembly	PWM1448	PWM1444	PWM1444	PWM1445	PWM1445	PWM1447	PWM1444	PWM1445	PWM1445	
⊗	Audio board assembly	PWZ2118	
⊗	S trans board assembly	Non supply	
⊗	A trans board assembly	Non supply	
⊗	Operate board assembly	PWZ2112	PWZ2111	PWZ2111	PWZ2111	PWZ2111	PWZ2111	PWZ2111	PWZ2111	PWZ2111	
⊗	SW board assembly	Non supply	Non supply	Non supply	Non supply	Non supply	Non supply	Non supply	Non supply	Non supply	
⊗	Headphone board assembly	Non supply	Non supply	Non supply	Non supply	Non supply	Non supply	Non supply	Non supply	Non supply	
⊗	Jack board assembly	Non supply	
⊗	Voltage selector	PSB1002	
⊗	Power transformer S(AC120V)	PTT1179	PTT1179	PTT1179	
⊗	Power transformer S(AC220-240V)	PTT1178	PTT1178	PTT1178	PTT1178	PTT1178	
⊗	Power transformer S(AC110, 120-127, 220, 240V)	PTT1181	
⊗	Power transformer A(AC120V)	PTT1183	
⊗	AC power cord	PDG1015	PDG1015	PDG1015	PDG1003	PDG1036	PDG1013	PDG1006	PDG1003	PDG1003	
⊗	Strala relief	CM-22C	CM-22C	CM-22C	CM-22B	CM-22B	CM-22B	CM-22B	CM-22B	CM-22B	
⊗	Front panel assembly	FEA1164	FEA1133	FEA1133	FEA1133	FEA1133	FEA1133	FEA1133	FEA1133	FEA1153	
⊗	Control panel	PNW1948	PNW1948	PNW1948	PNW1948	PNW1948	PNW1948	PNW1948	PNW1948	PNW2009	
⊗	Power button	PAC1569	PAC1569	PAC1569	PAC1569	PAC1569	PAC1569	PAC1569	PAC1569	PAC1590	
⊗	Select button	PAC1570	PAC1570	PAC1570	PAC1570	PAC1570	PAC1570	PAC1570	PAC1570	PAC1591	
⊗	Play button	PAC1571	PAC1571	PAC1571	PAC1571	PAC1571	PAC1571	PAC1571	PAC1571	PAC1592	
⊗	Search button	PAC1572	
⊗	Headphone knob	PAC1600	PAC1600	PAC1600	PAC1600	PAC1600	PAC1600	PAC1600	PAC1601	
⊗	Slide knob	RAC1428	
⊗	Knob C	RAC1608	
⊗	Display window	PAM1503	PAM1503	PAM1503	PAM1488	PAM1488	PAM1503	PAM1503	PAM1503	PAM1488	
⊗	Cord with plug (mini plug)	PDE-319	
⊗	Tray panel	PNW2025	PNW1949	PNW1949	PNW1949	PNW1949	PNW1949	PNW1949	PNW1949	PNW2011	
⊗	Bonnet	PYY1148	PYY1148	PYY1148	PYY1148	PYY1148	PYY1148	PYY1148	PYY1148	PYY1154	
⊗	CD packing case	PHG1679	PHG1683	PHG1683	PHG1681	PHG1681	PHG1681	PHG1681	PHG1681	PHG1682	
⊗	Stopper	PNM1134	PNM1070	PNM1070	PNM1070	PNM1070	PNM1070	PNM1070	PNM1070	PNM1070	For Packing
⊗	Insulator	PNW2020	VNK1095	VNK1095	VNK1095	VNK1095	VNK1095	VNK1095	VNK1095	VNK1095	
⊗	Cord clamp	RNH-184	
⊗	BIAS lens	RNK1674	
⊗	Operating instructions(English)	PRB1151	PRB1139	PRB1139	PRB1139	PRB1139	
⊗	Operating instructions(English/French)	PRE1142	PRE1142	
⊗	Operating instructions (German/Italian/Dutch/Swedish/Spanish/Portuguese)	PRF1042	PRF1042	
⊗	Operating instructions(Spanish)	PRC1035	

9.2 P.C.B.'s PARTS LIST

NOTES:

- Parts without part number cannot be supplied.
- Parts marked by "Ⓜ" are not always kept in stock. Their delivery time may be longer than usual or they may be unavailable.
- The Δ mark found on some component parts indicates the importance of the safety factor of the part. Therefore, when replacing, be sure to use parts of identical designation.
- When ordering resistors, first convert resistance values into code form as shown in the following examples.

Ex.1 When there are 2 effective digits (any digit apart from 0), such as 560 ohm and 47k ohm (tolerance is shown by J = 5%, and K = 10%).

560 Ω	56 \times 10 ³	561	RD1/4PS	5	6	J
47k Ω	47 \times 10 ³	473	RD1/4PS	4	7	J
0.5 Ω	0R5		RD2H	0	R	5K
1 Ω	010		RD1P	0	1	0K

Ex.2 When there are 3 effective digits (such as in high precision metal film resistors).

5.62k Ω	562 \times 10 ³	5621	RD1/4SR	5	6	2	1	F
----------------	------------------------------	------	---------	---	---	---	---	---

Mark No.	Description	Parts No.	Mark No.	Description	Parts No.
● MOTHER BOARD ASSEMBLY			COILS		
(PWM1444: PD-7700/KU, KC and HPW types)			L383	AXIAL INDUCTOR	LAU010K
(PWM1445: PD-7700/HEM, HB and PD-7700-S/HEWM types)			L394	AXIAL INDUCTOR	LAU010K
(PWM1447: PD-7700/SD type)			CAPACITORS		
SEMICONDUCTORS			C11, C13	CERAMIC CAPACITOR	CKCYF103Z50
Δ IC20	REGULATOR IC	M5298P	C15, C16	CERAMIC CAPACITOR	CKCYF103Z50
IC21	REGULATOR IC	NJM78L05A	C25	ELECTROLYTIC CAPACIT	CEAS472M16
IC22	REGULATOR IC	NJM79L06A	C26	ELECTR. CAPACITOR	CEAS222M16
IC23	REGULATOR IC	NJM7805FA	C27	ELECTROLYTIC CAPACIT	CEAS471M6R3
Δ IC31	IC(PWM1445, PWM1447 only)	ICP-N10	C28	ELECTR. CAPACITOR	CEAS101M10
IC101	PRE AMP IC	CXA1471S	C52	ELECTR. CAPACITOR	CEAS101M35
IC151	SERVO IC	CXA1372S	C60	ELECTR. CAPACITOR	CEAS10M50
Δ IC201, IC202	POWER OP-AMP, IC	LA6520	C61, C62	ELECTR. CAPACITOR	CEAS101M16
IC301	EPM DEMODULATION IC	CXD2500AQ	C63	ELECTR. CAPACITOR	CEAS102M16
IC401	D/A CONVERTER, IC	PD2026A	C101, C102	ELECTR. CAPACITOR	CEAS101M10
IC402	OP-AMP IC	M5238PF	C103	CERAMIC CAPACITOR	CCCCH200350
IC402	OP-AMP IC	NJM5532DD	C104	ELECTR. CAPACITOR	CEAS101M10
Q101	TRANSISTOR	2SA854S	C110	CERAMIC CAPACITOR	CKCYF103Z50
Q321, Q351	TRANSISTOR	DTC124ES	C151-C153	ELECTR. CAPACITOR	CEAS101M10
Q391	TRANSISTOR	2SCJ740S	C155	CERAMIC CAPACITOR	CKCYB182K20
Q401-Q404	TRANSISTOR	2SD2144S	C156	CERAMIC CAPACITOR	CGCYX333K25
Q405	TRANSISTOR	DTC124ES	C157	CERAMIC CAPACITOR	CGCYX103K25
Q406	TRANSISTOR	DTA124ES	C158, C159	CERAMIC CAPACITOR	CGCYX104K25
Q451, Q452	TRANSISTOR	DTA124ES	C160	ELECTR. CAPACITOR	CEAS4R7M50
Q453, Q454	TRANSISTOR	2SB1296	C161	CERAMIC CAPACITOR	CGCYX104K25
Δ D11-D14, D52	DIODE	11ES2	C162	ELECTR. CAPACITOR	CEAS010M50
D54	ZENNER DIODE	MTZJ18B	C163	CERAMIC CAPACITOR	CGCYX104K25
D301	DIODE	1SS254	C164	CERAMIC CAPACITOR	CGCYX103K25
D391-D394	DIODE(PWM1444 only)	1SS254	C167	CERAMIC CAPACITOR	CKCYF103Z50
D395-D397	DIODE	1SS254	C168	CERAMIC CAPACITOR	CGCYX333K25
D451, D452	DIODE	1SS254	C169	CERAMIC CAPACITOR	CGCYX103K25
			C170	CERAMIC CAPACITOR	CKCYB332K50
			C171, C172	CERAMIC CAPACITOR	CKCYB472K50
			C202, C207	CERAMIC CAPACITOR	CKCYF103Z50

Mark No.	Description	Parts No.
C212	CERAMIC CAPACITOR	CKCYB272K50
C216, C217	ELECTR. CAPACITOR	CEAS330M16
C301	CERAMIC CAPACITOR	CGCYX104K25
C302	ELECTROLYTIC CAPACIT	CEAS471M6R3
C306	CERAMIC CAPACITOR	CKCYB162K50
C307	CERAMIC CAPACITOR	GGCYX473K25
C308	CERAMIC CAPACITOR	GGCYX103K25
C309	ELECTR. CAPACITOR	CEASR47M50
C321	CERAMIC CAPACITOR	GGCYX104K25
C324	CERAMIC CAPACITOR	CKCYF103Z50
C361	CERAMIC CAPACITOR	CKCYF103Z50
C362	CERAMIC CAPACITOR	CKCYB102K50
C391, C392	CERAMIC CAPACITOR (PWM1444 only)	CCCSL101J50
C393, C394	CERAMIC CAPACITOR	CKCYF103Z50
C395	CERAMIC CAPACITOR (PWM1444 only)	CKCYF103Z50
C397	CERAMIC CAPACITOR	CKCYF103Z50
C403	CERAMIC CAPACITOR	CCCCH220J50
C404	CERAMIC CAPACITOR	CCCCH120J50
C413-C416	AUDIO FILM CAPACITOR	CFTXA104J50
C429, C430	CERAMIC CAPACITOR	CCCCH390J50
C431, C432	ELECTR. CAPACITOR	CEAS330M16
C433, C434	ELECTR. CAPACITOR	CEAS470M50
C435-C438	CERAMIC CAPACITOR	CCCCH390J50
C441, C442	PL. STYRENE CAPACITOR	CQSA102J50
C451, C452	ELECTR. CAPACITOR	CEAS330M16
C453	CERAMIC CAPACITOR	CKCYF103Z50
RESISTORS		
VR102	VR	VRTB6VS223
VR103	VR	VRTB6VS102
VR151	VR	VRTB6VS223
VR152	VR	VRTB6VS223
R391	CARBON FILM RESISTOR (PWM1444 only)	RD1/6PM244J
R392	CARBON FILM RESISTOR (PWM1444 only)	RD1/6PM102J
	Other resistors	RD1/6PM□□□J
OTHERS		
CN101	CONNECTOR	52045-1610
JA301	OPTICAL OUTPUT JACK	TOTX178
JA391	JACK /12V(PWM1444 only)	PKN1004
JA392	JACK /12V(PWM1444 only)	PKN1004
JA393	JACK (mini)	PKN1005
JA401	JACK (2P)	PKB1009
X401	XTAL RES (OSC)	PSS1006

Mark No.	Description	Parts No.
● OPERATE BOARD ASSEMBLY (PWZ2111)		
SEMICONDUCTORS		
IC701	MICROCOMPUTER, IC	PD4336A
D701-D714	DIODE	1SS264
SWITCHES		
S701-S742	SWITCH	PSG1006
[1-20, PGM, DELETE, CHECK, CLEAR, >20, RESERVE, REPEAT, TIME, RND, PEAK SEARCH, O/L, HI LITE SCAN, AUTO SPACE, COMPU, TIME FADE, <4, >>, <4, >>, STOP(□), PLAY(>)]		
CAPACITORS		
C701	ELECTR. CAPACITOR	CEAS330M16
C702-C714	AXIAL CAPACITOR	CKPUYB221K50
RESISTORS		
	All resistors	RD1/6PM□□□J
OTHERS		
V701	FL INDICATOR TUBE	PEL1057
X701	CERAMIC RESONATOR PHOTO SENSOR UNIT	VSS1014 GP1U50X
SW BOARD ASSEMBLY		
SEMICONDUCTORS		
D715	LED	PCX1018
SWITCHES		
S743	SWITCH (ON/STN BY)	PSG1006
HEADPHONE BOARD ASSEMBLY		
SEMICONDUCTORS		
IC501	OP-AMP, IC	M5218AL
COILS		
L501-L505	AXIAL INDUCTOR	LAU010K
CAPACITORS		
C501, C502	ELECTR. CAPACITOR	CEAS330M16
C508-C507	CERAMIC CAPACITOR	CKCYF103Z50
RESISTORS		
VR501	VARIABLE RESISTOR Other resistors	PCS1002 RD1/6PM□□□J
OTHERS		
JA501	JACK	RKN2001

9.4 SCHEMATIC DIAGRAM

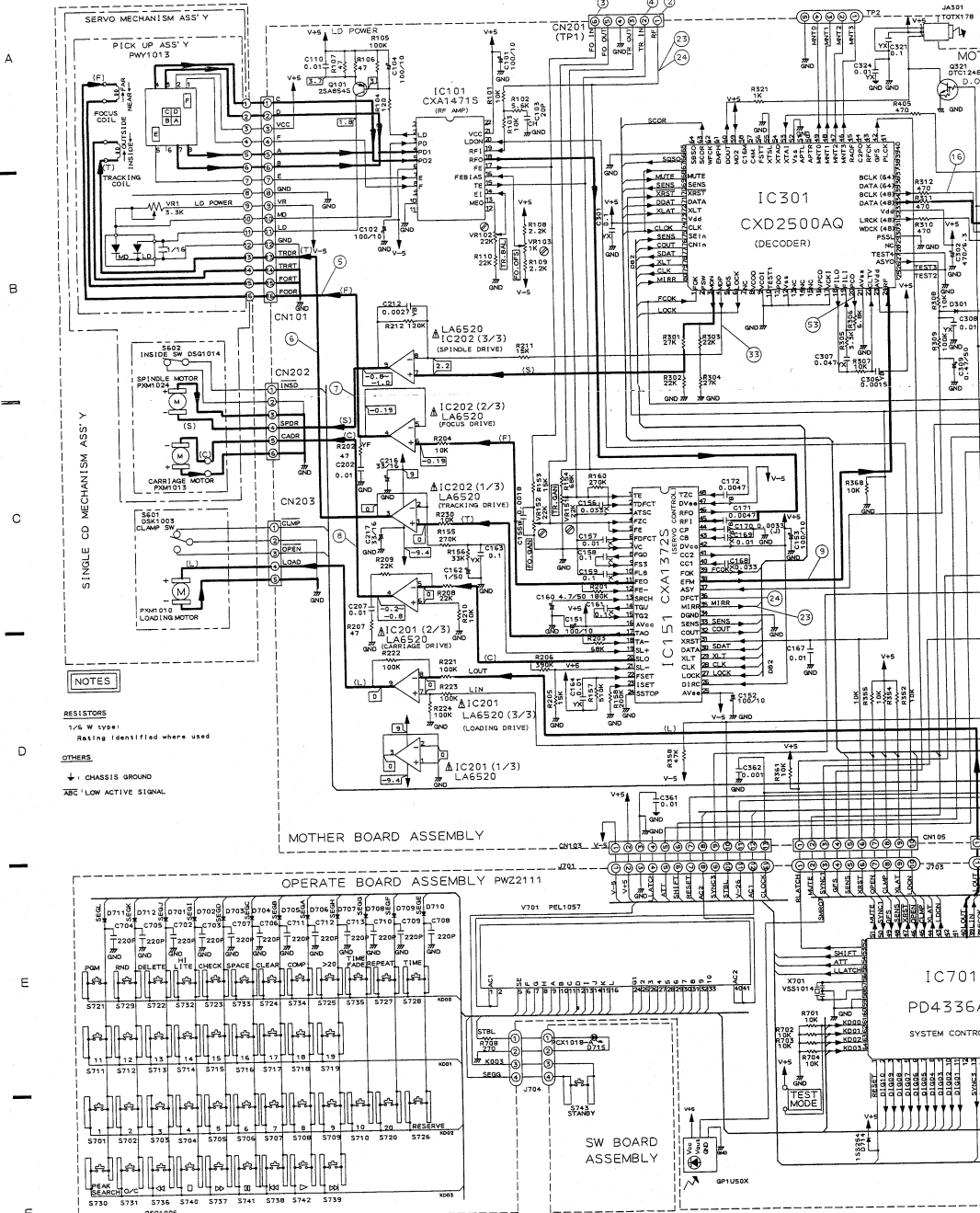

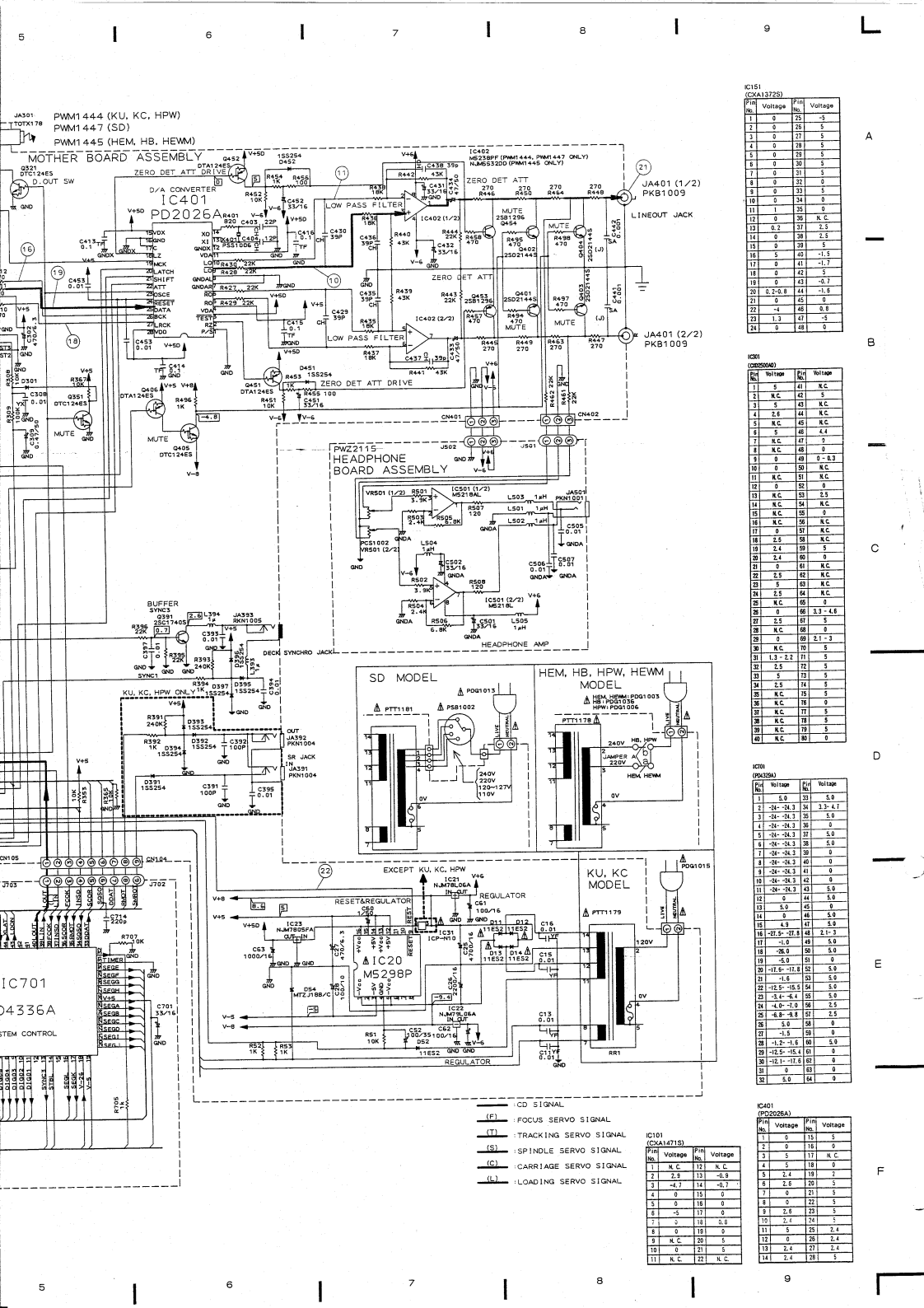

IC151
(CCA13725)

Pin No.	Voltage	Pin No.	Voltage
1	0	23	5
2	0	24	5
3	0	27	5
4	0	28	5
5	0	29	5
6	0	30	5
7	0	31	5
8	0	32	5
9	0	33	5
10	0	34	0
11	0	35	0
12	0	36	K.C.
13	0.2	37	2.5
14	0	38	2.5
15	0	39	2.5
16	5	40	5
17	0	41	-1.7
18	0	42	5
19	0	43	-0.7
20	2.7	44	-5
21	0	45	0
22	-1	46	5.8
23	1.3	47	-5
24	0	48	0

IC101
(CPD2026A)

Pin No.	Voltage	Pin No.	Voltage
1	5	41	K.C.
2	K.C.	42	5
3	5	43	K.C.
4	2.6	44	K.C.
5	K.C.	45	K.C.
6	5	46	4.4
7	K.C.	47	5
8	K.C.	48	0
9	0	49	0.3
10	0	50	K.C.
11	K.C.	51	K.C.
12	0	52	5
13	K.C.	53	2.5
14	K.C.	54	K.C.
15	K.C.	55	0
16	K.C.	56	K.C.
17	0	57	K.C.
18	2.5	58	K.C.
19	2.6	59	5
20	2.1	60	0
21	2.5	61	K.C.
22	2.5	62	K.C.
23	5	63	K.C.
24	2.5	64	K.C.
25	K.C.	65	3
26	0	66	3.3-4.6
27	0.5	67	0.1
28	K.C.	68	2.1-3
29	0	69	5
30	K.C.	70	5
31	1.3-2.7	71	5
32	2	72	5
33	5	73	5
34	2.5	74	5
35	K.C.	75	0
36	K.C.	76	0
37	K.C.	77	5
38	K.C.	78	5
39	K.C.	79	5
40	K.C.	80	0

IC101
(CCA14715)

Pin No.	Voltage	Pin No.	Voltage
1	5.0	13	5.0
2	-24	14	3.3-4.7
3	-24	15	5.0
4	-24	16	5.0
5	-24	17	5.0
6	-24	18	5.0
7	-24	19	5.0
8	-24	20	5.0
9	-24	21	5.0
10	-24	22	5.0
11	5.0	23	5.0
12	5.0	24	5.0
13	4.9	27	5.0
14	-25	28	2.1-3
15	5.0	29	5.0
16	-18	30	5.0
17	-18	31	5.0
18	-8	32	5.0
19	5.0	33	5.0
20	-18	34	5.0
21	-18	35	5.0
22	-18	36	5.0
23	-3.6	37	5.0
24	-4.0	38	5.0
25	-6.8	39	2.5
26	5.0	40	5.0
27	5.0	41	5.0
28	-1.2	42	5.0
29	-12.5	43	0
30	-12.1	44	0
31	5.0	45	0
32	5.0	46	0

IC101
(CPD2026A)

Pin No.	Voltage	Pin No.	Voltage
1	K.C.	12	K.C.
2	2.3	13	-6.9
3	-4.7	14	-0.7
4	0	15	0
5	0	16	0
6	5	17	0
7	0	18	5.0
8	0	19	0
9	0	20	5.0
10	0	21	5.0
11	K.C.	22	K.C.
12	K.C.	23	K.C.

- (CD) SIGNAL
- (F) FOCUS SERVO SIGNAL
- (T) TRACKING SERVO SIGNAL
- (S) SPINDLE SERVO SIGNAL
- (C) CARRIAGE SERVO SIGNAL
- (L) LOADING SERVO SIGNAL

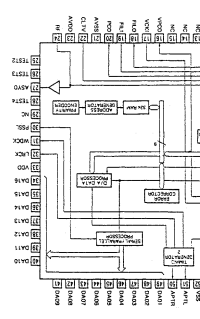
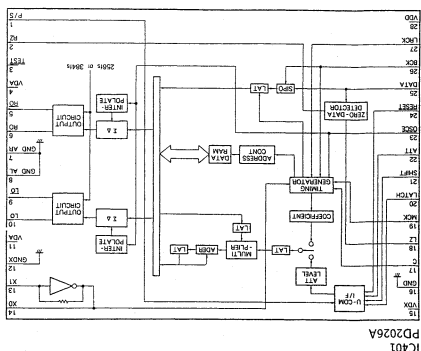
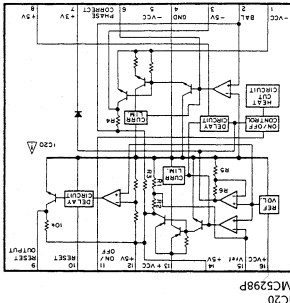

9.3 WAVEFORMS

Note: The encircled numbers denote measuring in the schematic diagram.

*1.50T - JUMP: After switching to the pause mode, press the manual search key.
*2.FOCUS - IN: Press the key without loading a disc.

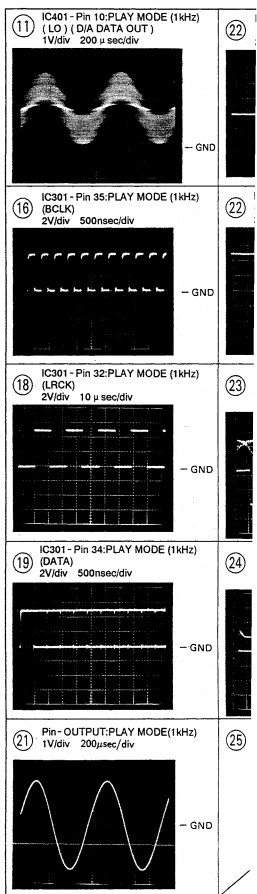
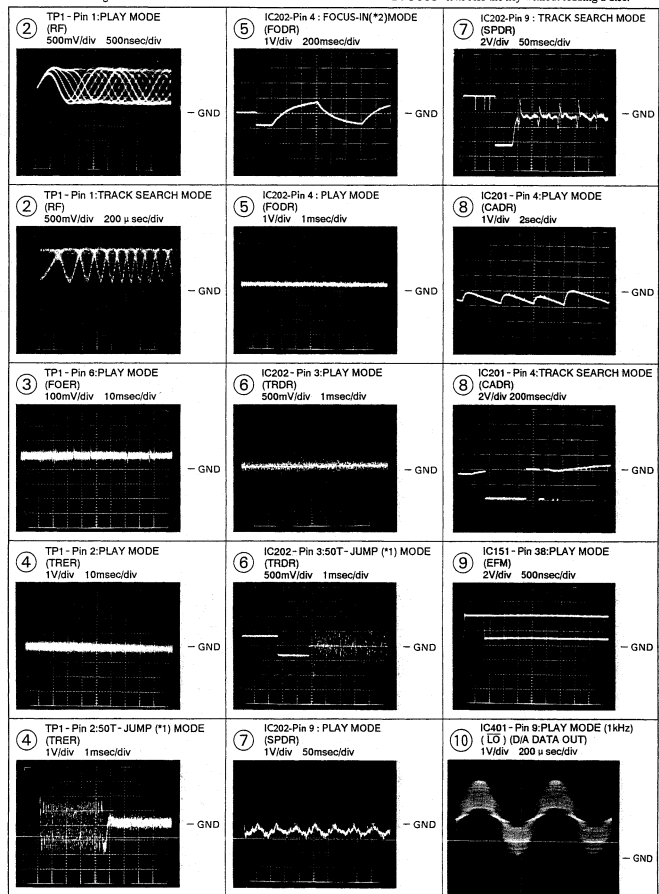

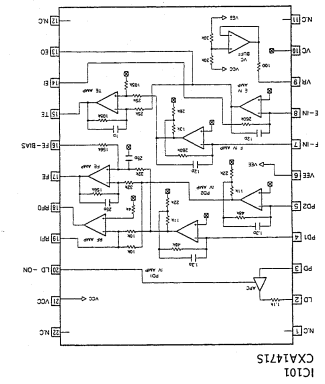
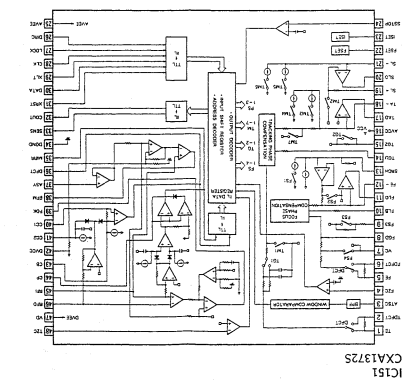
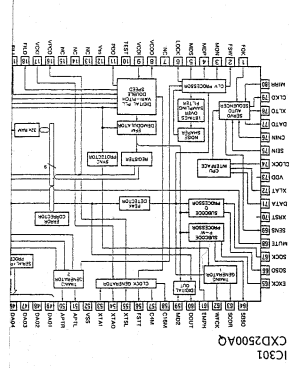

● IC BLOCK DIAGRAM

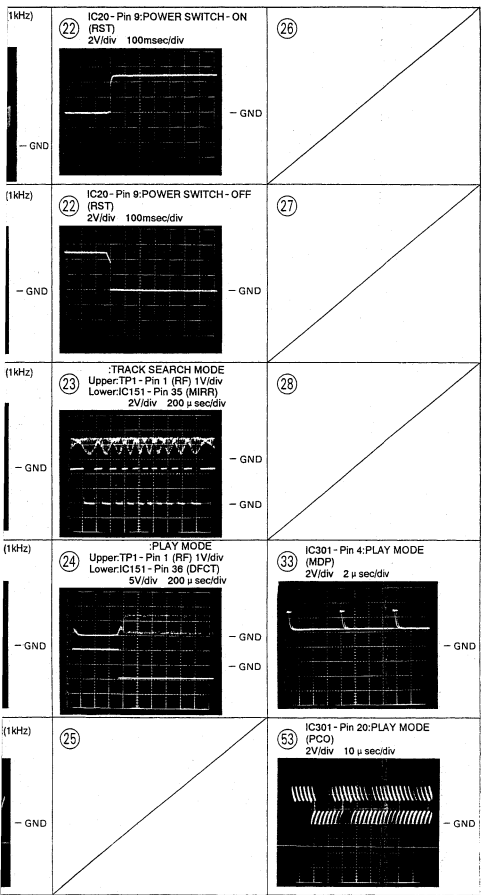

1. RESISTORS:
 Indicated in Ω, 1/4W, 1/6W and 1/8W, ±5% tolerance unless otherwise noted
 k; kΩ; M; MΩ (F); ±5% (G); ±2% (K); ±10% (M); ±20% tolerance.
2. CAPACITORS:
 Indicated in capacity (μF)/voltage(V) unless otherwise noted p; pF. Indication without voltage is 50V except electrolytic capacitor.
3. VOLTAGE, CURRENT:
 □ : DC voltage (V) at play state.
 □_{MA} : DC current at play state.
 Value in () is DC current at stop state.
4. OTHERS:
 ◆ : Signal route.
 ⊗ : Adjusting point.
 The ⊗ mark found on some component parts indicates the importance of the safety factor of the part. Therefore, when replacing, be sure to use parts of identical designation.
 * marked capacitors and resistors have parts numbers.
- This is the basic schematic diagram, but the actual circuit may vary due to improvements in design.
5. SWITCHES: (The underlined indicates the switch position)
 SWITCH BOARD ASSEMBLY
 S743: POWER ON-OFF
- OPERATE BOARD ASSEMBLY
- | | |
|--------------|-------------------------|
| S701: 1 | S723: CHECK |
| S702: 2 | S724: CLEAR |
| S703: 3 | S725: > 28 |
| S704: 4 | S726: RESERVE |
| S705: 5 | S727: REPEAT |
| S706: 6 | S728: TIME |
| S707: 7 | S729: RND |
| S708: 8 | S730: PEAK SEARCH |
| S709: 9 | S731: O/L |
| S710: 10 | S732: HI LITE SCAN |
| S711: 11 | S733: AUTO SPACE |
| S712: 12 | S734: COMPU |
| S713: 13 | S735: TIME FADE] EDIT |
| S714: 14 | S736: [] MANUAL SEARCH |
| S715: 15 | S737: [] TRACK SEARCH |
| S716: 16 | S738: [] STOP [] |
| S717: 17 | S741: PAUSE [] |
| S718: 18 | S742: PLAY [] |
| S719: 19 | S743: ON/STN BY |
| S720: 20 | |
| S721: PGM | |
| S722: DELETE | |

Line Voltage Selection (For HB, HEM, HPW and HEWM types)

- Line voltage can be changed with the following steps.
1. Disconnect the AC power cord.
 2. Remove the top cover.
 3. Change the position of the jumper wire A as follows

Voltage	Jumper wire A position
220V	a
240V	b

4. Stick the line voltage label on the rear panel.

Parts No.	Description
AXX-193	220V label
AXX-192	240V label

9.5 P.C. BOARDS CONNECTION DIAGRAM

MOTHER BOARD ASSEMBLY
 (PWM1444:KU,KC AND HPW TYPES)
 (PWM1445:HEM,HB AND HEWM TYPES)
 (PWM1447:SD TYPE)

A

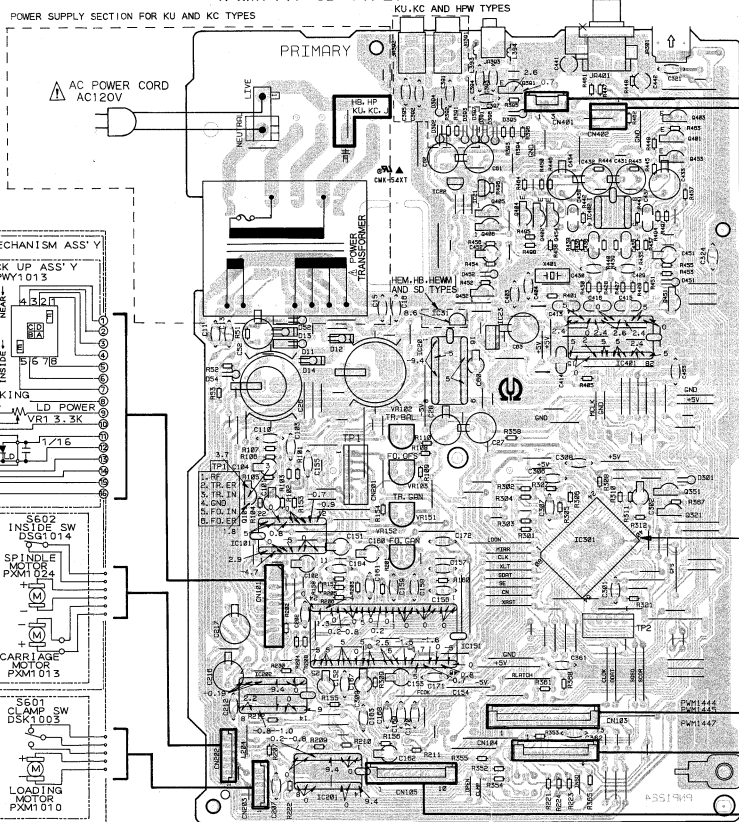

- Q391
- Q403
- Q401
- Q453
- IC22 IC21
- Q405 Q404
- Q402 Q454
- Q406 IC402
- Q452
- Q451
- IC31
- IC23 IC401
- IC20
- VR102
- VR103 Q101
- Q351
- Q321
- VR151
- IC101
- VR152 IC301
- IC151
- IC202
- IC201

POWER SUPPLY SECTION FOR HEM,HB,HPW AND HEWM TYPES

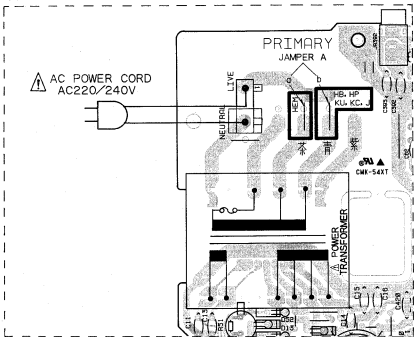

B

POWER SUPPLY SECTION FOR SD TYPE

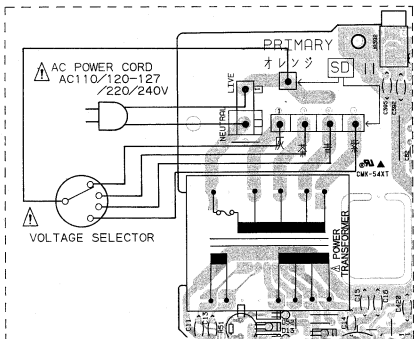

C

D

1

2

3

4

5

6

HEADPHONE BOARD ASSEMBLY

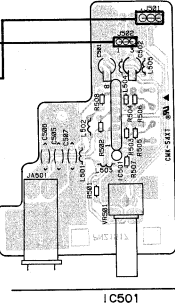

IC501

SW BOARD ASSEMBLY

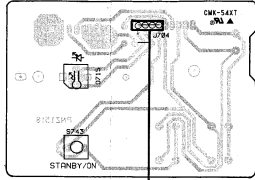

IC501 (CONTINUED)

Pin	Trace	Pin	Voltage
1	S	41	K.C.
2	K.C.	42	S
3	S	43	K.C.
4	2.5	44	K.C.
5	K.C.	45	K.C.
6	S	46	4.4
7	K.C.	47	0
8	K.C.	48	0
9	0	49	0 - 2.3
10	0	50	K.C.
11	K.C.	51	K.C.
12	0	52	0
13	K.C.	53	2.5
14	K.C.	54	K.C.
15	K.C.	55	0
16	K.C.	56	K.C.
17	S	57	K.C.
18	2.5	58	K.C.
19	2.4	59	0
20	2.4	60	0
21	0	61	K.C.
22	2.5	62	K.C.
23	S	63	K.C.
24	2.5	64	K.C.
25	K.C.	65	0
26	0	66	3.3 - 4.8
27	2.5	67	S
28	K.C.	68	0
29	0	69	2.1 - 3
30	K.C.	70	S
31	1.5 - 2.2	71	S
32	S	72	0
33	S	73	0
34	2.5	74	S
35	K.C.	75	S
36	K.C.	76	S
37	K.C.	77	S
38	K.C.	78	S
39	K.C.	79	S
40	K.C.	80	0

IC502 (CONTINUED)

Pin	Voltage	Pin	Voltage
1	5.0	33	5.0
2	20 - 20.3	34	3.3 - 4.7
3	20 - 20.3	35	5.0
4	20 - 20.3	36	0
5	20 - 20.3	37	5.0
6	20 - 20.3	38	5.0
7	20 - 20.3	39	0
8	20 - 20.3	40	0
9	20 - 20.3	41	0
10	20 - 20.3	42	0
11	20 - 20.3	43	5.0
12	0	44	5.0
13	5.0	45	0
14	0	46	5.0
15	4.9	47	5.0
16	10.5 - 10.8	48	2.1 - 3
17	-1.0	49	5.0
18	-2.0	50	5.0
19	-5.0	51	0
20	31.6 - 11.8	52	5.0
21	-1.8	53	5.0
22	21.5 - 10.5	54	5.0
23	-3.4 - 4.4	55	5.0
24	4.0 - 11.0	56	2.5
25	-6.8 - 8.4	57	2.5
26	5.0	58	0
27	-1.5	59	0
28	1.2 - 1.6	60	5.0
29	12.5 - 15.4	61	0
30	-11.1 - 12.0	62	0
31	0	63	0
32	5.0	64	0

Q391
 Q403
 Q401
 Q453
 IC22 IC21
 Q405 Q404
 Q402 Q454
 Q406 IC402
 Q452
 Q451
 IC31
 IC23 IC401
 IC20

VR102
 VR103 Q101
 Q351
 Q321
 VR151
 IC101
 IC301
 IC151
 IC202
 IC201

OPERATE BOARD ASSEMBLY (PWZ2111)

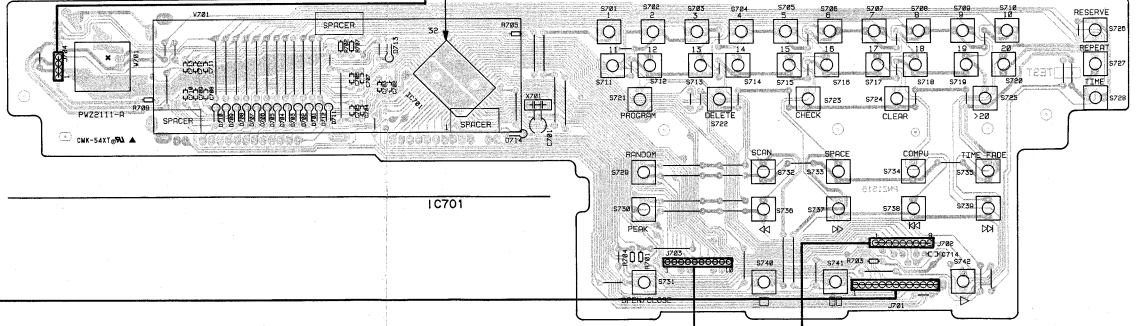

IC701

P.C.B. pattern diagram indication	Corresponding part symbol	Part name	P.C.B. pattern diagram indication	Corresponding part symbol	Part name
		Transistor			Ceramic capacitor
		FET			Mylar capacitor
		Diode			Sinter capacitor
		Zener diode			Electrolytic capacitor (Non-polarized)
		LED			Electrolytic capacitor (Polarized)
		Varactor			Power capacitor
		Tact switch			Semi-fixed resistor
		Inductor			Resistor array
		Coil			Resistor
		Transformer			Resonator
		Filter			Thermistor

- This P.C.B. connection diagram is viewed from the parts mounted side.
- The parts which have been mounted on the board can be replaced with those shown with the corresponding wiring symbols listed in the above Table.
- The capacitor terminal marked with shows negative terminal.
- The diode marked with G shows cathode side.
- The transistor terminal marked with shows emitter.

10. PANEL FACILITIES

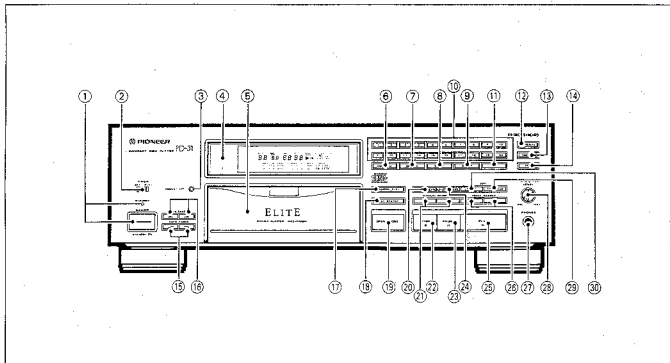

FRONT PANEL

- ① **POWER STANDBY/ON switch and indicator**
Press this switch to turn the power on. The unit will set to the standby mode and the STANDBY indicator will light.
- ② **TIMER OFF/PLAY switch**
- ③ **DISPLAY OFF button**
- ④ **Remote sensor**
- ⑤ **Disc tray**
- ⑥ **PROGRAM button**
- ⑦ **DELETE button**
- ⑧ **CHECK button**
- ⑨ **CLEAR button**
- ⑩ **Track number buttons (1-20)**
- ⑪ **> 20 button**
- ⑫ **RESEVRE button**
- ⑬ **REPEAT button**
- ⑭ **TIME button**
- ⑮ **AUTO FADER buttons (↖, ↗)**
- ⑯ **INDEX SEARCH buttons (↙, ↘)**
- ⑰ **RANDOM PLAY button**
- ⑱ **PEAK SEARCH button**
- ⑲ **OPEN/CLOSE button**
- ⑳ **HI-LITE SCAN button**

- ㉑ **MANUAL SEARCH buttons (◀◀, ▶▶)**
- ㉒ **STOP button (■)**
- ㉓ **PAUSE button (■)**
- ㉔ **AUTO SPACE button**
- ㉕ **PLAY button (▶)**
- ㉖ **TRACK SEARCH buttons (◀◀, ▶▶)**
- ㉗ **Headphones jack (PHONES)**
- ㉘ **Headphones/line volume control (PHONES/LINE LEVEL)**
- ㉙ **TIME FADE EDIT button**
- ㉚ **Program edit button (EDIT) (■ COMPU/■ AUTO)**

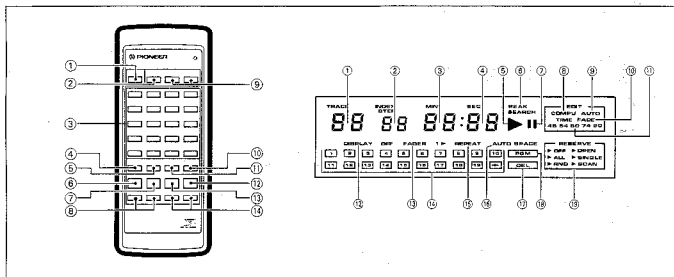

REMOTE CONTROL UNIT

Buttons listed here but not accompanied with explanations have the same functions as the corresponding front panel buttons.

- ① POWER button
- ② OPEN/CLOSE button
- ③ Track number buttons (1–20)
- ④ HI-LITE SCAN button
- ⑤ RESERVE button
- ⑥ RANDOM PLAY button
- ⑦ STOP button (■)
- ⑧ Manual search buttons (MANUAL ◀◀, ▶▶)
- ⑨ OUTPUT LEVEL buttons (–, +)
- ⑩ > 20 button
- ⑪ PROGRAM button
- ⑫ PLAY button (▶)
- ⑬ PAUSE button (⏸)
- ⑭ Track search buttons (TRACK ◀◀, ▶▶)

DISPLAY

- ① Displays track numbers (01–99) during playback or track search.
- ② Displays index numbers (sub-divisions of tracks); during program input, indicates program steps.
- ③ Displays track playing time and remaining time (minutes).
- ④ Displays track playing time and remaining time (seconds).
- ⑤ Lights during playback.
- ⑥ Lights when peak volume levels on the disc are detected.
- ⑦ Lights during playback pause.
- ⑧ Lights during use of computer allocated program editing or auto program editing.
- ⑨ Lights during auto program editing.
- ⑩ Lights during time fade editing.
- ⑪ Indicates the editing time.
- ⑫ Lights when display is in OFF mode.
- ⑬ Lights during operation of fade function.
- ⑭ Calendar display. Lighted numbers indicate total number of tracks on the disc (during program input and program playback, indicates programmed tracks). When a track completes playback, the corresponding lighted number goes out. Arrow mark (➡) lights for tracks higher than "19".
- ⑮ Lights during repeat playback. (During single-track repeat, the [1▶] indicator also lights).
- ⑯ Lights during auto space.
- ⑰ Lights during delete mode.
- ⑱ Lights during program mode.
- ⑲ When "reserve" function is activated, these indicators light in correspondence to the reserved functions (OFF, OPEN, ALL, SINGLE, RND, SCAN).

11. SPECIFICATIONS

1. General

Type	Compact disc digital audio system
Usable discs	Compact Disc
Power requirements	AC 120V, 60Hz
Power consumption	18W
Operating temperature	+5°C – +35°C (+41°F – +95°F)
Weight	5.0kg (11lb)
External dimensions	420(W) × 274(D) × 135(H)mm 16-9 /16(W) × 10-13/16(D) × 5-5/16(H) in.

2. Audio section

Frequency response	2Hz – 20kHz ±0.5dB
S/N	108dB or more (EIAJ)
Dynamic range	97dB or more (EIAJ)
Channel separation	102dB or more (EIAJ)
Total harmonic distortion	0.0022% or less (EIAJ)
Wow and flutter	Limit of measurement [±0.001% W.PEAK] or less (EIAJ)
Number of channels	2 channels (stereo)

3. Output terminal

- Audio line output terminals (FIXED)
- Audio line output terminals (VARIABLE)
- CD-DECK SYNCHRO terminal
- Headphone jack (with motor drive volume control)
- Optical digital output terminal
- Control input/output terminals

4. Functions

- Play
- Pause
- Stop
- Auto space
- Manual search
- Track search
- Index search
- Peak search
- Hi-lite scan
- Direct selection

- Single track repeat
- All track repeat
- Programmed repeat
- Delete repeat
- Random play repeat
- Programmed random play repeat
- Delete play repeat random
- Programmed playback (up to 24 tracks)
- Delete playback
- Pause program
- Program check
- Program correction
- Program clear
- Auto program edit
- Compu program edit
- Time fade edit
- Digital level control
- Random play
- Programmed random play
- Delete random play
- Fade in/fade out
- Time location
- Reserve
- Display off
- Program hold
- Level hold
- Timer start
- CD-deck synchro

5. Accessories

• Remote control unit	1
• Size AAA/R03 dry cell batteries	2
• Output cable	1
• Control cord	1
• Operating instructions	1

NOTE:

The specifications and design of this product are subject to change without notice, due to improvements.

