

Quartz PLL
DIRECT DRIVE TURNTABLE

PL-550

SERVICE MANUAL



 PIONEER®

MODEL PL-550 COMES IN THREE VERSIONS DISTINGUISHED AS FOLLOWS:

Type	Voltage	Remarks
HGT	220V and 240V (Switchable)	SEMKO (Sweden), NEMKO (Norway), DEMKO (Denmark) and EI (Finland) approved model without phono cartridge.
S	110V, 120V, 220V and 240V (Switchable)	General export model with phono cartridge
ST	110V, 120V, 220V and 240V (Switchable)	General export model without phono cartridge

This service manual is applicable to the PL-550/S, ST type. When repairing the PL-550/HGT type please see the manual on pages 43-48.

CONTENTS

1.	SPECIFICATIONS	4
2.	PANEL FACILITIES	5
3.	PARTS LOCATIONS	7
4.	EXPLODED VIEW	11
5.	NOMENCLATURE OF SCREW, WASHERS AND NUT	16
6.	SCHMATIC DIAGRAMS, P.C. BOARD PATTERNS AND PARTS LIST	
6.1	Schematic Diagram	17
6.2	Drive Control Assembly (PWG-008)	19
6.3	Power Supply Assembly (PWR-822)	22
6.4	Positional Detector Assembly (PWX-006)	24
7.	PACKING	25
8.	OPERATING PRINCIPLES CIRCUIT DESCRIPTION	
8.1	Block Diagram	27
8.2	Motor Operation	29
8.3	Waveforms	36
9.	TROUBLE SHOOTING GUIDE	
9.1	Motor Does Not Rotate	37
9.2	Motor Run-away	38
9.3	Motor Alternates Between Forward And Reverse Rotation	39
9.4	Unstable Rotation Near Rated Speed	39
10.	ADJUSTMENT PROCEDURES	40
11.	D.D MOTOR EXPLODED VIEW	41
	PL-550 Additional Service Manual	Enclosed Herewith

PL-550X/ST differs from PL-550 at the point of cabinet appearance; it is black cabinet. Except packing case and cabinet all of components are same as PL-550.

1. SPECIFICATIONS

Motor and Turntable

Motor	Quartz PLL Hall motor
Turntable Platter . . .	324mm diam. aluminum alloy die-cast
Moment of Inertia . . .	340kg-cm ² (including platter mat)
Speeds	33-1/3 and 45rpm
Speed Control Range	±6%
Wow and Flutter	Less than 0.025% (WRMS)
Signal-to-Noise Ratio	More than 70dB (DIN-B)

Rotational Characteristics

Build-up Time	Within 240° rotation at 33-1/3rpm
Speed Deviation	Less than 0.003%
Speed vs. Load Characteristics	Stable up to 120 grams drag load
Speed Drift	Less than 0.0003%/h at 33-1/3rpm Less than 0.00004%/degree temp. change at 33-1/3rpm

Tonearm

Type	Static-balance type, S-shaped pipe arm
Effective Arm Length	221mm
Overhang	15.5mm
Usable Cartridge Weight	4g (min.) to 14.5g (max.) (For cartridge weighs over 9.5g, attach the sub weight)
Arm Height Adjust Range	±5mm

Subfunctions

- Anti-skating force control
- Lateral balancer
- Stylus pressure direct-readout counter weight
- Arm height adjusting device
- Cueing device
- Headshell stand
- Strobe light
- Free stop hinges
- Insulator feet

Furnished Cartridge (S type)

Type	Moving magnet type PC-550E/II
Replacement stylus	PN-550E/II
Stylus Tip	0.3 x 0.7mil diamond
Output Voltage	3mV (at 1kHz, 50mm/s RMS)
Tracking Force	1.0g to 1.8g (proper 1.5g)
Frequency Response	10 to 30,000Hz

Semiconductors

ICs	2
Transistors	9
Diodes	11
Hall elements	3

Accessories

45rpm Adaptor	1
Overhang gauge	1
Screwdriver	1
Sub weight	1
Cartridge mounting screws (ST, HGT type)	6
Cartridge mounting nuts (ST, HGT type)	2
Cartridge mounting washers (ST, HGT type)	2
Operating instructions	1

Miscellaneous

Power Requirements	AC 110-120-220-240V 50/60Hz
Power Consumption	5W
Dimensions	490(W) x 185(H) x 390(D)mm 19-5/16(W) x 7-5/16(H) x 15-3/8(D)in.
Weight	12kg/26lb 6oz

NOTE:

Specifications and design subject to possible modification without notice, due to improvements.

2. PANEL FACILITIES

HEADSHELL STAND

Convenient stand for storing a spare cartridge. Align headshell guide pin with slot of stand and insert. Avoid storing here if the headshell is too large to allow the dust cover to be closed fully. The 45rpm adaptor can also be placed here.

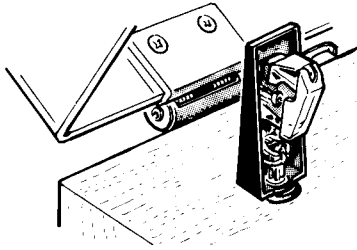

45 RPM ADAPTOR

Place on center shaft when playing 45 rpm records (with large center hole).

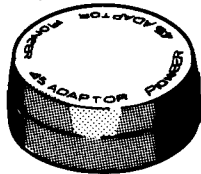

STROBE LIGHT

Lights to illuminate stroboscope when POWER/ARM ELEVATION lever is set to ON. The stroboscope appears to become stationary when the Quartz LOCK button is set to ON.

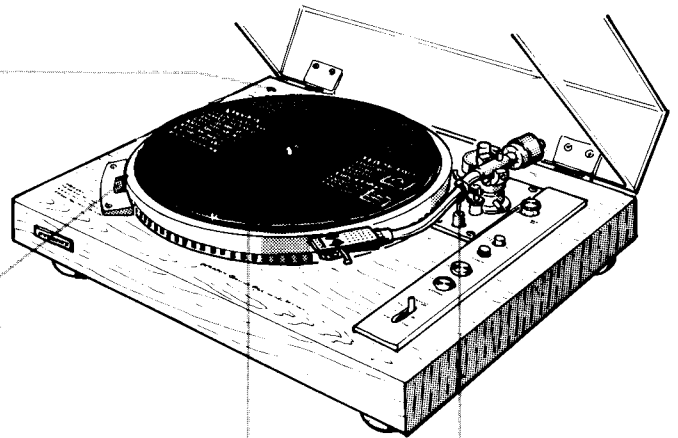

PLATTER MAT COVER

ARM REST

Supports the tonearm. Gently press tonearm in direction shown by arrow to clamp. Be sure to clamp when not playing records.

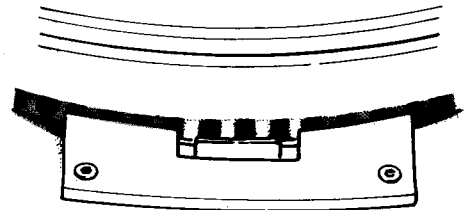
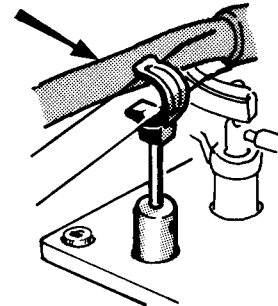

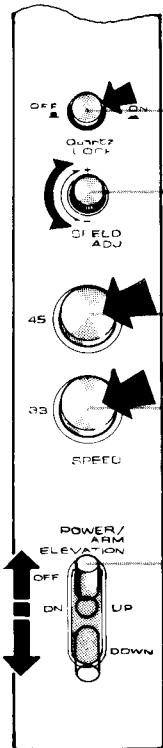

QUARTZ LOCK BUTTON

Quartz PLL system functions when button is depressed to ON. Platter rotation becomes precisely locked to the speed selected by the SPEED buttons.

SPEED ADJ. CONTROL

Can be used to increase or decrease the speed with respect to the selected rotation. Set Quartz LOCK button to OFF and turn this control toward the + direction to increase speed (maximum 6%) and toward the - direction to decrease speed (maximum 6%).

45 RPM SPEED BUTTON

Press to play 45 rpm records.

33 RPM SPEED BUTTON

Press to play 33-1/3 rpm records.

POWER/ARM ELEVATION LEVER

Combines power switch and tonearm elevation switch.

OFF Power is cut off.

ON-UP Power is turned on (platter rotates).
When moved from DOWN to this position, the tonearm is raised.

DOWN Tonearm is gently lowered.

3. PARTS LOCATIONS

TOP VIEW

Headshell stand
PNW-073

Cabinet
PMM-056
PMM-062 (ST type
of PL-550X)

Plate
PAN-029

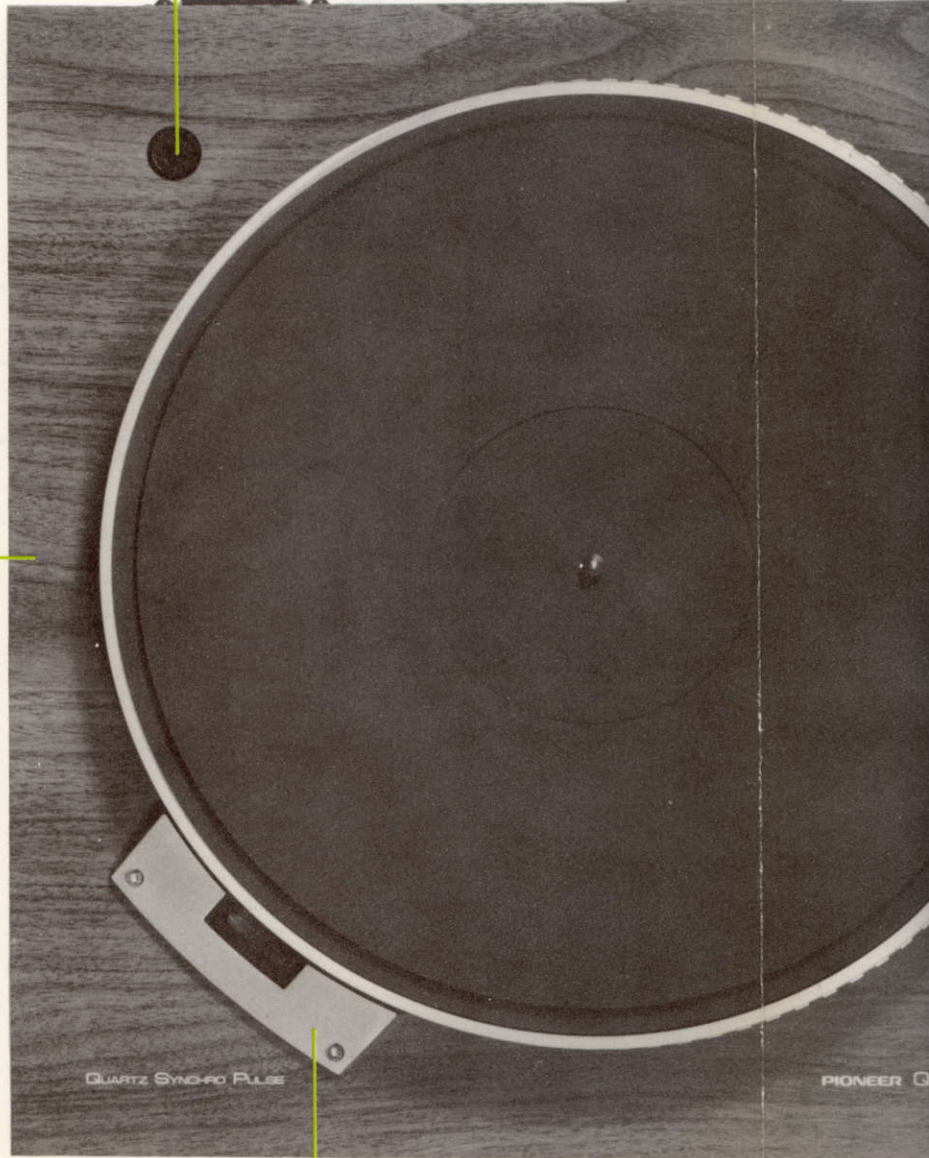

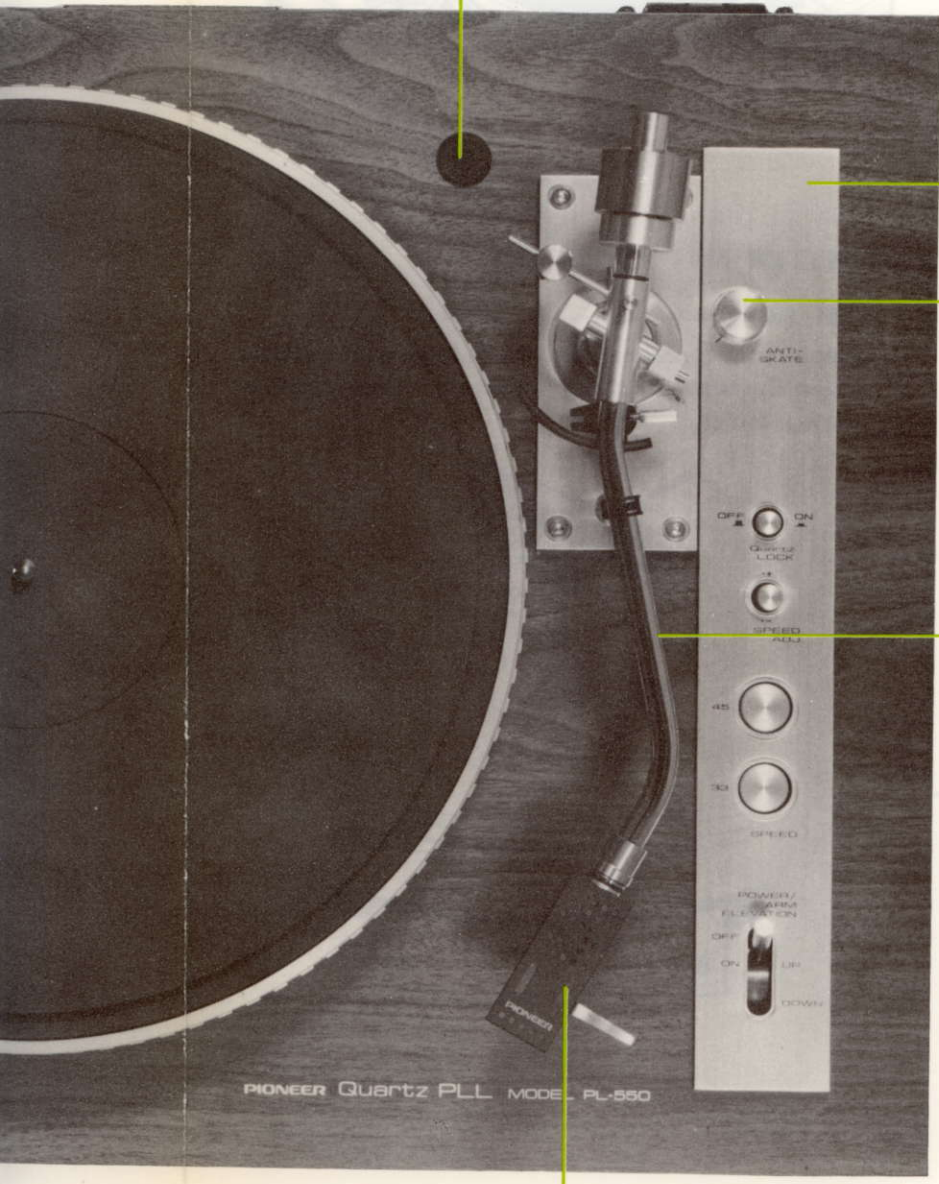

2. PANEL FACILITIES

Control panel
PXT-098

Knob (ANTI-SKATE)
PAA-014

Tonearm

Headshell assembly
PXA-630

BOTTOM VIEW

Line voltage selector
PSB-001

Power transformer
PTT-014

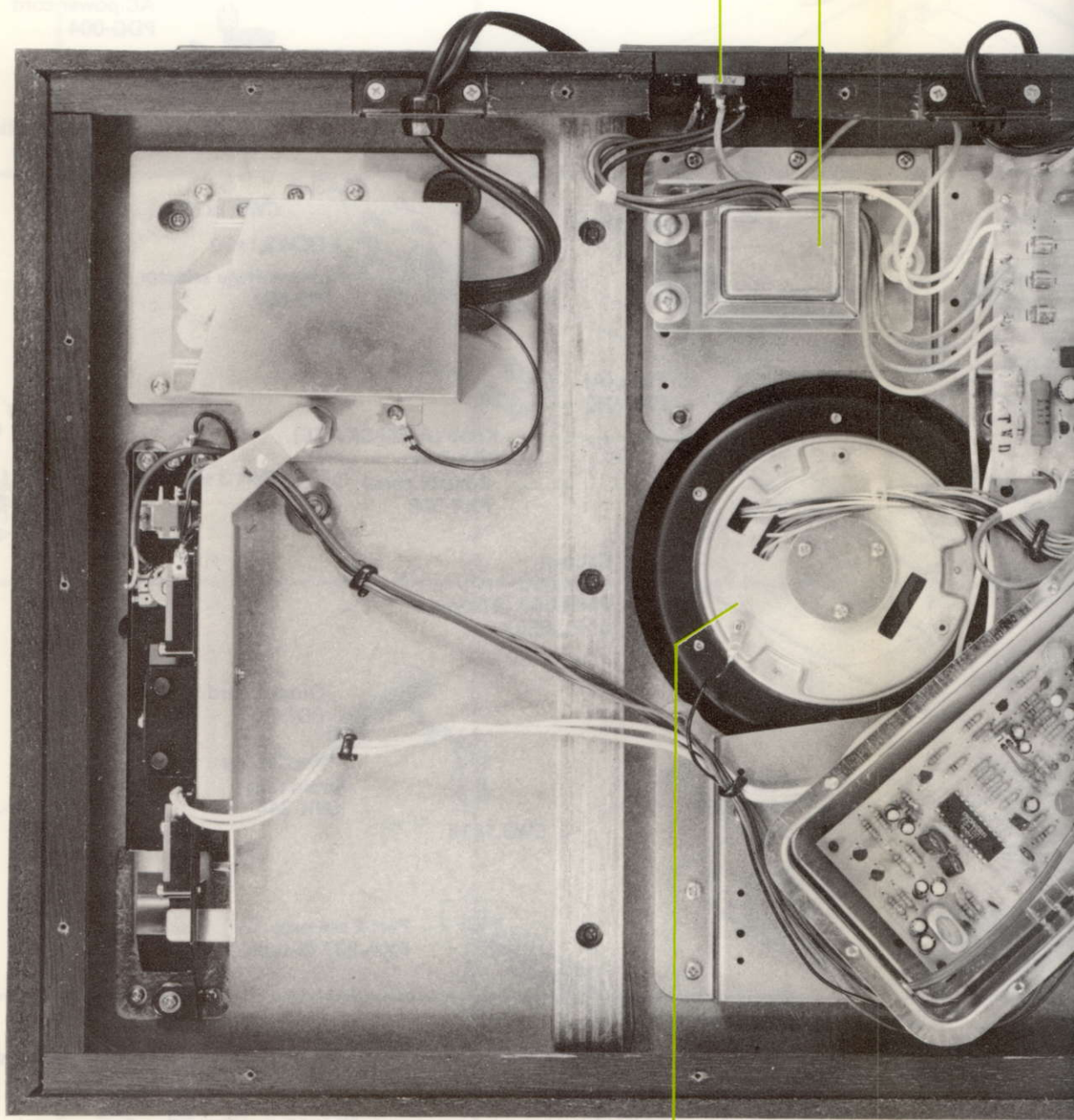

D.D. motor
PXM-029

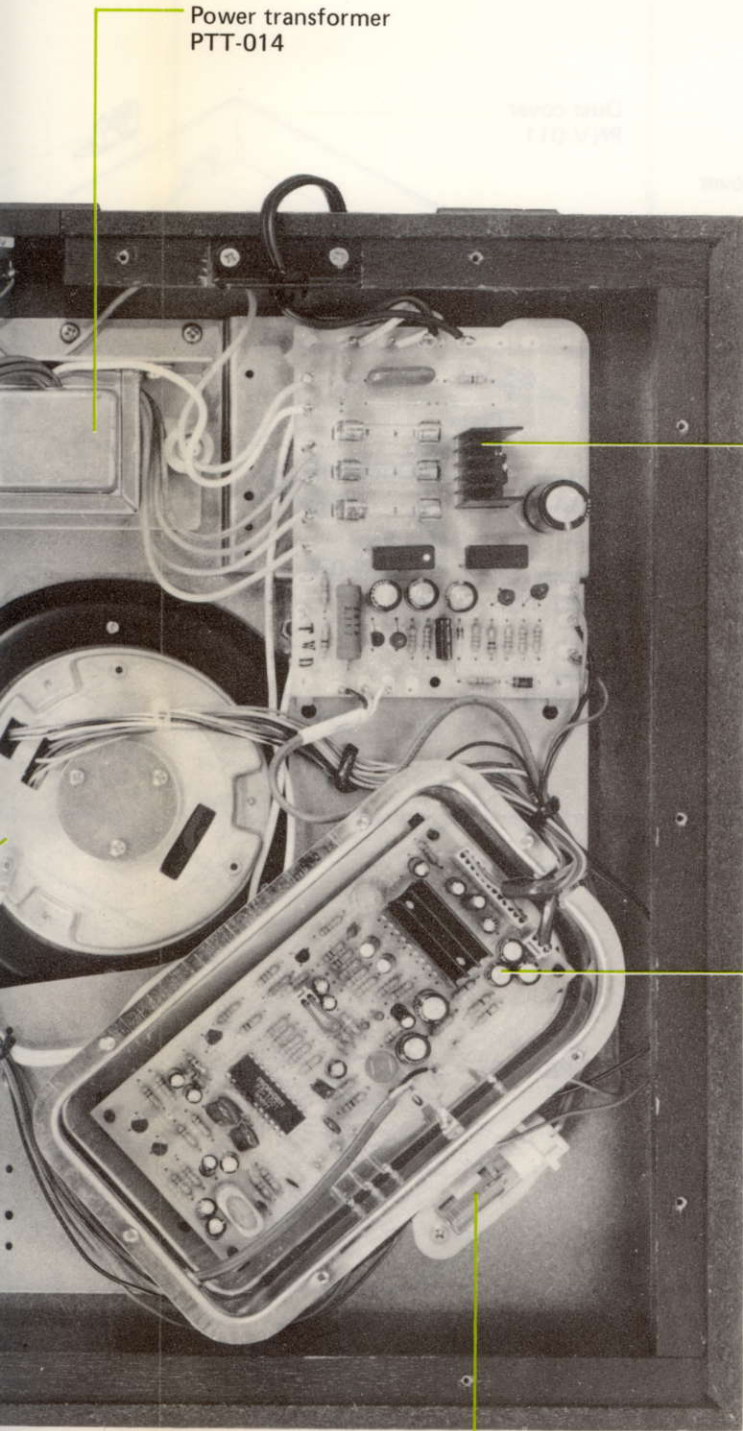

Power transformer
PTT-014

Power supply assembly
PWR-822

Drive control assembly
PWG-008

Neon lamp
PEL-011

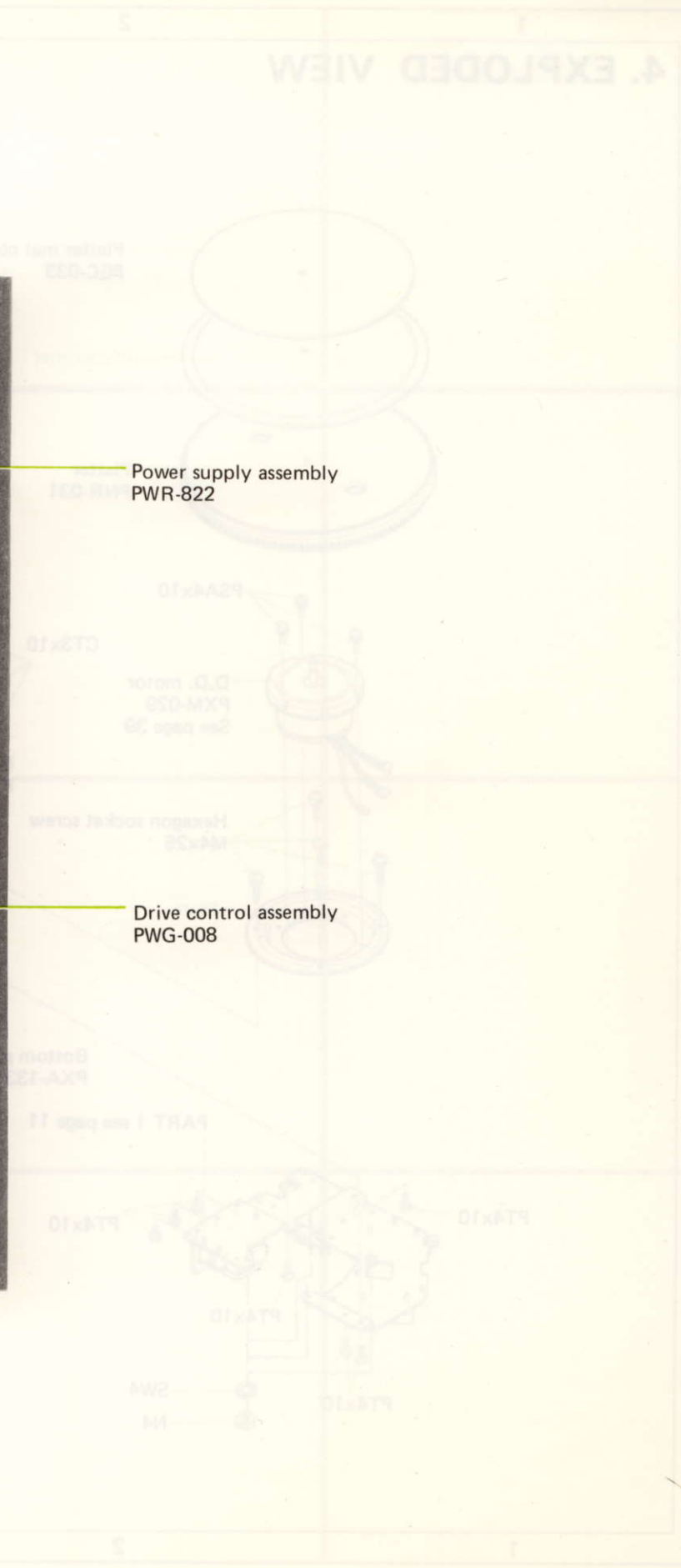

4. EXPLODED VIEW

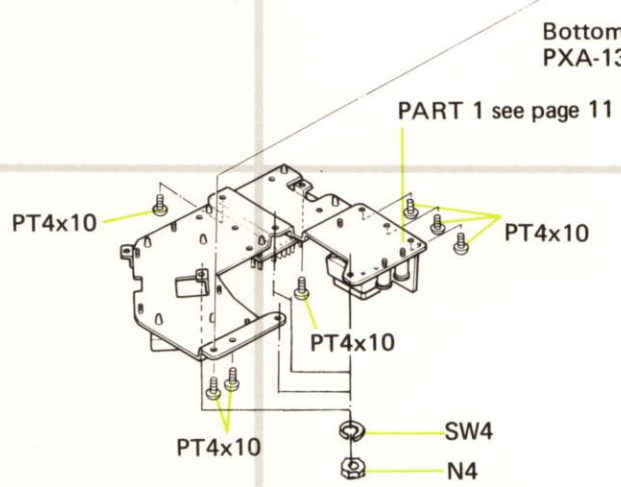
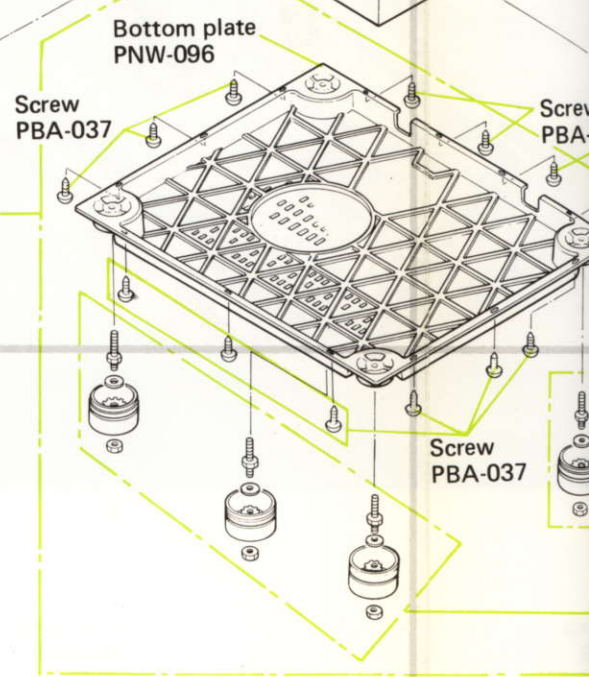
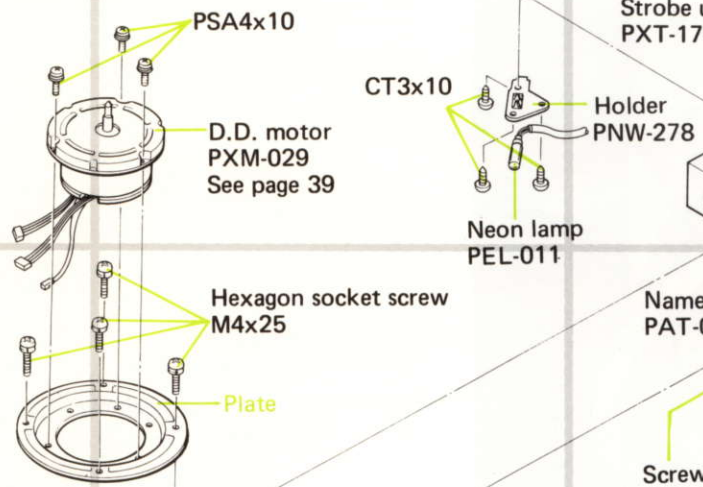
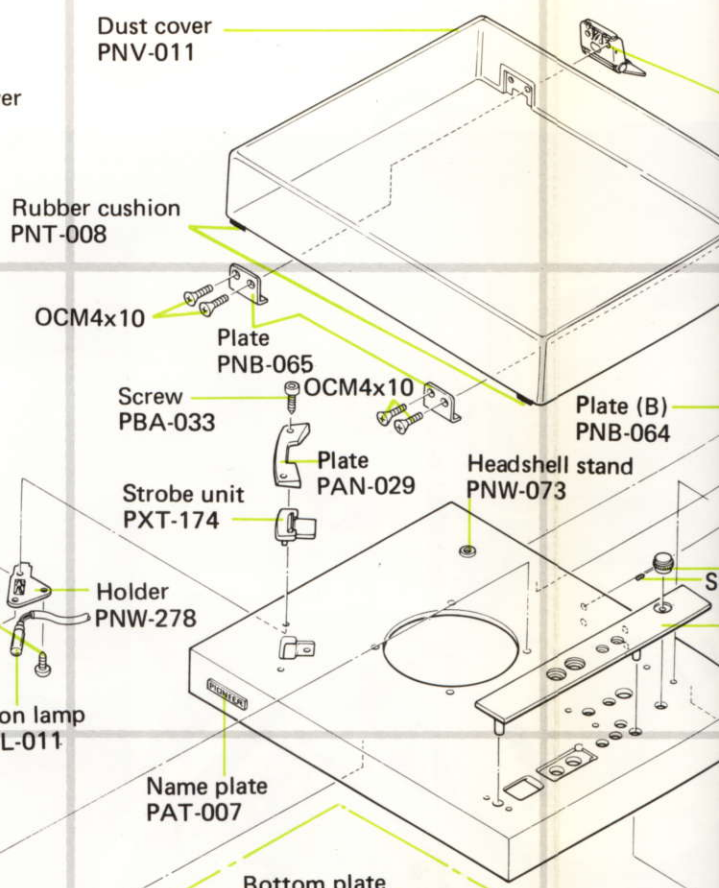
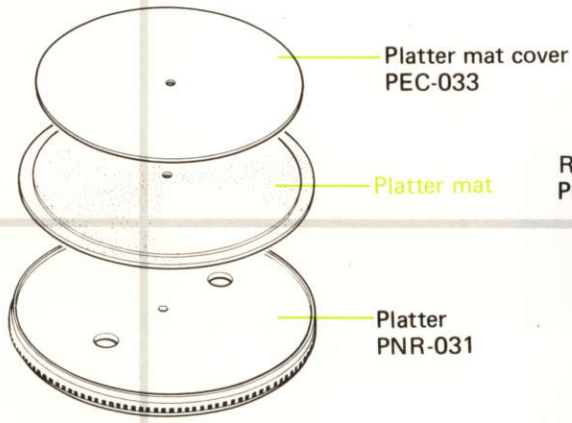

A

B

C

D

1

2

3

1

2

3

4

5

6

NOTE:
Part indicated in green type cannot be supplied.

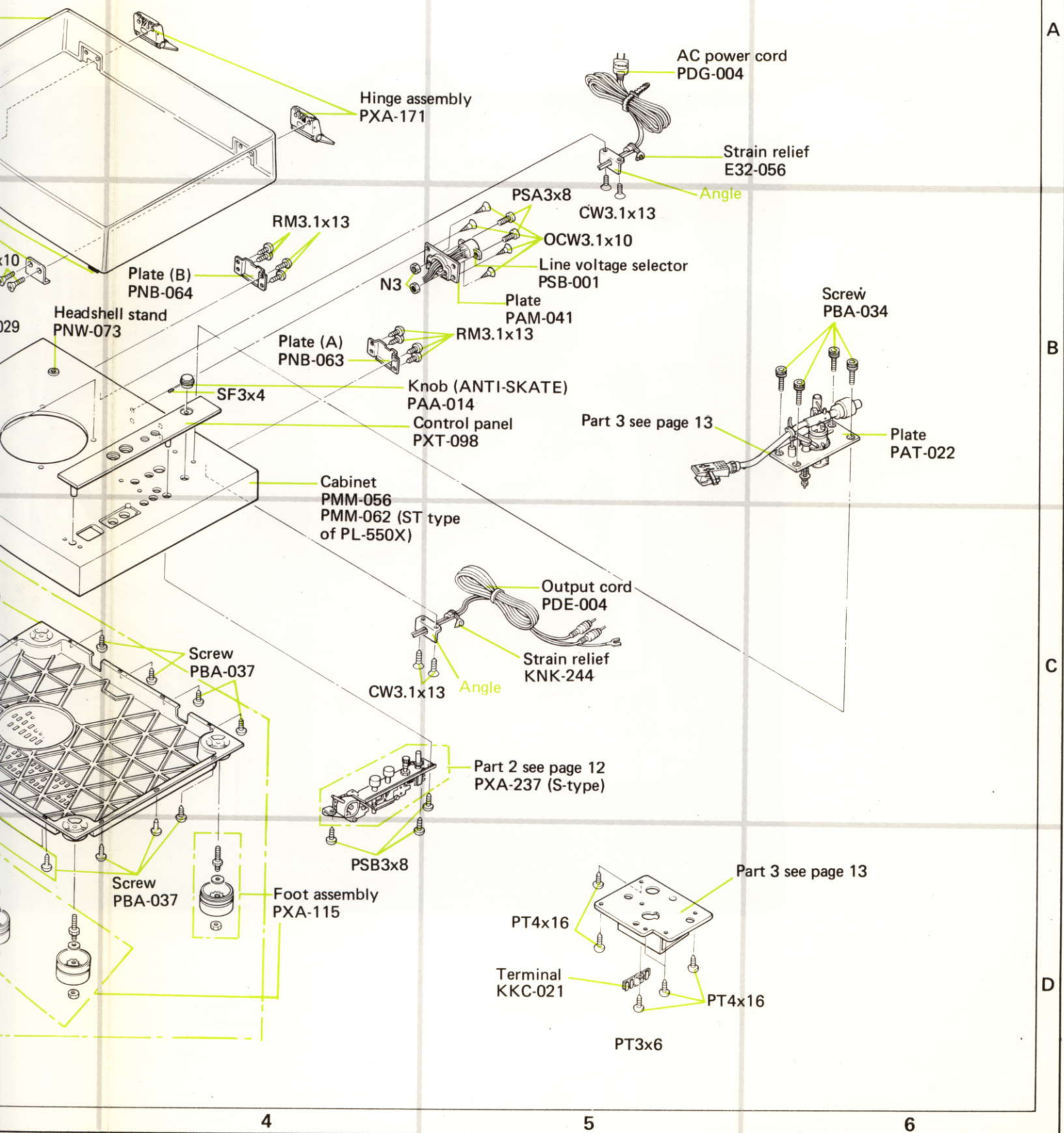

A

B

C

D

4

5

6

4.1 PART 1

NOTE:
Parts indicated in green type cannot be supplied.

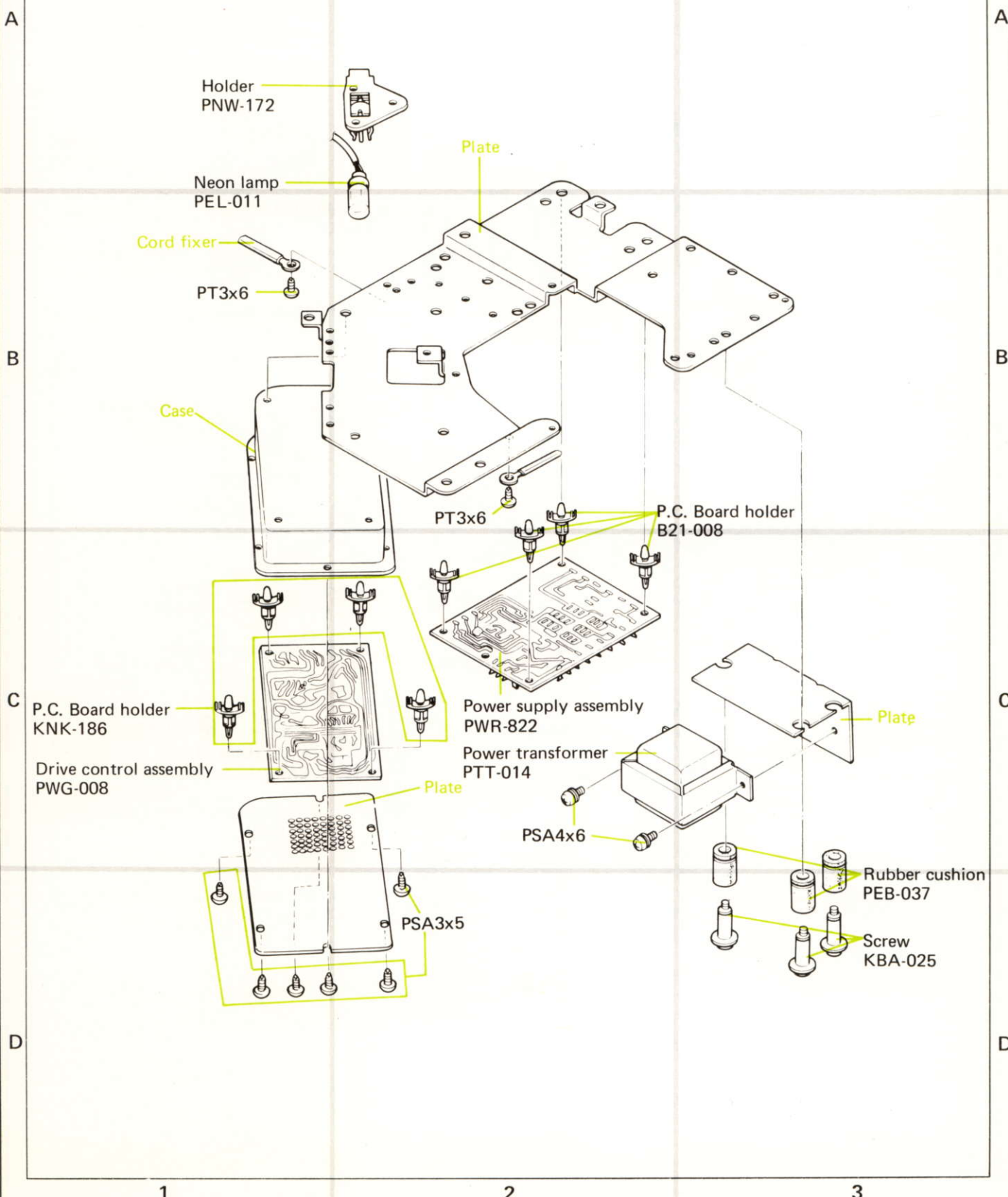

4.2 PART 2

NOTE:

Parts indicated in green type cannot be supplied.

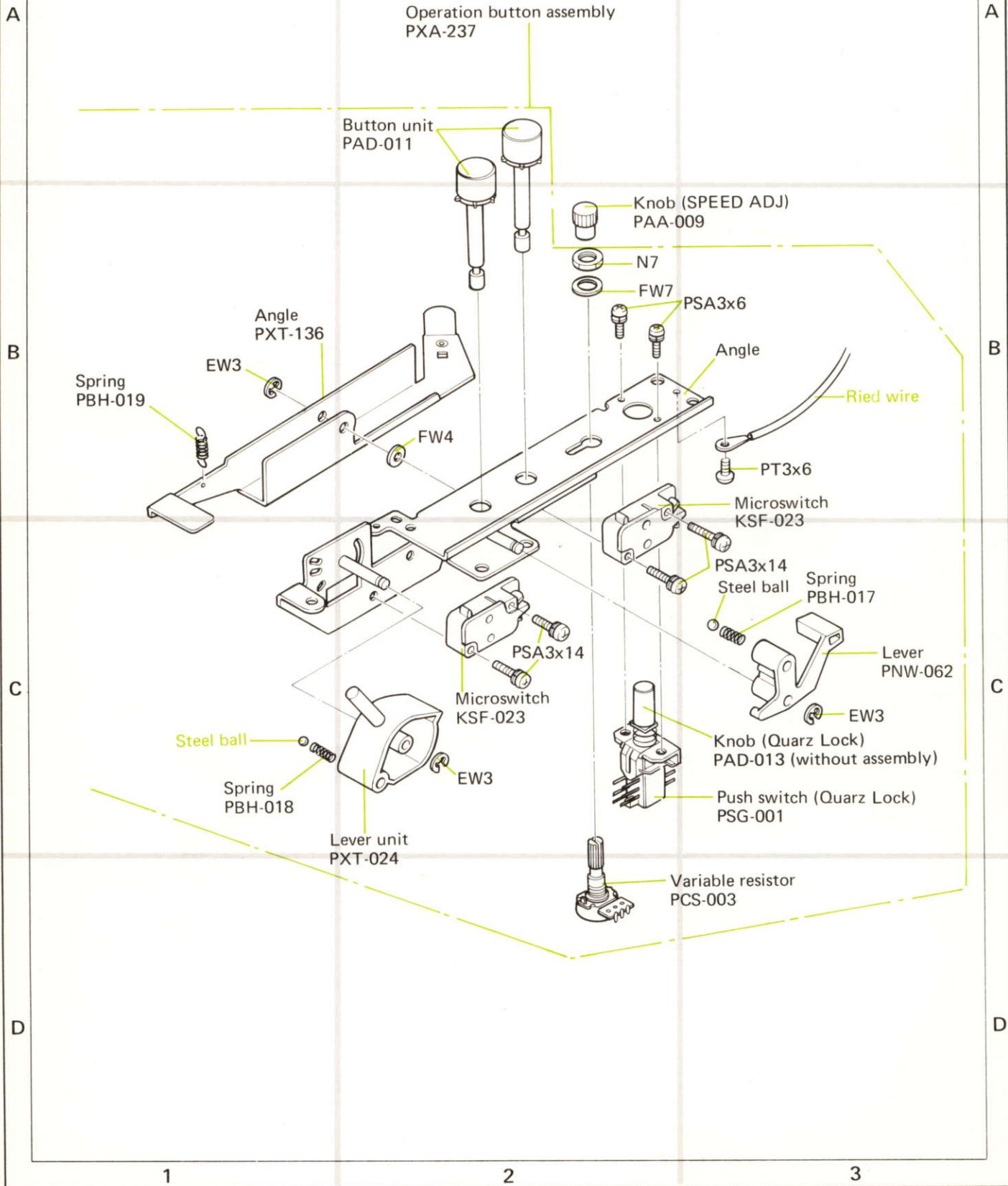





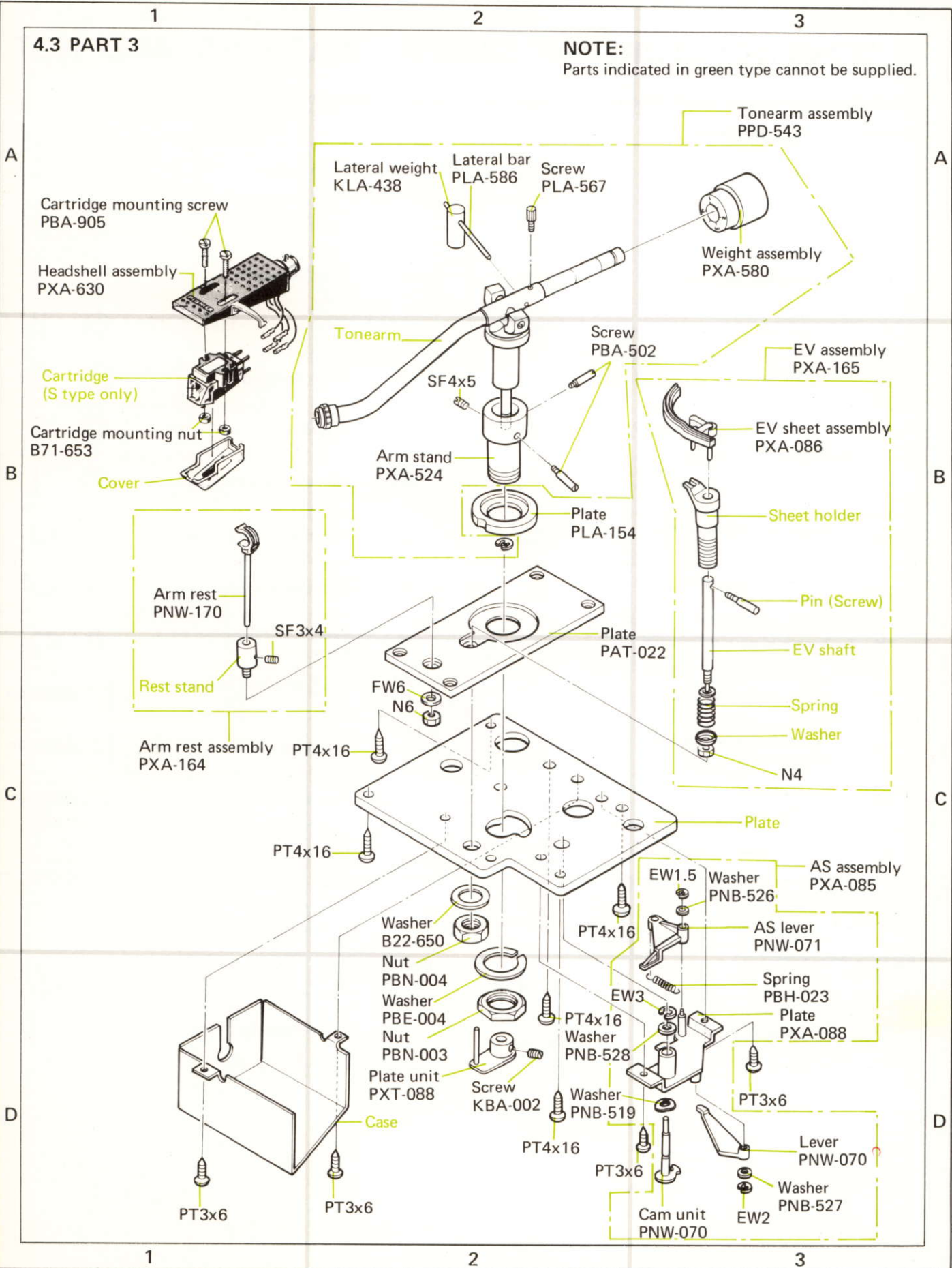









4.3 PART 3













NOTE:
Parts indicated in green type cannot be supplied.

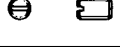

5. NOMENCLATURE OF SCREW, WASHERS AND NUT

The following symbols stand for screws, washers and nuts as shown in exploded view.

Symbol	Description	Shape
RT	Brazier head tapping screw	
PT	Pan head tapping screw	
BT	Binding head tapping screw	
CT	Countersunk head tapping screw	
TT	Truss head tapping screw	
OCT	Oval countersunk head tapping screw	
PM	Pan head machine screw	
CM	Countersunk head machine screw	
OCM	Oval countersunk head machine screw	
TM	Truss head machine screw	
BM	Binding head machine screw	
PSA	Pan head screw with spring lock washer	
PSB	Pan head screw with spring lock washer and flat washer	
PSF	Pan head screw with flat washer	

Symbol	Description	Shape
EW	E type washer	
FW	Flat washer	
SW	Spring lock washer	
N	Nut	
WN	Washer faced nut	
ITW	Internal toothed lock washer	
OTW	Outernal toothed lock washer	
SC	Slotted set screw (Cone point)	
SF	Slotted set screw (Flat point)	
HS	Hexagon socket headless set screw	
OCW	Oval countersunk head wood screw	
CW	Countersunk head wood screw	
RW	Round head wood screw	

EXAMPLE

PM · 3x8
 length in mm (l)
 diameter in mm (d)
 Symbol

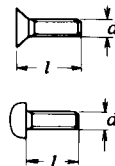

FW · 9 ϕ x 1 t
 thickness in mm (t)
 diameter in mm (d)
 Symbol

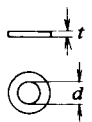

6. SCHEMATIC DIAGRAMS, P.C. BOARD PATTERNS AND

6.1 SCHEMATIC DIAGRAM

A

DRIVE CONTROL Ass'y PWG-008

B

C

D

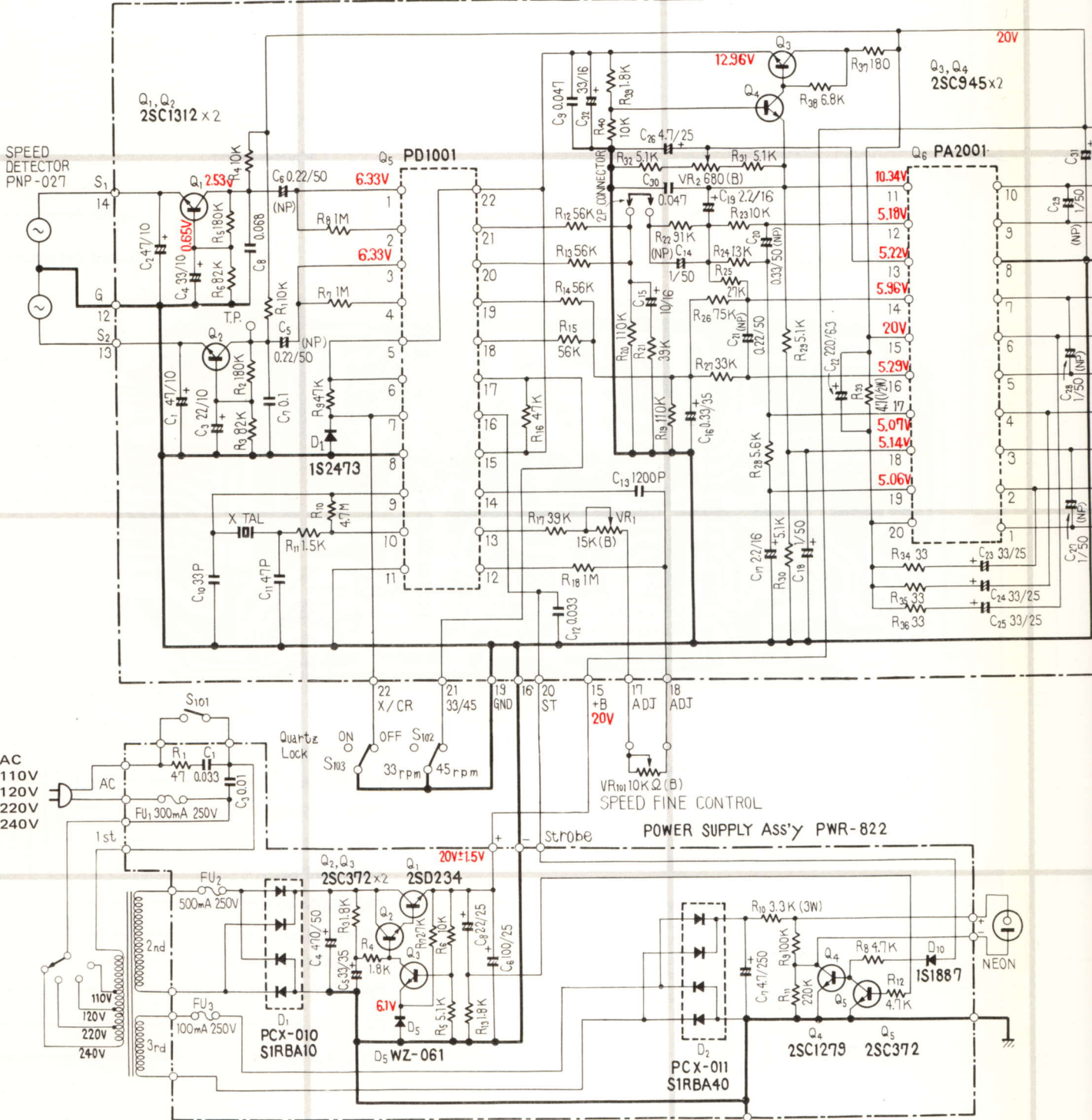

SCHEMATIC AND PARTS LIST

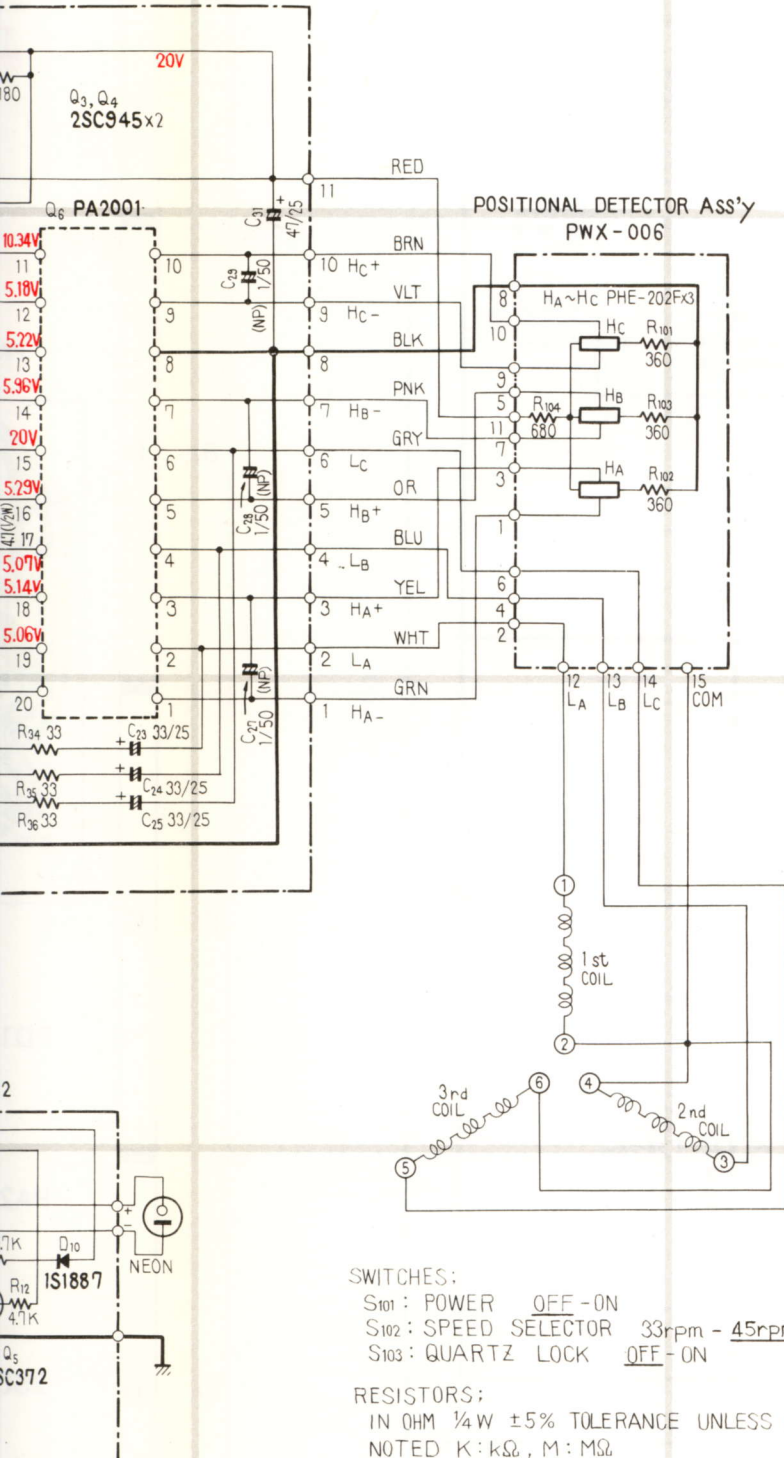

CAUTION
When Handling IC PD1001, Please Observe:
 IC PD1001 (Q5 in the Drive Control Ass'y PWG-008) is a C-MOS IC of extremely low power consumption and very high input impedance. Unless handled with special care, it could be damaged by static electricity induction. This IC is supplied with a shorting cap (of aluminum foil) attached. When soldering or performing other repair work, always attach this cap as shown below. Remove the cap after the repair has been completed.
 Also, this type of IC must not be inserted in a polystyrene package for storage.

Miscellaneous Parts List

Symbol	Description	Part No.
	Drive control assembly	PWG-008
	Positional detector assembly	PWX-006
	Power supply assembly	PWR-822
	Power transformer	PTT-014
S101	Microswitch (Power)	KSF-023
S102	Microswitch (Speed selector)	KSF-023
S103	Push switch (Quartz Lock)	PSG-001
	Neon lamp	PEL-011
	Line voltage selector	PSB-001
VR101	Variable resistor	PCS-003

SWITCHES:
 S101: POWER OFF-ON
 S102: SPEED SELECTOR 33rpm - 45rpm
 S103: QUARTZ LOCK OFF-ON

RESISTORS:
 IN OHM 1/4W ±5% TOLERANCE UNLESS OTHERWISE NOTED K:kΩ, M:MΩ

CAPACITORS:
 IN μF UNLESS OTHERWISE NOTED P:pF

A

B

C

D

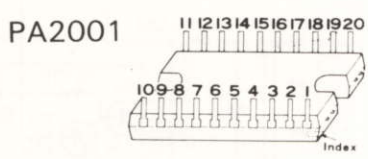
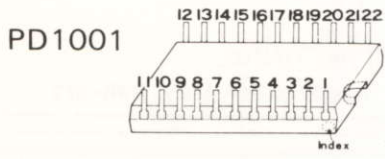
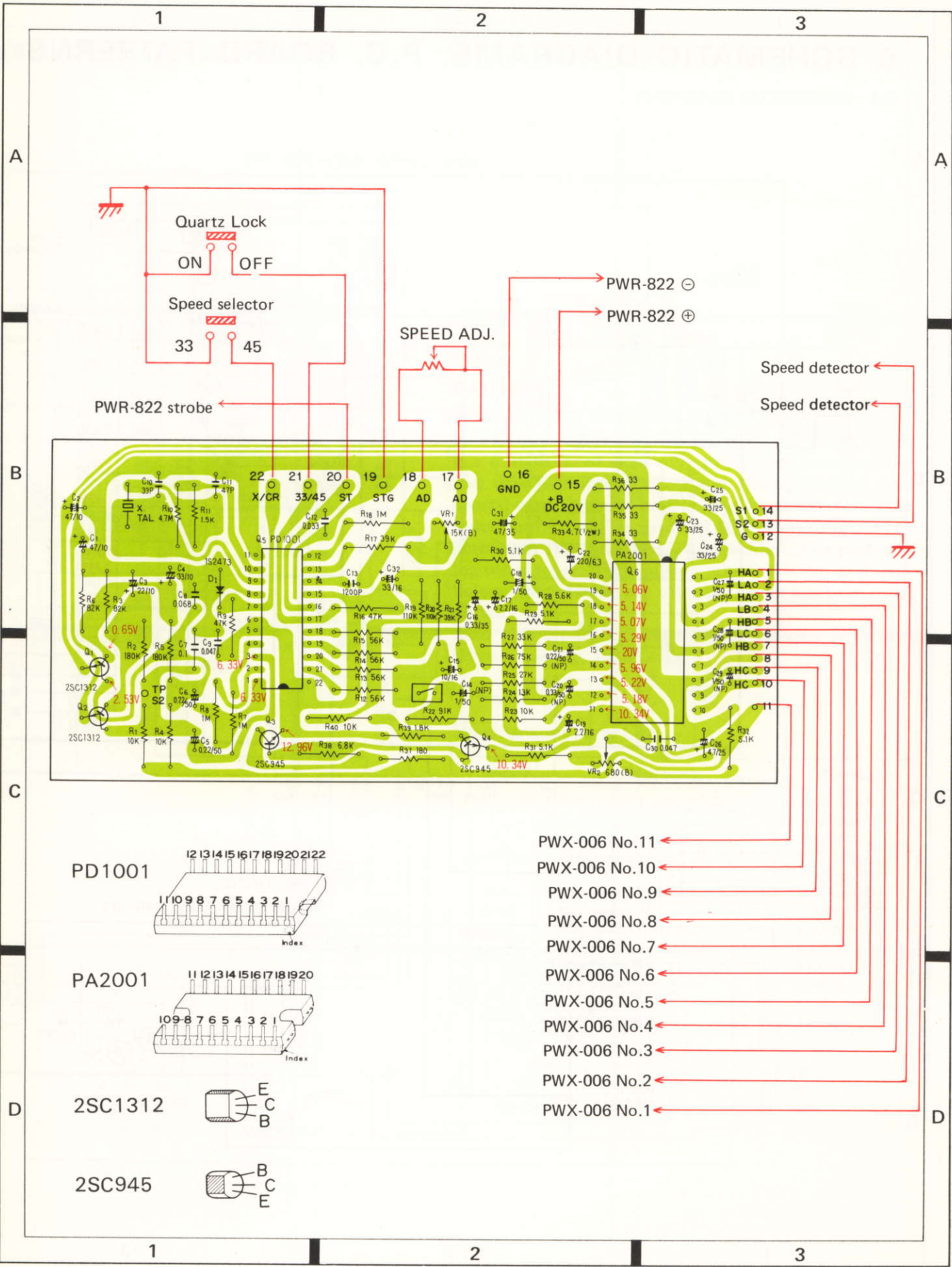

- PWX-006 No.11
- PWX-006 No.10
- PWX-006 No.9
- PWX-006 No.8
- PWX-006 No.7
- PWX-006 No.6
- PWX-006 No.5
- PWX-006 No.4
- PWX-006 No.3
- PWX-006 No.2
- PWX-006 No.1

Parts List of Drive Control Assembly (PWG-008)

SEMICONDUCTORS

Symbol	Description	Part No.
Q1	Transistor	2SC1312 H or G
Q2	Transistor	2SC1312 H or G
Q3	Transistor	2SC945 R, Q or P
Q4	Transistor	2SC945 R, Q or P
Q5	IC	PD1001
Q6	IC	PA2001
D	Diode	1S2473

RESISTORS

Symbol	Description	Part No.
VR1	Semi-fixed 15k-B	PCP-006
VR2	Semi-fixed 680-B	PCP-007
R1	Carbon film 10k	RD½PS 103J
R2	Carbon film 180k	RD½PS 184J
R3	Carbon film 82k	RD½PS 823J
R4	Carbon film 10k	RD½PS 103J
R5	Carbon film 180k	RD½PS 184J
R6	Carbon film 82k	RD½PS 823J
R7	Carbon film 1M	RD½PS 105J
R8	Carbon film 1M	RD½PS 105J
R9	Carbon film 47k	RD½PS 473J
R10	Carbon film 4.7M	RD½PS 475J
R11	Carbon film 1.5k	RD½PS 152J
R12	Carbon film 56k	RD½PS 563J
R13	Carbon film 56k	RD½PS 563J
R14	Carbon film 56k	RD½PS 563J
R15	Carbon film 56k	RD½PS 563J
R16	Carbon film 47k	RD½PS 473J
R17	Carbon film 39k	RD½PS 393J
R18	Carbon film 1M	RD½PS 105J
R19	Carbon film 110k	RD½PS 114J
R20	Carbon film 110k	RD½PS 114J
R21	Carbon film 39k	RD½PS 393J
R22	Carbon film 91k	RD½PS 913J
R23	Carbon film 10k	RD½PS 103J
R24	Carbon film 13k	RD½PS 133J
R25	Carbon film 27k	RD½PS 273J
R26	Carbon film 75k	RD½PS 753J
R27	Carbon film 33k	RD½PS 333J
R28	Carbon film 5.6k	RD½PS 562J
R29	Carbon film 5.1k	RD½PS 512J
R30	Carbon film 5.1k	RD½PS 512J
R31	Carbon film 5.1k	RD½PS 512J
R32	Carbon film 5.1k	RD½PS 512J
R33	Carbon film 4.7 ½W	RD½PS 4R7J
R34	Carbon film 33	RD½PS 330J
R35	Carbon film 33	RD½PS 330J

Symbol	Description	Part No.
R36	Carbon film 33	RD½PS 330J
R37	Carbon film 180	RD½PS 181J
R38	Carbon film 6.8k	RD½PS 682J
R39	Carbon film 1.8k	RD½PS 182J
R40	Carbon film 10k	RD½PS 103J

CAPACITORS

Symbol	Description	Part No.
C1	Electrolytic 47 10V	CEA 470P 10
C2	Electrolytic 47 10V	CEA 470P 10
C3	Electrolytic 22 10V	CEA 220P 10
C4	Electrolytic 33 10V	CEA 330P 10
C5	Electrolytic 0.22 10V	CEA R22M 50NP
C6	Electrolytic 0.22 10V	CEA R22M 50NP
C7	Mylar 0.1 50V	CQMA 104K 50
C8	Mylar 0.068 50V	CQMA 683K 50
C9	Ceramic 0.047 50V	CKDYF 473Z 50
C10	Ceramic 33p 50V	CCDCH 330J 50
C11	Ceramic 47p 50V	CCDCH 470J 50
C12	Mylar 0.033 50V	CQMA 333K 50
C13	Mylar 0.0012 50V	CQMA 122J 50
C14	Electrolytic 1 50V	CEA 010M 50NP
C15	Electrolytic 10 16V	CEA 100P 16
C16	Electrolytic 0.33 35V	CSZA R33M 35
C17	Electrolytic 2.2 16V	CSZA 2R2M 16
C18	Electrolytic 1 50V	CEA 010P 50
C19	Electrolytic 2.2 16V	CSZA 2R2M 16
C20	Electrolytic 0.33 50V	CEA R33M 50NP
C21	Electrolytic 0.22 50V	CEA R22M 50NP
C22	Electrolytic 220 6V	CEA 221P 6
C23	Electrolytic 33 25V	CEA 330P 25
C24	Electrolytic 33 25V	CEA 330P 25
C25	Electrolytic 33 25V	CEA 330P 25
C26	Electrolytic 4.7 25V	CEA 4R7P 25
C27	Electrolytic 1 50V	CEA 010M 50NP
C28	Electrolytic 1 50V	CEA 010M 50NP
C29	Electrolytic 1 50V	CEA 010M 50NP
C30	Ceramic 0.047 50V	CKDYF 473Z 50
C31	Electrolytic 47 25V	CEA 470P 25
C32	Electrolytic 33 16V	CEA 330P 16

OTHERS

Symbol	Description	Part No.
	Crystal	PSS-001
	Heat sink	PNS-002
	Angle	PNB-195
	Connector socket assembly (G)	PXA-169
	Connector pin (A)	PKP-008
	Connector pin (E)	PKP-011
	Connector pin (F)	PKP-012

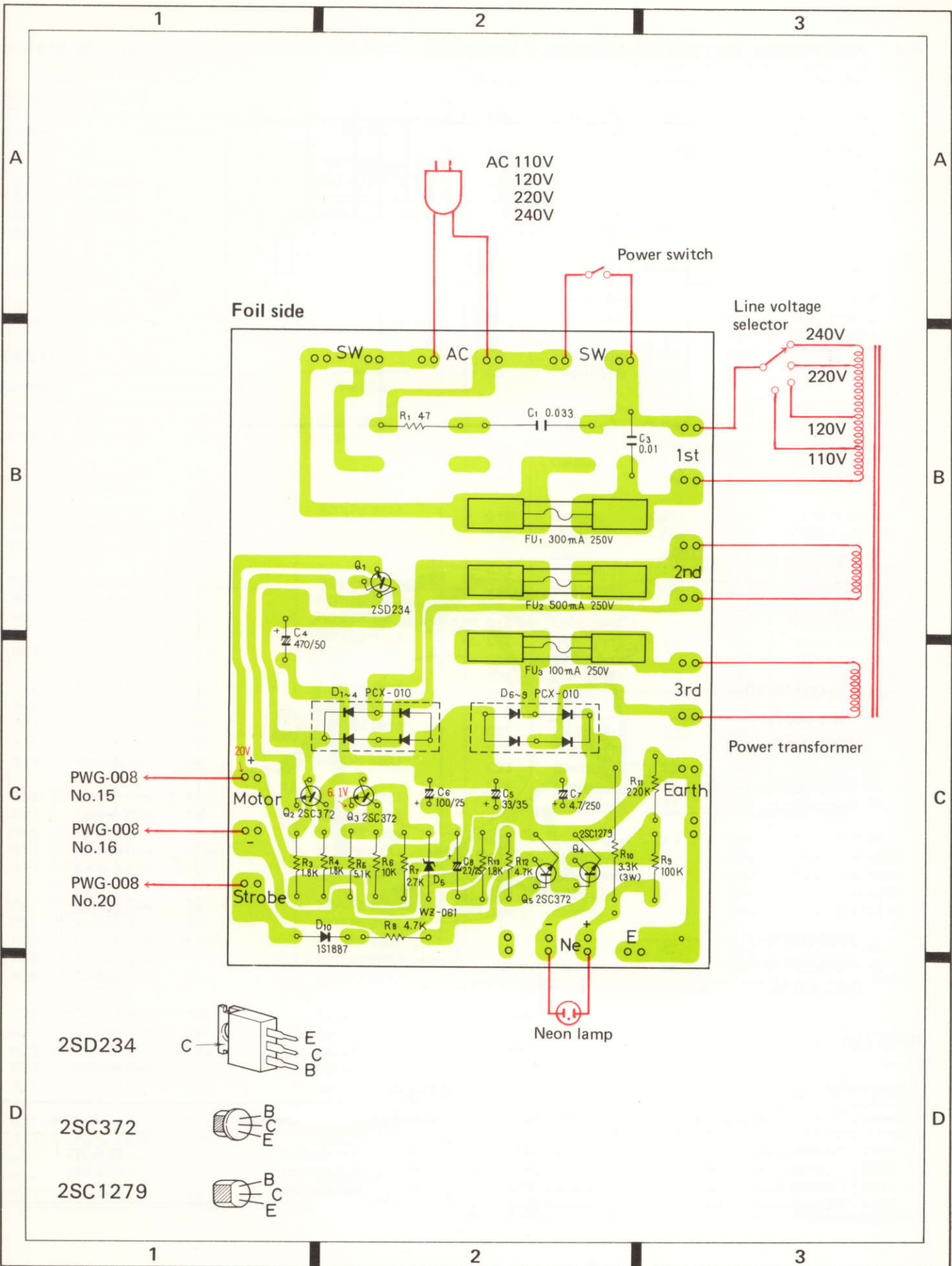

PWG-008 No.15
 PWG-008 No.16
 PWG-008 No.20

2SD234
 2SC372
 2SC1279

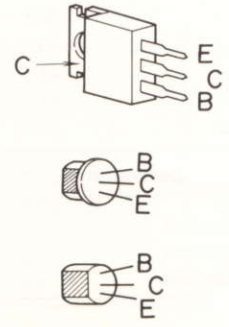

6.4 POSITIONAL DETECTOR ASSEMBLY (PWX-006)

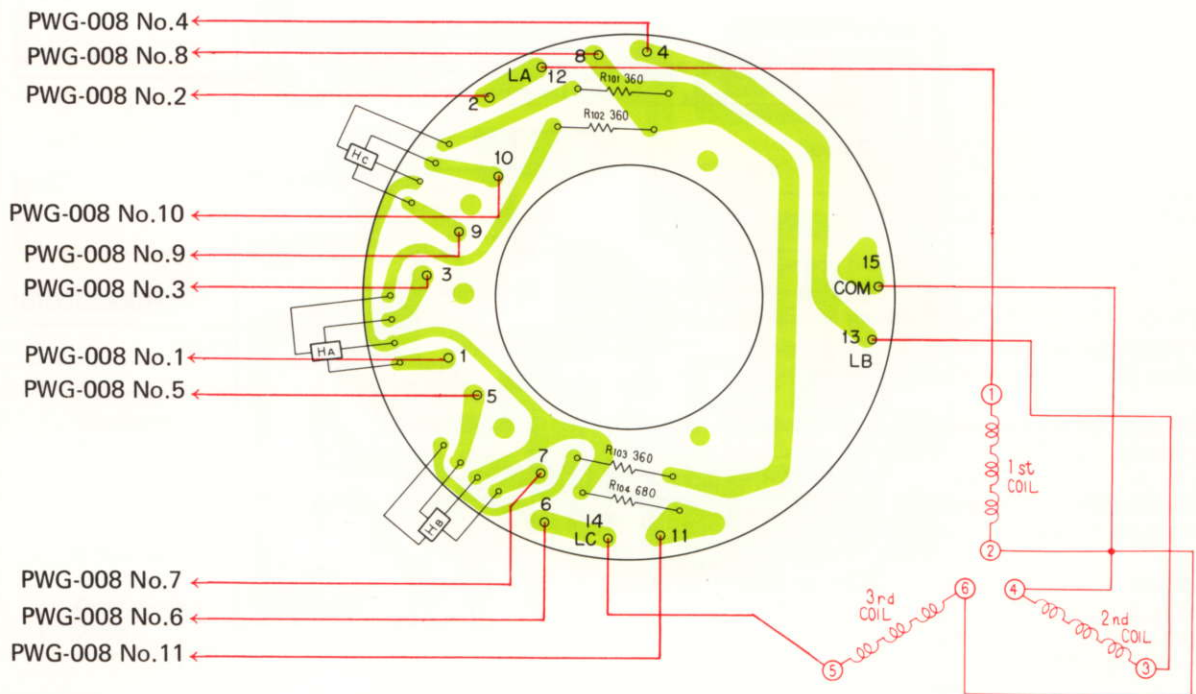
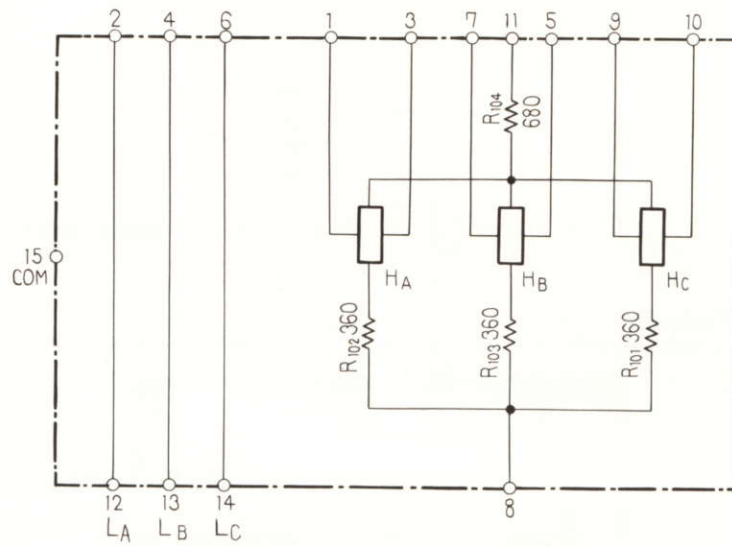

Parts List

RESISTORS

Symbol	Description	Part No.
R101	Carbon film 360	RD¼PS 361J
R102	Carbon film 360	RD¼PS 361J
R103	Carbon film 360	RD¼PS 361J
R104	Carbon film 680	RD¼PS 681J

OTHERS

Symbol	Description	Part No.
HA	Hall element	PCX-012
HB	Hall element	PCX-012
HC	Hall element	PCX-012

7. PACKING

NOTE:
Parts indicated in green type cannot be supplied.

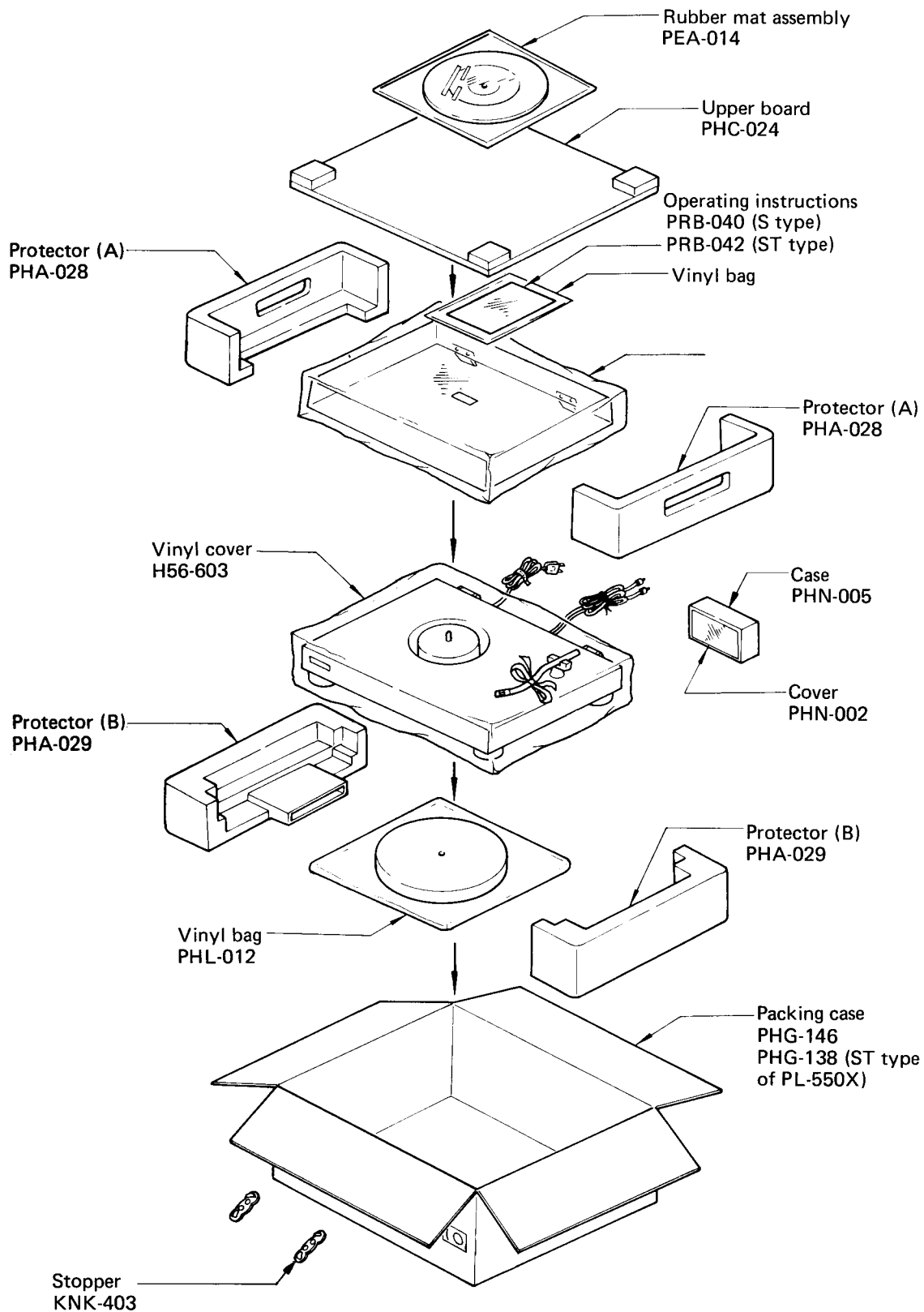

ACCESSORY

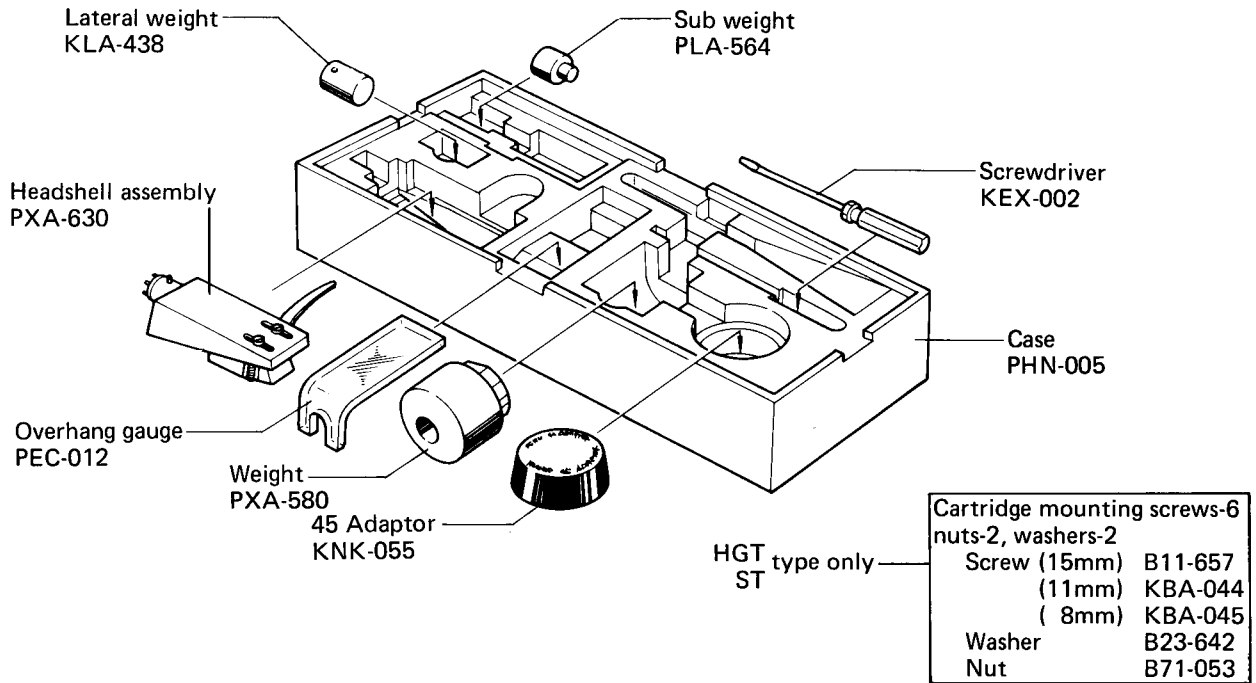

8. OPERATING PRINCIPLES, CIRCUIT DESCRIPTIONS

8.1 BLOCK DIAGRAM

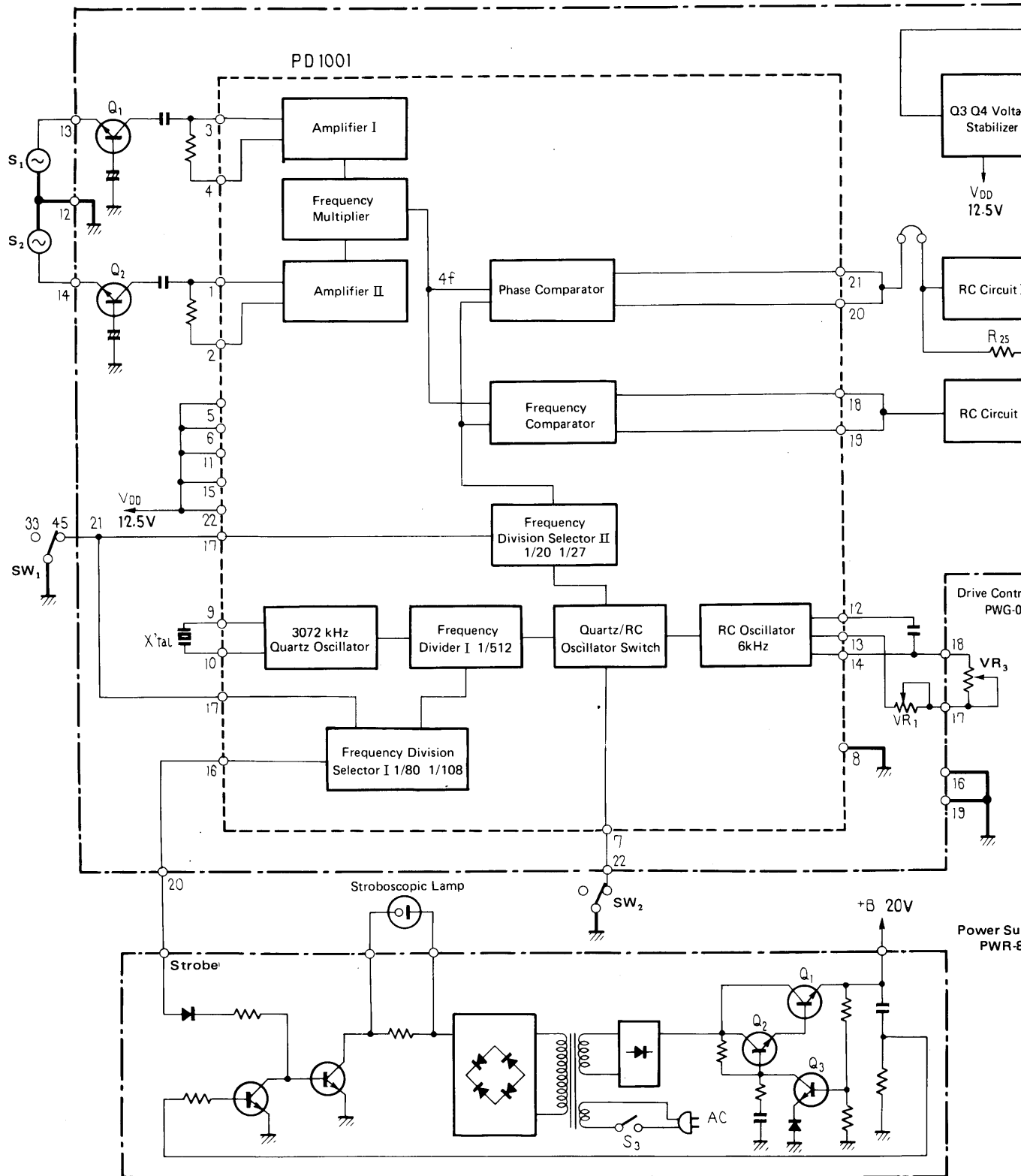

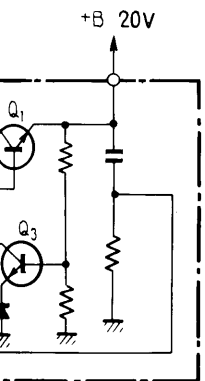
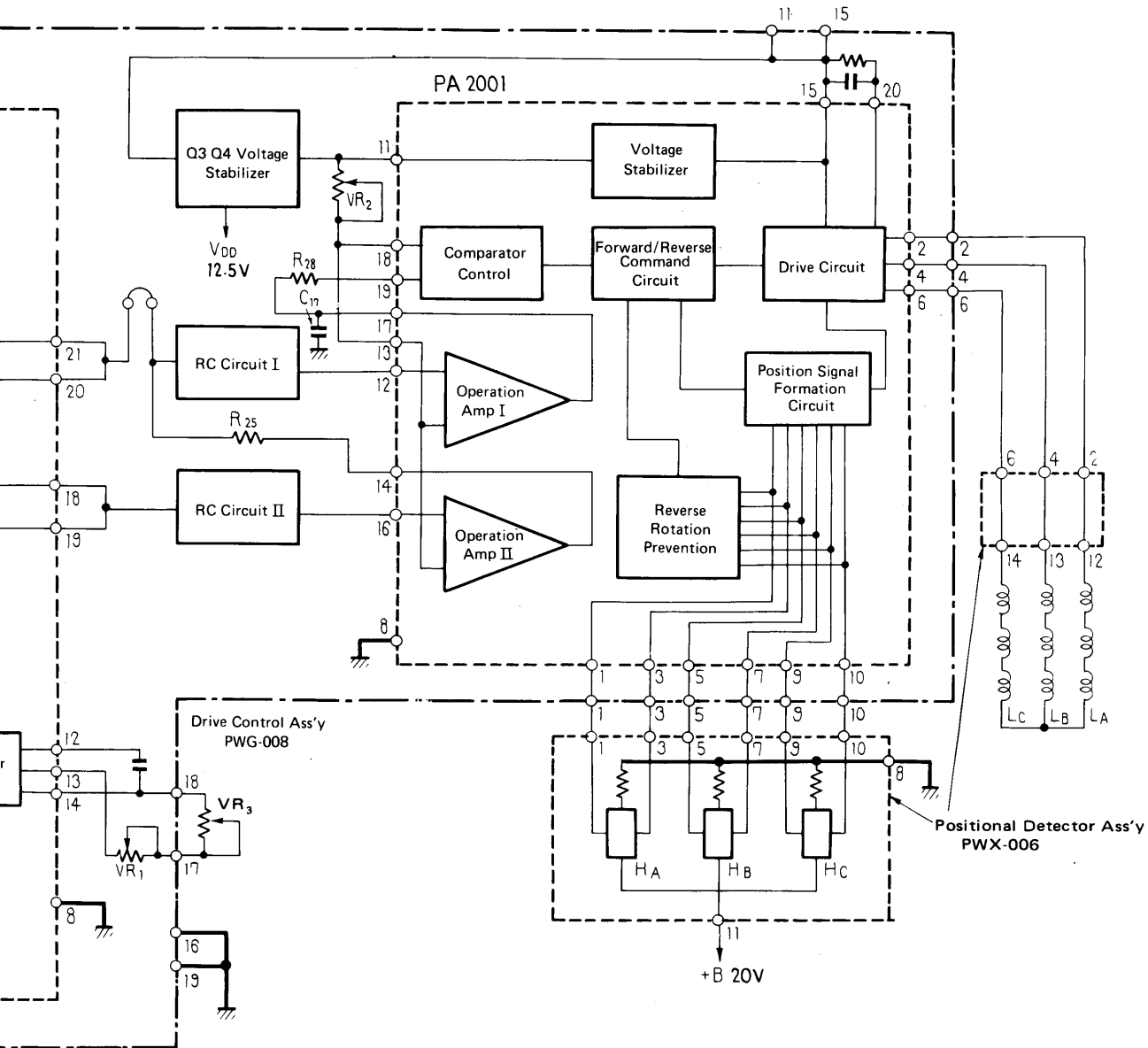

Power Supply Ass'y
PWR-822

- SW₁ SPEED SELECTOR switch
- SW₂ Quartz Lock(OFF) switch
- VR₁, VR₂. ADJ.
- VR₃ SPEED ADJ.

8.2 MOTOR OPERATION

1 Motor Construction

1. The PXM-029 is an outer-rotor brushless DC motor with 6 poles and 9 slots.
2. Motor windings are arranged in a 3-phase Y configuration. For detection of the platter position, 3 Hall elements are mounted at 40° intervals.
3. As the motor rotates, these Hall elements generate an AC voltage dependent upon the strength and direction of the magnetic flux.
4. The bottom side of the rotor magnet possesses 200 magnetic poles. As these rotate above the speed detection plate, an AC voltage is generated which serves as the speed detection signal.
5. The inner surface of the rotor magnet possesses 6 magnetic poles. As shown in Fig. 2, these are tilted by 10° relative to the vertical axis.

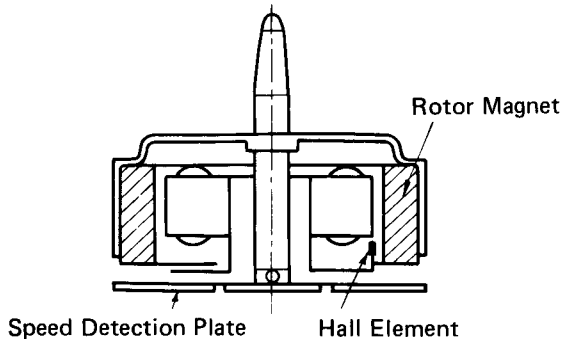

Fig. 1

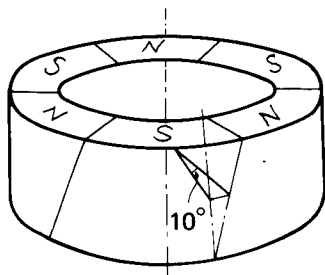

Fig. 2

2. Principle of Motor Rotation

1. Let us assume that the motor is at standstill, in the position shown in Fig. 3.
2. In this position, Hall element H_A is located next to a borderline between south and north poles, H_B next to a south pole, and H_C next to a north pole.

3. When the unit is switched on, the output voltages of the respective Hall elements will be as shown in Fig. 13-a, page 33.
4. The Hall element output is applied to the Position Signal Combination Circuit contained in IC PA2001 and utilized to control the current flowing to the motor drive coils. For further details, see paragraph "Drive Circuit." on page 30.
5. The output from the Hall elements undergoes waveform formation in the Position Signal Combination circuit. The resulting waveforms are shown in Fig. 13-b, page 33.
6. These composite signals are used to switch the drive current in such a way that each motor winding receives the proper current to polarize the magnetic poles for north, south, or OFF in the correct sequence.

In actual rotation, this happens as follows.

7. As the pole of coil L_A becomes a south pole, that of L_B becomes north, and L_C , neutral.
8. Repulsion between the S pole at L_A and the rotor S pole, and attraction between the L_B N pole and the rotor S pole exert a propulsive force on the rotor.
9. As the rotor turns through 20° of arc, the output from the Hall elements changes.
10. L_B now enters OFF state, L_C becomes a N pole, and L_A a S pole.
11. The L_C N pole now attracts the rotor S pole, and the L_A S pole attracts the rotor N pole. Rotation continues.
12. Correspondences between rotor positions and coil polarities are shown in Fig. 4, a-f.

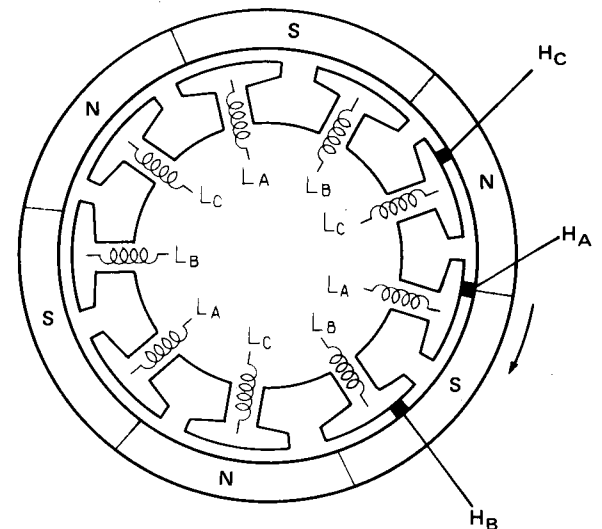

Fig. 3

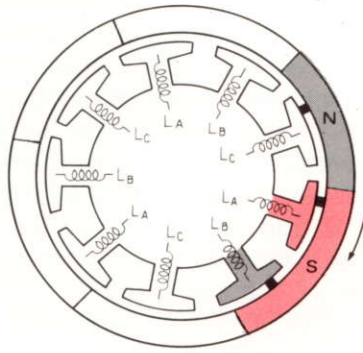

Fig. 4-a

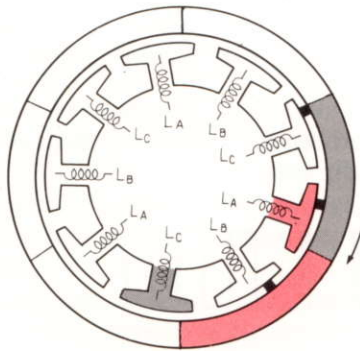

Fig. 4-b

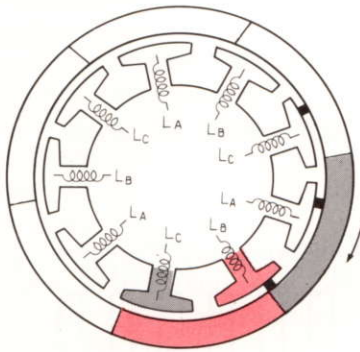

Fig. 4-c

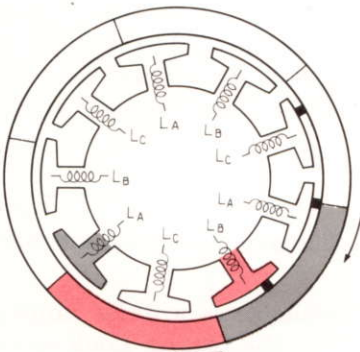

Fig. 4-d

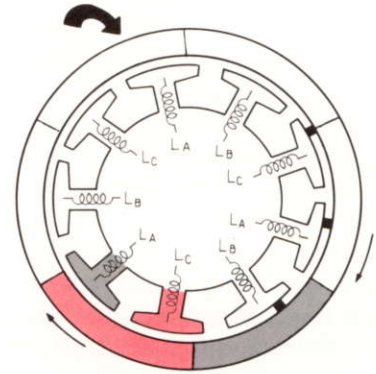

Fig. 4-e

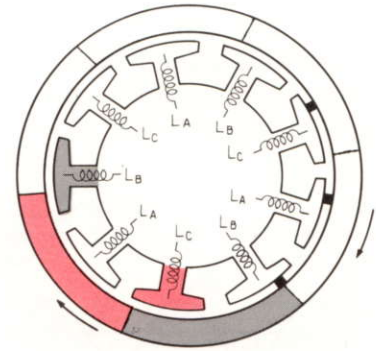

Fig. 4-f

3. Speed Detection Section

1. The speed detection plate has two rows of "detection patterns."
2. The bottom surface of the rotor is magnetized with 200 magnetic poles, and these rotate at a short distance above the speed detection plate.
3. The output voltages obtained from the inner and outer detection patterns differ 90° in phase.
4. The output voltage from the detection patterns has a frequency of 55.5Hz at 33-1/3 rpm, and of 75Hz at 45 rpm.
5. The two signals are amplified by transistors Q1 and Q2, respectively, and then supplied to IC PD1001.

4. Functions of IC=PD1001

1. When the power is turned on, the Quartz Oscillator supplies a quartz-controlled signal of 3072kHz.
2. This frequency is divided by 512 ($512 = 2^9$), becoming 6kHz. This signal then passes through the Quartz/RC Oscillator Switch and on to the Frequency Division Selector II.

3. The Frequency Division Selector I supplies a signal for the stroboscopic lamp. For this purpose, it divides by 80 (giving a signal of 75Hz for 45 rpm) or by 108 (giving a signal of 55.5Hz for 33-1/3 rpm).
4. Division in the Frequency Division Selector II is by 20 (giving 300Hz for 45 rpm) or by 27 (giving 222Hz for 33 rpm). The output signal is then passed on to the Phase Comparator and the Frequency Comparator where it is compared with the speed detection signal.
5. The speed detection signals, after amplification by Q1 and Q2 (waveforms shown in Fig. 5-a) undergo waveform formation in amplifiers AMP I and AMP II. The resultant waveforms are shown in Fig. 5-b. They then enter the Frequency Multiplication Block.

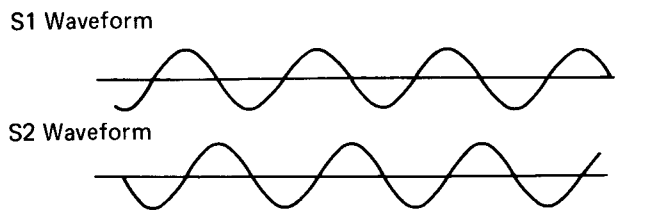

Fig. 5-a

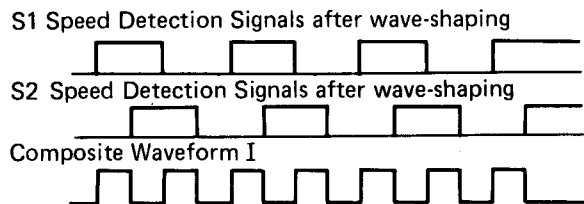

Fig. 5-b

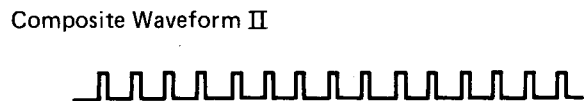

Fig. 5-c

6. In the Frequency Multiplier, the 90° phase difference between the two signals is utilized to produce, in a logic circuit, a composite signal of double frequency; this is then multiplied by 2 once again, resulting in four times the original frequency. See Fig. 5-c.
7. This Speed Detection Signal x 4 is then compared with the quartz-derived reference signal in the Phase and Frequency Comparators.

8. If the phase of the detection signal lags that of the reference signal, the combined PC output voltage (at pins 21 and 22 of PD-1001) will rise; conversely, if the detection signal phase leads that of the reference signal, PC output will drop. See Fig. 6-a. The former case indicates that turntable rotation is too slow. The latter case means that the turntable is rotating too fast.
9. Similarly, if the frequency of the detection signal is lower than that of the reference signal, the voltage of the combined FC output signal (pins 18 and 19 of PD1001) will drop. Conversely, this voltage will rise if the detection signal frequency is higher than the reference signal frequency. See Fig. 6-b. Again, the former case indicates slower than rated turntable rotation, while the latter case means faster than rated rotation.

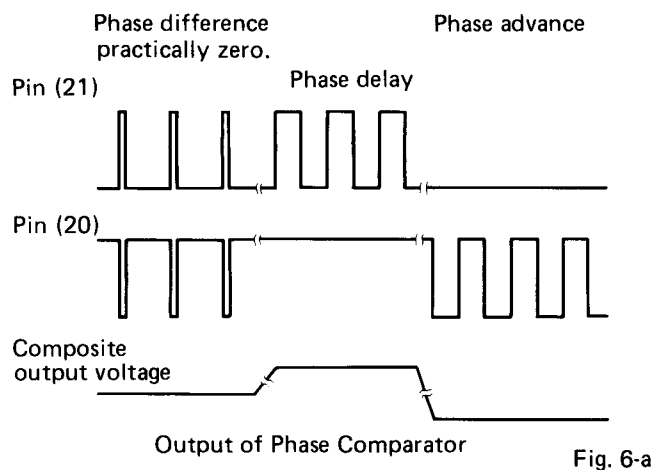

Fig. 6-a

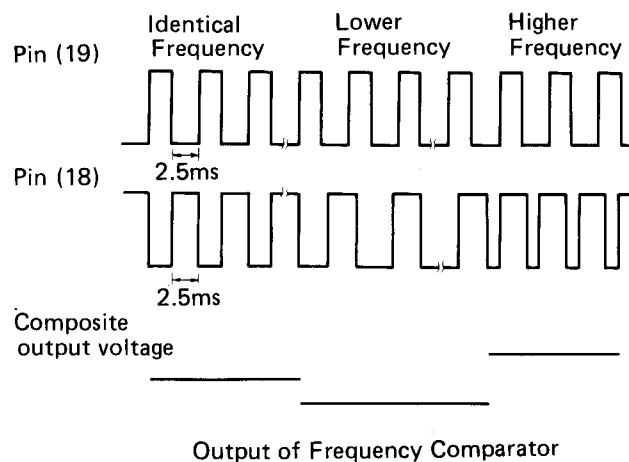

Fig. 6-b

10. The RC Oscillator is a 6kHz nonstable multivibrator. With the Quartz Lock switch in OFF position, the reference signal is obtained from the RC Oscillator and passed on to the Phase

and Frequency Comparators via the Frequency Division Selector II, much in the same way as with the quartz-derived signal.

11. In QUARTZ LOCK OFF position, the frequency of the RC Oscillator can be adjusted with the SPEED-ADJ control by $\pm 6\%$.
12. This adjustment of the RC oscillator derived reference frequency results in an equivalent change in turntable speed.

5. The Active Filter

1. The output from the Phase and Frequency Comparators contains unwanted harmonics resulting from the reference frequency and the (multiplied) speed detection signal frequency (222, 300Hz).
2. In order to remove these harmonics, an active filter is provided in the IC PA2001 (as an RC circuit in the Operation Amplifiers I & II).
3. To remove these harmonics with a low pass filter, it is necessary to provide a large amount of attenuation at the higher frequencies without causing major phase changes at the low frequencies.
4. For the output of the Phase Comparator, this attenuation is obtained in two steps: a 12dB/oct. active filter made up of a RC circuit I and Operation Amplifier I; and a passive 6dB/oct. filter consisting of R28 and C17; resulting in an overall attenuation of 18dB/oct. See Fig. 7-a.
5. For the output of the Frequency Comparator, the necessary attenuation of 12dB/oct. is obtained in the active filter formed by RC circuit II and Operation Amplifier II. The signal then passes through R25 and is combined with the Phase Comparator output.
6. Since the Frequency Comparator output passes through two active (and one passive) filters, its total high range attenuation amounts to 30dB/oct. See Fig. 7-b.
7. The cut-off frequency of each filter is set at 12Hz.
8. The active filters also function as inverting amplifiers. Their output phases are inverted relative to the Phase Comparator output. The output is the supplied to the Comparator Control Circuit.

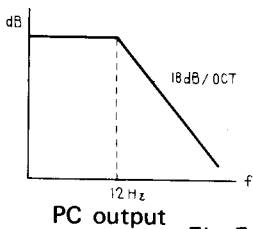

Fig. 7-a

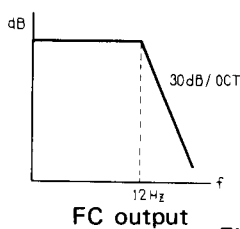
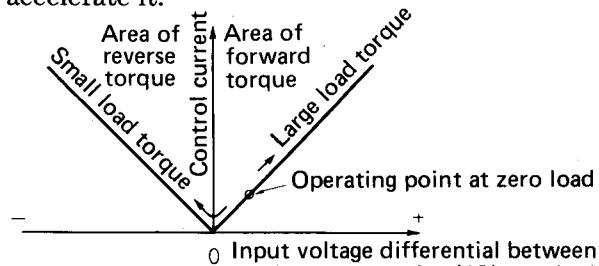

Fig. 7-b

6. Comparator Control and Forward/Reverse Command Circuit

1. Two inputs are supplied to the Control Comparator: a) a 5V reference voltage from the voltage stabilizer; and b) the output from the active filters, which serves as the detection signal.
2. If the turntable rotates faster than rated speed, the detection signal is higher than the 5V reference.
3. When this happens, the Comparator Control sends a command to the Forward/Reverse Command Circuit, telling it to apply a reverse torque to the motor to slow it down.
4. Conversely, if turntable rotation is below rated speed, the detection signal voltage will be below the 5V reference.
5. In this case, the Comparator Control indicates to the Forward/Reverse Command Circuit that forward torque must be applied to the motor to accelerate it.



V18... Voltage at pin (18)
V19... Voltage at pin (19)
Fig. 8

7. Drive Circuit

1. Switching signals obtained from the three Hall elements and having been processed in the Position Detection Signal Formation Circuit, applied to terminals a, b and c in Fig. 9, in order to switch transistors Q2 ~ Q7.
2. These signals are step waves as shown in Fig. 10, with relative phase differences of 120° between them.

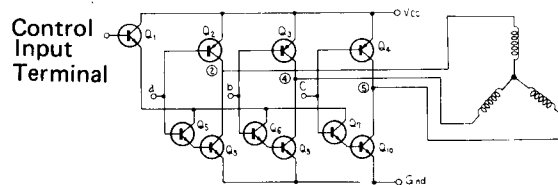

Fig. 9

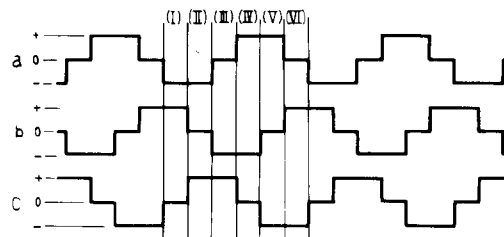

Fig. 10

- Because of the low potential at pin (a), Q2 is ON. Pin (b) is at high potential, so Q6 and Q9 are ON. Pin (c) is at standard potential — a standard bias is applied which keeps transistors Q4, Q7 and Q10 OFF.
- A current caused by voltage V_{CC} flows through Q2 — (2) — coil L_A — coil L_B — (4) — Q9, causing a north pole to appear at L_B and a south pole at L_A .
- This magnetism causes the rotor to start rotating. After 20 degrees of rotation, the signal levels at terminals a, b and c will be come as

shown in Fig. 11-b II, and the current path of the drive current is changed. After another 20 degrees of rotation, the signals become as in Fig. 11-c III, and the drive current path is changed again. This process continues, with current path changes every 20 degrees and signal levels as in Figs. 11-d IV, 11-e V, and 11-f VI, whereupon the cycle returns to 11-a and repeats.

- Also, a control signal from the Forward/Reverse Command Block is applied to the control input terminal, and this controls the current flow through the motor windings.

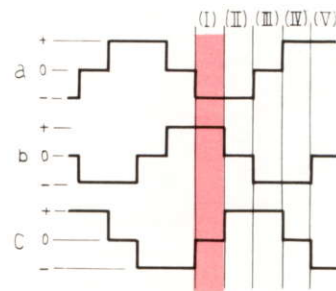
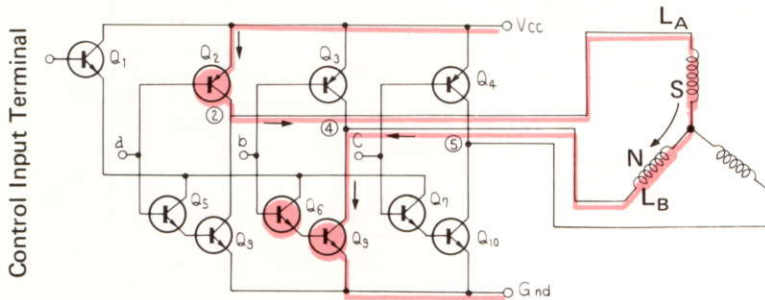

Fig. 11-a

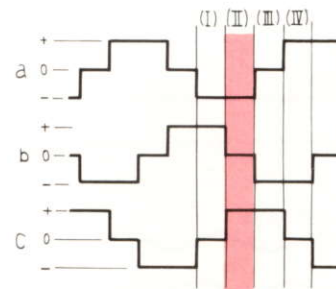
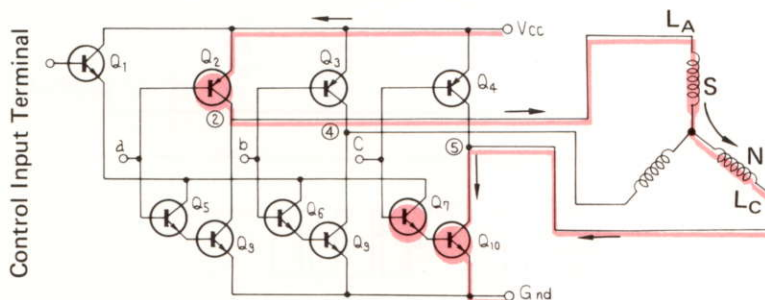

Fig. 11-b

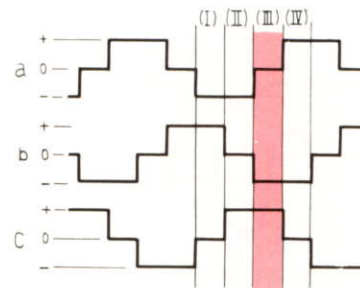
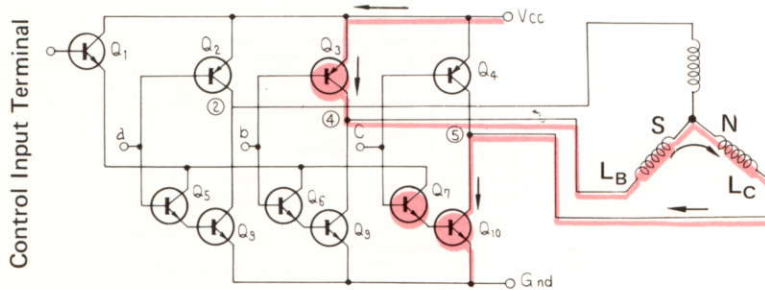

Fig. 11-c

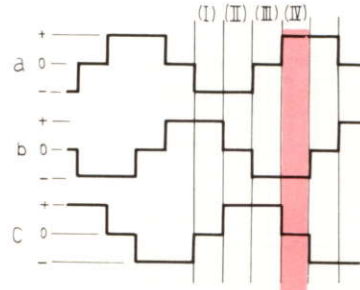
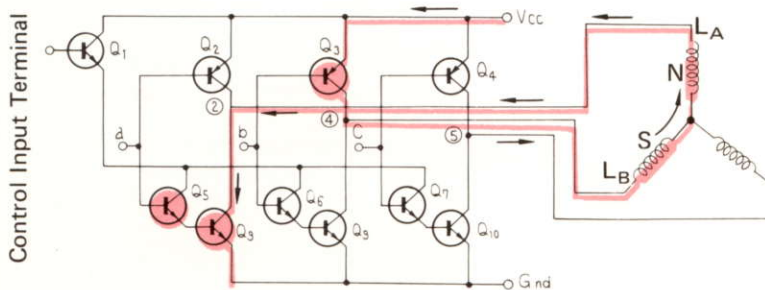

Fig. 11-d

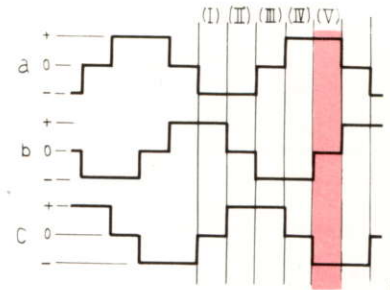
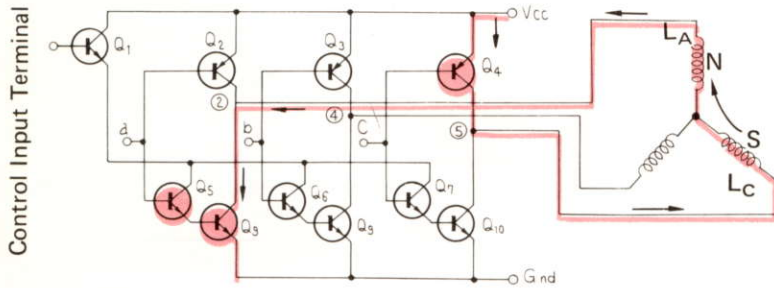

Fig. 11-e

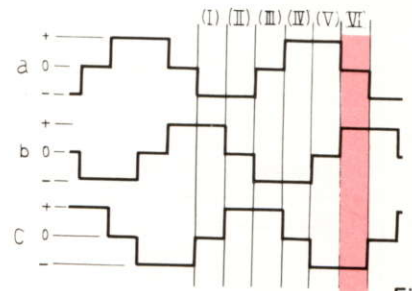
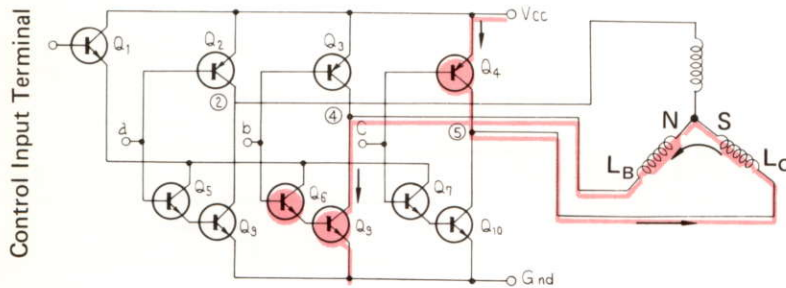

Fig. 11-f

8. Stroboscope Pulse Circuit

1. The platter has only a single row of stroboscopic markings. Switchover for 45 and 33 rpm is effected by changing the frequency of the pulse to the stroboscopic lamp.
2. From the Frequency Divider Selector I, a frequency of either 75Hz (for 45 rpm, representing 1/80 of 6000Hz) or 55.5Hz (for 33 rpm, representing 1/108) is obtained and supplied to the transistor that drives the stroboscopic lamp.

9. Reverse Rotation Prevention

1. PXM-029 operates indiscriminately in regard to the direction of rotation. If the platter is turned slowly in the reverse direction by hand, a forward torque will be applied until the platter stops, reverses its rotation and reaches rated speed in the proper direction.
2. If, however, the rotational speed in the reverse direction is in excess of 33 or 45 rpm, the Forward/Reverse Command Block may "mis-read" this as simply excessive speed ("overrun") and apply a reverse torque until rated speed is attained.
3. This reverse torque will further accelerate the turntable rotation in the reverse direction. This is known as "reverse run-away."
4. To prevent this from happening, a Reverse Rotation Prevention circuit has been included.
5. This Reverse Rotation Prevention circuit consists of two flip-flops and AND gates See Fig. 12.
6. The input for this circuit is derived from the Hall element position detection signals processed in the Reverse Rotation Prevention circuit.

7. As long as the platter is rotating in the proper direction, this pulse enters in the order B - A - C, and no "reverse" command is generated.
8. If, however, the platter rotates in the reverse direction, the pulse order becomes A - B - C, and a corrective command is given to the Forward/Reverse Command Circuit.

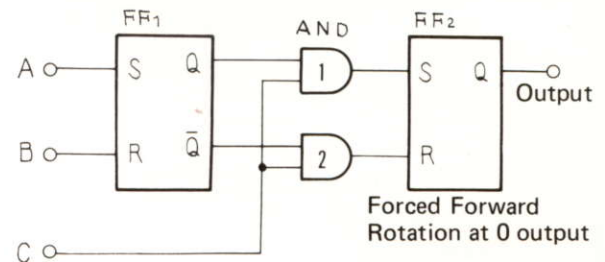
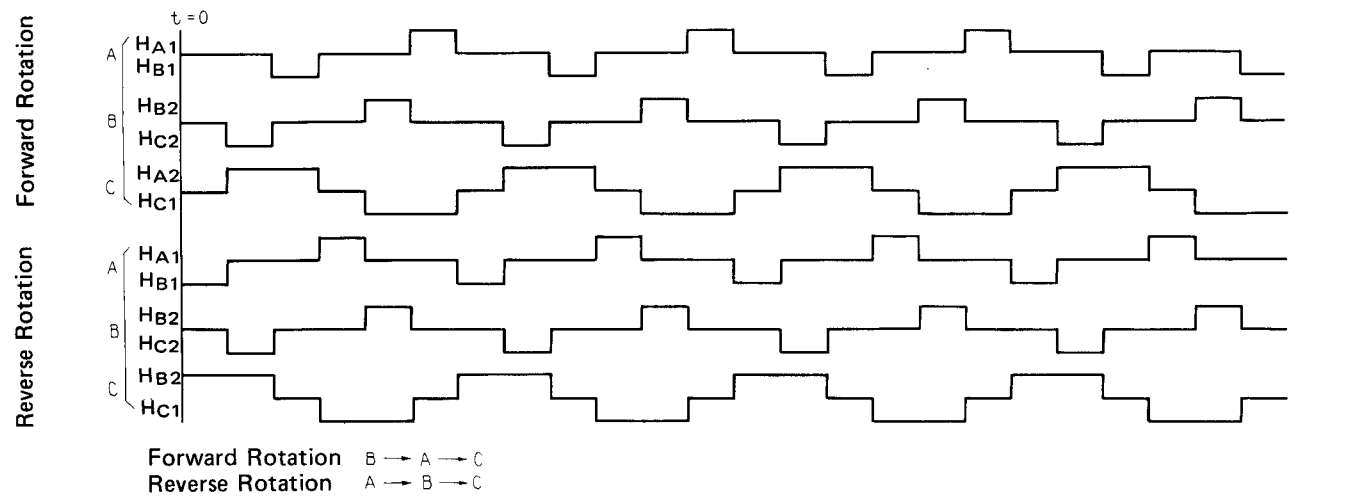
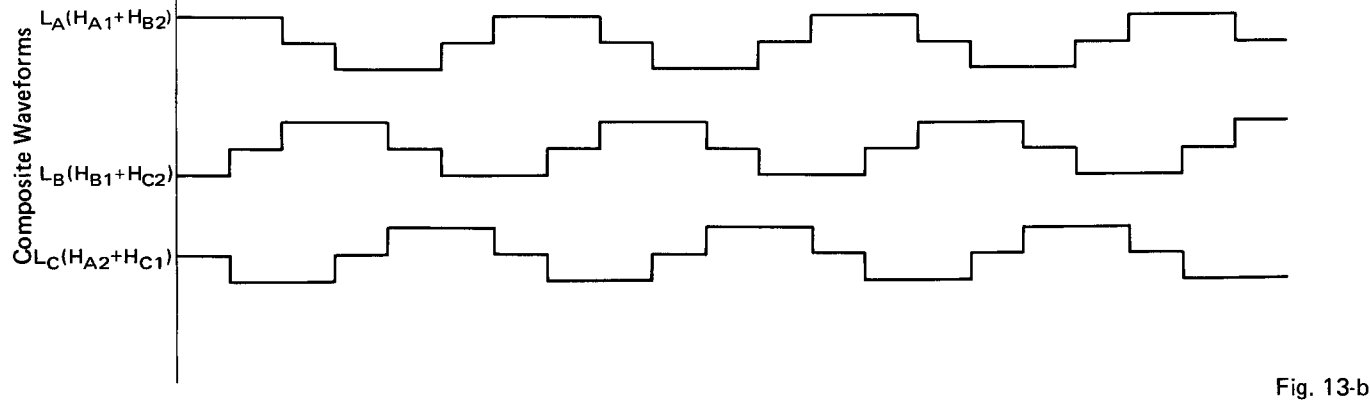
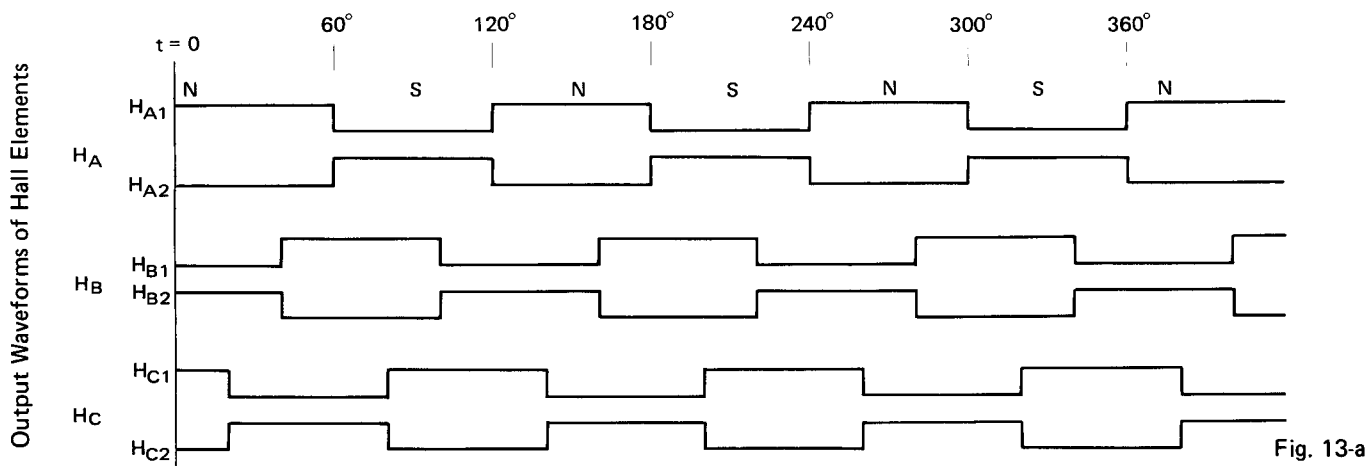

Fig. 12

	FF ₁				C	AND		FF ₂
	S	R	Q	\bar{Q}		1 _{out}	2 _{out}	
Forward rotation	B	0	1	0	1	0	0	—
	↓							
	A	1	0	1	0	0	0	—
Reverse rotation	↓							
	C	0	0	1	0	1	1	1
	A	1	0	1	0	0	0	—
Reverse rotation	↓							
	B	0	1	0	1	0	0	—
	C	0	0	0	1	1	0	1

Fig. 12 Truth table



8.3 WAVEFORMS

<PWG-008>

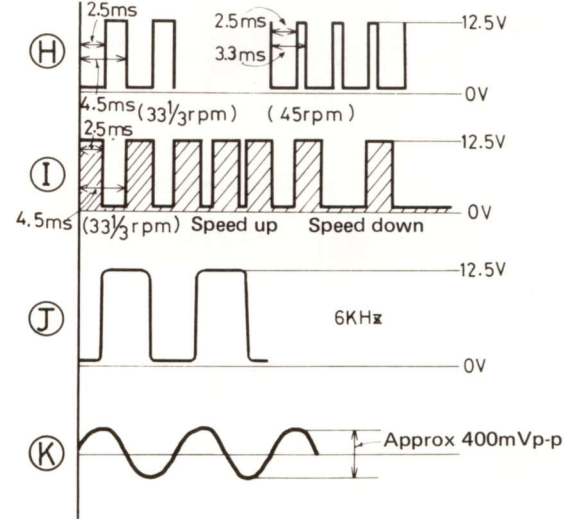
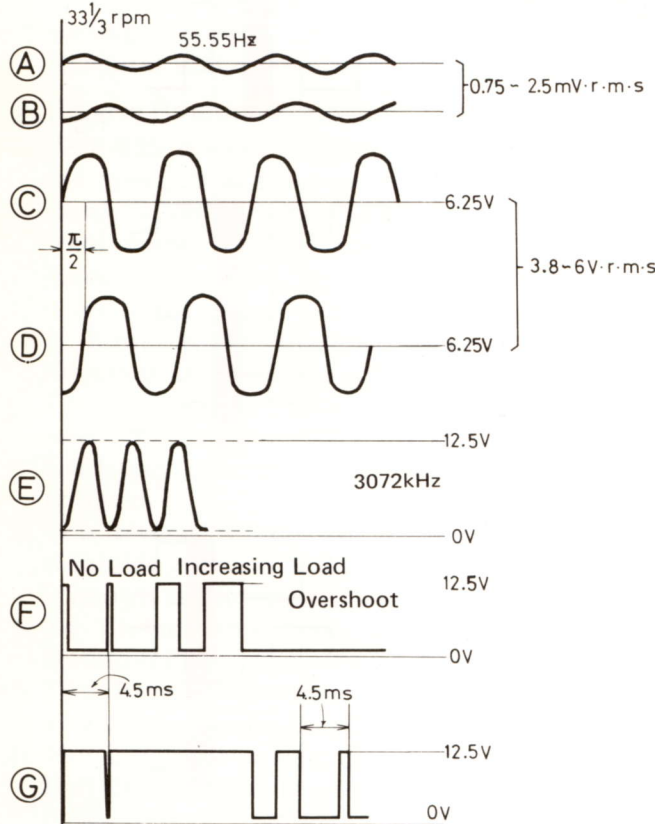
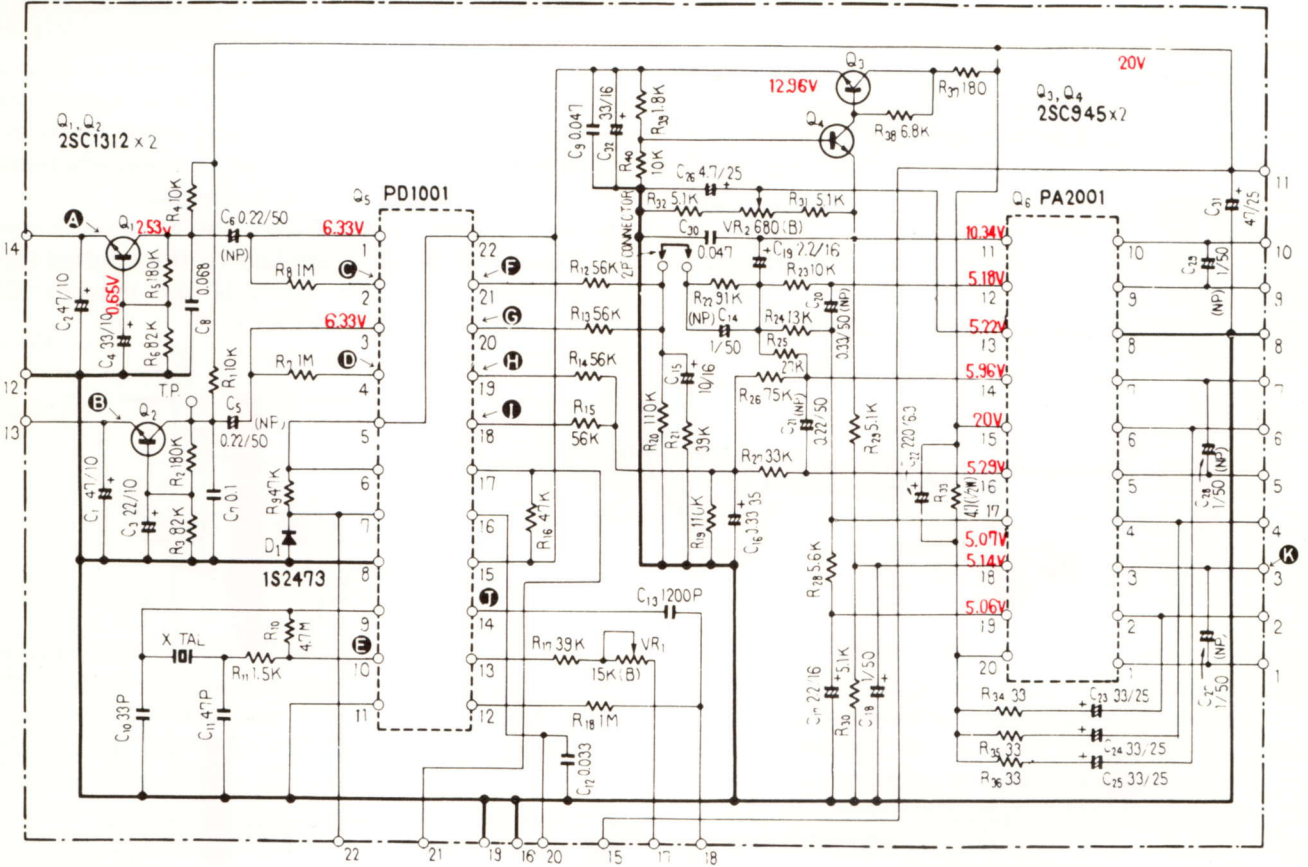

9. TROUBLESHOOTING GUIDE

9.1 MOTOR DOES NOT ROTATE

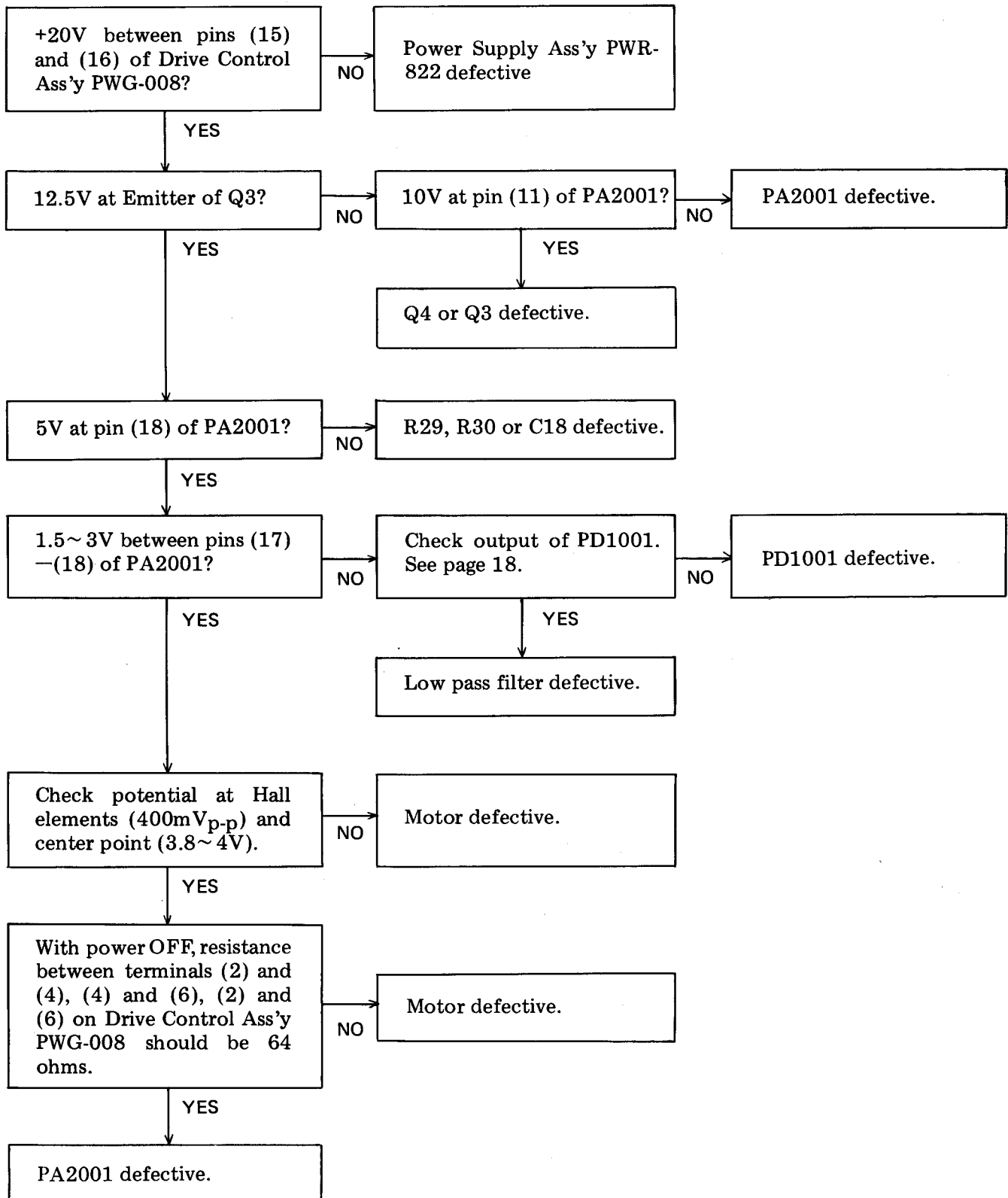

9.2 MOTOR RUN-AWAY

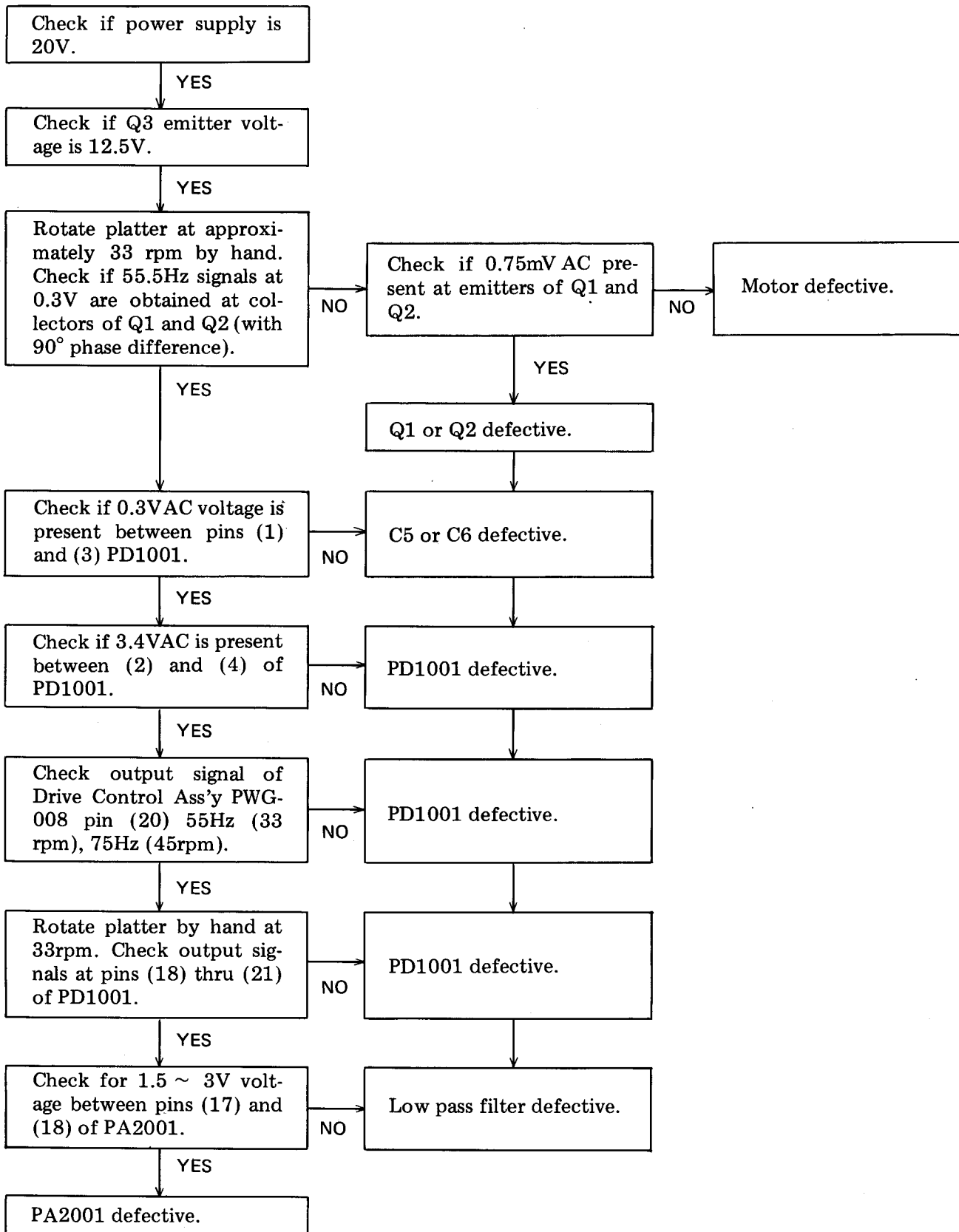

9.3 MOTOR ALTERNATES BETWEEN FORWARD AND REVERSE ROTATION

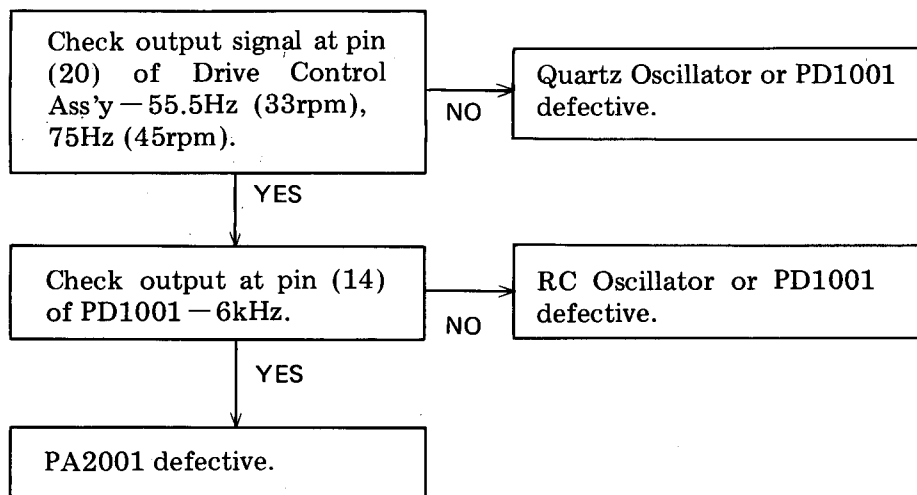

9.4 UNSTABLE ROTATION NEAR RATED SPEED

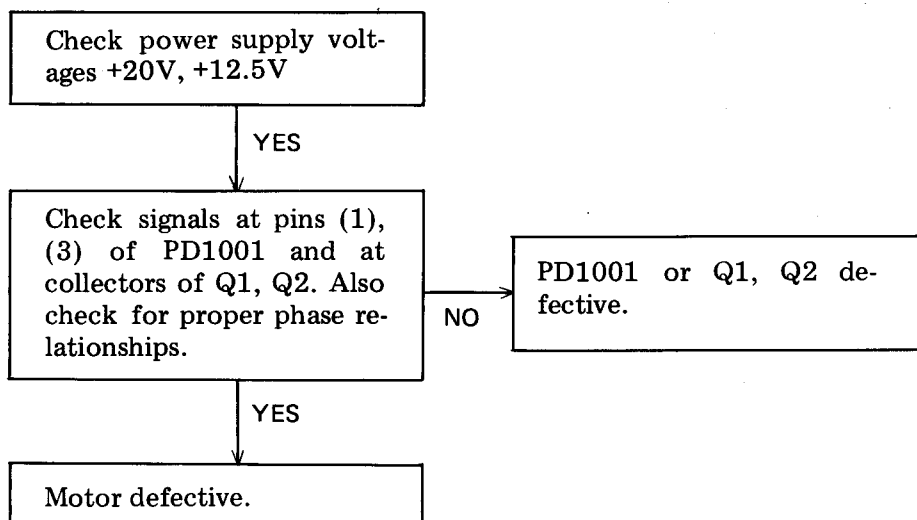

10. ADJUSTMENT PROCEDURES

1. Adjustment of PA2001 Operating Point

This adjustment is necessary whenever PA2001 has been replaced or repairs have been performed on the RC low pass filter ass'y or the power supply circuits.

As the PXM-029 utilizes a phase comparator and frequency comparator combination, the operating points of these comparators must be adjusted.

- Set unit in QUARTZ LOCK ON mode, 33 rpm.
- Unplug jumper connector from Drive Control Ass'y PWG-008.
- Adjust white potentiometer VR2 until stroboscope comes to a standstill. See Fig. 15.

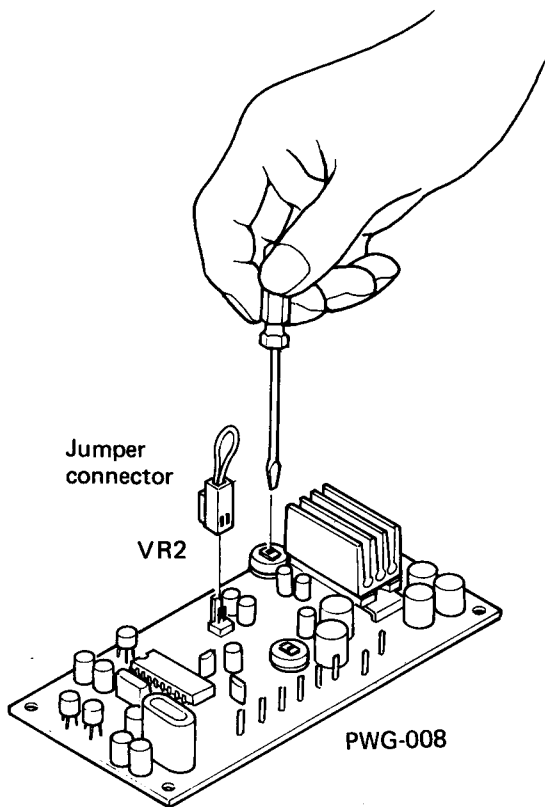

Fig. 15

2. Speed Adjustment

This adjustment is needed when proper speed cannot be obtained with the SPEED ADJ control in QUARTZ LOCK OFF mode.

- Set SPEED ADJ control at mechanical center position.
- Adjust blue potentiometer VR1 on Drive Control Ass'y PWG-008 until stroboscope comes to a standstill. See Fig. 16.

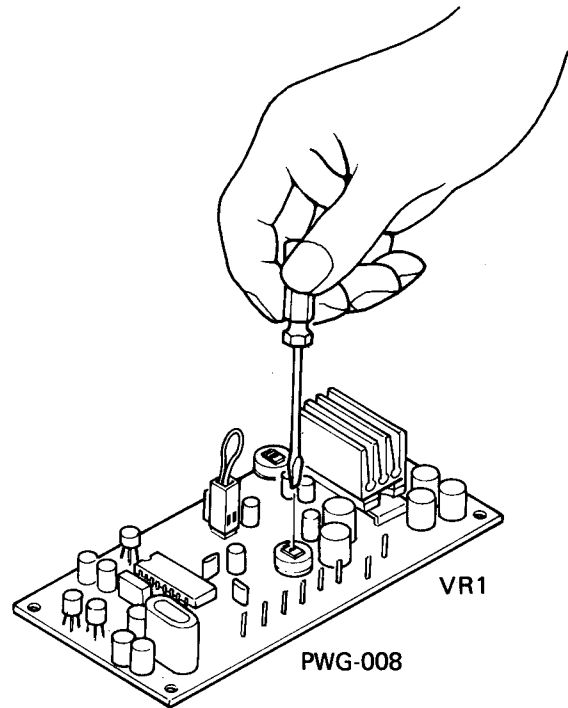
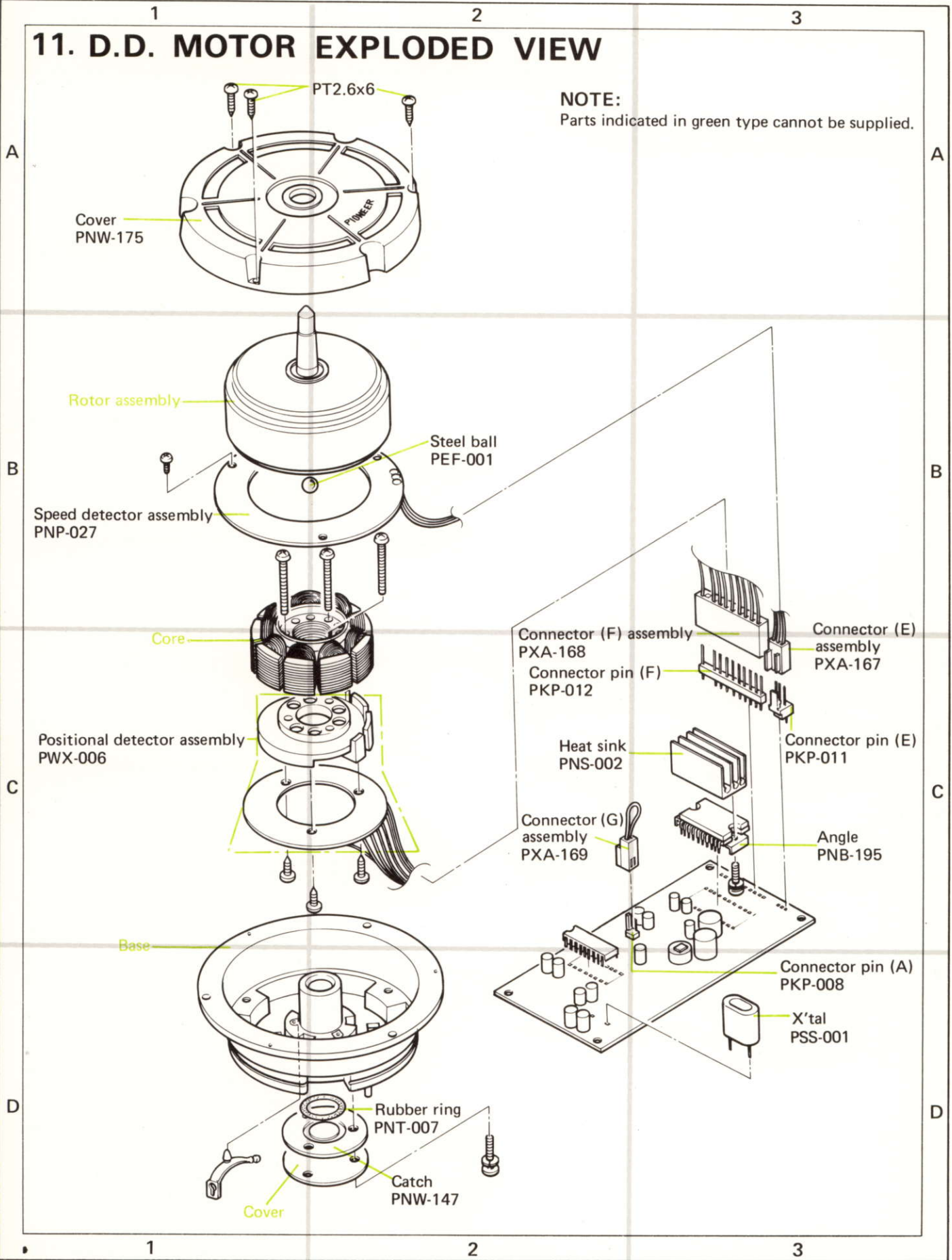

Fig. 16

11. D.D. MOTOR EXPLODED VIEW

NOTE:
Parts indicated in green type cannot be supplied.



The following locations in the text are incorrect. Please perform the corrections shown below.

4 EXPLODED VIEW (on page 11, 12)

	Incorrect	Correct
Page 11 2-B	D.D. Motor (see page 39)	D.D Motor (see page 41)
Page 11 2-C	PART 1 (see page 11)	PART 1 (see page 13)
Page 12 5-B	PART 3 (see page 13)	PART 3 (see page 15)
Page 12 5-C	PART 2 (see page 12)	PART 2 (see page 14)
Page 12 6-D	PART 3 (see page 13)	PART 3 (see page 15)

- Please paste the following illustration below the table on page 18 (in 6-D).

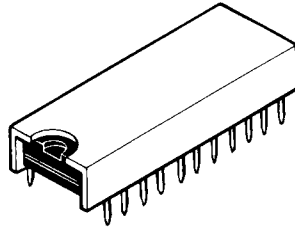

1459

DIRECT DRIVE TURNTABLE

PL-550

HGT

Additional

Service Manual

 **PIONEER®**

12. HGT TYPE EXPLODED VIEW

NOTE:

Parts indicated in green type cannot be supplied.

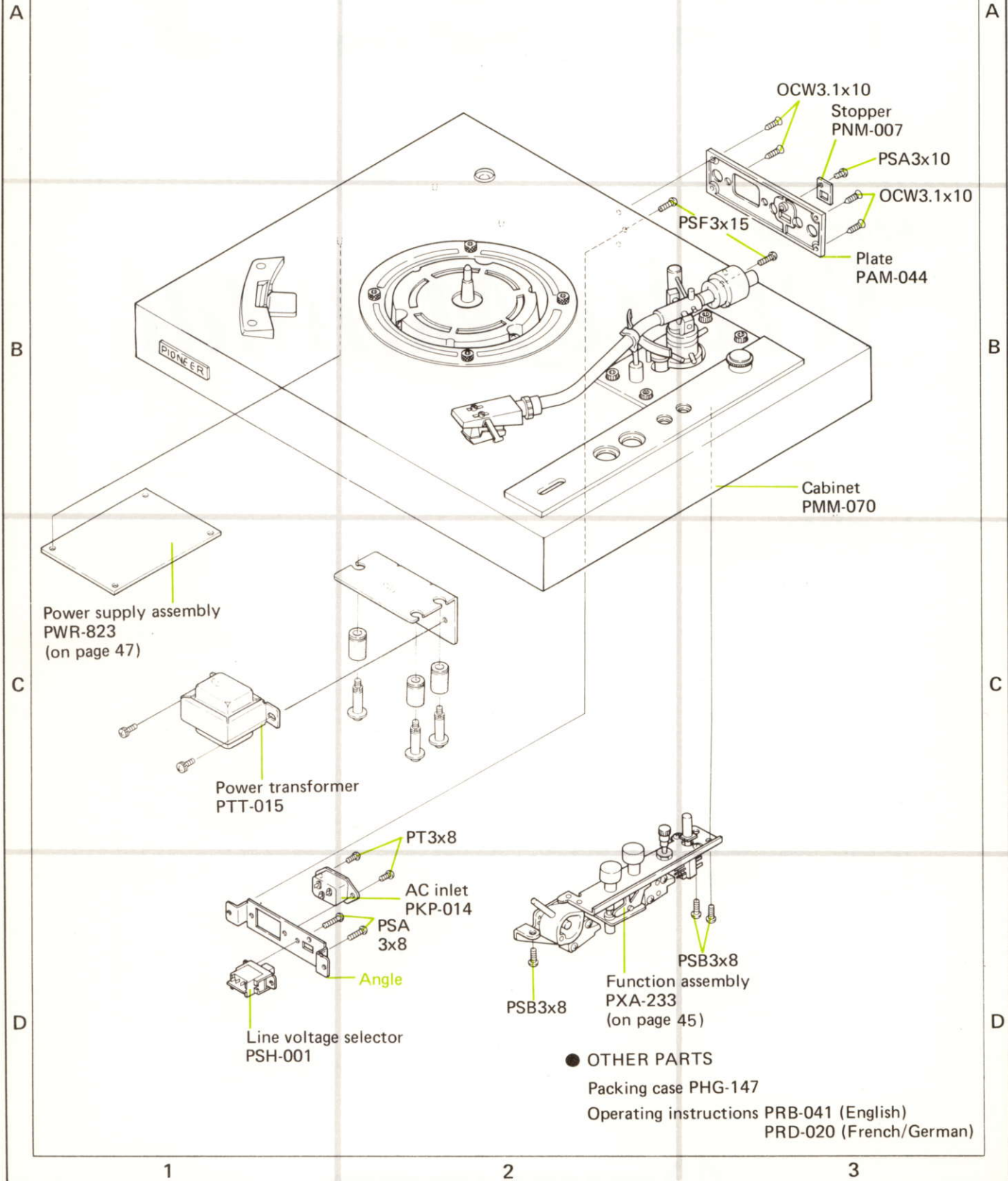

● **OTHER PARTS**

- Packing case PHG-147
- Operating instructions PRB-041 (English)
- PRD-020 (French/German)

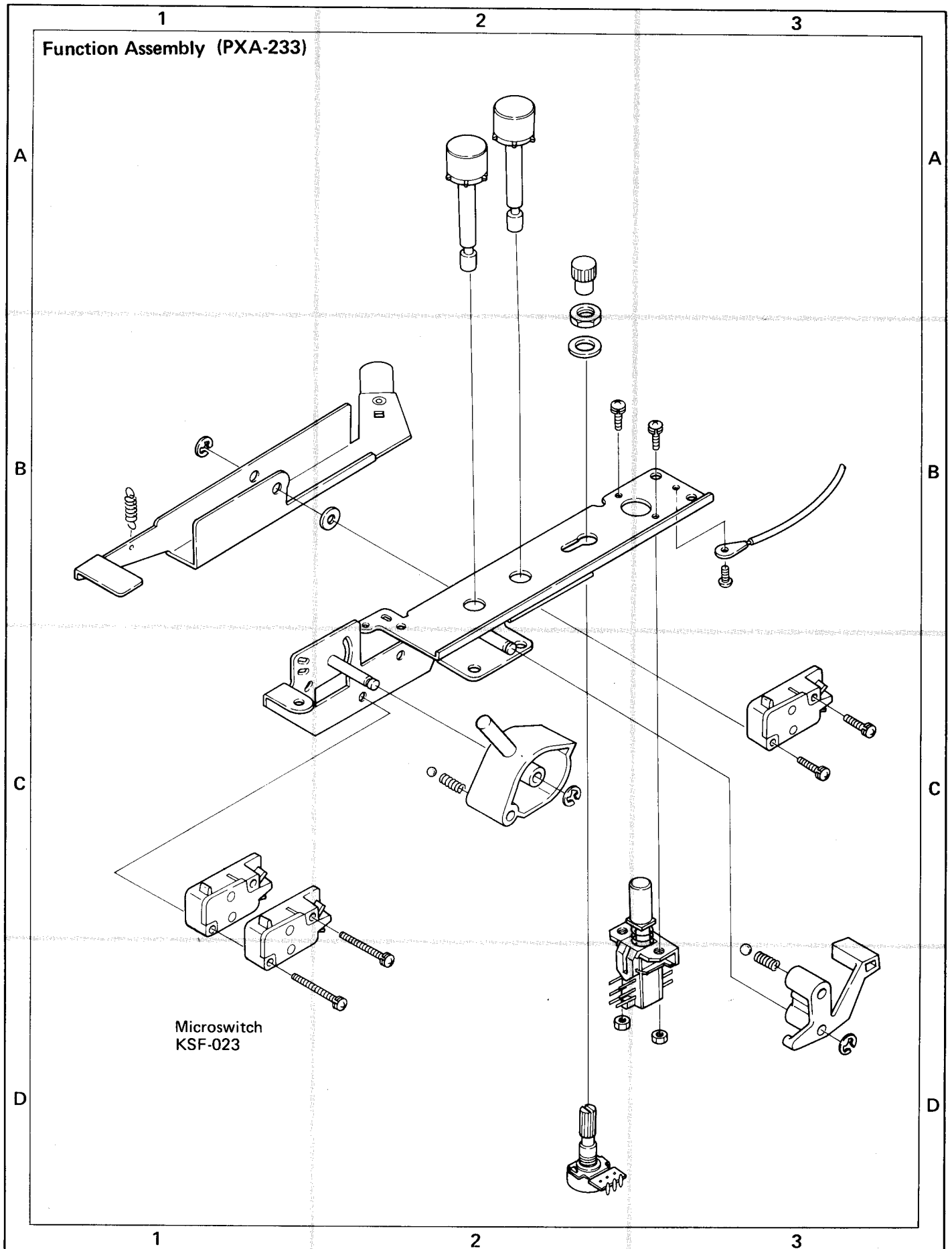

13.2 POWER SUPPLY ASSEMBLY (PWR-823)

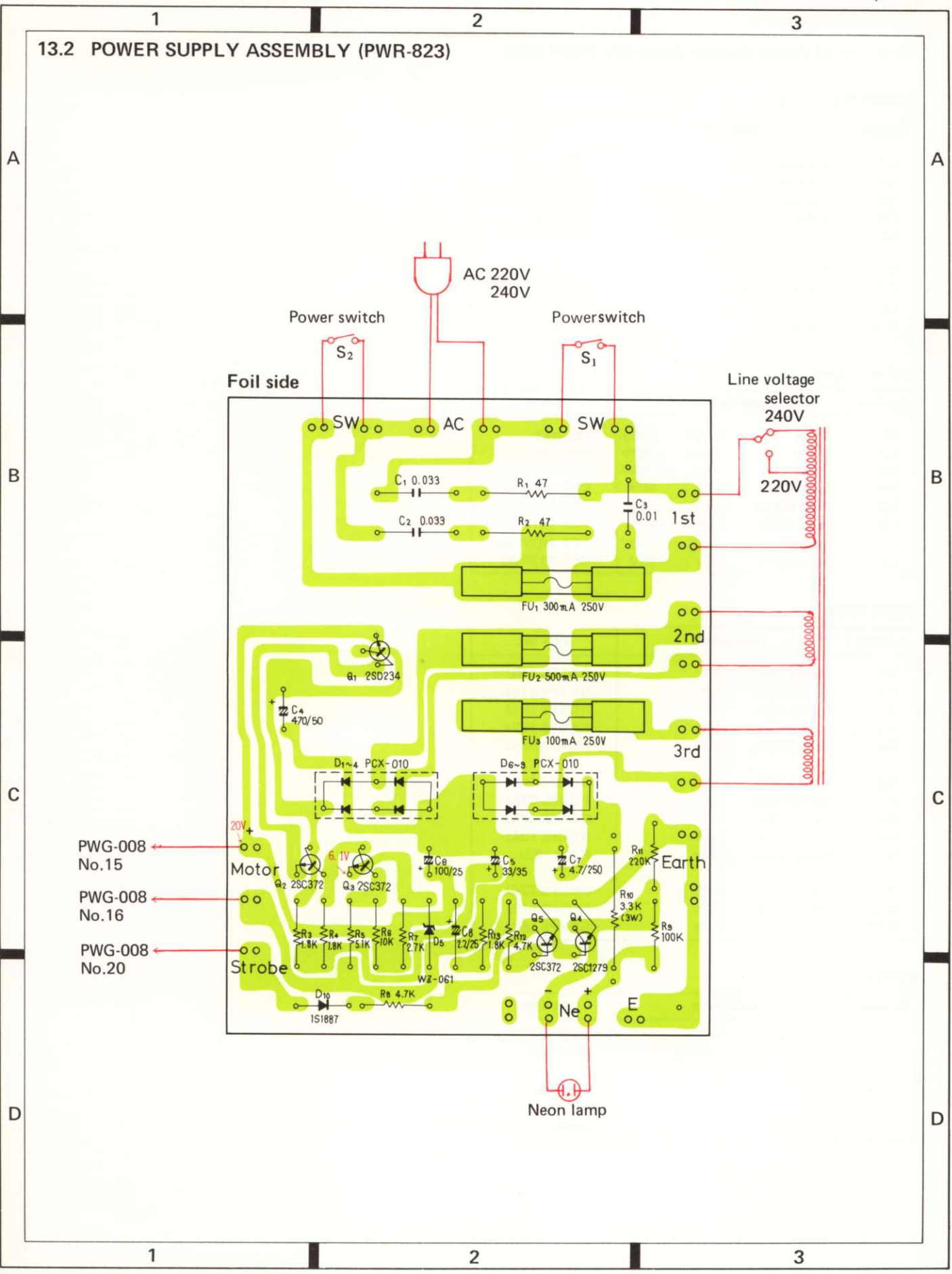

- PWG-008 No.15
- PWG-008 No.16
- PWG-008 No.20

Parts List of Power Supply Assembly (PWR-823)

SEMICONDUCTORS

Symbol	Description	Part No.
Q1	Transistor	2SD234
Q2	Transistor	2SC372-Y
Q3	Transistor	2SC372-Y
Q4	Transistor	2SC1279-S
Q5	Transistor	2SC372-Y
D1	Bridge rectifiers	PCX-010
D2	Bridge rectifiers	PCX-011
D5	Zener diode	WZ-061
D10	Diode	1S-1887

CAPACITORS

Symbol	Description	Part No.
C1	Mylar 0.033 250V	PCL-013
C2	Mylar 0.033 250V	PCL-013
C3	Ceramic 0.01 250V	ACG-001
C4	Electrolytic 470 50V	CEA 471P 50
C5	Electrolytic 33 35V	CEA 330P 35
C6	Electrolytic 100 25V	CEA 101P 25
C7	Electrolytic 4.7 250V	CEA 4R7P 250
C8	Electrolytic 2.2 25V	CEB 2R2P 25

RESISTORS

Symbol	Description	Part No.
R1	Carbon film 4.7	RD¼PS 470J
R2	Carbon film 4.7	RD¼PS 470J
R3	Carbon film 1.8k	RD¼PS 182J
R4	Carbon film 1.8k	RD¼PS 182J
R5	Carbon film 5.1k	RD¼PS 512J
R6	Carbon film 10k	RD¼PS 103J
R7	Carbon film 2.7k	RD¼PS 272J
R8	Carbon film 4.7k	RD¼PS 472J
R9	Carbon film 100k	RD¼PS 104J
R10	Metal oxide 3.3k 3W	RS3P 332J
R11	Carbon film 220k	RD¼PS 224J
R12	Carbon film 4.7k	RD¼PS 472J
R13	Carbon film 1.8k	RD¼PS 182J

OTHERS

Symbol	Description	Part No.
FU1	Fuse clip	KKR-001
FU1	Fuse 315mA	KEK-008
FU2	Fuse 500mA	PEK-007
FU3	Fuse 100mA	PEK-008
	Heat sink	PNS-001

PIONEER ELECTRONIC CORPORATION

4-1, Meguro 1-Chome, Meguro-ku, Tokyo 153, Japan

U.S. PIONEER ELECTRONICS CORPORATION

75 Oxford Drive, Moonachie, New Jersey 07074, U.S.A.

PIONEER ELECTRONIC (EUROPE) N.V.

Luithagen-Haven 9, 2030 Antwerp, Belgium

PIONEER ELECTRONICS AUSTRALIA PTY. LTD.

178-184 Boundary Road, Braeside, Victoria 3195, Australia