



QUADRAPHONIC POWER AMPLIFIER

QM-8000A

FVW

Power amp ass'y AWH-015

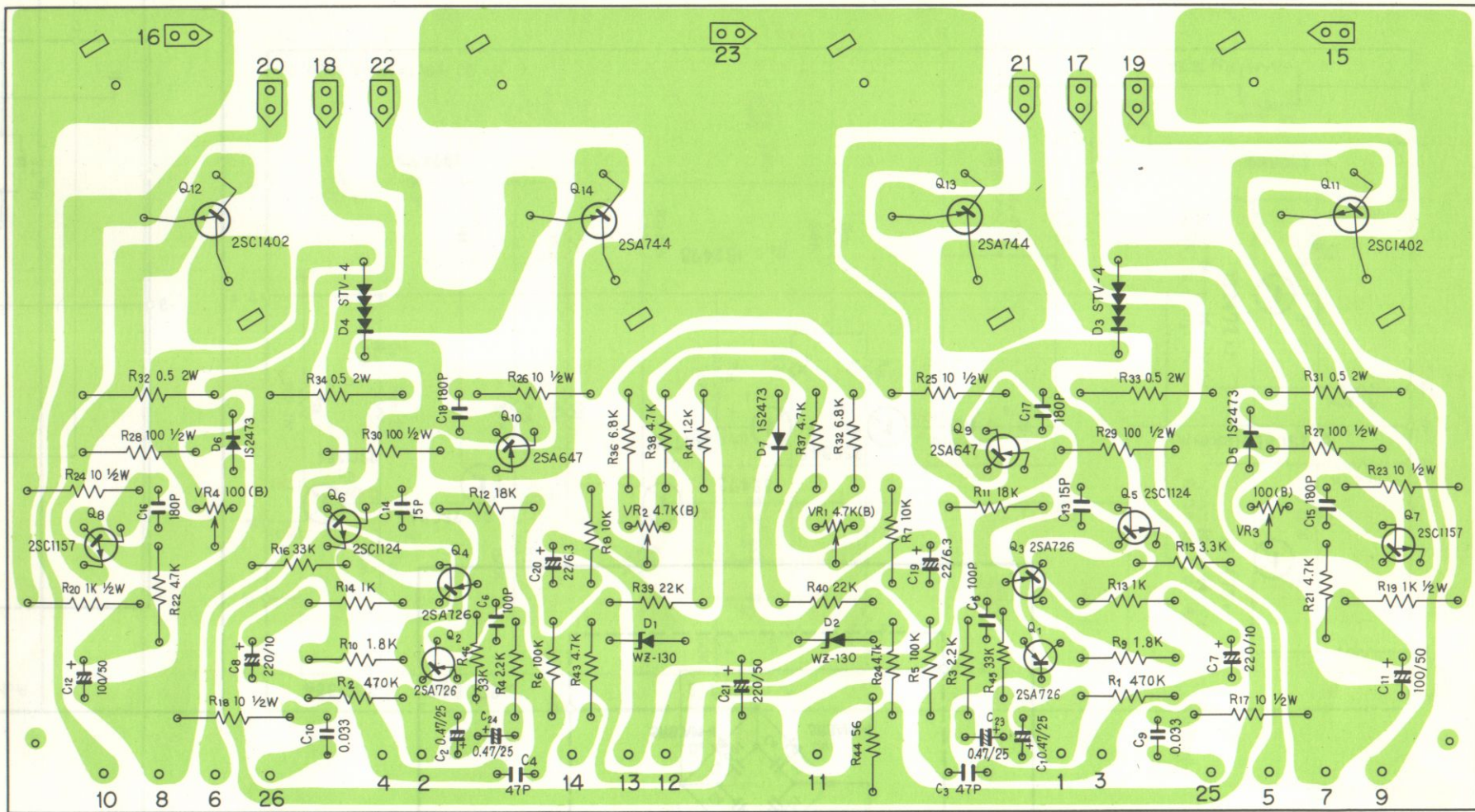

Power supply ass'y AWR-001

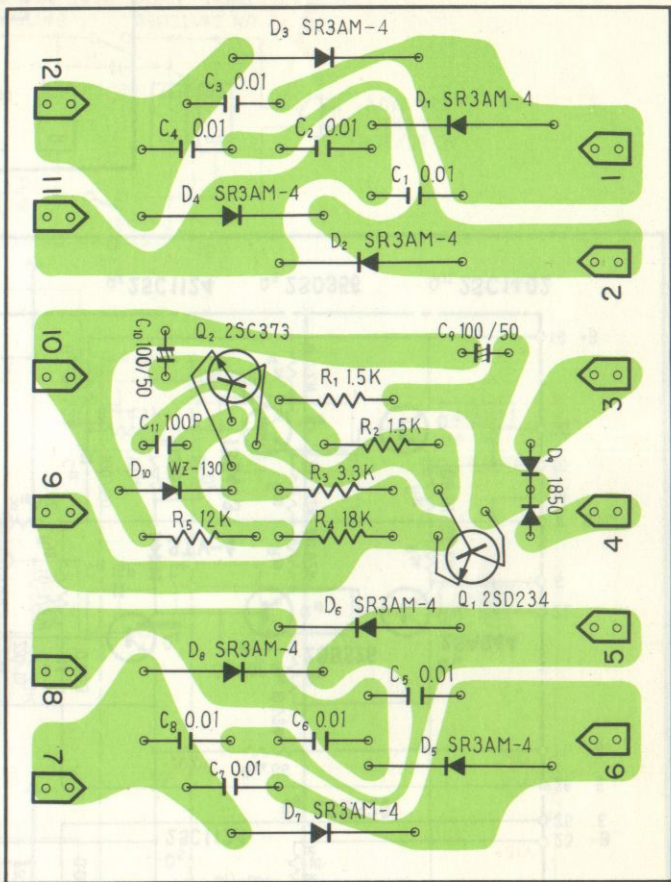

Protection ass'y AWM-028

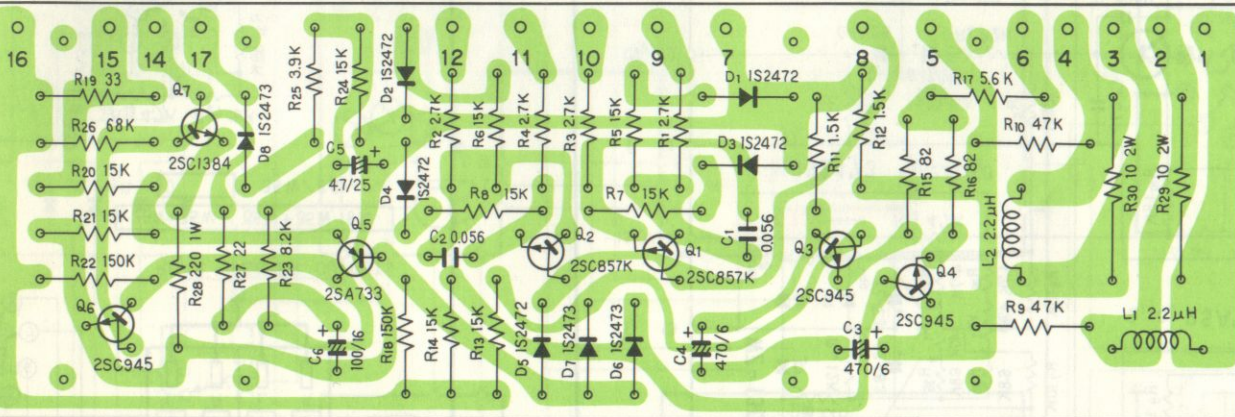

Protection ass'y AWM-029

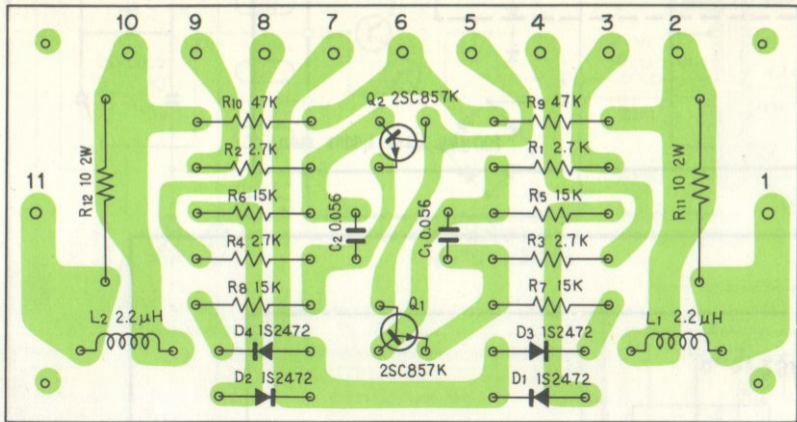

QM-800A

FRONT L (CH-1)
500mV

FRONT R (CH-3)
500mV

REAR L (CH-2)
500mV

REAR R (CH-4)
500mV

INPUTS

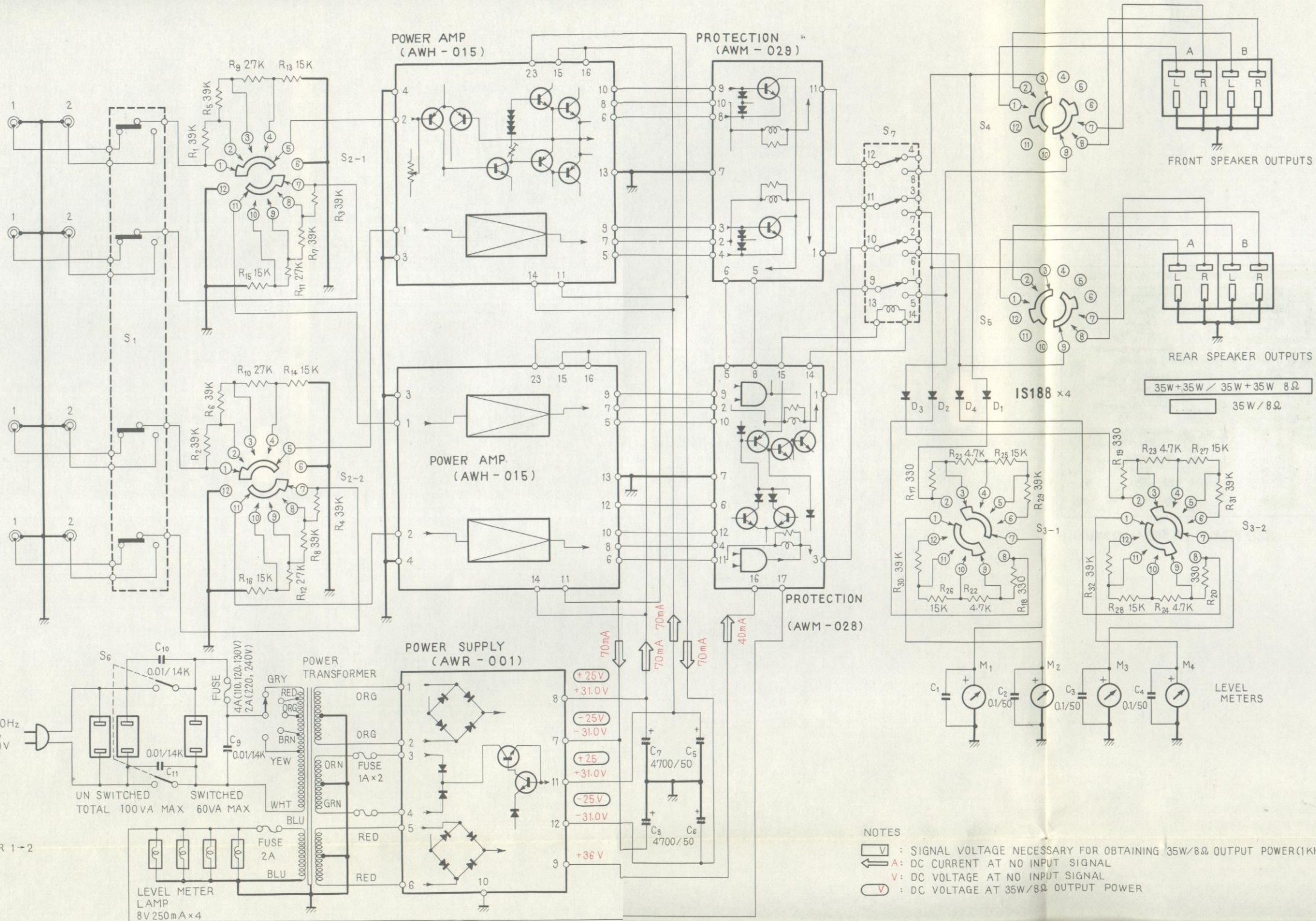

SWITCHES
S₁: INPUT SELECTOR 1+2

S₂: INPUT LEVEL
(1) 0.5V
(2) 1V
(3) 2V

LEVEL METER
LAMP
8V 250mA x 4

NOTES

- : SIGNAL VOLTAGE NECESSARY FOR OBTAINING 35W/8Ω OUTPUT POWER (1KHz)
- : DC CURRENT AT NO INPUT SIGNAL
- : DC VOLTAGE AT NO INPUT SIGNAL
- : DC VOLTAGE AT 35W/8Ω OUTPUT POWER

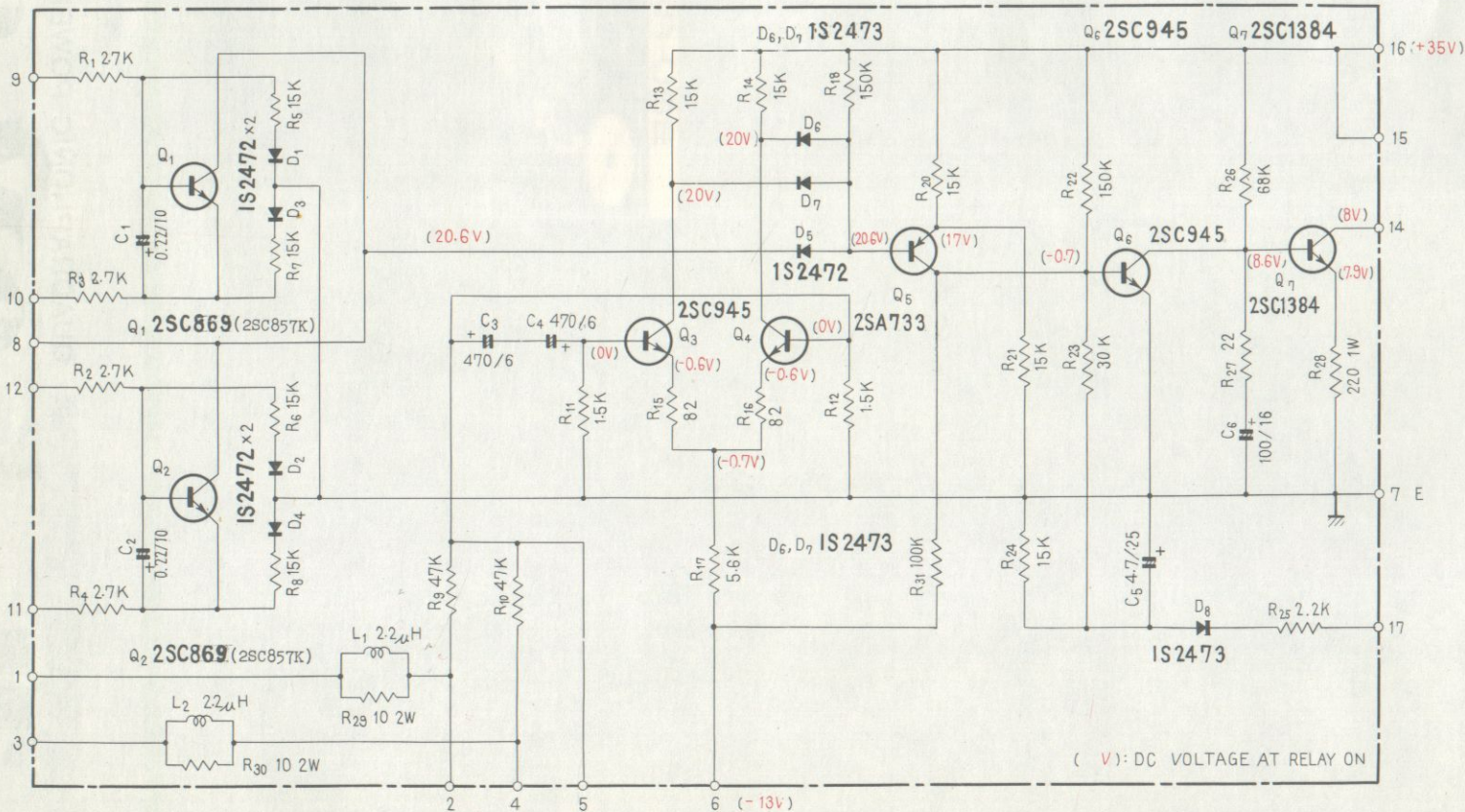

Power amp ass'y AWH-015

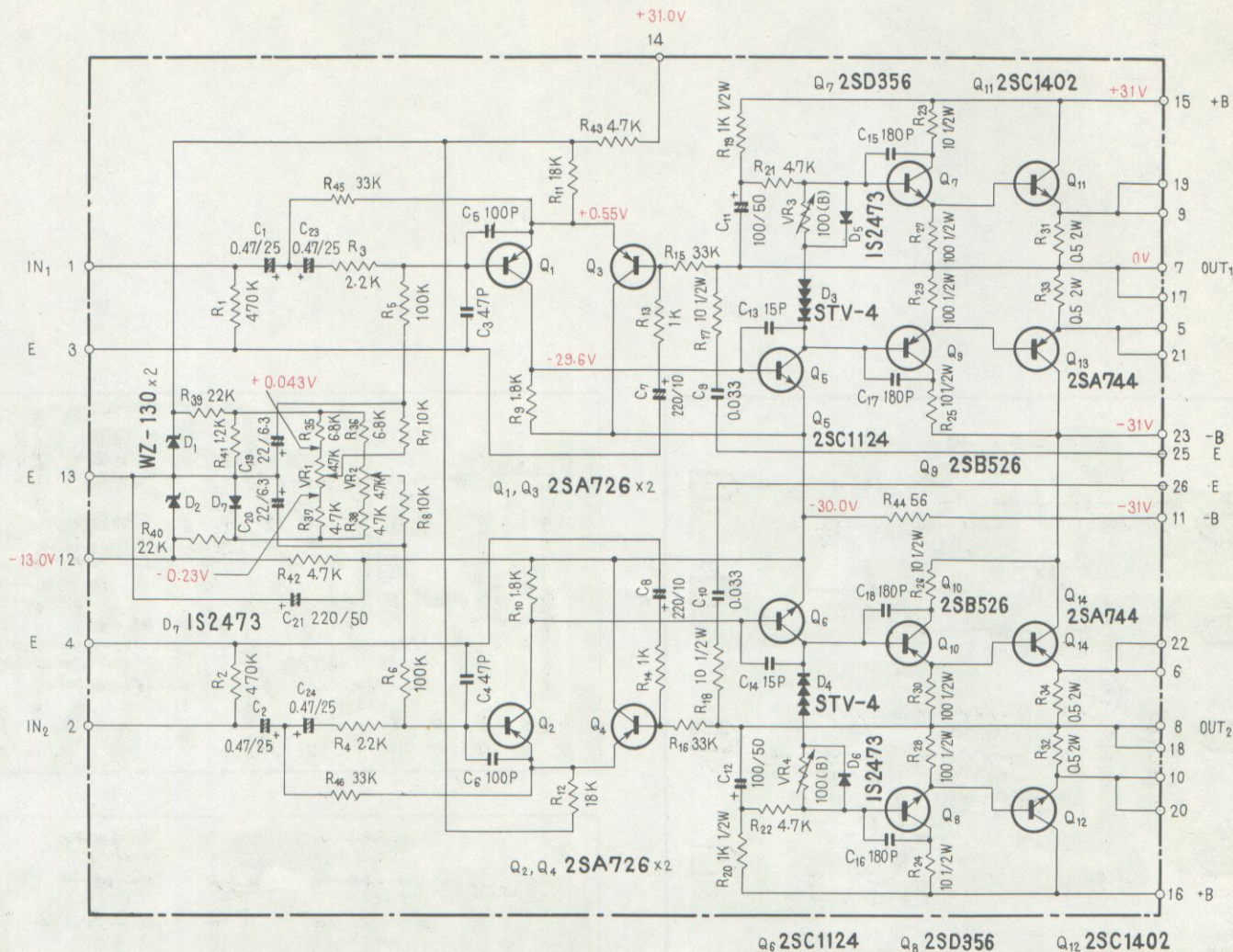

Power supply ass'y AWR-001

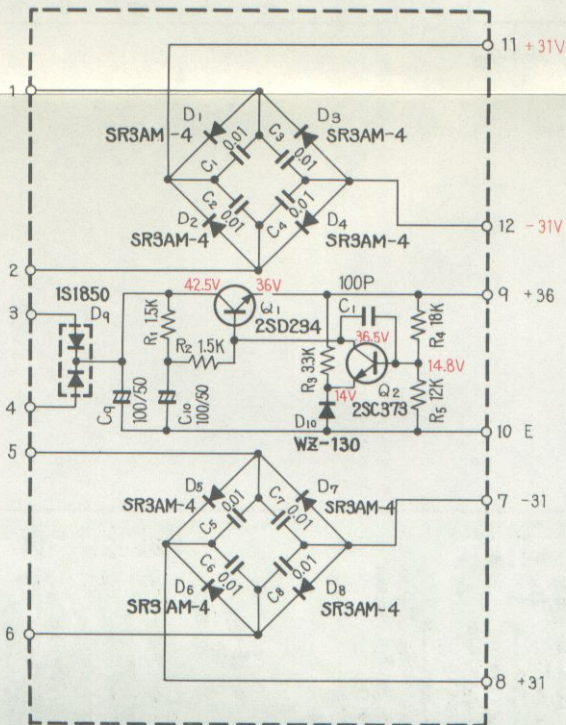

Protection ass'y AWM-029

