

STEREO AMPLIFIER

# SA-9500II

KC, S, HG

<ART-208-0>

Additional

## *Service Manual*

MODEL SA-9500II COMES IN FOUR VERSIONS DISTINGUISHED AS FOLLOWS:

Type	Voltage	Remarks
KU	120V only	UL (U.S.A.) approved
KC	120V only	CSA (Canada) approved
HG	220V and 240V (Switchable)	SEMKO (Sweden), NEMKO (Norway), DEMKO (Denmark) and EI (Finland) approved
S	110V, 120V, 220V and 240V (Switchable)	General export model

This additional service manual is applicable to the S, HG and KC types please refer to the KU type manual <ART-198-0> with exception of descriptions in this manual.

 PIONEER®

# CONTRAST OF MISCELLANEOUS PARTS

**NOTE:**

- Capacitors: in  $\mu F$  unless otherwise noted p:pF
- Resistors: in  $\Omega$ ,  $\frac{1}{4}W$  unless otherwise noted k:k $\Omega$ , M:M $\Omega$

## SWITCHES

Symbol	Description	Part No.			
		KU-type	KC-type	HG-type	S-type
S13	Lever switch (POWER)	ASK-124	ASK-124	ASK-127	ASK-128
S15	Plug in selector	.....	.....	AKX-037*	AKR-031**

\* 2-position line voltage selector (220V/240V)

\*\* 4-position line voltage selector (110V/120V/220V/240V) with fuse holder

## TRANSFORMERS

Symbol	Description	Part No.			
		KU-type	KC-type	HG-type	S-type
T1	Power transformer (L)	ATT-374	ATT-376	ATT-378	ATT-380
T2	Power transformer (R)	ATT-375	ATT-377	ATT-379	ATT-381

## FUSES

Symbol	Description	Part No.			
		KU-type	KC-type	HG-type	S-type
FU1	Fuse 4A (for 120V)	AEK-100	AEK-100	.....	.....
	Fuse 2A (for 220V or 240V)	.....	.....	AEK-017	.....
	Fuse 4A (for 220V or 240V)	.....	.....	.....	AEK-100
FU2	Fuse 8A (for 110V or 120V)	.....	.....	.....	AEK-110
	Fuse 4A (for 120V)	AEK-100	AEK-100	.....	.....
	Fuse 2A (for 220V or 240V)	.....	.....	AEK-017	.....
FU2	Fuse 0.8A (Secondary)	.....	.....	.....	AEK-111
FU3	Fuse 0.8A (Secondary)	AEK-111	AEK-111	AEK-031	AEK-111
FU4	Fuse 0.8A (Secondary)	AEK-111	AEK-111	AEK-031	.....

## OTHERS

Symbol	Description	Part No.			
		KU-type	KC-type	HG-type	S-type
	AC socket (AC OUTLETS)	AKP-004	AKP-004	.....	AKP-004
	Recessed plug (AC INLET)	.....	.....	AKP-008	.....
	AC power cord	ADG-005	ADG-005	.....	ADG-017
	Packing case	AHD-433	AHD-434	AHD-435	AHD-433
	Switch assembly	AWS-109	AWS-111	AWS-114	AWS-115
	5P connector assembly	.....	.....	AWX-062	AWX-062
	Power Amplifier assembly	AWH-052	AWH-052	AWH-062	AWH-052

## CAPACITORS

Symbol	Description	Part No.			
		KU-type	KC-type	HG-type	S-type
C10	Ceramic 0.01 125V	.....	ACG-014	.....	.....
	Ceramic 0.01 250V	ACG-001	.....	.....	ACG-001
C11	Ceramic 0.01 250V	.....	.....	.....	ACG-001
		.....	.....	.....	ACG-001

FURNISHED PARTS

Symbol	Description	Part No.			
		KU-type	KC-type	HG-type	S-type
	Operating instructions (English)	ARB-208	ARB-208	ARB-220	ARB-220
	Operating instructions (German/French)	.....	.....	ARD-108	.....
	Fuse 4A (for 220V or 240V)	.....	.....	.....	AEK-100
	Fuse 8A (for 110V or 120V)	.....	.....	.....	AEK-110
	Vinyl pouch (for fuse)	.....	.....	.....	E11-033

5P CONNECTOR ASSEMBLY(AWX-062)

NOTE:

This assembly is applicable to the S and HG types.

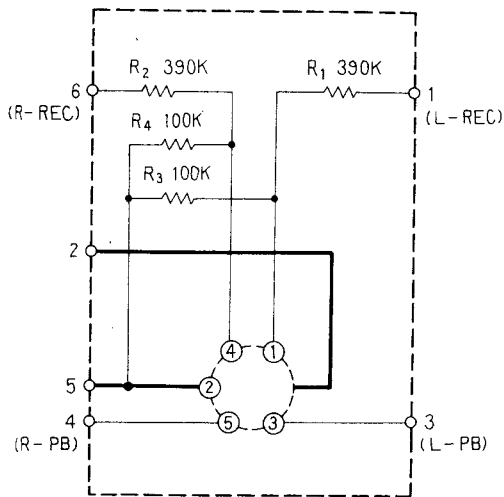

Parts List

Symbol	Description	Part No.
R1	Carbon film resistor 390k	RD¼PS 394J
R2	Carbon film resistor 390k	RD¼PS 394J
R3	Carbon film resistor 100k	RD¼PS 104J
R4	Carbon film resistor 100k	RD¼PS 104J
	Connector socket (REC/PLAY)	AKP-007

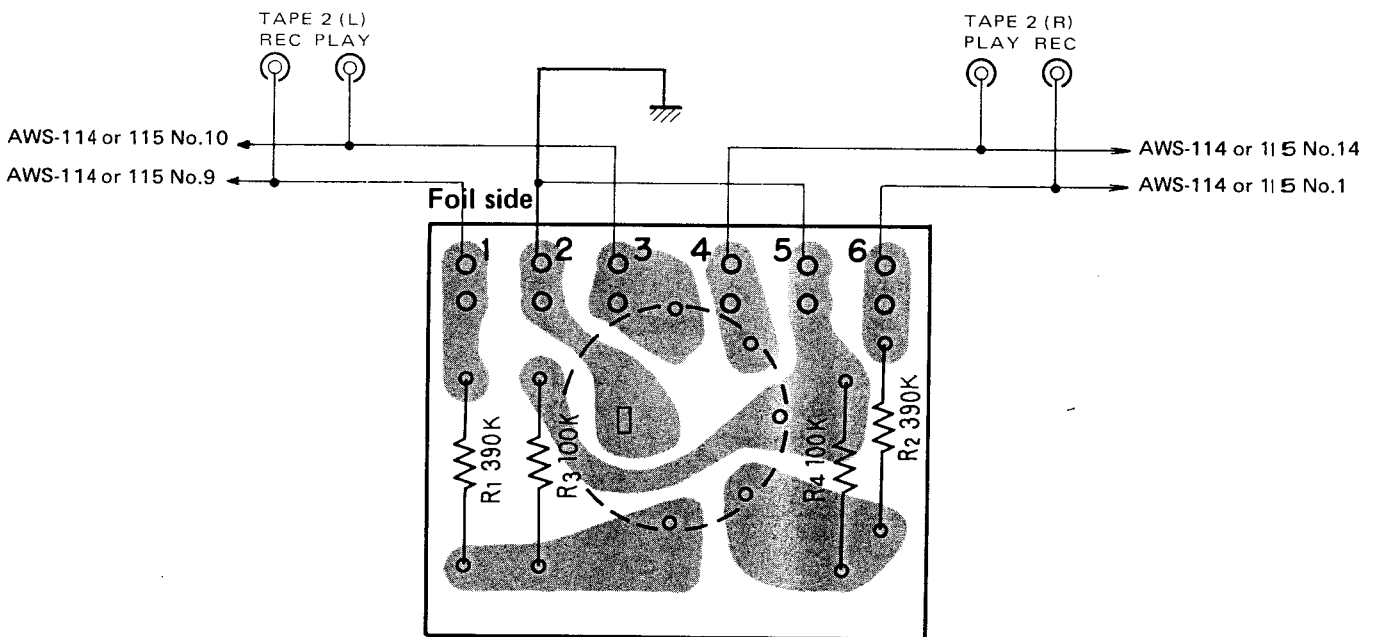

# SA-9500II/KC

## Miscellaneous Parts for KC-type

### NOTE:

- Capacitors: in  $\mu F$  unless otherwise noted p:pF
- Resistors: in  $\Omega$ ,  $\frac{1}{4}W$  unless otherwise noted k:k $\Omega$ , M:M $\Omega$

### SEMICONDUCTORS

Symbol	Description	Part No.
Q1	Transistor	2SD588A/A/-R or Q
Q2	Transistor	2SD588A/A/-R or Q
Q3	Transistor	2SB618A/A/-R or Q
Q4	Transistor	2SB618A/A/-R or Q
Q5	Transistor	2SD588A/A/-R or Q
Q6	Transistor	2SD588A/A/-R or Q
Q7	Transistor	2SB618A/A/-R or Q
Q8	Transistor	2SB618A/A/-R or Q

### CAPACITORS

Symbol	Description	Part No.
C1	Ceramic 0.047 50V	CKDYF 473Z 50
C2	Ceramic 0.047 50V	CKDYF 473Z 50
C3	Ceramic 0.047 50V	CKDYF 473Z 50
C4	Ceramic 0.047 50V	CKDYF 473Z 50
C5	Ceramic 0.047 50V	CKDYF 473Z 50
C6	Electrolytic 12,000 63V	ACH-065
C7	Electrolytic 12,000 63V	ACH-065
C8	Electrolytic 12,000 63V	ACH-065
C9	Electrolytic 12,000 63V	ACH-065
C10	Ceramic 0.01 125V	ACG-014

- The rear panel components of KC-type are the same as KU-type.

### LAMP, FUSES

Symbol	Description	Part No.
PL1	Lamp with leads 8V, 50mA	AEL-069
FU1	Fuse 4A	AEK-100
FU2	Fuse 4A	AEK-100
FU3	Fuse 0.8A	AEK-111
FU4	Fuse 0.8A	AEK-111

### SWITCH

Symbol	Description	Part No.
S13	Lever switch (POWER)	ASK-124

### TRANSFORMERS

Symbol	Description	Part No.
T1	Power transformer (L)	ATT-376
T2	Power transformer (R)	ATT-377

### RESISTOR

Symbol	Description	Part No.
VR1	Variable resistor 100k 32-step (VOLUME)	ACV-171

Schematic Diagram for KC type

**NOTE:**  
The indicated semiconductors are representative ones only. Other alternative semiconductors may be used and are listed in the parts list.

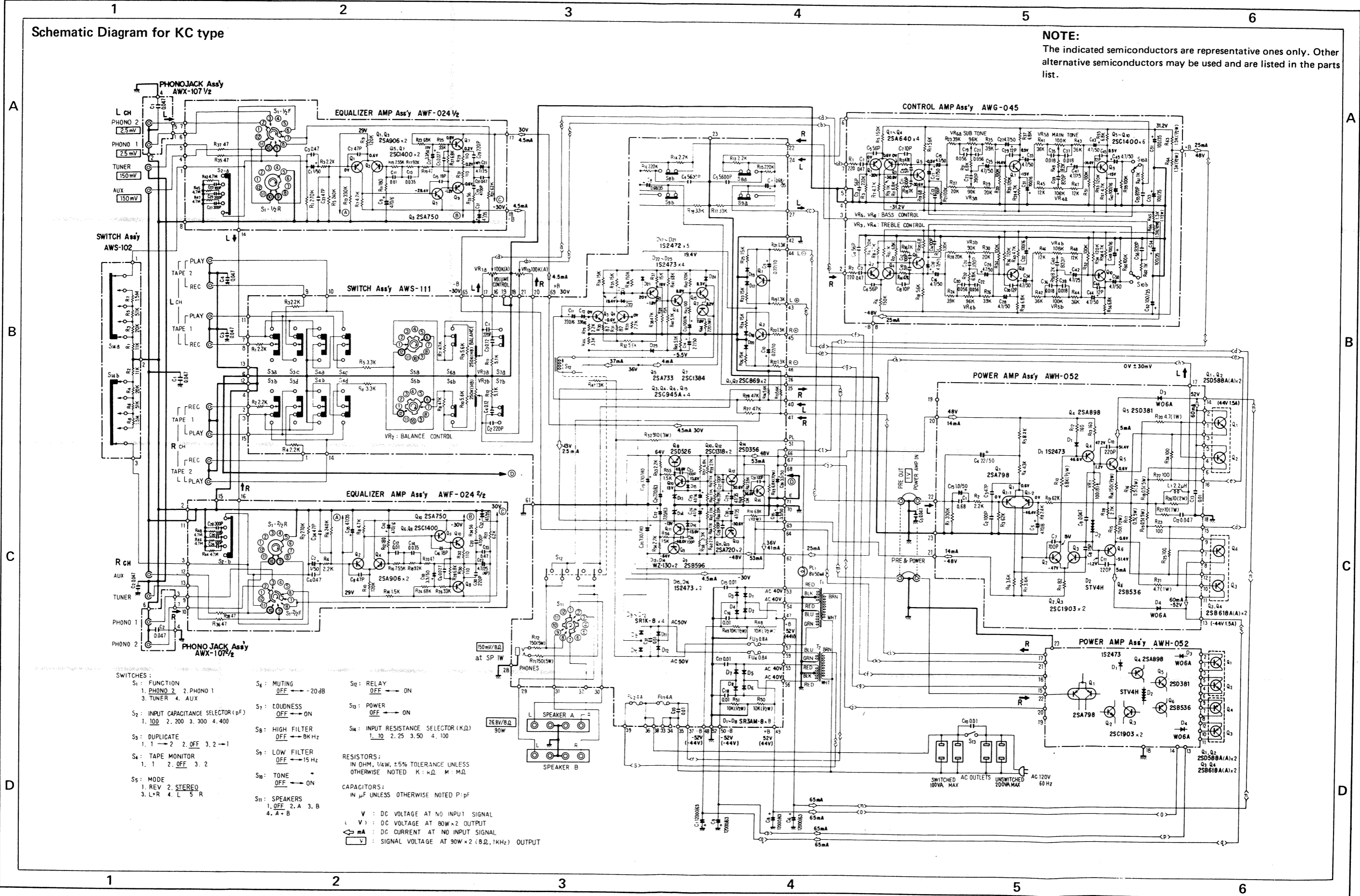

- SWITCHES:**
- S<sub>1</sub>: FUNCTION  
1. PHONO 2 2. PHONO 1  
3. TUNER 4. AUX
  - S<sub>2</sub>: INPUT CAPACITANCE SELECTOR (pF)  
1. 100 2. 200 3. 300 4. 400
  - S<sub>3</sub>: DUPLICATE  
1. 1 — 2. OFF 3. 2 — 1
  - S<sub>4</sub>: TAPE MONITOR  
1. 1 2. OFF 3. 2
  - S<sub>5</sub>: MODE  
1. REV 2. STEREO  
3. L-R 4. L 5. R
  - S<sub>6</sub>: MUTING  
OFF → -20dB
  - S<sub>7</sub>: LOUDNESS  
OFF → ON
  - S<sub>8</sub>: HIGH FILTER  
OFF → 9KHz
  - S<sub>9</sub>: LOW FILTER  
OFF → 15Hz
  - S<sub>10</sub>: TONE  
OFF → ON
  - S<sub>11</sub>: SPEAKERS  
1. OFF 2. A 3. B  
4. A + B
  - S<sub>12</sub>: RELAY  
OFF → ON
  - S<sub>13</sub>: POWER  
OFF → ON
  - S<sub>14</sub>: INPUT RESISTANCE SELECTOR (K.Ω)  
1. 10 2. 25 3. 50 4. 100
- RESISTORS:**  
IN OHM, 1/4W, ±5% TOLERANCE UNLESS OTHERWISE NOTED K: KΩ M: MΩ
- CAPACITORS:**  
IN μF UNLESS OTHERWISE NOTED P: pF
- SYMBOLS:**  
V: DC VOLTAGE AT NO INPUT SIGNAL  
V: DC VOLTAGE AT 80W × 2 OUTPUT  
mA: DC CURRENT AT NO INPUT SIGNAL  
V: SIGNAL VOLTAGE AT 90W × 2 (8.0, 1KHz) OUTPUT

SA-9500II/KC

Switch Assembly (AWS-111)

NOTE:  
This assembly is applicable to the KC type.

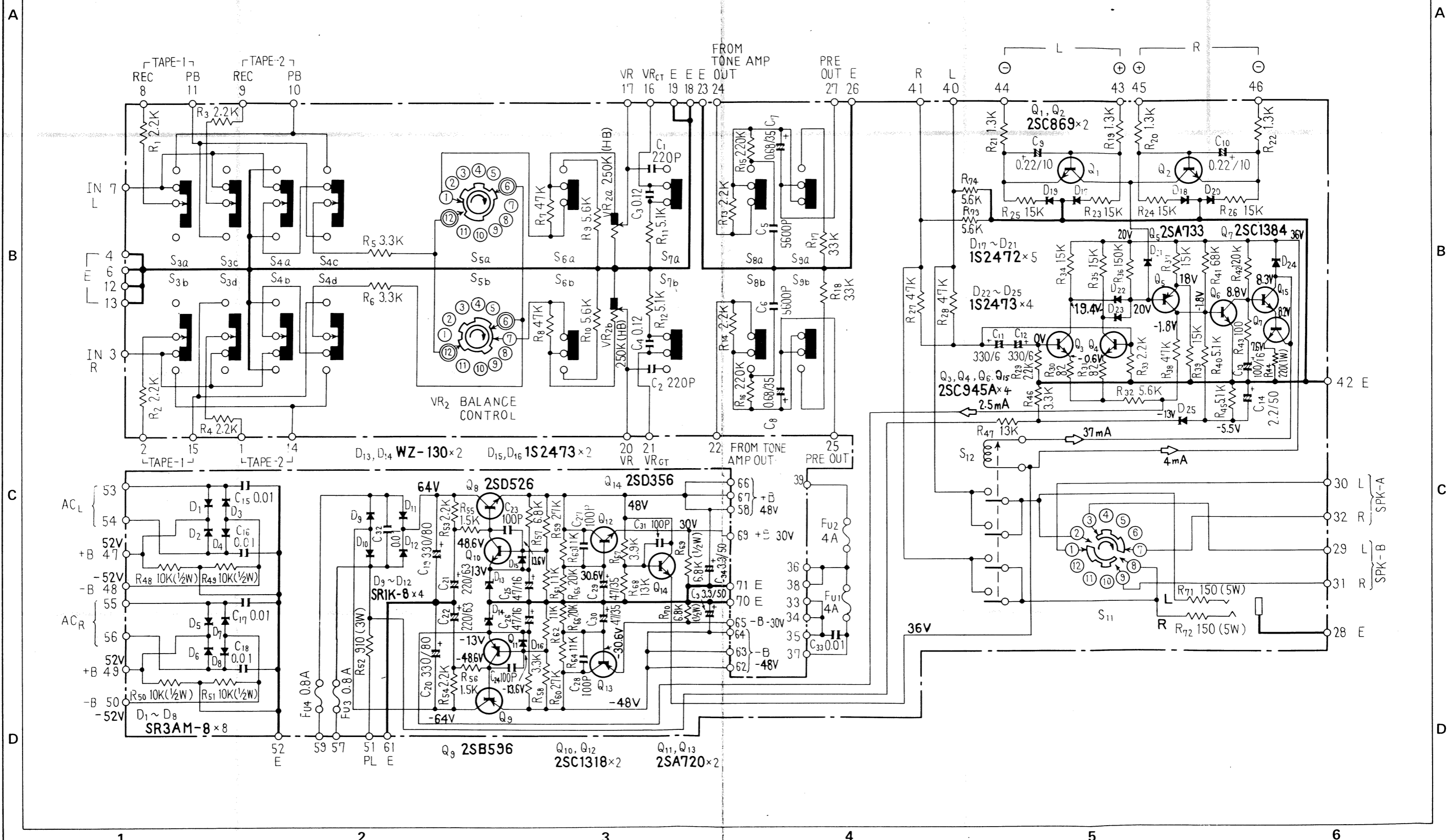

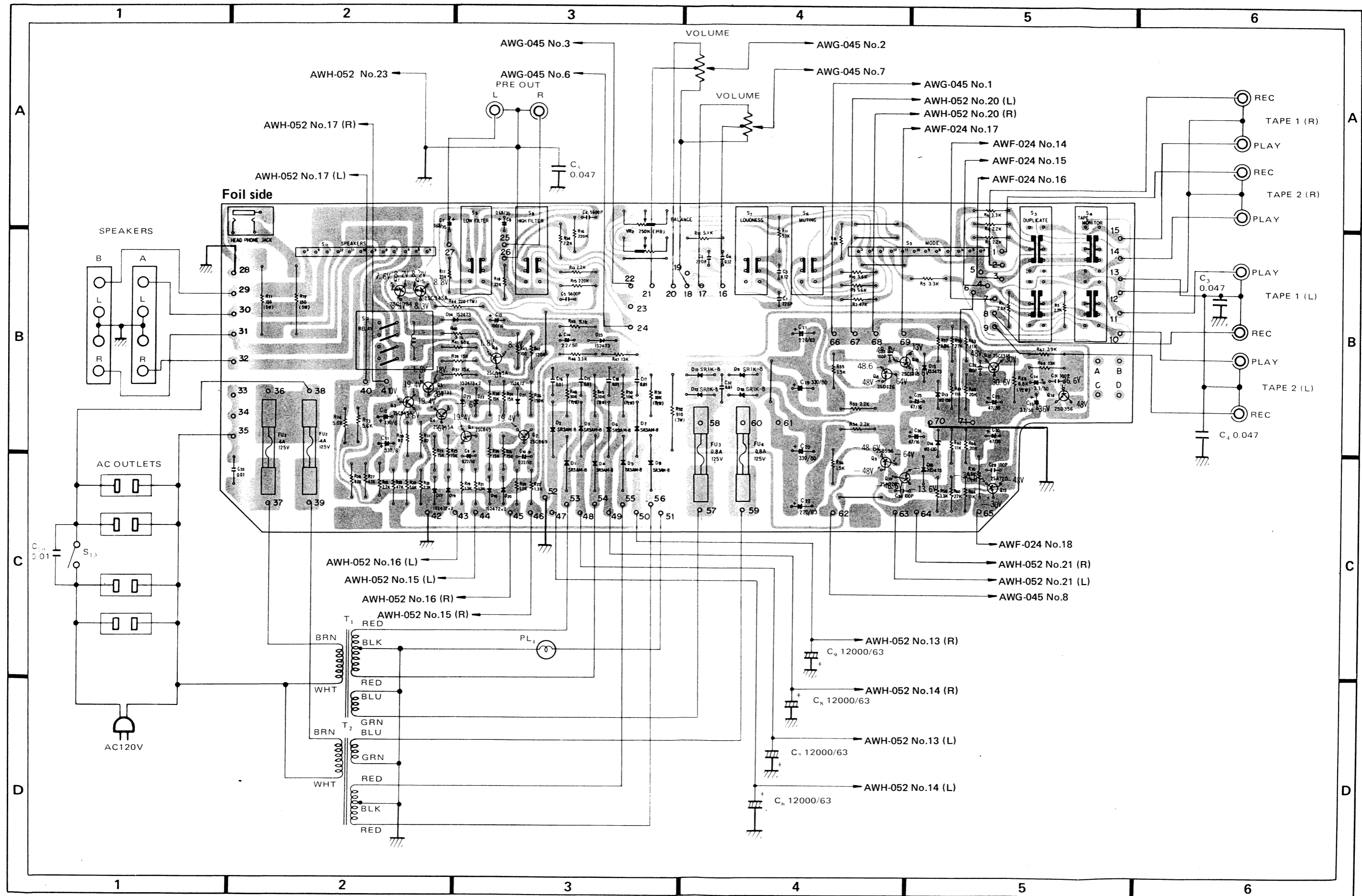

## Parts List of Switch Assembly (AWS-111, for KC-type)

## SEMICONDUCTORS

Symbol	Description	Part No.
Q1	Transistor	2SC869-C or D (2SC1649-Q or R)
Q2	Transistor	2SC869-C or D (2SC1649-Q or R)
Q3	Transistor	2SC945A-Q or R
Q4	Transistor	2SC945A-Q or R
Q5	Transistor	2SA733-Q or R (2SA823-Q or R)
Q6	Transistor	2SC945A-Q or R
Q7	Transistor	2SC1384-Q or R
Q8	Transistor	2SD526-O or R (2SD313P-D or E)
Q9	Transistor	2SB596-O or R (2SB507P-D or E)
Q10	Transistor	2SC1318-Q or R
Q11	Transistor	2SA720-Q or R
Q12	Transistor	2SC1318-Q or R
Q13	Transistor	2SA720-Q or R
Q14	Transistor	2SD356-C or D
Q15	Transistor	2SC945A-Q or R
D1	Diode	SR3AM-8 (ERD03-04)
D2	Diode	SR3AM-8 (ERD03-04)
D3	Diode	SR3AM-8 (ERD03-04)
D4	Diode	SR3AM-8 (ERD03-04)
D5	Diode	SR3AM-8 (ERD03-04)
D6	Diode	SR3AM-8 (ERD03-04)
D7	Diode	SR3AM-8 (ERD03-04)
D8	Diode	SR3AM-8 (ERD03-04)
D9	Diode	SR1K-8 (SIB01-04)
D10	Diode	SR1K-8 (SIB01-04)
D11	Diode	SR1K-8 (SIB01-04)
D12	Diode	SR1K-8 (SIB01-04)

Symbol	Description	Part No.
D13	Zener diode	WZ-130
D14	Zener diode	WZ-130
D15	Diode	1S2473 (1S1555)
D16	Diode	1S2473 (1S1555)
D17	Diode	1S2472 (1S1554)
D18	Diode	1S2472 (1S1554)
D19	Diode	1S2472 (1S1554)
D20	Diode	1S2472 (1S1554)
D21	Diode	1S2472 (1S1554)
D23	Diode	1S2473 (1S1555)
D24	Diode	1S2473 (1S1555)
D25	Diode	1S2473 (1S1555)

## SWITCHES

Symbol	Description	Part No.
S3	Lever switch (DUPLICATE)	ASK-113
S4	Lever switch (MONITOR)	ASK-113
S5	Rotary switch (MODE)	ASD-053
S6	Lever switch (MUTING)	ASK-110
S7	Lever switch (LOUDNESS)	ASK-110
S8	Lever switch (HIGH FILTER)	ASK-110
S9	Lever switch (LOW FILTER)	ASK-110
S11	Rotary switch (SPEAKERS)	ASD-054
S12	Relay	ASR-018

## RESISTORS

Symbol	Description	Part No.
R1	Carbon film 2.2k	RD¼PS 222J
R2	Carbon film 2.2k	RD¼PS 222J
R3	Carbon film 2.2k	RD¼PS 222J
R4	Carbon film 2.2k	RD¼PS 222J
R5	Carbon film 3.3k	RD¼PS 332J
R6	Carbon film 3.3k	RD¼PS 332J
R7	Carbon film 47k	RD¼PS 473J
R8	Carbon film 47k	RD¼PS 473J
R9	Carbon film 5.6k	RD¼PS 562J
R10	Carbon film 5.6k	RD¼PS 562J



Symbol	Description	Part No.
R11	Carbon film 5.1k	RD½PS 512J
R12	Carbon film 5.1k	RD½PS 512J
R13	Carbon film 2.2k	RD½PS 222J
R14	Carbon film 2.2k	RD½PS 222J
R15	Carbon film 220k	RD½PS 224J
R16	Carbon film 220k	RD½PS 224J
R17	Carbon film 33k	RD½PS 333J
R18	Carbon film 33k	RD½PS 333J
R19	Carbon film 1.3k	RD½PS 132J
R20	Carbon film 1.3k	RD½PS 132J
R21	Carbon film 1.3k	RD½PS 132J
R22	Carbon film 1.3k	RD½PS 132J
R23	Carbon film 15k	RD½PS 153J
R24	Carbon film 15k	RD½PS 153J
R25	Carbon film 15k	RD½PS 153J
R26	Carbon film 15k	RD½PS 153J
R27	Carbon film 47k	RD½PS 473J
R28	Carbon film 47k	RD½PS 473J
R29	Carbon film 2.2k	RD½PS 222J
R30	Carbon film 82	RD½PS 820J
R31	Carbon film 82	RD½PS 820J
R32	Carbon film 5.6k	RD½PS 562J
R33	Carbon film 2.2k	RD½PS 222J
R34	Carbon film 15k	RD½PS 153J
R35	Carbon film 15k	RD½PS 153J
R36	Carbon film 150k	RD½PS 154J
R37	Carbon film 15k	RD½PS 153J
R38	Carbon film 47k	RD½PS 473J
R39	Carbon film 15k	RD½PS 153J
R40	Carbon film 5.1k	RD½PS 512J
R41	Carbon film 68k	RD½PS 683J
R42	Carbon film 120k	RD½PS 124J
R43	Carbon film 100	RD½PS 101J
R44	Metal oxide 220	RS1P 221J
R45	Carbon film 5.1k	RD½PS 512J
R46	Carbon film 3.3k	RD½PS 332J
R47	Carbon film 13k	RD½PS 133J
R48	Carbon film 10k ½W	RD½PS 103J
R49	Carbon film 10k ½W	RD½PS 103J
R50	Carbon film 10k ½W	RD½PS 103J
R51	Carbon film 10k ½W	RD½PS 103J
R52	Metal oxide 910 3W	RS3P 911J
R53	Carbon film 2.2k	RD½PS 222J
R54	Carbon film 2.2k	RD½PS 222J
R55	Carbon film 1.5k	RD½PS 152J
R56	Carbon film 1.5k	RD½PS 152J
R57	Carbon film 6.8k	RD½PS 682J
R58	Carbon film 3.3k	RD½PS 332J
R59	Carbon film 27k	RD½PS 273J
R60	Carbon film 27k	RD½PS 273J
R61	Carbon film 11k	RD½PS 113J
R62	Carbon film 11k	RD½PS 113J

Symbol	Description	Part No.
R63	Carbon film 11k	RD½PS 113J
R64	Carbon film 11k	RD½PS 113J
R65	Carbon film 20k	RD½PS 203J
R66	Carbon film 20k	RD½PS 203J
R67	Carbon film 3.9k	RD½PS 392J
R68	Carbon film 13k	RD½PS 133J
R69	Carbon film 6.8k ½W	RD½PS 682J
R70	Carbon film 6.8k ½W	RD½PS 682J
R71	Wire wound 150 5W	RT5B 151K
R72	Wire wound 150 5W	RT5B 151K
R73	Carbon film 5.6k	RD½PS 562J
R74	Carbon film 5.6k	RD½PS 562J
VR2	Variable resistor 250k-HB (BALANCE)	ACV-172

### CAPACITORS

Symbol	Description	Part No.
C1	Ceramic 220p 50V	CCDSL 221K 50
C2	Ceramic 220p 50V	CCDSL 221K 50
C3	Mylar 0.12 50V	CQMA 124K 50
C4	Mylar 0.12 50V	CQMA 124K 50
C5	Mylar 0.0056 50V	CQMA 562J 50
C6	Mylar 0.0056 50V	CQMA 562J 50
C7	Electrolytic 0.68 35V	CSZA R68M 35
C8	Electrolytic 0.68 35V	CSZA R68M 35
C9	Electrolytic 0.22 10V	CSSA R22M 10
C10	Electrolytic 0.22 10V	CSSA R22M 10
C11	Electrolytic 330 6V	CEA 331P 6
C12	Electrolytic 330 6V	CEA 331P 6
C13	Electrolytic 100 16V	CEA 101P 16
C14	Electrolytic 2.2 50V	ACH-317
C15	Ceramic 0.01 150V	ACG-004
C16	Ceramic 0.01 150V	ACG-004
C17	Ceramic 0.01 150V	ACG-004
C18	Ceramic 0.01 150V	ACG-004
C19	Electrolytic 330 80V	CEA 331P 80
C20	Electrolytic 330 80V	CEA 331P 80
C21	Electrolytic 220 63V	CEA 221P 63
C22	Electrolytic 220 63V	CEA 221P 63
C23	Ceramic 100p 50V	CCDSL 101K 50
C24	Ceramic 100p 50V	CCDSL 101K 50
C25	Electrolytic 47 16V	CEA 470P 16
C26	Electrolytic 47 16V	CEA 470P 16
C27	Ceramic 100p 50V	CCDSL 101K 50
C28	Ceramic 100p 50V	CCDSL 101K 50
C29	Electrolytic 47 35V	CEA 470P 35
C30	Electrolytic 47 35V	CEA 470P 35
C31	Ceramic 100p 50V	CCDSL 101K 50
C32	Ceramic 0.01 150V	ACG-004
C33	Ceramic 0.01 125V	ACG-014
C34	Electrolytic 3.3 50V	CEA 3R3P 50
C35	Electrolytic 3.3 50V	CEA 3R3P 50

## OTHERS

Symbol	Description	Part No.
	Phone jack (PHONES)	AKN-008
	Fuse clip	AKR-013
	Heat sink	ANH-117
	Washer faced nut M9	ABN-024
	Special nut	ABN-027

# SA-9500II/S

## Miscellaneous Parts for S-type

### NOTE:

- Capacitors: in  $\mu F$  unless otherwise noted p:pF
- Resistors: in  $\Omega$ ,  $\frac{1}{4}W$  unless otherwise noted k:k $\Omega$ , M:M $\Omega$

### SEMICONDUCTORS

Symbol	Description	Part No.
Q1	Transistor	2SD588A/A/-R or Q
Q2	Transistor	2SD588A/A/-R or Q
Q3	Transistor	2SB618A/A/-R or Q
Q4	Transistor	2SB618A/A/-R or Q
Q5	Transistor	2SD588A/A/-R or Q
Q6	Transistor	2SB618A/A/-R or Q
Q7	Transistor	2SB618A/A/-R or Q
Q8	Transistor	2SB618A/A/-R or Q

### CAPACITORS

Symbol	Description	Part No.
C1	Ceramic 0.047 50V	CKDYF 473Z 50
C2	Ceramic 0.047 50V	CKDYF 473Z 50
C3	Ceramic 0.047 50V	CKDYF 473Z 50
C4	Ceramic 0.047 50V	CKDYF 473Z 50
C5	Ceramic 0.047 50V	CKDYF 473Z 50
C6	Electrolytic 12,000 63V	ACH-065
C7	Electrolytic 12,000 63V	ACH-065
C8	Electrolytic 12,000 63V	ACH-065
C9	Electrolytic 12,000 63V	ACH-065
C10	Ceramic 0.01 250V	ACG-001
C11	Ceramic 0.01 250V	ACG-001

### LAMP, FUSES

Symbol	Description	Part No.
PL1	Lamp with leads 8V, 50mA	AEL-069
FU1	Fuse 4A (for 220V or 240V)	AEK-100
	Fuse 8A (for 110V or 120V)	AEK-110
FU2	Fuse 0.8A	AEK-111
FU3	Fuse 0.8A	AEK-111

### SWITCHES

Symbol	Description	Part No.
S13	Lever switch (POWER)	ASK-128
S15	Plug in selector (4-position)	AKR-031

### TRANSFORMERS

Symbol	Description	Part No.
T1	Power transformer (L)	ATT-380
T2	Power transformer (R)	ATT-381

### RESISTOR

Symbol	Description	Part No.
VR1	Variable resistor 100k 32-step (VOLUME)	ACV-171

Schematic Diagram for S type

NOTE: The indicated semiconductors are representative ones only. Other alternative semiconductors may be used and are listed in the parts list.

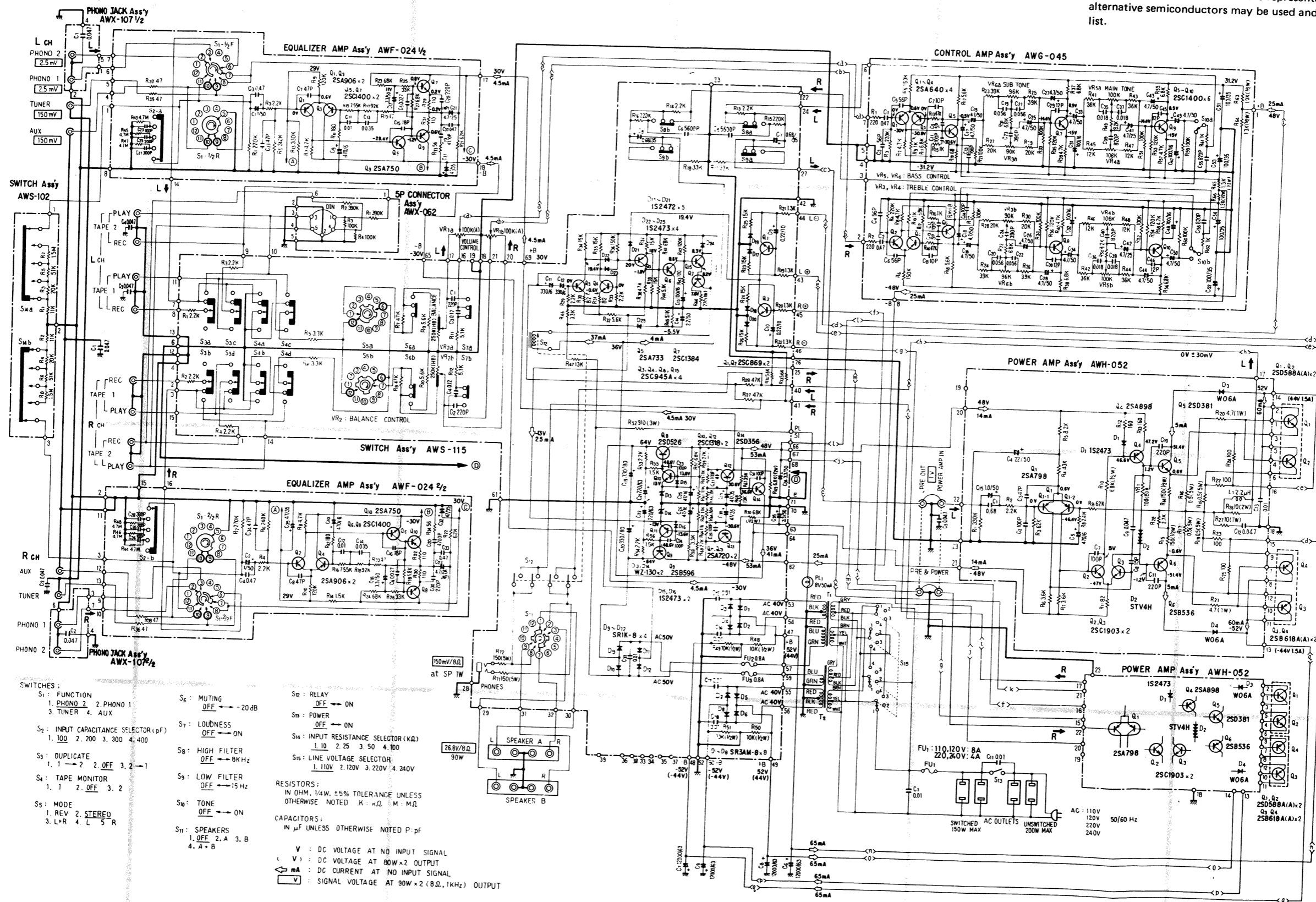

- SWITCHES:
- S1: FUNCTION  
1. PHONO 2. PHONO 1  
3. TUNER 4. AUX
  - S2: INPUT CAPACITANCE SELECTOR (pF)  
1. 100 2. 200 3. 300 4. 400
  - S3: DUPLICATE  
1. 1 → 2 2. OFF 3. 2 → 1
  - S4: TAPE MONITOR  
1. 1 2. OFF 3. 2
  - S5: MODE  
1. REV 2. STEREO  
3. L+R 4. L 5. R
  - S6: MUTING OFF → 20 dB
  - S7: LOUDNESS OFF → ON
  - S8: HIGH FILTER OFF → BKHz
  - S9: LOW FILTER OFF → 15 Hz
  - S10: TONE OFF → ON
  - S11: SPEAKERS  
1. OFF 2. A 3. B  
4. A + B
  - S12: RELAY OFF → ON
  - S13: POWER OFF → ON
  - S14: INPUT RESISTANCE SELECTOR (kΩ)  
1. 10 2. 25 3. 50 4. 100
  - S15: LINE VOLTAGE SELECTOR  
1. 110V 2. 120V 3. 220V 4. 240V

- RESISTORS:  
IN OHM, 1/4W, ±5% TOLERANCE UNLESS OTHERWISE NOTED. K: kΩ, M: MΩ
- CAPACITORS:  
IN μF UNLESS OTHERWISE NOTED. P: pF
- V: DC VOLTAGE AT NO INPUT SIGNAL  
V: DC VOLTAGE AT 80W x 2 OUTPUT  
mA: DC CURRENT AT NO INPUT SIGNAL  
V: SIGNAL VOLTAGE AT 90W x 2 (B.D., 1KHz) OUTPUT

# SA-9500II/S

## Switch Assembly (AWS-115)

NOTE:  
This assembly is applicable to the S type.

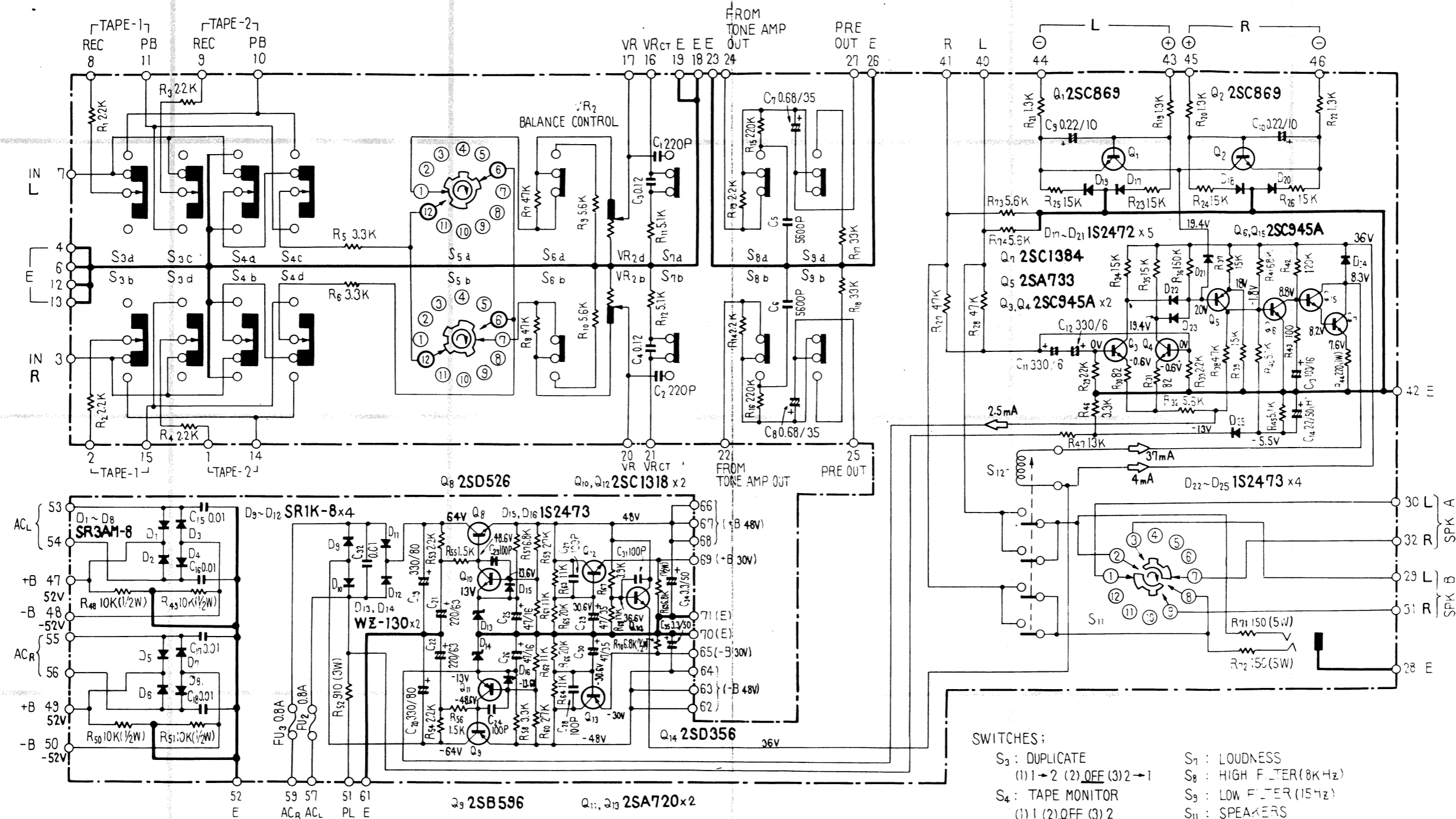

### SWITCHES:

- |  |  |
|--|--|
| S <sub>3</sub> : DUPLICATE<br>(1) 1 → 2 (2) OFF (3) 2 → 1          | S <sub>7</sub> : LOUDNESS<br>S <sub>8</sub> : HIGH FILTER (8KHz) |
| S <sub>4</sub> : TAPE MONITOR<br>(1) 1 (2) OFF (3) 2               | S <sub>9</sub> : LOW FILTER (15Hz)                               |
| S <sub>5</sub> : MODE<br>(1) REV (2) STEREO<br>(3) L+R (4) L (5) R | S <sub>11</sub> : SPEAKERS<br>(1) OFF (2) A (3) B (4) A+B        |
| S <sub>6</sub> : MUTING (-20dB)                                    |  |

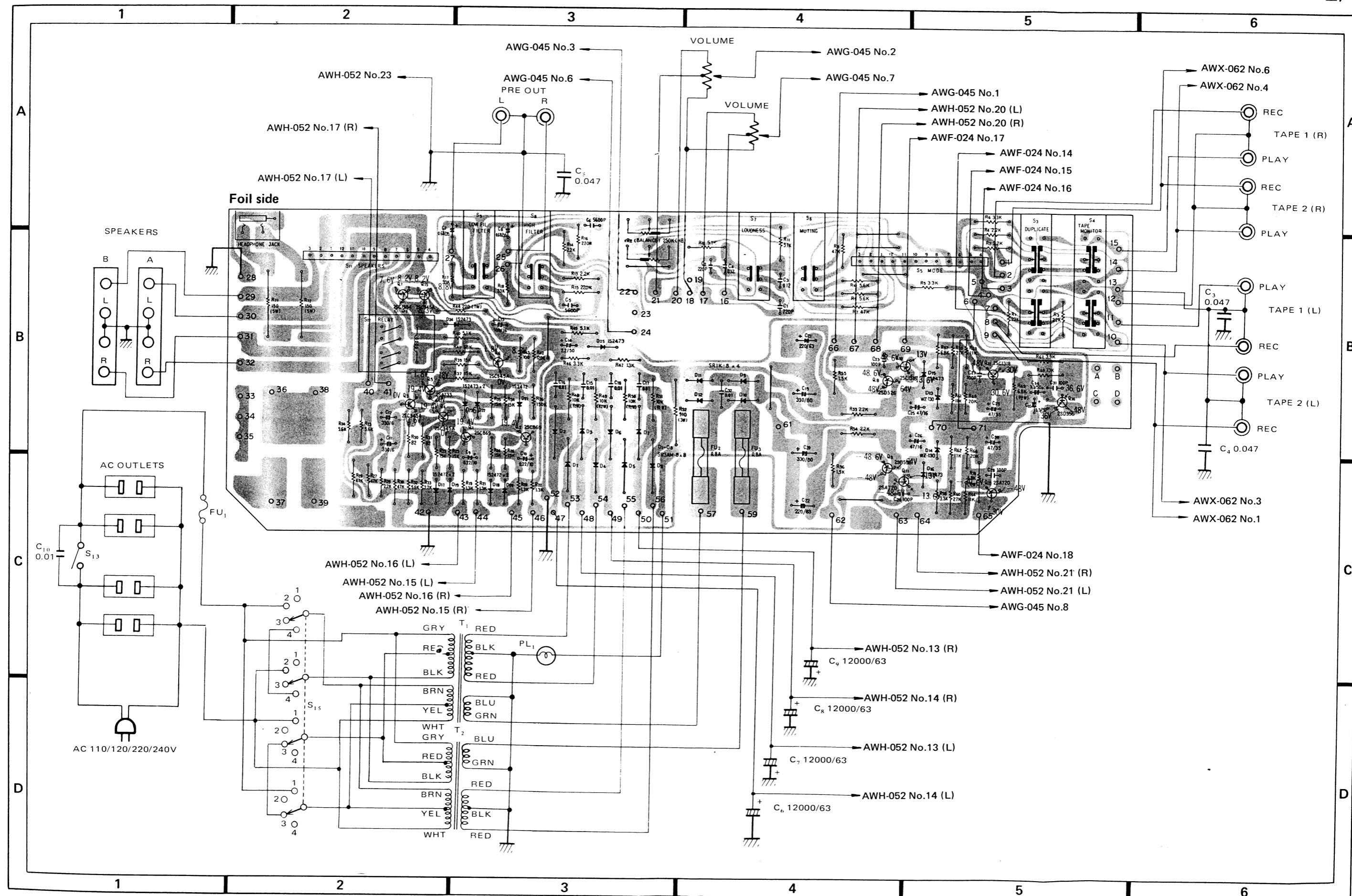

## Parts List of Switch Assembly (AWS-115, for S-type)

## SEMICONDUCTORS

Symbol	Description	Part No.
Q1	Transistor	2SC869-C or D (2SC1649-Q or R)
Q2	Transistor	2SC869-C or D (2SC1649-Q or R)
Q3	Transistor	2SC945A-Q or R
Q4	Transistor	2SC945A-Q or R
Q5	Transistor	2SA733-Q or R (2SA823-Q or R)
Q6	Transistor	2SC945A-Q or R
Q7	Transistor	2SC1384-Q or R
Q8	Transistor	2SD526-O or R (2SD313P-D or E)
Q9	Transistor	2SB596-O or R (2SB507P-D or E)
Q10	Transistor	2SC1318-Q or R
Q11	Transistor	2SA720-Q or R
Q12	Transistor	2SC1318-Q or R
Q13	Transistor	2SA720-Q or R
Q14	Transistor	2SD356-C or D
Q15	Transistor	2SC945A-Q or R
D1	Diode	SR3AM-8 (ERD03-04)
D2	Diode	SR3AM-8 (ERD03-04)
D3	Diode	SR3AM-8 (ERD03-04)
D4	Diode	SR3AM-8 (ERD03-04)
D5	Diode	SR3AM-8 (ERD03-04)
D6	Diode	SR3AM-8 (ERD03-04)
D7	Diode	SR3AM-8 (ERD03-04)
D8	Diode	SR3AM-8 (ERD03-04)
D9	Diode	SR1K-8 (SIB01-04)
D10	Diode	SR1K-8 (SIB01-04)
D11	Diode	SR1K-8 (SIB01-04)
D12	Diode	SR1K-8 (SIB01-04)

Symbol	Description	Part No.
D13	Zener diode	-WZ-130
D14	Zener diode	WZ-130
D15	Diode	1S2473 (1S1555)
D16	Diode	1S2473 (1S1555)
D17	Diode	1S2472 (1S1554)
D18	Diode	1S2472 (1S1554)
D19	Diode	1S2472 (1S1554)
D20	Diode	1S2472 (1S1554)
D21	Diode	1S2472 (1S1554)
D23	Diode	1S2473 (1S1555)
D24	Diode	1S2473 (1S1555)
D25	Diode	1S2473 (1S1555)

## SWITCHES

Symbol	Description	Part No.
S3	Lever switch (DUPLICATE)	ASK-113
S4	Lever switch (MONITOR)	ASK-113
S5	Rotary switch (MODE)	ASD-053
S6	Lever switch (MUTING)	ASK-110
S7	Lever switch (LOUDNESS)	ASK-110
S8	Lever switch (HIGH FILTER)	ASK-110
S9	Lever switch (LOW FILTER)	ASK-110
S11	Rotary switch (SPEAKERS)	ASD-054
S12	Relay	ASR-018

## RESISTORS

Symbol	Description	Part No.
R1	Carbon film 2.2k	RD¼PS 222J
R2	Carbon film 2.2k	RD¼PS 222J
R3	Carbon film 2.2k	RD¼PS 222J
R4	Carbon film 2.2k	RD¼PS 222J
R5	Carbon film 3.3k	RD¼PS 332J
R6	Carbon film 3.3k	RD¼PS 332J
R7	Carbon film 47k	RD¼PS 473J
R8	Carbon film 47k	RD¼PS 473J
R9	Carbon film 5.6k	RD¼PS 562J
R10	Carbon film 5.6k	RD¼PS 562J

Symbol	Description	Part No.
R11	Carbon film 5.1k	RD½PS 512J
R12	Carbon film 5.1k	RD½PS 512J
R13	Carbon film 2.2k	RD½PS 222J
R14	Carbon film 2.2k	RD½PS 222J
R15	Carbon film 220k	RD½PS 224J
R16	Carbon film 220k	RD½PS 224J
R17	Carbon film 33k	RD½PS 333J
R18	Carbon film 33k	RD½PS 333J
R19	Carbon film 1.3k	RD½PS 132J
R20	Carbon film 1.3k	RD½PS 132J
R21	Carbon film 1.3k	RD½PS 132J
R22	Carbon film 1.3k	RD½PS 132J
R23	Carbon film 15k	RD½PS 153J
R24	Carbon film 15k	RD½PS 153J
R25	Carbon film 15k	RD½PS 153J
R26	Carbon film 15k	RD½PS 153J
R27	Carbon film 47k	RD½PS 473J
R28	Carbon film 47k	RD½PS 473J
R29	Carbon film 2.2k	RD½PS 222J
R30	Carbon film 82	RD½PS 820J
R31	Carbon film 82	RD½PS 820J
R32	Carbon film 5.6k	RD½PS 562J
R33	Carbon film 2.2k	RD½PS 222J
R34	Carbon film 15k	RD½PS 153J
R35	Carbon film 15k	RD½PS 153J
R36	Carbon film 150k	RD½PS 154J
R37	Carbon film 15k	RD½PS 153J
R38	Carbon film 47k	RD½PS 473J
R39	Carbon film 15k	RD½PS 153J
R40	Carbon film 5.1k	RD½PS 512J
R41	Carbon film 68k	RD½PS 683J
R42	Carbon film 120k	RD½PS 124J
R43	Carbon film 100	RD½PS 101J
R44	Metal oxide 220	RS1P 221J
R45	Carbon film 5.1k	RD½PS 512J
R46	Carbon film 3.3k	RD½PS 332J
R47	Carbon film 13k	RD½PS 133J
R48	Carbon film 10k	RD½PS 103J
R49	Carbon film 10k	RD½PS 103J
R50	Carbon film 10k	RD½PS 103J
R51	Carbon film 10k	RD½PS 103J
R52	Metal oxide 910	RS3P 911J
R53	Carbon film 2.2k	RD½PS 222J
R54	Carbon film 2.2k	RD½PS 222J
R55	Carbon film 1.5k	RD½PS 152J
R56	Carbon film 1.5k	RD½PS 152J
R57	Carbon film 6.8k	RD½PS 682J
R58	Carbon film 3.3k	RD½PS 332J
R59	Carbon film 27k	RD½PS 273J
R60	Carbon film 27k	RD½PS 273J
R61	Carbon film 11k	RD½PS 113J
R62	Carbon film 11k	RD½PS 113J

Symbol	Description	Part No.
R63	Carbon film 11k	RD½PS 113J
R64	Carbon film 11k	RD½PS 113J
R65	Carbon film 20k	RD½PS 203J
R66	Carbon film 20k	RD½PS 203J
R67	Carbon film 3.9k	RD½PS 392J
R68	Carbon film 13k	RD½PS 133J
R69	Carbon film 6.8k	RD½PS 682J
R70	Carbon film 6.8k	RD½PS 682J
R71	Wire wound 150	RT5B 151K
R72	Wire wound 150	RT5B 151K
R73	Carbon film 5.6k	RD½PS 562J
R74	Carbon film 5.6k	RD½PS 562J
VR2	Variable resistor 250k-HB (BALANCE)	ACV-172

### CAPACITORS

Symbol	Description	Part No.
C1	Ceramic 220p 50V	CCDSL 221K 50
C2	Ceramic 220p 50V	CCDSL 221K 50
C3	Mylar 0.12 50V	CQMA 124K 50
C4	Mylar 0.12 50V	CQMA 124K 50
C5	Mylar 0.0056 50V	CQMA 562J 50
C6	Mylar 0.0056 50V	CQMA 562J 50
C7	Electrolytic 0.68 35V	CSZA R68M 35
C8	Electrolytic 0.68 35V	CSZA R68M 35
C9	Electrolytic 0.22 10V	CSSA R22M 10
C10	Electrolytic 0.22 10V	CSSA R22M 10
C11	Electrolytic 330 6V	CEA 331P 6
C12	Electrolytic 330 6V	CEA 331P 6
C13	Electrolytic 100 16V	CEA 101P 16
C14	Electrolytic 2.2 50V	ACH-317
G15	Ceramic 0.01 150V	ACG-004
C16	Ceramic 0.01 150V	ACG-004
C17	Ceramic 0.01 150V	ACG-004
C18	Ceramic 0.01 150V	ACG-004
C19	Electrolytic 330 80V	CEA 331P 80
C20	Electrolytic 330 80V	CEA 331P 80
C21	Electrolytic 220 63V	CEA 221P 63
C22	Electrolytic 220 63V	CEA 221P 63
C23	Ceramic 100p 50V	CCDSL 101K 50
C24	Ceramic 100p 50V	CCDSL 101K 50
C25	Electrolytic 47 16V	CEA 470P 16
C26	Electrolytic 47 16V	CEA 470P 16
C27	Ceramic 100p 50V	CCDSL 101K 50
C28	Ceramic 100p 50V	CCDSL 101K 50
C29	Electrolytic 47 35V	CEA 470P 35
C30	Electrolytic 47 35V	CEA 470P 35
C31	Ceramic 100p 50V	CCDSL 101K 50
C32	Ceramic 0.01 150V	ACG-004
C33	Vacancy	.....
C34	Electrolytic 3.3 50V	CEA 3R3P 50
C35	Electrolytic 3.3 50V	CEA 3R3P 50



OTHERS

Symbol	Description	Part No.
	Phone jack (PHONES)	AKN-008
	Fuse clip	AKR-013
	Heat sink	ANH-117
	Washer faced nut M9	ABN-024
	Special nut	ABN-027

Exploded View of Rear Panel for S type

NOTE:

Parts indicated in red type cannot be supplied.

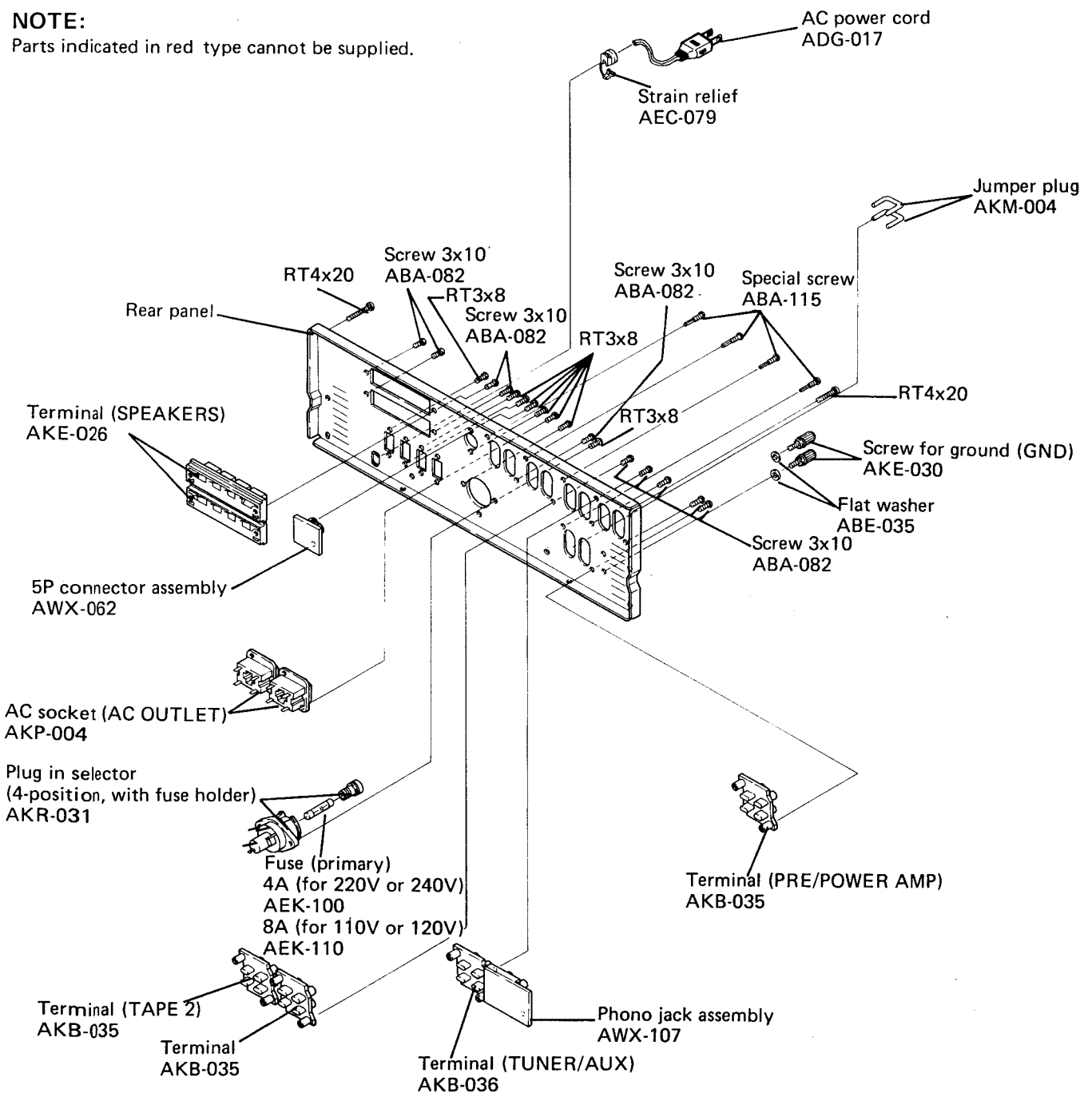

# SA-9500II/HG

## Miscellaneous Parts for HG-type

### SEMICONDUCTORS

Symbol	Description	Part No.
Q1	Transistor	2SD588A/A/-R or Q
Q2	Transistor	2SD588A/A/-R or Q
Q3	Transistor	2SB618A/A/-R or Q
Q4	Transistor	2SB618A/A/-R or Q
Q5	Transistor	2SD588A/A/-R or Q
Q6	Transistor	2SD588A/A/-R or Q
Q7	Transistor	2SB618A/A/-R or Q
Q8	Transistor	2SB618A/A/-R or Q

### CAPACITORS

Symbol	Description	Part No.
C1	Ceramic 0.047 50V	CKDYF 473Z 50
C2	Ceramic 0.047 50V	CKDYF 473Z 50
C3	Ceramic 0.047 50V	CKDYF 473Z 50
C4	Ceramic 0.047 50V	CKDYF 473Z 50
C5	Ceramic 0.047 50V	CKDYF 473Z 50
C6	Electrolytic 12,000 63V	ACH-065
C7	Electrolytic 12,000 63V	ACH-065
C8	Electrolytic 12,000 63V	ACH-065
C9	Electrolytic 12,000 63V	ACH-065

### LAMP, FUSES

Symbol	Description	Part No.
PL1	Lamp with leads 8V, 50mA	AEL-069
FU1	Fuse 2A	AEK-017
FU2	Fuse 2A	AEK-017
FU3	Fuse 0.8A	AEK-031
FU4	Fuse 0.8A	AEK-031

### SWITCH

Symbol	Description	Part No.
S13	Lever switch (POWER)	ASK-127
S15	Plug in selector (2-position)	AKX-037

### TRANSFORMERS

Symbol	Description	Part No.
T1	Power transformer (L)	ATT-378
T2	Power transformer (R)	ATT-379

### RESISTOR

Symbol	Description	Part No.
VR1	Variable resistor 100k 32-step (VOLUME)	ACV-171

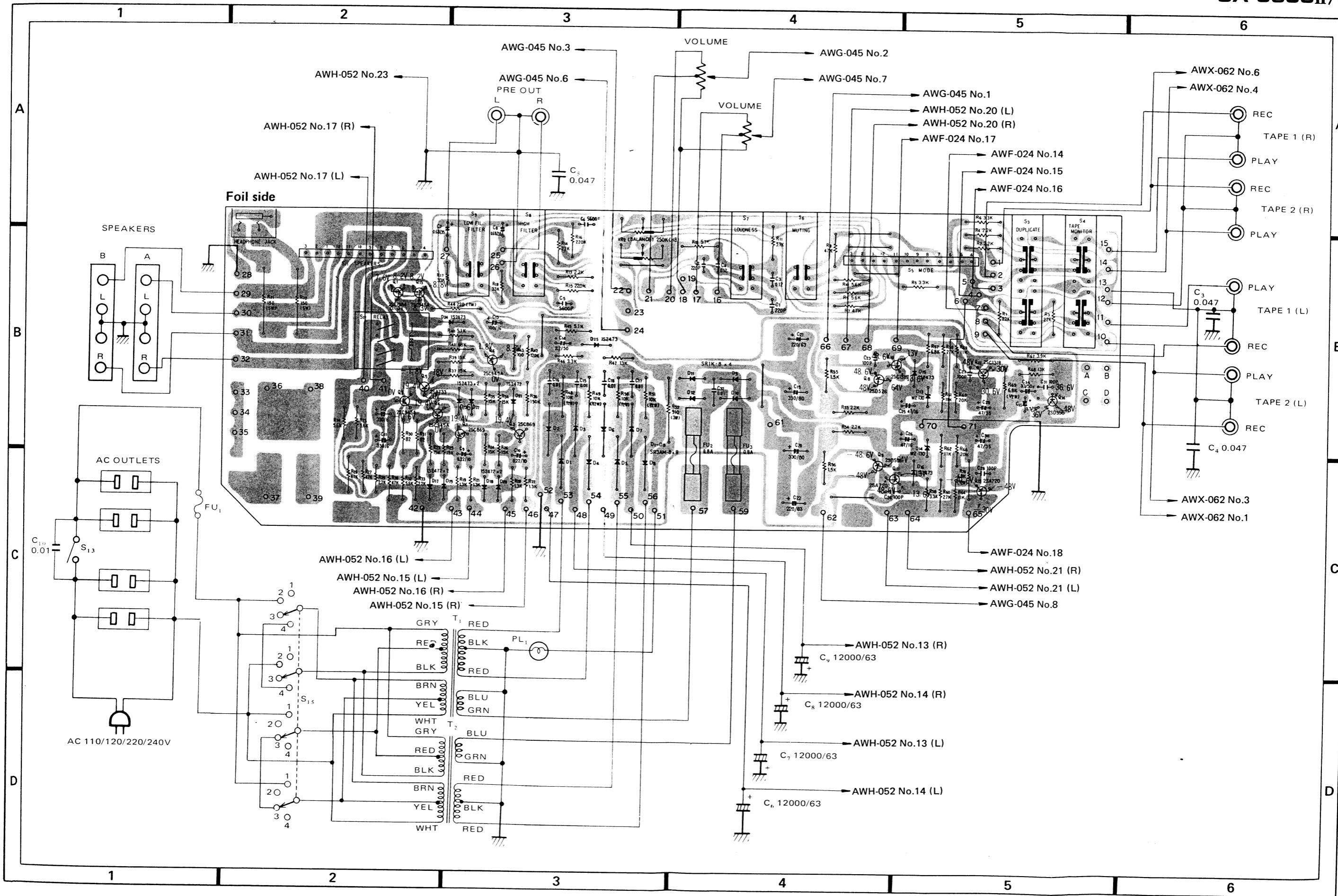

Schematic Diagram for HG type

**NOTE:**  
The indicated semiconductors are representative ones only. Other alternative semiconductors may be used and are listed in the parts list.

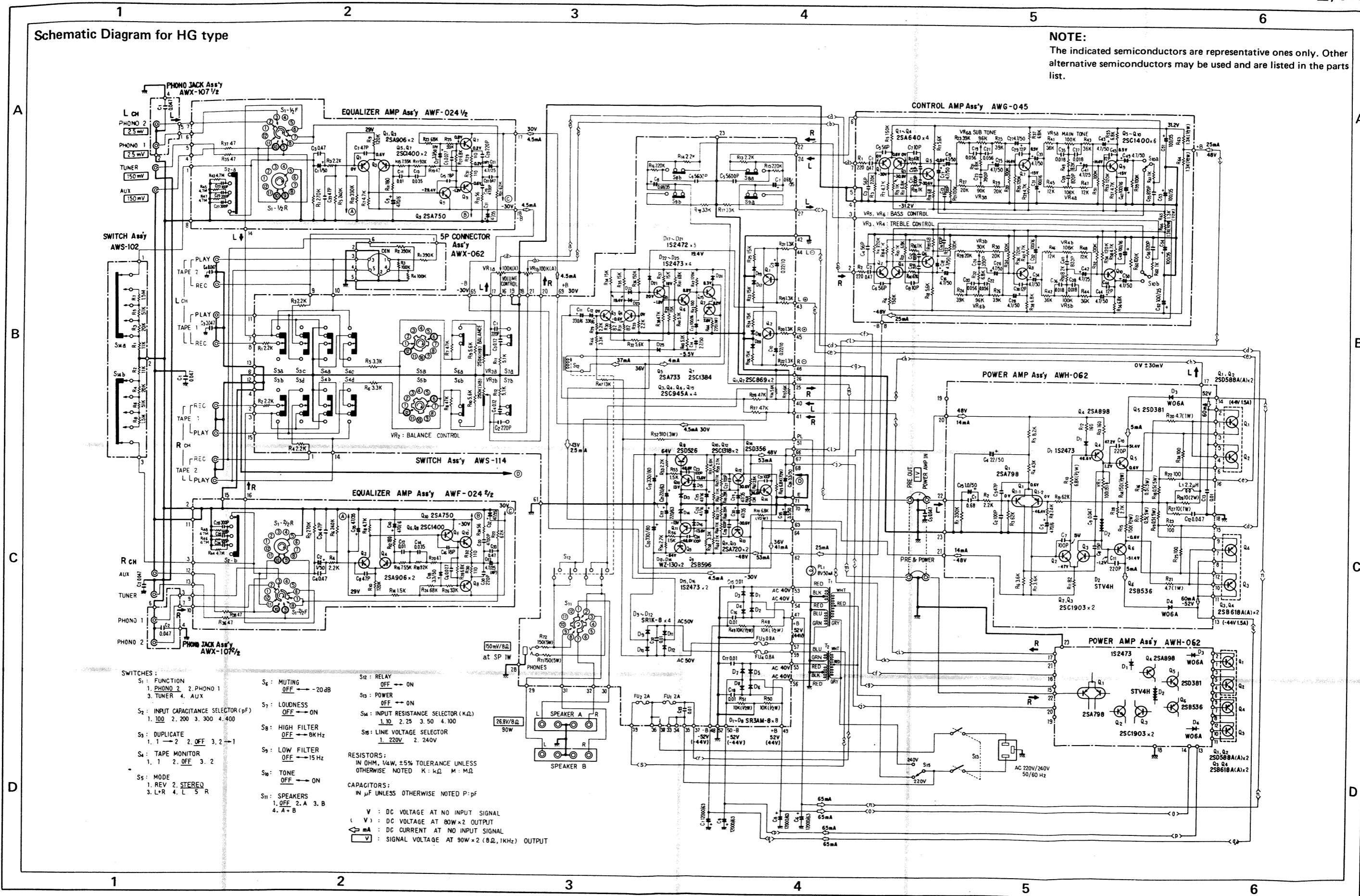

- SWITCHES:**
- S<sub>1</sub>: FUNCTION  
1. PHONO 2. PHONO 1  
3. TUNER 4. AUX
  - S<sub>2</sub>: INPUT CAPACITANCE SELECTOR (pF)  
1. 100 2. 200 3. 300 4. 400
  - S<sub>3</sub>: DUPLICATE  
1. 1 → 2 2. OFF 3. 2 → 1
  - S<sub>4</sub>: TAPE MONITOR  
1. 1 2. OFF 3. 2
  - S<sub>5</sub>: MODE  
1. REV 2. STEREO  
3. L-R 4. L 5. R
  - S<sub>6</sub>: MUTING OFF → -20 dB
  - S<sub>7</sub>: LOUDNESS OFF → ON
  - S<sub>8</sub>: HIGH FILTER OFF → 8KHz
  - S<sub>9</sub>: LOW FILTER OFF → 15Hz
  - S<sub>10</sub>: TONE OFF → ON
  - S<sub>11</sub>: SPEAKERS  
1. OFF 2. A 3. B  
4. A + B

- RESISTORS:**  
IN OHM, KΩ, MΩ, ±5% TOLERANCE UNLESS OTHERWISE NOTED K: KΩ M: MΩ
- CAPACITORS:**  
IN μF UNLESS OTHERWISE NOTED P: pF

- V : DC VOLTAGE AT NO INPUT SIGNAL  
V : DC VOLTAGE AT 80W × 2 OUTPUT  
mA : DC CURRENT AT NO INPUT SIGNAL  
V : SIGNAL VOLTAGE AT 90W × 2 (8Ω, 1KHz) OUTPUT

# SA-9500II/HG

## Switch Assembly (AWS-114)

**NOTE:**  
This assembly is applicable to the HG type.

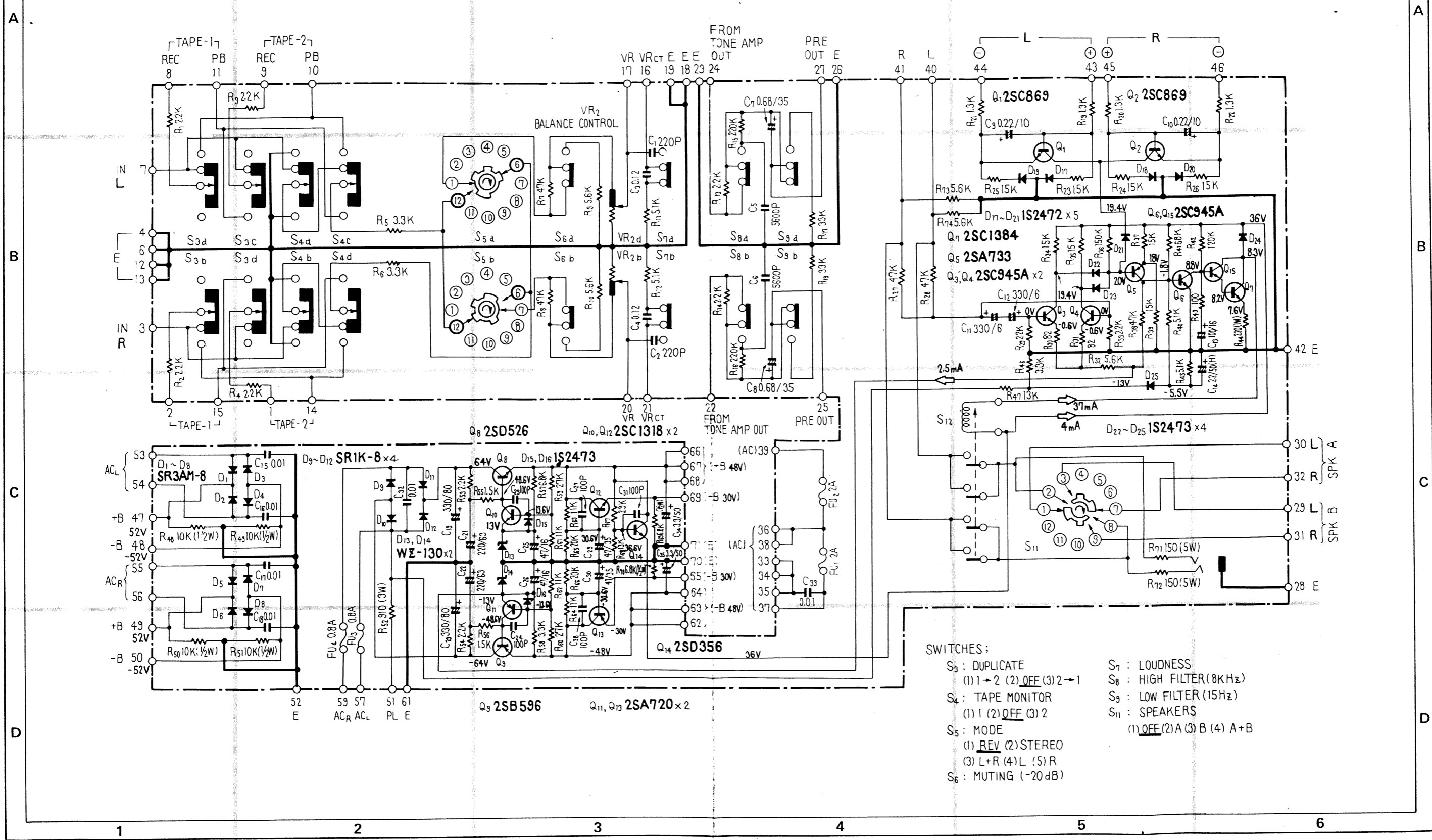

- SWITCHES:**
- S<sub>3</sub> : DUPLICATE  
(1) 1 → 2 (2) OFF (3) 2 → 1
  - S<sub>4</sub> : TAPE MONITOR  
(1) 1 (2) OFF (3) 2
  - S<sub>5</sub> : MODE  
(1) REV (2) STEREO  
(3) L+R (4) L (5) R
  - S<sub>6</sub> : MUTING (-20 dB)
  - S<sub>1</sub> : LOUDNESS
  - S<sub>8</sub> : HIGH FILTER (8KHz)
  - S<sub>9</sub> : LOW FILTER (15Hz)
  - S<sub>11</sub> : SPEAKERS  
(1) OFF (2) A (3) B (4) A+B

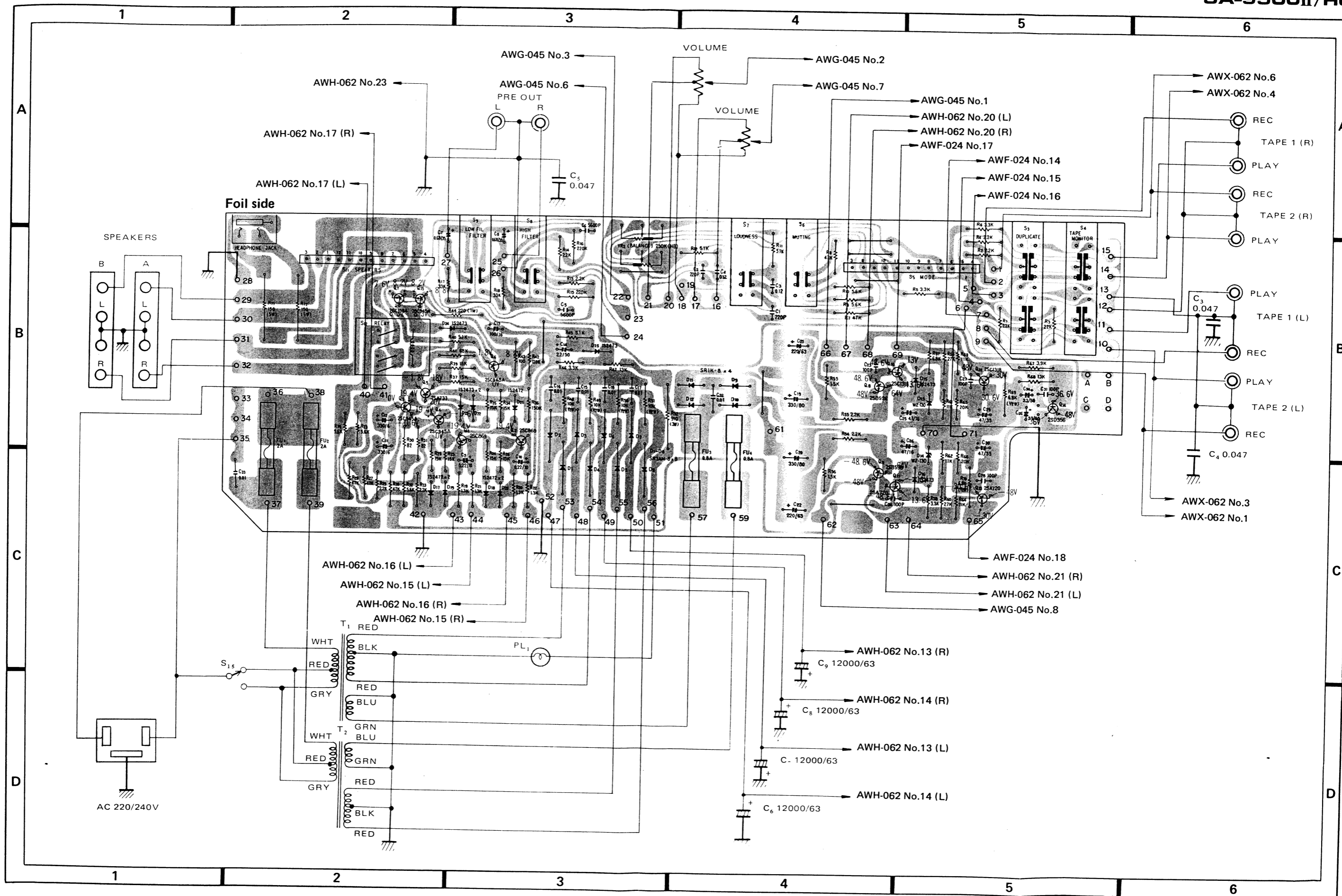

Parts List of Switch Assembly (AWS-114, for HG-type)

SEMICONDUCTORS

Symbol	Description	Part No.
Q1	Transistor	2SC869-C or D (2SC1649-Q or R)
Q2	Transistor	2SC869-C or D (2SC1649-Q or R)
Q3	Transistor	2SC945A-Q or R
Q4	Transistor	2SC945A-Q or R
Q5	Transistor	2SA733-Q or R (2SA823-Q or R)
Q6	Transistor	2SC945A-Q or R
Q7	Transistor	2SC1384-Q or R
Q8	Transistor	2SD526-O or R (2SD313P-D or E)
Q9	Transistor	2SB596-O or R (2SB507P-D or E)
Q10	Transistor	2SC1318-Q or R
Q11	Transistor	2SA720-Q or R
Q12	Transistor	2SC1318-Q or R
Q13	Transistor	2SA720-Q or R
Q14	Transistor	2SD356-C or D
Q15	Transistor	2SC945A-Q or R
D1	Diode	SR3AM-8 (ERD03-04)
D2	Diode	SR3AM-8 (ERD03-04)
D3	Diode	SR3AM-8 (ERD03-04)
D4	Diode	SR3AM-8 (ERD03-04)
D5	Diode	SR3AM-8 (ERD03-04)
D6	Diode	SR3AM-8 (ERD03-04)
D7	Diode	SR3AM-8 (ERD03-04)
D8	Diode	SR3AM-8 (ERD03-04)
D9	Diode	SR1K-8 (SIB01-04)
D10	Diode	SR1K-8 (SIB01-04)
D11	Diode	SR1K-8 (SIB01-04)
D12	Diode	SR1K-8 (SIB01-04)

Symbol	Description	Part No.
D13	Zener diode	WZ-130
D14	Zener diode	WZ-130
D15	Diode	1S2473 (1S1555)
D16	Diode	1S2473 (1S1555)
D17	Diode	1S2472 (1S1554)
D18	Diode	1S2472 (1S1554)
D19	Diode	1S2472 (1S1554)
D20	Diode	1S2472 (1S1554)
D21	Diode	1S2472 (1S1554)
D23	Diode	1S2473 (1S1555)
D24	Diode	1S2473 (1S1555)
D25	Diode	1S2473 (1S1555)

SWITCHES

Symbol	Description	Part No.
S3	Lever switch (DUPLICATE)	ASK-113
S4	Lever switch (MONITOR)	ASK-113
S5	Rotary switch (MODE)	ASD-053
S6	Lever switch (MUTING)	ASK-110
S7	Lever switch (LOUDNESS)	ASK-110
S8	Lever switch (HIGH FILTER)	ASK-110
S9	Lever switch (LOW FILTER)	ASK-110
S11	Rotary switch (SPEAKERS)	ASD-054
S12	Relay	ASR-018

RESISTORS

Symbol	Description	Part No.
R1	Carbon film 2.2k	RD¼PS 222J
R2	Carbon film 2.2k	RD¼PS 222J
R3	Carbon film 2.2k	RD¼PS 222J
R4	Carbon film 2.2k	RD¼PS 222J
R5	Carbon film 3.3k	RD¼PS 332J
R6	Carbon film 3.3k	RD¼PS 332J
R7	Carbon film 47k	RD¼PS 473J
R8	Carbon film 47k	RD¼PS 473J
R9	Carbon film 5.6k	RD¼PS 562J
R10	Carbon film 5.6k	RD¼PS 562J

Symbol	Description	Part No.
R11	Carbon film 5.1k	RD½PS 512J
R12	Carbon film 5.1k	RD½PS 512J
R13	Carbon film 2.2k	RD½PS 222J
R14	Carbon film 2.2k	RD½PS 222J
R15	Carbon film 220k	RD½PS 224J
R16	Carbon film 220k	RD½PS 224J
R17	Carbon film 33k	RD½PS 333J
R18	Carbon film 33k	RD½PS 333J
R19	Carbon film 1.3k	RD½PS 132J
R20	Carbon film 1.3k	RD½PS 132J
R21	Carbon film 1.3k	RD½PS 132J
R22	Carbon film 1.3k	RD½PS 132J
R23	Carbon film 15k	RD½PS 153J
R24	Carbon film 15k	RD½PS 153J
R25	Carbon film 15k	RD½PS 132J
R26	Carbon film 15k	RD½PS 153J
R27	Carbon film 47k	RD½PS 473J
R28	Carbon film 47k	RD½PS 473J
R29	Carbon film 2.2k	RD½PS 222J
R30	Carbon film 82	RD½PS 820J
R31	Carbon film 82	RD½PS 820J
R32	Carbon film 5.6k	RD½PS 562J
R33	Carbon film 2.2k	RD½PS 222J
R34	Carbon film 15k	RD½PS 153J
R35	Carbon film 15k	RD½PS 153J
R36	Carbon film 150k	RD½PS 154J
R37	Carbon film 15k	RD½PS 153J
R38	Carbon film 47k	RD½PS 473J
R39	Carbon film 15k	RD½PS 153J
R40	Carbon film 5.1k	RD½PS 512J
R41	Carbon film 68k	RD½PS 683J
R42	Carbon film 120k	RD½PS 124J
R43	Carbon film 100	RD½PS 101J
R44	Metal oxide 220 1W	RS1P 221J
R45	Carbon film 5.1k	RD½PS 512J
R46	Carbon film 3.3k	RD½PS 332J
R47	Carbon film 13k	RD½PS 133J
R48	Carbon film 10k ½W	RD½PS 103J
R49	Carbon film 10k ½W	RD½PS 103J
R50	Carbon film 10k ½W	RD½PS 103J
R51	Carbon film 10k ½W	RD½PS 103J
R52	Metal oxide 910 3W	RS3P 911J
R53	Carbon film 2.2k	RD½PS 222J
R54	Carbon film 2.2k	RD½PS 222J
R55	Carbon film 1.5k	RD½PS 152J
R56	Carbon film 1.5k	RD½PS 152J
R57	Carbon film 6.8k	RD½PS 682J
R58	Carbon film 3.3k	RD½PS 332J
R59	Carbon film 27k	RD½PS 273J
R60	Carbon film 27k	RD½PS 273J
R61	Carbon film 11k	RD½PS 113J
R62	Carbon film 11k	RD½PS 113J

Symbol	Description	Part No.
R63	Carbon film 11k	RD½PS 113J
R64	Carbon film 11k	RD½PS 113J
R65	Carbon film 20k	RD½PS 203J
R66	Carbon film 20k	RD½PS 203J
R67	Carbon film 3.9k	RD½PS 392J
R68	Carbon film 13k	RD½PS 133J
R69	Carbon film 6.8k ½W	RD½PS 682J
R70	Carbon film 6.8k ½W	RD½PS 682J
R71	Wire wound 150 5W	RT5B 151K
R72	Wire wound 150 5W	RT5B 151K
R73	Carbon film 5.6k	RD½PS 562J
R74	Carbon film 5.6k	RD½PS 562J
VR2	Variable resistor 250k-HB (BALANCE)	ACV-172

### CAPACITORS

Symbol	Description	Part No.
C1	Ceramic 220p 50V	CCDSL 221K 50
C2	Ceramic 220p 50V	CCDSL 221K 50
C3	Mylar 0.12 50V	CQMA 124K 50
C4	Mylar 0.12 50V	CQMA 124K 50
C5	Mylar 0.0056 50V	CQMA 562J 50
C6	Mylar 0.0056 50V	CQMA 562J 50
C7	Electrolytic 0.68 35V	CSZA R68M 35
C8	Electrolytic 0.68 35V	CSZA R68M 35
C9	Electrolytic 0.22 10V	CSSA R22M 10
C10	Electrolytic 0.22 10V	CSSA R22M 10
C11	Electrolytic 330 6V	CEA 331P 6
C12	Electrolytic 330 6V	CEA 331P 6
C13	Electrolytic 100 16V	CEA 101P 16
C14	Electrolytic 2.2 50V	ACH-317
C15	Ceramic 0.01 150V	ACG-004
C16	Ceramic 0.01 150V	ACG-004
C17	Ceramic 0.01 150V	ACG-004
C18	Ceramic 0.01 150V	ACG-004
C19	Electrolytic 330 80V	CEA 331P 80
C20	Electrolytic 330 80V	CEA 331P 80
C21	Electrolytic 220 63V	CEA 221P 63
C22	Electrolytic 220 63V	CEA 221P 63
C23	Ceramic 100p 50V	CCDSL 101K 50
C24	Ceramic 100p 50V	CCDSL 101K 50
C25	Electrolytic 47 16V	CEA 470P 16
C26	Electrolytic 47 16V	CEA 470P 16
C27	Ceramic 100p 50V	CCDSL 101K 50
C28	Ceramic 100p 50V	CCDSL 101K 50
C29	Electrolytic 47 35V	CEA 470P 35
C30	Electrolytic 47 35V	CEA 470P 35
C31	Ceramic 100p 50V	CCDSL 101K 50
C32	Ceramic 0.01 150V	ACG-004
C33	Ceramic 0.01 250V	ACG-001
C34	Electrolytic 3.3 50V	CEA 3R3P 50
C35	Electrolytic 3.3 50V	CEA 3R3P 50



OTHERS

Symbol	Description	Part No.
	Phone jack (PHONES)	AKN-008
	Fuse clip	AKR-010
	Heat sink	ANH-117
	Washer faced nut M9	ABN-024
	Special nut	ABN-027

Exploded View of Rear Panel for HG type

NOTE:

Parts indicated in red type cannot be supplied.

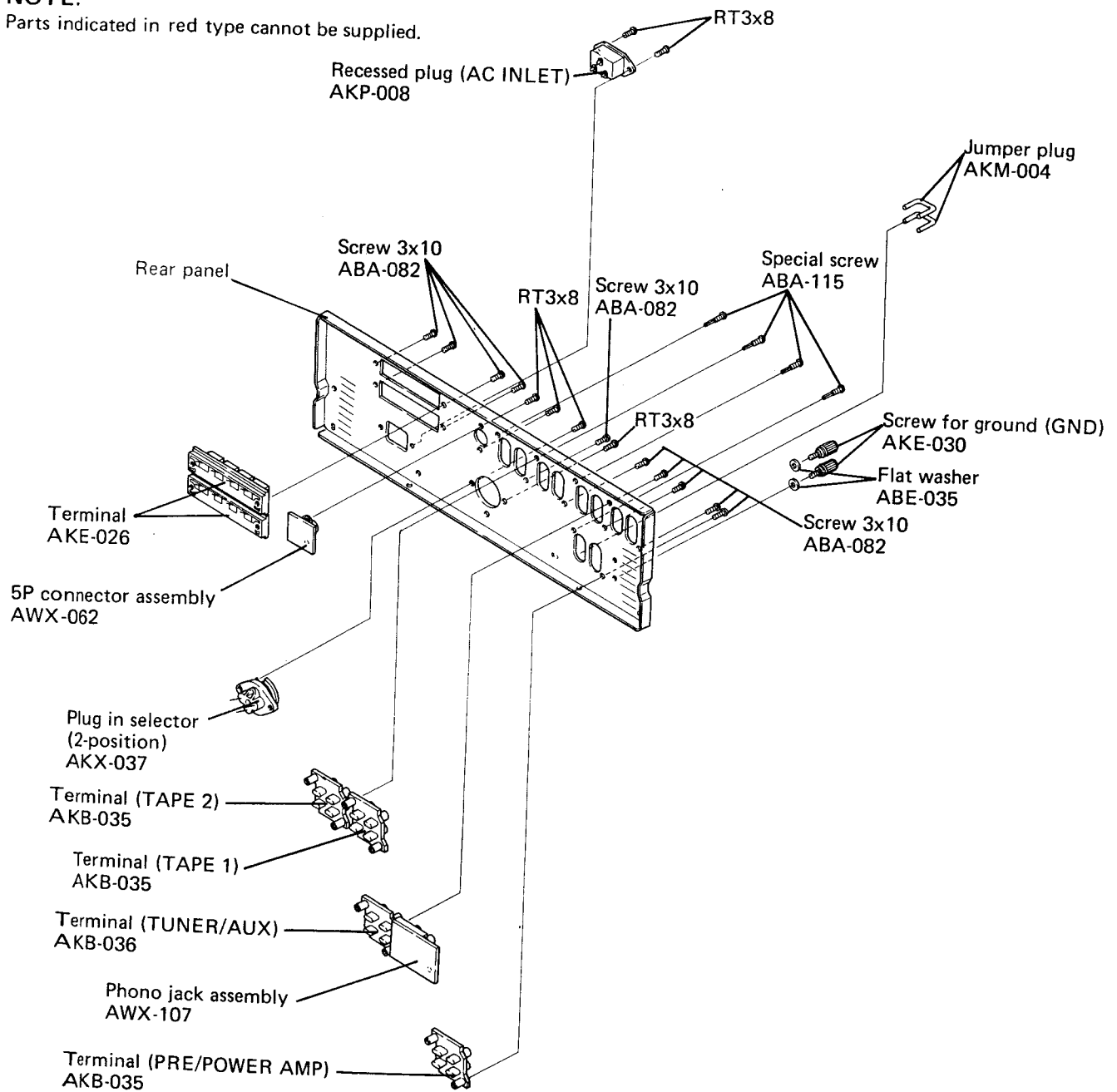

# Power Amplifier Assembly (AWH-062)

**NOTE:**  
This assembly is applicable to the HG type.

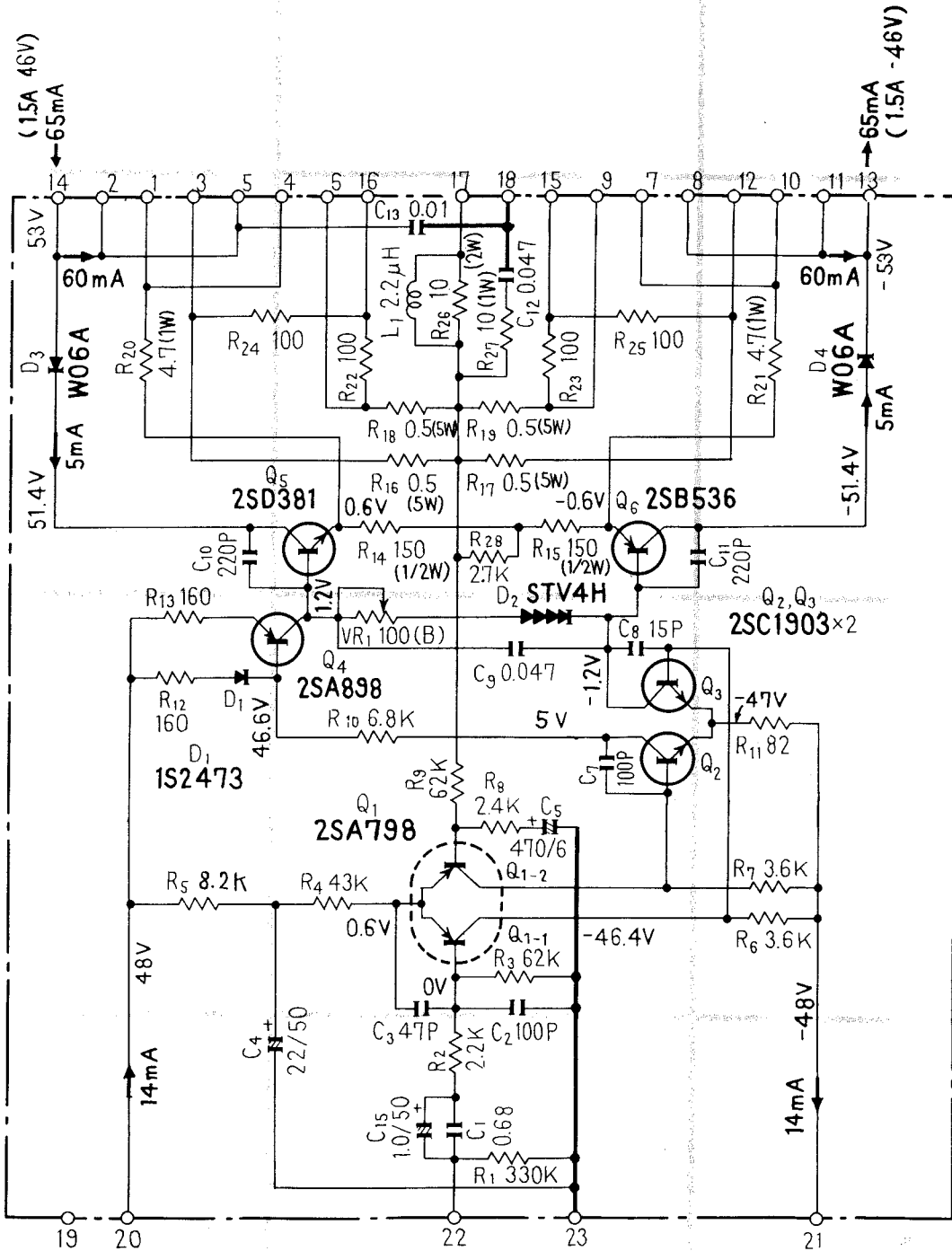

STEREO AMPLIFIER

# SA-9500II KU

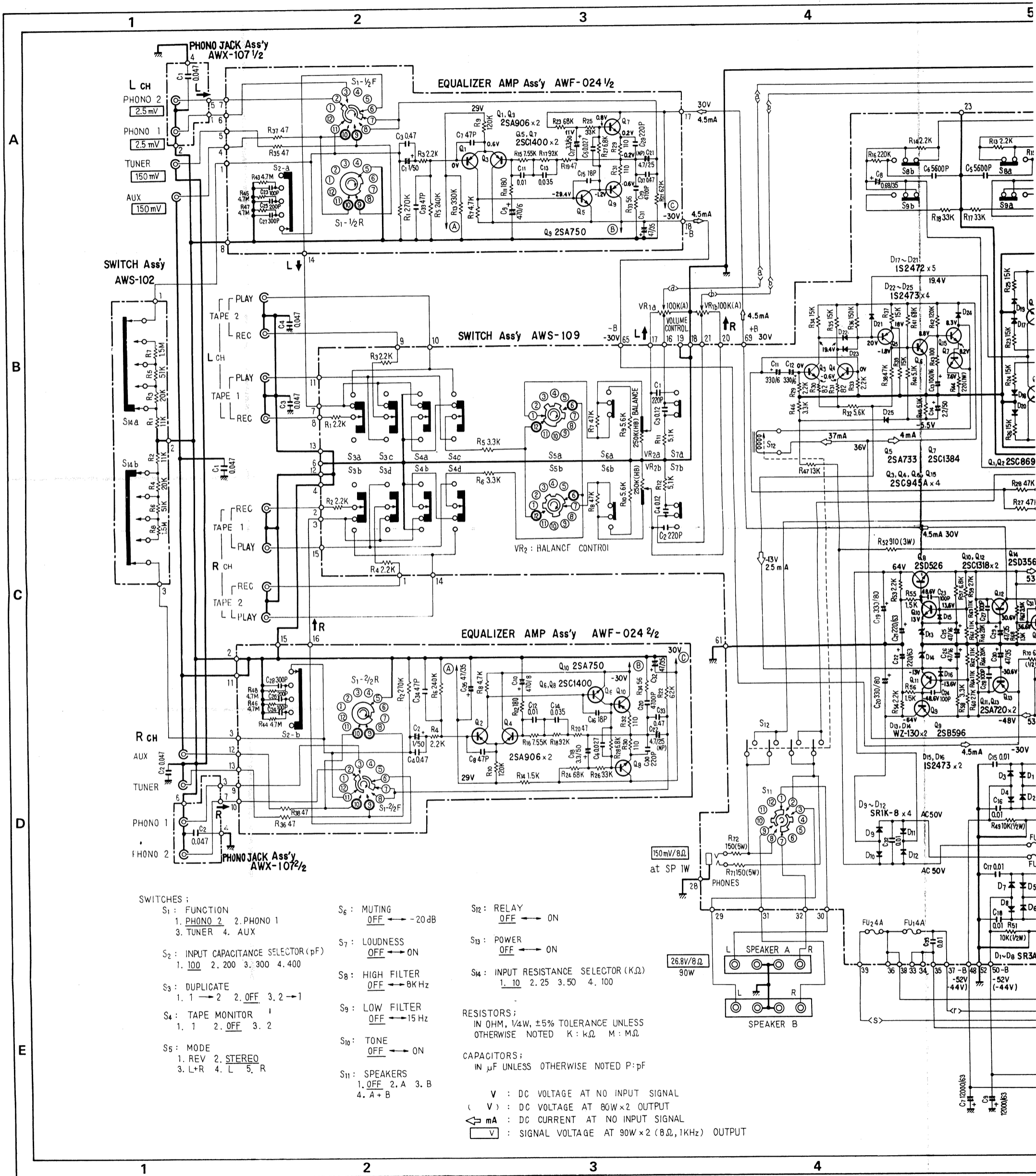

SWITCHES :

- |   |  |  |
|---|--|--|
| S <sub>1</sub> : FUNCTION<br>1. PHONO 2. PHONO 1<br>3. TUNER 4. AUX             | S <sub>6</sub> : MUTING<br>OFF → -20 dB                  | S <sub>12</sub> : RELAY<br>OFF → ON  |
| S <sub>2</sub> : INPUT CAPACITANCE SELECTOR (pF)<br>1. 100 2. 200 3. 300 4. 400 | S <sub>7</sub> : LOUDNESS<br>OFF → ON                    | S <sub>13</sub> : POWER<br>OFF → ON  |
| S <sub>3</sub> : DUPLICATE<br>1. 1 → 2 2. OFF 3. 2 → 1                          | S <sub>8</sub> : HIGH FILTER<br>OFF → 8K Hz              | S <sub>14</sub> : INPUT RESISTANCE SELECTOR (KΩ)<br>1. 10 2. 25 3. 50 4. 100 |
| S <sub>4</sub> : TAPE MONITOR<br>1. 1 2. OFF 3. 2                               | S <sub>9</sub> : LOW FILTER<br>OFF → 15 Hz               |  |
| S <sub>5</sub> : MODE<br>1. REV 2. STEREO<br>3. L+R 4. L 5. R                   | S <sub>10</sub> : TONE<br>OFF → ON                       |  |
|   | S <sub>11</sub> : SPEAKERS<br>1. OFF 2. A 3. B<br>4. A+B |  |

RESISTORS :  
IN OHM, 1/4W, ±5% TOLERANCE UNLESS  
OTHERWISE NOTED K : kΩ M : MΩ

CAPACITORS :  
IN μF UNLESS OTHERWISE NOTED P : pF

- V : DC VOLTAGE AT NO INPUT SIGNAL
- ( V ) : DC VOLTAGE AT 80W X 2 OUTPUT
- mA : DC CURRENT AT NO INPUT SIGNAL
- V : SIGNAL VOLTAGE AT 90W X 2 (8Ω, 1KHz) OUTPUT

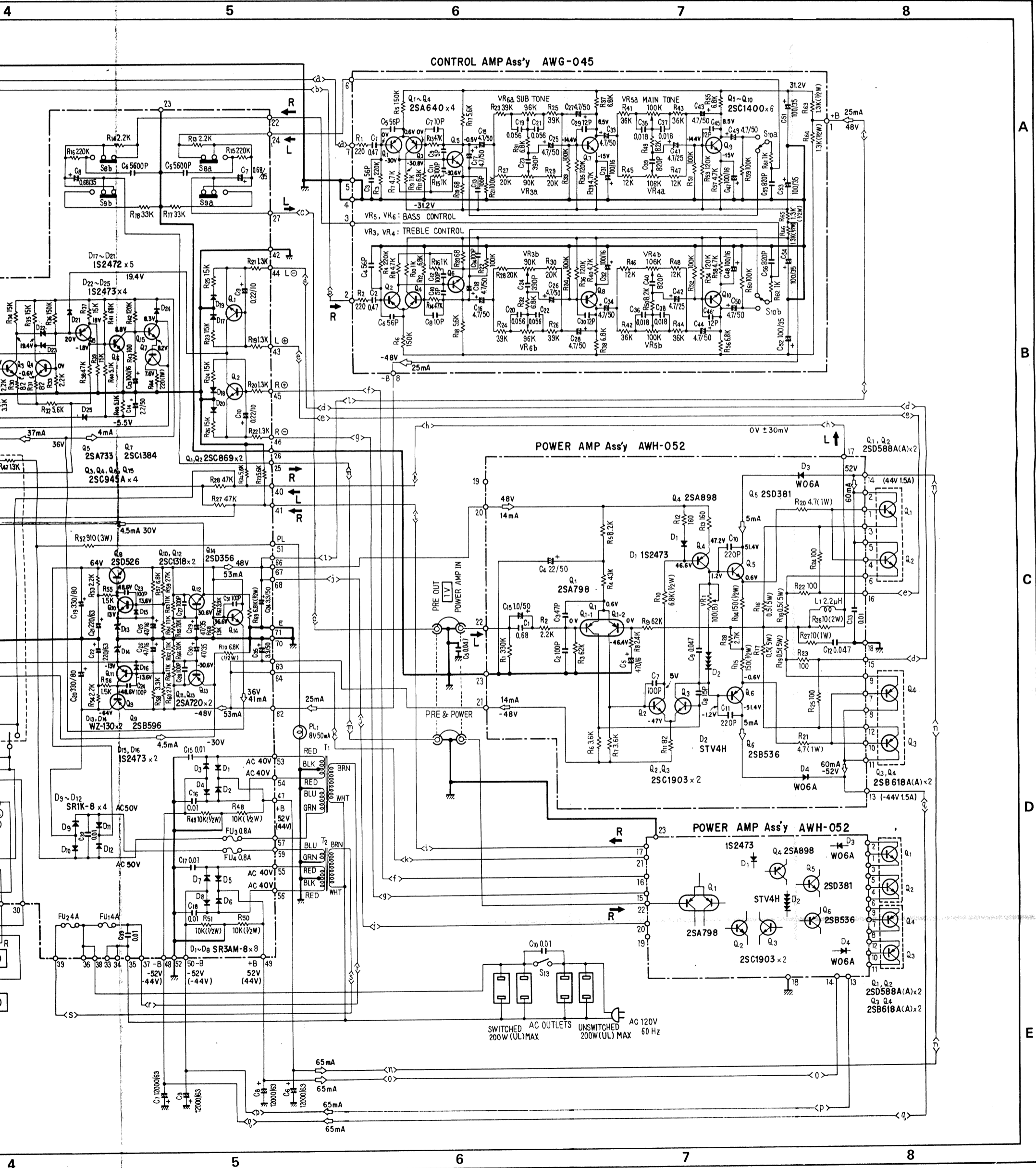

# SA-9500II HG

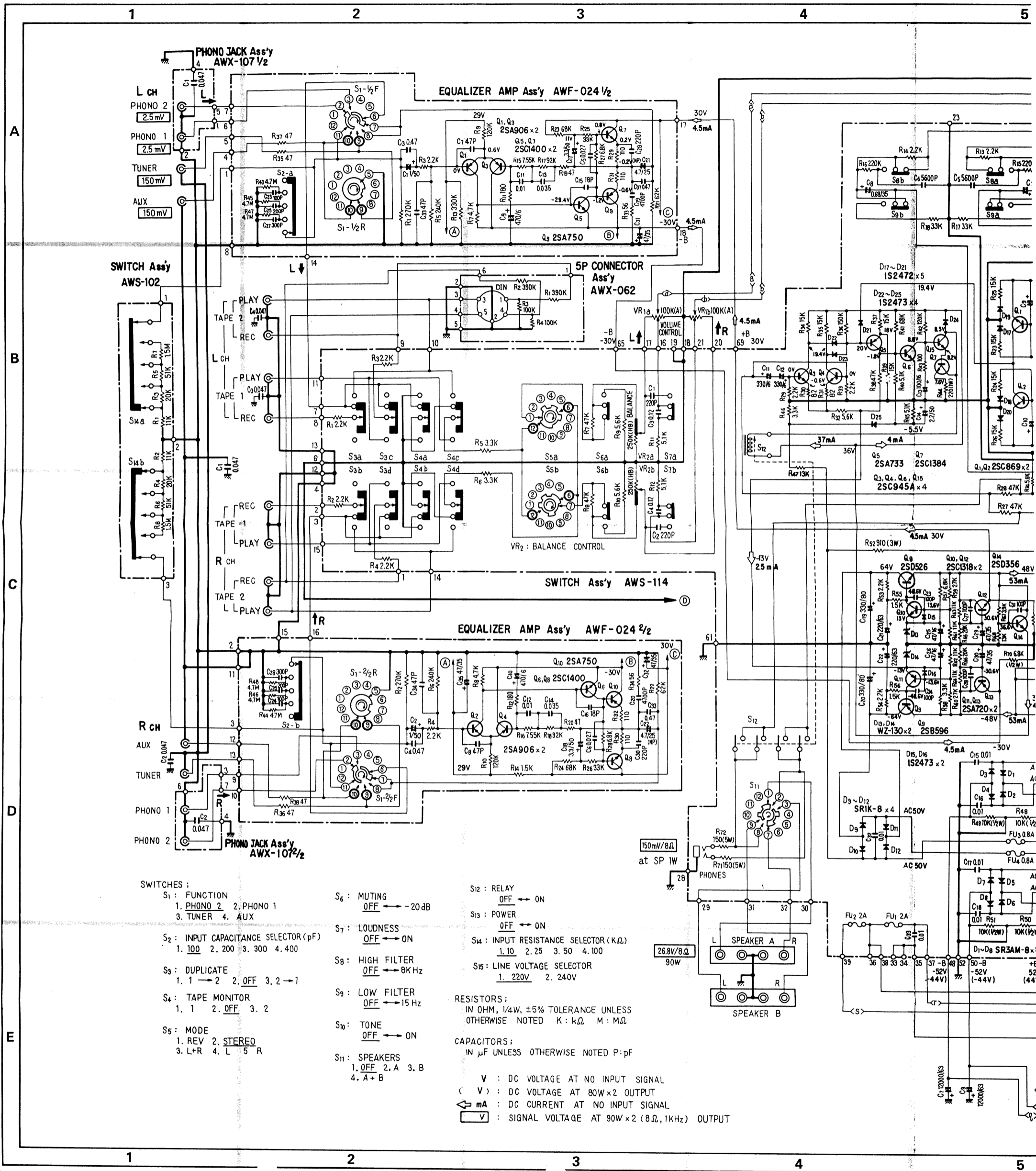

- SWITCHES :**
- S<sub>1</sub> : FUNCTION
    - 1. PHONO 2
    - 2. PHONO 1
    - 3. TUNER 4. AUX
  - S<sub>2</sub> : INPUT CAPACITANCE SELECTOR (pF)
    - 1. 100 2. 200 3. 300 4. 400
  - S<sub>3</sub> : DUPLICATE
    - 1. 1 → 2 2. OFF 3. 2 → 1
  - S<sub>4</sub> : TAPE MONITOR
    - 1. 1 2. OFF 3. 2
  - S<sub>5</sub> : MODE
    - 1. REV 2. STEREO
    - 3. L+R 4. L 5. R
  - S<sub>6</sub> : MUTING
    - OFF → -20dB
  - S<sub>7</sub> : LOUDNESS
    - OFF → ON
  - S<sub>8</sub> : HIGH FILTER
    - OFF → 8KHz
  - S<sub>9</sub> : LOW FILTER
    - OFF → 15Hz
  - S<sub>10</sub> : TONE
    - OFF → ON
  - S<sub>11</sub> : SPEAKERS
    - 1. OFF 2. A 3. B
    - 4. A + B

- S<sub>12</sub> : RELAY
  - OFF → ON
- S<sub>13</sub> : POWER
  - OFF → ON
- S<sub>14</sub> : INPUT RESISTANCE SELECTOR (K.Ω)
  - 1. 10 2. 25 3. 50 4. 100
- S<sub>15</sub> : LINE VOLTAGE SELECTOR
  - 1. 220V 2. 240V

**RESISTORS ;**  
 IN OHM, 1/4W, ±5% TOLERANCE UNLESS OTHERWISE NOTED K : kΩ M : MΩ

**CAPACITORS ;**  
 IN μF UNLESS OTHERWISE NOTED P : pF

V : DC VOLTAGE AT NO INPUT SIGNAL  
 ( V ) : DC VOLTAGE AT 80W×2 OUTPUT  
 mA : DC CURRENT AT NO INPUT SIGNAL  
 V : SIGNAL VOLTAGE AT 90W×2 (8Ω, 1KHz) OUTPUT

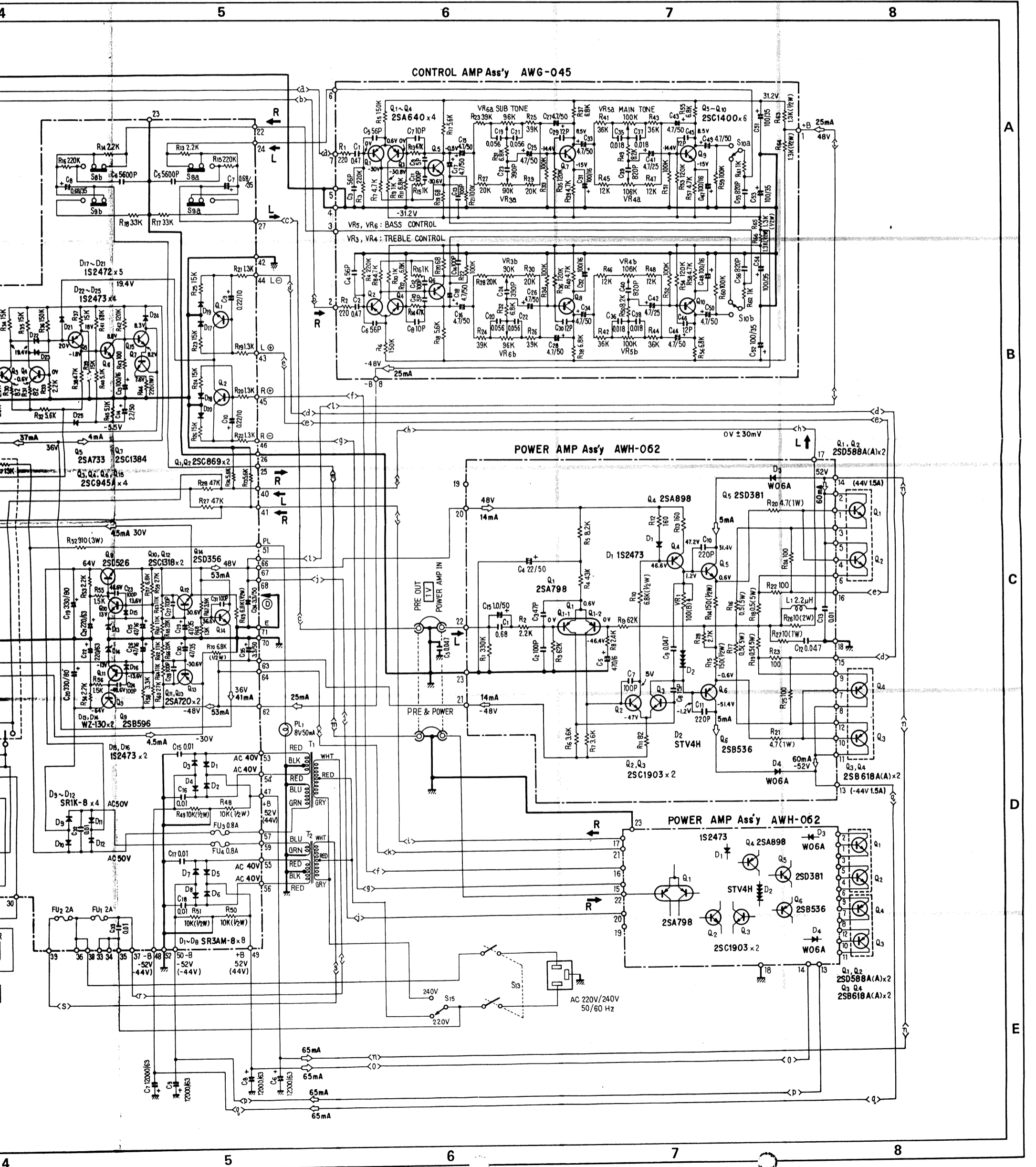

# SA-9500II

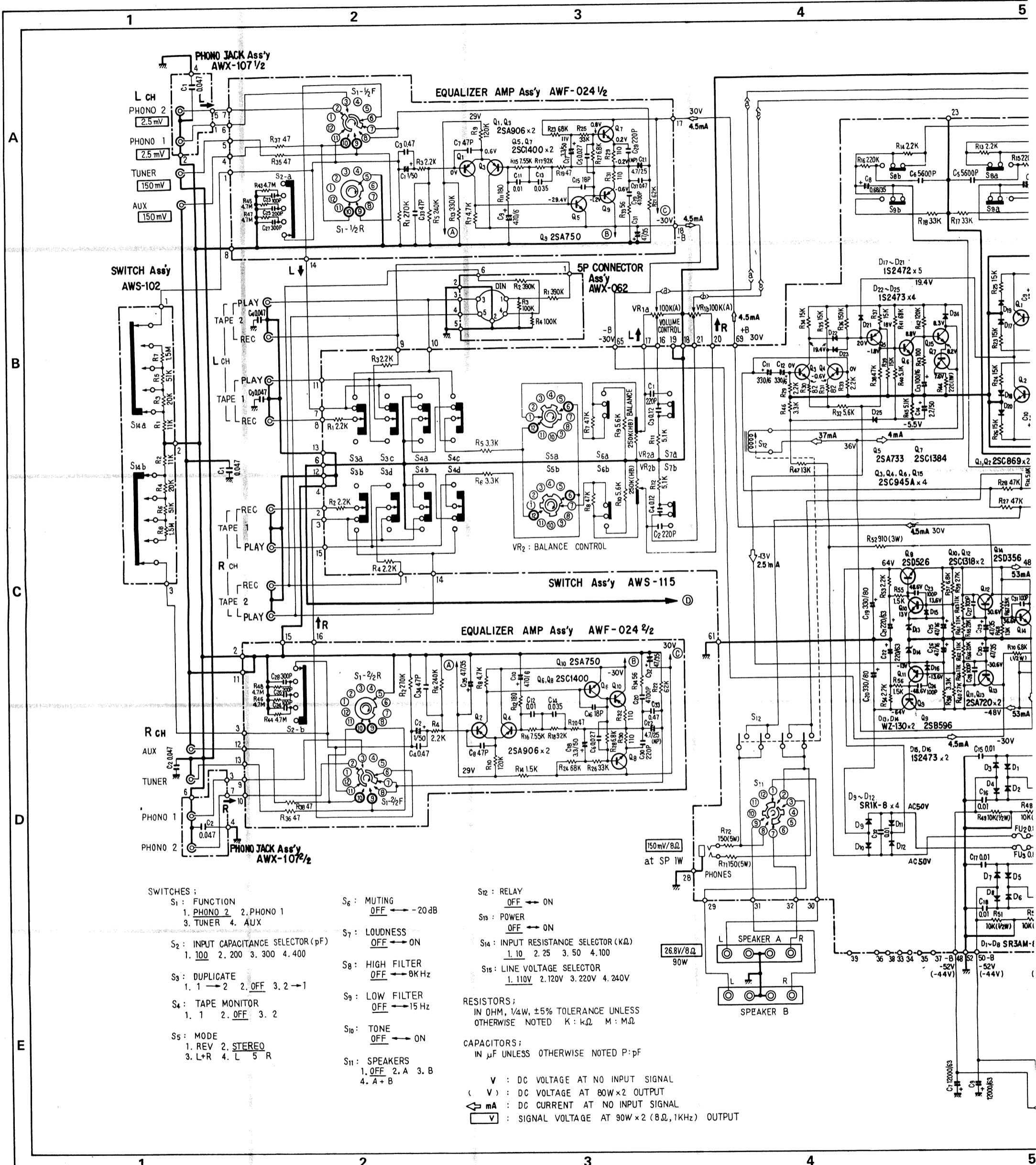

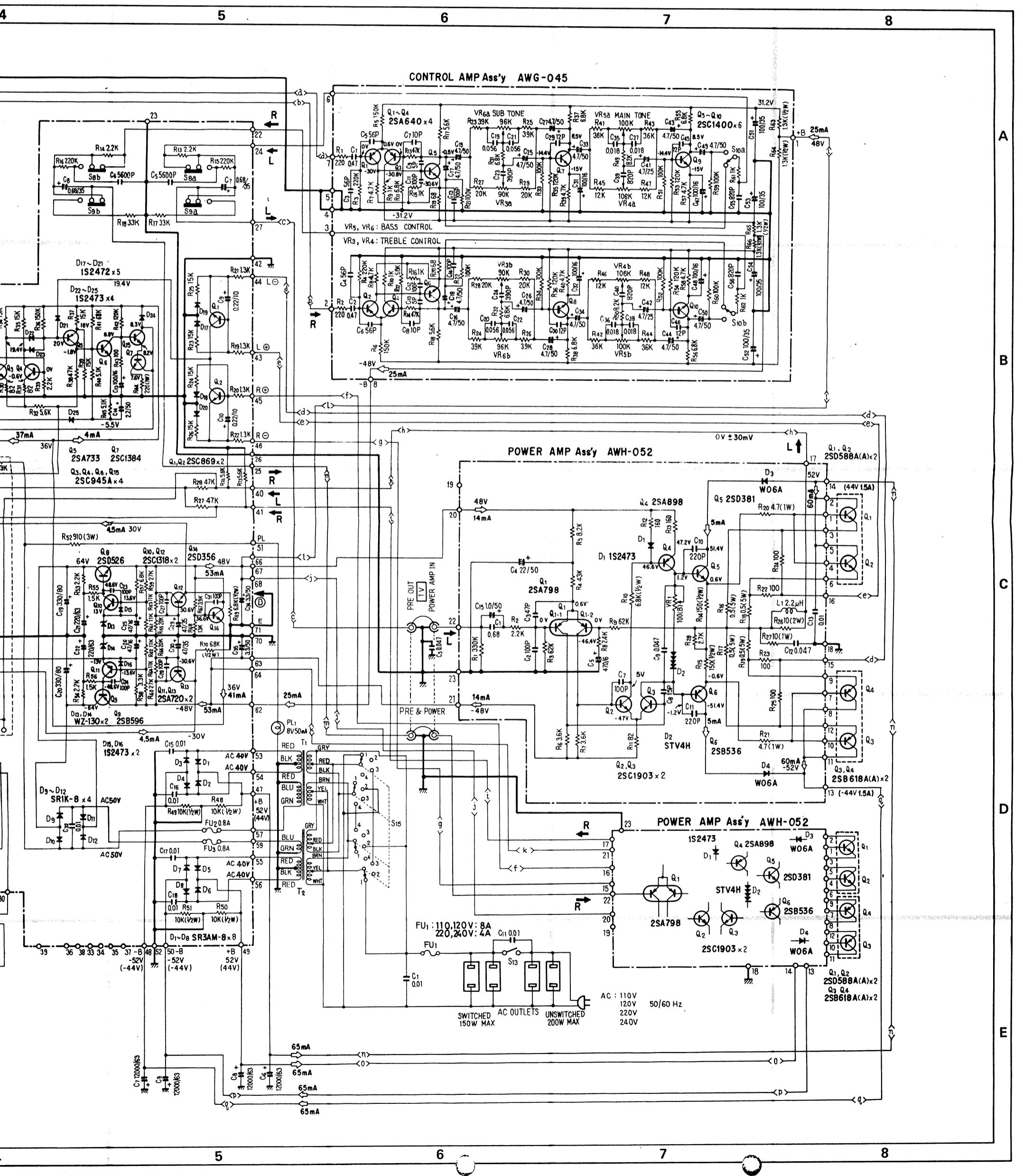



## Parts List of Power Amplifier (AWH-062, for HG-type)

### SEMICONDUCTORS

Symbol	Description	Part No.
Q1	Transistor	2SA798-G or F
Q2	Transistor	2SC1903-V or B (2SC1885-S or R)
Q3	Transistor	2SC1903-V or B (2SC1885-S or R)
Q4	Transistor	2SA898-V or B (2SA912-S or R)
Q5	Transistor	2SD381-L or M
Q6	Transistor	2SB536-L or M
D1	Diode	1S2473 (1S1555)
D2	Varistor	STV-4H
D3	Diode	W06A (1S1885)
D4	Diode	W06A (1S1885)

### CAPACITORS

Symbol	Description	Part No.
C1	Metallized mylar 0.68 100V	ACE-010
C2	Ceramic 100p 50V	CCDSL 101K 50
C3	Ceramic 47p 50V	CCDSL 470K 50
C4	Electrolytic 22 50V	CEA 220P 50
C5	Electrolytic 470 6V	CEA 471P 6
C7	Ceramic 100p 500V	CCDSL 101K 500
C8	Ceramic 15p 50V	CCDSL 150K 50
C9	Ceramic 0.047 50V	CKDYF 473Z 50
C10	Ceramic 220p 500V	CCDSL 221K 500
C11	Ceramic 220p 500V	CCDSL 221K 500
C12	Ceramic 0.047 150V	ACG-009
C13	Ceramic 0.01 150V	ACG-004
C15	Electrolytic 1 50V	CEANL 010P 50

### RESISTORS

Symbol	Description	Part No.
R1	Carbon film 330k	RD $\frac{1}{4}$ PS 334J
R2	Carbon film 2.2k	RD $\frac{1}{4}$ PS 222J
R3	Carbon film 62k	RD $\frac{1}{4}$ PS 623J
R4	Carbon film 43k	RD $\frac{1}{4}$ PS 433J
R5	Carbon film 8.2k	RD $\frac{1}{4}$ PS 822J
R6	Carbon film 3.6k	RD $\frac{1}{4}$ PS 362J
R7	Carbon film 3.6k	RD $\frac{1}{4}$ PS 362J
R8	Carbon film 2.4k	RD $\frac{1}{4}$ PS 242J
R9	Carbon film 62k	RD $\frac{1}{4}$ PS 623J
R10	Carbon film 6.8k $\frac{1}{2}W$	RD $\frac{1}{4}$ PS 682J
R11	Carbon film 82	RD $\frac{1}{4}$ PSF 820J
R12	Carbon film 160	RD $\frac{1}{4}$ PS 161J
R13	Carbon film 160	RD $\frac{1}{4}$ PS 161J
R14	Carbon film 150 $\frac{1}{2}W$	RD $\frac{1}{4}$ PSF 151J
R15	Carbon film 150 $\frac{1}{2}W$	RD $\frac{1}{4}$ PSF 151J
R16	Wire wound 0.5 5W	RT5B 0R5K
R17	Wire wound 0.5 5W	RT5B 0R5K
R18	Wire wound 0.5 5W	RT5B 0R5K
R19	Wire wound 0.5 5W	RT5B 0R5K
R20	Metal film 4.7 1W	RN1H 4R7K
R21	Metal film 4.7 1W	RN1H 4R7K
R22	Carbon film 100	RD $\frac{1}{4}$ PS 101J
R23	Carbon film 100	RD $\frac{1}{4}$ PS 101J
R24	Carbon film 100	RD $\frac{1}{4}$ PS 101J
R25	Carbon film 100	RD $\frac{1}{4}$ PS 101J
R26	Metal oxide 10 2W	RS2P 100J
R27	Metal oxide 10 1W	RS1P 100J
R28	Carbon film 2.7k	RD $\frac{1}{4}$ PS 272J
VR1	Semi-fixed 100-B	ACP-019

### OTHER

Symbol	Description	Part No.
L1	AF choke coil 2.2 $\mu$ H	T63-009

**PIONEER ELECTRONIC CORPORATION** 4-1, Meguro 1-Chome, Meguro-ku, Tokyo 153, Japan  
**U.S. PIONEER ELECTRONICS CORPORATION** 75 Oxford Drive, Moonachie, New Jersey 07074, U.S.A.  
**PIONEER ELECTRONIC (EUROPE) N.V.** Luithagen-Haven 9, 2030 Antwerp, Belgium  
**PIONEER ELECTRONICS AUSTRALIA PTY. LTD.** 178-184 Boundary Road, Braeside, Victoria 3195, Australia

<76L02Y0H01>

© DEC. 1976

Printed in Japan