

AM/FM STEREO RECEIVER SX-1500TD

ROUND LABEL UNIT	FVZW	FW	KLW			
TUNER UNIT						
FM FRONT END	AWB-001	W11-028	W11-028			
FM IF UNIT	W12-032	W12-032	W12-032			
MPX UNIT	W13-026	W13-026	W13-026			
AM TUNER UNIT	W14-008	W14-008	W14-008			
MUTING UNIT	W18-026	W18-026	W18-026			
HEAD AMP UNIT	W21-001	W21-001	W21-001			
CONTROL AMP UNIT	W15-079	W15-079	W15-079			
MAIN AMP UNIT	W23-002	W23-002	W23-002			
POWER SUPPLY UNIT	W16-026	W16-026	W16-026			
SWITCH UNIT	W15-081	W15-081	W15-081			
SWITCH UNIT	W15-082	W15-082	W15-082			
SWITCH UNIT						
TONE COLOR UNIT						
CONTROL UNIT	W15-080	W15-080	W15-080			
MIC AMP UNIT	W15-106	W15-106	W15-106			
REVERBE AMP UNIT						
REVERBE UNIT						
INDICATOR UNIT	W18-012	W18-012	W18-012			

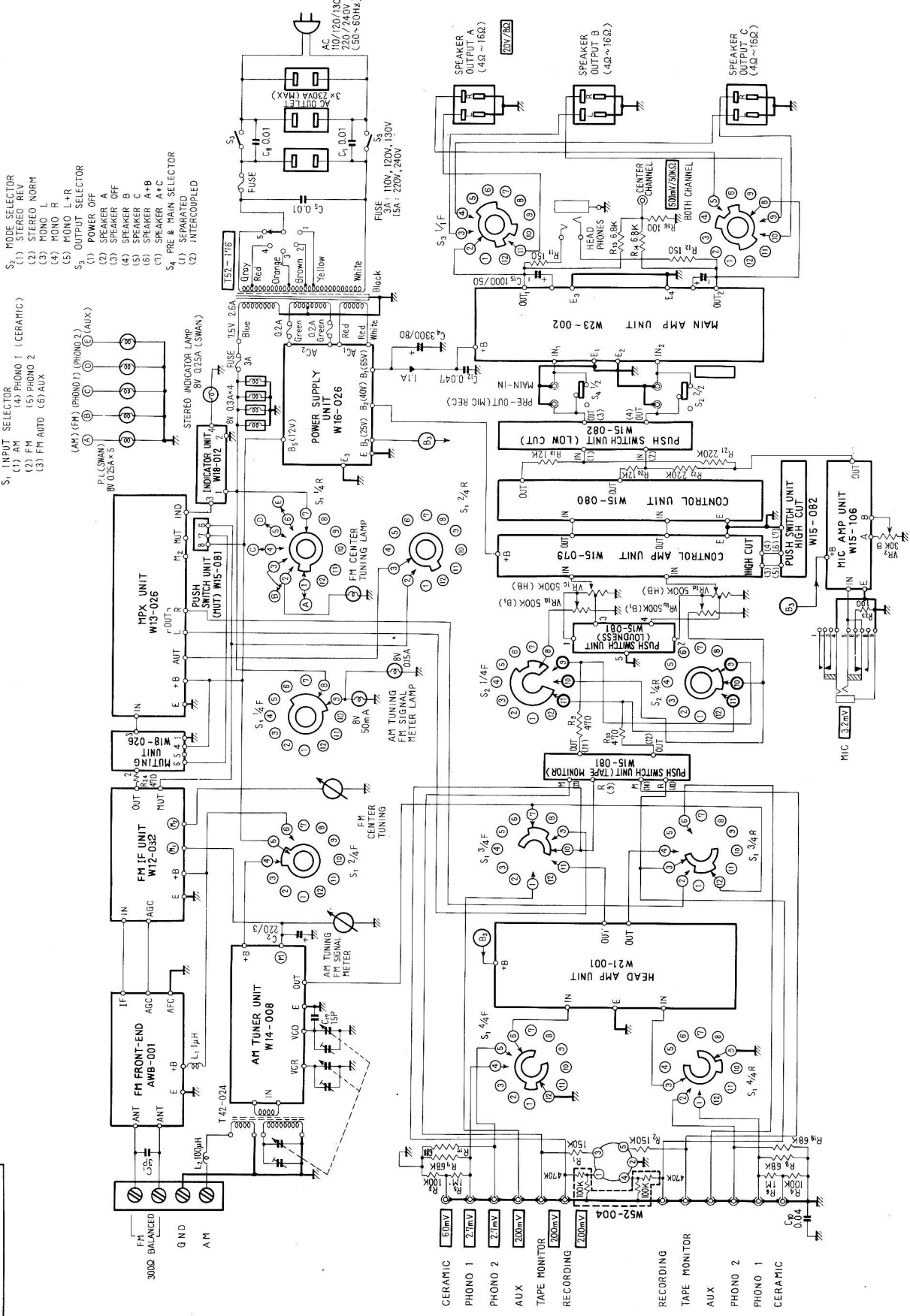



- S₁ INPUT SELECTOR**
 (1) AM
 (2) FM
 (3) FM AUTO (G) AUX
- S₂ MODE SELECTOR**
 (1) STEREO REV
 (2) STEREO NORM
 (3) MONO L
 (4) MONO R
 (5) MONO L+R
- S₃ OUTPUT SELECTOR**
 (1) POWER OFF
 (2) SPEAKER A
 (3) SPEAKER B
 (4) SPEAKER C
 (5) SPEAKER A+B
 (6) SPEAKER A+C
 (7) SPEAKER B+C
 (8) PRE-AMPLIFIED
 (9) INTERCOUPLED

- S₄ PRE-AMPLIFIED SELECTOR**
 (1) SEPARATED
 (2) INTERCOUPLED

- S₅ TUNING INDICATOR LAMP**
 (1) 8V 0.25A (SWAN)
 (2) 8V 0.25A (SWAN)
 (3) 8V 0.25A (SWAN)
 (4) 8V 0.25A (SWAN)
 (5) 8V 0.25A (SWAN)

- S₆ TUNING INDICATOR LAMP**
 (1) 8V 0.25A (SWAN)
 (2) 8V 0.25A (SWAN)
 (3) 8V 0.25A (SWAN)
 (4) 8V 0.25A (SWAN)
 (5) 8V 0.25A (SWAN)

- S₇ TUNING INDICATOR LAMP**
 (1) 8V 0.25A (SWAN)
 (2) 8V 0.25A (SWAN)
 (3) 8V 0.25A (SWAN)
 (4) 8V 0.25A (SWAN)
 (5) 8V 0.25A (SWAN)

- S₈ TUNING INDICATOR LAMP**
 (1) 8V 0.25A (SWAN)
 (2) 8V 0.25A (SWAN)
 (3) 8V 0.25A (SWAN)
 (4) 8V 0.25A (SWAN)
 (5) 8V 0.25A (SWAN)

- S₉ TUNING INDICATOR LAMP**
 (1) 8V 0.25A (SWAN)
 (2) 8V 0.25A (SWAN)
 (3) 8V 0.25A (SWAN)
 (4) 8V 0.25A (SWAN)
 (5) 8V 0.25A (SWAN)

- S₁₀ TUNING INDICATOR LAMP**
 (1) 8V 0.25A (SWAN)
 (2) 8V 0.25A (SWAN)
 (3) 8V 0.25A (SWAN)
 (4) 8V 0.25A (SWAN)
 (5) 8V 0.25A (SWAN)

- S₁₁ TUNING INDICATOR LAMP**
 (1) 8V 0.25A (SWAN)
 (2) 8V 0.25A (SWAN)
 (3) 8V 0.25A (SWAN)
 (4) 8V 0.25A (SWAN)
 (5) 8V 0.25A (SWAN)

- S₁₂ TUNING INDICATOR LAMP**
 (1) 8V 0.25A (SWAN)
 (2) 8V 0.25A (SWAN)
 (3) 8V 0.25A (SWAN)
 (4) 8V 0.25A (SWAN)
 (5) 8V 0.25A (SWAN)

- S₁₃ TUNING INDICATOR LAMP**
 (1) 8V 0.25A (SWAN)
 (2) 8V 0.25A (SWAN)
 (3) 8V 0.25A (SWAN)
 (4) 8V 0.25A (SWAN)
 (5) 8V 0.25A (SWAN)

- S₁₄ TUNING INDICATOR LAMP**
 (1) 8V 0.25A (SWAN)
 (2) 8V 0.25A (SWAN)
 (3) 8V 0.25A (SWAN)
 (4) 8V 0.25A (SWAN)
 (5) 8V 0.25A (SWAN)

- S₁₅ TUNING INDICATOR LAMP**
 (1) 8V 0.25A (SWAN)
 (2) 8V 0.25A (SWAN)
 (3) 8V 0.25A (SWAN)
 (4) 8V 0.25A (SWAN)
 (5) 8V 0.25A (SWAN)

- S₁₆ TUNING INDICATOR LAMP**
 (1) 8V 0.25A (SWAN)
 (2) 8V 0.25A (SWAN)
 (3) 8V 0.25A (SWAN)
 (4) 8V 0.25A (SWAN)
 (5) 8V 0.25A (SWAN)

- S₁₇ TUNING INDICATOR LAMP**
 (1) 8V 0.25A (SWAN)
 (2) 8V 0.25A (SWAN)
 (3) 8V 0.25A (SWAN)
 (4) 8V 0.25A (SWAN)
 (5) 8V 0.25A (SWAN)

- S₁₈ TUNING INDICATOR LAMP**
 (1) 8V 0.25A (SWAN)
 (2) 8V 0.25A (SWAN)
 (3) 8V 0.25A (SWAN)
 (4) 8V 0.25A (SWAN)
 (5) 8V 0.25A (SWAN)

- S₁₉ TUNING INDICATOR LAMP**
 (1) 8V 0.25A (SWAN)
 (2) 8V 0.25A (SWAN)
 (3) 8V 0.25A (SWAN)
 (4) 8V 0.25A (SWAN)
 (5) 8V 0.25A (SWAN)

- S₂₀ TUNING INDICATOR LAMP**
 (1) 8V 0.25A (SWAN)
 (2) 8V 0.25A (SWAN)
 (3) 8V 0.25A (SWAN)
 (4) 8V 0.25A (SWAN)
 (5) 8V 0.25A (SWAN)

- S₂₁ TUNING INDICATOR LAMP**
 (1) 8V 0.25A (SWAN)
 (2) 8V 0.25A (SWAN)
 (3) 8V 0.25A (SWAN)
 (4) 8V 0.25A (SWAN)
 (5) 8V 0.25A (SWAN)

- INPUT SELECTOR**
 CERAMIC
 PHONO 1
 PHONO 2
 AUX
 TAPE MONITOR
 RECORDING
- OUTPUT SELECTOR**
 RECORDING
 TAPE MONITOR
 AUX
 PHONO 2
 PHONO 1
 CERAMIC

SX-1500TD for KLV model

SX-1500TD

- S₇ MODE SELECTOR (S14-035)
 (1) STEREO REV
 (2) STEREO NORM
 (3) MONO L
 (4) MONO R
 (5) MONO L+R
 (6) MONO R+L
- S₈ OUTPUT SELECTOR (S11-031)
 (1) POWER OFF
 (2) SPEAKER A
 (3) SPEAKER OFF
 (4) SPEAKER B
 (5) SPEAKER C
 (6) SPEAKER A+B
 (7) SPEAKER A+C
 (8) PRE. & MAIN SELECTOR (S41-022)
 (1) SEPARATED
 (2) INTERCOUPLED

- S₁ INPUT SELECTOR (S19-028)
 (1) AM
 (2) FM
 (3) FM AUTO
 (4) PHONO 1 (CERAMIC)
 (5) PHONO 2
 (6) AUX
- (AM) (FM) (PHONO1) (PHONO 2)
 (A) (B) (C) (D) (E) (AUX)

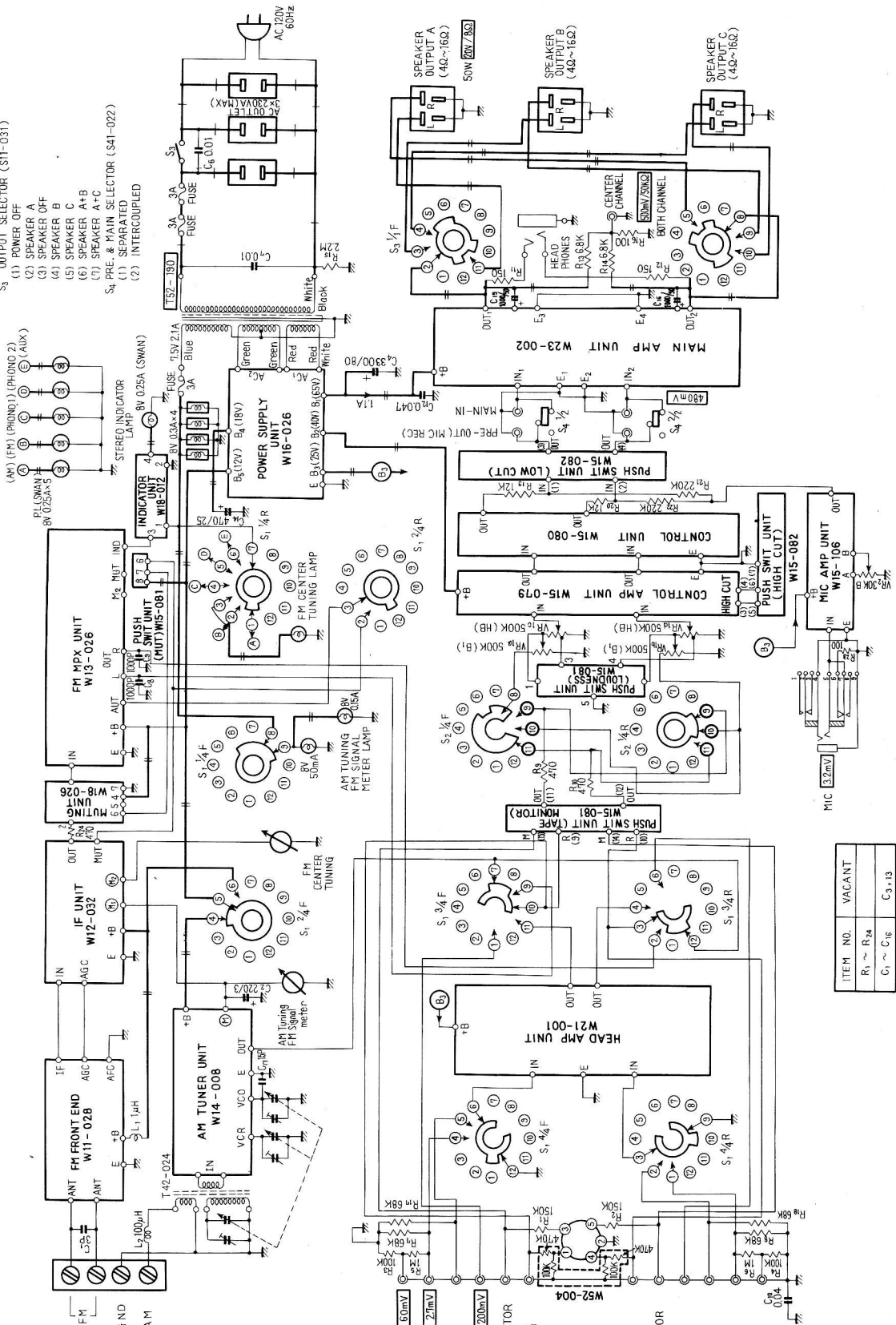

ITEM NO.	VACANT
R ₁ ~ R ₂₄	
C ₁ ~ C ₁₆	C ₃ + 13

- CERAMIC 50mV
 PHONO 1 20mV
 PHONO 2 20mV
 AUX 200mV
 TAPE MONITOR
 RECORDING
 RECORDING
 TAPE MONITOR
 AUX
 PHONO 2
 PHONO 1
 CERAMIC

- S₁ INPUT SELECTOR**
 (1) AM (2) FM (3) PHONO 1 (CERAMIC)
 (4) FM (5) PHONO 2
 (6) FM AUTO (67) AUX
- S₂ MODE SELECTOR**
 (1) STEREO REV
 (2) STEREO NORM
 (3) MONO L
 (4) MONO R
 (5) MONO L+R
- S₃ OUTPUT SELECTOR**
 (1) POWER OFF
 (2) SPEAKER A
 (3) SPEAKER OFF
 (4) SPEAKER B
 (5) SPEAKER C
 (6) SPEAKER A+B
 (7) SPEAKER A+C
 (8) PRE & MAIN SELECTOR
- S₄ PRE & MAIN SELECTOR**
 (1) SEPARATED
 (2) INTERCOUPLED

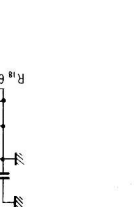
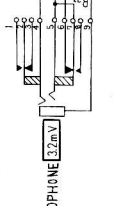
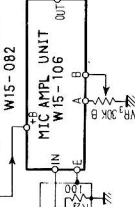
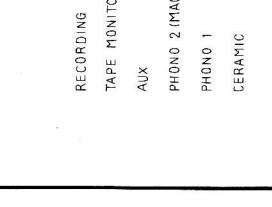
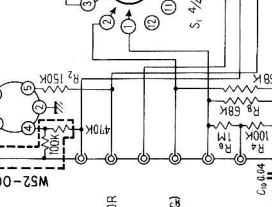
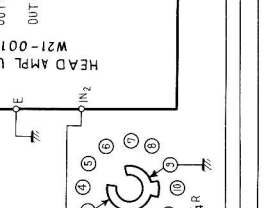
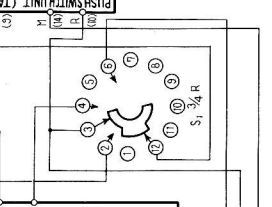
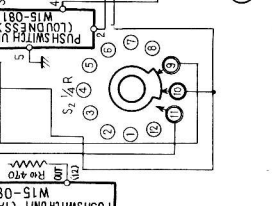
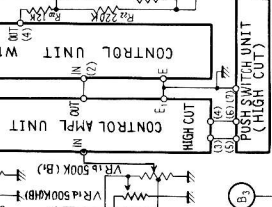
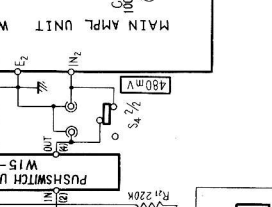
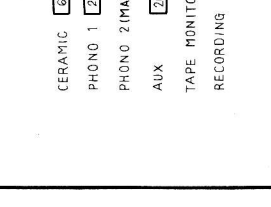
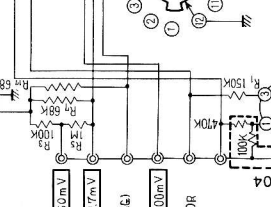
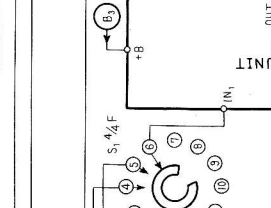
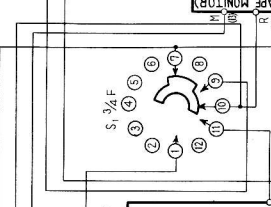
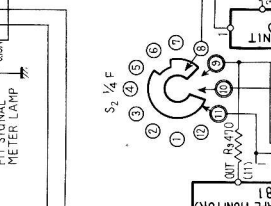
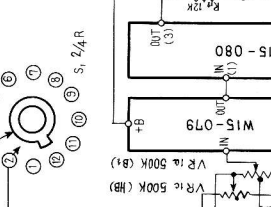
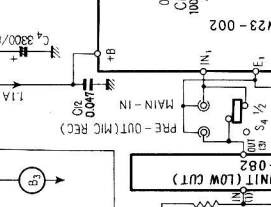
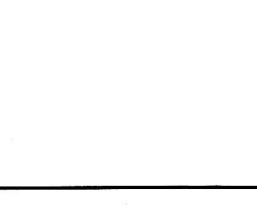
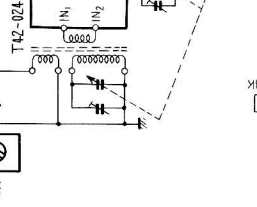
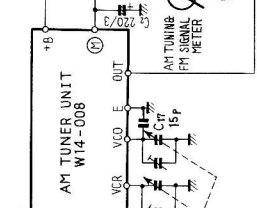
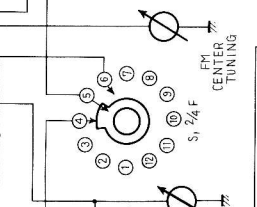
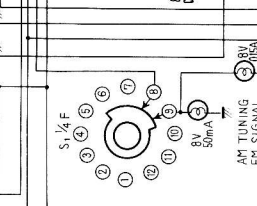
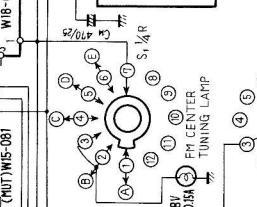
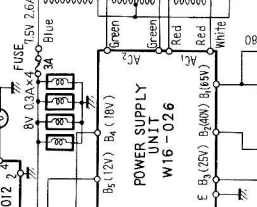
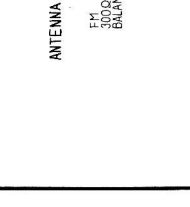
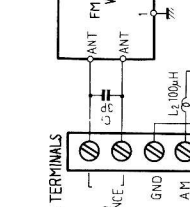
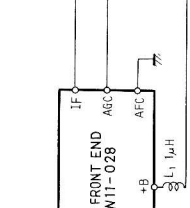
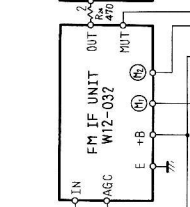
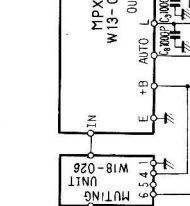
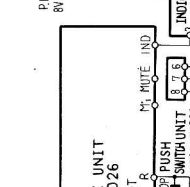
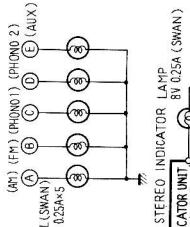

- ANTENNA TERMINALS**
 FM 300Ω BALANCE
 GND
 AM
- CERAMIC** 60mV
PHONO 1 27mV
PHONO 2 (IMAG)
AUX 200mV
TAPE MONITOR
RECORDING
RECORDING
TAPE MONITOR
AUX
PHONO 2 (IMAG)
PHONO 1
CERAMIC

FM FRONT END

FM FRONT END

AWB-001

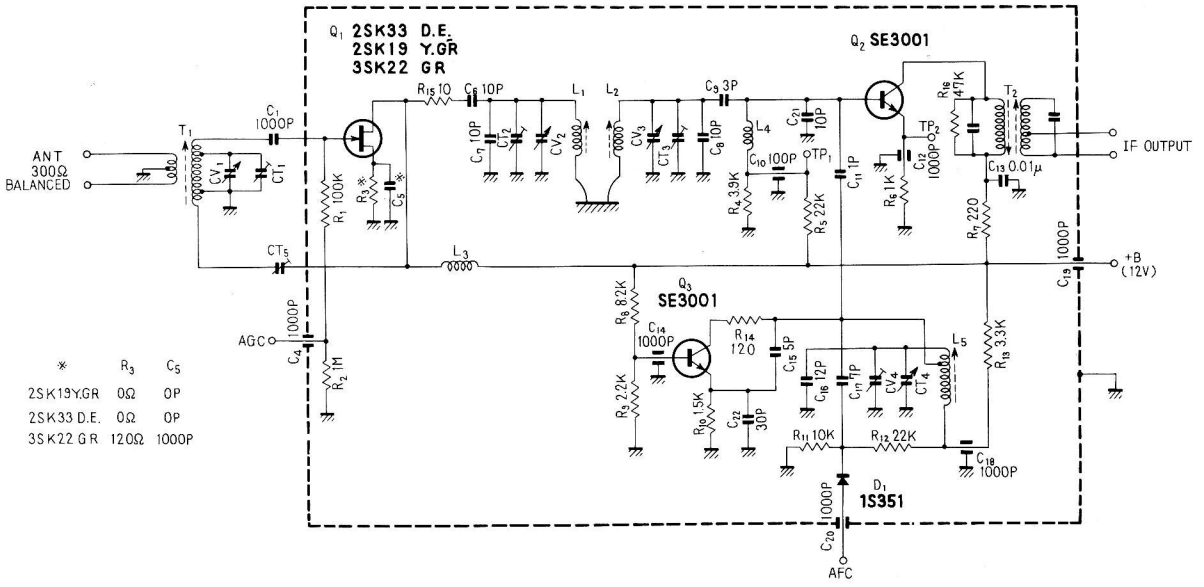

*	R ₃	C ₅
2SK19Y.GR	0Ω	0P
2SK33 D.E.	0Ω	0P
3SK22 G.R	120Ω	1000P

FM FRONT END for FW KLV model

FM FRONT END

W11-028

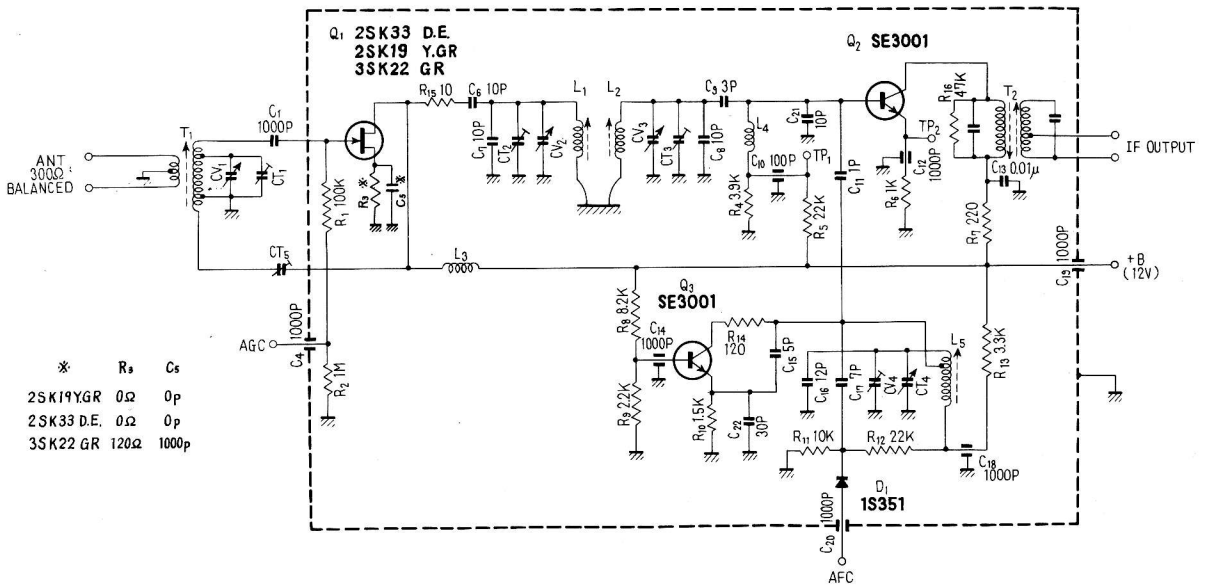

*	R ₃	C ₅
2SK19Y.GR	0Ω	0p
2SK33 D.E.	0Ω	0p
3SK22 GR	120Ω	1000p

FM IF UNIT

FM IF UNIT

W12-032

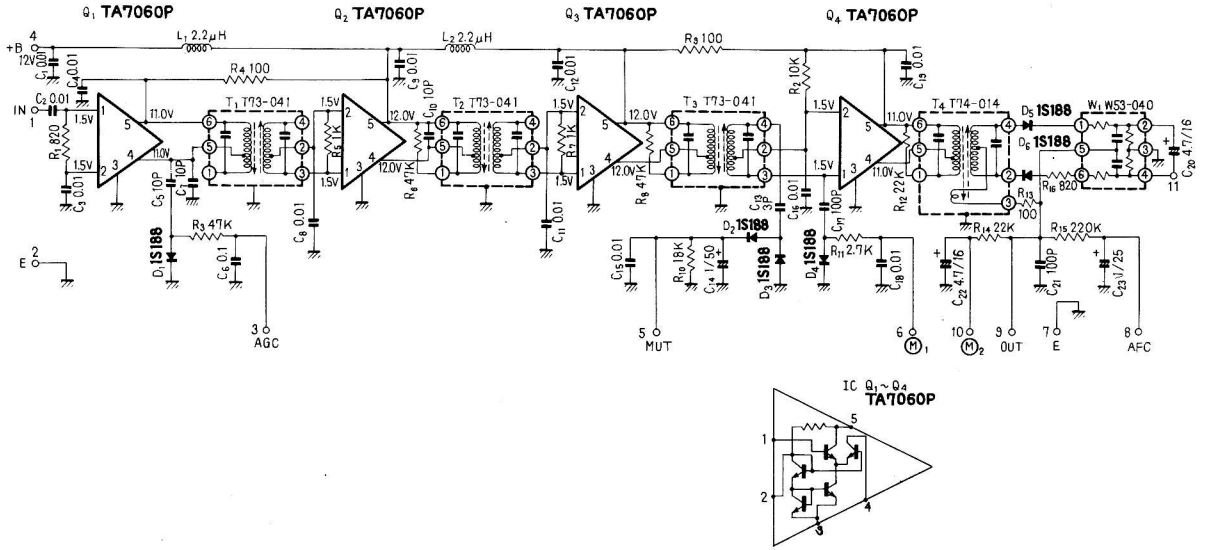

MPX UNIT

MPX UNIT

W13-026

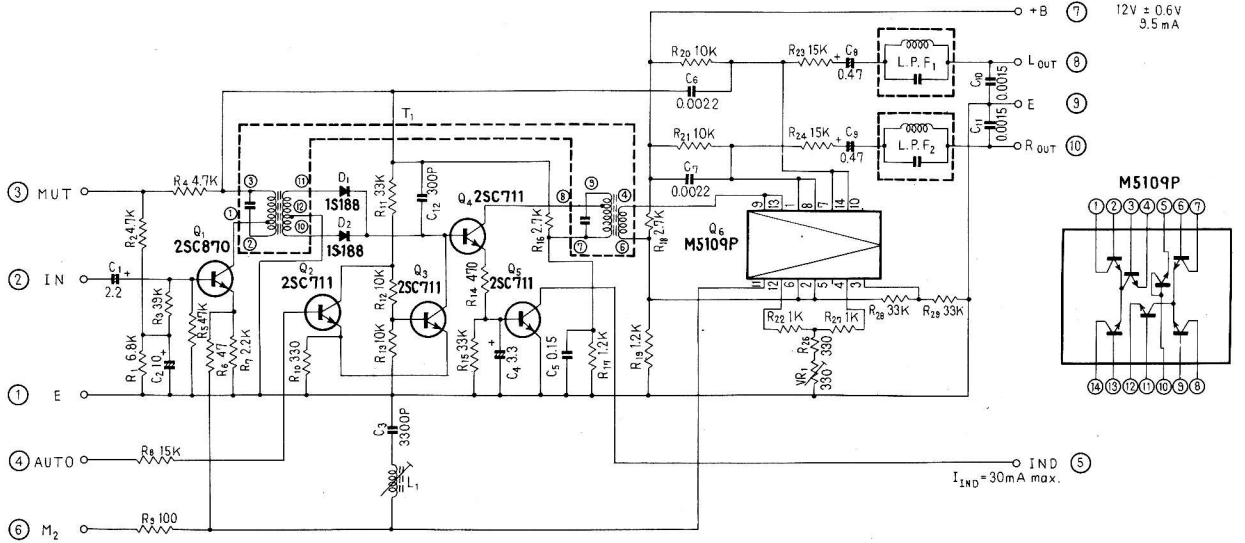

AM TUNER UNIT

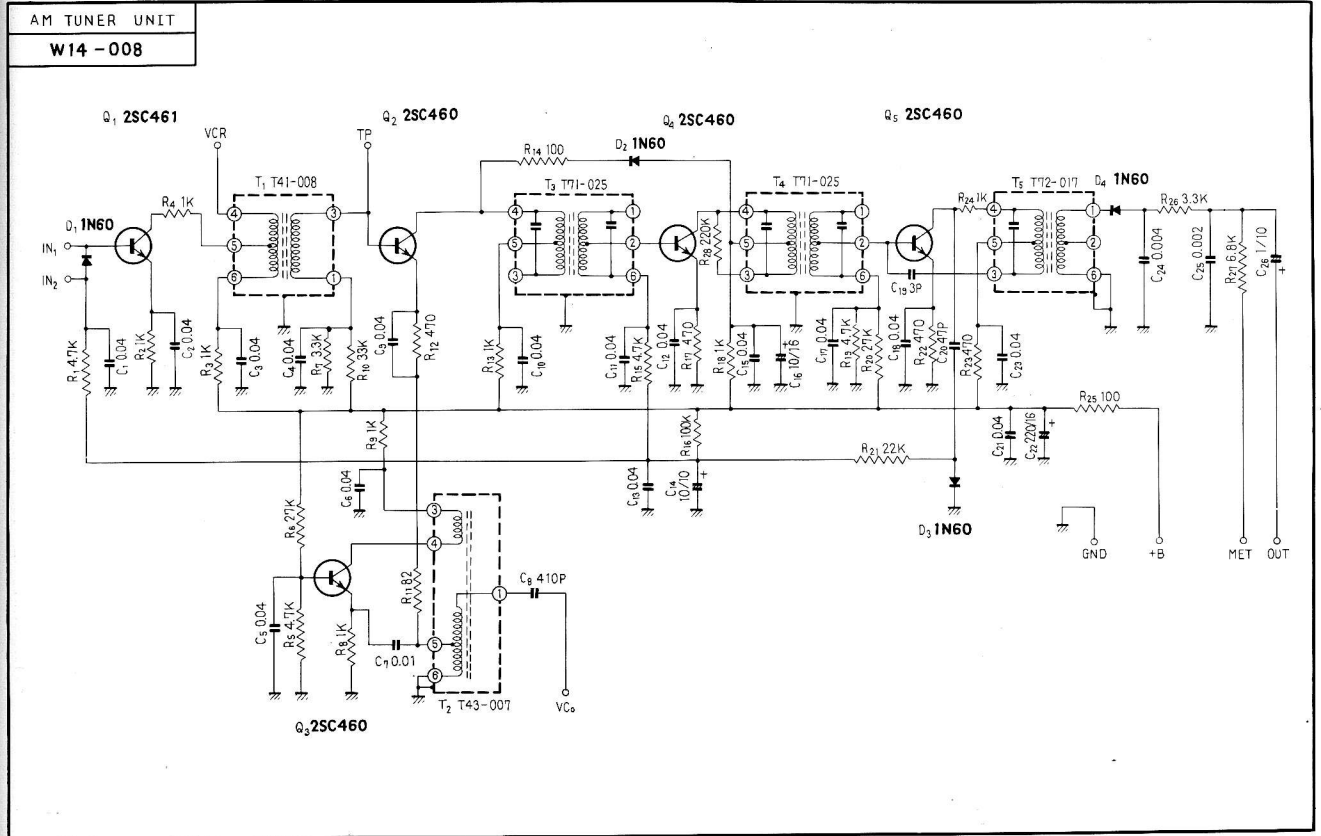

MUTING UNIT

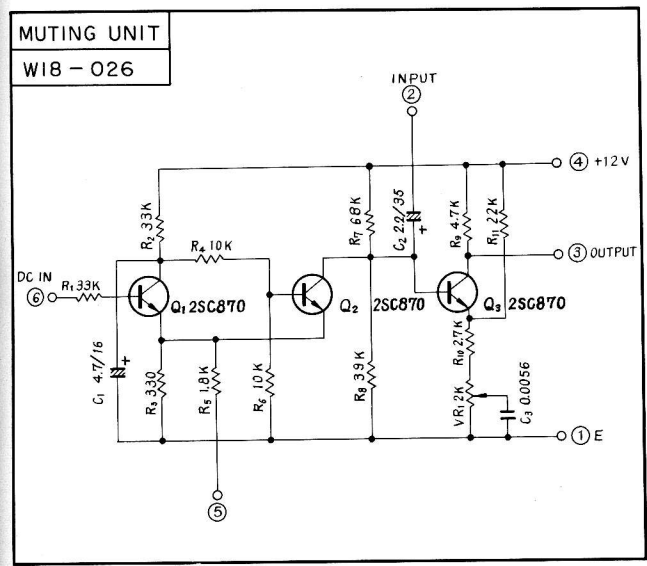

HEAD AMP UNIT

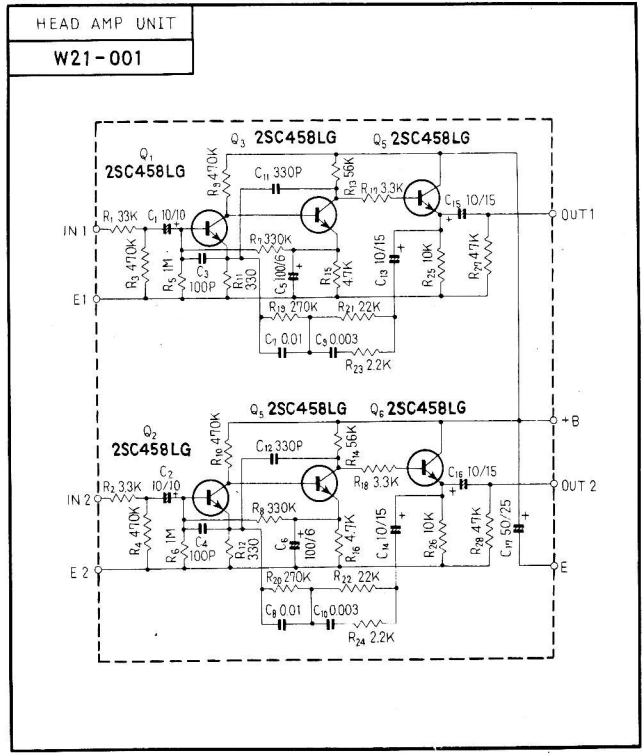

CONTROL AMP UNIT

POWER SUPPLY UNIT

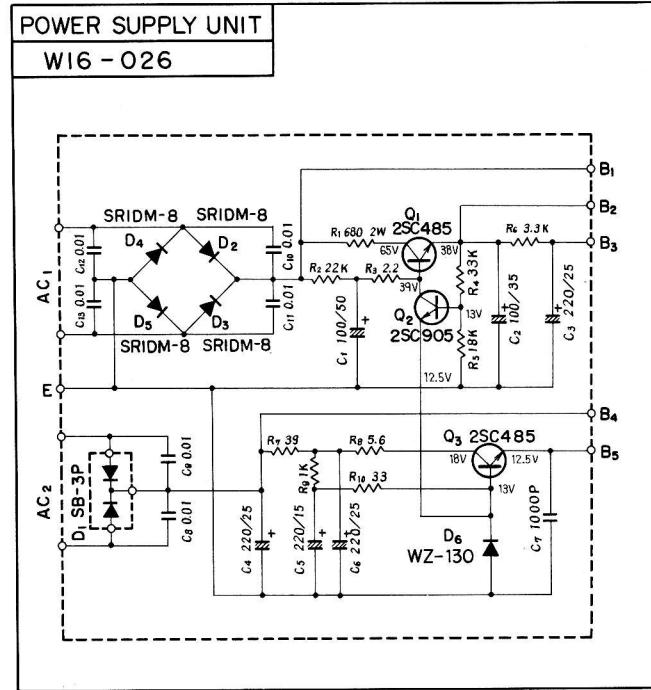
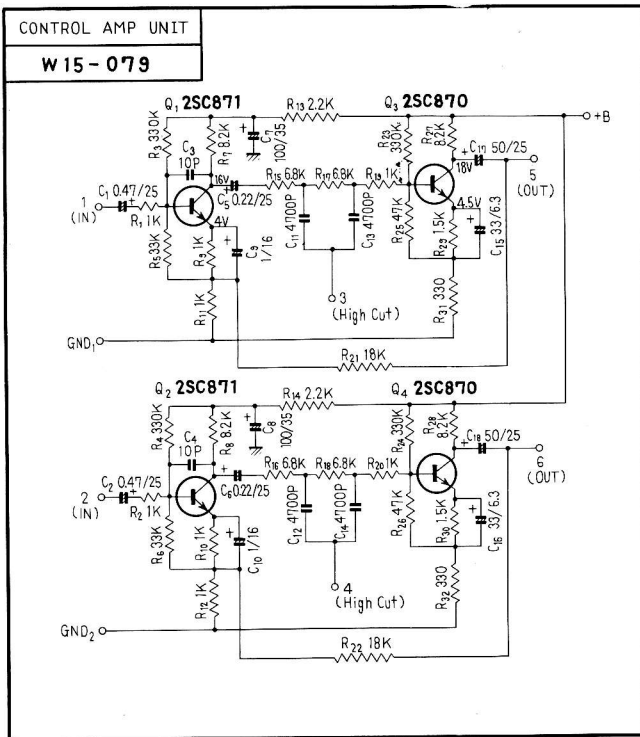

MAIN AMP UNIT

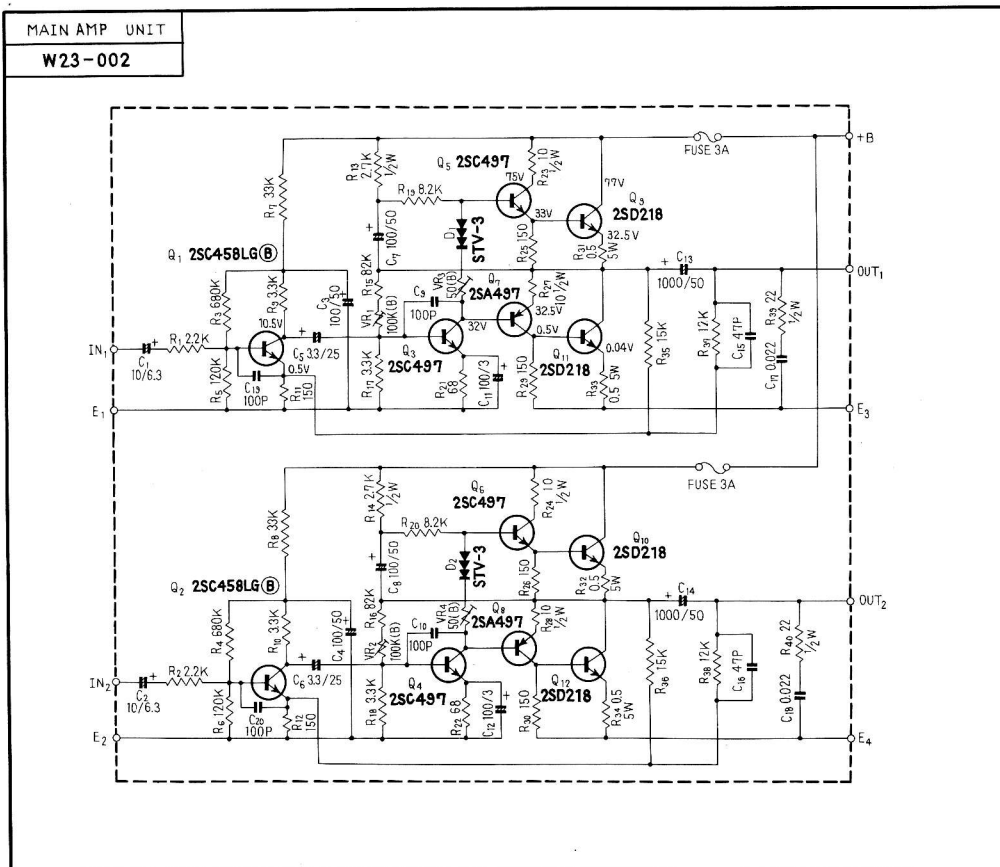

PUSH SWITCH UNIT

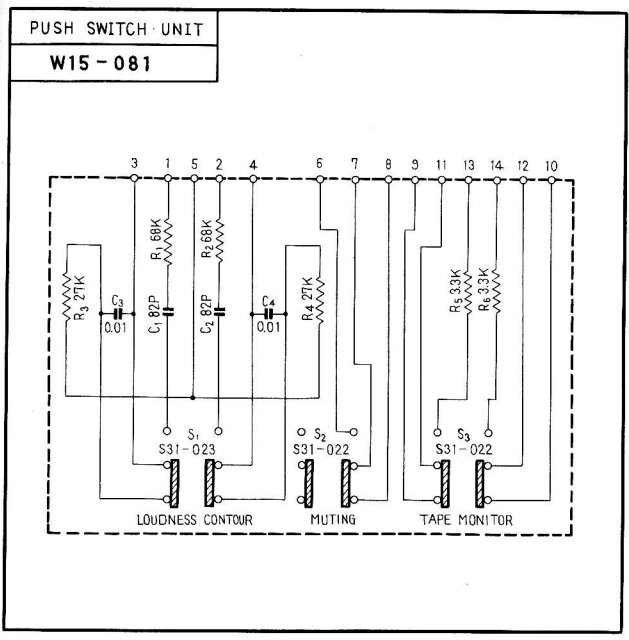

PUSH SWITCH UNIT

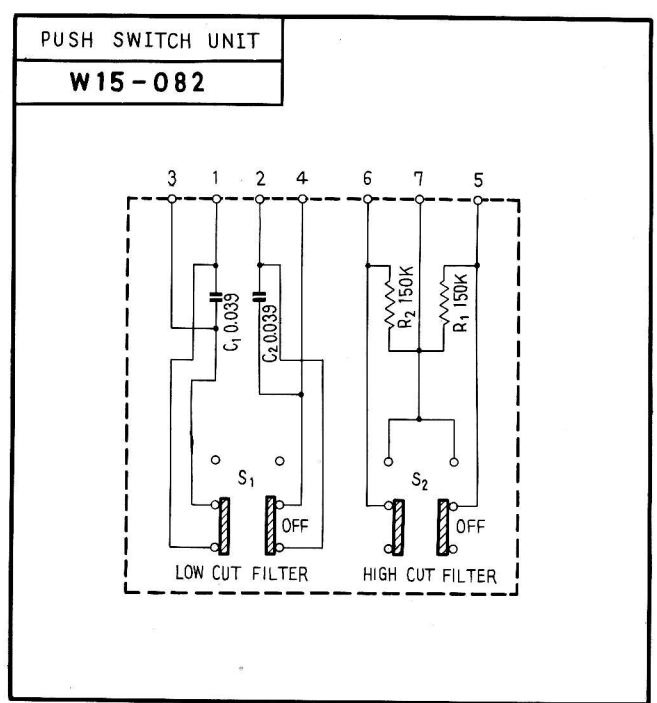

CONTROL UNIT

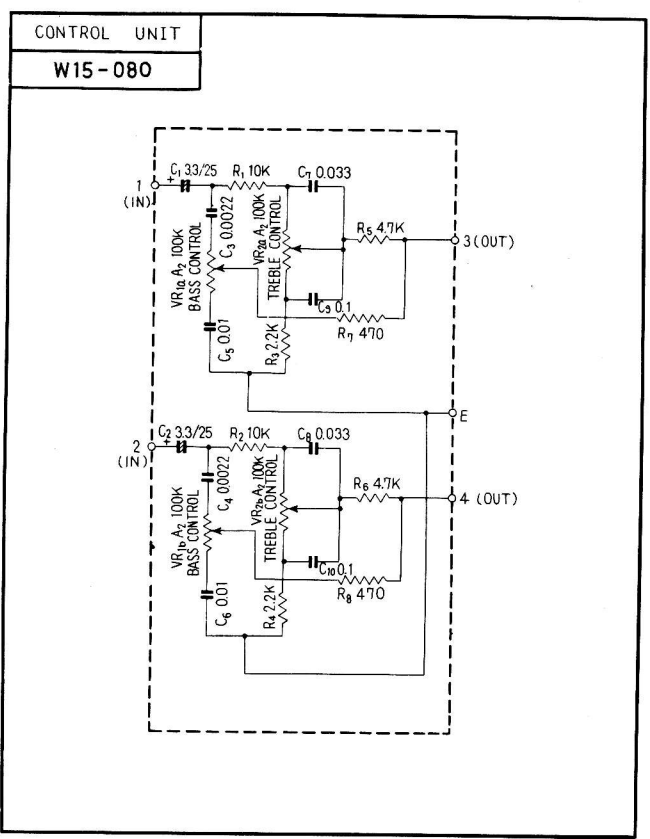

INDICATOR UNIT

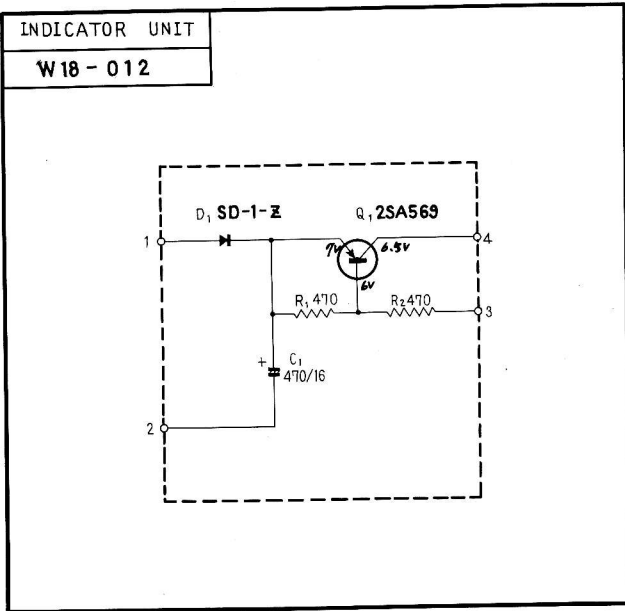

MIC AMP UNIT

