

AM/FM STEREO RECEIVER

# SX-450

## SERVICE MANUAL



 PIONEER®

# AM/FM STEREO RECEIVER

# SX-450

HG

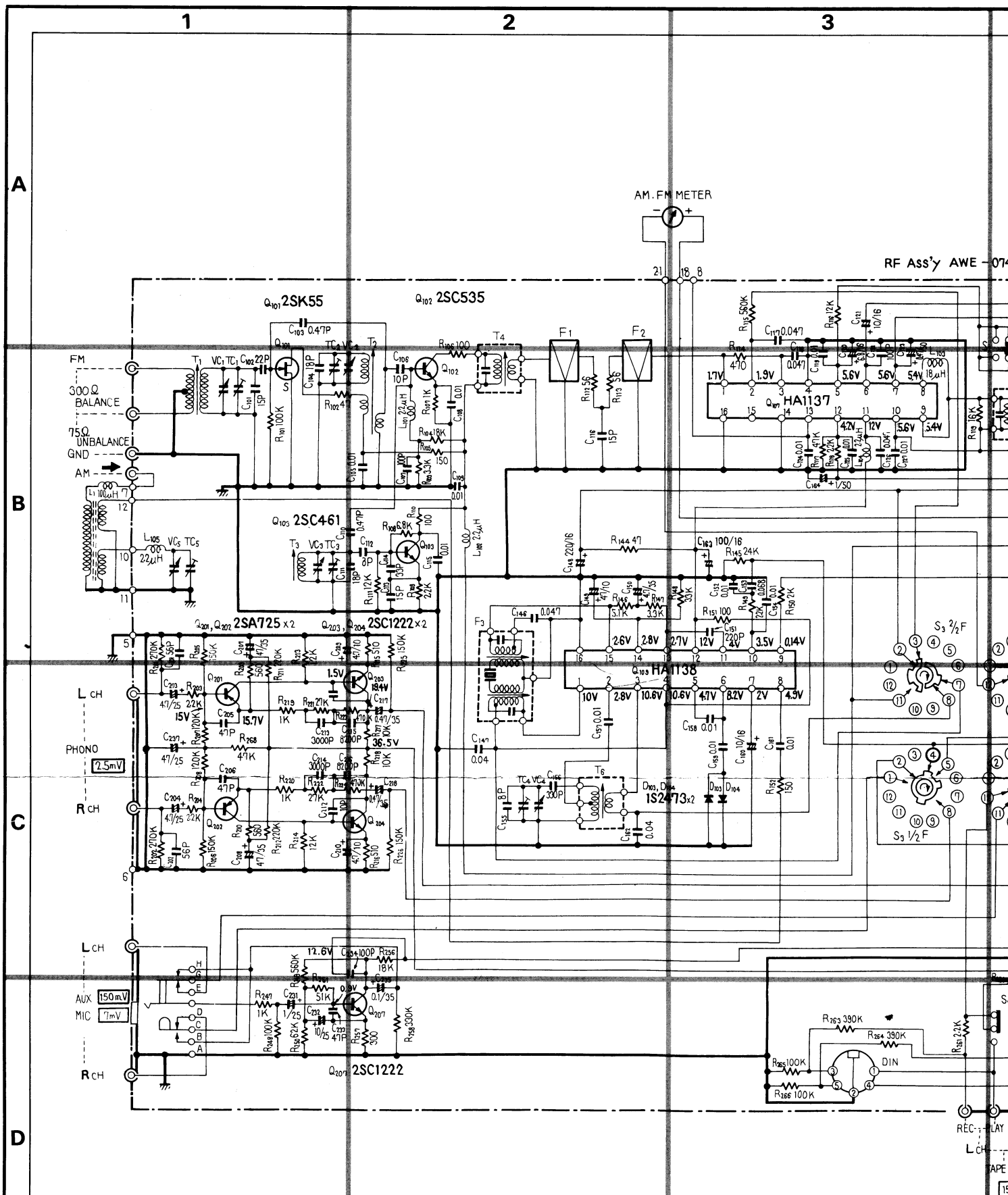

### SWITCHES:

- S<sub>1</sub> SPEAKERS
- 1 POWER OFF
- 2 SP A
- 3 SP OFF
- 4 SP B
- 5 SP A + B

- S<sub>5</sub> MODE
- STEREO ← MONO
- S<sub>6</sub> LOUDNESS
- OFF → ON
- S<sub>7</sub> AC VOLTAGE SELECTOR

3

4

5

6

RF Ass'y AWE-074

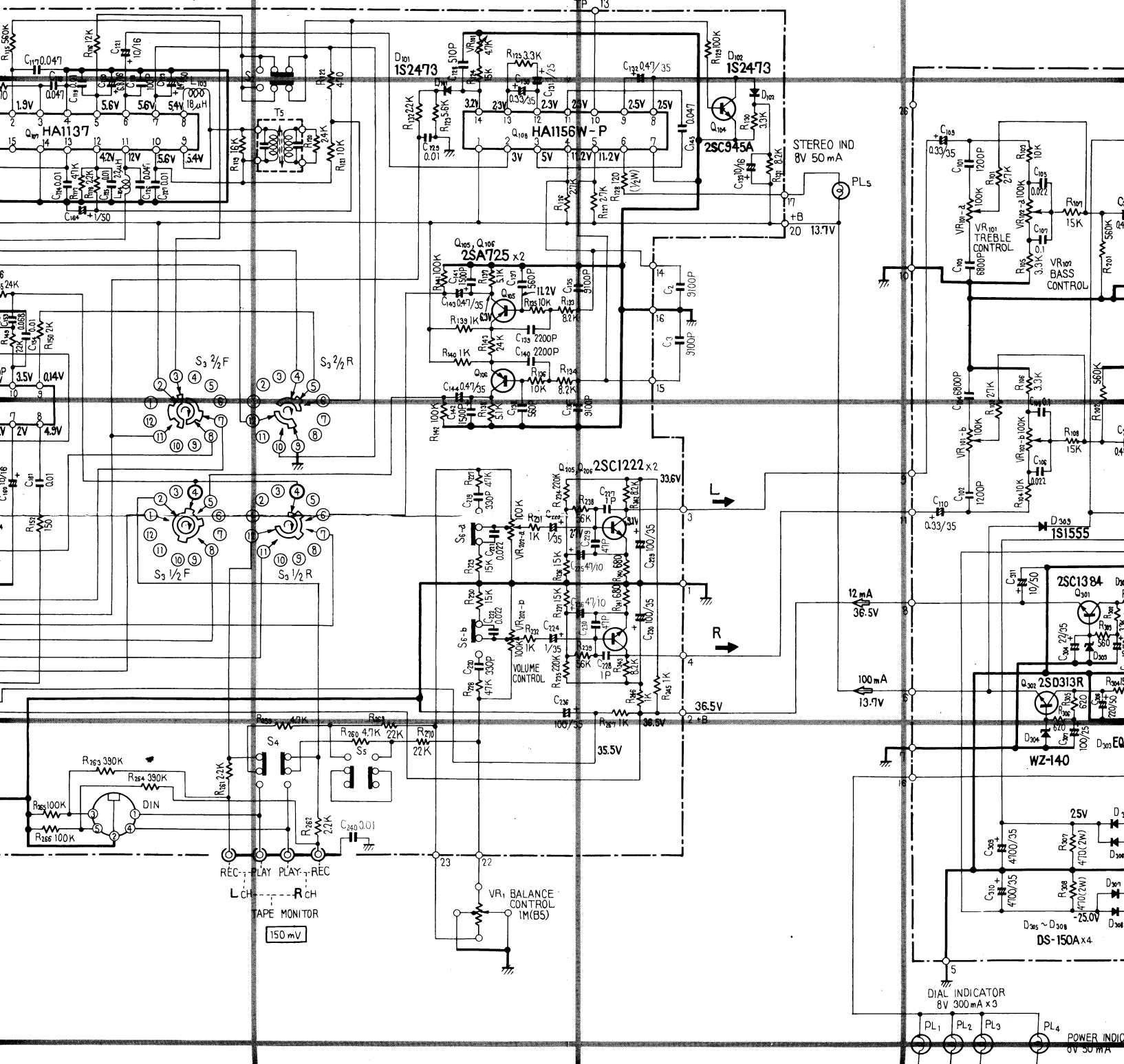

REC - PLAY - REC  
 L CH - R CH  
 TAPE MONITOR  
 150 mV

STEREO IND  
 8V 50 mA  
 PL5

DIAL INDICATOR  
 8V 300 mA x3  
 PL1 PL2 PL3 PL4  
 POWER INDICATOR  
 8V 50 mA

WZ-140

DS-150A x4



6

7

8

A

B

C

D

AF Ass'y AWK-069

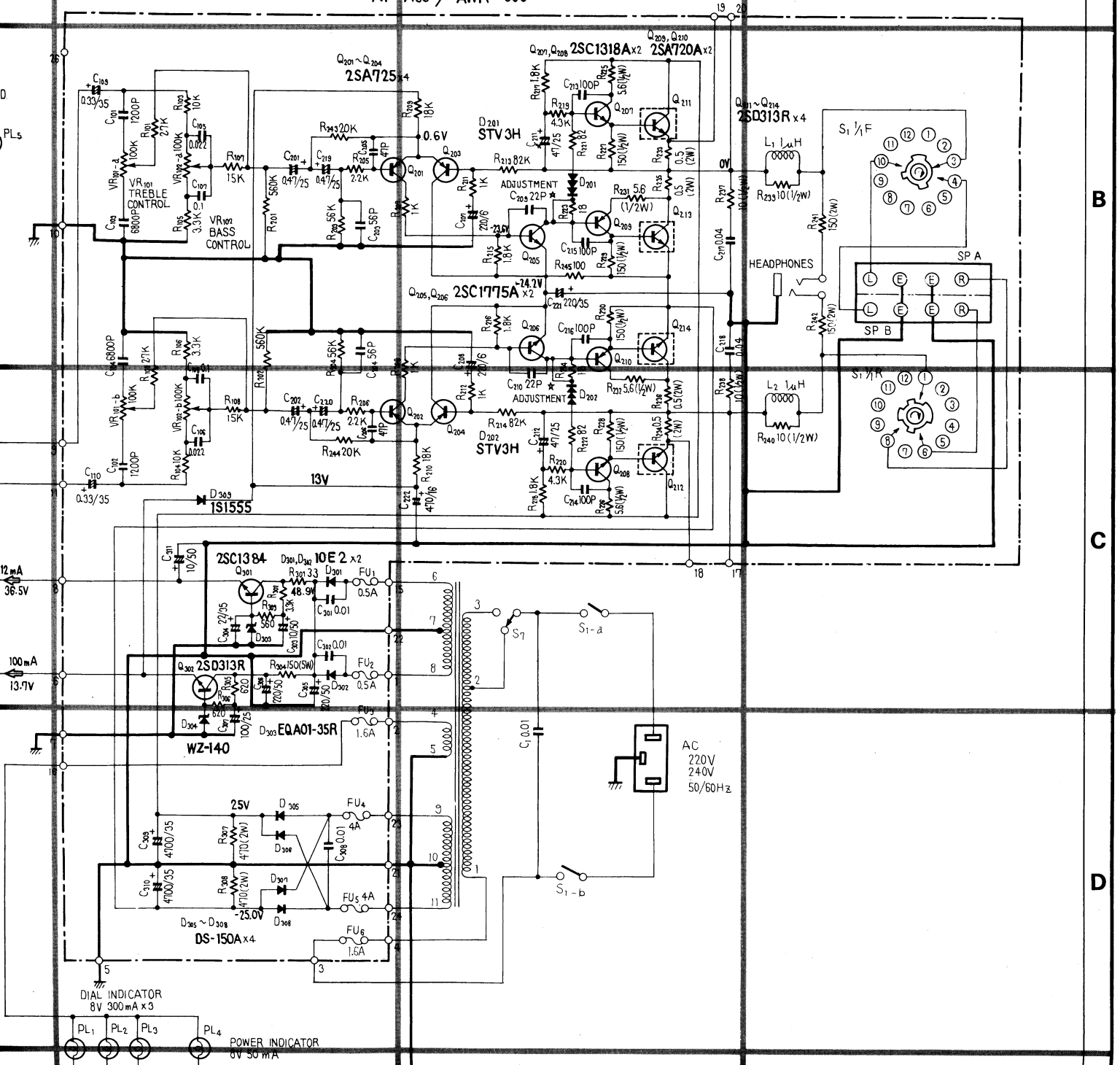

AF Ass'y AWK-069

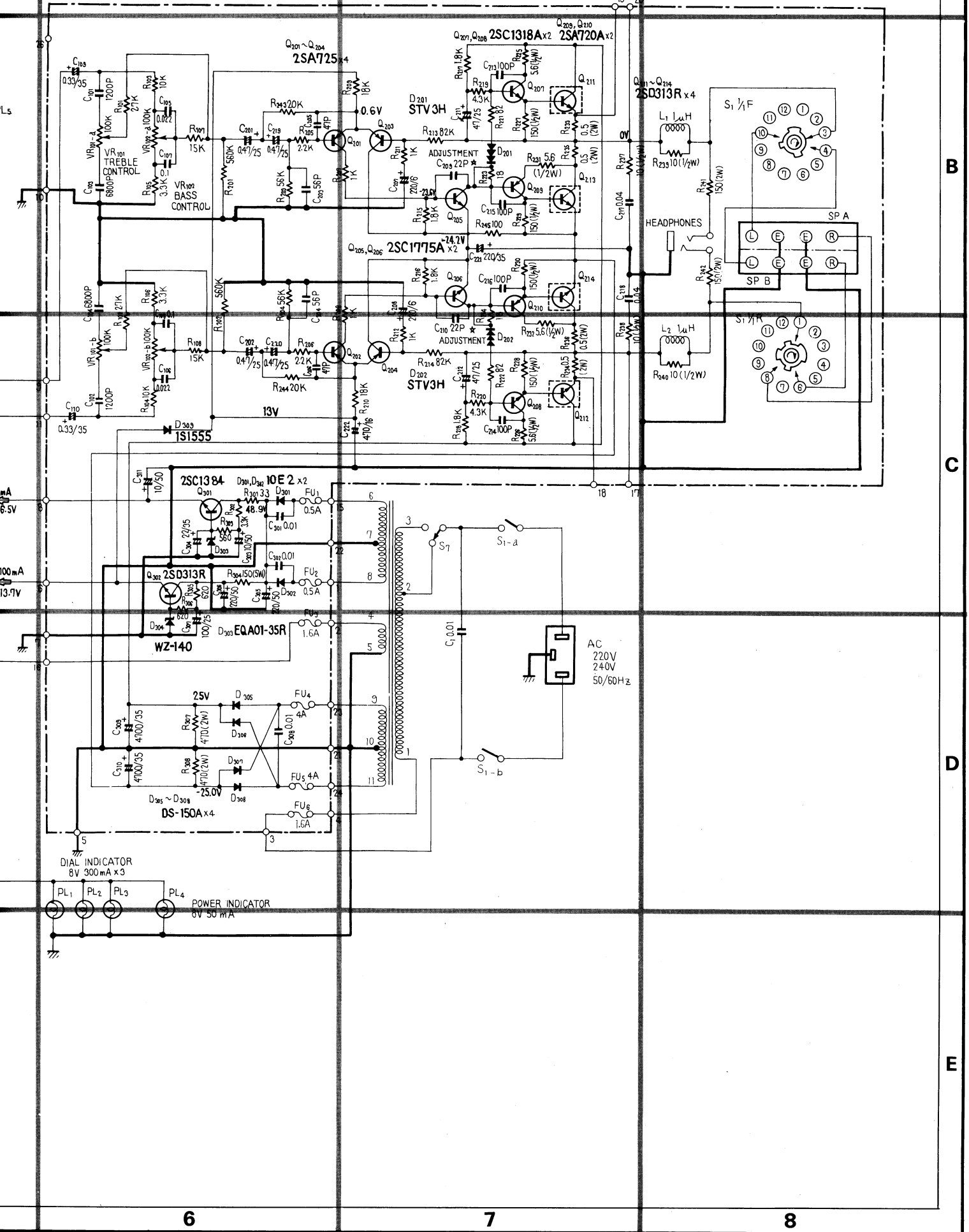

B

C

D

E

6

7

8

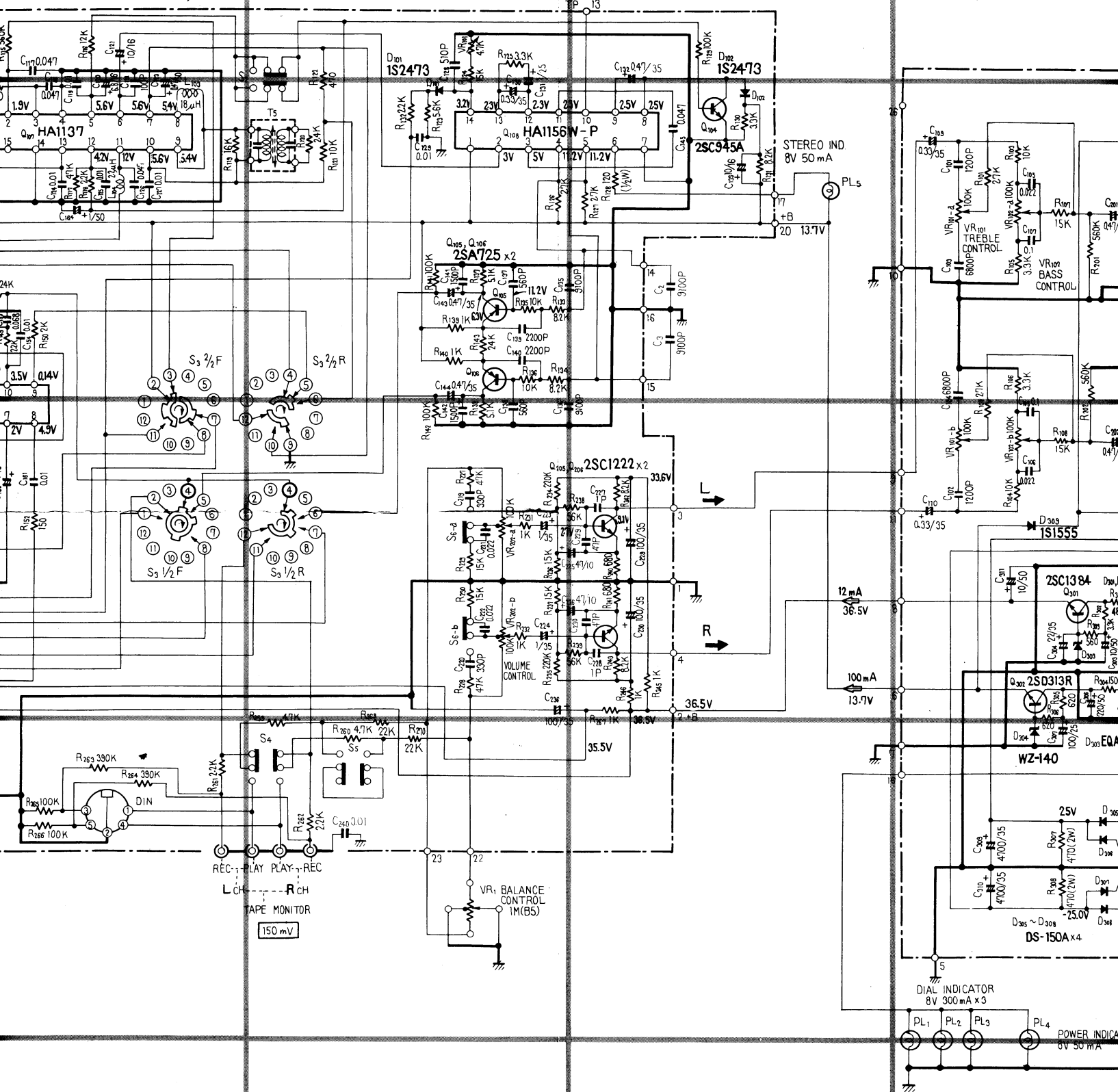

V : SIGNAL VOLTAGE AT SPEAKER OUTPUT 10.9V / 8Ω (1KHz)  
 mA : DC CURRENT AT NO SIGNAL  
 V : DC VOLTAGE AT NO SIGNAL

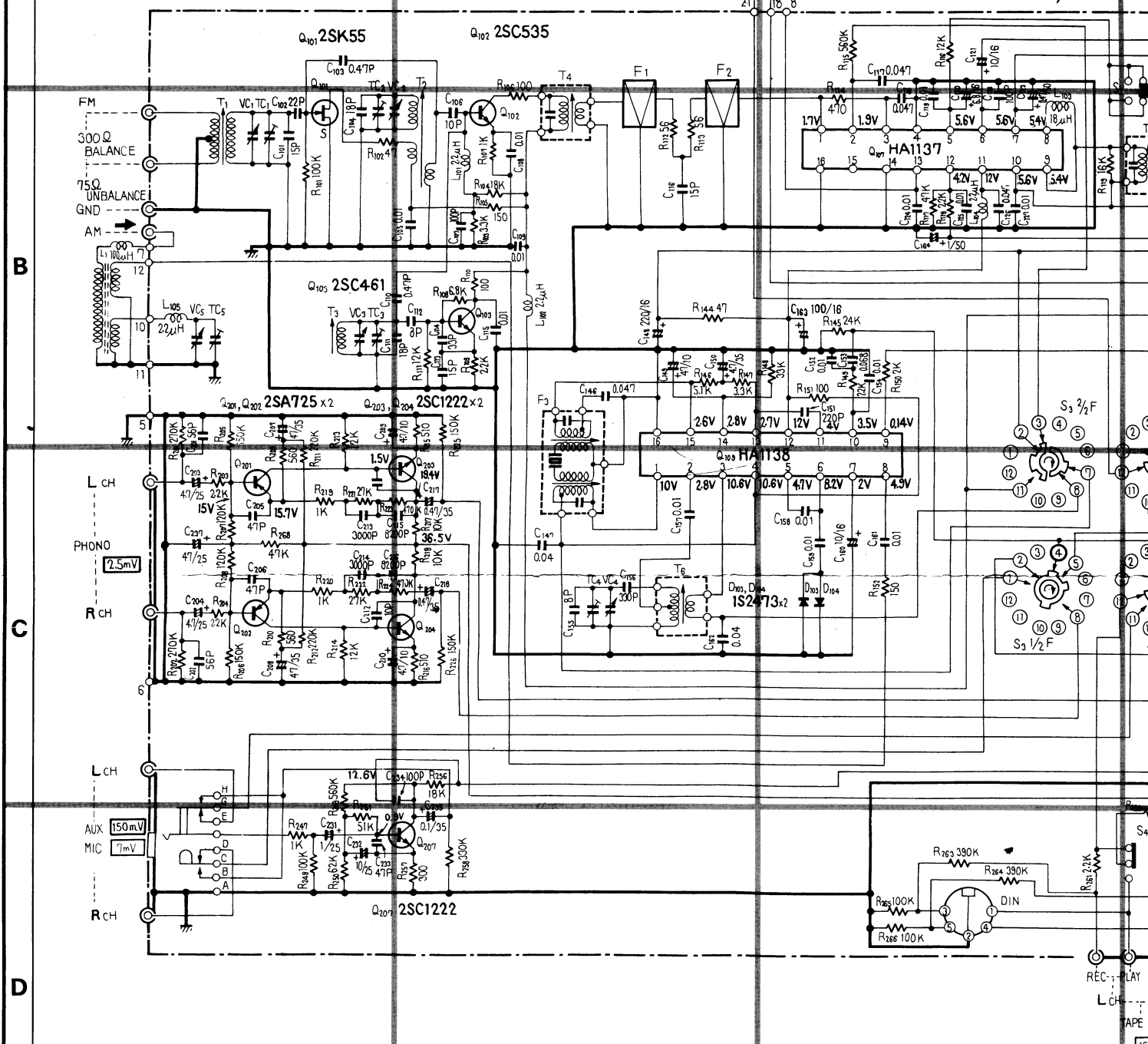

SWITCHES:

- |  |                                      |   |   |                                      |                                     |
|--|--------------------------------------|---|---|--------------------------------------|-------------------------------------|
| S <sub>1</sub> SPEAKERS<br>1 POWER OFF<br>2 SP A<br>3 SP OFF<br>4 SP B<br>5 SP A + B | S <sub>2</sub> FM MUTING<br>ON → OFF | S <sub>3</sub> FUNCTION<br>1 AM<br>2 FM<br>3 PHONO<br>4 AUX | S <sub>4</sub> TAPE MONITOR<br>OFF → ON | S <sub>5</sub> MODE<br>STEREO ↔ MONO | S <sub>6</sub> LOUDNESS<br>OFF → ON |
|--|--------------------------------------|---|---|--------------------------------------|-------------------------------------|

S<sub>1</sub> AC VOLTAGE SELECTOR  
220V ↔ 240V

RESISTORS:  
IN OHM, 1/4W, ±5% TOLERANCE UNLESS  
OTHERWISE NOTED K=KΩ, M=MΩ

CAPACITORS:  
IN μF UNLESS OTHERWISE NOTED P=pF

∇ : SIGNAL VOLTAGE AT SPEAKER  
↗ mA : DC CURRENT AT NO SIGNAL  
V : DC VOLTAGE AT NO SIGNAL

## 9. ADJUSTMENT

### 9.1 AM SECTION

1. Through a 1k ohm resistor, connect an AM signal generator to the AM antenna terminal. Set for 400kHz at 100dB and 30% modulation.
2. Connect AC voltmeter to TAPE REC jack (L or R).
3. Set FUNCTION switch to AM position.
4. Set AM signal generator and SX-450 dial indication to point A (600kHz).
5. Adjust T6 for maximum indication on AC voltmeter.
6. Set AM signal generator and SX-450 dial indication to point C (1,400kHz).
7. Adjust TC4 for maximum indication on AC voltmeter.
8. Again set AM signal generator and SX-450 dial indication to point A.
9. Adjust bar antenna core for maximum indication on AC voltmeter.
10. Return AM signal generator and SX-450 dial indication to point C.
11. Adjust TC5 for maximum indication on AC voltmeter.
12. Repeat steps 4-11 to eliminate variations in AC voltmeter indications at point A and C.

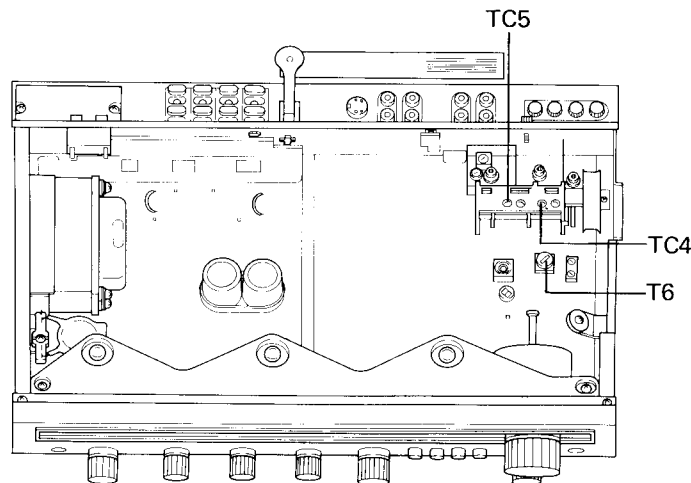
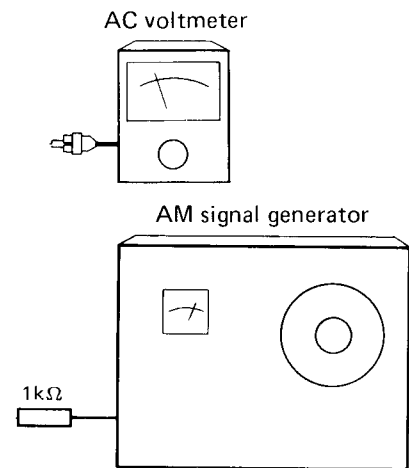
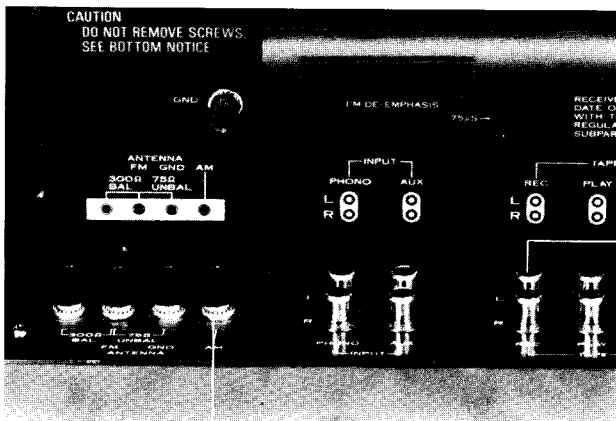



## 9.2 FM SECTION

1. Through 300 ohm dummy antenna, connect FM signal generator to the 300 ohm FM antenna terminals and set for 400Hz at 100dB and 100% modulation.
2. Connect AC voltmeter and distortion meter to TAPE REC jack (L or R).
3. Set FUNCTION switch to FM and MUTING switch to OFF.
4. Set FM signal generator and SX-450 dial indication to point A (90MHz).
5. Adjust T3 for maximum indication on AC voltmeter.
6. Adjust T5 lower core for center of scale indication on AM/FM meter.
7. Set FM signal generator for 9dB output and adjust T1 and T2 for maximum indication on AC voltmeter.
8. Set FM signal generator and SX-450 dial indication to point C (106MHz).
9. Adjust TC3, then TC1 and TC2 for maximum indication on AC voltmeter.
10. Again set FM signal generator and SX-450 dial indication to point A.
11. Adjust T3, then T1 and T2 for maximum indication on AC voltmeter.
12. Repeat steps 8-11 to eliminate variations in sensitivity at points A and C.
13. Adjust T4 for maximum sensitivity.
14. Detune to noise only and adjust T5 lower core for center of scale indication on FM meter.
15. Set SX-450 dial indication to point B (98MHz) and adjust FM signal generator for center of scale indication on AM/FM meter.
16. Set FM signal generator output to 60dB and adjust T5 upper core for minimum distortion.
17. Repeat steps 14-16 eliminate variation in minimum distortion position.

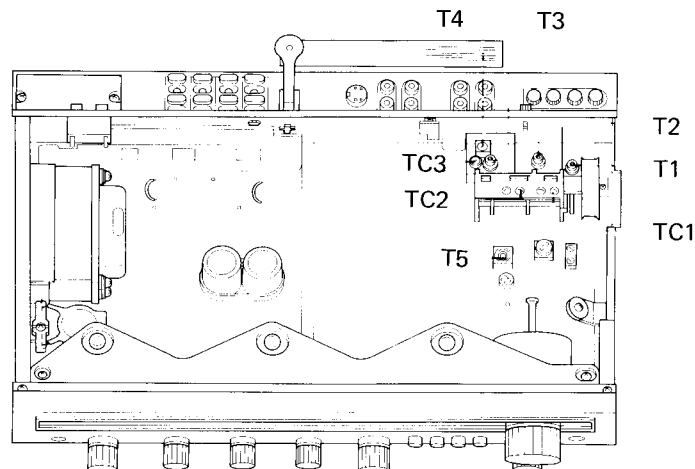
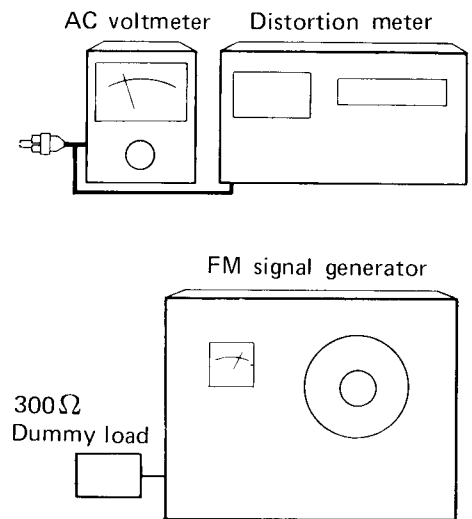
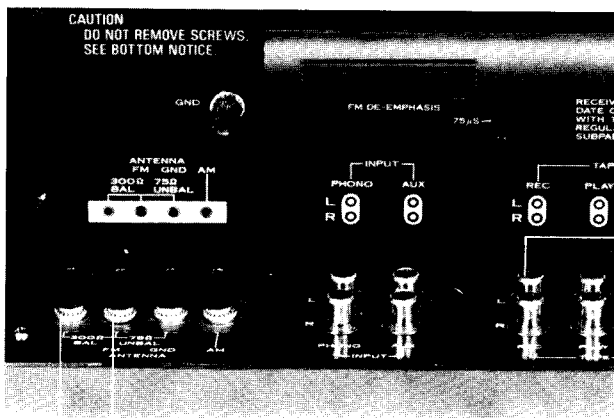

9.3 MPX SECTION

1. Through 300 ohm dummy antenna, connect FM signal generator to 300 ohm FM antenna terminals.
2. Connect multiplex signal generator to external modulation terminals of FM signal generator.
3. Connect oscilloscope horizontal input to MPX signal pilot output and vertical input via probe to TP (No. 13) of circuit board.
4. Set SX-450 dial indication to 98MHz and adjust FM signal generator for center of scale indication on AM/FM meter.
5. With FM signal generator unmodulated, adjust VR1 so that lissajous pattern on oscilloscope becomes stationary as shown in Fig. 12.
6. With MPX signal generator modulation 1kHz, L + R 67.5kHz deviation and pilot 7.5kHz deviation, adjust T4 for minimum distortion.

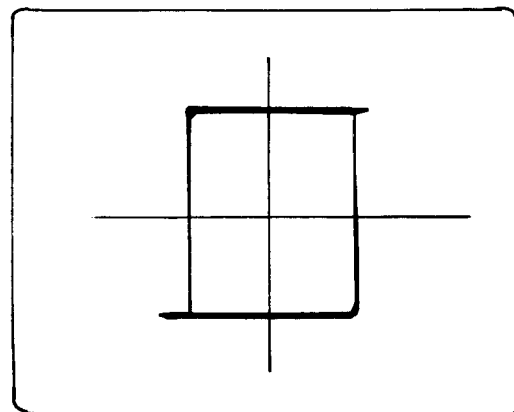
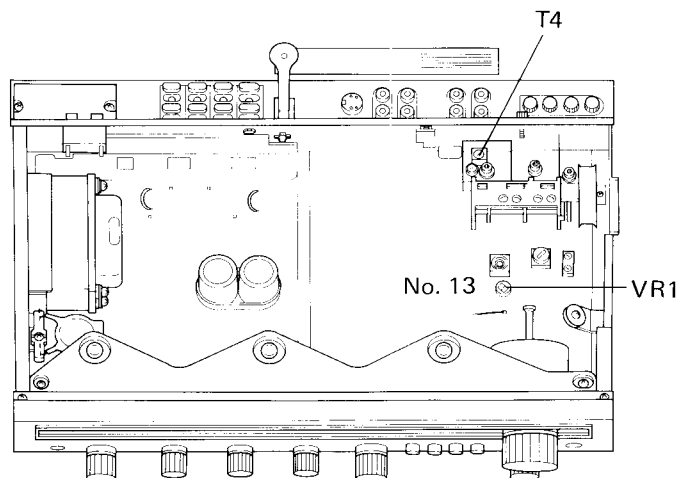
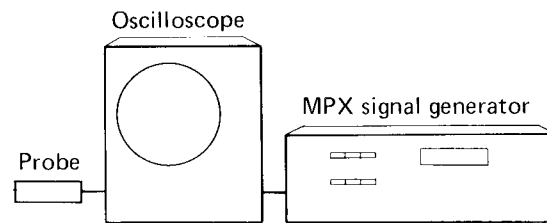
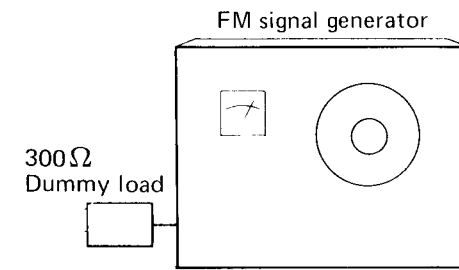
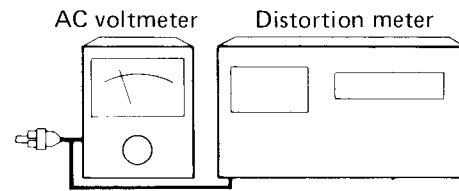
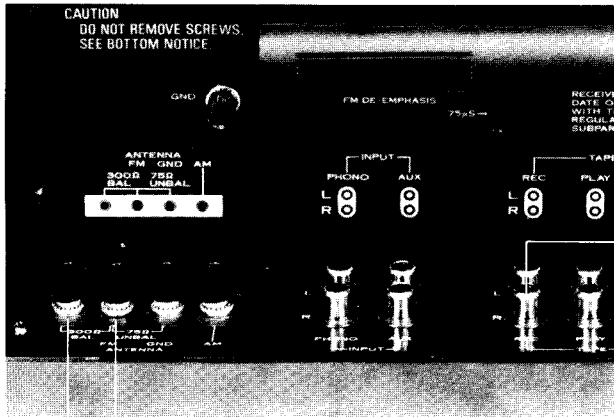
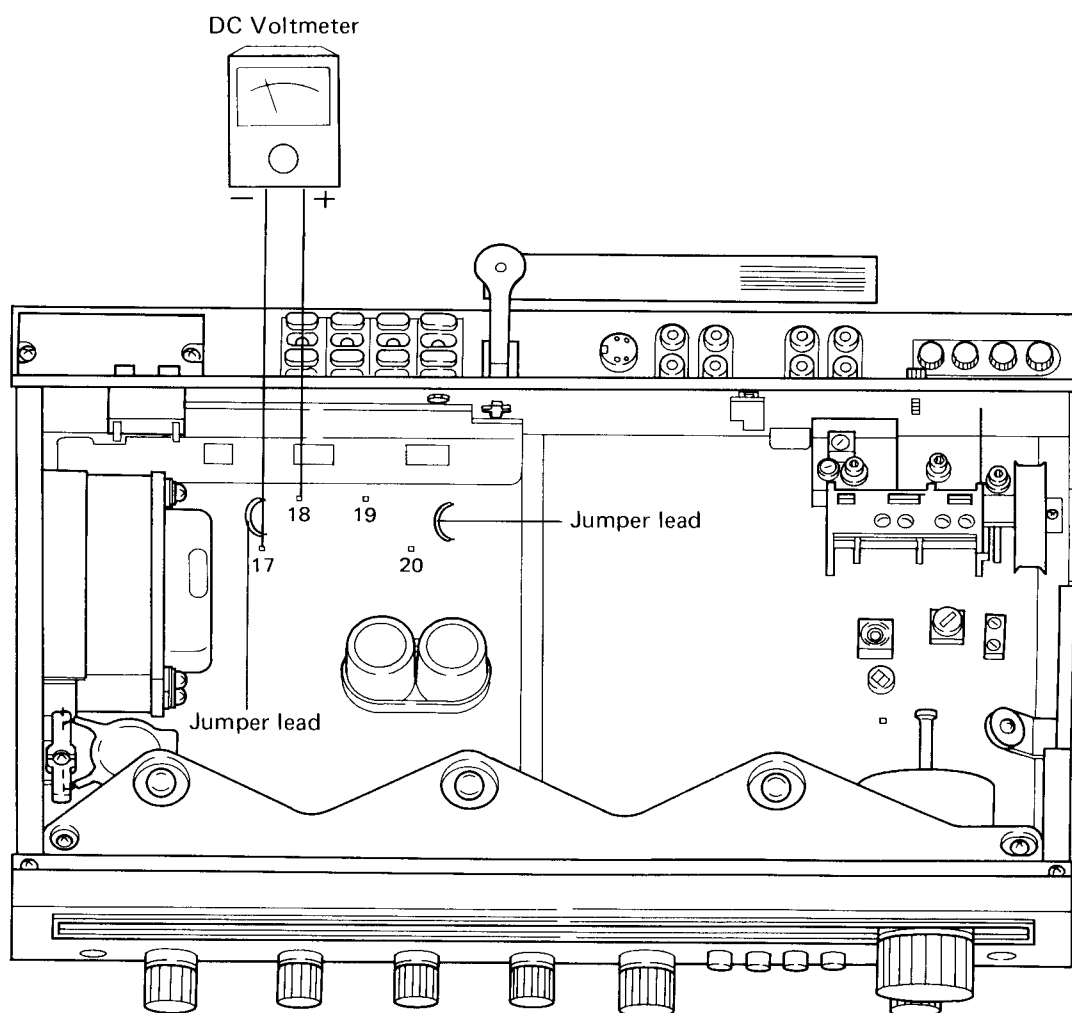

Fig. 12

#### 9.4 POWER AMPLIFIER SECTION (IDLE CURRENT)

1. Set BASS and TREBLE controls to center position.
2. Nothing should be connected to the INPUT jacks of SX-450 and an 8 ohm dummy load should be connected across the SPEAKER terminal.
3. A DC voltmeter should be connect across between terminal number 19 (+), 20 (-) for Left channel and 18 (+), 17 (-) for Right channel.
4. Cut the jumper lead, if the voltage less than 15mV.



## 10. DIAL CORD STRINGING

Remove the Front panel (See page 14, 15).

1. Turn tuning drum fully clockwise (as viewed from X direction in Fig. 13).
2. Tie one end of cord to stud on inner section of tuning drum (more easily performed by loosening setscrew and temporarily removing tuning drum from shaft).
3. Pass cord through pulley opening, make a half turn around the pulley, then route in the sequence: pulley A-Dial needle-pulley B-C.
4. Wind cord clockwise (as viewed from rear panel) 3 turns around dial shaft, then route to pulley D.
5. Wind 3 turns around dial pulley and tie to spring so that the cord is under tension.
6. Turn TUNING knob and confirm normal cord-motion, then trim off excess cord.
7. With tuning capacitor blades fully closed, move dial needle to starting point (left edge of scale).
8. Apply laquor to tied ends of cord.

### DIAL NEEDLE INSTALLATION CAUTION

Metal portion of dial pointer is plated. If this section is touched directly by hand or fingerprints and other impurities, it is difficult to remove dirt from aventurine finish. As this is not desirable in terms of both appearance and anti-corrosion, take extreme care not to touch the metal section when handling the dial needle.

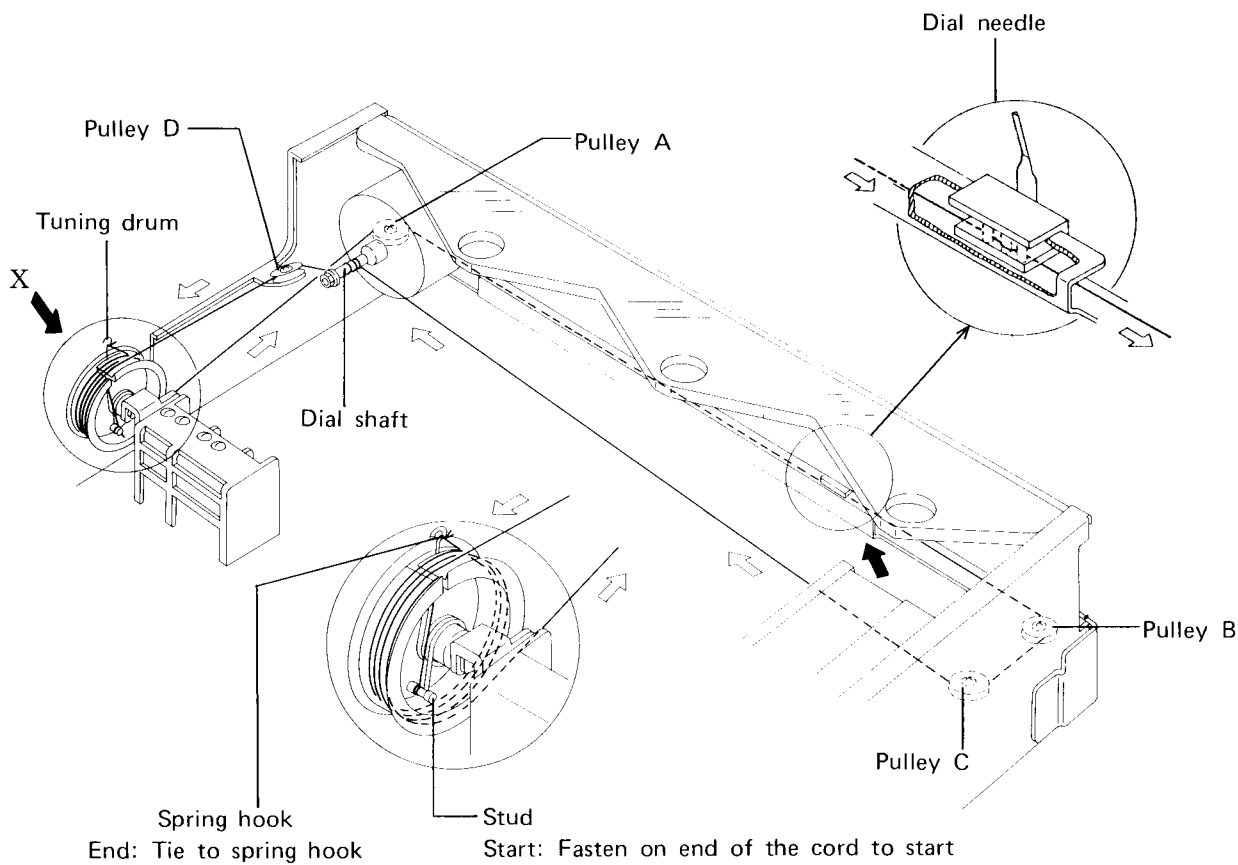

Fig. 13