

Switch circuit ass'y AWS-015

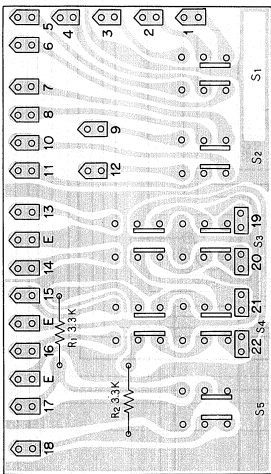

CR ass'y AWX-012 (KCW, KUW model)

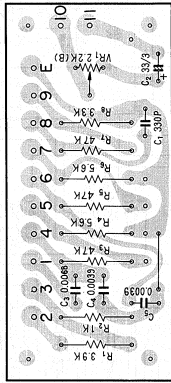

CR ass'y AWX-013 (FW, NBW, FVZW model)

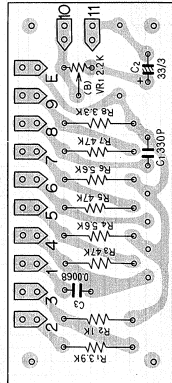

Equalizer amp ass'y AWF-003

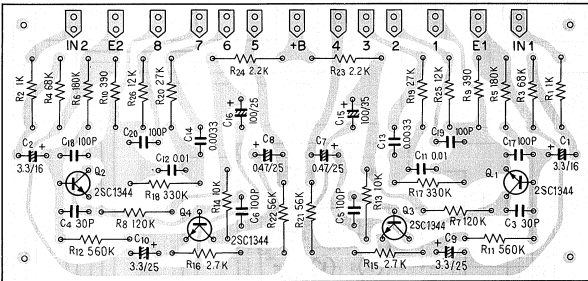

Power amp ass'y AWH-006 (NBW model AWH-012)

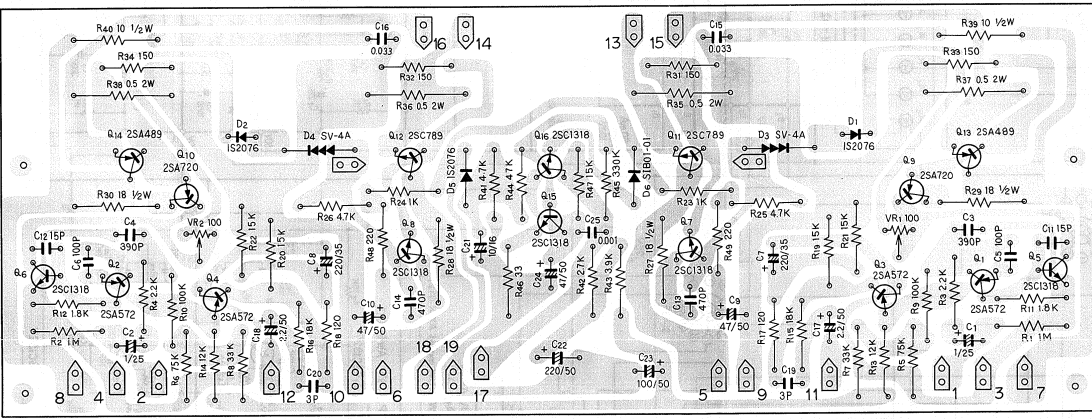

Power supply ass'y AWR-007

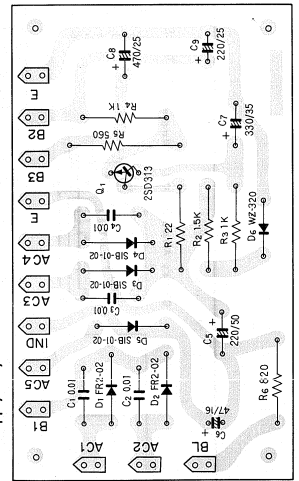

Tuner ass'y AWE-003

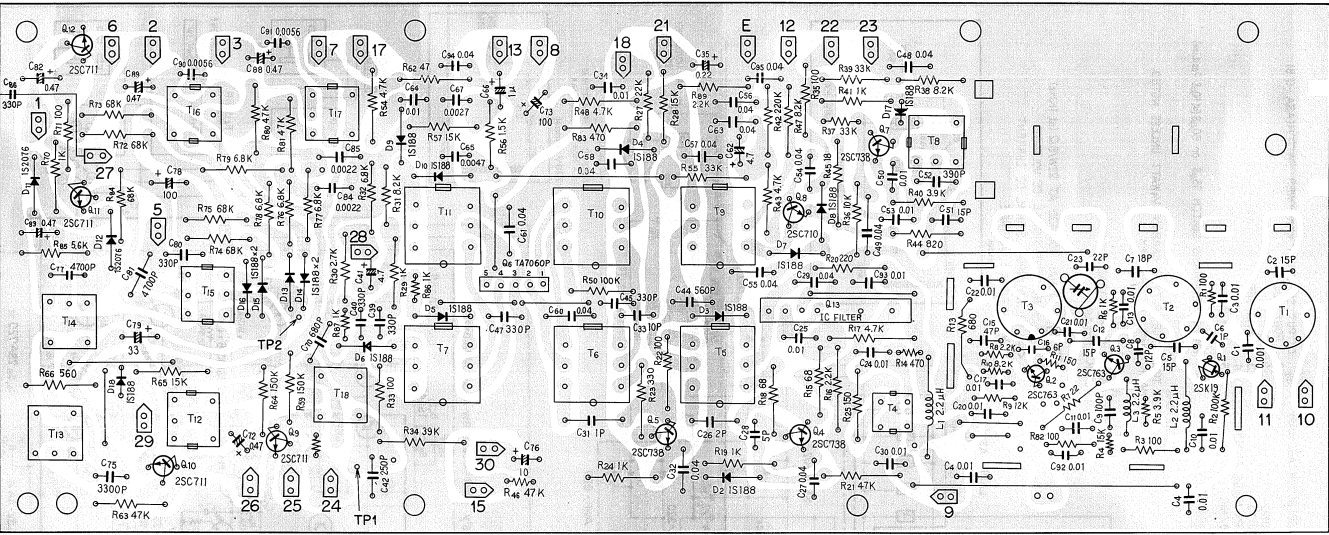

Control amp ass'y AWG-011

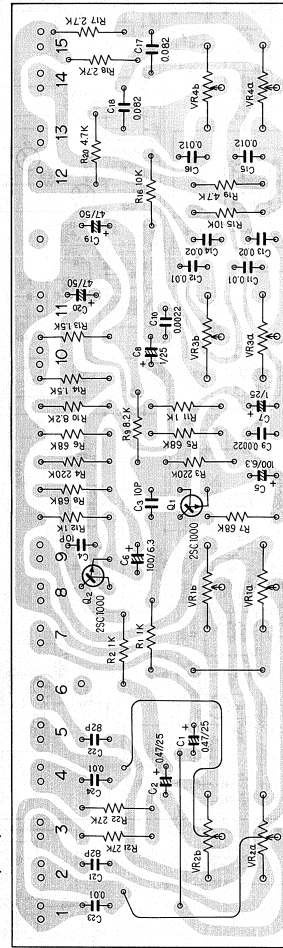

AM/FM STEREO RECEIVER
SX-525
FVZW FW KCW KUW NBW

SX-525

TUNER Ass'y AWE-003

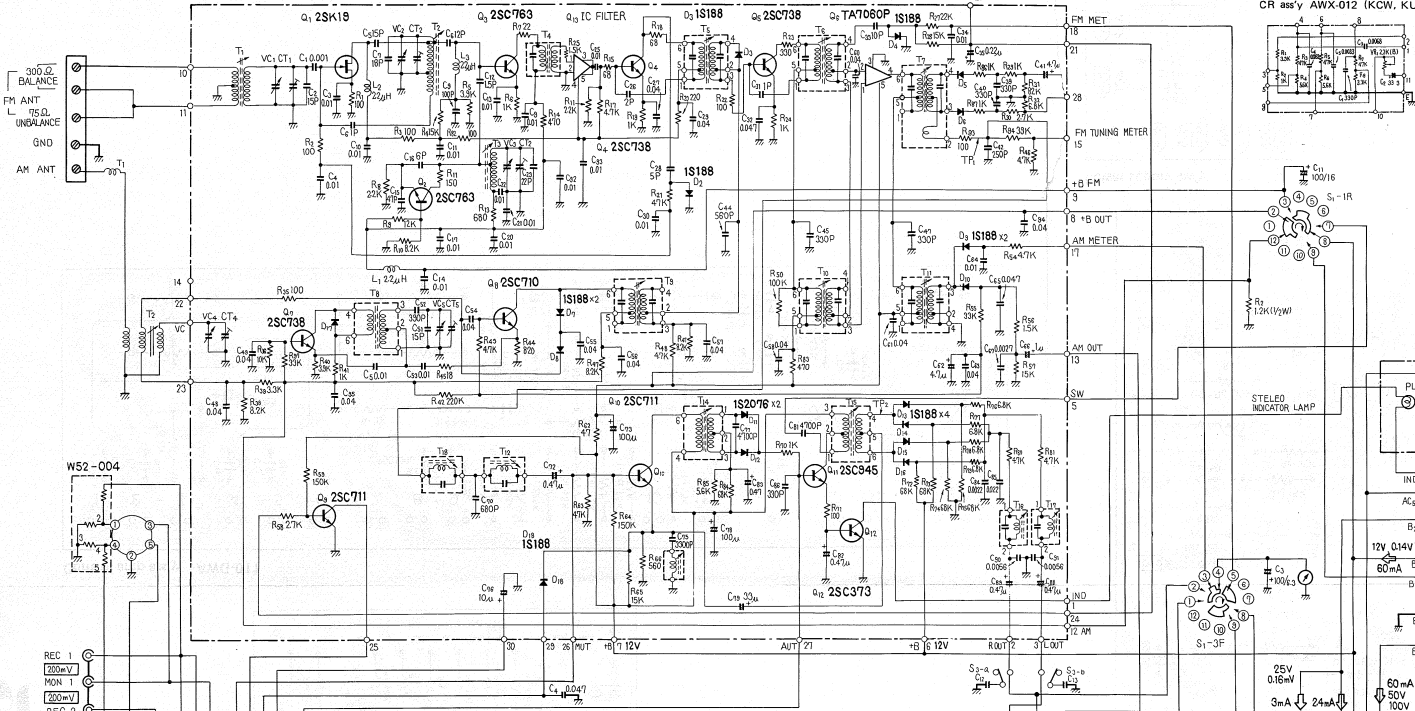

- SWITCHES**
- S₁ INPUT SELECTOR (ASC-019)
 1. AM
 2. FM MONO
 3. FM AUTO
 4. FM MPX NOISE FILTER
 5. PHONO/MIC
 6. AUX
 - S₂ OUTPUT SELECTOR with POWER SWITCH (ASA-018)
 1. POWER OFF
 2. A
 3. SPKR OFF
 4. B
 5. A + B
- S₃ FM DE-EMPHASIS SWITCH 75μS or 50μS (at 50S Position)

RESISTORS
 ± 10% TOLERANCE P-TYPE CARBON 1/4WATT UNLESS NOTED.
 NON MARK : OHM K: KILO OHM

CAPACITORS
 NON MARK : MICRO FARAD
 NON MARK : MYLAR

V : SIGNAL VOLTAGE AT 22W/8Ω (at 1KHz)
 V : NO INPUT SIGNAL DC VOLTAGE
 V : NO INPUT SIGNAL DC CURRENT
 V : RIPPLE VOLTAGE
 120V model

