

Switch and control ass'y AWM-068

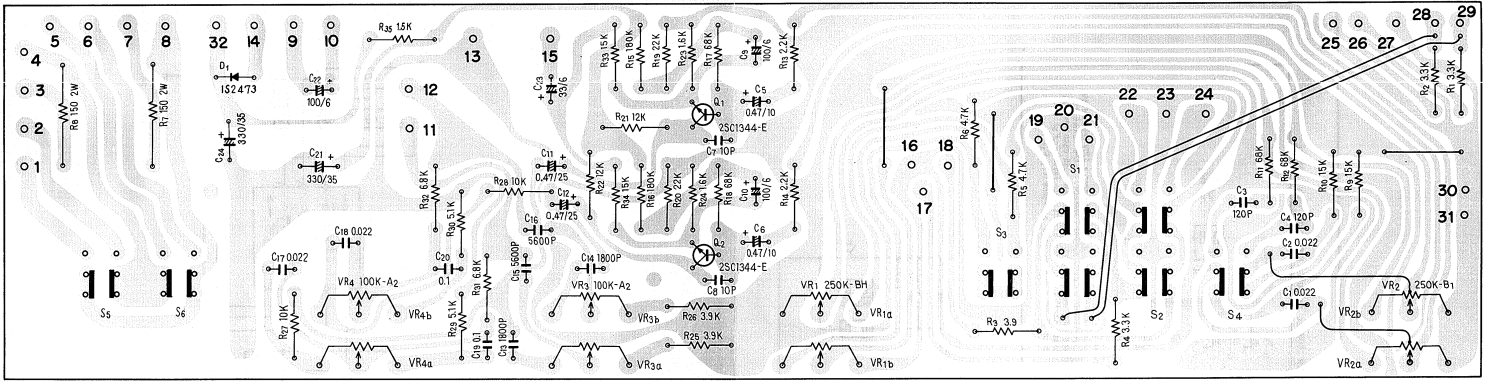

Tuner ass'y AWE-046

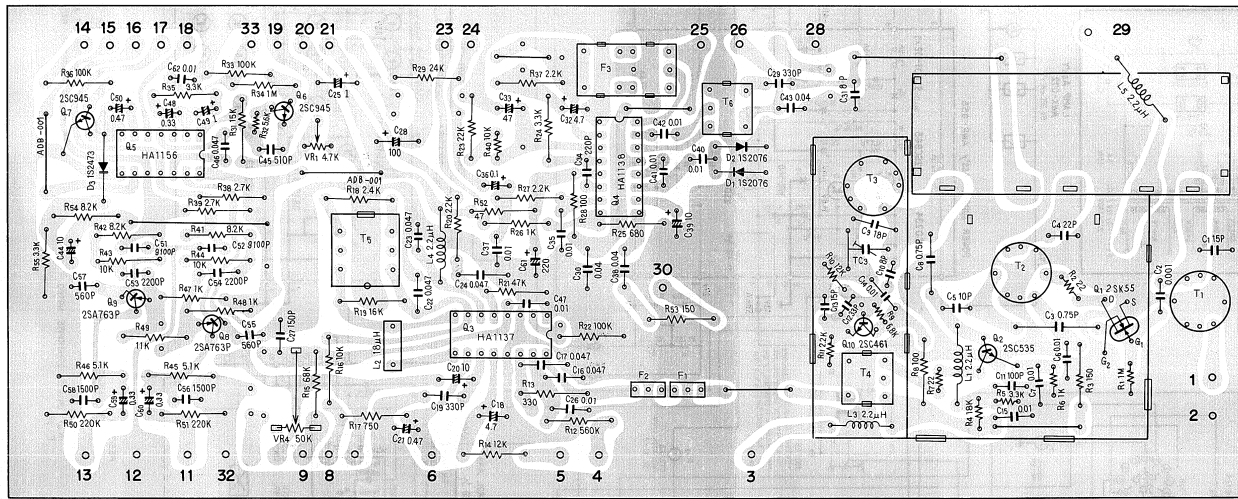

Equalizer amp ass'y AWF-014

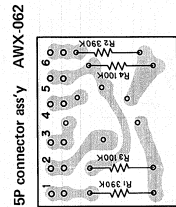
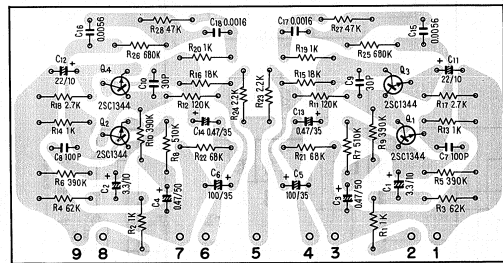

Power supply ass'y AWR-065

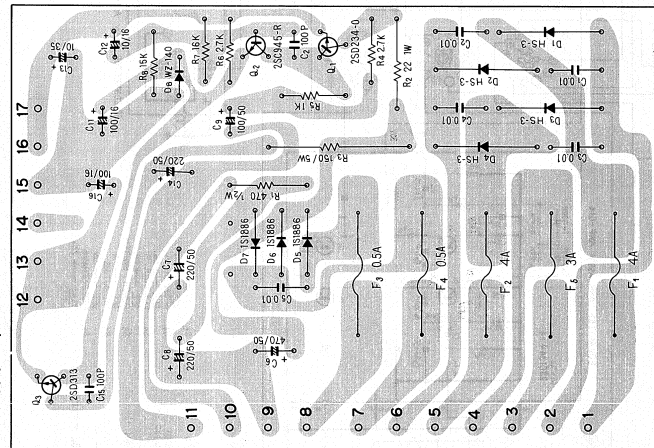

Power amp ass'y AWH-035

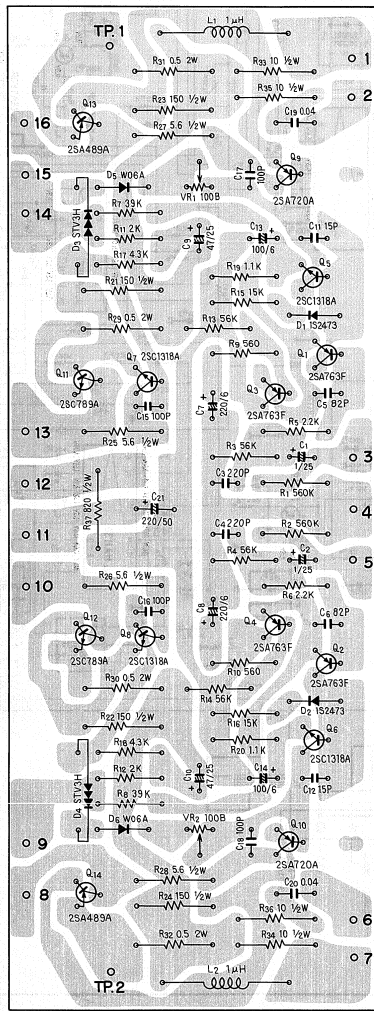

AM/FM STEREO RECEIVER
SX-535
 FV GN KCU

SX-535

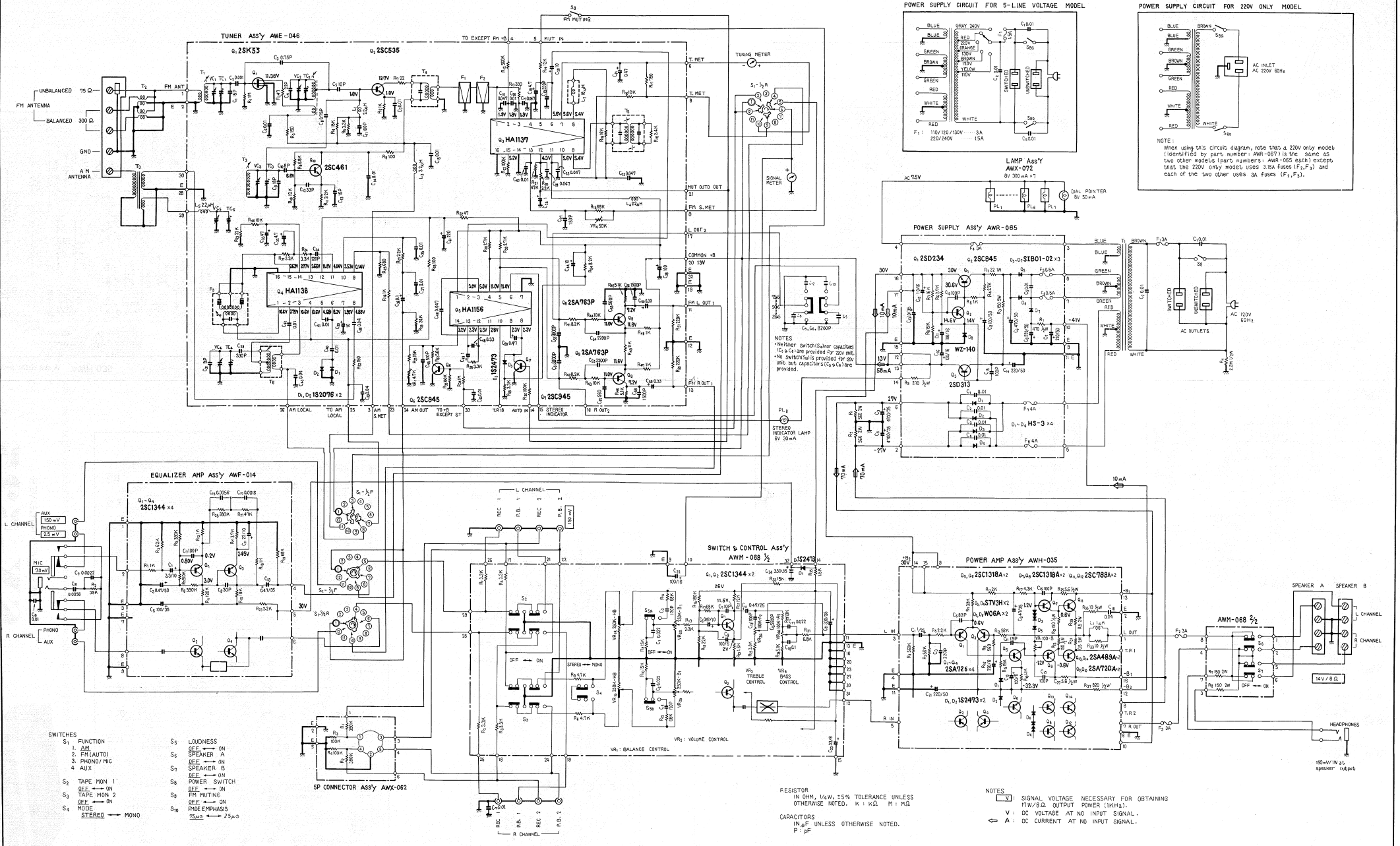

- SWITCHES**
- S1 FUNCTION
 - 1. AM
 - 2. FM(AUTO)
 - 3. PHONO/MIC
 - 4. AUX
 - S2 TAPE MON 1
 - OFF → ON
 - S3 TAPE MON 2
 - OFF → ON
 - S4 MODE
 - STEREO → MONO
 - S5 LOUDNESS
 - DEF → ON
 - S6 SPEAKER A
 - DEF → ON
 - S7 SPEAKER B
 - DEF → ON
 - S8 POWER SWITCH
 - OFF → ON
 - S9 FM MUTING
 - OFF → ON
 - S10 MODE/PHASIS
 - 25μs

RESISTOR
IN OHM, 1/4W, 5% TOLERANCE UNLESS OTHERWISE NOTED. K: KΩ M: MΩ

CAPACITORS
IN μF UNLESS OTHERWISE NOTED.
P: pF

NOTES

- ① SIGNAL VOLTAGE NECESSARY FOR OBTAINING 1W/8Ω OUTPUT POWER (1kHz).
- V: DC VOLTAGE AT NO INPUT SIGNAL.
- ⊙ A: DC CURRENT AT NO INPUT SIGNAL.