

Service Manual

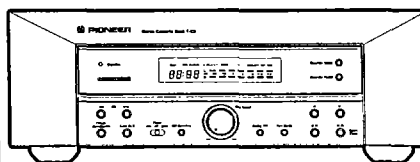

ORDER NO.
RRV1041

STEREO CASSETTE DECK

T-C3

THIS MANUAL IS APPLICABLE TO THE FOLLOWING MODEL(S) AND TYPE(S).

Type	Model	Power Requirement	The voltage can be converted by the following method.
	T-C3		
HE	○	AC220 - 230V	AC230 - 240V *
HB	○	AC230 - 240V	AC220 - 230V *
HEWM	○	AC220 - 230V	AC230 - 240V *

*: Alter the wiring of the Power-supply block at the primary winding of power transformer referring to the "Line Voltage Selection" described in Service Manual.

CONTENTS

1. EXPLODED VIEWS, PACKING AND PARTS LIST	2
2. BLOCK DIAGRAM	8
3. PCB PARTS LIST	9
4. SCHEMATIC DIAGRAM	12
5. PCB CONNECTION DIAGRAM	15
6. ADJUSTMENTS	21
7. IC INFORMATION	24
8. FL INFORMATION	26
9. PANEL FACILITIES	27
10. SPECIFICATIONS	28

PIONEER ELECTRONIC CORPORATION 4-1, Meguro 1-Chome, Meguro-ku, Tokyo 153, Japan

PIONEER ELECTRONICS SERVICE INC. P.O. Box 1760, Long Beach, California 90801 U.S.A.

PIONEER ELECTRONICS OF CANADA, INC. 300 Allstate Parkway Markham, Ontario L3R 0P2 Canada

PIONEER ELECTRONIC [EUROPE] N.V. Haven 1087 Keetberglaan 1, 9120 Melsele, Belgium

PIONEER ELECTRONICS AUSTRALIA PTY. LTD. 178-184 Boundary Road, Braeside, Victoria 3195, Australia TEL: [03] 580-9911

© PIONEER ELECTRONIC CORPORATION 1993

O - SN DEC. 1993 Printed in Japan

1. EXPLODED VIEWS, PACKING AND PARTS LIST

NOTES:

- Parts marked by "NSP" are generally unavailable because they are not in our Master Spare Parts List.
- The Δ mark found on some component parts indicates the importance of the safety factor of the part. Therefore, when replacing, be sure to use parts of identical designation.
- Parts marked by "⊙" are not always kept in stock. Their delivery time may be longer than usual or they may be unavailable.

Parts List

Mark	No.	Description	Part No.	Mark	No.	Description	Part No.
Δ	1	Strain relief	CM - 22B		48	Washer	WT16D032D025
Δ	2	Power cord with plug (T - C3/HE and HEWM)	PDG1003		49	Slide knob	REA1111
Δ	2	Power cord with plug (T - C3/HB)	PDG1021		50	VR knob	REA1112
	3	Lead card 11P	RDD1295		51	Loading motor assy	RXX1341
	4	Lead card 11P	RDD1298		52	Motor pulley	PNW1634
	5	Connector assy 5P	RKP1350		53	Screw	IPZ26P060FMC
					54	Screw	PMZ30P080FMC
					55	Screw	BBZ26P060FZK
Δ	6	AC Socket (T - C3/HB)	AKP - 509		56	Screw	BBT30P080FCC
Δ	6	AC Socket 1 - P (T - C3/HE and HEWM)	AKP - 508		57	Screw	BBZ26P080FZK
Δ	7	Power transformer	RTT1263		58	Screw	IBZ30P080FCC
Δ	8	Fuse (1.25A)	REK1023		59	Screw	IBZ30P150FCC
	9	Loading motor	VXM1034		60	Screw	IBZ30P060FCC
	10	Cassette mecha unit	RYM1219				
NSP	11	Cord clamper	DNF1128	NSP	61	VERTICAL UNIT	RWZ3116
NSP	12	PCB spacer	PNY - 404	NSP	62	TR1 UNIT (T - C3/HE)	RWZ3253
NSP	13	Washer	RBF1017	NSP	62	TR1 UNIT (T - C3/HB)	RWZ3252
	14	Spring	RBH1375	NSP	62	TR1 UNIT (T - C3/HEWM)	RWZ3254
NSP	15	FFC cover	REC1222	NSP	63	TR2 UNIT	RWZ3259
					64	MAIN UNIT	RWZ3251
NSP	16	Main chassis	RNB1095	NSP	65	REGULATOR A UNIT	RWZ3113
NSP	17	MECHA UNIT	RWZ3103				
	18	Door cover	RNE1770	NSP	66	REGULATOR B UNIT	RWZ3114
	19	Cord clamper	RNH - 184	NSP	67	OPERATE UNIT	RWZ3098
	20	Door	RNK2025	NSP	68	FL UNIT	RWZ3099
					69	Connection cord with plug	PDE - 319
	21	Damp cushion	VEC1110		70	Connection cord assy	RDE1002
	22	Tray panel	RAH2344				
	23	Release arm SP	RBH1276		71	Control cord	RDE1030
	24	Earth spring	RBK1043		72	Operating instructions (T - C3/HB) (English)	RRB1147
	25	Half pressure spring	RBK1037		72	Operating instructions (T - C3/HE) (English/French/German/ Italian/Dutch/Swedish/ Spanish/Portuguese)	RRE1099
	26	Drive belt	REB1249		72	Operating instructions (T - C3/HEWM) (German/Italian)	RRD1152
NSP	27	Release arm	RNE1410		73	Screw	BBZ30P100FCC
	28	Earth spring	RBH1280		74	Pad F	RHA1137
	29	Tray base	RNE1736		75	Pad R	RHA1138
	30	Clamp arm	RNK1666				
	31	Pulley gear	RNK1667		76	Sheet	RHX1003
	32	Loading base R	RNK1668		77	Packing case	RHG1561
	33	Cassette plate	RNK1754	NSP	78	Mechanism stay	RNE1737
	34	Tray	RNK2024	NSP	79	Jumper wire 08P	D20PYY0820G
	35	Loading base L assy	RXA1363		80	Fiber washer	REC1204
	36	Steel ball (ϕ 6)	VNX1002				
	37	Bonnet	ANE7010	NSP	81	Shield plate	RNE1771
	38	LED lens	PNW2019		82	LD pad	REC1472
	39	Insulator	PNW2363	Note 1	83	Spacer	RHC1049
	40	Button	RAC1859	Note 1	84	Caution sheet	RRN1005
				Δ	85	Fuse (2.5A) (T - C3/HE only)	REK1026
	41	Front panel	RAH2345		86	AC OUTLET UNIT (T - C3/HE only)	RWZ3102
	42	FL lens	RAH2346				
	43	Center panel	RAH2405				
	44	Name plate	RAN1013				
	45	Rear panel (T - C3/HB)	RNA1806				
	45	Rear panel (T - C3/HE)	RNA1807				
	45	Rear panel (T - C3/HEWM)	RNA1817				
	46	Panel stay	RNT1190				
NSP	47	Tray label	RRW1159				

Note 1 : The spacer and caution sheet are used to protect the door when transportig the product.

Exterior

T-C3

Note 2: ① To remove the tray, remove the MECHA UNIT first and disassemble its parts.
 ② Attach the MECHA UNIT with the tray slightly out or the switch will be damaged.
 ③ When assembling, make sure that the jumper wire from operation unit No. 67 and the release arm No. 27 do not touch. (If they touch, the mechanism half detection switch will not operate.)

Note 2

NOTE: Screws adjacent to ▼ mark on the product are used for disassembly.

Packing

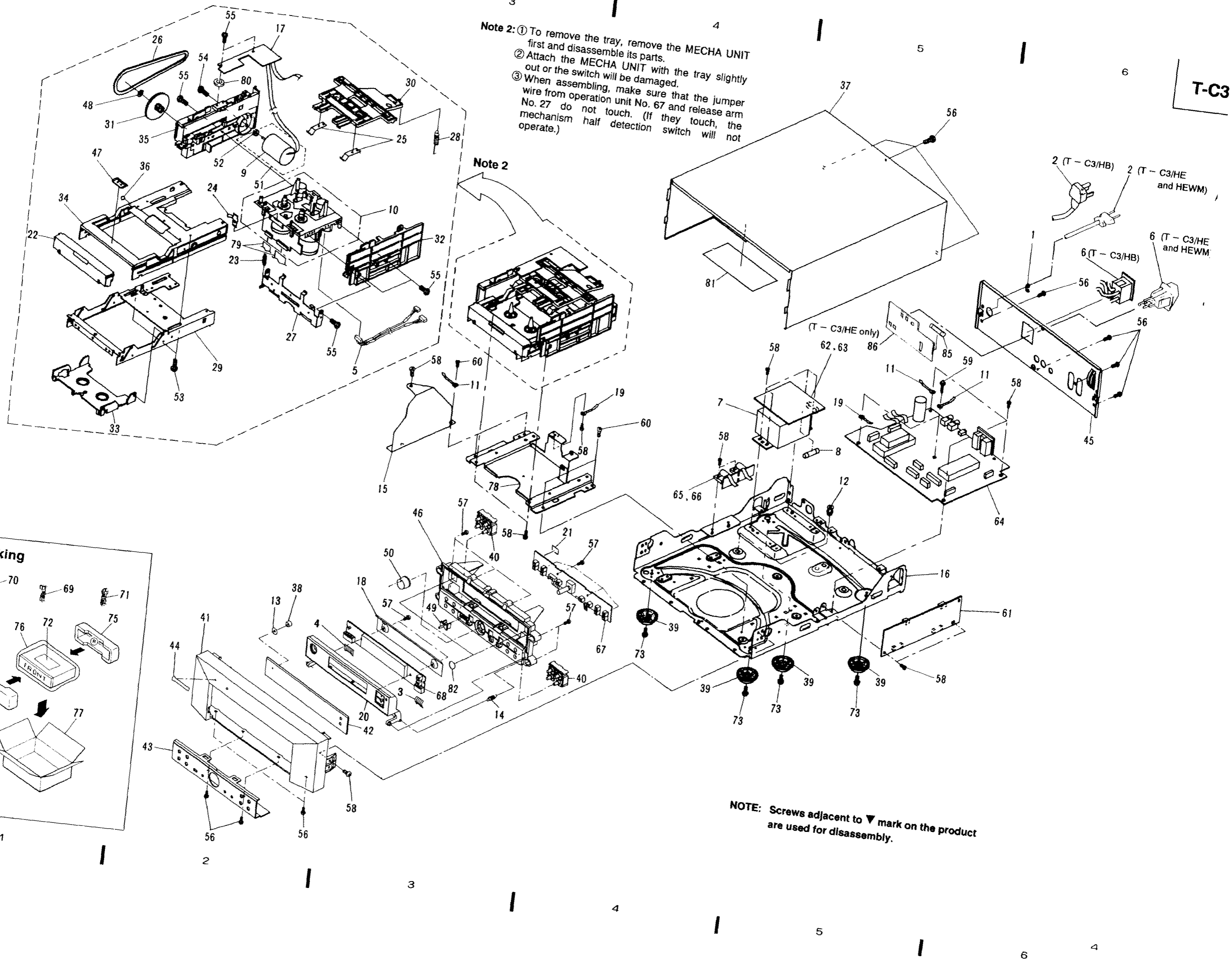
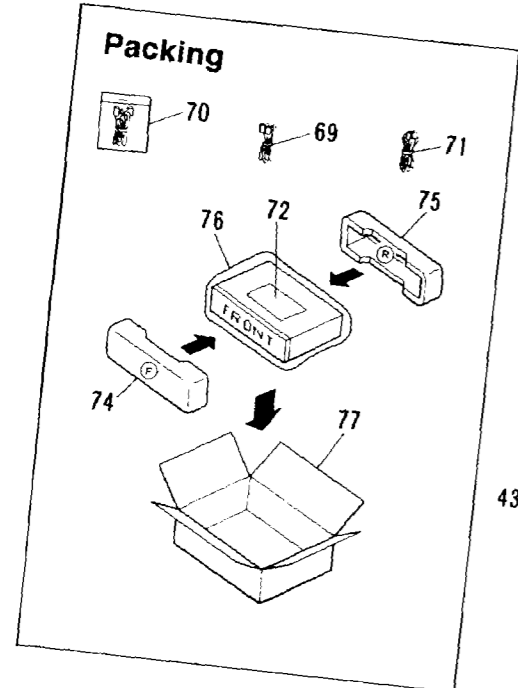

1.2 CASSETTE MECHA UNIT

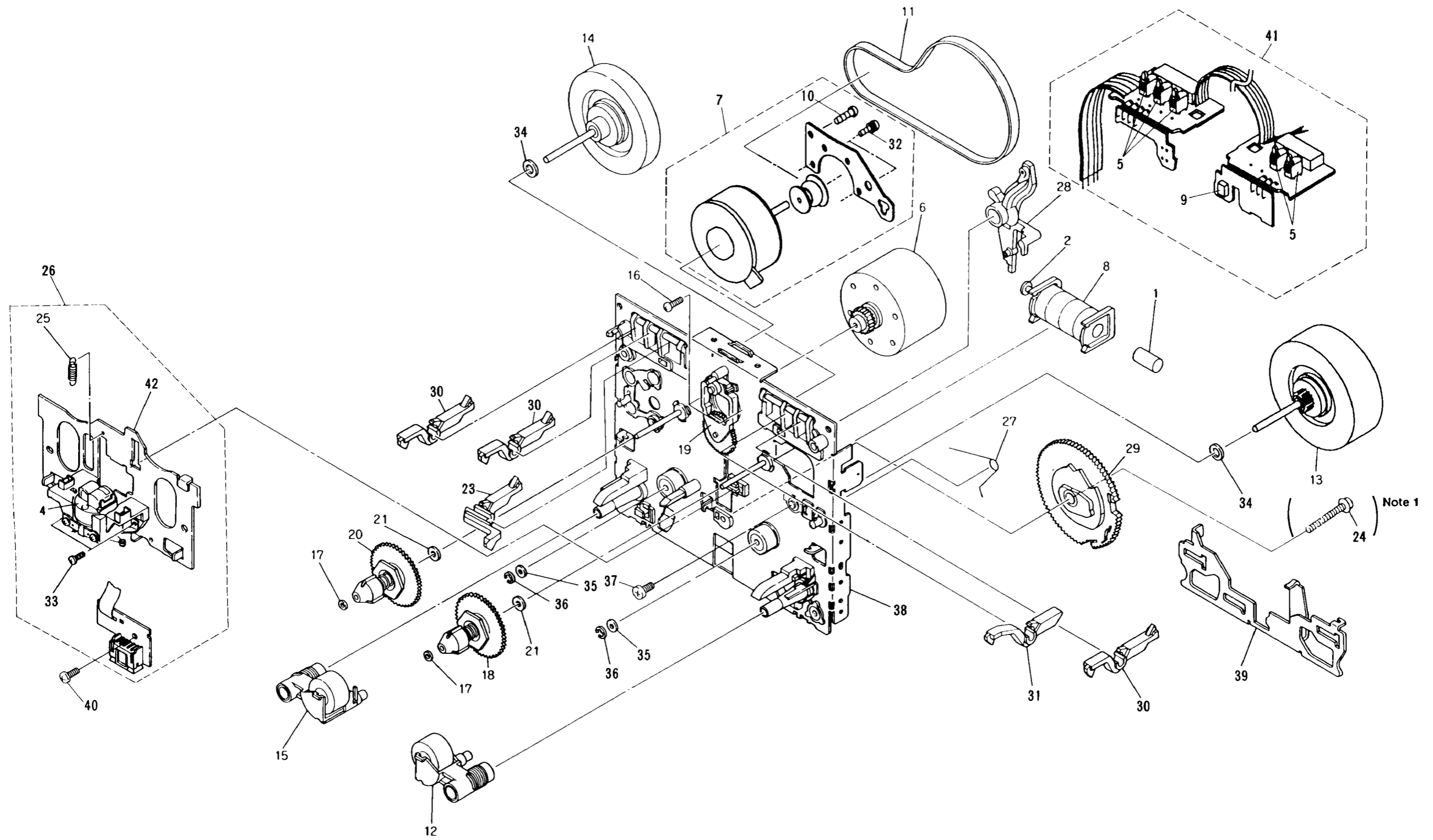

Parts List

Mark	No.	Description	Part No.
	1	Shaft	RLA1130
	2	Planger	RLA1132
	3	
	4	R/P, E head	RPB1030
	5	Push switch	RSG1018
	6	Reel motor (BLK)	RXM1029
	7	Main motor (BLK)	RXM1071
	8	Solenoid (BLK)	RXP1010
	9	Photo - Transistor	SPI33534FG
	10	Screw	PBZ26P080FZK
	11	Main belt	REB1157
	12	Pinch roller assy (DIA 2.5)	RXA1183
	13	Flywheel assy	RXA1609
	14	Flywheel assy	RXA1611
	15	Pinch roller assy (L)	RXA1296
	16	Screw	RBA1076
	17	Washer	RBF - 057
	18	Reel base (BLK)	RXA1184
	19	Idler (BLK)	RXA1248
	20	Reel base (BLK)	RXC - 040
	21	Washer	RBF1038
	22	
	23	Metal detection lever	RNK1529
	24	Screw	RBA1068
	25	Head base spring	RBL1003
	26	PLATE HD BLK	RXA1610
	27	Slide spring	RBH1239
	28	Play arm	RNK1525
	29	Cam gear (3R)	RNK1672
	30	REC detection lever	RNK1527
	31	PACK detection lever (P)	RNK1543
	32	Screw	PMA26P040FMC
	33	Screw	RBA1077
	34	Washer	WA26D045D025
	35	Washer	WA26D047D050
	36	Washer	YE15FUC
	37	Screw	RBA1101
	38	Chassis base (BLK)	RXA1608
	39	Slide plate	RNE1345
	40	Screw	PCZ20P040FMC
	41	PCB CONTROL BLK	RXA1607
NSP	42	Head base	RNE1343

Note 1 : The screw No. 24 is the part to hold the cam gear for servicing, when the hook holding the cam No. 29 is broken.

2. BLOCK DIAGRAM

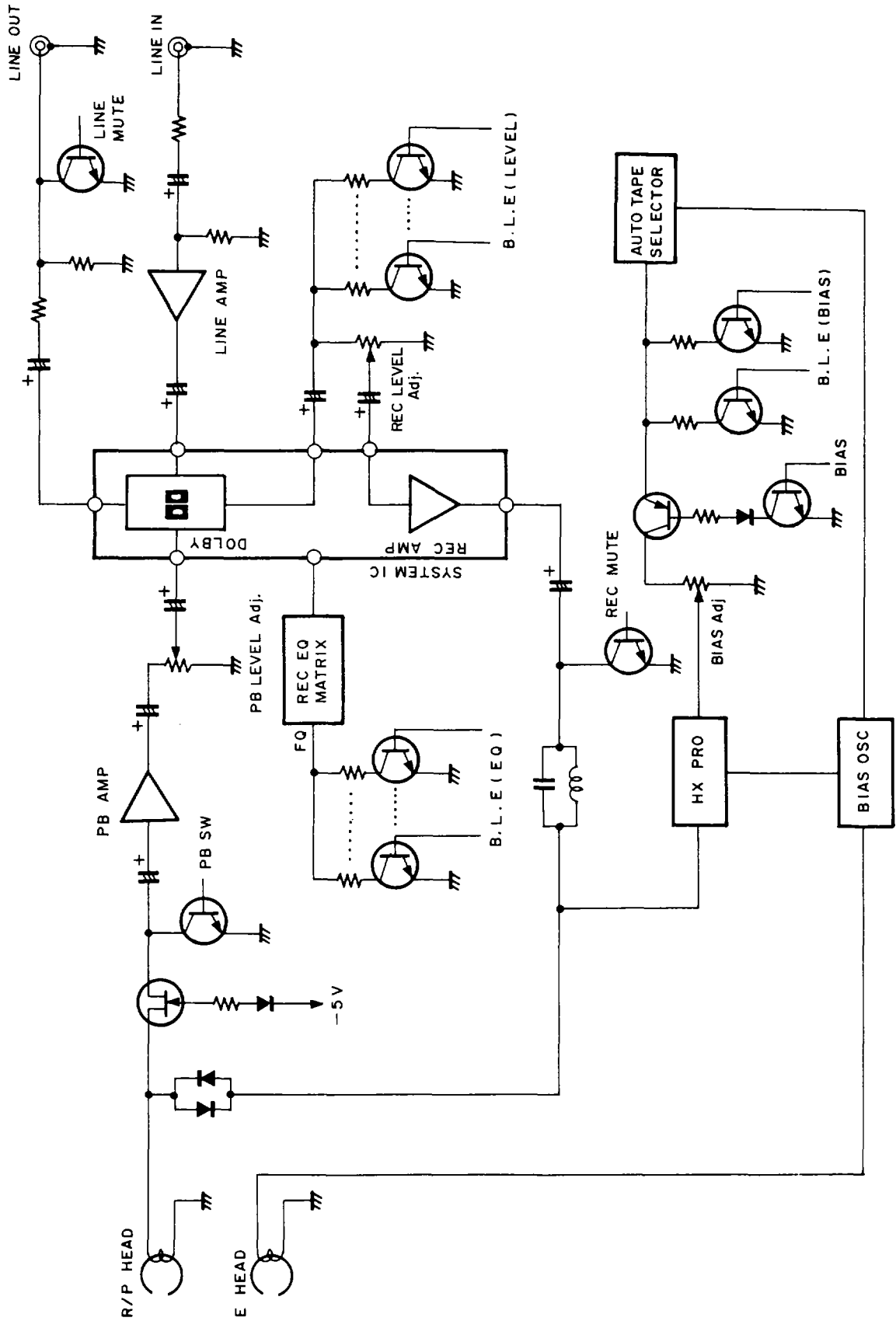

3. PCB PARTS LIST

NOTES:

- Parts marked by "NSP" are generally unavailable because they are not in our Master Spare Parts List.
- The Δ mark found on some component parts indicates the importance of the safety factor of the part. Therefore, when replacing, be sure to use parts of identical designation.
- Parts marked by "⊙" are not always kept in stock. Their delivery time may be longer than usual or they may be unavailable.
- When ordering resistors, first convert resistance values into code form as shown in the following examples.

Ex.1 When there are 2 effective digits (any digit apart from 0), such as 560 ohm and 47k ohm (tolerance is shown by J=5%, and K=10%).

560 Ω \rightarrow $56 \times 10^1 \rightarrow$ 561 RD1/8PM $\begin{matrix} 5 & 6 & 1 \\ \hline \end{matrix}$ J
 47k Ω \rightarrow $47 \times 10^3 \rightarrow$ 473 RD1/4PS $\begin{matrix} 4 & 7 & 3 \\ \hline \end{matrix}$ J
 0.5 Ω \rightarrow 0R5 RN2H $\begin{matrix} 0 & R & 5 \\ \hline \end{matrix}$ K
 1 Ω \rightarrow 010 RS1P $\begin{matrix} 0 & 1 & 0 \\ \hline \end{matrix}$ K

Ex.2 When there are 3 effective digits (such as in high precision metal film resistors).

5.62k $\Omega \rightarrow$ $562 \times 10^1 \rightarrow$ 5621 RN1/4PC $\begin{matrix} 5 & 6 & 2 & 1 \\ \hline \end{matrix}$ F

Mark	No.	Description	Part No.	Mark	No.	Description	Part No.
------	-----	-------------	----------	------	-----	-------------	----------

LIST OF ASSEMBLIES

NSP	MOTHER UNIT	RWM1662
NSP	└ REGULATOR A UNIT	RWZ3113
NSP	└ REGULATOR B UNIT	RWZ3114
	└ MAIN UNIT	RWZ3251
	└ VERTICAL UNIT	RWZ3116

NSP	MECHA UNIT	RWZ3103
-----	------------	---------

• FOR HE MODEL

NSP	SUB UNIT	RWM1708
NSP	└ OPERATE UNIT	RWZ3098
NSP	└ FL UNIT	RWZ3099
NSP	└ TR1 UNIT	RWZ3253 *
NSP	└ TR2 UNIT	RWZ3259
	└ AC OUTLET UNIT	RWZ3102

• FOR HB MODEL

NSP	SUB UNIT	RWM1707
NSP	└ OPERATE UNIT	RWZ3098
NSP	└ FL UNIT	RWZ3099
NSP	└ TR1 UNIT	RWZ3252 *
NSP	└ TR2 UNIT	RWZ3259

• FOR HEWM MODEL

NSP	SUB UNIT	RWM1709
NSP	└ OPERATE UNIT	RWZ3098
NSP	└ FL UNIT	RWZ3099
NSP	└ TR1 UNIT	RWZ3254 *
NSP	└ TR2 UNIT	RWZ3259

Note

*:Although RWZ3252, RWZ3254 and RWZ3253 are different in part number, they consist of the same components.

REGULATOR A UNIT

SEMICONDUCTORS

Δ	IC502	NJM7812FA
----------	-------	-----------

CAPACITORS

	C510	CEAS101M16
--	------	------------

REGULATOR B UNIT

SEMICONDUCTORS

Δ	IC503	NJM7812FA
----------	-------	-----------

CAPACITORS

	C511	CEAS101M16
--	------	------------

MAIN UNIT

SEMICONDUCTORS

	IC702	BA10393F
	IC731	BU2040F
	IC300, IC732	M5218AFP
	IC701	TC4050BF
	IC712	AT24C01-10PC

	IC201	HA12155NT
Δ	IC501	NJM78L05A
Δ	IC504	NJM79L12A
	IC711	PD4491A
	IC601	TA7288P

	Q305, Q502, Q505, Q607	2SA1309A
	Q601	2SC3246
	Q301, Q302, Q503, Q504	2SC3311A
	Q604, Q605	2SD1858X
	Q201, Q202, Q213, Q214	2SD2144S

	Q303, Q304	2SD2144S
	Q200, Q701	DTA114ES
	Q308, Q610-Q612	DTA114TS
	Q307	DTA124ES
	Q203-Q212, Q215-Q219, Q306	DTC114ES







	Q600, Q606, Q608, Q609, Q732	DTC114ES
	Q733	DTC114TS
	Q702, Q711-Q714, Q731	DTC124ES
Δ	D502, D508, D605	1SR35-100AVL
	D604	1SS252

	D200, D201, D301-D309	1SS254
	D311-D314, D503-D505, D512	1SS254
	D601-D603, D606-D608	1SS254
	D701-D705, D710, D712-D716	1SS254
	D600	HZS3B2

Mark	No.	Description	Part No.
△	D509		MTZJ16B
	D609		MTZJ3. 6A
	D315, D511		MTZJ5. 1B
	D610		MTZJ6. 8C
△	D510		MTZJ7. 5B
	D711		MTZJ9. 1A
△	D501		S2VB20
COILS AND FILTERS			
	F201, F202 (7KHz)		RTF1209
CAPACITORS			
	C301, C302, C305, C306		CCSQSL101J50
	C732, C733		CCSQSL101J50
	C506		CEAS010M50
	C205, C206, C307, C308, C519		CEAS100M50
	C797		CEAS100M50
	C233, C504		CEAS101M16
	C515, C517		CEAS101M50
	C520, C600		CEAS220M25
	C217, C218, C609		CEAS330M16
	C505		CENS332M25
	C300, C518, C711		CEAS470M16
	C201, C219, C220, C303, C304		CEJA010M50
	C221, C222		CEJA2R2M50
	C223-C226		CEJA4R7M50
	C227, C228, C738		CEJAR10M50
	C200, C231, C232		CEJAR47M50
	C237, C238		CFTXA103J50
	C213-C216		CFTXA104J50
	C207-C212		CFTXA222J50
	C229, C230		CFTXA223J50
	C501, C502, C521		CKCYF473Z50
	C604-C606		CKSQYB102K50
	C603, C737		CKSQYB103K50
	C736		CKSQYB104K25
	C234, C235		CKSQYB221K50
	C734		CKSQYB223K50
	C236		CKSQYB471K50
	C735		CKSQYB823K25
	C312-C314, C712-C715, C731		CKSQYF103Z50
	C311, C512-C514, C601, C602		CKSQYF473Z50
	C607, C608, C701		CKSQYF473Z50
	C503 (2200/16)		RCH1109
RESISTORS			
	R731		RA10T223J
	R715, R716		RA4T223J
	R701		RA5T223J
	R504-R506 (5. 6K)		RCN1062
	R702 (11K/22K)		RCX1020
	R613		RD1/2VMO10J
	R327, R328		RD1/6PM102J
	R612		RD1/6PM330J
	R317, R318		RD1/6PM621J
	R608		RS2LMF390J
	VR201, VR202 (22K)		RCP1046
	VR731, VR732 (220K)		RCP1049

Mark	No.	Description	Part No.
	VR601 (4. 7K)		RCP1111
	Other Resistors		RS1/10S□□□J
OTHERS			
	CN704 CONNECTOR 3P		52147-0310
	CN601 CONNECTOR 6P		52147-0610
	CN602, CN603, CN705 CONNECTOR 8P		52147-0810
	CN1010 2MM PITCH CONNECTOR		9115B-06
	CN1020 2MM PITCH CONNECTOR		9115B-08
	CN701, CN702 FFC CONNECTOR 11P		HLEM11S-1
	JA300 4P PIN JACK		RKB1001
	JA310, JA320 REMOCOON JACK		RKN1004
	PCB BINDER		VEF1040
	JA330 MINI JACK		VKN1165
	EARTH PLATE		VNF-091
	X711 (4. 19MHz)		VSS1014
VERTICAL UNIT			
SEMICONDUCTORS			
	IC101		M5220FP
	IC431		UPC1297CA
	Q431, Q433		2SA1309A
	Q405		2SB1238X
	Q401-Q403		2SC3243
	Q103, Q104, Q404, Q406, Q407		2SC3311A
	Q101, Q102		2SK373
	Q107		DTA124ES
	Q434, Q435		DTC114ES
	Q109		DTC114TS
	Q108, Q432		DTC124ES
	Q105, Q106		DTC124TS
	D401, D431		1SS252
	D101-D106, D432		1SS254
COILS AND FILTERS			
	L402		LFA121K
	L401 (1. 18MH)		RTD1022
	L431, L432 (4. 6MH)		RTD1046
	L201, L202 (10mH)		RTF1102
CAPACITORS			
	C433, C434		CCCSL101K500
	C101, C102		CCSQCH100D50
	C107, C108		CCSQCH101J50
	C444		CCSQSL101J50
	C105, C106		CEANL100M16
	C109, C110		CEANL101M10
	C113, C114, C408, C445, C446		CEAS100M50
	C406, C407		CEAS330M16
	C117, C119		CEAS470M16
	C447		CEJA4R7M50
	C203, C204		CEJAR47M50
	C441, C442		CFTXA103J50
	C111, C112, C115, C116		CFTXA223J50
	C437, C438		CFTXA223J50
	C402		CFTXA273J50
	C404, C405		CFTXA332J50
	C403		CFTXA682J50
	C243, C244		CKSQYB221K50

NOTE FOR SCHEMATIC DIAGRAMS (Type 6A)

- When ordering service parts, be sure to refer to "PARTS LIST of EXPLODED VIEWS" or "PCB PARTS LIST".
- Since these are basic circuits, some parts of them or the values of some components may be changed for improvement.
- RESISTORS:**
Unit: k: k Ω , M: M Ω , or Ω unless otherwise noted.
Rated power: 1/4W, 1/6W, 1/8W, 1/10W unless otherwise noted.
Tolerance: (F): $\pm 1\%$, (G): $\pm 2\%$, (K): $\pm 10\%$, (M): $\pm 20\%$ or $\pm 5\%$ unless otherwise noted.
- CAPACITORS:**
Unit: p: pF or μ F unless otherwise noted.
Ratings: capacitor (μ F)/ voltage (V) unless otherwise noted.
Rated voltage: 50V except for electrolytic capacitors.
- COILS:**
Unit: m: mH or μ H unless otherwise noted.
- VOLTAGE AND CURRENT:**
 or - V :
DC voltage (V) in STOP mode unless otherwise noted.
 mA or - mA :
DC current in STOP mode unless otherwise noted.
- OTHERS:**
 -  or  : Adjusting point.
 -  : Measurement point.
 - The  mark found on some component parts indicates the importance of the safety factor of the parts. Therefore, when replacing, be sure to use parts of identical designation.
- SCH-□ ON THE SCHEMATIC DIAGRAM:**
 - SCH-□ indicates the drawing number of the schematic diagram. (SCH stands for schematic diagram.)

9. SWITCHES (Underline indicates switch position):

OPERATE UNIT

- S901 :   MS
- S902 :  MS
- S903 : P - ON (POWER STANDBY/ON)
- S904 : BLE (FRAT SYSTEM)
- S905 : CD SYNCHRO
- S906 : DOLBY NR
- S907 : REV MODE
- S908 : 
- S909 : 
- S910 : 
- S911 : 
- S912 : TIMER REC - OFF - PLAY

MECHA UNIT

- S601 : OPEN
- S602 : CLOSE

FL UNIT

- S920 : COUNTER MODE
- S921 : COUNTER RESET

T-C3

Mark	No.	Description	Part No.	Mark	No.	Description	Part No.
	C435, C436		CKSQYB473K50				
	C103, C104, C439, C440		CKSQYB821K50				
	C118		CKSQYF103Z50				
	C443		CKSQYF104Z25				
	C401		CQPA682J100				
	C431, C432 (430P/500)		RCG1005				

RESISTORS

R404, R405 (5.6 Ω)	RCN1033
R409 (20 Ω)	RCN1034
R408 (560 Ω)	RCN1061
R401	RD1/6PM010J
VR101, VR102, VR431, VR432 (22K)	RCP1084
Other Resistors	RS1/10S□□□J

OTHERS

CN101 CONNECTOR	9115S-06L
CN102 CONNECTOR	9115S-08L
CN103 CONNECTOR	B2B-EH
CN100 TOP POST 3P	B3B-EH

MECHA UNIT

SWITCHES AND RELAYS

S601, S602	VSK1017
------------	---------

OPERATE UNIT

SEMICONDUCTORS

D901-D904	1SS254
-----------	--------

SWITCHES AND RELAYS

S901-S911	RSG1033
S912	RSH1041

CAPACITORS

C901	CKPUYF223Z25
------	--------------

RESISTORS

VR901 (20K)	RCV1101
Other Resistors	RD1/6PM□□□J

FL UNIT

SEMICONDUCTORS

D920, D921, D923	1SS254
D922	SEL6C10R

SWITCHES AND RELAYS

S920, S921	RSG1033
------------	---------

RESISTORS

Other Resistors	RD1/6PM□□□J
-----------------	-------------

OTHERS

CN7010, CN7020 CONNECTOR 11P	52492-1120
V920 FL TUBE	RAW1131

TR1 UNIT

This assembly has no service part.

TR2 UNIT

SEMICONDUCTORS

 IC505	ICP-N38
---	---------

4. SCHEMATIC DIAGRAM

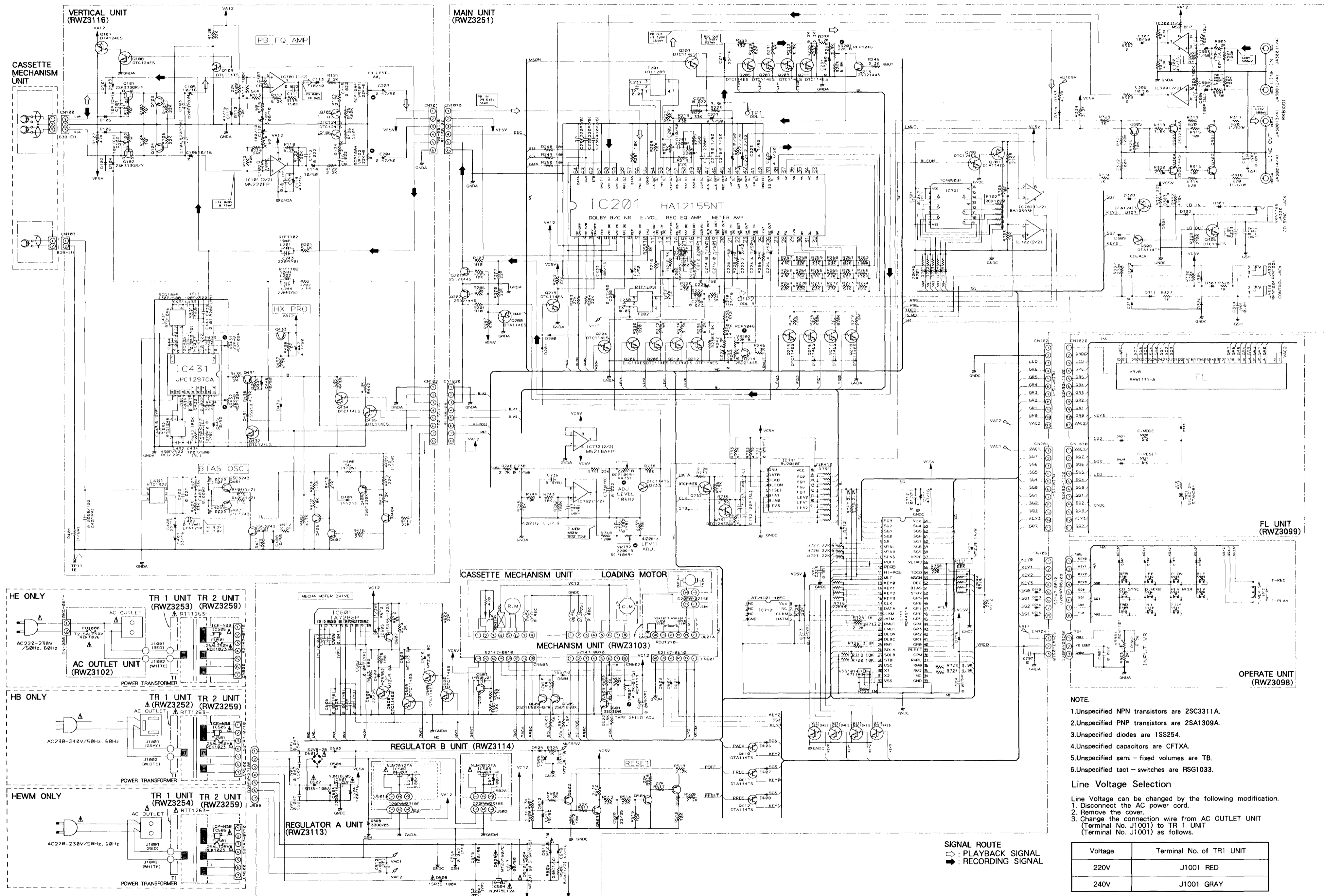

- NOTE.**
1. Unspecified NPN transistors are 2SC3311A.
 2. Unspecified PNP transistors are 2SA1309A.
 3. Unspecified diodes are 1SS254.
 4. Unspecified capacitors are CFTXA.
 5. Unspecified semi-fixed volumes are TB.
 6. Unspecified tact-switches are RSG1033.
- Line Voltage Selection**

Line Voltage can be changed by the following modification.

1. Disconnect the AC power cord.
2. Remove the cover.
3. Change the connection wire from AC OUTLET UNIT (Terminal No. J1001) to TR 1 UNIT (Terminal No. J1001) as follows.

Voltage	Terminal No. of TR1 UNIT
220V	J1001 RED
240V	J1001 GRAY

4. Stick a line voltage label on the rear panel.
- | Part No. | Description |
|----------|-------------|
| AAX-193 | 220V label |
| AAX-192 | 240V label |

SIGNAL ROUTE
 □ : PLAYBACK SIGNAL
 ■ : RECORDING SIGNAL

5. PCB CONNECTION DIAGRAM

- This diagram is viewed from the pink colored foil side.
- This PCB is double sided.

NOTE FOR PCB DIAGRAMS:
 1. Part numbers in PCB diagrams match those in the schematic diagrams.
 2. A comparison between the main parts of PCB and schematic diagrams is shown below.

Symbol in PCB Diagrams	Symbol in Schematic Diagrams	Part Name
		Transistor
		Diode
		Capacitor (Polarized)

3. The transistor terminal marked with E or shows the emitter.
 4. The diode terminal marked with or shows cathode side.
 5. The capacitor terminal marked with or shows negative terminal.

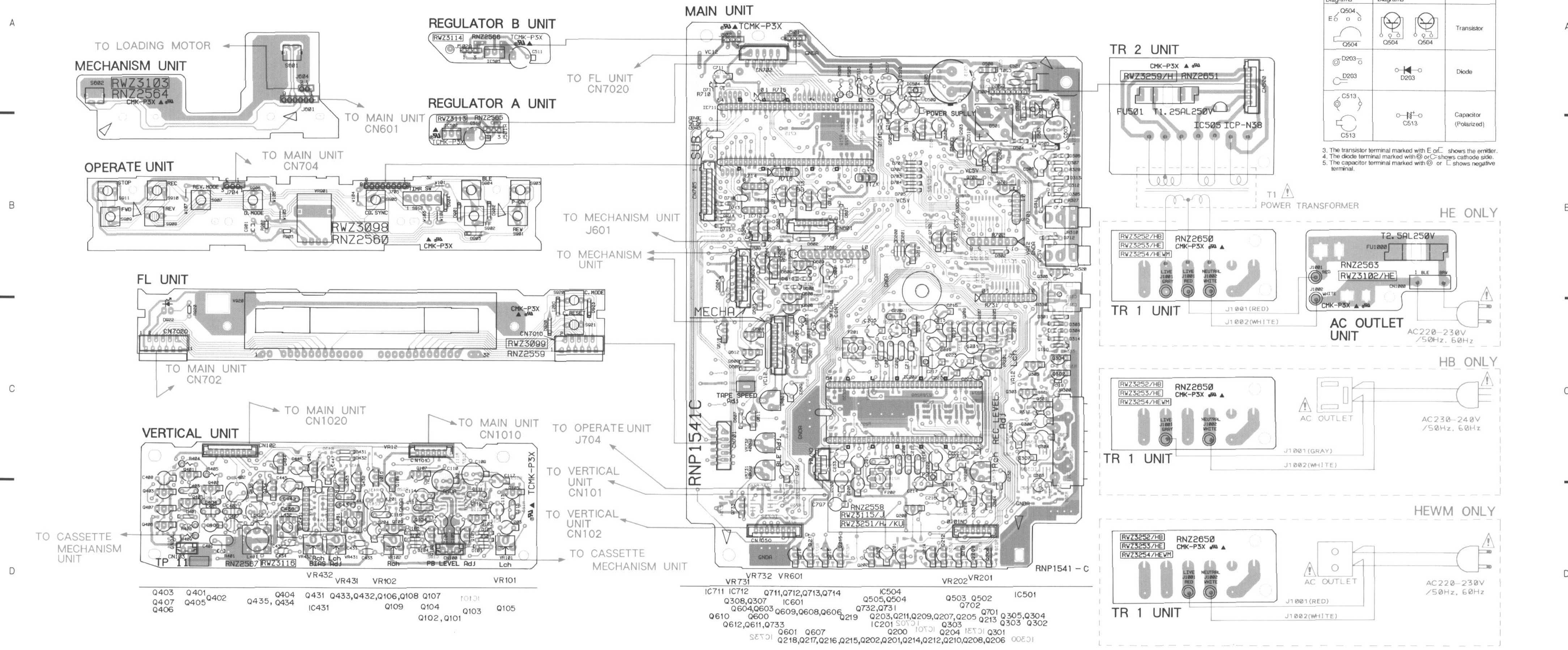

- This diagram is viewed from the gray colored foil side.
- This PCB is double sided.

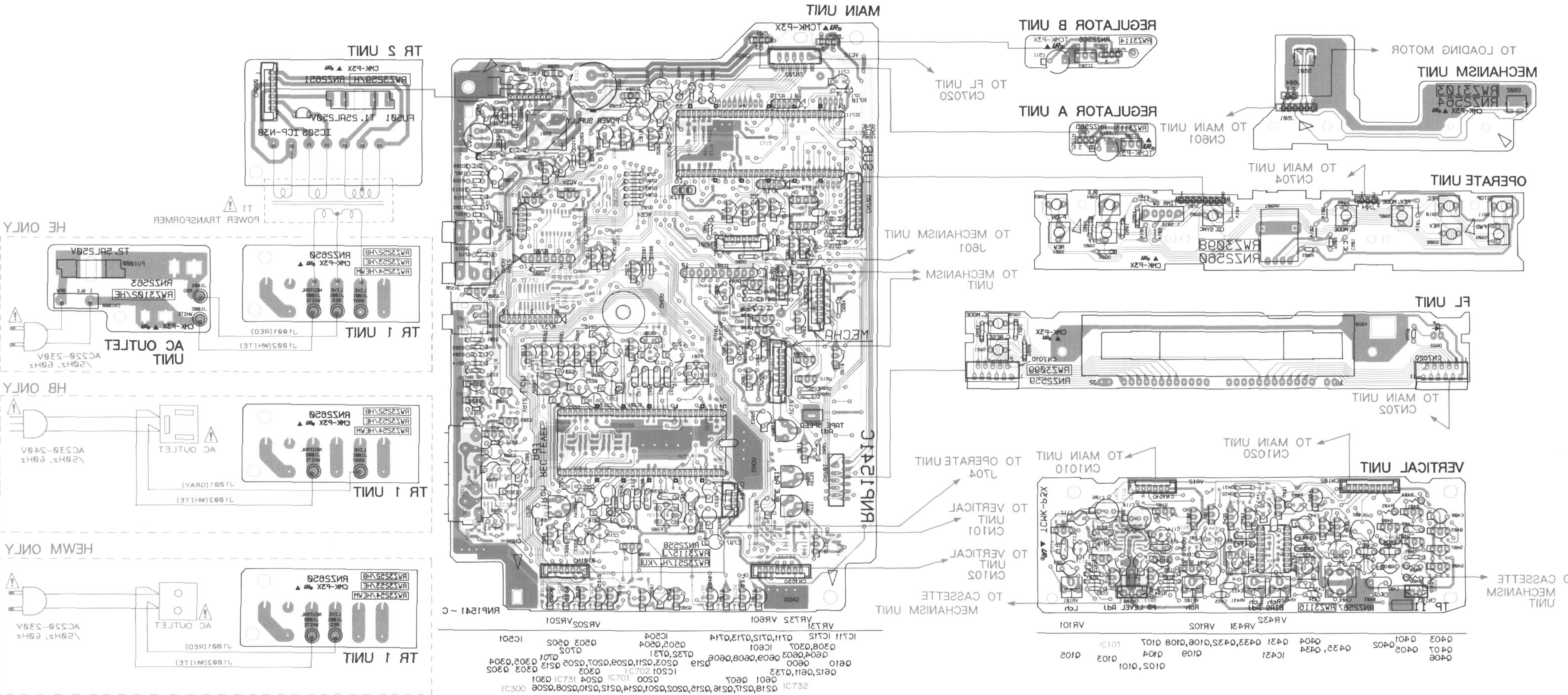

6. ADJUSTMENTS

6.1 ELECTRICAL ADJUSTMENTS

Adjustment Conditions

1. The mechanical adjustments must be completed first.
2. The head must be cleaned and demagnetized.
3. Turn power on allow the deck to warm up for at least a few minutes before commencing any electrical adjustments.
4. The reference signal is 0 dBV=1 Vrms.
5. Connect a 10 kΩ load resistance to the OUTPUT terminals.
6. Unless otherwise specified, leave the DOLBY NR switch off.

Test Tapes

- STD-331E : Playback adjustments
(See Fig. 6-1)
- STD-632 : NORMAL blank tape
- STD-621 : CrO₂ blank tape
- STD-610 : METAL blank tape
- STD-301 : Tape speed adjustments

* As the reference recording level is 250 nwb/m for STD-331E, the recording level will be higher by 4 dB for STD-331B (160 nwb/m). When adjusting, pay carefull attention to the type of tape used.

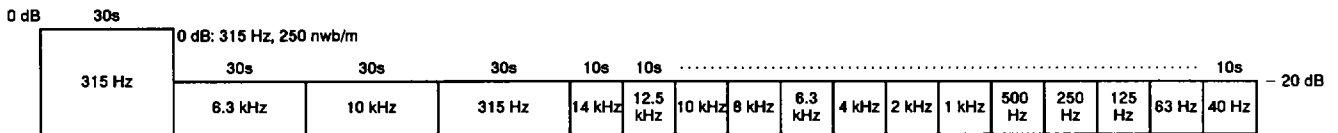

Fig. 6-1 Constants of the test tape STD-331E

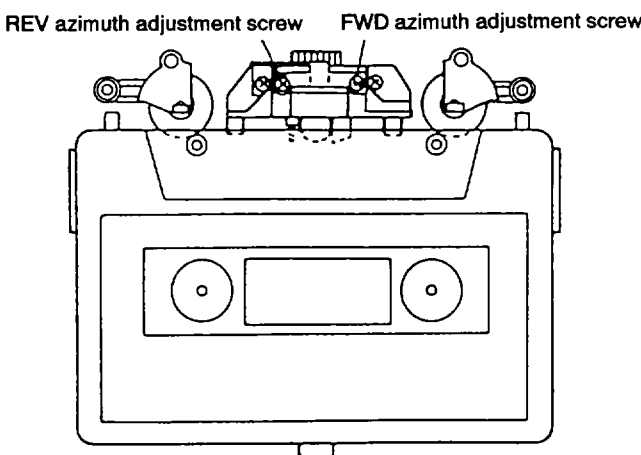

Fig. 6-2 Head azimuth adjustment

List of Adjustments

Playback sections

1. Tape speed adjustment.
2. Head azimuth adjustment.
3. Playback level adjustment.

Recording sections

1. Bias oscillator adjustment.
2. Recording bias adjustment.
3. Recording level adjustment.
4. Level meter check.
5. AUTO BLE adjustment.

NOTE: This unit has an automatic tape selection feature.

Dolby noise reduction and HX Pro headroom extension manufactured under license from Dolby Laboratories Licensing Corporation. HX Pro originated by Bang & Olufsen. "DOLBY", the double-D symbol and "HX PRO" are trademarks of Dolby Laboratories Licensing Corporation.

PLAY BACK

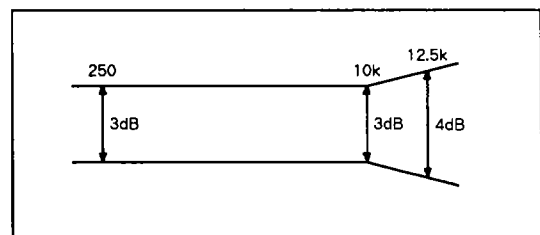

RECORDING

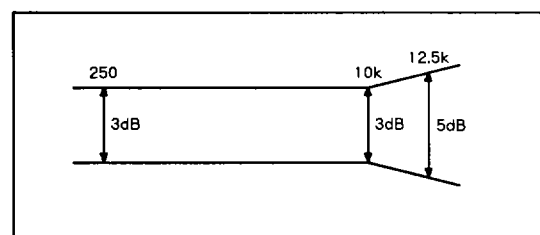

Fig. 6-3 Frequency response zone

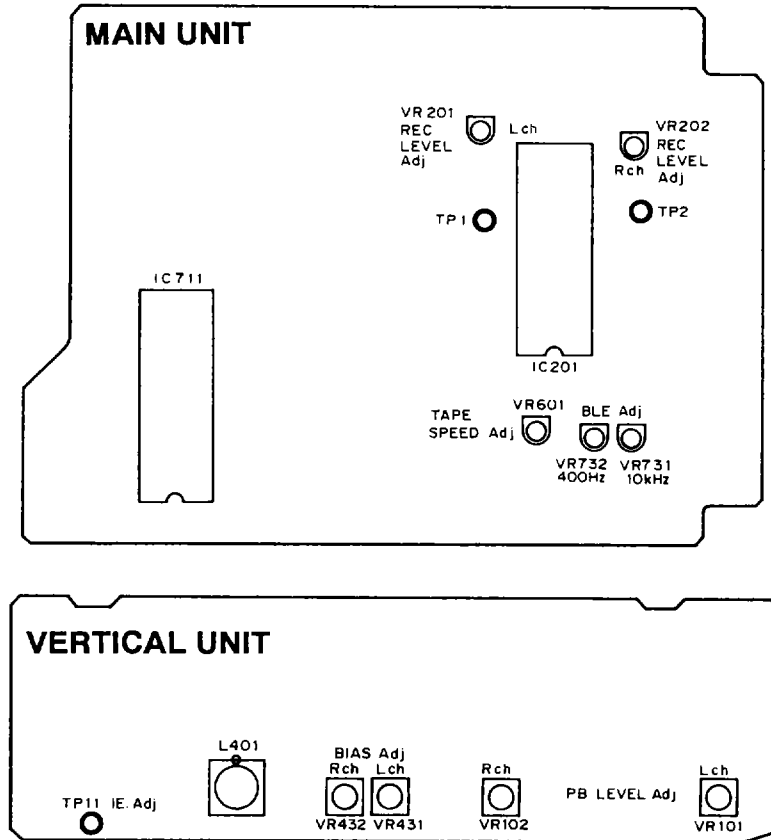

Fig. 6 - 4 Adjustment locations

PLAYBACK SECTION

1. Tape Speed Adjustment

No.	Mode	Input signal & test tape	Adjustment location	Measuring location	Adjustment value	Remarks
1.	PLAY	STD-301 (3KHz)	VR601	LINE OUT	3000Hz ± 5Hz	

2. Head Azimuth Adjustment

• Turn VR101 and VR102 to the mechanical center position.

No.	Mode	Input signal & test tape	Adjustment location	Measuring location	Adjustment value	Remarks
1.	PLAY	Play the 10 kHz/ - 20 dB section of the STD-331E test tape.	Head azimuth adjustment screw. (See Fig. 6 - 2)	LINE OUT L-R terminals	Maximum playback signal level	
2.	STOP	Fix the screw with screw - locking compound after adjusting.				

3. Playback Level Adjustment

No.	Mode	Input signal & test tape	Adjustment location	Measuring location	Adjustment value	Remarks
1.	PLAY	Play the 315 Hz/0 dB section of the STD-331E test tape.	VR101 (Lch) VR102 (Rch)	TP1 (Lch) TP2 (Rch)	- 9.0dBV	Adjust properly as this sets the dolby level.

RECORDING SECTION

1. Bias Oscillator Adjustment

No.	Mode	Input signal & test tape	Adjustment location	Measuring location	Adjustment value	Remarks
1.	REC	Load the STD-610 test tape with no input signal.	L401	TP11	105KHz ± 0.3KHz	

2. Recording Bias Adjustment

No.	Mode	Input signal & test tape	Adjustment location	Measuring location	Adjustment value	Remarks
1.	REC/ PAUSE	Apply a signal to the line input terminals from an external oscillator, adjust the oscillator so that the line output becomes 315 Hz/ - 20 dBV, and load the STD-632 (NORMAL) test tape.	_____	LINE OUT L-R terminal	_____	
2.	REC → PLAY	Record the 315 Hz and 6.3 kHz signals at the above level and playback.	VR431 (Lch) VR432 (Rch)		Repeatedly record, playback, and adjust so that the playback level of 6.3 kHz signal becomes +0 dB ± 0.5 dB when compared with the 315 Hz signal.	
3.	After adjusting, check the distortion rate and make sure it is not under bias.					

3. Recording Level Adjustment

- Turn off the DOLBY NR switch.



No.	Mode	Input signal & test tape	Adjustment location	Measuring location	Adjustment value	Remarks
1.	REC/ PAUSE	Apply a signal to the line input terminals from an external oscillator, adjust the oscillator so that the line output becomes 315 Hz/ - 4 dBV, and load the STD-632 (NORMAL) test tape.	Volume of the output level of the oscillator	TP1 (Lch) TP2 (Rch)	- 13.5dBV	
2.	REC → PLAY	Record the above signal and playback.	VR201 (Lch) VR202 (Rch)		Repeatedly record, playback, and adjust so that the playback signal level becomes - 13.5 dBV.	
3.	REC → PLAY	Record the above signal onto the STD-621 (CrO2) test tape, and playback.	Check		- 13.5dBV ± 1.5dB	
4.	REC → PLAY	Record the above signal onto the STD-610 (METAL) test tape, and playback.	Check		- 13.5dBV ± 1.0 2.0 dB	

4. Level Meter Check

No.	Mode	Input signal & test tape	Adjustment location	Measuring location	Adjustment value
1.	REC/ PAUSE	Apply a signal (315 Hz) to the line input terminals from an external oscillator, adjust the	Volume of the output level of the oscillator.	TP1 (Lch) TP2 (Rch)	Check that the "0" dB indication segment lights up when the signal level is - 9.5 dBV ± 2 dB.

5. AUTO BLE Adjustment

- Perform the auto BLE adjustment after completing all adjustments.
- Perform the auto BLE adjustment in the test mode.
- Setting the Test Mode
Turn on the power, wait for more than four seconds, and press COUNTER RESET+COUNTER+DOLBY at a time. (Stop state)
- Cancel the Test mode
Press the COUNTER RESET KEY.

No.	Mode	Input signal & test tape	Adjustment location	Measuring location	location	Adjustment value
1.		Press the FLAT key.	VR732	Level meter	 Lights up the segment as shown in the figure.	400 Hz adjustment
2.		Press the FLAT key.	VR731	Level meter	 Lights up the segment as shown in the figure.	10 kHz adjustment

7. IC INFORMATION

- The information shown in the list is basic information and may not correspond exactly to that shown in the schematic diagrams.

■ PD4491A(IC711)

● Pin Function

Pin No.	Name	I/O	Function	Pin No.	Name	I/O	Function
1	S3	O	Segment output, key scan output, level scan output terminals.	26	SOLA	O	Solenoid drive terminal A "H"=ON
2	S2	O	Segment output, key scan output, level scan output terminals.	27	SOLB	O	Solenoid drive terminal B "H"=ON
3	S1	O	Segment output, key scan output, level scan output terminals.	28	STB	O	HA2155NT serial data control terminal "H"=CLK, DATA input
4	S0	O	Segment output, key scan output, level scan output terminals.	29	OSC	O	AUTO BLE 400/10 kHz square wave output terminal
5	SR	I	System POWER ON/OFF input terminals. "H"=POWER ON	30	X1	-	Main system clock oscillation crystal/ceramics connection terminal
6	MTRL	I	Level detection input terminal Lch	31	X2	-	Main system clock oscillation crystal/ceramics connection terminal
7	MTRR	I	Level detection input terminal Rch	32	GNDC	-	GND
8	SENS	I	Sensing pulse input terminal	33	(XT1)	-	Sub system clock oscillation crystal connection terminal. Used as GND
9	POFF	I	POWER OFF input terminal "H"=Active	34	(XT2)	-	Sub system clock oscillation crystal connection terminal. Not used
10	XREM	I	Remote control input terminal "L"=Active	35	RM2	O	TA7288P control output terminal 2
11	CRO	I	Auto tape selector chrome input terminal	36	RMO	O	TA7288P control output terminal 0
12	MET	I	Auto tape selector metal input terminal	37	RMPL	O	TA7288P control output terminal. For reel motor
13	KEY0	I	Key scan input terminal	38	CPM	O	Capstan motor drive terminal "H"=ON
14	KEY1	I	Key scan input terminal	39	XRST	I	System reset input terminal "L" active
15	KEY2	I	Key scan input terminal	40	T0	O	FL display grid output terminal
16	KEY3	I	Key scan input terminal	41	T1	O	FL display grid output terminal
17	CLK	O	Output extension clock output terminal	42	T2	O	FL display grid output terminal
18	DATA	O	Output extension data output terminal	43	T3	O	FL display grid output terminal
19	CLKM	I	Memory IC clock output terminal	44	T4	O	FL display grid output terminal
20	DATAM	I, O	Memory IC data output terminal	45	T5	O	FL display grid output terminal
21	RMUT	O	Recording mute input/output terminal "H"=ON	46	T6	O	FL display grid output terminal
22	LMUT	O	Line mute output terminal "H"=ON	47	T7	O	FL display grid output terminal
23	DLON	O	DOLBY ON/OFF switching output terminal	48		-	Not used
24	DLBC	O	DOLBY B/C switching output terminal	49		-	Not used
25	RM1	O	TA7288P control output terminal 1	50	STBY	O	STANDBY display output terminal

Pin No.	Name	I/O	Function	Pin No.	Name	I/O	Function
51	BIAS	O	BIAS oscillation output terminal	58		–	Not used
52	DEC	O	DECODE/ENCODE output terminal "H"=DECODE, "L"=ENCODE	59		–	Not used
53	MSON	O	MS cutoff frequency switching output terminal	60	S7	O	Segment output, key scan output terminal
54	TOCD	O	CD SYNCHRO output terminal	61	S6	O	Segment output, key scan output terminal
55		–	Not used	62	S5	O	Segment output, key scan output terminal
56	VLOAD	–	FL controller/driver pull-down resistance connection terminal	63	S4	O	Segment output, key scan output terminal, level scan output terminal
57	VPRE	–	FL controller/driver output buffer power supply terminal	64	VC5V	–	+5V power supply terminal

■ BU2040F(IC731)

● Pin Function

Pin No.	Name	Function
1	VSS	GND
2	DATB	Microprocessor communication data input terminal
3	CLKB	Microprocessor communication clock input terminal
4	BLEON	AUTO BLE ON output terminal, "H" when BLE
5	1FSEL	AUTO BLE OSC frequency selection output terminal 1, "H" when 400 Hz
6	BIA1	AUTO BLE BIAS correction output terminal BIT 1
7	BIA0	AUTO BLE BIAS correction output terminal BIT 0
8	LEV3	AUTO BLE LEVEL correction output terminal BIT 3
9	LEV2	AUTO BLE LEVEL correction output terminal BIT 2
10	LEV1	AUTO BLE LEVEL correction output terminal BIT 1
11	LEV0	AUTO BLE LEVEL correction output terminal BIT 0
12	FQ3	AUTO BLE HIGH EQ correction output terminal BIT 3
13	FQ2	AUTO BLE HIGH EQ correction output terminal BIT 2
14	FQ1	AUTO BLE HIGH EQ correction output terminal BIT 1
15	FQ0	AUTO BLE HIGH EQ correction output terminal BIT 0
16	VDD	+5V power supply terminal

8. FL INFORMATION

■ RAW1131 (V920)

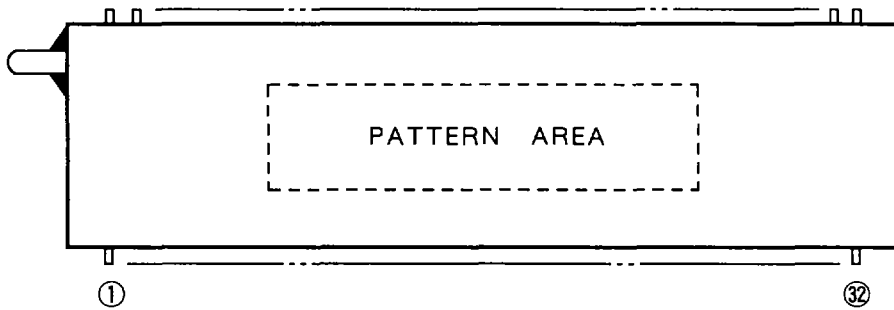

PIN CONNECTION

PIN NO.	1	2	3	4	5	6	7	8	9	10	11	12	13	14	15	16	17	18	19	20	21	22	23	24	25	26	27	28	29	30	31	32	
CONNECTION	F	F	N	P	G	G	G	G	G	G	C	C	C	C	C	C	C	C	C	C	C	4	3	2	1	5	6	7	8	P	N	F	F

- NOTE 1) F1, F2 --- Filament
 2) NP ----- No pin
 3) NC ----- No connection
 4) DL ----- Datum Line
 5) 1G~8G --- Grid

GRID ASSIGNMENT

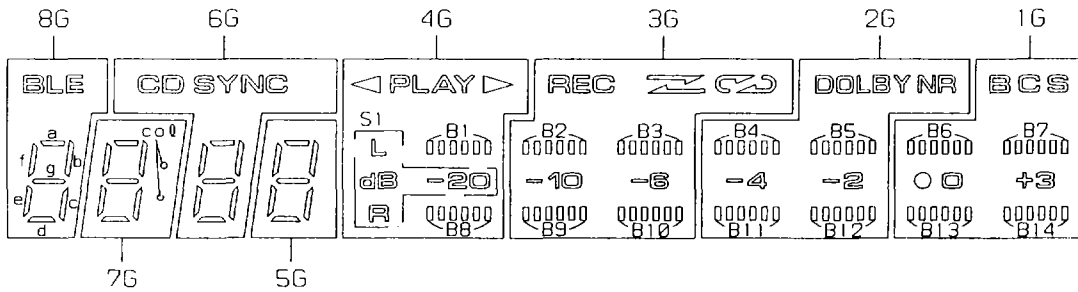

ANODE CONNECTION

	8G	7G	6G	5G	4G	3G	2G	1G
P1	a	a	a	a	B1	B2	B4	B6
P2	b	b	b	b	-	B3	B5	B7
P3	f	f	f	f	B8	B9	B11	B13
P4	g	g	g	g	-	B10	B12	B14
P5	c	c	c	c	S1	-10 -8	-4 -2	0 0 +3
P6	e	e	e	e	◀	REC	DOLBY NR	B
P7	d	d	d	d	PLAY	⏏	-	C
P8	BLE	col	CO SYNC	-	▶	⏏	-	S

9. PANEL FACILITIES

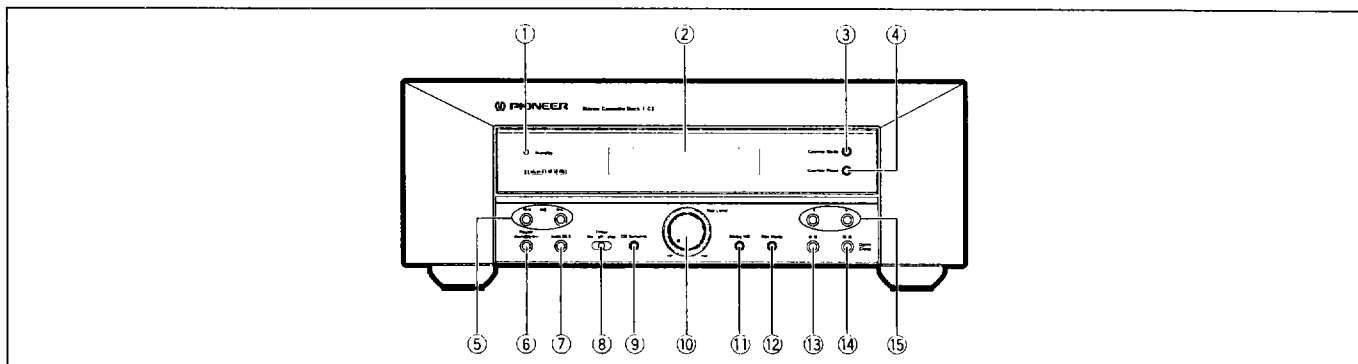

① **Standby indicator**

② **Display section**

③ **Counter Mode button**

Each time this button is pressed, the counter display mode changes.

④ **Counter Reset button**

Press this button to reset the counter; the display will change to "0000."

⑤ **Fast reverse and Fast forward buttons (MS ◀▶)**

⑥ **Power standby/on switch**

This is the switch for electric power.

on: When set to the on position, power is supplied and the unit becomes operational.

standby: When set to the standby position, the main power flow is cut and the unit is no longer fully operational. A minute flow of power feeds the unit to maintain operation readiness.

⑦ **Auto BLE button**

Press this button to automatically perform bias, recording level (sensitivity) and equalizer adjustments for your tape.

⑧ **Timer mode switch (Timer rec/off/play)**

Use to switch between timer playback and timer recording functions.

⑨ **CD Synchro button**

Use this button to perform one-touch CD playback with synchronized recording on your cassette deck.

⑩ **Rec Level control**

Use this dial to adjust the recording level.

⑪ **Dolby* NR selector button**

Press to select the Dolby noise reduction mode. Each time the button is pressed, the mode changes as follows:

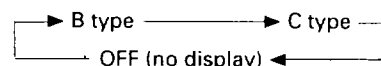

⑫ **Rev Mode button**

Use to alternate between two tape travel modes:

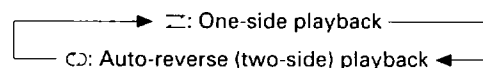

⑬ **Rec pause button (● II)**

⑭ **Open/Close button (■ ▲)**

Press to stop tape playback or eject the tape cassette.

⑮ **Play button (◀ ▶)**

*

- *Dolby noise reduction and HX Pro headroom extension manufactured under license from Dolby Laboratories Licensing Corporation. HX Pro originated by Bang & Olufsen.*
- *"DOLBY", the double-D symbol  and "HX PRO" are trademarks of Dolby Laboratories Licensing Corporation.*

10. SPECIFICATIONS

System	4-track, 2-channel stereo
Heads	"Hard Permalloy" recording/playback head x 1 "Ferrite" erasing head x 1
Motors	DC servo motor (capstan) x 1 DC reel motor x 1 DC loading motor x 1
Wow and flutter	No more than 0.07% (WRMS) No more than ± 0.19 % (DIN)
Fast winding time	Approximately 90 seconds (C-60 tape)

Frequency response (at -20 dB recording)

TYPE I (Normal) tape.....	25 to 18,000 Hz
TYPE II (HIGH/CrO ₂) tape.....	25 to 18,000 Hz
TYPE IV (Metal) tape	25 to 21,000 Hz

Signal-to-Noise ratio

Dolby NR OFF	More than 57 dB
--------------------	-----------------

Noise reduction effect

Dolby B type NR ON	More than 10 dB (at 5 kHz)
Dolby C type NR ON	More than 19 dB (at 5 kHz)

Harmonic distortion No more than 1.0% (-4 dB)

Input (Sensitivity)

LINE (INPUT).....	100 mV (Input impedance 22 k Ω)
-------------------	---

Output (Reference level)

LINE (OUTPUT)	0.5 V (Output impedance 2.2 k Ω)
---------------------	--

Miscellaneous

Power requirements

U.K. model	AC 230 - 240 Volts, 50/60 Hz
U.S. model	AC 120 Volts, 60Hz

Power consumption

U.K. model	20 W
U.S. model	20 W

Dimensions 260 (W) x 95 (H) x 332 (D) mm
10-5/6 (W) x 3-3/4 (H) x 13-1/14 (D) in

Weight (without package) 3.4 kg (7 lb 8 oz)

Accessories

Operating instructions	1
Audio cable	2
CD-deck synchro cable.....	1
Control cable	1

Features

- Can be used with wireless remote control
- AUTO BLE tuning function
- Peak level meter with peak-hold function
- Four-digit two-mode fluorescent tape counter (elapsed time/tape counter)
- DOLBY HX PRO recording function
- DOLBY NR B/C types
- Music search over ± 15 selections
- Automatic space recording mute
- Automatic tape selectors
- Timer recording
- Timer playback
- CD-DECK SYNCHRO function
- Automatic reverse

NOTE:

Specifications and design subject to possible modifications without notice due to improvements.