

AM/FM STEREO TUNER

# TX-6700 TX-606

## SERVICE MANUAL

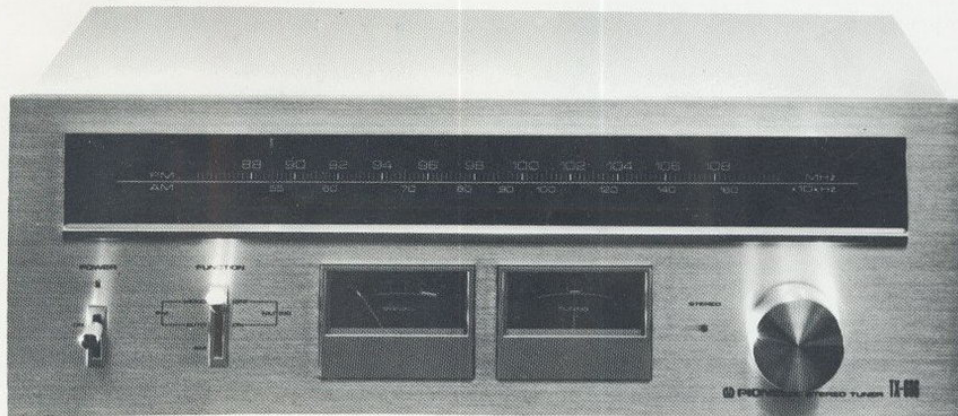

 PIONEER®

## APPEARANCE OF TRANSISTORS AND ICs

HA 1197  
PA1001-A  
PA3001-A

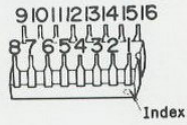

2SC535  
2SC461

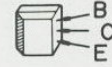

2SK61



2SC945A

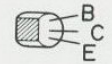

2SA725



2SC1384

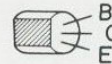

## Circuit Diagram of IC

HA1197

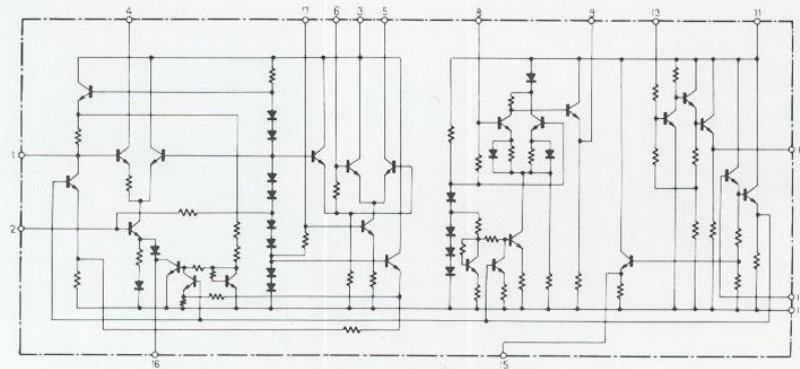

# SCHEMATIC DIAGRAM

## TUNER Ass'y GWM-110

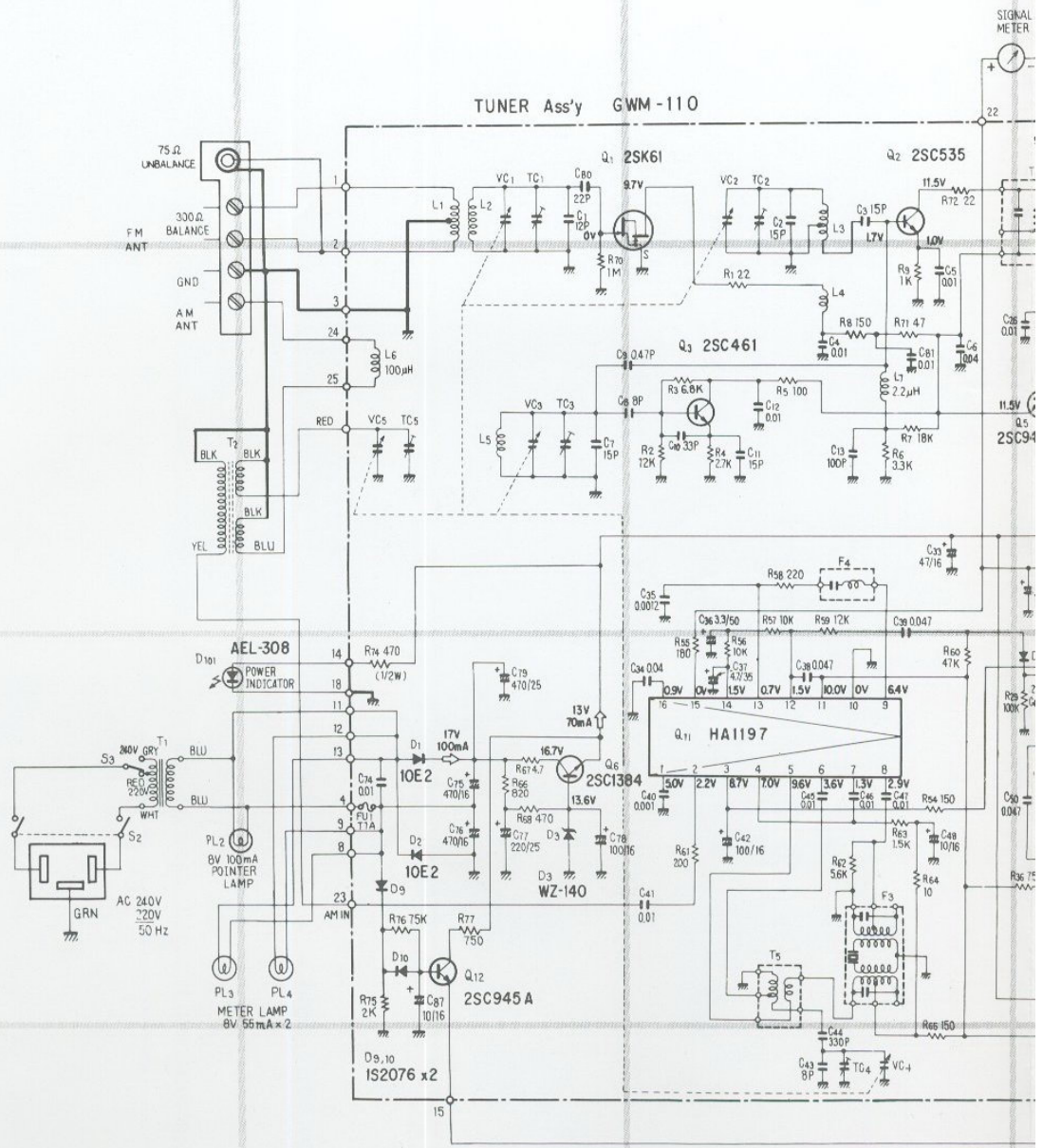

**SWITCHES**

- S<sub>1</sub>: FUNCTION
  1. FM MONO MUTING OFF
  2. FM AUTO MUTING ON
  3. AM
- S<sub>2</sub>: POWER ON - OFF
- S<sub>3</sub>: LINE VOLTAGE SELECTOR 220V - 240V

**NOTES**

- RESISTORS: IN OHM ¼W ±5% TOLERANCE UNLESS OTHERWISE NOTED K: k.Ω M: M.Ω
- CAPACITORS: IN μF UNLESS OTHERWISE NOTED
- P: pF



4

5

6

**NOTE:**

The indicated semiconductors are representative ones only. Other alternative semiconductors may be used and are listed in the parts list.

A

B

C

D

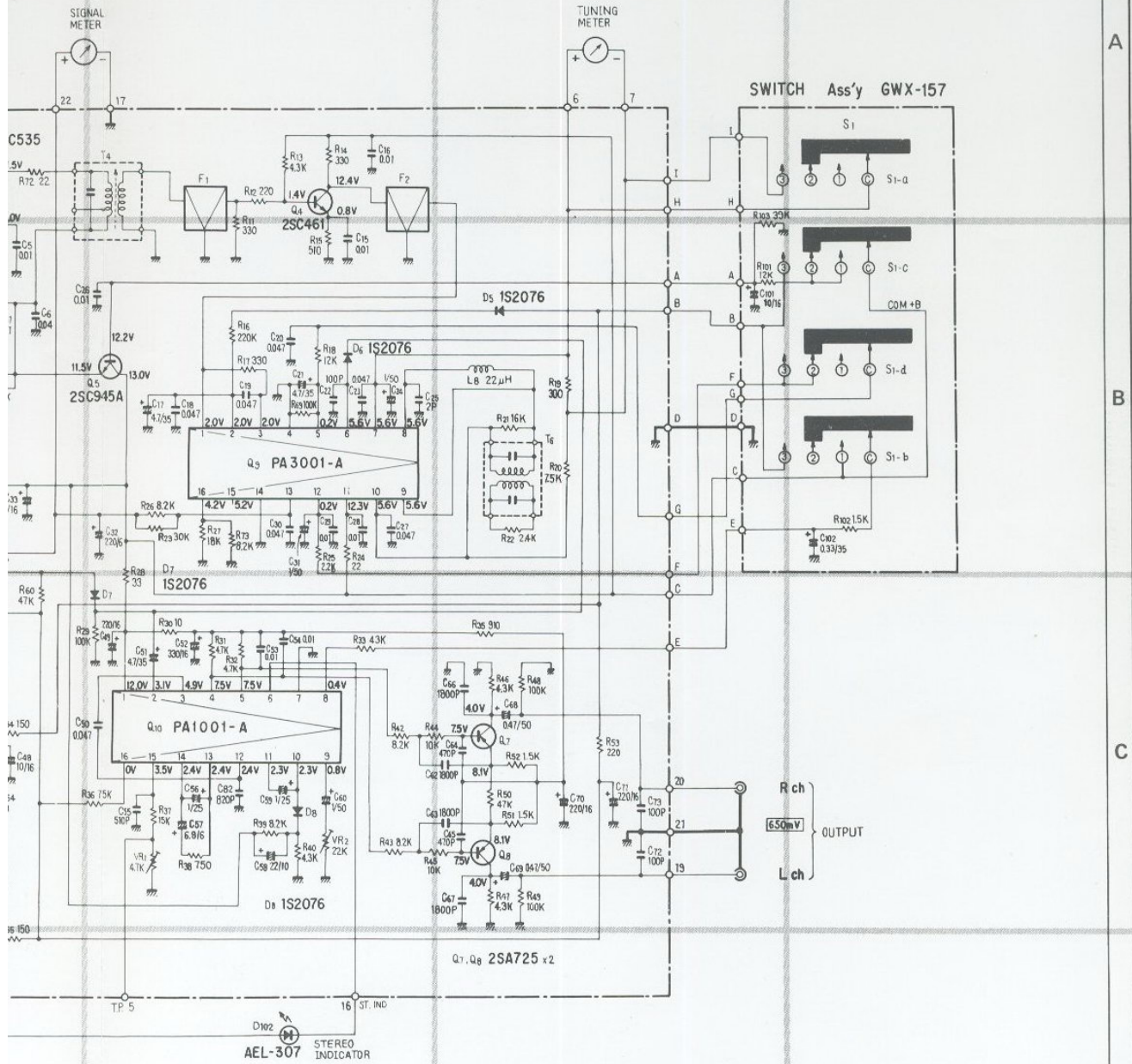

- mV : SIGNAL VOLTAGE AT 100% FM MOD (400Hz)
- mA : DC CURRENT AT NO INPUT SIGNAL
- V : DC VOLTAGE AT NO INPUT SIGNAL

This is the basic schematic diagram, but the actual circuit may vary due to improvements in design.

4

5

6

TUNER ASSEMBLY (GWM-110)

A

B

C

D

1

2

3

1

2

3

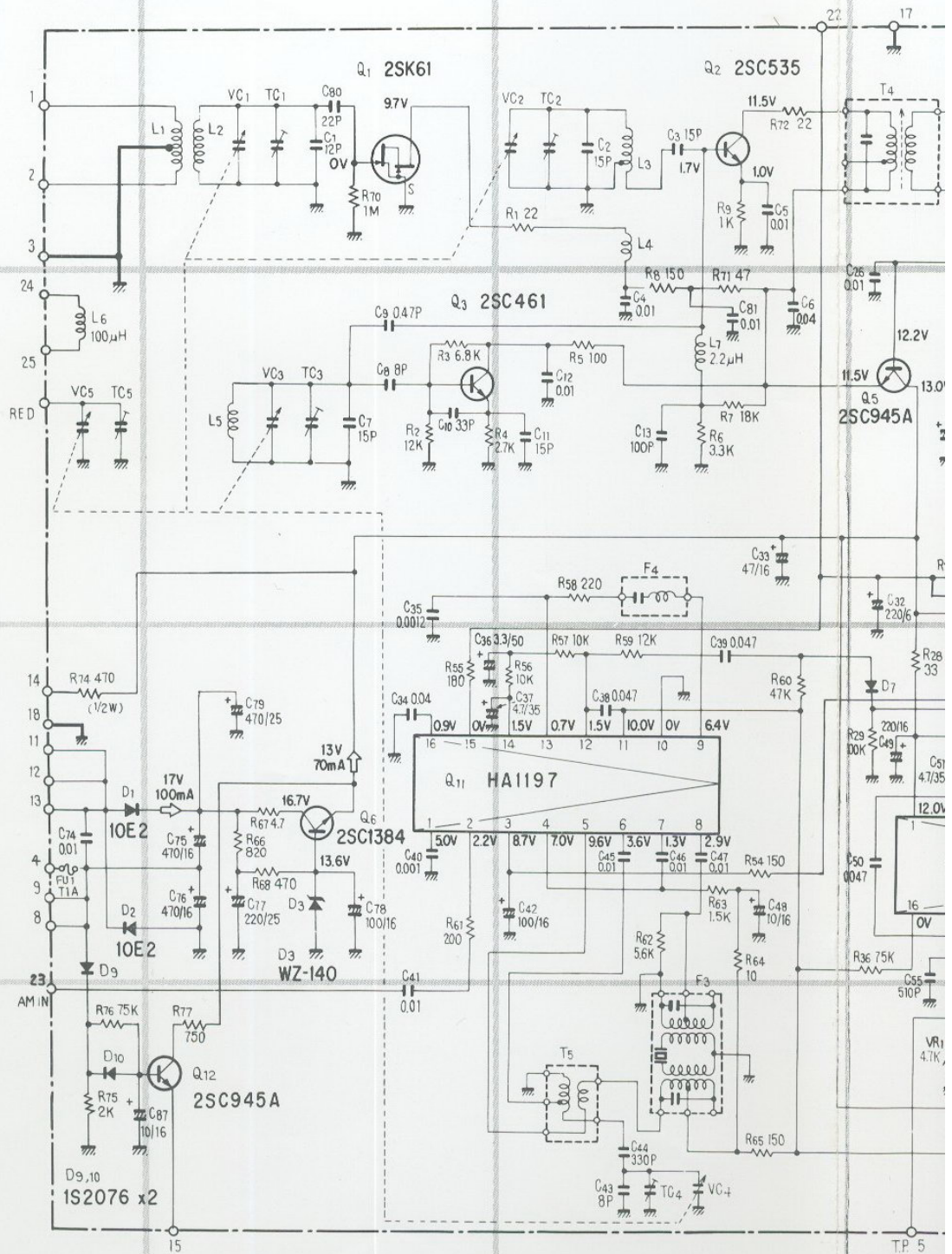

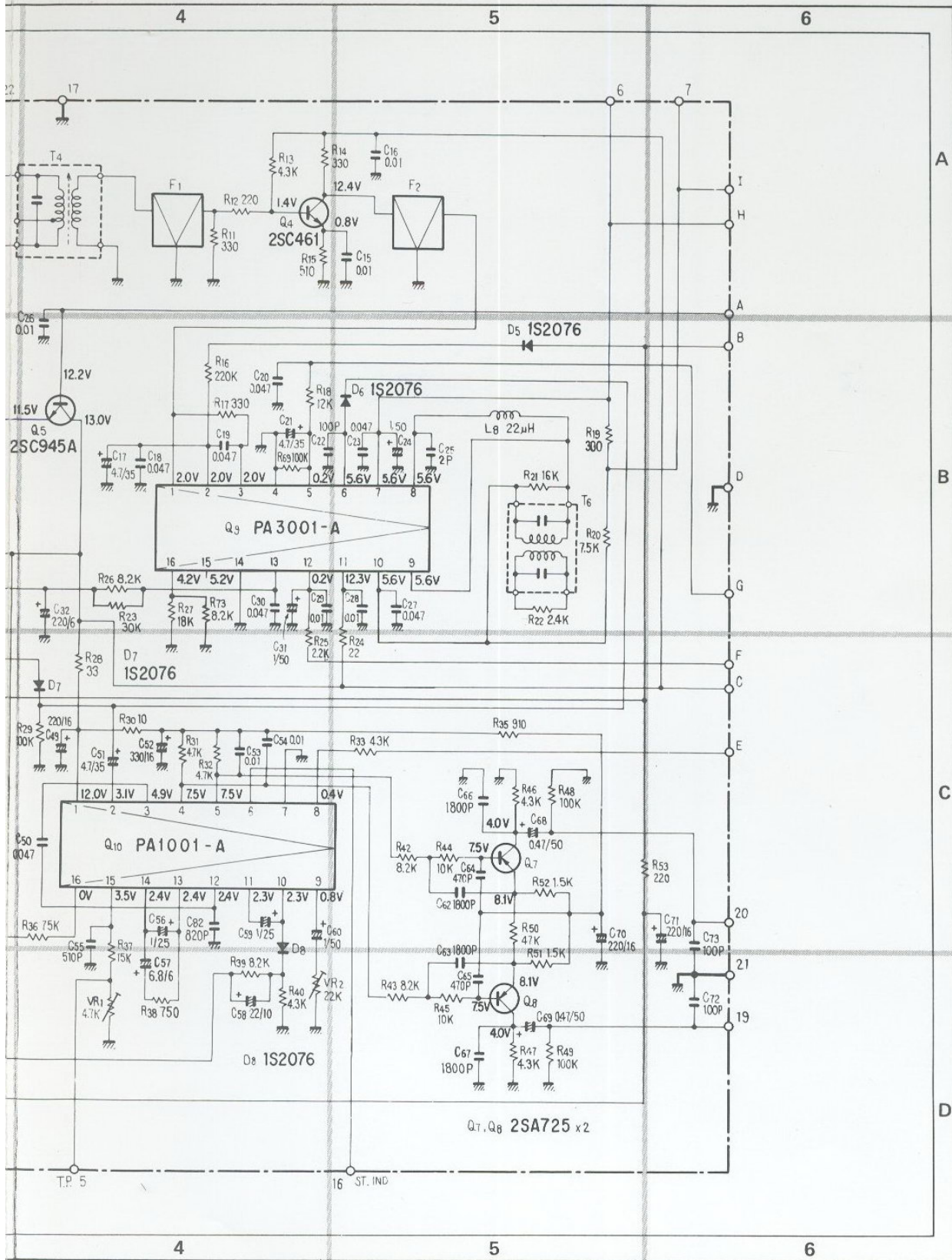

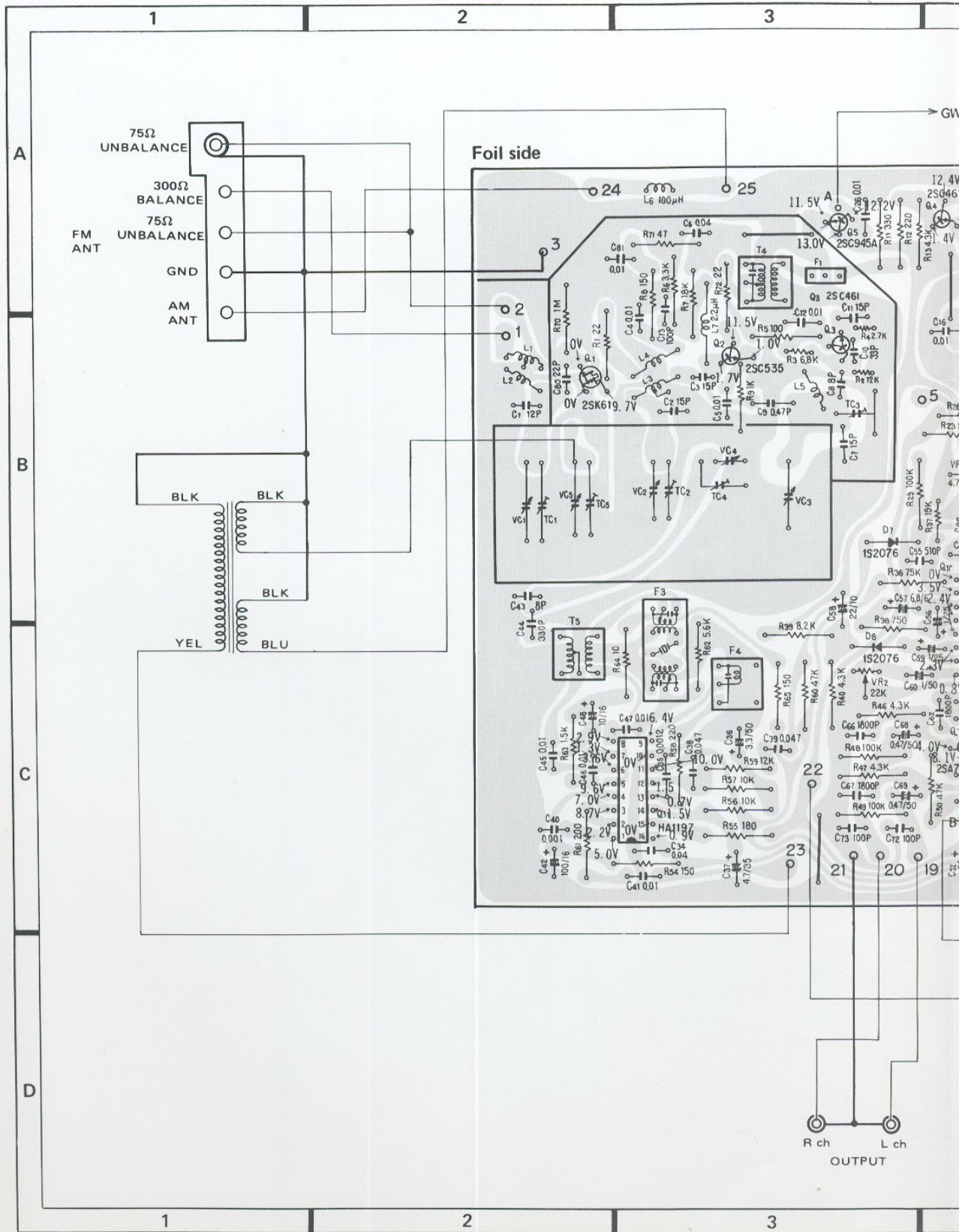

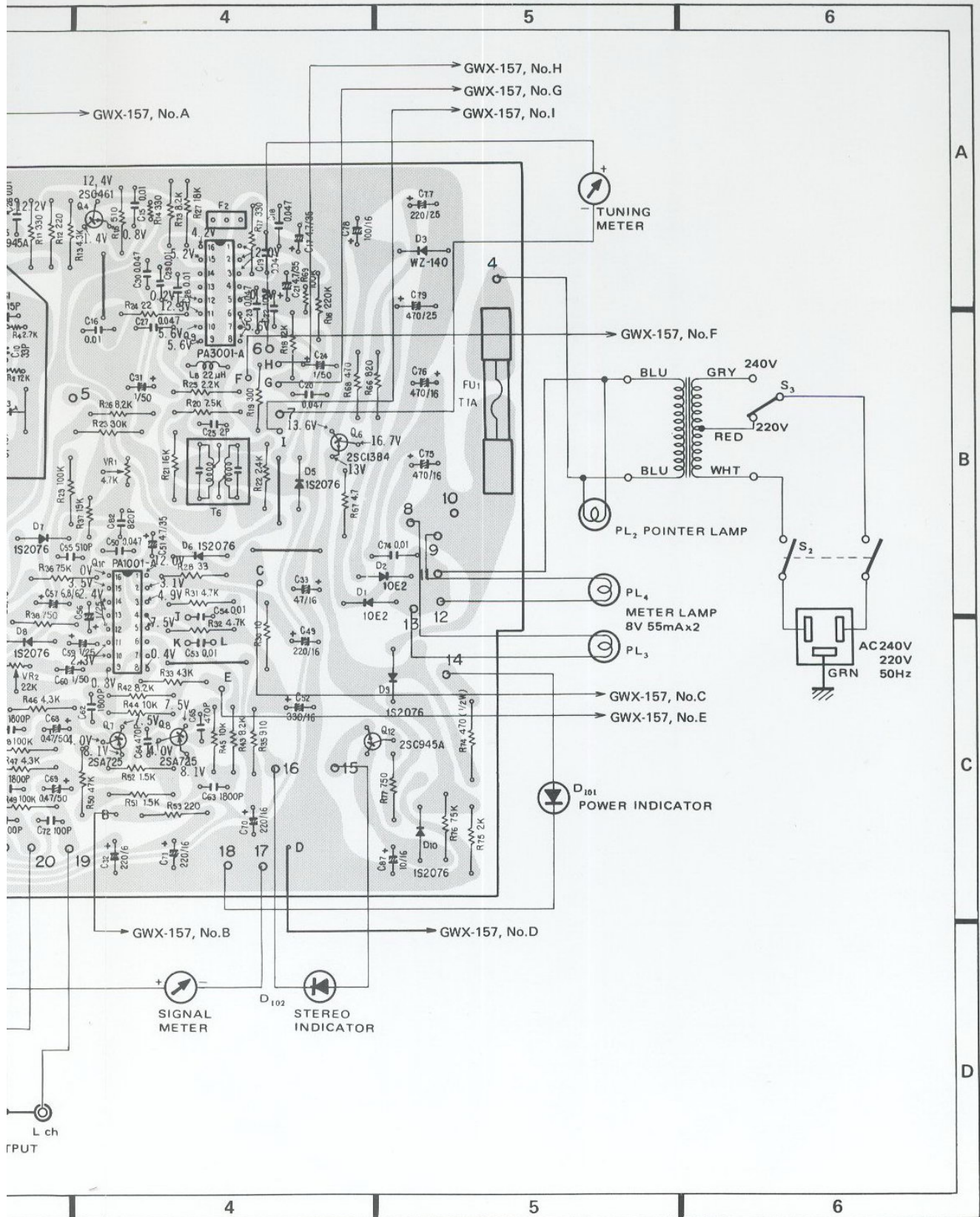



# SWITCH ASSEMBLY (GWX-157)

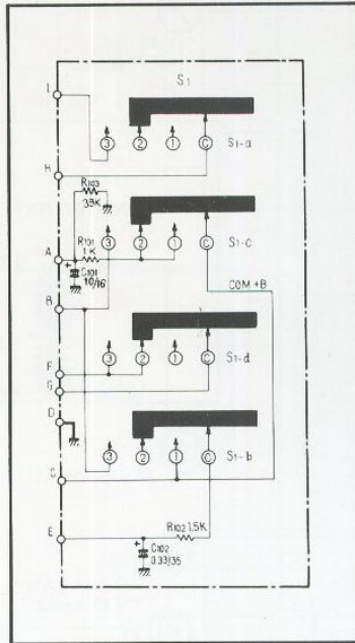

- GWM-108, No.F ←
- GWM-108, No.G ←
- GWM-108, No.H ←
- GWM-108, No.I ←
- GWM-108, No.E →
- GWM-108, No.D →
- GWM-108, No.C →
- GWM-108, No.B →
- GWM-108, No.A →

Foil side

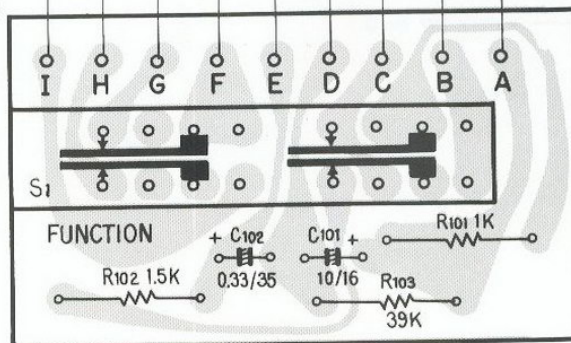

# PIONEER®-SERVICE

Telefon 04 21 / 3 16 91

Versandanschrift: Pioneer-Melchers GmbH, Flughafendamm 9, 2800 Bremen 1

**Service-Leitung**

**04 21 / 31 69 278**

**Werkstatt**

**04 21 / 31 69 279**

Reparaturen  
Reparaturhilfen

**Ersatzteile**

**04 21 / 31 69 277**

Ersatzteilbestellungen  
Technische Unterlagen

**PIONEER-Melchers**<sup>GmbH</sup>  
Service

**PIONEER-Melchers**<sup>GmbH</sup>

Schlachte 39/40, 2800 Bremen 1 Postfach 10 25 60,

**PIONEER ELECTRONIC CORPORATION**

4-1, Meguro 1-chome, Meguro-ku, TOKYO, 153, JAPAN

**PIONEER ELECTRONICS OF AMERICA**

1925E, Dominguez ST. Long Beach, Calif. 90810

**PIONEER ELECTRONIC (EUROPE) N.V.**

Luithagen-Haven 9, 2030 Antwerp, Belgium

**PIONEER ELECTRONICS AUSTRALIA PTY. LTD.**

178-184 Boundary Road, Braeside, Victoria 3195, Australia