

AM/FM STEREO TUNER

TX-6700 TX-606

SERVICE MANUAL

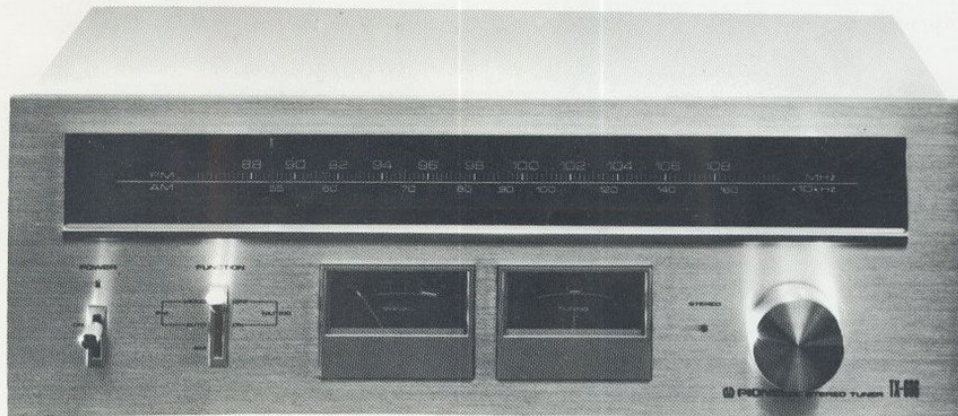

 PIONEER®

APPEARANCE OF TRANSISTORS AND ICs

HA 1197
PA1001-A
PA3001-A

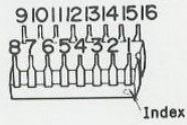

2SK61



2SA725



2SC535
2SC461

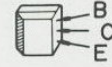

2SC945A

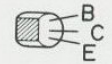

2SC1384

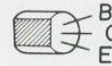

Circuit Diagram of IC

HA1197

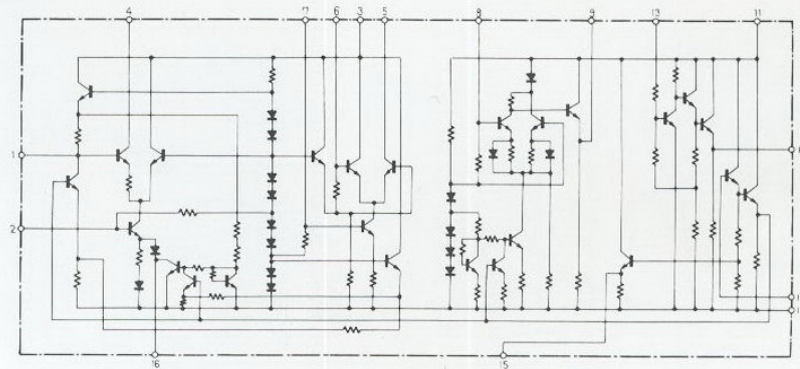

SCHEMATIC DIAGRAM

TUNER Ass'y GWM-110

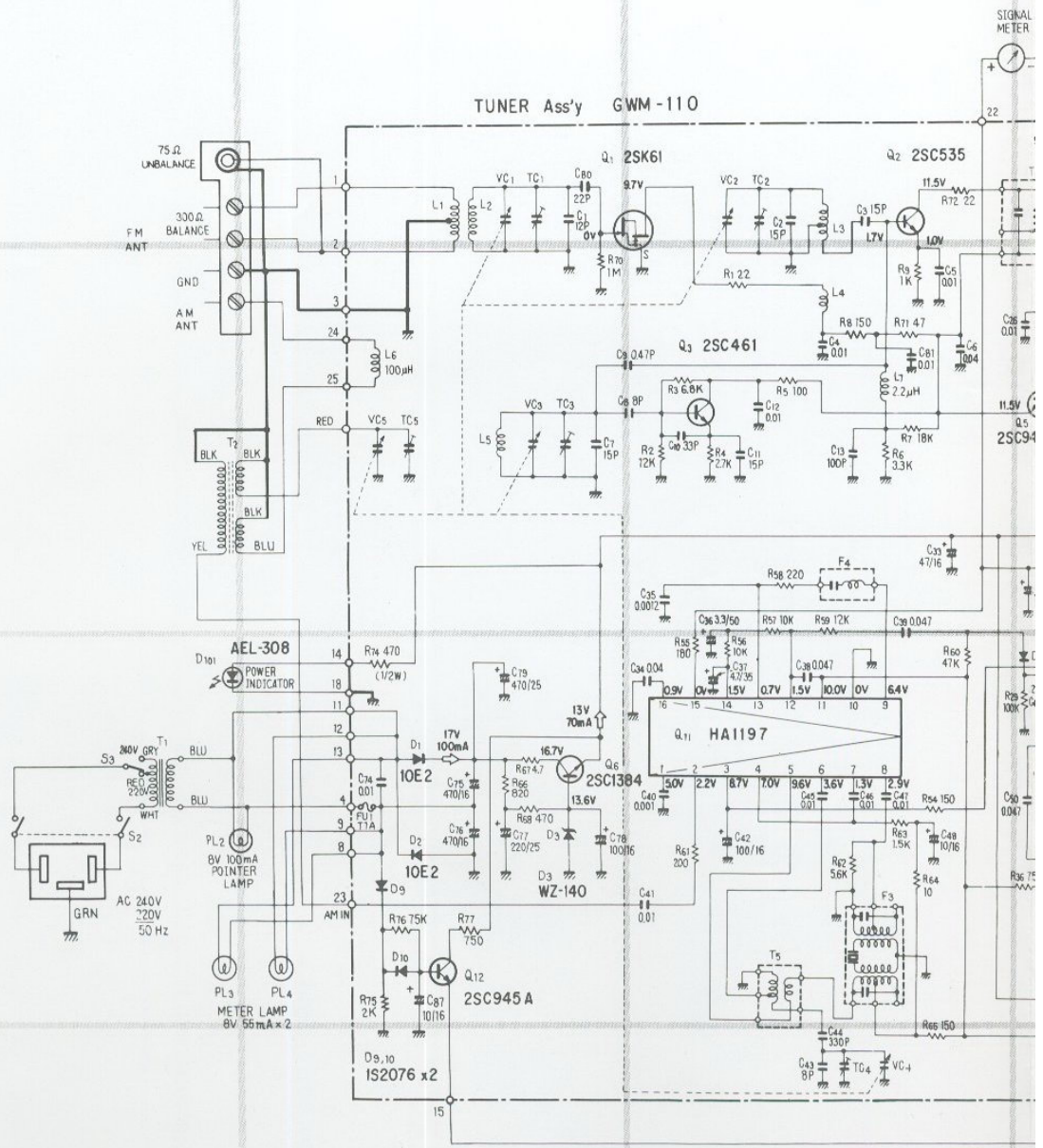

SWITCHES

- S1 : FUNCTION
 - 1. FM MONO MUTING OFF
 - 2. FM AUTO MUTING ON
 - 3. AM
- S2 : POWER ON - OFF
- S3 : LINE VOLTAGE SELECTOR 220V - 240V

NOTES

- RESISTORS : IN OHM 1/4W ±5% TOLERANCE UNLESS OTHERWISE NOTED K: k.Ω M: M.Ω
- CAPACITORS : IN μF UNLESS OTHERWISE NOTED
- P : pF



4

5

6

NOTE:

The indicated semiconductors are representative ones only. Other alternative semiconductors may be used and are listed in the parts list.

A

B

C

D

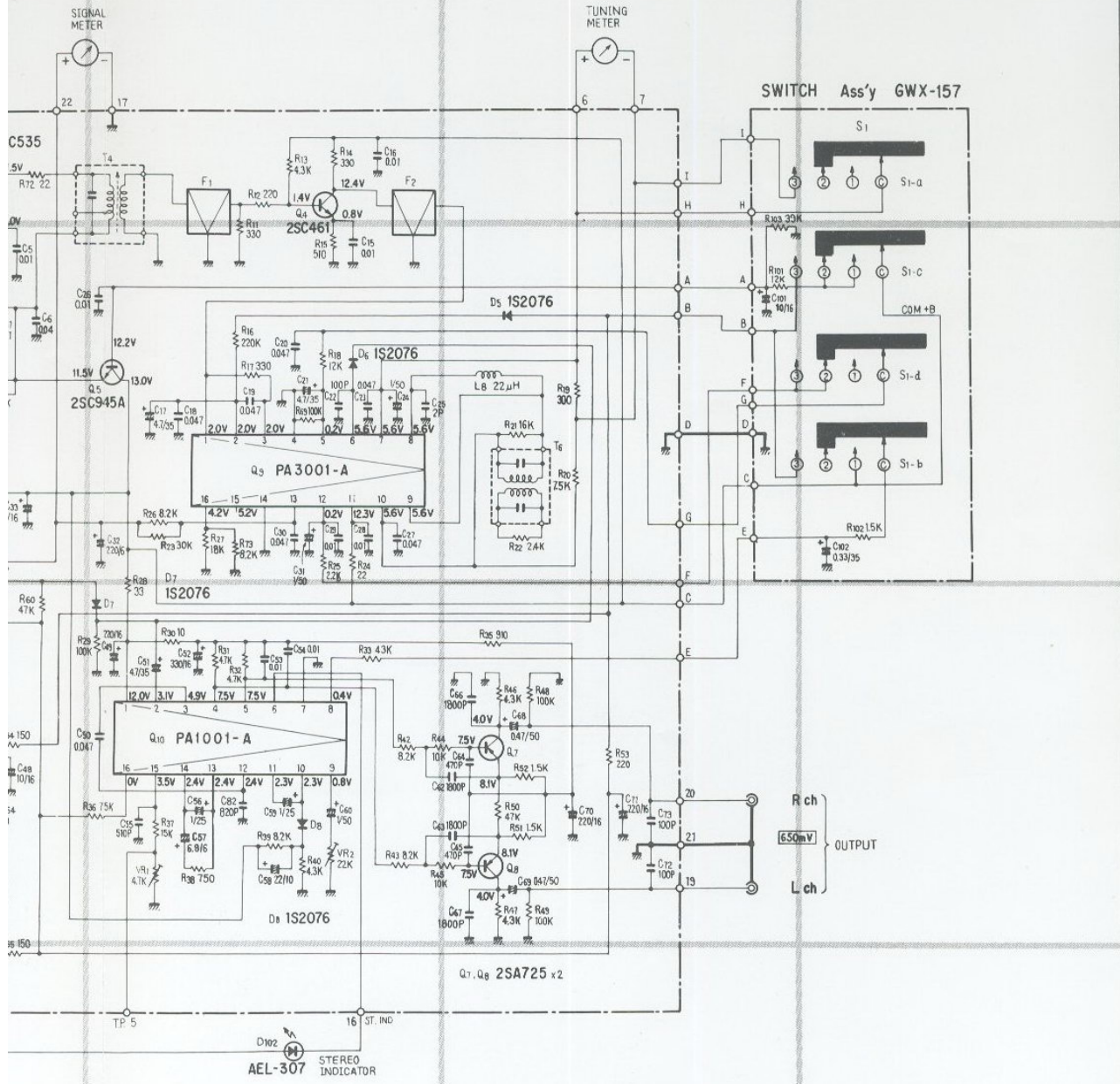

- \square mV : SIGNAL VOLTAGE AT 100% FM MOD (400Hz)
- \leftarrow mA : DC CURRENT AT NO INPUT SIGNAL
- V : DC VOLTAGE AT NO INPUT SIGNAL

This is the basic schematic diagram, but the actual circuit may vary due to improvements in design.

4

5

6

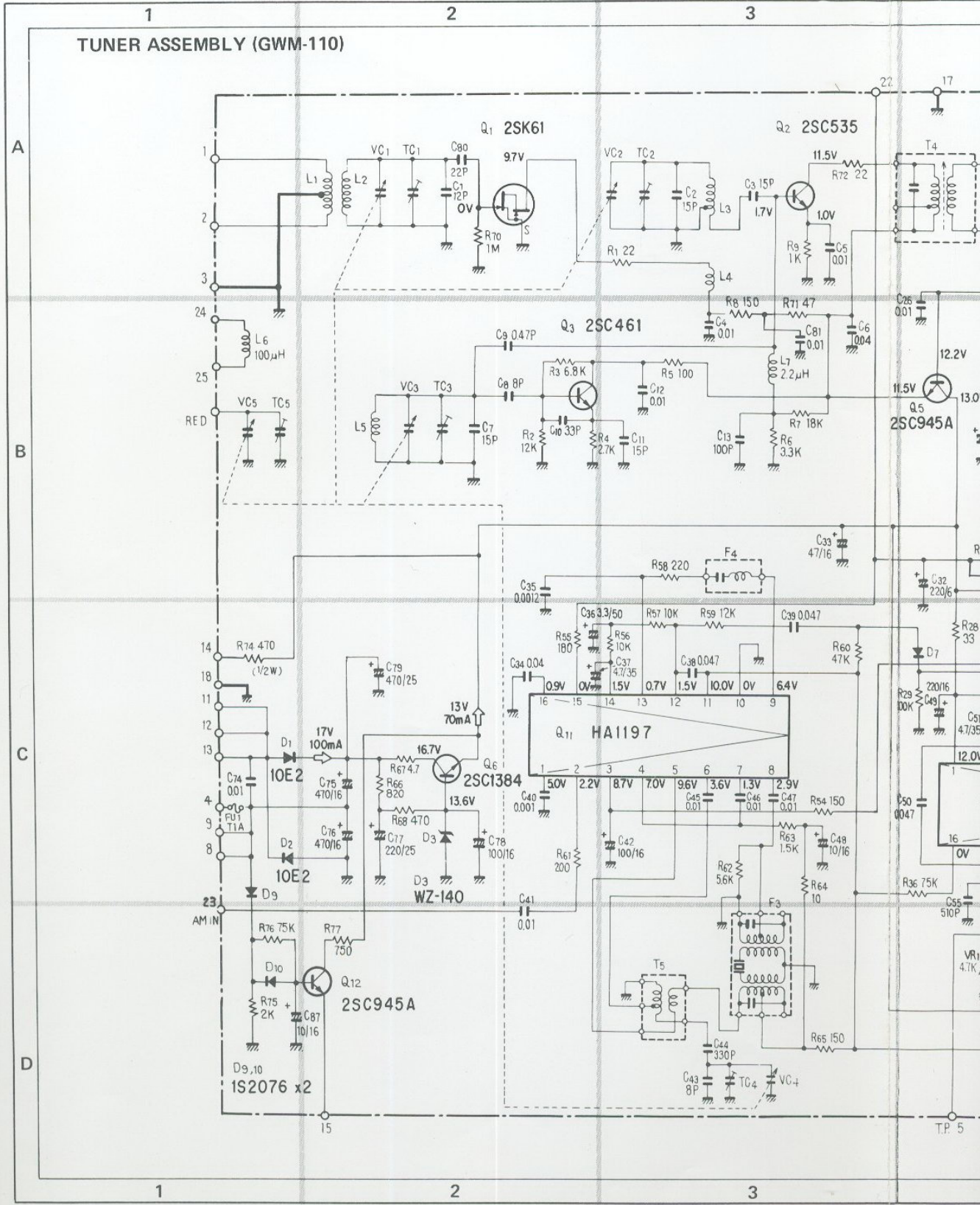

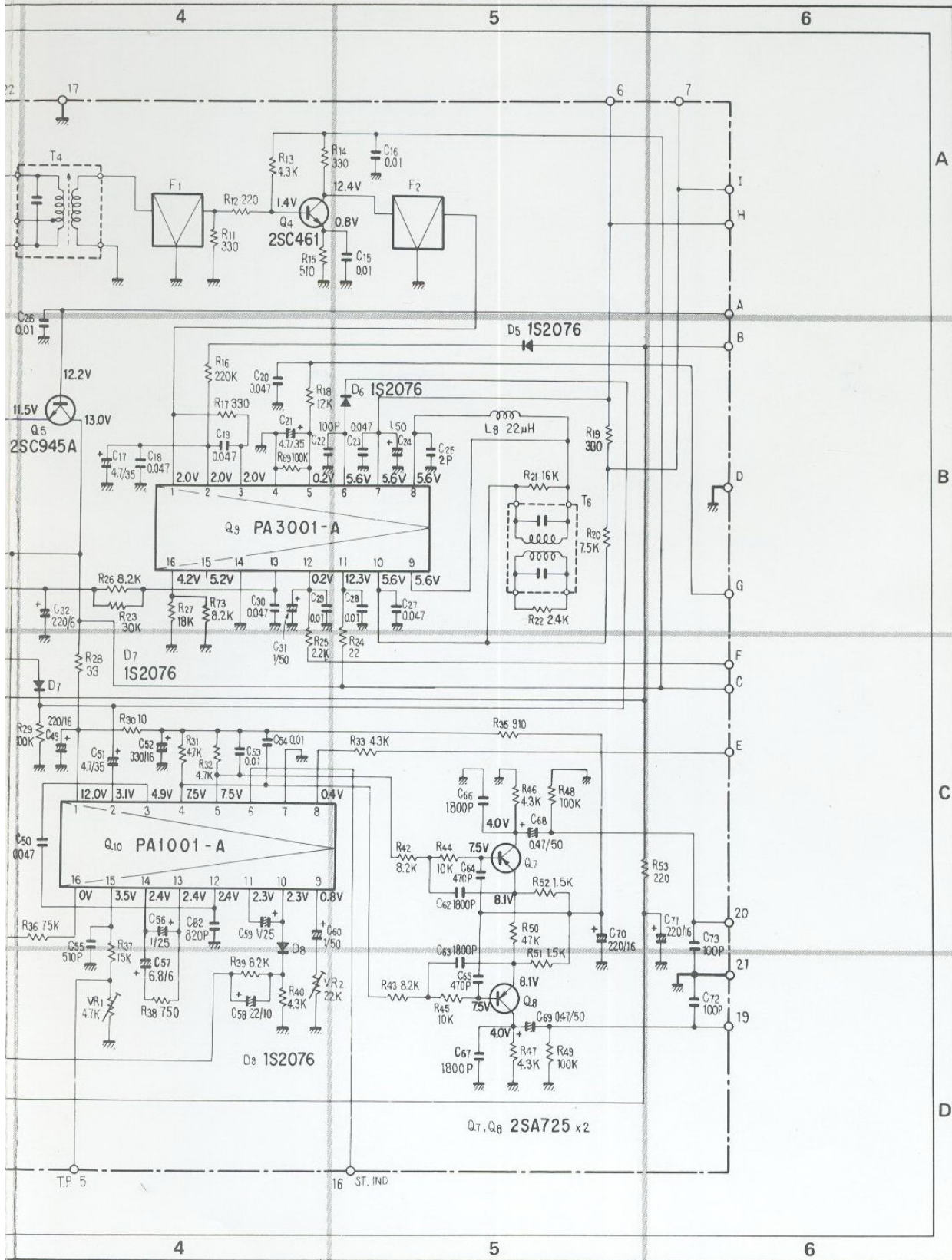

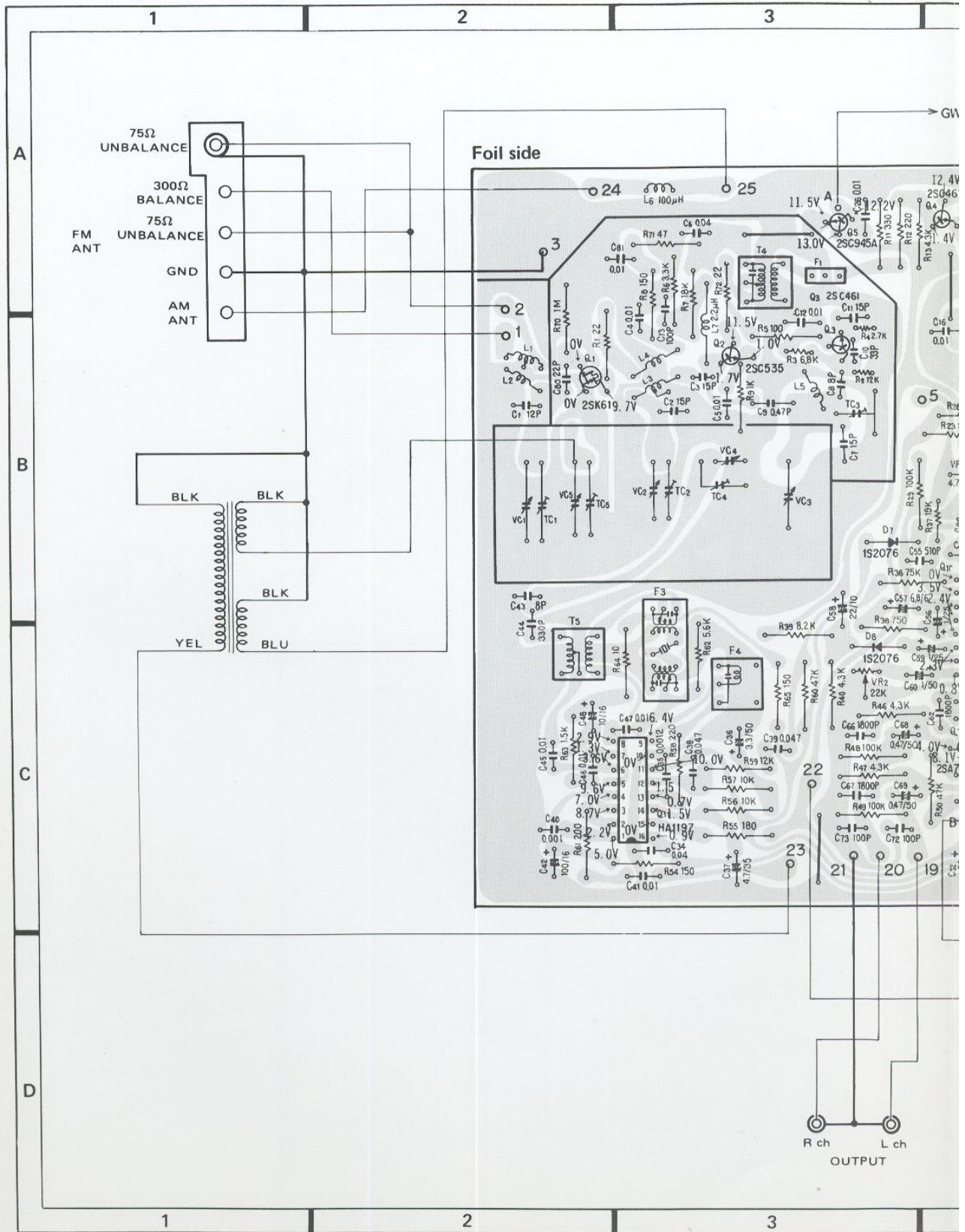

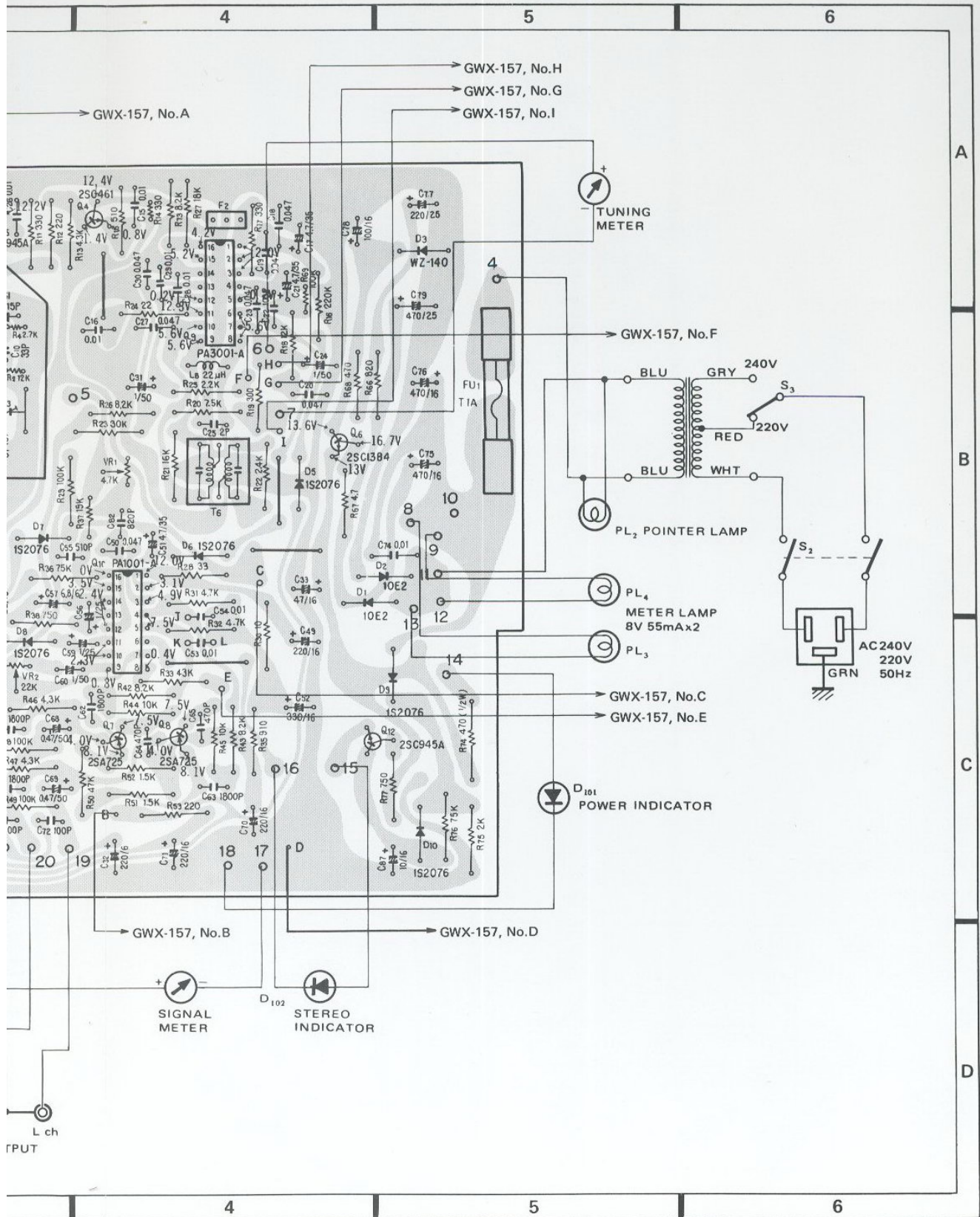

SWITCH ASSEMBLY (GWX-157)

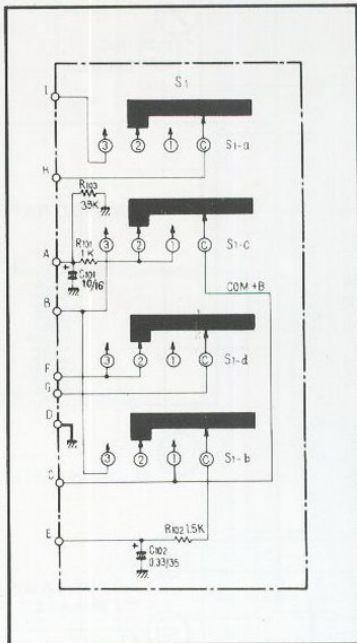

- GWM-108, No. F ←
- GWM-108, No. G ←
- GWM-108, No. H ←
- GWM-108, No. I ←
- GWM-108, No. E →
- GWM-108, No. D →
- GWM-108, No. C →
- GWM-108, No. B →
- GWM-108, No. A →

Foil side

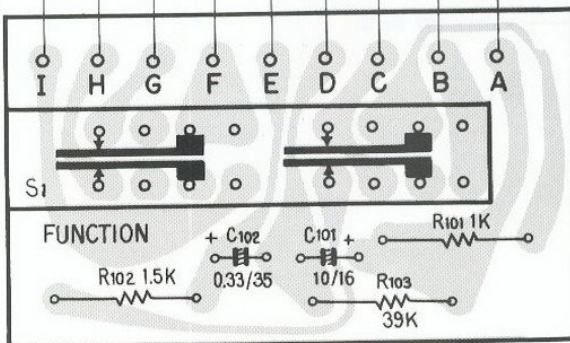

PIONEER®-SERVICE

Telefon 04 21 / 3 16 91

Versandanschrift: Pioneer-Melchers GmbH, Flughafendamm 9, 2800 Bremen 1

Service-Leitung

04 21 / 31 69 278

Werkstatt

04 21 / 31 69 279

Reparaturen
Reparaturhilfen

Ersatzteile

04 21 / 31 69 277

Ersatzteilbestellungen
Technische Unterlagen

PIONEER-Melchers^{GmbH}
Service

PIONEER-Melchers^{GmbH}

Schlachte 39/40, 2800 Bremen 1 Postfach 10 25 60,

PIONEER ELECTRONIC CORPORATION

4-1, Meguro 1-chome, Meguro-ku, TOKYO, 153, JAPAN

PIONEER ELECTRONICS OF AMERICA

1925E, Dominguez ST. Long Beach, Calif. 90810

PIONEER ELECTRONIC (EUROPE) N.V.

Luithagen-Haven 9, 2030 Antwerp, Belgium

PIONEER ELECTRONICS AUSTRALIA PTY. LTD.

178-184 Boundary Road, Braeside, Victoria 3195, Australia