

# TX-9500II

KC KU

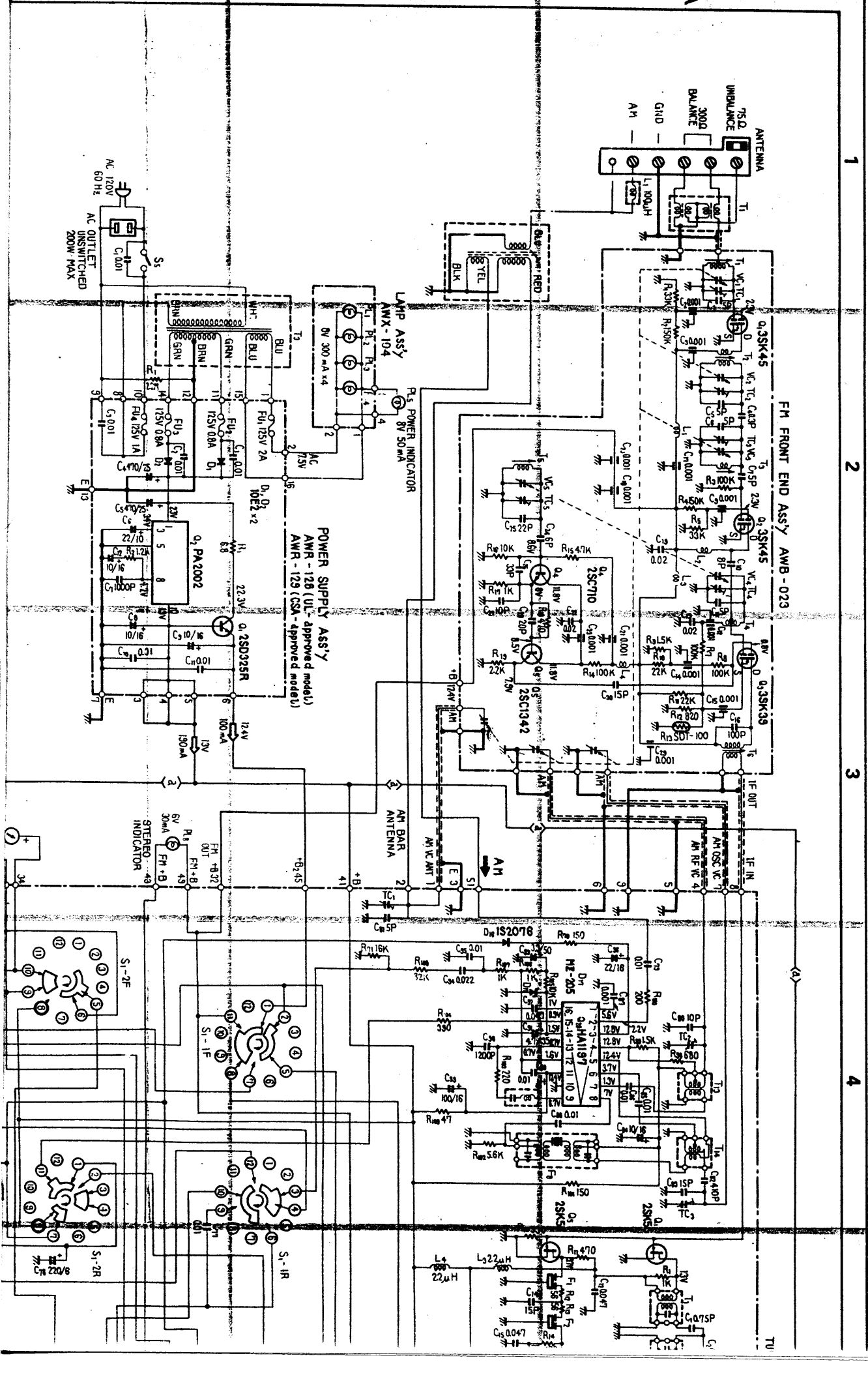

**POWER SUPPLY ASS'Y**  
AWR-128 (UL-Approved model)  
AWR-129 (CSA-Approved model)

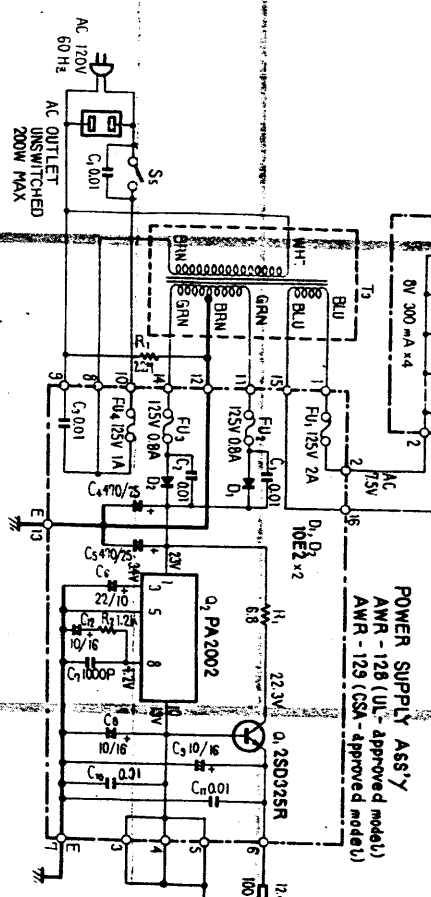

**SWITCHES**

- S1: FUNCTION
  - 1. AT
  - 2. FM AUTO
  - 3. FM IMPX NOISE FILTER
  - 4. FM IMPND
- S2: FM MUTING
  - OFF → 1 → 2
- S3: REC LEVEL CHECK
  - ON → OFF → MULTIPATH
- S4: IF BAND
  - WIDE → NARROW
- S5: POWER
  - ON → OFF
- S6: DE-EMPHASIS
  - 75 μS → 25 μS

**RESISTORS:**

IN OHM, 1/4W, ±5% TOLERANCE UNLESS OTHERWISE NOTED  
K: KΩ M: MΩ

**CAPACITORS:**

IN μF UNLESS OTHERWISE NOTED P: pF

**NOTES:**

- ↔ : DC CURRENT AT NO INPUT SIGNAL
- ( V ) : DC VOLTAGE AT NO INPUT SIGNAL
- : SIGNAL VOLTAGE AT FM, 400Hz, 75kHz DEV.
- DC VOLTAGE AT NO INPUT SIGNAL
- V : AT WIDE
- ( V ) : AT NARROW

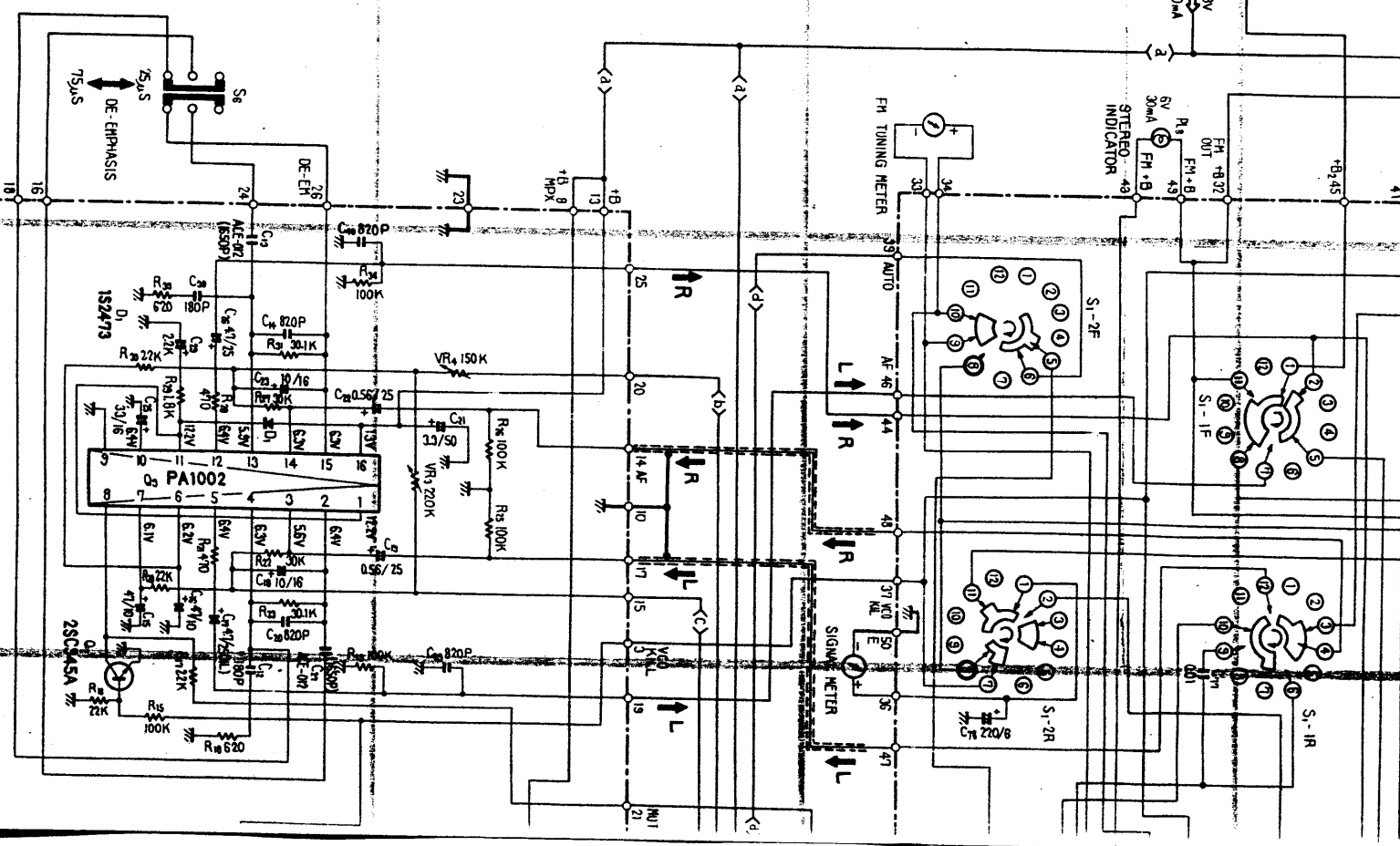

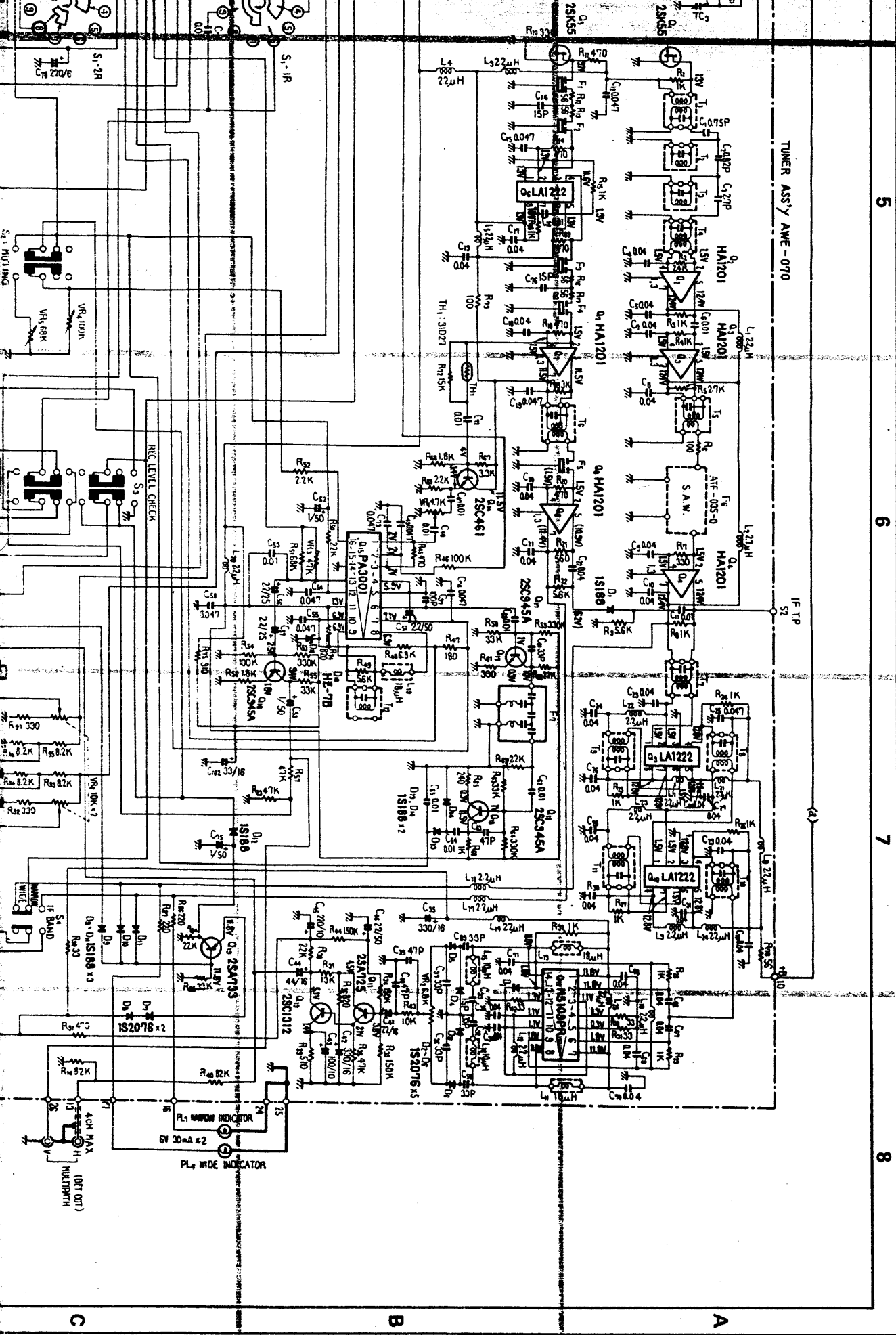

5

6

7

8

TUNER ASS'Y AWE-070

IF TP

(A)

A

B

C

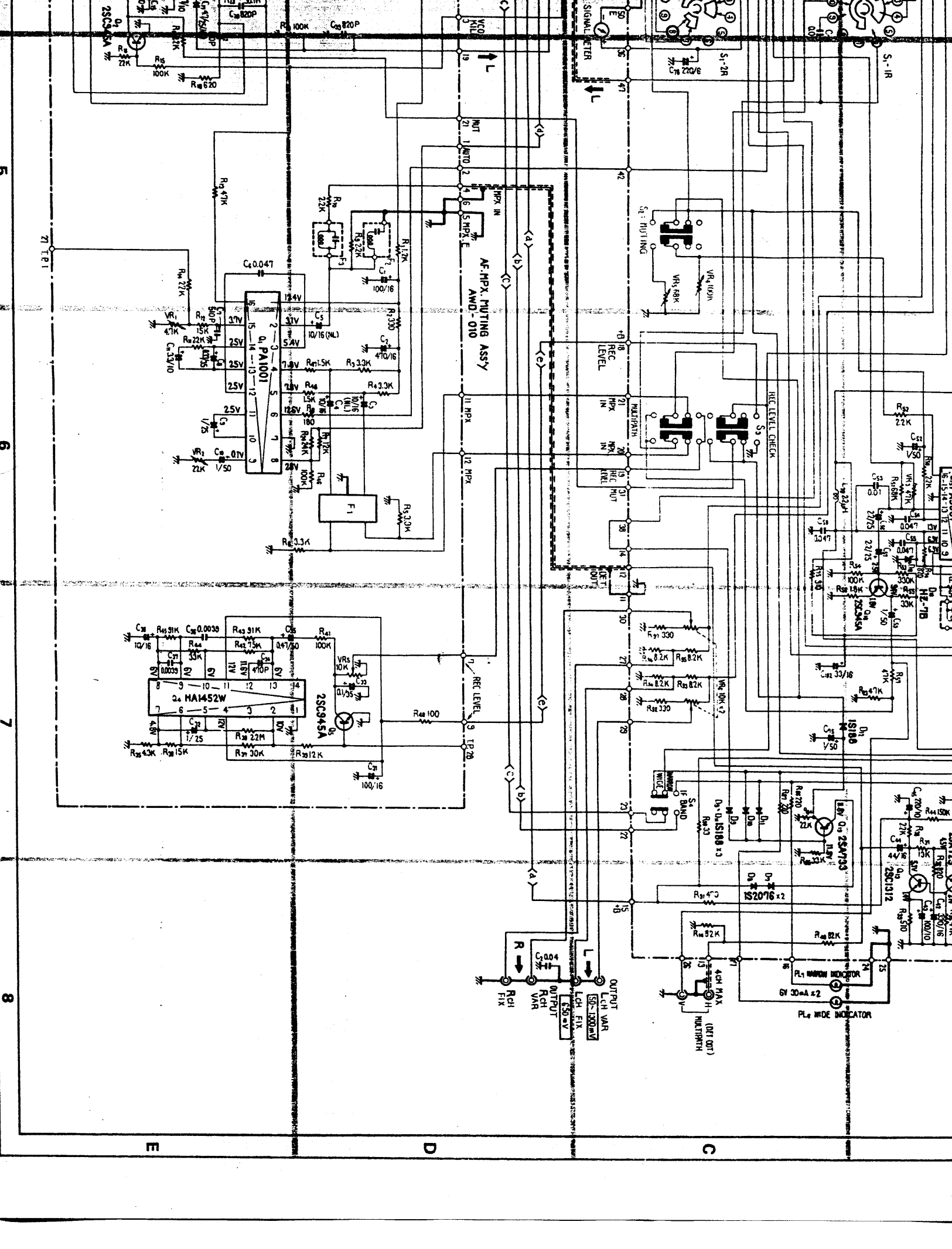

Z1 TP1

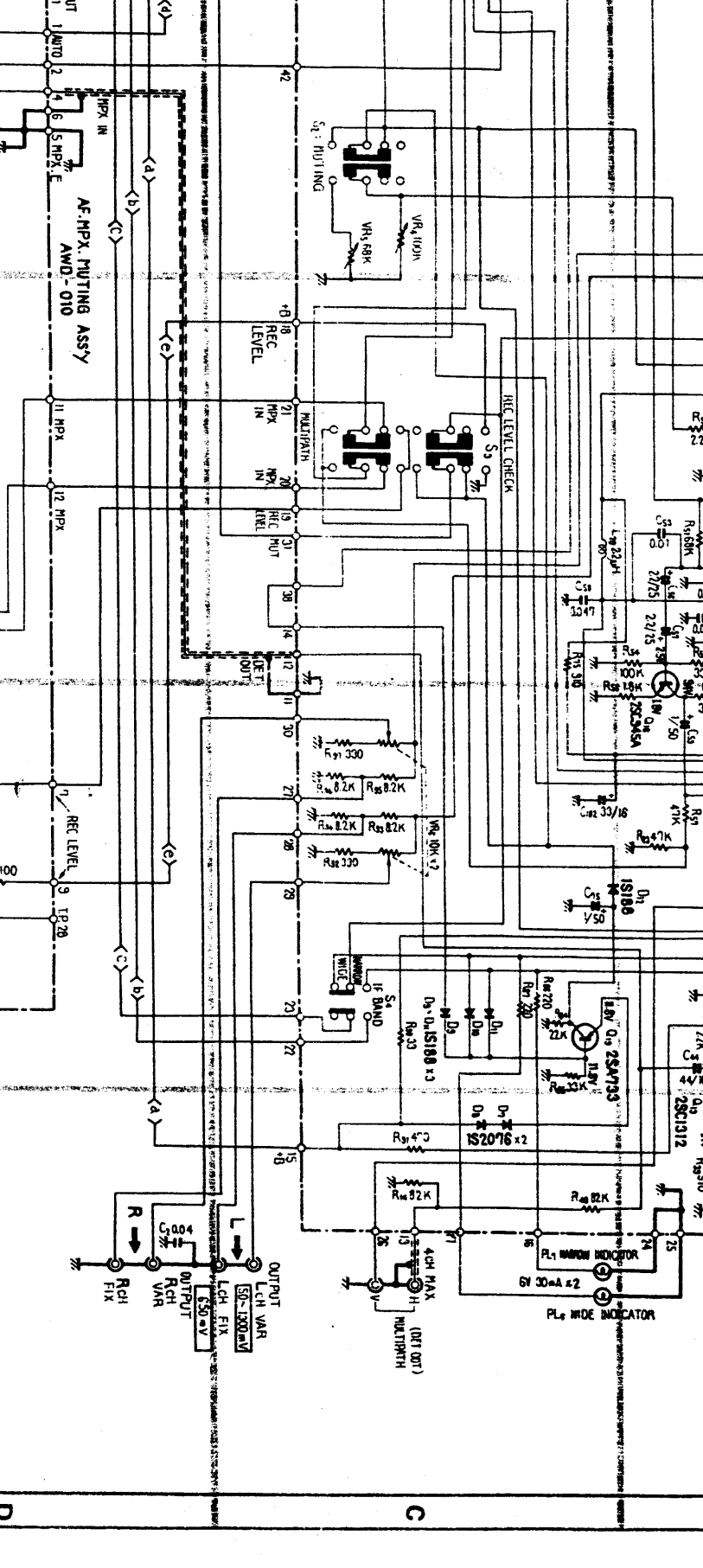
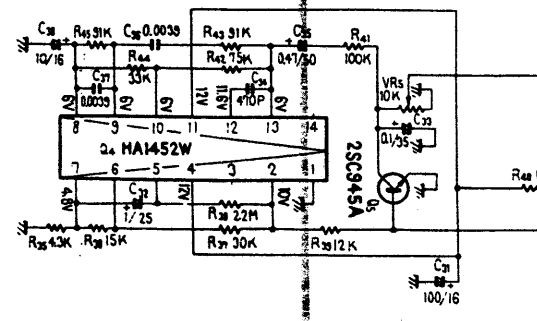
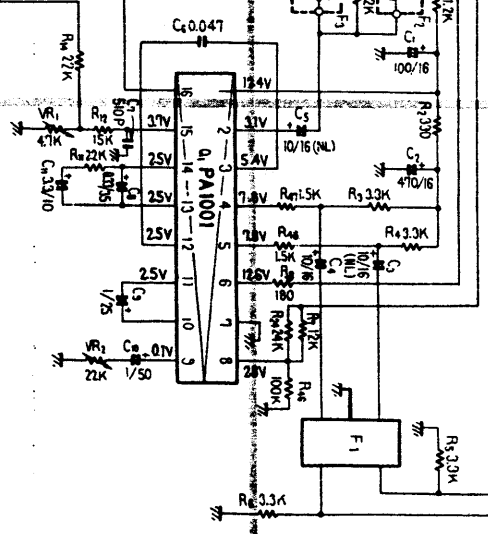

A B C D E

5

6

7

8