

Pioneer

Service Manual

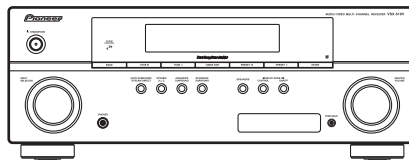

VSX-519V-K

ORDER NO.
RRV3897

AUDIO/VIDEO MULTI-CHANNEL RECEIVER

VSX-519V-K

VSX-519V-S

THIS MANUAL IS APPLICABLE TO THE FOLLOWING MODEL(S) AND TYPE(S).

Model	Type	Power Requirement	Remarks
VSX-519V-K	MYSXCN5	AC 220 V to 230 V	
VSX-519V-S	MYSXCN5	AC 220 V to 230 V	



For details, refer to "Important Check Points for good servicing".

PIONEER CORPORATION 4-1, Meguro 1-chome, Meguro-ku, Tokyo 153-8654, Japan
PIONEER ELECTRONICS (USA) INC. P.O. Box 1760, Long Beach, CA 90801-1760, U.S.A.
PIONEER EUROPE NV Haven 1087, Keetberglaan 1, 9120 Melsele, Belgium

SAFETY INFORMATION



This service manual is intended for qualified service technicians; it is not meant for the casual do-it-yourselfer. Qualified technicians have the necessary test equipment and tools, and have been trained to properly and safely repair complex products such as those covered by this manual.

Improperly performed repairs can adversely affect the safety and reliability of the product and may void the warranty. If you are not qualified to perform the repair of this product properly and safely, you should not risk trying to do so and refer the repair to a qualified service technician.



WARNING

This product may contain a chemical known to the State of California to cause cancer, or birth defects or other reproductive harm.

Health & Safety Code Section 25249.6 - Proposition 65



NOTICE

(FOR CANADIAN MODEL ONLY)

Fuse symbols  (fast operating fuse) and/or  (slow operating fuse) on PCB indicate that replacement parts must be of identical designation.

REMARQUE

(POUR MODÈLE CANADIEN SEULEMENT)

Les symboles de fusible  (fusible de type rapide) et/ou  (fusible de type lent) sur CCI indiquent que les pièces de remplacement doivent avoir la même désignation.

(FOR USA MODEL ONLY)

1. SAFETY PRECAUTIONS

The following check should be performed for the continued protection of the customer and service technician.

LEAKAGE CURRENT CHECK

Measure leakage current to a known earth ground (water pipe, conduit, etc.) by connecting a leakage current tester such as Simpson Model 229-2 or equivalent between the earth ground and all exposed metal parts of the appliance (input/output terminals, screwheads, metal overlays, control shaft, etc.). Plug the AC line cord of the appliance directly into a 120V AC 60 Hz outlet and turn the AC power switch on. Any current measured must not exceed 0.5 mA.

ANY MEASUREMENTS NOT WITHIN THE LIMITS OUTLINED ABOVE ARE INDICATIVE OF A POTENTIAL SHOCK HAZARD AND MUST BE CORRECTED BEFORE RETURNING THE APPLIANCE TO THE CUSTOMER.

2. PRODUCT SAFETY NOTICE

Many electrical and mechanical parts in the appliance have special safety related characteristics. These are often not evident from visual inspection nor the protection afforded by them necessarily can be obtained by using replacement components rated for voltage, wattage, etc. Replacement parts which have these special safety characteristics are identified in this Service Manual.

Electrical components having such features are identified by marking with a Δ on the schematics and on the parts list in this Service Manual.

The use of a substitute replacement component which does not have the same safety characteristics as the PIONEER recommended replacement one, shown in the parts list in this Service Manual, may create shock, fire, or other hazards.

Product Safety is continuously under review and new instructions are issued from time to time. For the latest information, always consult the current PIONEER Service Manual. A subscription to, or additional copies of, PIONEER Service Manual may be obtained at a nominal charge from PIONEER.

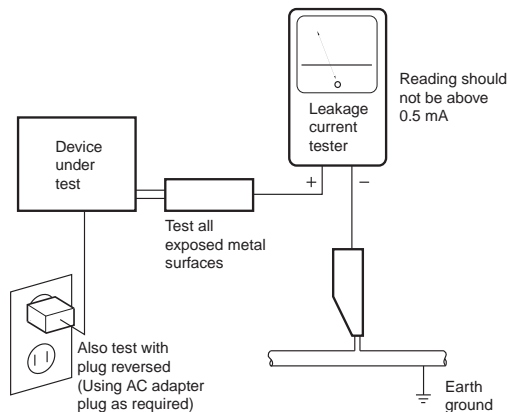

AC Leakage Test

[Important Check Points for Good Servicing]

In this manual, procedures that must be performed during repairs are marked with the below symbol. Please be sure to confirm and follow these procedures.

1. Product safety



Please conform to product regulations (such as safety and radiation regulations), and maintain a safe servicing environment by following the safety instructions described in this manual.

- ① Use specified parts for repair.

Use genuine parts. Be sure to use important parts for safety.

- ② Do not perform modifications without proper instructions.

Please follow the specified safety methods when modification (addition/change of parts) is required due to interferences such as radio/TV interference and foreign noise.

- ③ Make sure the soldering of repaired locations is properly performed.

When you solder while repairing, please be sure that there are no cold solder and other debris. Soldering should be finished with the proper quantity. (Refer to the example)

- ④ Make sure the screws are tightly fastened.

Please be sure that all screws are fastened, and that there are no loose screws.

- ⑤ Make sure each connectors are correctly inserted.

Please be sure that all connectors are inserted, and that there are no imperfect insertion.

- ⑥ Make sure the wiring cables are set to their original state.

Please replace the wiring and cables to the original state after repairs. In addition, be sure that there are no pinched wires, etc.

- ⑦ Make sure screws and soldering scraps do not remain inside the product.

Please check that neither solder debris nor screws remain inside the product.

- ⑧ There should be no semi-broken wires, scratches, melting, etc. on the coating of the power cord.

Damaged power cords may lead to fire accidents, so please be sure that there are no damages. If you find a damaged power cord, please exchange it with a suitable one.

- ⑨ There should be no spark traces or similar marks on the power plug.

When spark traces or similar marks are found on the power supply plug, please check the connection and advise on secure connections and suitable usage. Please exchange the power cord if necessary.

- ⑩ Safe environment should be secured during servicing.

When you perform repairs, please pay attention to static electricity, furniture, household articles, etc. in order to prevent injuries. Please pay attention to your surroundings and repair safely.

2. Adjustments



To keep the original performance of the products, optimum adjustments and confirmation of characteristics within specification. Adjustments should be performed in accordance with the procedures/instructions described in this manual.

3. Lubricants, Glues, and Replacement parts



Use grease and adhesives that are equal to the specified substance. Make sure the proper amount is applied.

4. Cleaning



For parts that require cleaning, such as optical pickups, tape deck heads, lenses and mirrors used in projection monitors, proper cleaning should be performed to restore their performances.

5. Shipping mode and Shipping screws



To protect products from damages or failures during transit, the shipping mode should be set or the shipping screws should be installed before shipment. Please be sure to follow this method especially if it is specified in this manual.

CONTENTS

	SAFETY INFORMATION	2
	1. SERVICE PRECAUTIONS	5
A	1.1 NOTES ON SOLDERING	5
	1.2 CAUTION	5
	2. SPECIFICATIONS	6
	2.1 SPECIFICATIONS	6
	2.2 PANEL FACILITIES	7
	3. BASIC ITEMS FOR SERVICE	11
	3.1 CHECK POINTS AFTER SERVICING	11
	3.2 PCB LOCATIONS	12
	3.3 JIGS LIST	13
	4. BLOCK DIAGRAM	14
	4.1 OVERALL CONNECTION DIAGRAM	14
	4.2 AUDIO BLOCK DIAGRAM	16
B	4.3 VIDEO BLOCK DIAGRAM	18
	4.4 U-COM BLOCK DIAGRAM	19
	4.5 POWER SUPPLY BLOCK DIAGRAM	20
	5. DIAGNOSIS	21
	5.1 DIAGNOSIS FLOWCHART	21
	5.2 DETECTION CIRCUIT	30
	6. SERVICE MODE	33
	6.1 SERVICE MODE	33
	7. DISASSEMBLY	36
	7.1 DISASSEMBLY	36
	8. EACH SETTING AND ADJUSTMENT	44
	8.1 IDLE CURRENT ADJUSTMENT	44
C	9. EXPLODED VIEWS AND PARTS LIST	46
	9.1 PACKING SECTION	46
	9.2 EXTERIOR SECTION	48
	10. SCHEMATIC DIAGRAM	52
	10.1 P.C.B SUB ASSY (MAIN) and P.C.B SUB ASSY (P/T)	52
	10.2 P.C.B SUB ASSYS (FRONT), (VOLUME), (FUNCTION), (HEADPHONE) and (PORTABLE)	54
	10.3 P.C.B SUB ASSY (AMP)	56
	10.4 P.C.B SUB ASSY (INPUT)	58
	10.5 P.C.B SUB ASSY (VIDEO-519)	60
	10.6 P.C.B SUB ASSY (SPEAKER-519) and P.C.B SUB ASSY (CNT)	62
	10.7 P.C.B SUB ASSY (DSP) (1/2)	64
	10.8 P.C.B SUB ASSY (DSP) (2/2)	66
D	11. PCB CONNECTION DIAGRAM	68
	11.1 P.C.B SUB ASSY (MAIN) and P.C.B SUB ASSY (P/T)	68
	11.2 P.C.B SUB ASSYS (FRONT)	72
	11.3 P.C.B SUB ASSYS (VOLUME), (FUNCTION), (HEADPHONE) and (PORTABLE)	74
	11.4 P.C.B SUB ASSY (AMP)	76
	11.5 P.C.B SUB ASSY (INPUT)	78
	11.6 P.C.B SUB ASSY (VIDEO-519)	80
	11.7 P.C.B SUB ASSY (SPEAKER-519)	84
	11.8 P.C.B SUB ASSY (DSP) and P.C.B SUB ASSY (CNT)	86
	11.9 P.C.B SUB ASSY (HDMI-519)	90
E	12. PCB PARTS LIST	92

1. SERVICE PRECAUTIONS

1.1 NOTES ON SOLDERING

- For environmental protection, lead-free solder is used on the printed circuit boards mounted in this unit.
Be sure to use lead-free solder and a soldering iron that can meet specifications for use with lead-free solders for repairs accompanied by reworking of soldering. A
- Compared with conventional eutectic solders, lead-free solders have higher melting points, by approximately 40 °C.
Therefore, for lead-free soldering, the tip temperature of a soldering iron must be set to around 373 °C in general, although the temperature depends on the heat capacity of the PC board on which reworking is required and the weight of the tip of the soldering iron.

Do NOT use a soldering iron whose tip temperature cannot be controlled.

Compared with eutectic solders, lead-free solders have higher bond strengths but slower wetting times and higher melting temperatures (hard to melt/easy to harden). B

The following lead-free solders are available as service parts:

- Parts numbers of lead-free solder:
GYP1006 1.0 in dia.
GYP1007 0.6 in dia.
GYP1008 0.3 in dia.

1.2 CAUTION

- **Discharging**

For more detail, please refer to "7. DISASSEMBLY - 1. Discharging".

- **Notes on Ground Points Connection**

For more detail, please refer to "7. DISASSEMBLY - 2. Notes on Ground Points Connection".

2. SPECIFICATIONS

2.1 SPECIFICATIONS

A Audio section

Rated power output
 Front, Center, Surround
130 W per channel (1 kHz, 6 Ω, 1 %)
 100 W per channel
 (20 Hz to 20 kHz, 8 Ω, 0.09 %)

Total Harmonic Distortion

.....0.06 % (20 Hz to 20 kHz, 8 Ω, 95 W/ch)

Frequency response (LINE Pure Direct mode)

..... 5 Hz to 100 kHz ±3 dB

Guaranteed speaker impedance 6 Ω to 16 Ω

Input (Sensitivity/Impedance)

B LINE200 mV/47 kΩ

Output (Level/Impedance)

REC.200 mV/330 Ω

ZONE 2200 mV/1 kΩ

Signal-to-Noise Ratio

(IHF, short circuited, A network)

LINE98 dB

Video Section

Signal level

Composite 1 Vp-p (75 Ω)

Component Video Y: 1.0 Vp-p (75 Ω)

PB, PR: 0.7 Vp-p (75 Ω)

C Corresponding maximum resolution

Component Video 1080p (1125p)

Tuner Section

FM Frequency Range 87.5 MHz to 108 MHz

Antenna Input75 Ω unbalanced

AM Frequency Range531 kHz to 1602 kHz

Antenna Loop antenna

Digital I/O

HDMI terminal 19-pin (Not DVI)

HDMI output type5 V, 100 mA

D Integrated control section

Control (IR) terminal ϕ 3.5 Mini-jack (MONO)

IR signal High Active (High Level : 2.0 V)

Miscellaneous

Power Requirements

.....AC 220 V to 230 V, 50 Hz/60 Hz

Power Consumption 260 W

In standby0.65 W

Dimensions

..... 420 mm (W) x 158 mm (H) x 347.7 mm (D)

Weight (without package) 8.8 kg

E

Furnished Parts

Remote control.....	1
Dry cell batteries (AAA size IEC R03).....	2
AM loop antenna.....	1
FM wire antenna.....	1
Power cord.....	1
Warranty card.....	1
Operating instructions.....	1

Note

- The specifications are applicable when the power supply is 230 V.
- Specifications and the design are subject to possible modifications without notice, due to improvements.

Manufactured under license from Dolby Laboratories. Dolby, Pro Logic and the double-D symbol are trademarks of Dolby Laboratories.

Manufactured under license under U.S. Patent #'s: 5,451,942; 5,956,674; 5,974,380; 5,978,762; 6,226,616; 6,487,535 & other U.S. and worldwide patents issued & pending. DTS and DTS Digital Surround are registered trademarks and the DTS logos, Symbol and DTS 96/24 are trademarks of DTS, Inc. © 1996-2007 DTS, Inc. All Rights Reserved.

Accessories

		
AM loop antenna (E601016000010-IL)	FM wire antenna (E605010070001-IL)	Remote control (VSX-519V-K:8300753600010-IL VSX-519V-S:8300753700010-IL)
		
		Power Cord (L068250160020-IL)

2.2 PANEL FACILITIES

Front panel

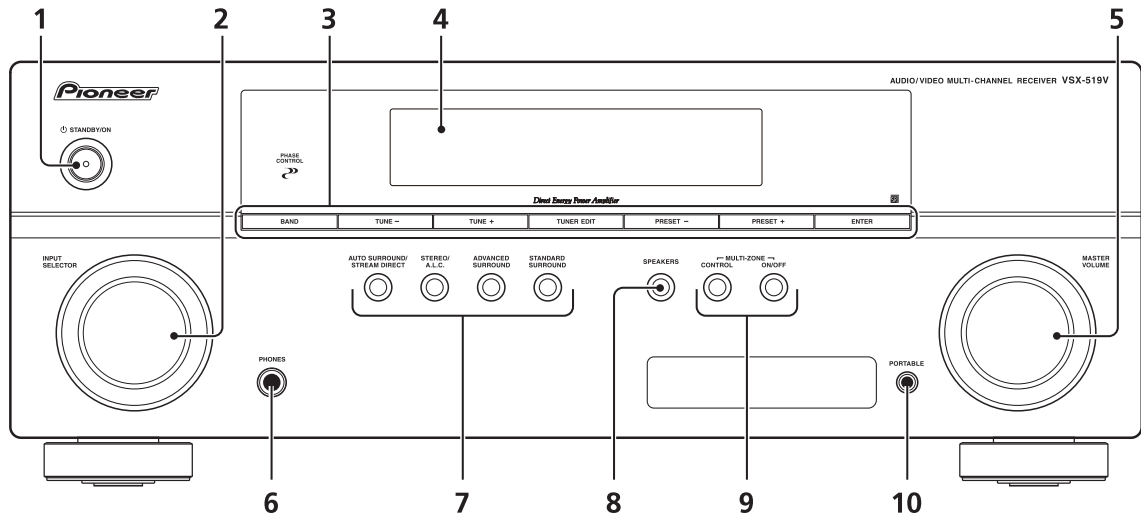

1 **STANDBY/ON**

2 **INPUT SELECTOR dial**

Selects an input source.

3 **Tuner control buttons**

BAND

Switches between AM, FM ST (stereo) and FM MONO radio bands.

TUNE +/-

Used to find radio frequencies.

TUNER EDIT

Use with **TUNE +/-**, **PRESET +/-** and **ENTER** to memorize and name stations for recall.

PRESET +/-

Use to select preset radio stations.

4 **Character display**

5 **MASTER VOLUME dial**

6 **PHONES jack**

Use to connect headphones.

7 **Listening mode buttons**

AUTO SURROUND/STREAM DIRECT

Switches between Auto surround mode and Stream Direct playback. Stream Direct playback bypasses the tone controls for the most accurate reproduction of a source.

STEREO/A.L.C.

Switches between stereo playback, Auto level control stereo mode and Front Stage Surround Advance modes.

ADVANCED SURROUND

Switches between the various surround modes.

STANDARD SURROUND

Press for Standard decoding and to switch between the various Pro Logic II options.

8 **SPEAKERS**

Use to change the speaker system on or off.

9 **MULTI ZONE controls**

If you've made MULTI-ZONE connections use these controls to control the sub zone from the main zone.

10 **PORTABLE audio input jack**

Connect an auxiliary component using a stereo mini-jack cable.

Rear panel

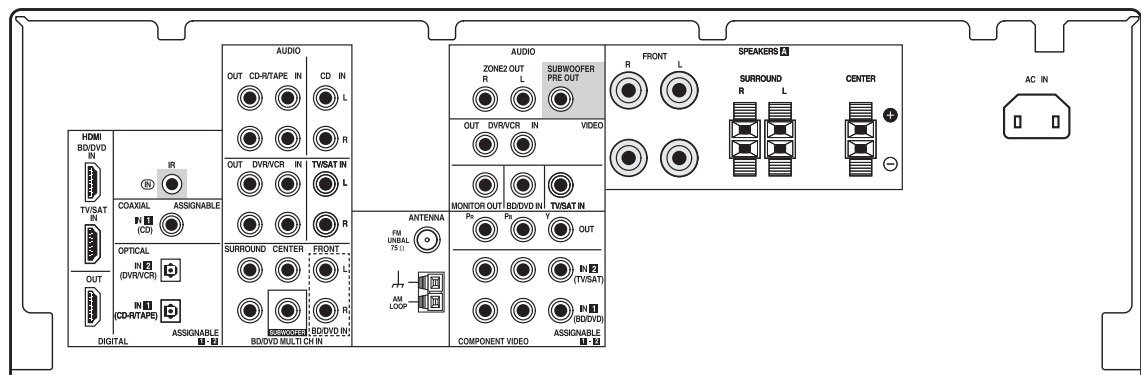

A Display

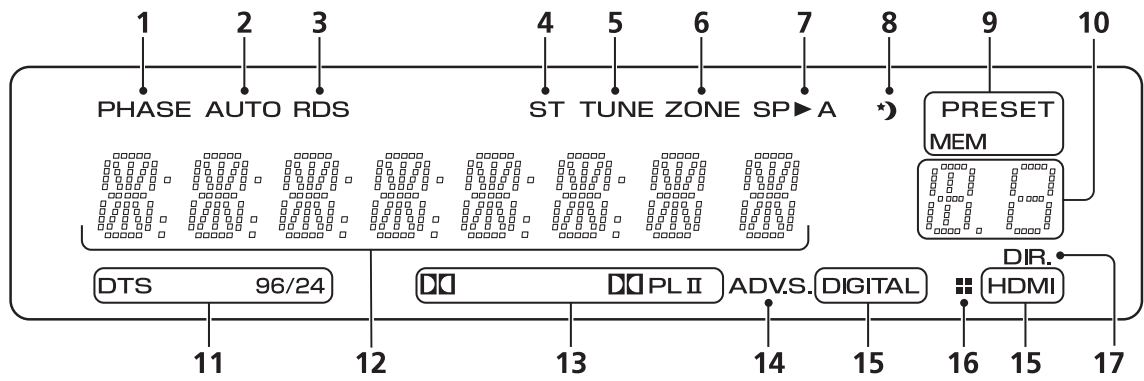

B

1 PHASE

Lights when the Phase Control is switched on.

2 AUTO

Lights when the Auto Surround feature is switched on.

C

3 RDS

Lights when an RDS broadcast is received.

4 ST

Lights when a stereo FM broadcast is being received in auto stereo mode.

D

5 TUNE

Lights when a broadcast is being received.

6 ZONE

Lights when the MULTI-ZONE feature is active.

7 Speaker indicator

Shows if the speaker system is on or not.

SP▶A means the speakers are switched on.

SP▶ means the speakers are switched off and sound is output from the headphone jack.

8 Sleep timer indicator

Lights when the receiver is in sleep mode.

E

9 Tuner preset indicators

PRESET

Shows when a preset radio station is registered or called.

MEM

Blinks when a radio station is registered.

F

10 PRESET information or input signal indicator

Shows the preset number of the tuner or the input signal type, etc.

F

11 DTS indicators

DTS

Lights when a source with DTS encoded audio signals is detected.

96/24

Lights when a source with DTS 96/24 encoded audio signals is detected.

12 Character display

Displays various system information.

13 Dolby Digital indicators

DD

Lights when a Dolby Digital encoded signal is detected.

DDPLII

Lights to indicate Pro Logic II decoding.

14 ADV.S.

Lights when one of the Advanced Surround modes has been selected.

15 SIGNAL SELECT indicators

DIGITAL

Lights when a digital audio signal is selected. Blinks when a digital audio signal is not selected.

HDMI

Lights when an HDMI signal is selected. Blinks when an HDMI signal is not selected.

16 DIMMER indicator

Shows when the display is set to turn off as the DIMMER setting.

17 DIR.

Lights when the DIRECT or PURE DIRECT mode is switched on.

Remote control

As for operating other devices, the remote control codes for the Pioneer products are preset. The settings cannot be changed.

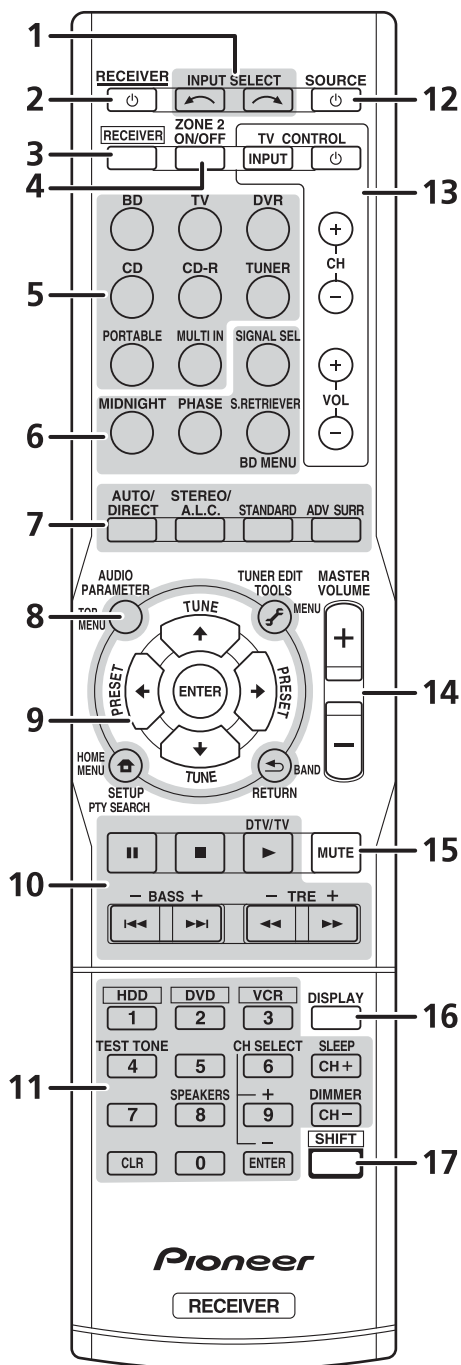

1 INPUT SELECT

Use to select the input source.

2 RECEIVER

Switches the receiver between standby and on.

3 RECEIVER

Switches the remote to control the receiver (used to select the white commands above the number buttons (**TEST TONE**, etc)). Also use this button to set up surround sound or Audio parameters.

4 ZONE 2 ON/OFF

Switches zone 2 of the multi-zone function between on and off.

5 MULTI CONTROL buttons

Press to select control of other components.

6 Receiver control buttons

SIGNAL SEL

Use to select an input signal.

MIDNIGHT

Switches to Midnight or Loudness listening.

PHASE

Press to switch on/off Phase Control.

S.RETRIEVER

Press to restore CD quality sound to compressed audio sources.

Press **BD** first to access:

BD MENU

Displays the disc menu of Blu-ray Discs.

7 Listening mode buttons

AUTO/DIRECT

Switches between Auto surround mode and Stream Direct playback. Stream Direct playback bypasses the tone controls for the most accurate reproduction of a source.

STEREO/A.L.C.

Switches between stereo playback, Auto level control stereo mode and Front Stage Surround Advance modes.

STANDARD

Press for Standard decoding and to switch between Pro Logic II options.

ADV SURR

Switches between the various surround modes.

8 System Setup and Component control buttons

The following button controls can be accessed after you have selected the corresponding **MULTI CONTROL** button (**BD**, **TV**, etc.).

Press **RECEIVER** first to access:

AUDIO PARAMETER

Use to access the Audio options.

SETUP

Press to access the System Setup menu.

RETURN

Confirm and exit the current menu screen.

Press **BD** or **DVR** first to access:

TOP MENU

Displays the disc 'top' menu of a BD/DVD.

A HOME MENU

Displays the HOME MENU screen.

RETURN

Confirm and exit the current menu screen.

MENU

Displays the TOOLS menu of Blu-ray Disc player.

Press **TUNER** first to access:

TUNER EDIT

Memorizes/names stations for recall.

BAND

Switches between AM, FM ST (stereo) and FM MONO radio bands.

PTY SEARCH

Use to search for RDS program types.

9 ↑↓←→ (TUNE ↑/↓, PRESET ←/→), ENTER

Use the arrow buttons when setting up your surround sound system. Also used to control BD/DVD menus/options.

Use the **TUNE** ↑/↓ buttons can be used to find radio frequencies and the **PRESET** ←/→ buttons can be used to select preset radio stations.

10 Component control buttons

C The main buttons (▶, ■, etc.) are used to control a component after you have selected it using the input source buttons.

The controls above these buttons can be accessed after you have selected the corresponding input source button (for example **BD**, **DVR** or **TV**). These buttons also function as described below.

Press **RECEIVER** first to access:

BASS -/+

Use to adjust Bass¹

TRE -/+

Use to adjust Treble¹

Press **TV** first to access:

DTV/TV

Switches between the DTV and analog TV input modes for Pioneer flat screen TVs.

11 Number buttons and other component controls

Use the number buttons to directly select the tracks on a CD, DVD, etc. There are other buttons that can be accessed after the **RECEIVER** button is pressed. (For example **TEST TONE**, etc.)

E HDD*, DVD*, VCR*

These buttons switch between the hard disk, DVD and VCR controls for HDD/DVD/VCR recorders.

TEST TONE

Outputs the test tones on each channel.

Use the ↑/↓ buttons to select the channel and use the ←/→ buttons to adjust the level on each channel. Pressing **TEST TONE** again exits the test tone mode.

CH SELECT

Press repeatedly to select a channel, then use +/- to adjust the level.

F CH SELECT +/-

Use to adjust the channel levels.

SPEAKERS

Use to change the speaker system on or off.

SLEEP

Press to change the amount of time before the receiver switches into standby (**30 min – 60 min – 90 min – Off**). You can check the remaining sleep time at any time by pressing **SLEEP** once.

DIMMER

Dims or brightens the display. The brightness can be controlled in four steps.

12 ⏻ SOURCE

Turns on or off the power of the Pioneer DVD/DVR units when **BD** or **DVR** is selected using the **MULTI CONTROL** buttons.

13 TV CONTROL buttons

These buttons can control only be used with Pioneer flat screen TVs.



Use to turn on/off the power of the TV.

INPUT

Use to select the TV input signal.

CH +/-

Use to select channels.

VOL +/-

Use to adjust the volume on your TV.

14 MASTER VOLUME +/-

Use to set the listening volume.

15 MUTE

Mutes/unmutes the sound.

16 DISPLAY

Switches the display of this unit. The input name, listening mode or sound volume can be checked by selecting an input source.

17 SHIFT

Press to access the 'boxed' commands (above the buttons) on the remote. These buttons are marked with an asterisk (*) in this section.

This button is also used for operating ZONE 2.

Note

1 The tone controls are disabled when the listening mode is set to **DIRECT** or **PURE DIRECT**.

3. BASIC ITEMS FOR SERVICE

3.1 CHECK POINTS AFTER SERVICING

Items to be checked after servicing / VSX, SC

To keep the product quality after servicing, confirm recommended check points shown below.

No.	Procedures	Check points
1	Confirm whether the customer complain has been solved. If the customer complain occurs with the particular source, such as Dolby Digital, DTS, AAC, DVD-A and HDMI, input it for the operation check.	The customer complain must not be reappeared. Video, Audio and operations must be normal.
2	Check the analog audio playback. (Make the analog connections with a DVD player.)	Each channel audio and operations must be normal.
3	Check the digital audio playback. (Make the digital connections with a DVD player.)	Each channel audio and operations must be normal.
4	Check surround playback. (Select Surround mode and check the multichannel operations via the DSP circuit.)	Each channel audio and operations must be normal.
5	Check the video outputs. (Connect with a DVD player.)	Video and operations must be normal.
6	Check the tuner (AM and FM) operations.	Audio and operations must be normal.
7	Check the sound from headphone output.	Sound must be normal, without noise.
8	Check the appearance of the product.	No scratches or dirt on its appearance after receiving it for service.

See the table below for the items to be checked regarding video and audio.

Item to be checked regarding video	Item to be checked regarding audio
Block noise	Distortion
Horizontal noise	Noise
Flicker	Volume too low
Disturbed image (video jumpiness)	Volume too high
Too dark	Volume fluctuating
Too bright	Sound interrupted
Mottled color	

3.2 PCB LOCATIONS

A

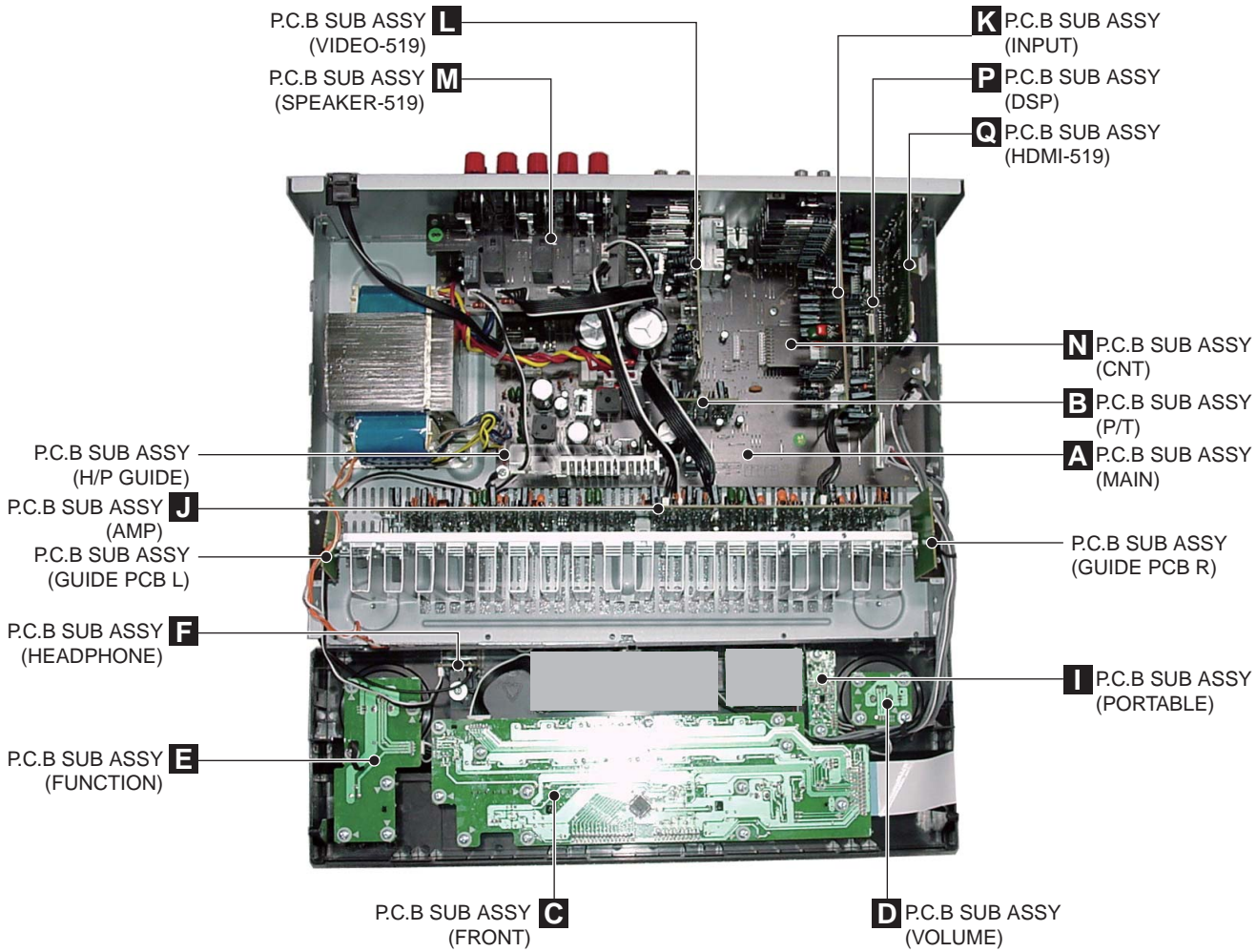

NOTES:

- Parts marked by “NSP” are generally unavailable because they are not in our Master Spare Parts List.
- The \triangle mark found on some component parts indicates the importance of the safety factor of the part. Therefore, when replacing, be sure to use parts of identical designation.

Mark No.	Description	Part No.	Mark No.	Description	Part No.
LIST OF ASSEMBLIES					
\triangle NSP	1..P.C.B TOTAL ASSY (AMP) 2..P.C.B SUB ASSY (AMP)	7025HK0811012-IL 7028067521010-IL	NSP	1..P.C.B TOTAL ASSY (HDMI-519) 2..P.C.B SUB ASSY (HDMI-519)	7025HK0812016-IL 7028067581010-IL
E	NSP	1..P.C.B TOTAL ASSY (FRONT) 2..P.C.B SUB ASSY (FRONT) 2..P.C.B SUB ASSY (HEADPHONE) 2..P.C.B SUB ASSY (VOLUME) 2..P.C.B SUB ASSY (FUNCTION) 2..P.C.B SUB ASSY (PORTABLE)	NSP	1..P.C.B TOTAL ASSY (MAIN) 2..P.C.B SUB ASSY (MAIN) 2..P.C.B SUB ASSY (GUIDE-L) 2..P.C.B SUB ASSY (GUIDE-R) 2..P.C.B SUB ASSY (CNT) 2..P.C.B SUB ASSY (P/T) 2..P.C.B SUB ASSY (H/P GUIDE)	7025HK0812010-IL 7028067501020-IL 7028067502010-IL 7028067503010-IL 7028067504010-IL 7028067505010-IL 7028067506010-IL
	NSP	1..P.C.B TOTAL ASSY (INPUT) 2..P.C.B SUB ASSY (INPUT)	NSP	1..P.C.B TOTAL ASSY (SPEAKER) 2..P.C.B SUB ASSY (SPEAKER-519)	7025HK0812013-IL 7028067531020-IL 7025HK0812017-IL 7028067601030-IL
	NSP	1..P.C.B TOTAL ASSY (VIDEO-519) 2..P.C.B SUB ASSY (VIDEO-519)			7025HK0812014-IL 7028067551010-IL
F	NSP	1..P.C.B TOTAL ASSY (DSP) 2..P.C.B SUB ASSY (DSP)			7025HK0812015-IL 7028067561020-IL

3.3 JIGS LIST

■ Jigs list

Name	Jig No.	Remarks
10P extension jig cable	GGD1628	Diagnosis
8P extension jig cable	GGD1629	Diagnosis
Board to board extension jig cable	GGD1630	Diagnosis

■ Lubricants and Glues list



Name	Lubricants and Glues No.	Remarks
Silicon grease	GEM1057	Refer to "9.2 EXTERIOR SECTION"
Silicon adhesive	GYA1011 (KE40RTV-W)	Refer to "9.2 EXTERIOR SECTION"

4. BLOCK DIAGRAM

4.1 OVERALL CONNECTION DIAGRAM

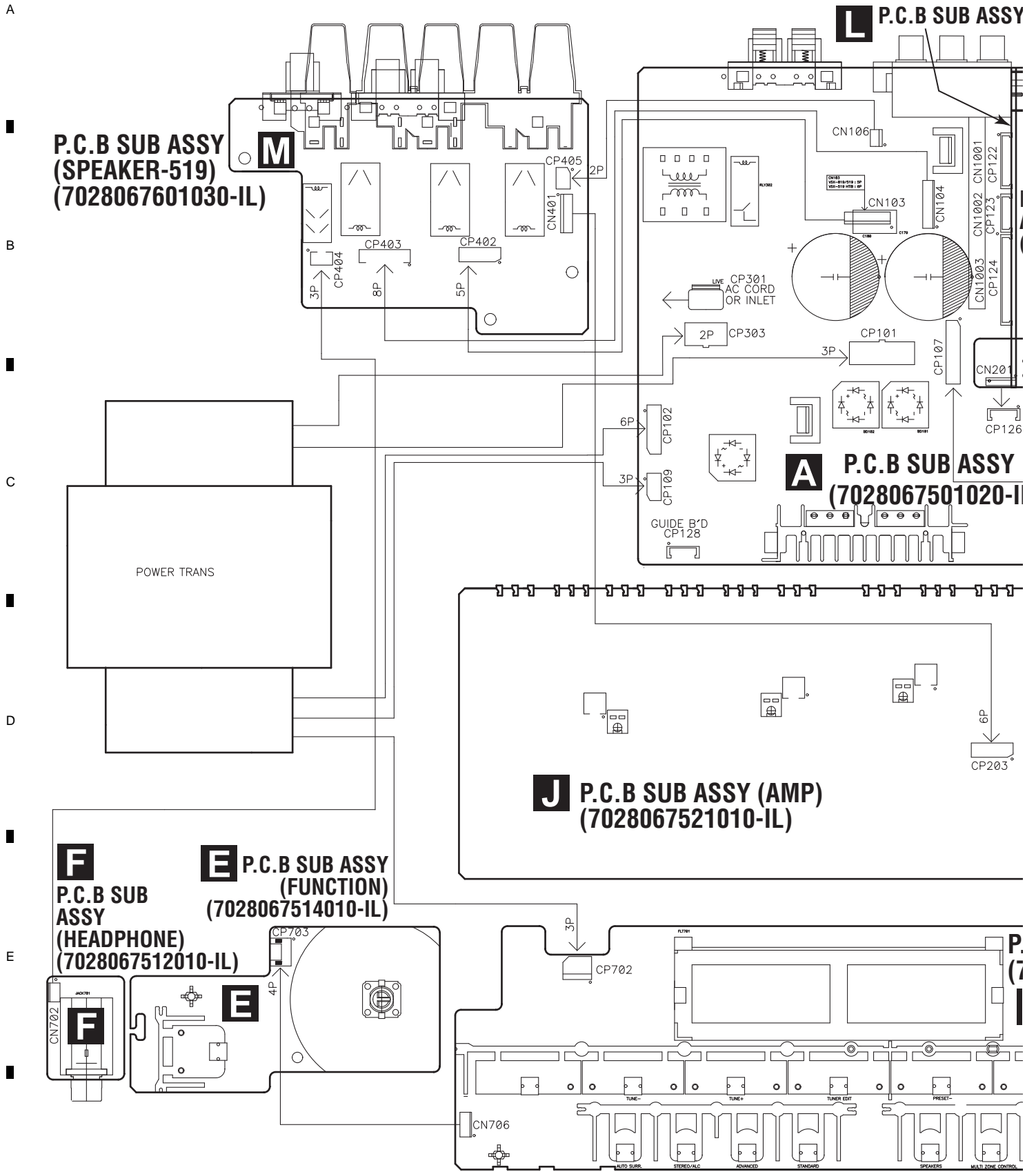

A
B
C
D
E
F

P.C.B SUB ASSY (VIDEO-519)(7028067551010-IL)

Q P.C.B SUB ASSY (HDMI-519)(7028067581010-IL)

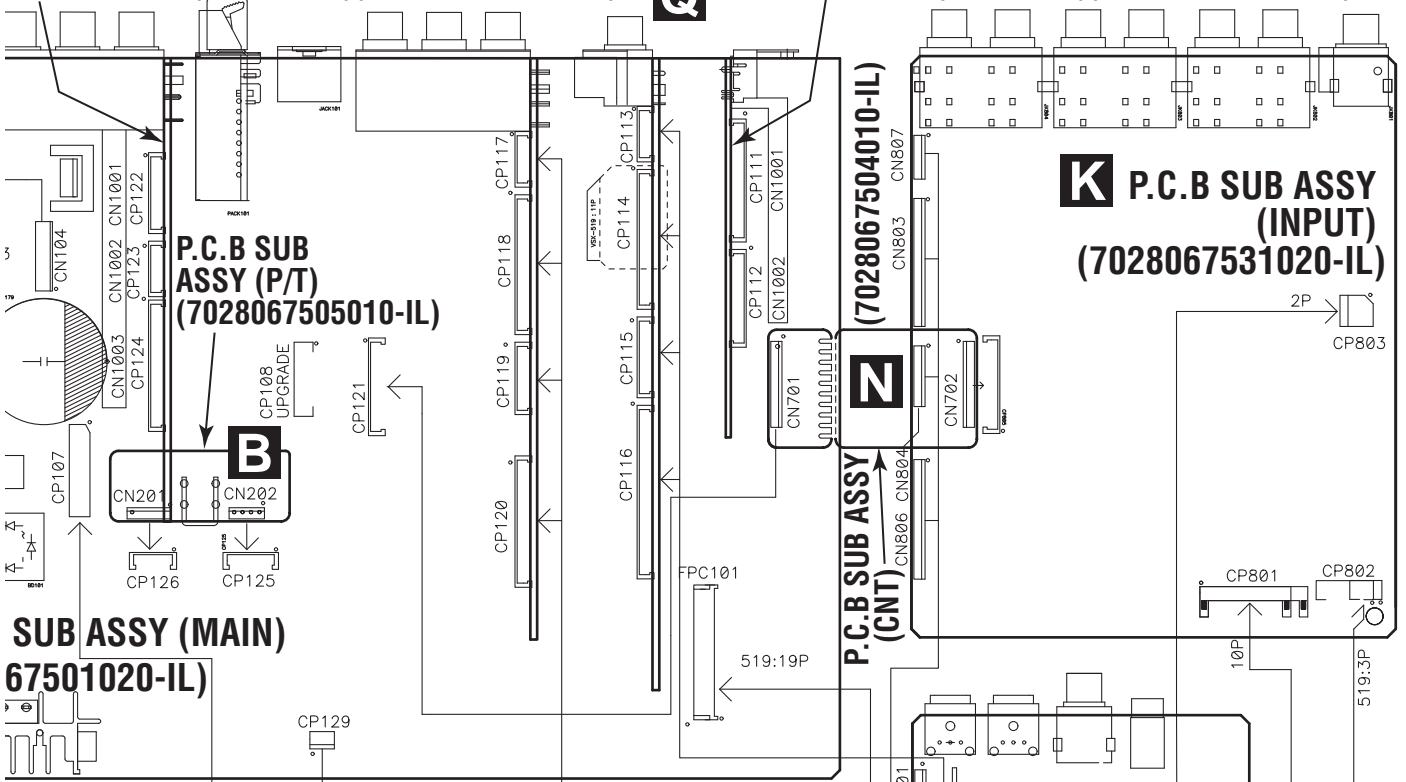

SUB ASSY (MAIN) 67501020-IL

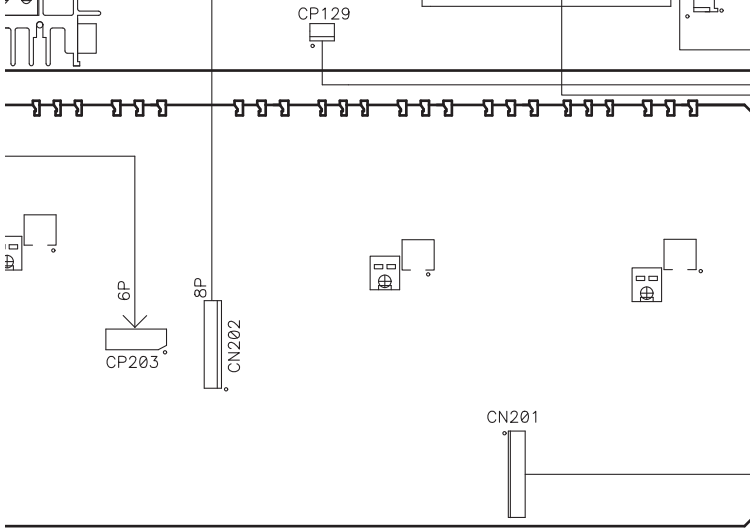

P.C.B SUB ASSY (CNT) (7028067504010-IL)

K P.C.B SUB ASSY (INPUT) (7028067531020-IL)

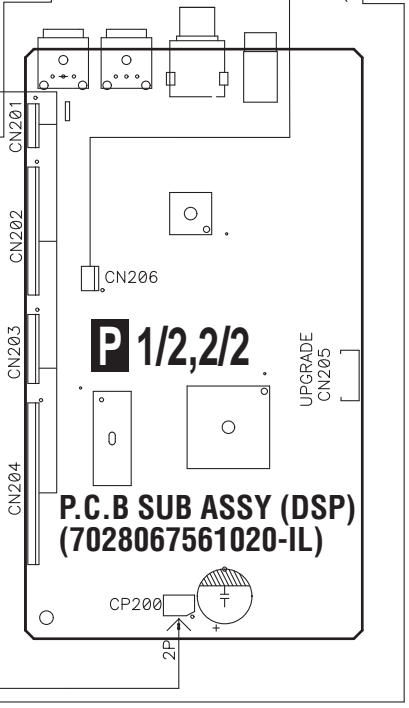

P.C.B SUB ASSY (FRONT) (7028067511020-IL)

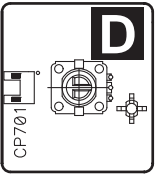
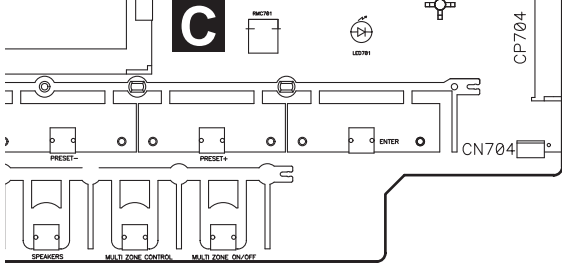

P.C.B SUB ASSY (VOLUME) (7028067513010-IL)

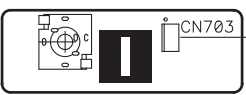

P.C.B SUB ASSY (PORTABLE) (7028067518010-IL)

4.2 AUDIO BLOCK DIAGRAM

A
B
C
D
E
F

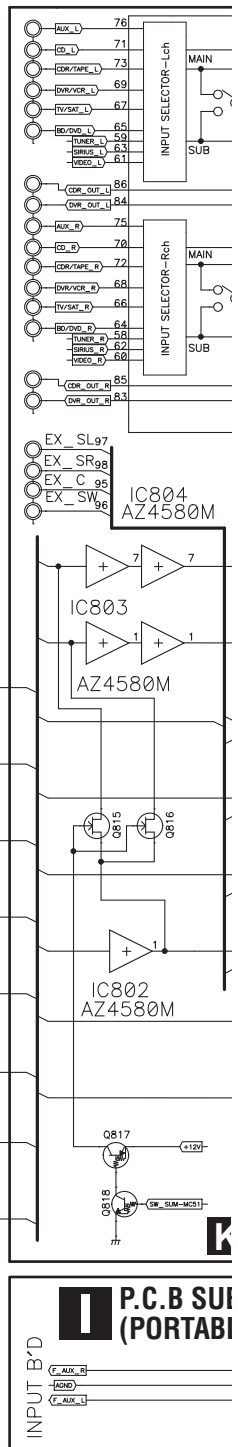
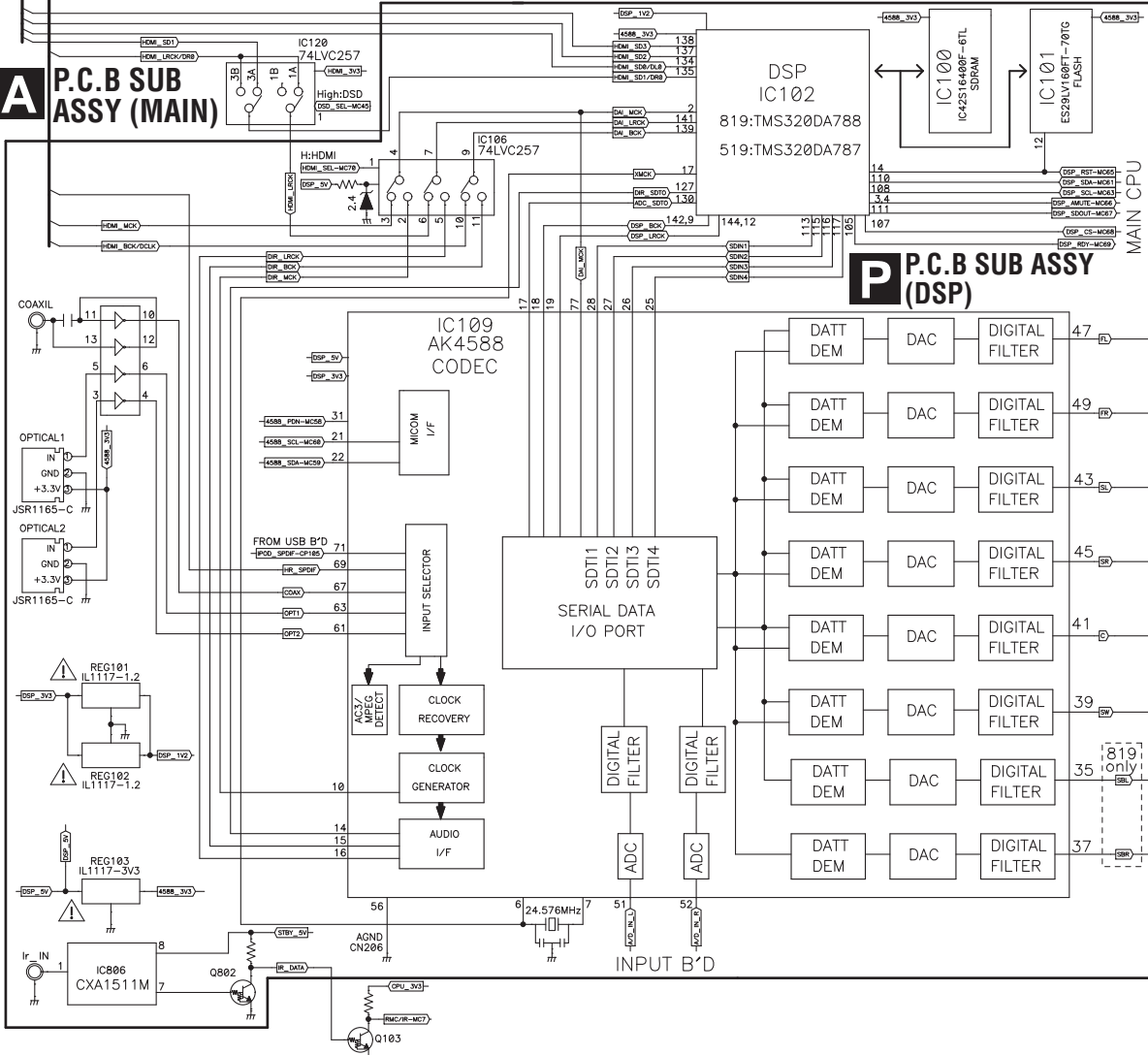
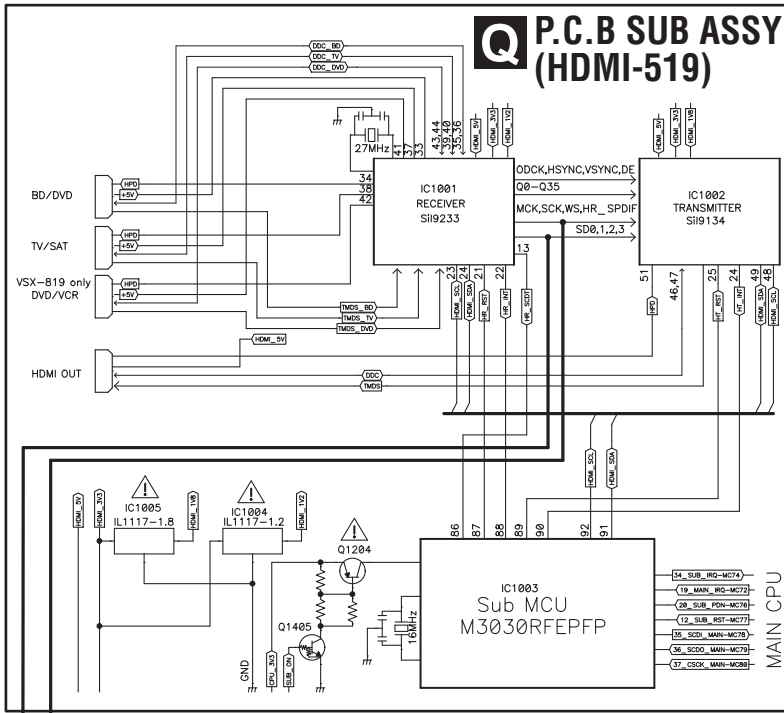

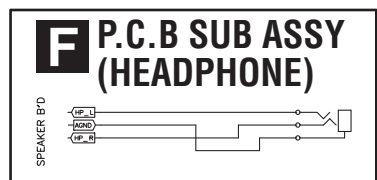
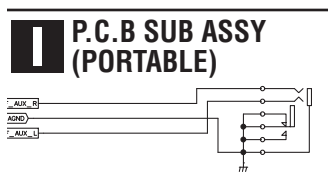
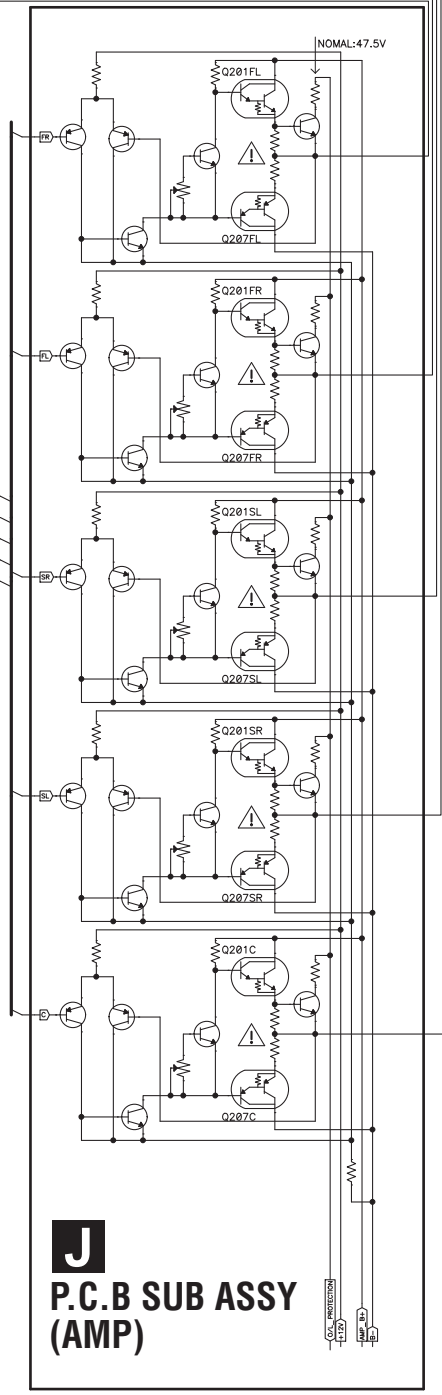
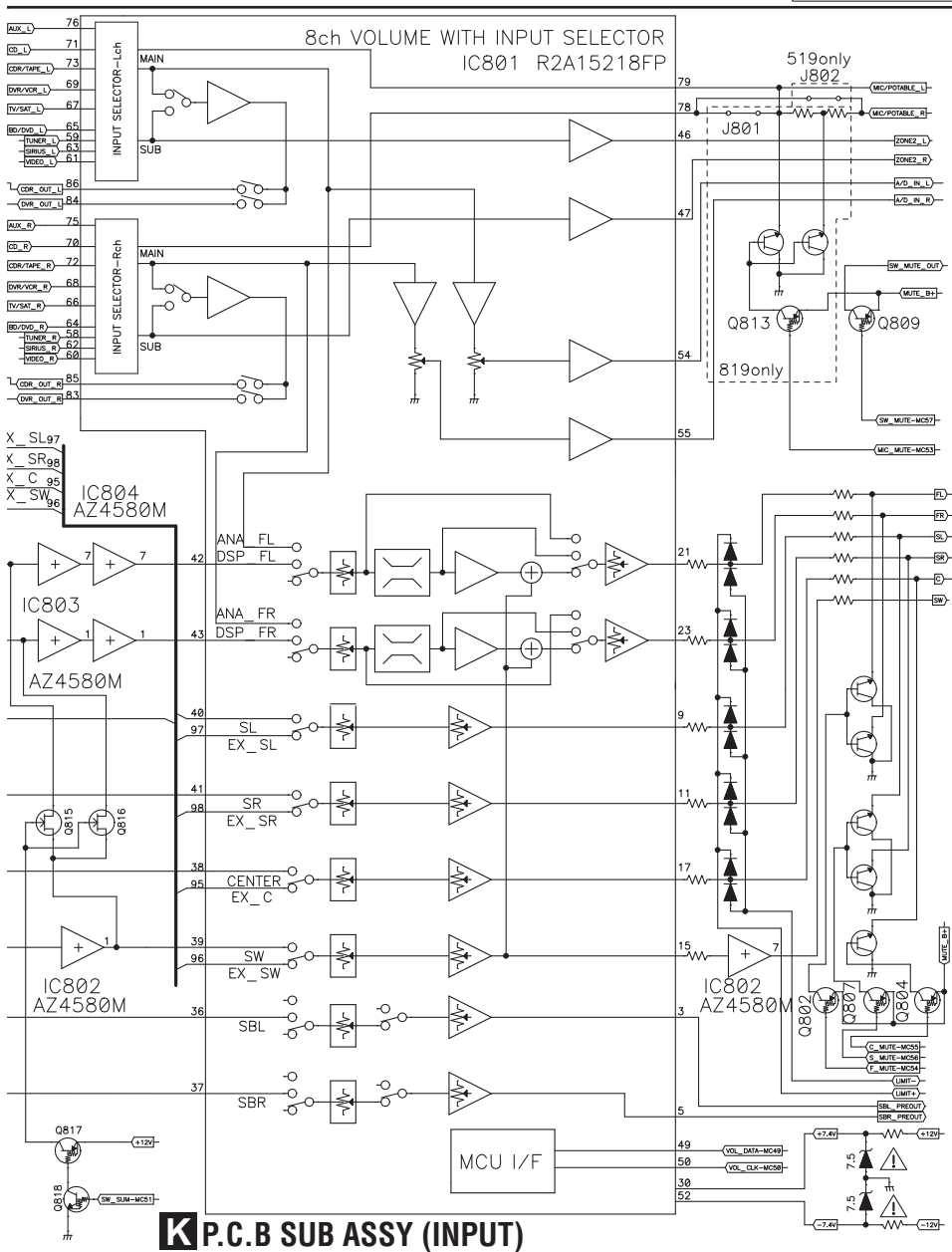
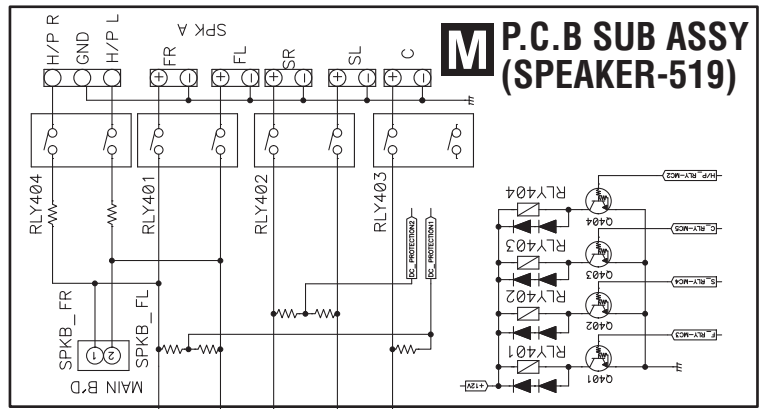

4.3 VIDEO BLOCK DIAGRAM

A
B
C
D
E
F

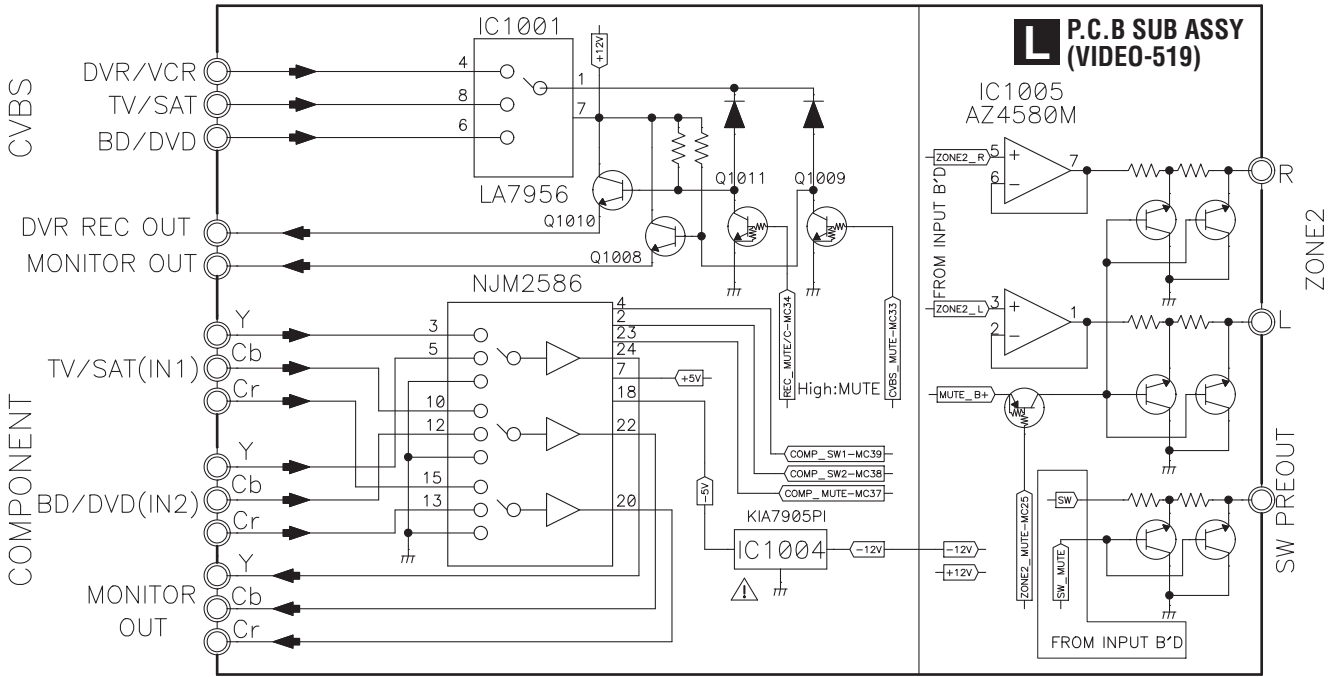

4.4 U-COM BLOCK DIAGRAM

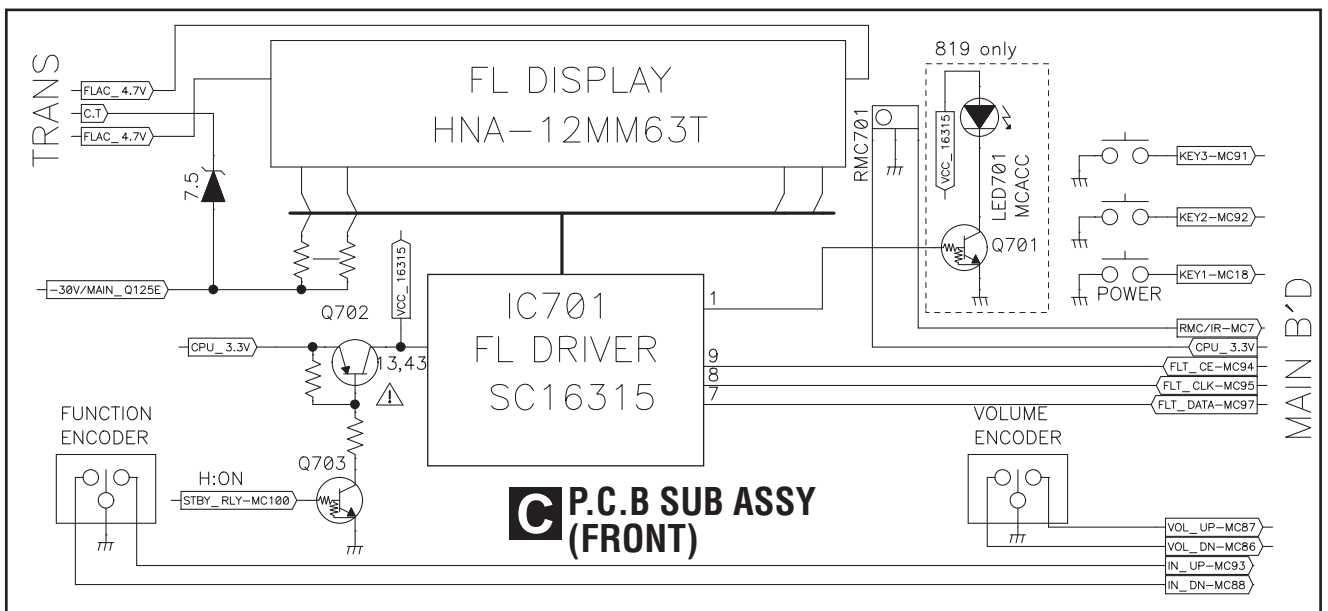
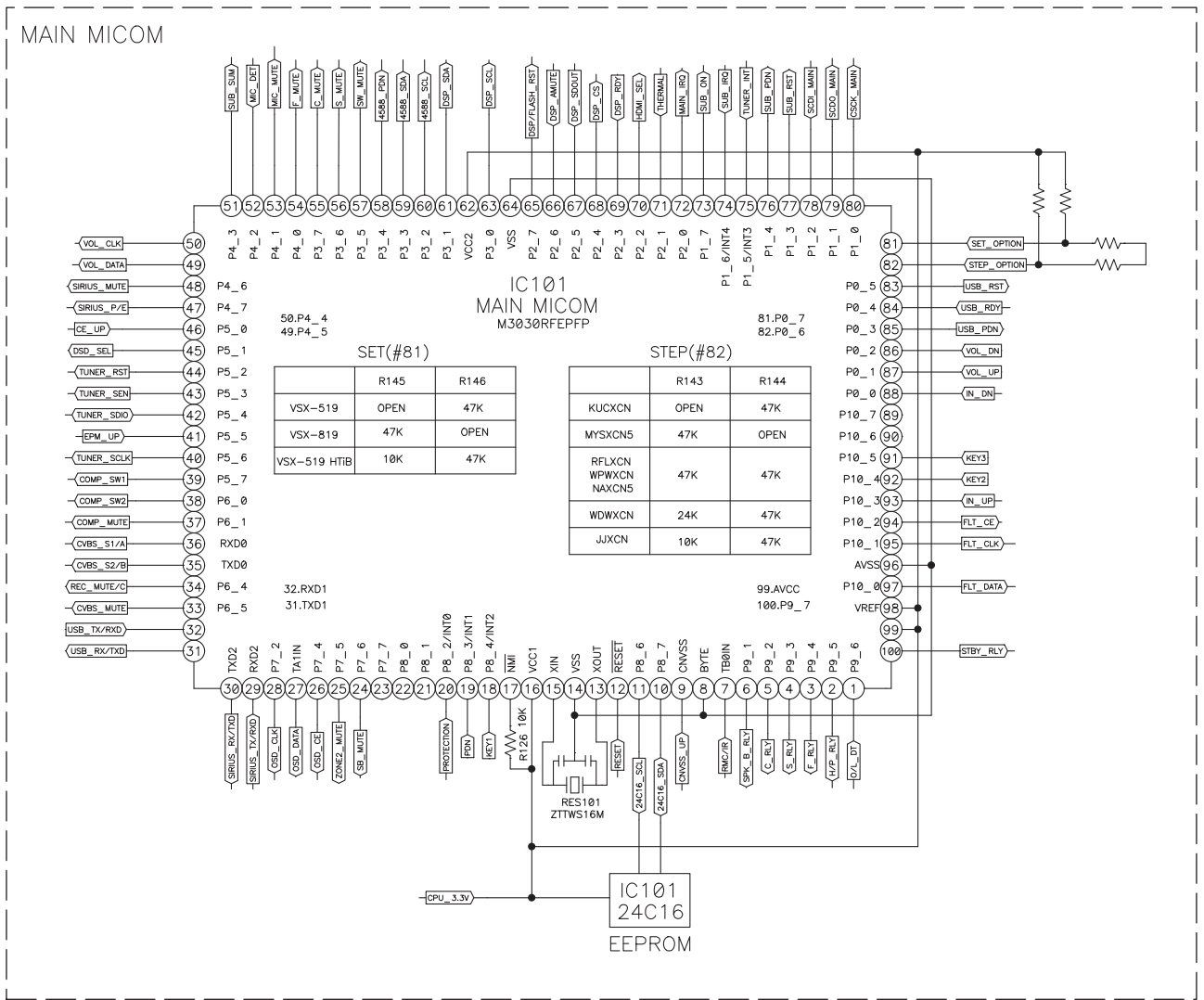

4.5 POWER SUPPLY BLOCK DIAGRAM

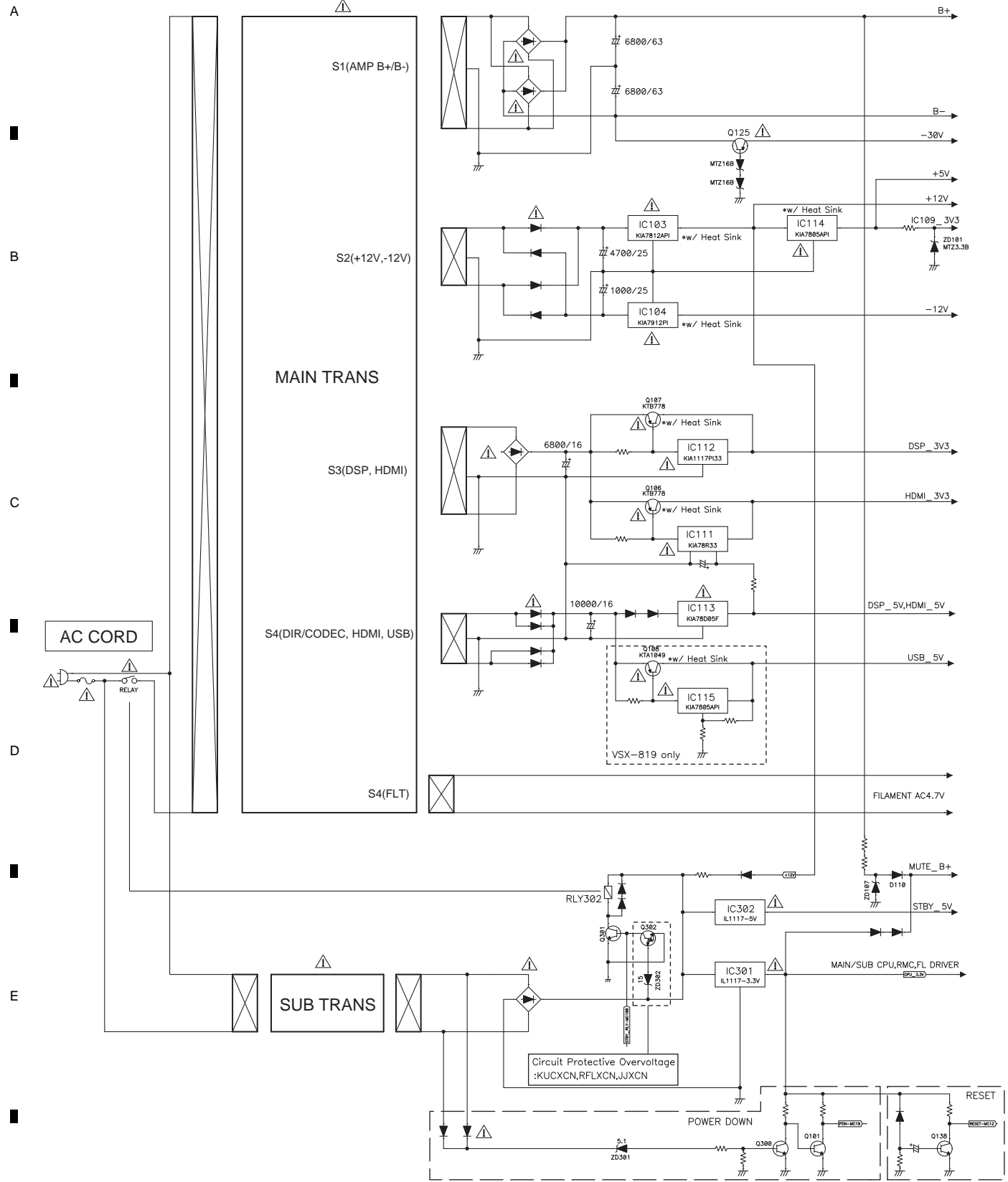

5. DIAGNOSIS

5.1 DIAGNOSIS FLOWCHART

[1] DSP TROUBLESHOOTING

■ Troubleshooting

Step 0: Preliminary confirmation

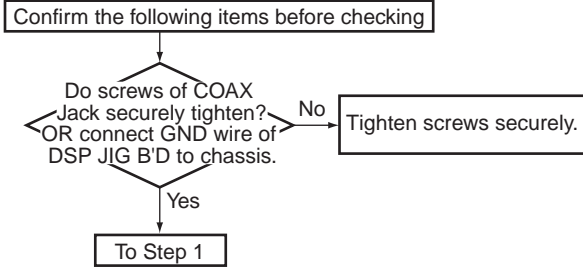

Step 1: BtoB connector

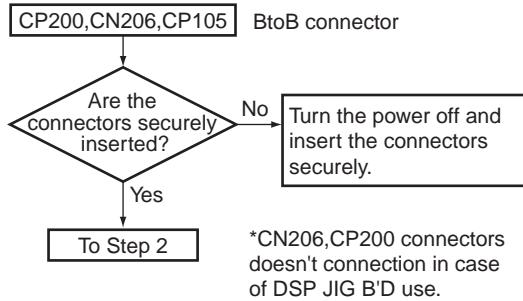

Step 2: Regulator IC

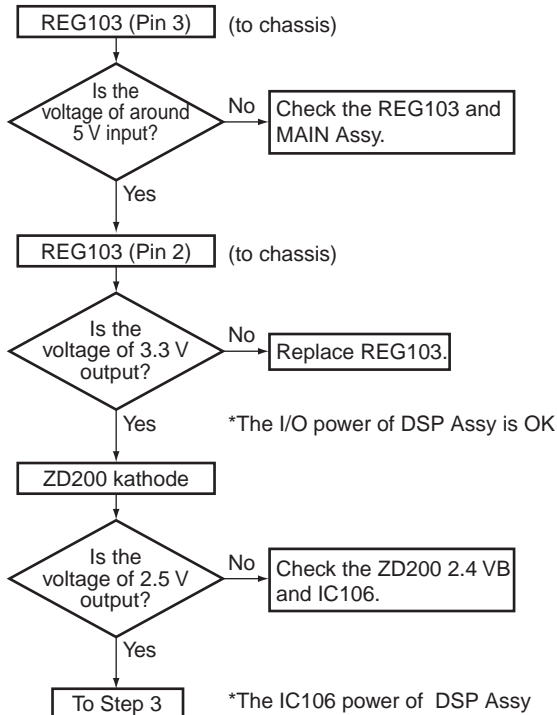

Step 3: Regulator IC

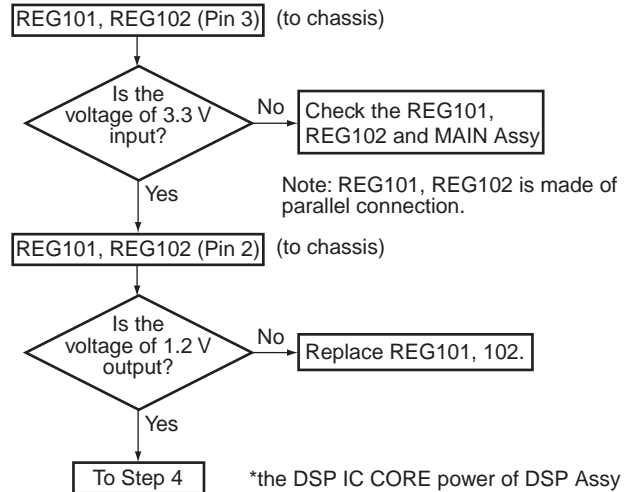

Step 4: X'tal

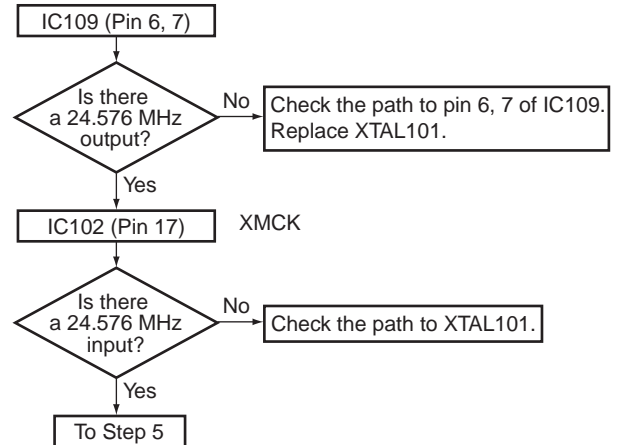

A Step 5: DIR

Check that the S/PDIF signal is output.
Check that changes by pulling out and inserting the digital input lines.

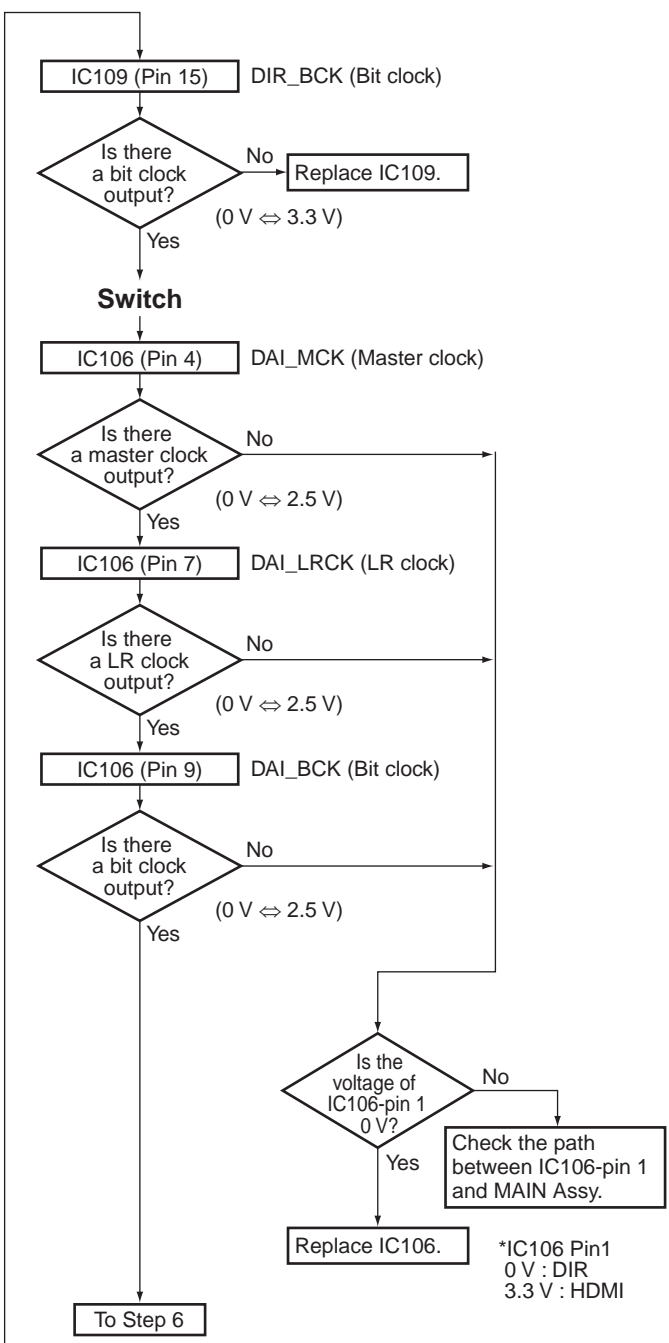
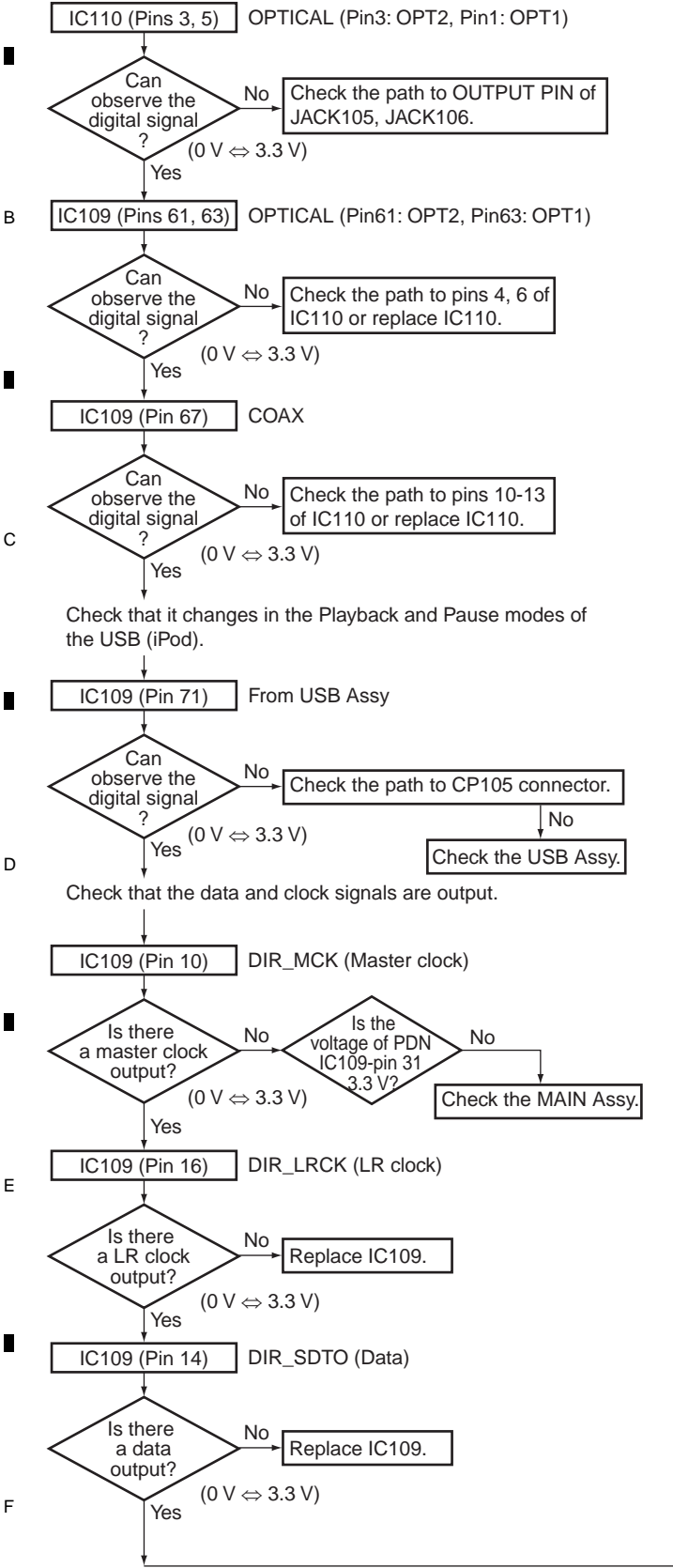

*IC106 Pin1
0 V : DIR
3.3 V : HDMI

Step 6: DSP output (digital)

Digital output of each CH when inputting the digital signal with audio.

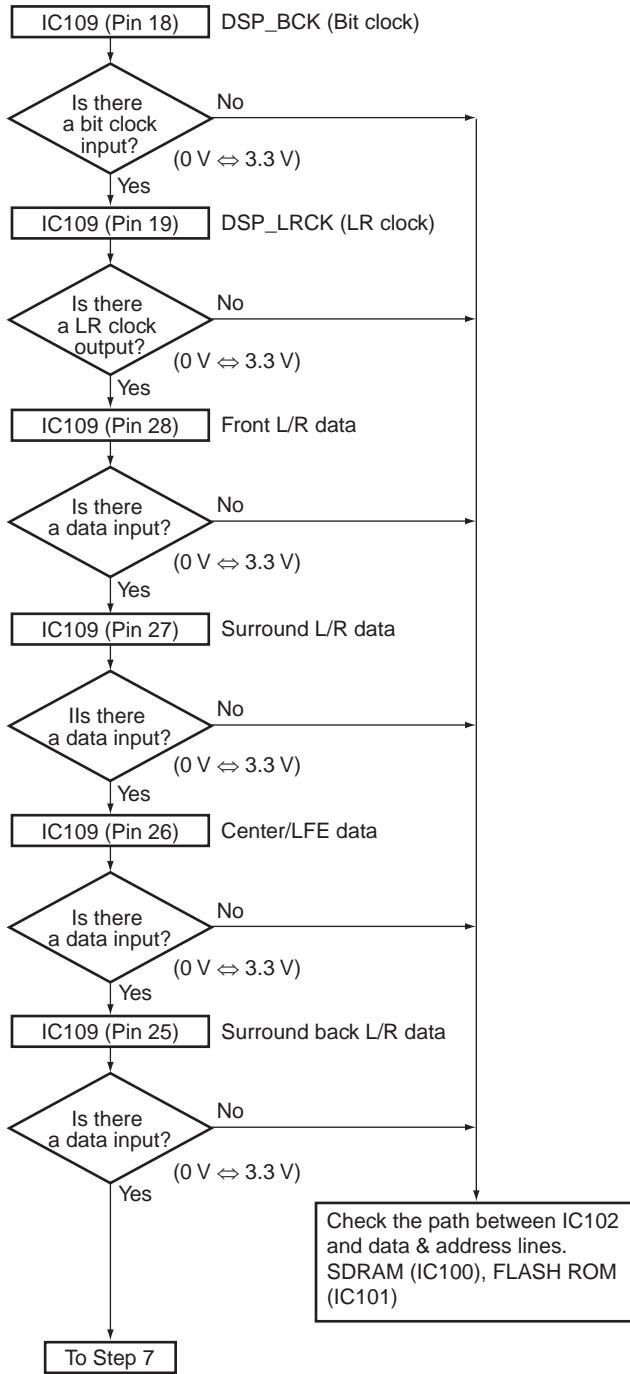

A
B
C
D
E
F

A Step 7: Codec output (analog)

Analog output of each CH when inputting the digital signal with audio.

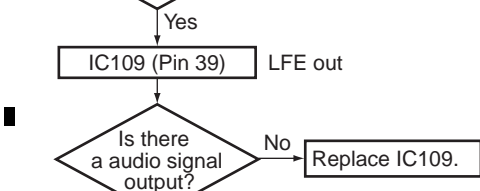
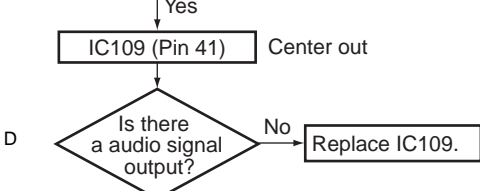
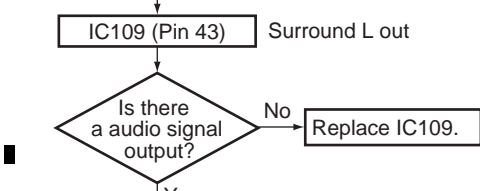
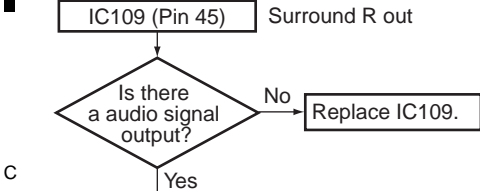
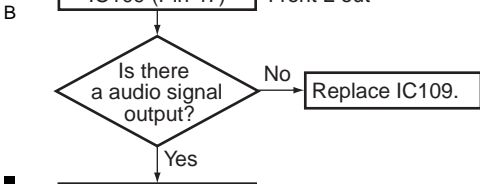
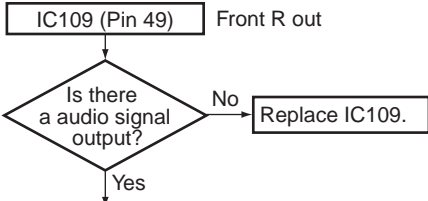

Analog output of each CH when inputting the digital signal (-∞ dB (no signal)).

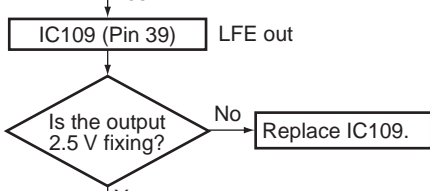
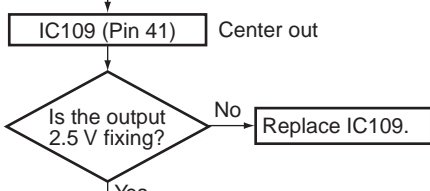
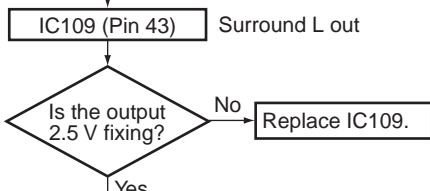
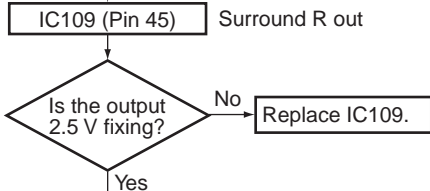
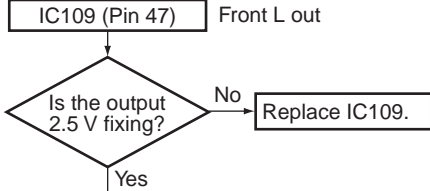
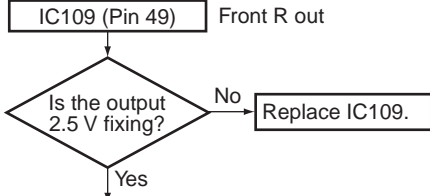

End



[2] HDMI TROUBLESHOOTING

1. Causes for noncompletion of HDMI authentication between the source equipment and this unit (the HDMI indicator is unlit or flashes)

■ HDMI Simple Diagnosis

Causes for no display or sound from the monitor

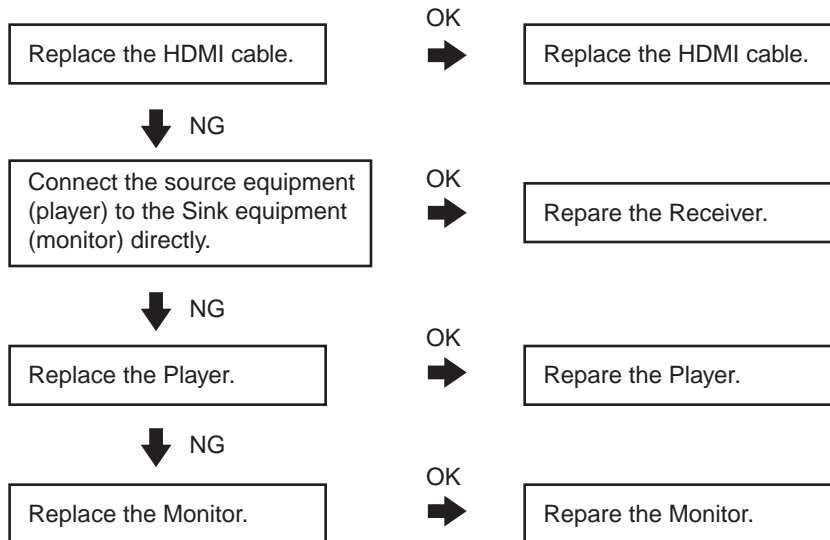

■ HDMI Troubleshooting

Step 0: Preliminary confirmation

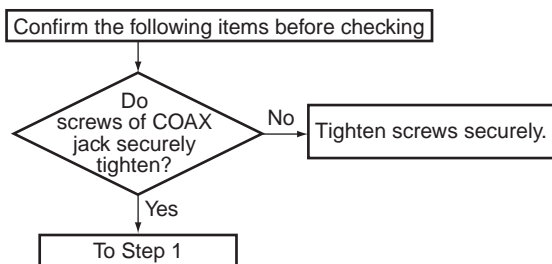

Step 1: Connect the HDMI equipment

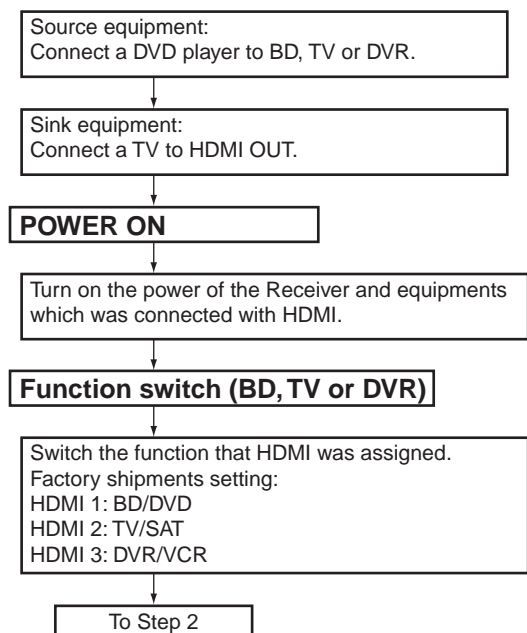

A Step 2: Power supply

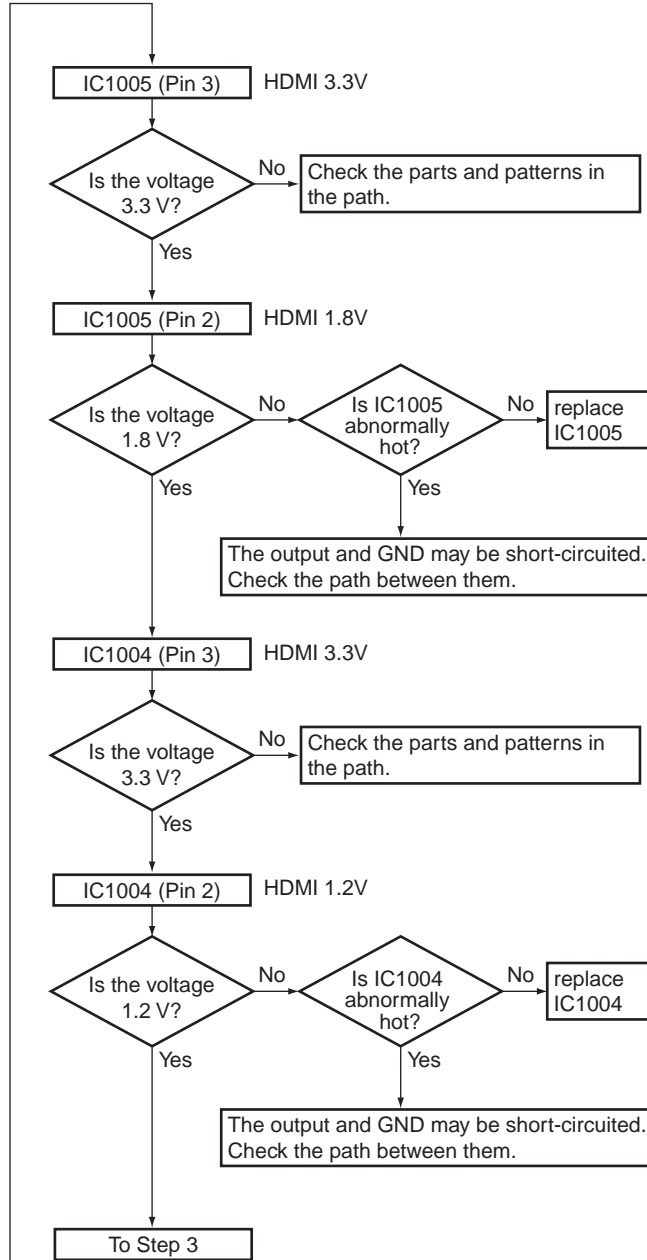
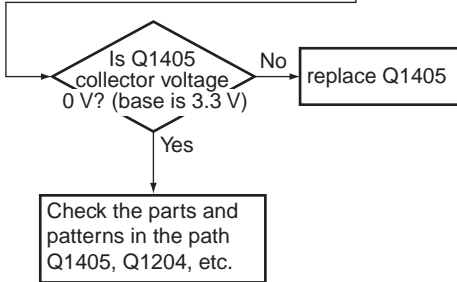
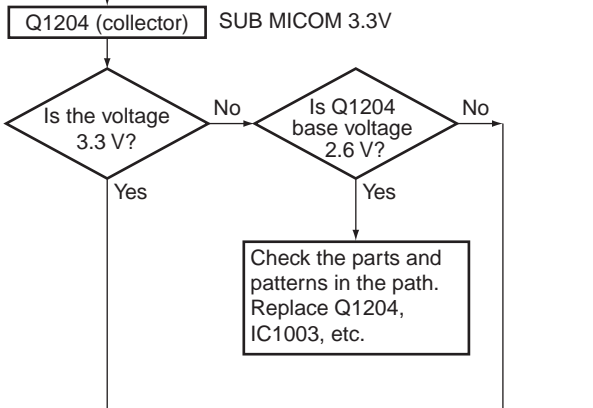
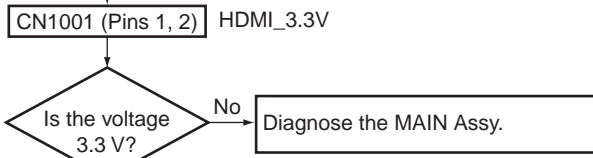
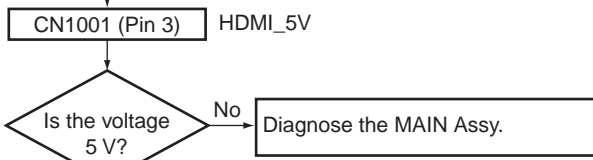
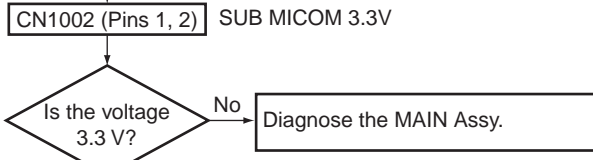
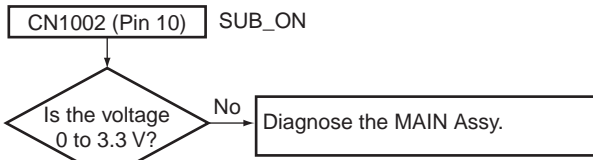

F

Step 3: Diagnosis

Each data lines confirmation checks it after standby OFF/ON.

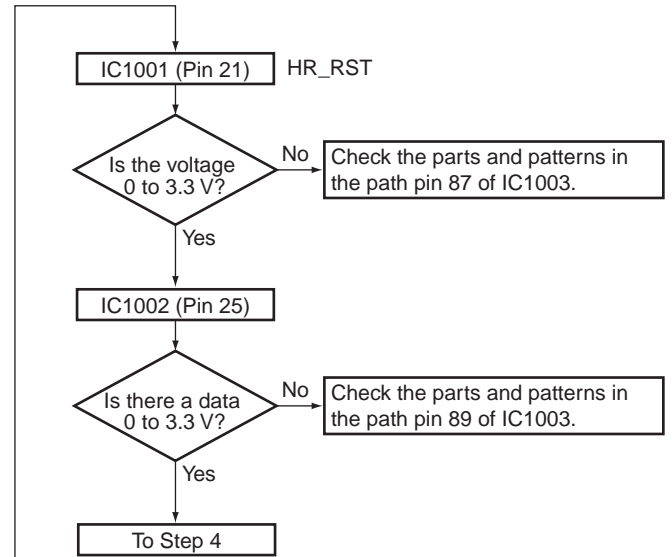
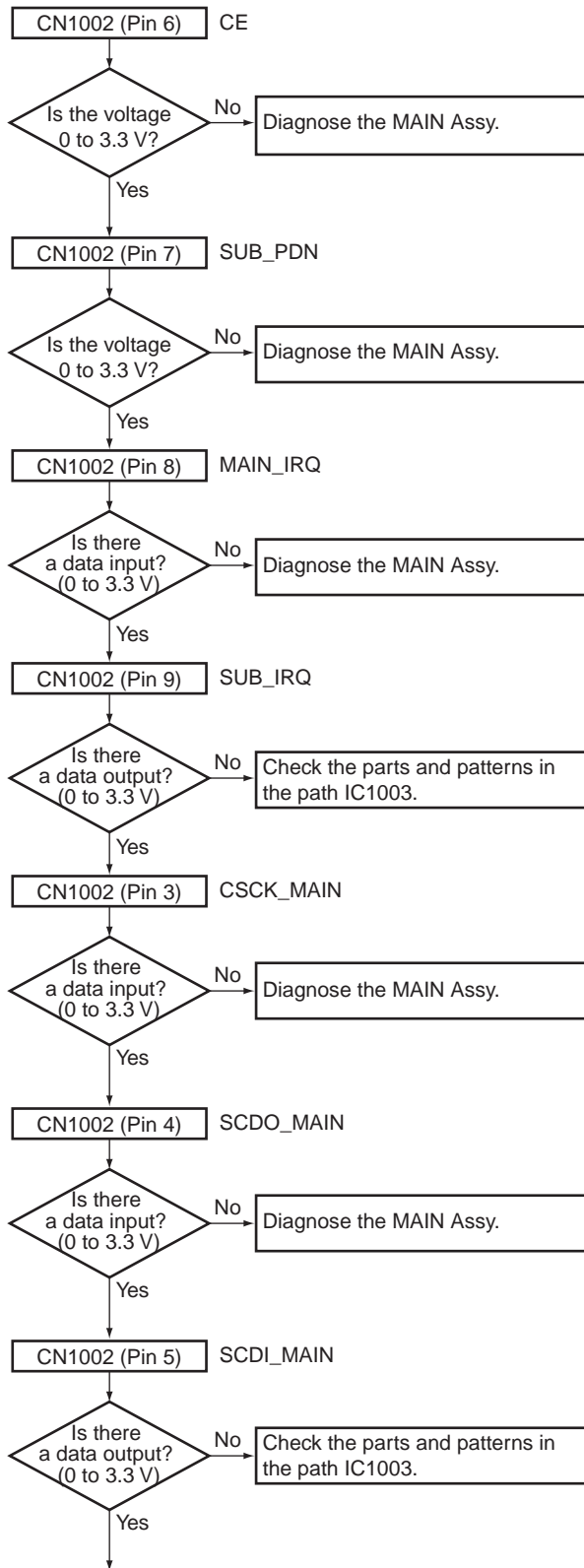

Step 4: X'TAL

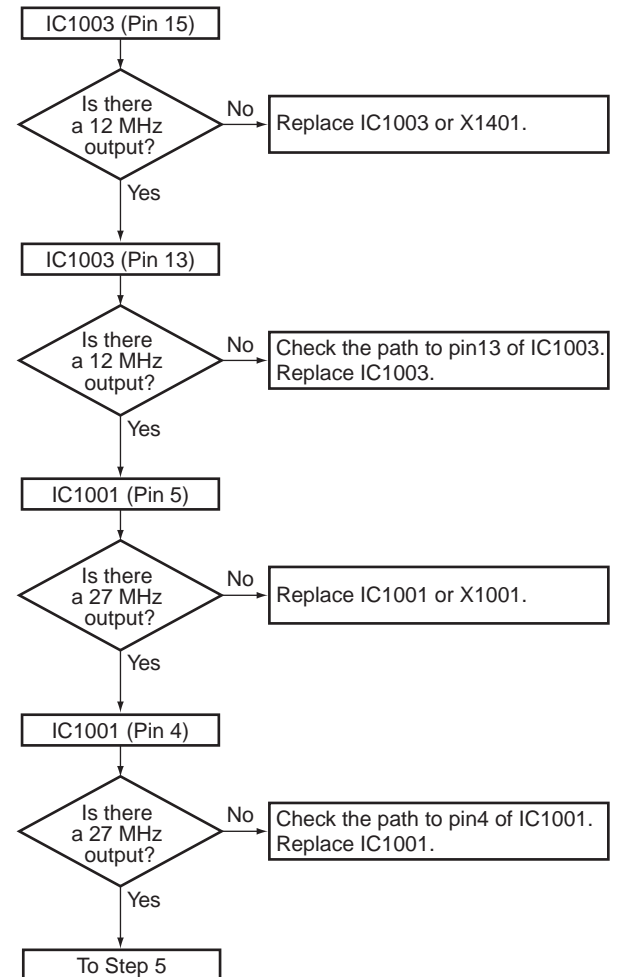

A Step 5: IN/OUTPUT Diagnosis

* When connected the equipment to IN1(BD/DVD);

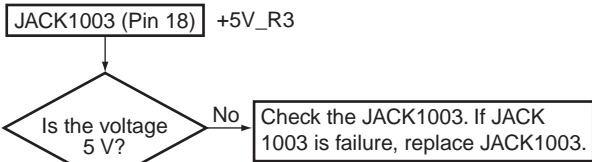

B

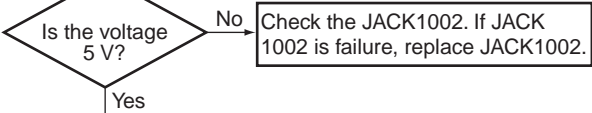

C

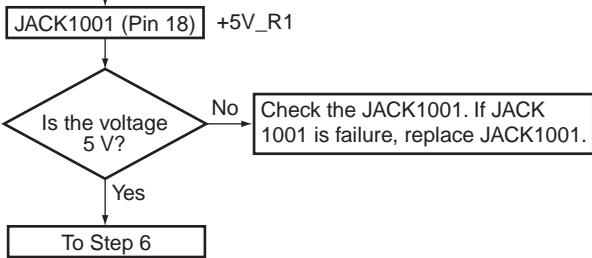

Step 6: Hot plug detect

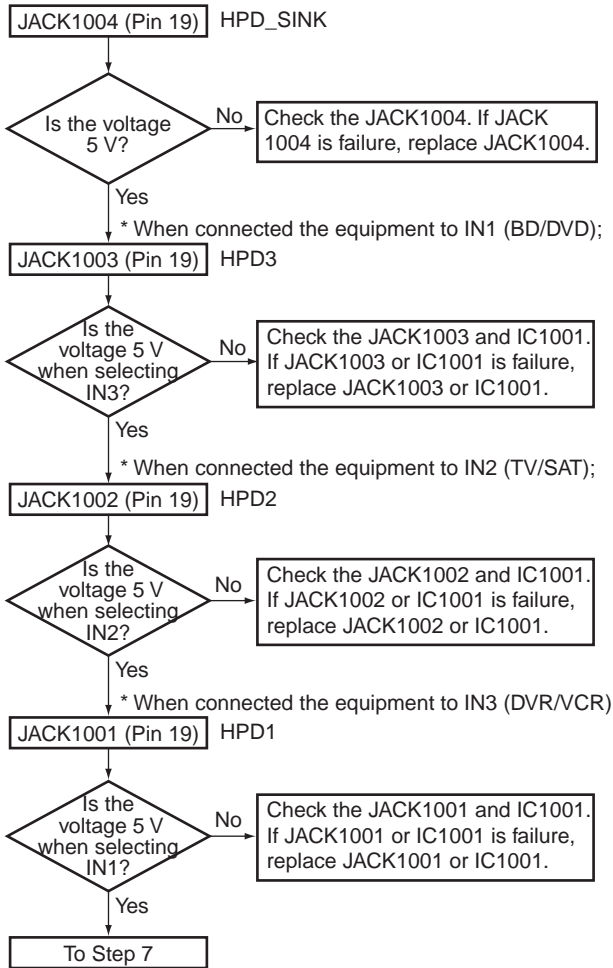

D

E

F

Step 7: SDA /SCL

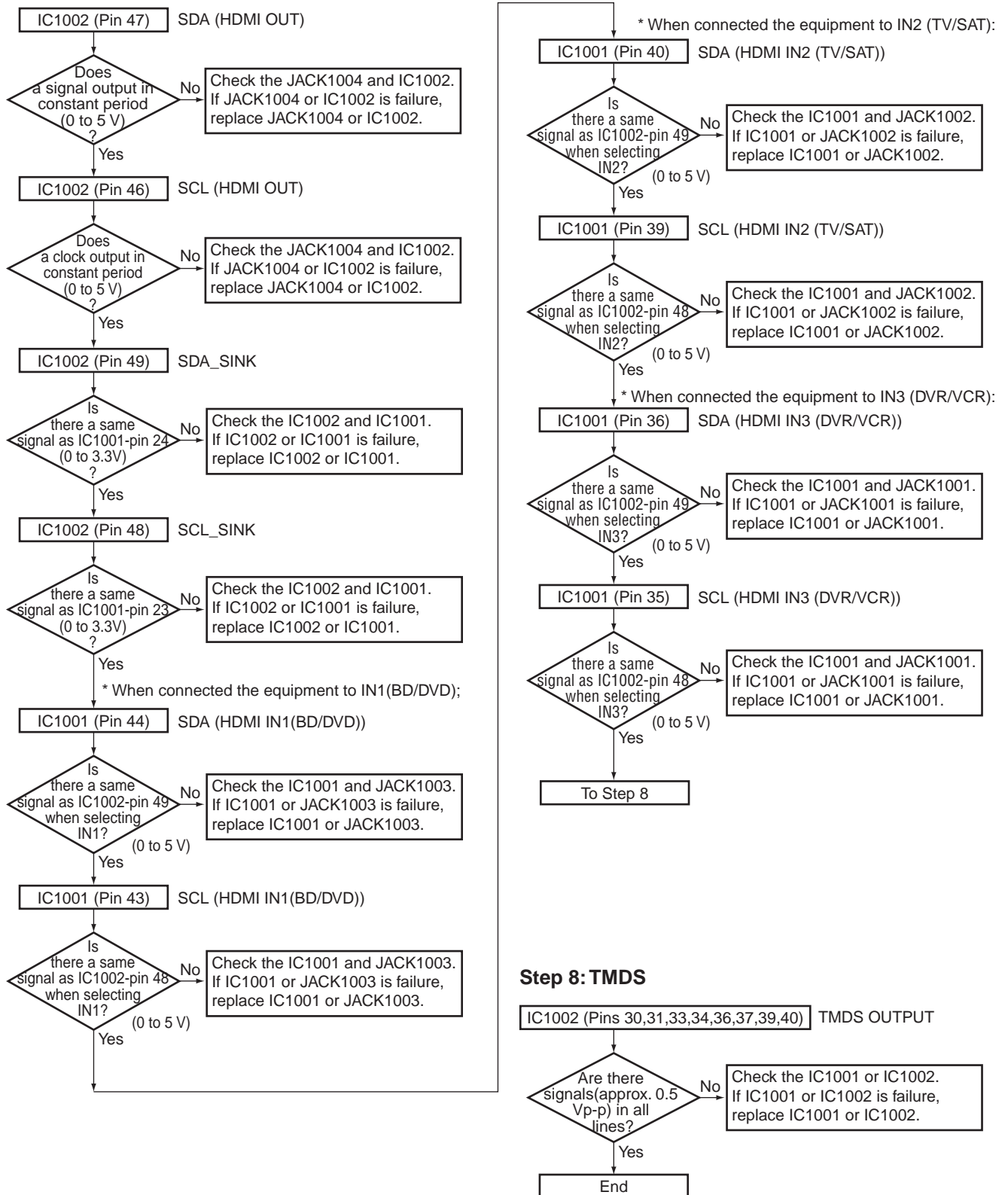

5.2 DETECTION CIRCUIT

[1] DC Protection Circuit Diagram

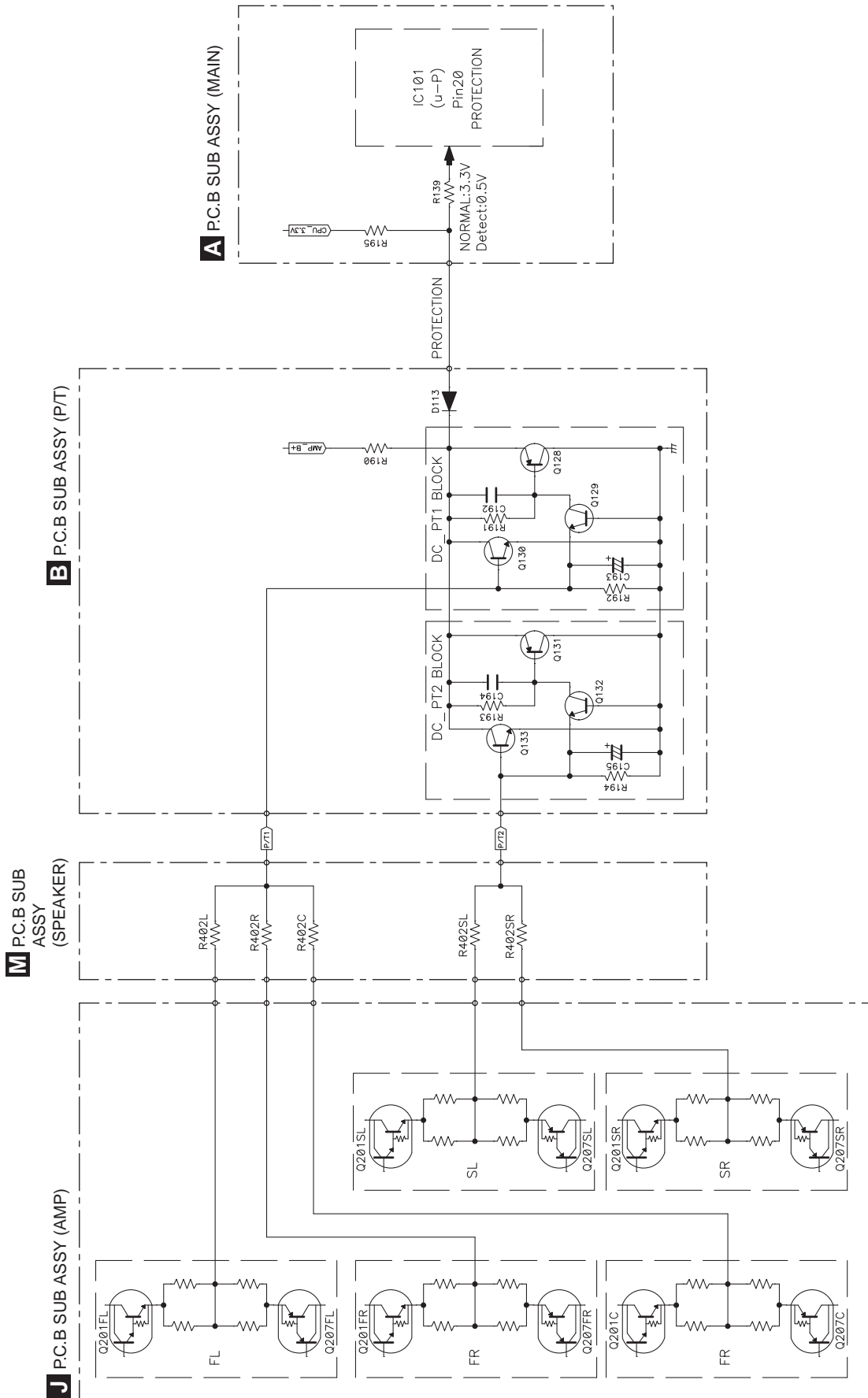

[2] Overload Protection Circuit Diagram

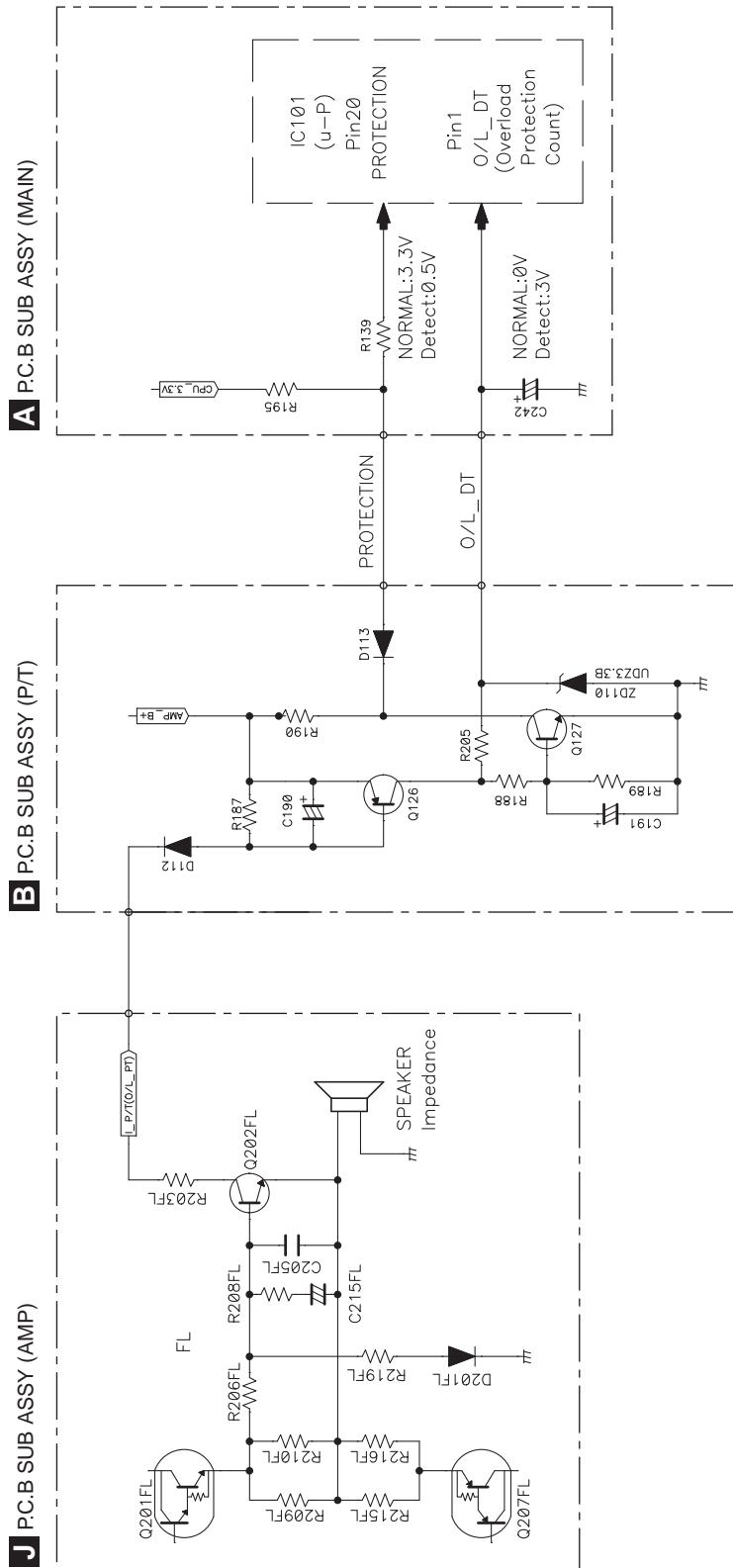

A B C D E F

[3] Power DC Protection Circuit Diagram

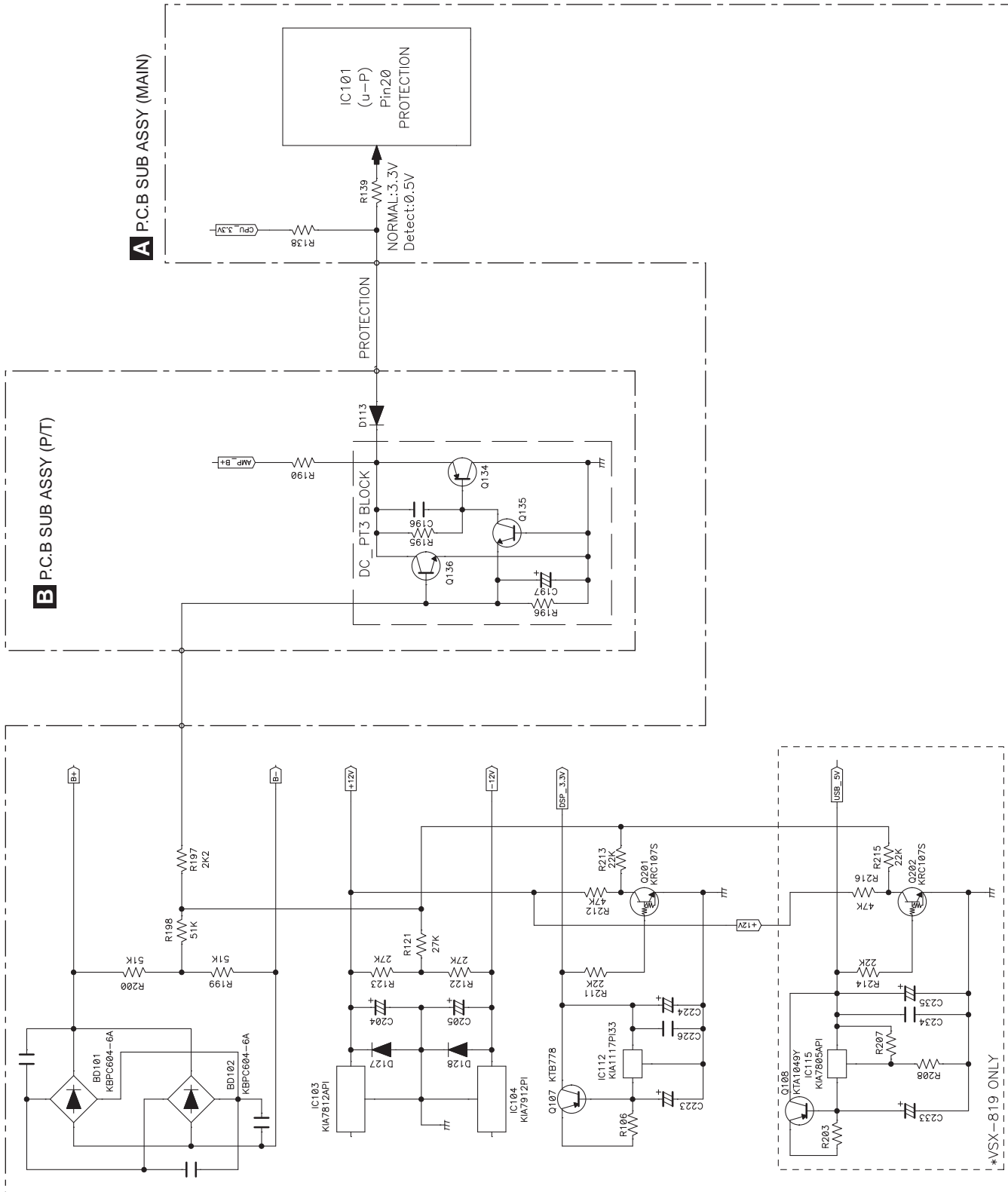

5

6

7

8

6. SERVICE MODE

6.1 SERVICE MODE

[1] Display mode for numbers of protection detections

[Purpose]

The numbers of detections for various protection processes are displayed.

[How to enter/exit]

During Standby mode, simultaneously press and hold the [PRESET -] and [STANDBY/ON] keys for 2 seconds to enter this mode.

The display will return to the normal indication when no key operation is performed for 5 seconds.

[Basic operations]

Key Operation	FL Display	Time (sec.)	Description of Indications
(STANDBY state)			
[PRESET -] + [STANDBY/ON] (Initial display)		5 (-> normal) *1	Number of DC error detections
[ENTER key]		5 (-> normal) *1	Number of OVERLOAD error detections
[ENTER key]		5 (-> normal) *1	Number of abnormal-temperature error detections
[ENTER key]	(Initial display)		

*1 "5 (-> normal)" denotes that the display will return to the normal indication when no key operation is performed for 5 seconds.

*2 Variable range: 0-255

VSX-519V-K

5

6

7

8

33

A [2] Reset mode for numbers of protection detections



[Purpose]

For clearing all the counts of protection detections.
(This mode resets the counts of protection detections.)

[How to enter/exit]

During Standby mode, simultaneously press and hold the [STANDARD SURROUND] and [STANDBY/ON] keys for 10 seconds to enter this mode.
The display will return to the normal indication when no key operation is performed for 5 seconds.

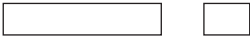
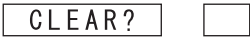
[Basic operations]

Key Operation	FL Display	Time (sec.)	Description of Indications
(STANDBY state)			
[STANDARD SURROUND] + [STANDBY/ON] (press and hold the keys for 10 seconds.)		5 (-> normal) *1	
[ENTER key]	↓		
(Counter Clear end)		5 (-> normal) *1	
(Normal display)	 *2	usually	

*1 "5 (-> normal)" denotes that the display will return to the normal indication when no key operation is performed for 5 seconds.

*2 Indication when the BD/DVD function is selected

[Detailed explanations]

- When the procedures for Reset mode for numbers of protection detections are completed, all the counters will be reset to "000."
- Prohibitions:
The protection detection counts cannot be cleared (reset to 000) with the MEMORY CLEAR process. They can only be cleared when the procedures of Reset mode are completed.

E

F

[3] The unit's operation when an error is detected

[Purpose]

- The unit's operation when a DC/OVER/TEMP error is detected is described here.
- How to cancel the status after detection of a DC error is described here, because no key input will be accepted after a DC error detection.

[Basic operations]

3.1 DC (AMP is abnormality) error detection

Key Operation	FL Display	Time (sec.)	Description of Indications
(Normal display)	<input type="text" value="BD/DVD"/> <input type="checkbox"/>	usually	Normal display
(DC detection)	<input type="text" value="BD/DVD"/> <input type="checkbox"/>		
↓ (Auto) (RECEIVER POWER OFF) *1, *2	<input type="text"/> <input type="checkbox"/>		

3.2 OVERLOAD (overcurrent) error detection

Key Operation	FL Display	Time (sec.)	Description of Indications
(Normal display)	<input type="text" value="BD/DVD"/> <input type="checkbox"/>	usually	Normal display
(OVERLOAD detection)	<input type="text" value="BD/DVD"/> <input type="checkbox"/>		
↓ (Auto) (RECEIVER POWER OFF) *1	<input type="text"/> <input type="checkbox"/>		

3.3 TEMP (AMP overheat) error detection

Key Operation	FL Display	Time (sec.)	Description of Indications
(Normal display)	<input type="text" value="BD/DVD"/> <input type="checkbox"/>	usually	Normal display
(TEMP detection)	<input type="text" value="BD/DVD"/> <input type="checkbox"/>		
↓ (Auto) (RECEIVER POWER OFF) *1	<input type="text"/> <input type="checkbox"/>		

*1 The time required for the unit to be shut off after an error is detected depends on the circuit configuration.

*2 If the unit is automatically shut off after a DC error is detected, no key input will be accepted afterward. (The power will not be turned ON.)

To turn it on again, see "3.4 How to cancel the status after detection of a DC error" below.

A key input will not be inhibited after an OVERLOAD/TEMP error is detected. (The unit can be turned ON.)

3.4 How to cancel the status after detection of the DC error

Key Operation	FL Display	Time (sec.)	Description of Indications
(STANDBY state) [ADVANCED SURROUND] + [STANDBY/ON] (press and hold the keys for 2 seconds.)	<input type="text"/> <input type="checkbox"/>	usually	Normal display
↓ (Normal display)	<input type="text" value="BD/DVD"/> <input type="checkbox"/>		

[Detailed explanations] Simultaneously holding the [ADVANCED SURROUND] and [STANDBY/ON] keys on the front panel pressed for 2 seconds will cancel Key Input Inhibition mode after a DC error detection and turn the unit ON.

7. DISASSEMBLY

7.1 DISASSEMBLY

Note 1: Even if the unit shown in the photos and illustrations in this manual may differ from your product, the procedures described here are common.

Note 2: For performing the diagnosis shown below, the following jigs for service is required:

- 10P board to board extension jig cable (GGD1628)
- 8P board to board extension jig cable (GGD1629)
- Board to board extension jig cable (GGD1630)

1. Discharging

[1] P.C.B SUB ASSY (MAIN) Capacitor (C179, C180)

[Procedures]

- (1) Unplug the power cord.
- (2) Disconnect the 8P CONNECTOR wire that connects the CN202 of the P.C.B SUB Assy (AMP) and CP107 of the P.C.B SUB Assy (MAIN) from the CP107.
- (3) Connect CP107 B+ (Pins 5 and 6) and B- (Pins 7 and 8, respectively) terminals, using resistor leads with 47-100 ohms (2 W or higher), for discharging.
*Discharging time: 30-60 seconds, depending on the level of resistance.
- (4) Check that the voltage between the B+ and GND terminals, as well as that between the B- and GND terminals, is less than 1 V, using a tester.
*Be sure to connect the GND terminal of the tester to the chassis.
*If the voltage is still 1 V or higher, repeat Step (3).

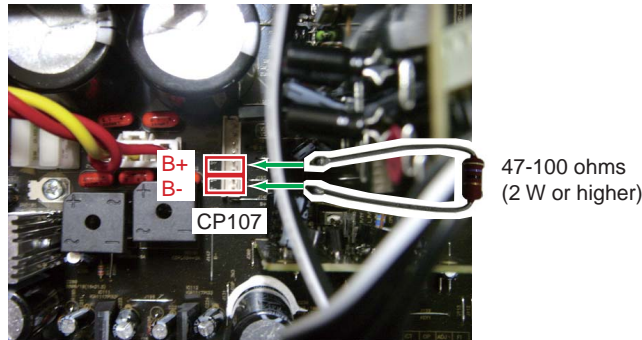

[2] FL-30 V Capacitor

[Procedures]

- (1) Unplug the power cord.
- (2) Connect CP704 -30 V (Pins 1 and 2) of the P.C.B SUB Assy (FRONT) and GND (Pins 3 and 4, respectively), using resistor leads with 47-100 ohms (2 W or higher), for discharging.
*Discharging time: 5-10 seconds, depending on the level of resistance.
- (3) Check that the voltage between the -30 V and GND terminals is less than 1 V, using a tester.
*Be sure to connect the GND terminal of the tester to the chassis.
*If the voltage is still 1 V or higher, repeat Step (2).

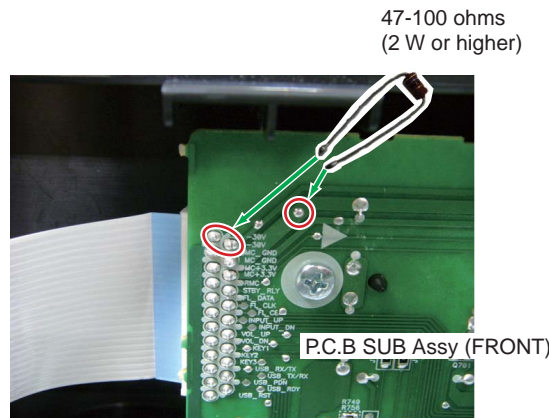

2. Notes on Ground Points Connection

[Note 1]

When reassembling after disassembling the product for repair, before connecting the power cord, make sure that the 2P wire from the CN206 of the P.C.B SUB Assy (DSP) is connected to the CP803 of the P.C.B TOTAL Assy (INPUT).

If the power is turned ON without the above connection, the CODEC IC (IC109: AK4588) of the P.C.B SUB Assy (DSP) may be damaged.

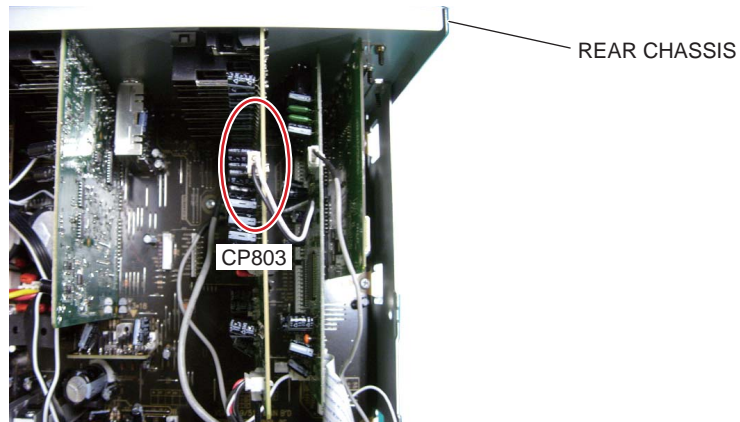

[Note 2]

During repair, before checking the P.C.B SUB Assy (MAIN), etc., with the rear chassis removed, be sure to connect the GND terminal of the main capacitor to the rear chassis (TUNER PACK CHASSIS), as shown below, then connect the power cord.

**Without grounding connection, the protection circuit will be activated.
After repairing, be sure to remove the ground wire before reassembling.**

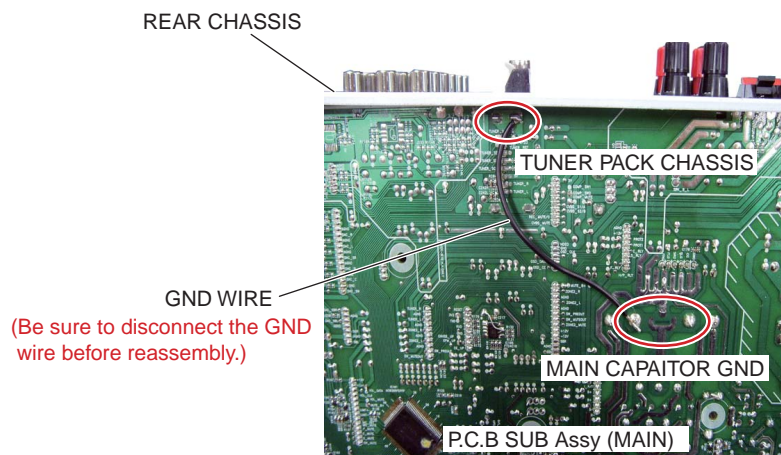

3. Diagnosis of PCB's

[1] Front Panel Section

Remove the bonnet by removing the 10 screws.

1. Remove the five screws. (BBZ30P080FTB)

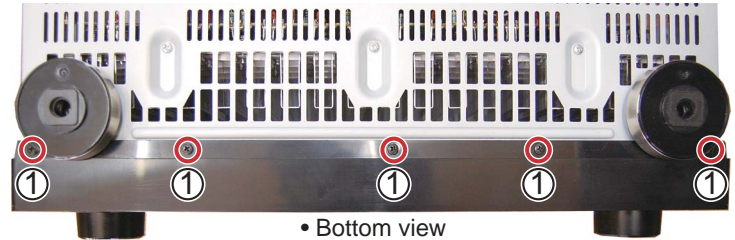

2. Remove the two screws. (BBZ30P080FTC)

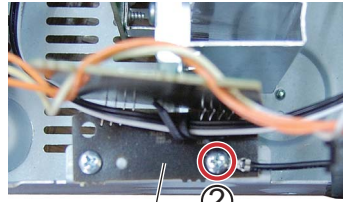

3. Remove the two screws.
 4. Unhook the two hooks.
 5. Arrange the front panel section as shown in the photo below.

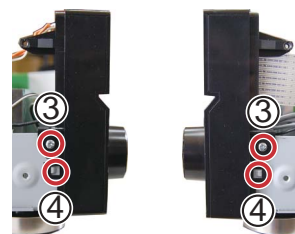

Front panel section

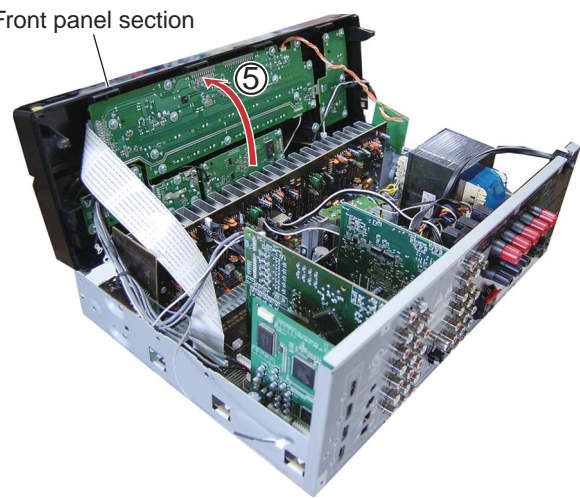

[2] Heat sink Section

Caution: Heat sink section in work becomes hot, and be careful with it.

Remove the bonnet by removing the 10 screws.

1. Remove the seven screws. (BBZ30P080FTC)

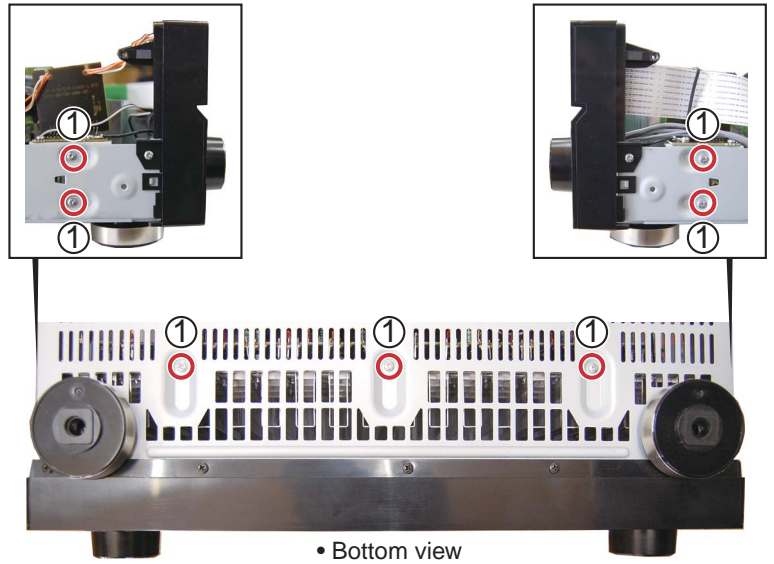

2. Remove the four screws. (BBZ30P080FTC)

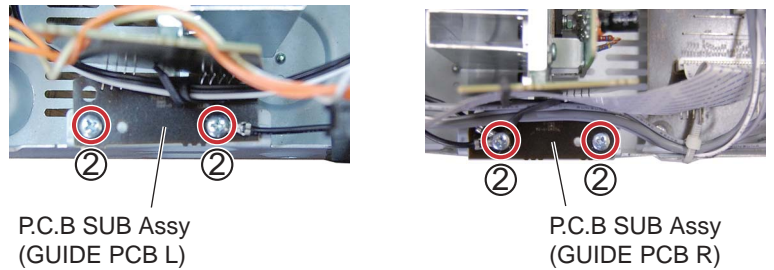

3. Disconnect the two connectors.

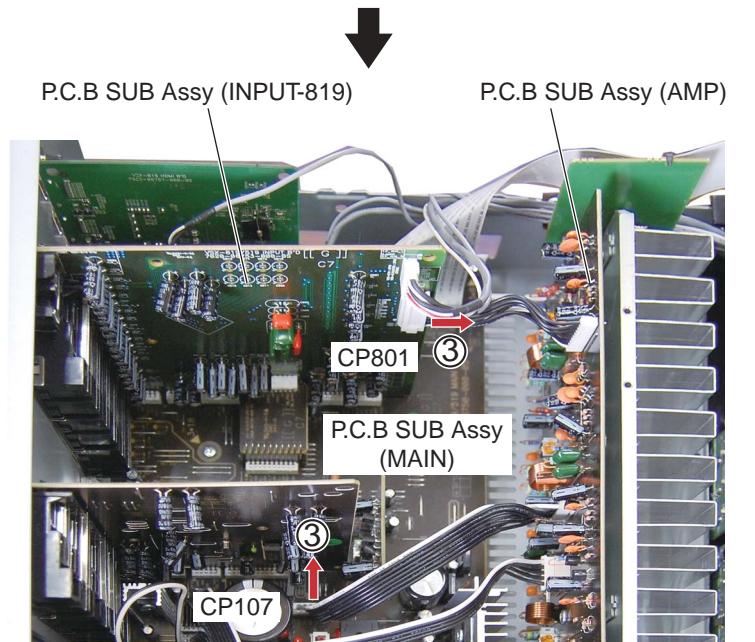

- A 4. Connect the two extension jig cables.
- 5. Rotate the heat sink section in the direction of the arrow.

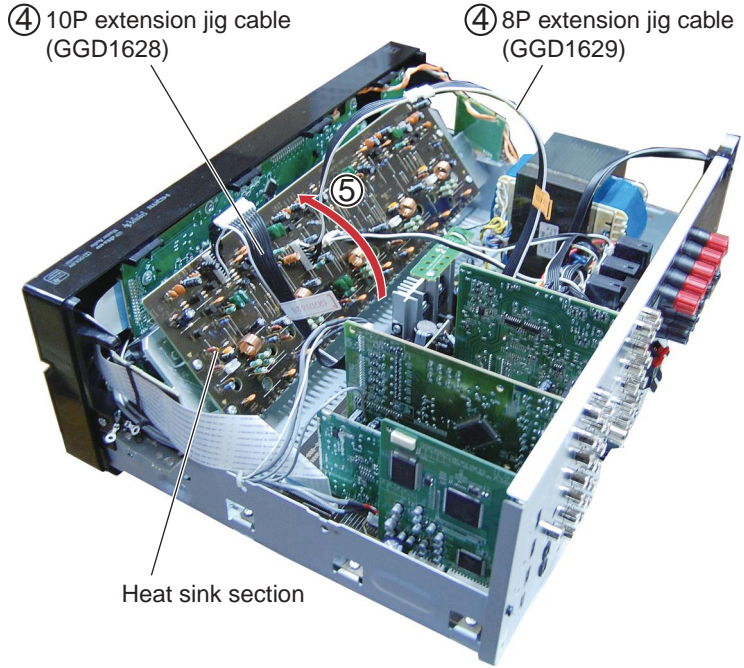

B

C

Note:
 The Power transistor and heat sink on the P.C.B SUB Assy (MAIN) come closer.
 Make sure that they will not come into contact.

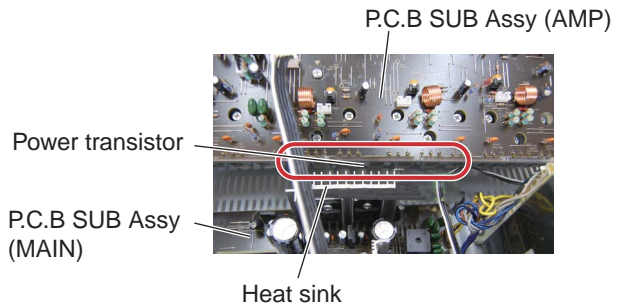

D



E

F

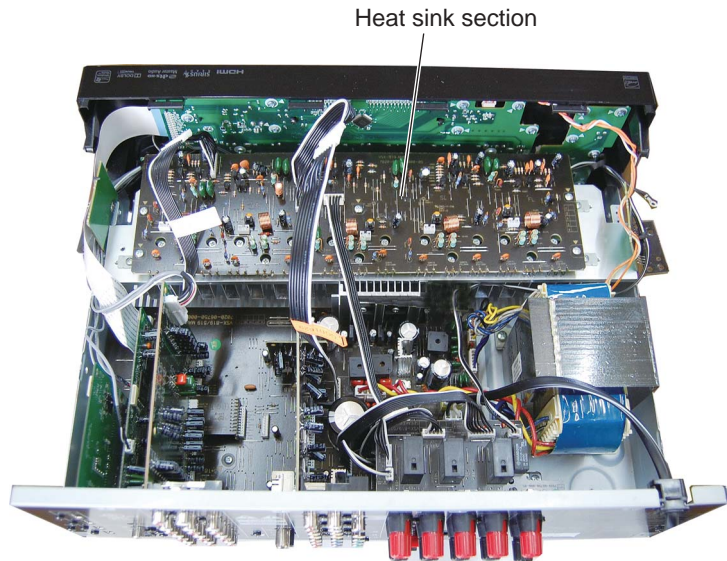

[3] P.C.B SUB Assy (MAIN)

Remove the bonnet by removing the 10 screws.

1. Remove the five screws. (BBT30P100FTB)

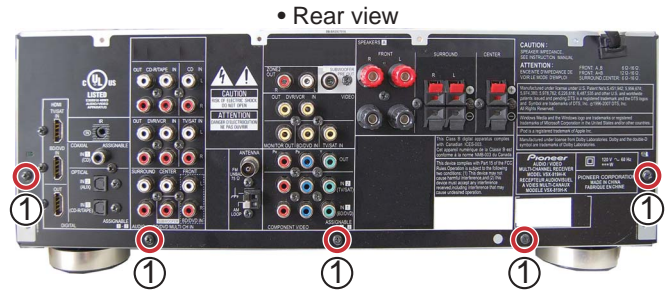

2. Remove the three screws. (BBZ30P080FTC)

3. Remove the six screws. (BBZ30P180FTC)

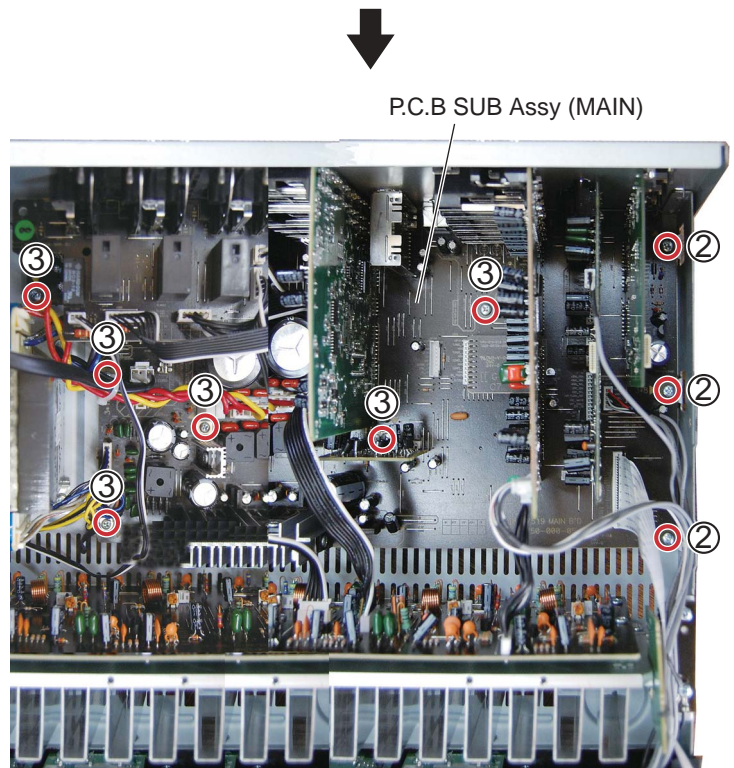

4. Arrange the unit as shown in the photo below.

5. Connect the chassis ground.

See "2. Notes on Ground Points Connection".

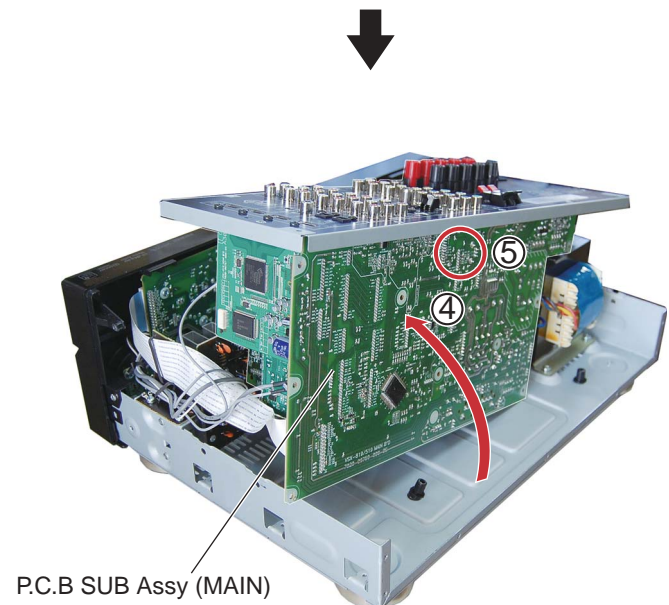

A [4] P.C.B SUB Assy (DSP)

Remove the bonnet by removing the 10 screws.

1. Remove the three screws. (B020930083B10-IL)
2. Remove the 18 screws. (BBT30P100FTB)
3. Remove the five screws. (BBT30P100FTB)

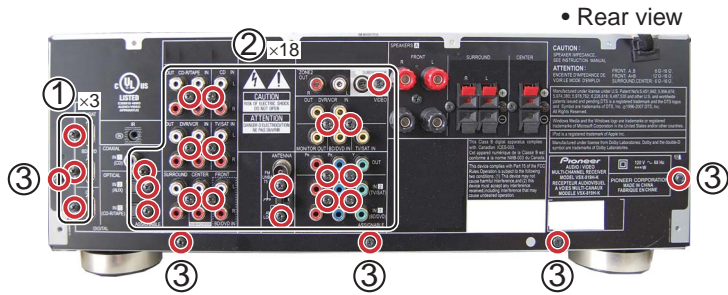

B

C

5. Remove the rear chassis.
6. Remove the P.C.B SUB Assy (DSP).

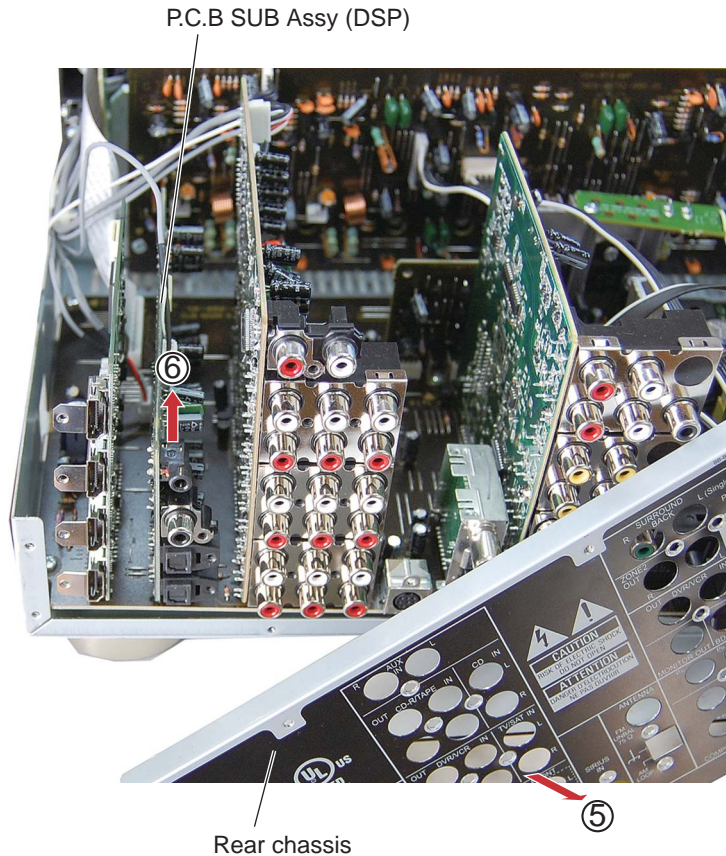

F

7. Disconnect the two connectors.

Note:

When reassembling after disassembling the product for repair, before connecting the power cord, make sure that the 2P wire from the CN206 of the P.C.B SUB Assy (DSP) is connected to the CP803 of the P.C.B TOTAL Assy (INPUT).

See “2. Notes on Ground Points Connection”.

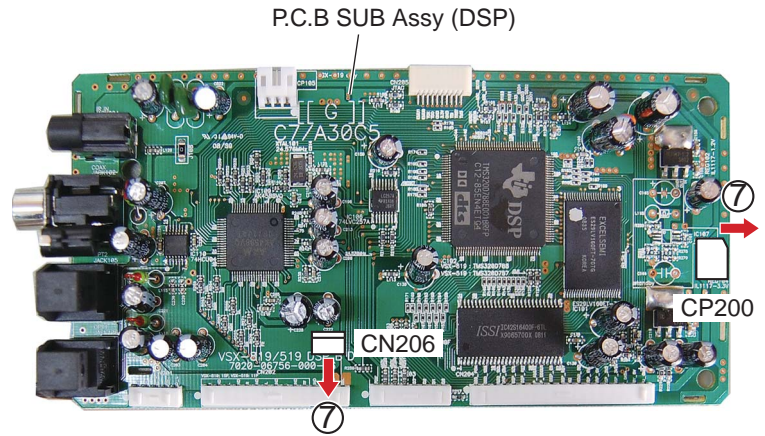

8. Reassembling the rear chassis.

9. Connect the board to board extension jig cable.

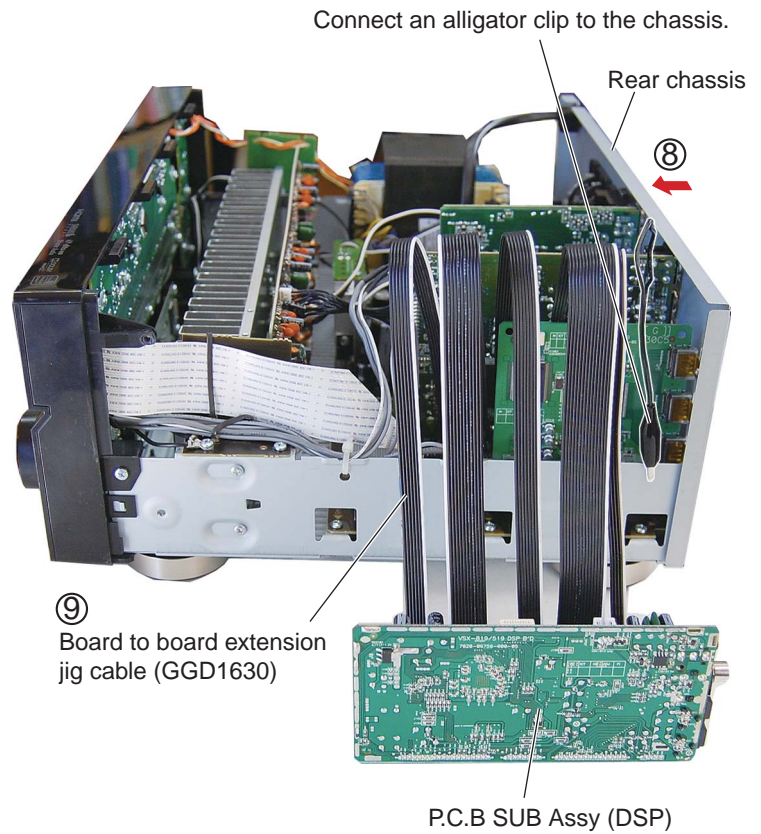

8. EACH SETTING AND ADJUSTMENT

8.1 IDLE CURRENT ADJUSTMENT

1. Idle Current Adjustment

Measurement Points	Adjustment Points	Procedure
TP201FL 3PIN : TEST POINT(+) TP201FL 1PIN : TEST POINT(-)	VR201FL	① Turn on the power. ② Perform aging for one minute. ③ Connect a digital voltmeter to the measurement point. ④ Turn the adjustment VR so that the voltage becomes in $2.0 \text{ mV} \pm 0.2 \text{ mV}$. (Condition : No signal and no load)
TP201FR 3PIN : TEST POINT(+) TP201FR 1PIN : TEST POINT(-)	VR201FR	
TP201C 3PIN : TEST POINT(+) TP201C 1PIN : TEST POINT(-)	VR201C	
TP201SL 3PIN : TEST POINT(+) TP201SL 1PIN : TEST POINT(-)	VR201SL	
TP201SR 3PIN : TEST POINT(+) TP201SR 1PIN : TEST POINT(-)	VR201SR	

• Adjustment Point and Measurement Points.... see fig1.

J P.C.B SUB ASSY (AMP)

SIDE A

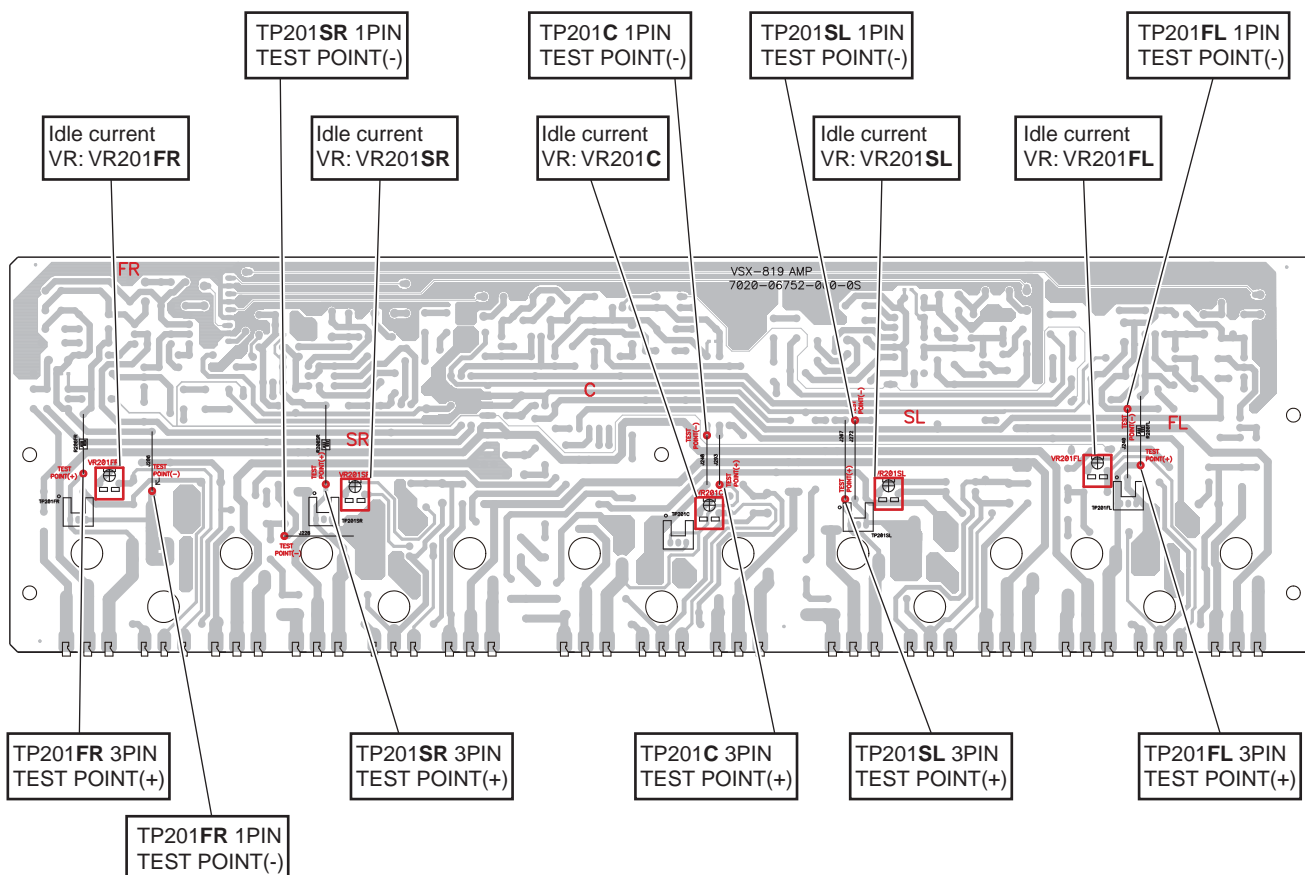

[fig 1.]



5



6



7



8



A



B



C



D



E



F



5



6

VSX-519V-K



7



8



9. EXPLODED VIEWS AND PARTS LIST

NOTES: ● Parts marked by "NSP" are generally unavailable because they are not in our Master Spare Parts List.

● The \triangle mark found on some component parts indicates the importance of the safety factor of the part. Therefore, when replacing, be sure to use parts of identical designation.

● Screws adjacent to ∇ mark on product are used for disassembly.

● For the applying amount of lubricants or glue, follow the instructions in this manual.

(In the case of no amount instructions, apply as you think it appropriate.)

9.1 PACKING SECTION

POLY BAG PACKING STYLE

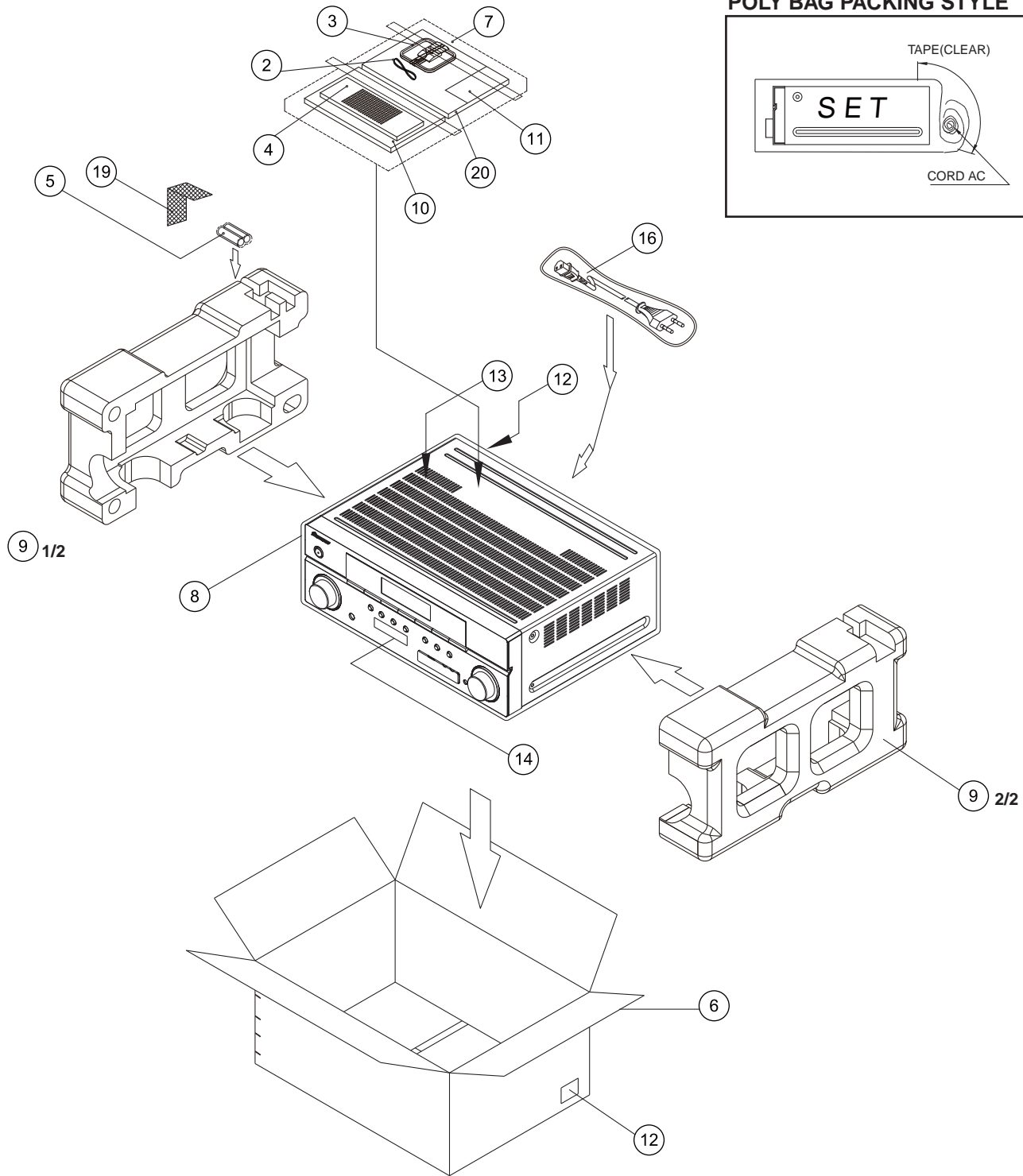
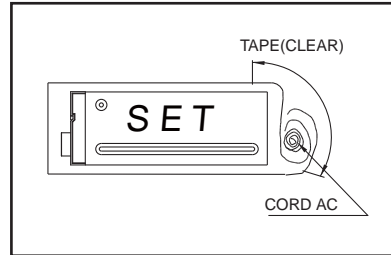

PACKING SECTION PARTS LIST

<u>Mark No.</u>	<u>Description</u>	<u>Part No.</u>	<u>Mark No.</u>	<u>Description</u>	<u>Part No.</u>
	1 •••••		NSP 11	Warranty Card	ARY7127
	2 FM Wire Antenn	E605010070001-IL	NSP 12	Label	VRW1629
	3 AM Loop Antenna	E601016000010-IL	13	Label Trans	5507000003270-IL
	4 Remote Control	See Contrast table (2)	NSP 14	Label Getter 519	5507000003610-IL
NSP	5 Dry Cell Batteries (AAA size IEC R03)	G670001R50210-IL	15	•••••	
	6 Box, Gift 519	See Contrast table (2)	⚠ 16	Power Cord	L068250160020-IL
NSP	7 Poly Bag	•••••	17	•••••	
	8 PE, Sheet	6327040059000-IL	18	•••••	
	9 Cushion, Snow	6230212404000-IL	NSP 19	Tape	•••••
	10 Operating Instructions (En/Fr/Ru)	5707000001920-IL	20	Operating Instructions (It/De/Nl/Es)	5707000002100-IL

(2) CONTRAST TABLE

VSX-519V-K/MYSXCN5 and VSX-519V-S/MYSXCN5 are constructed the same except for the following:

Mark	No.	Symbol and Description	VSX-519V-K/ MYSXCN5	VSX-519V-S/ MYSXCN5
	4	Remote Control	8300753600010-IL	8300753700010-IL
	6	Box, Gift 519K_MY	6007211340020-IL	Not used
	6	Box, Gift 519S_MY	Not used	6007211340000-IL

9.2 EXTERIOR SECTION

1

2

3

4

A

B

C

D

E

F

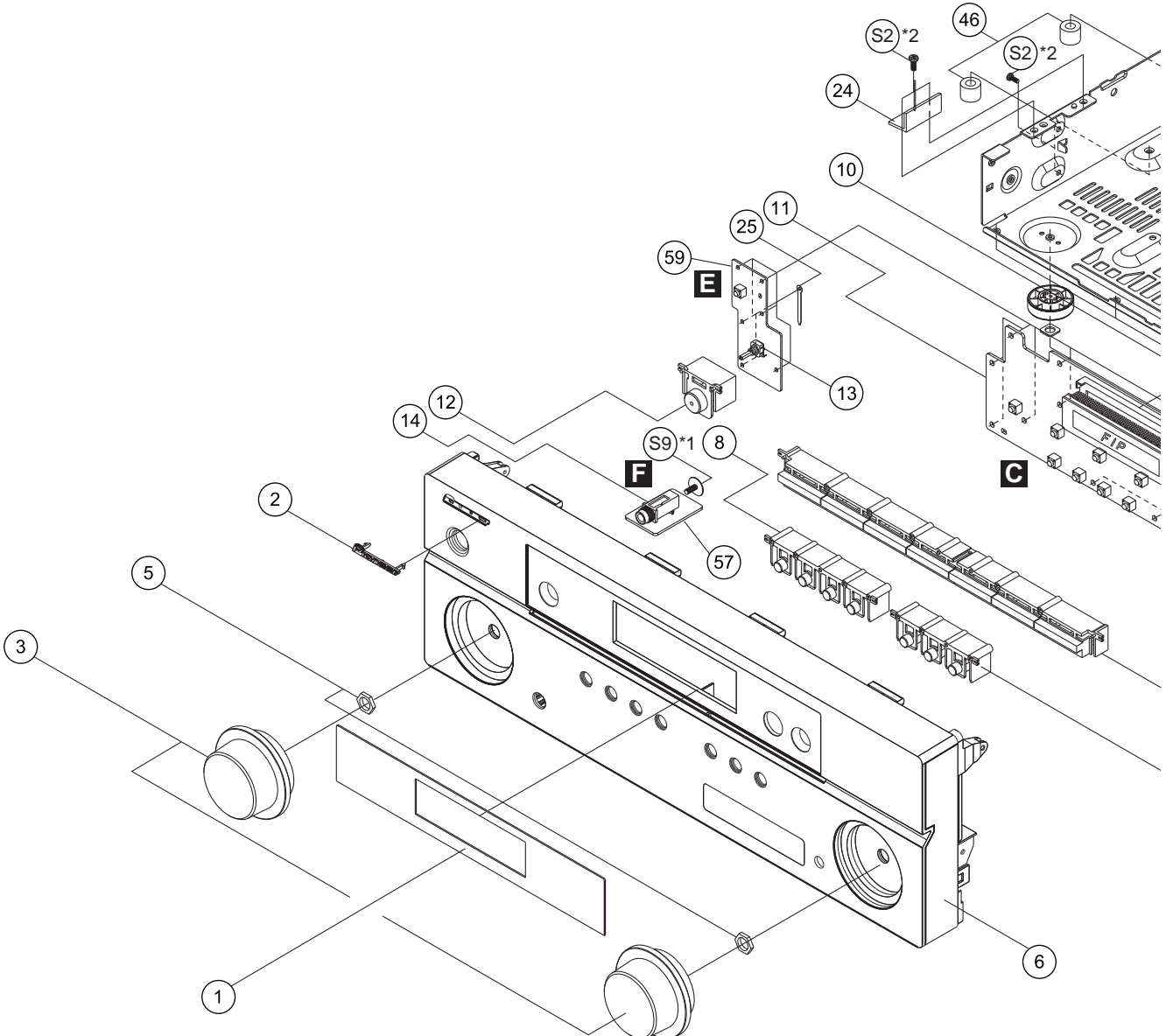
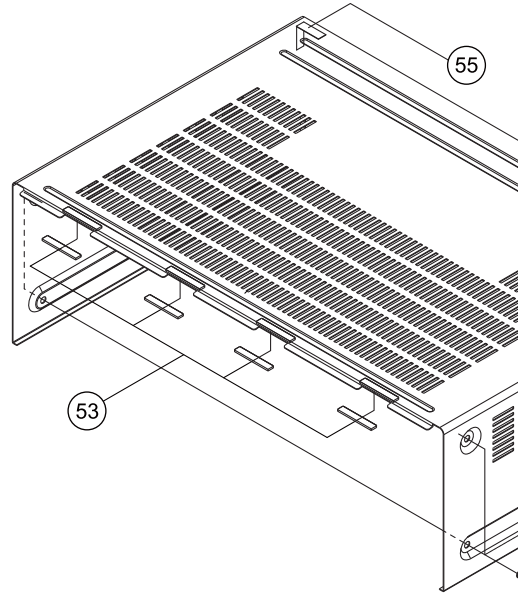
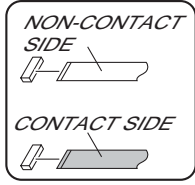

1

2

3

4

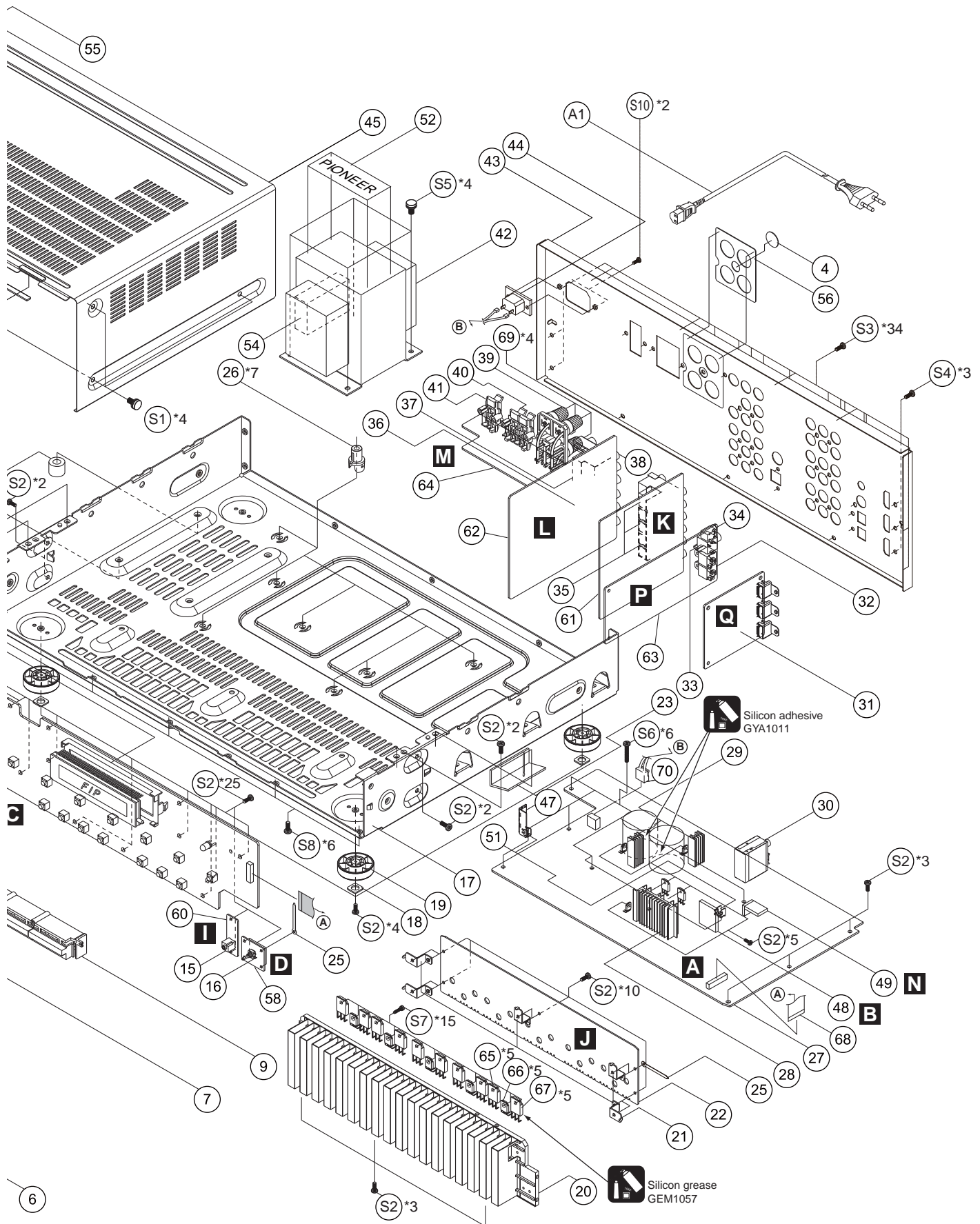

EXTERIOR SECTION PARTS LIST

	<u>Mark No.</u>	<u>Description</u>	<u>Part No.</u>	<u>Mark No.</u>	<u>Description</u>	<u>Part No.</u>
				50	•••••	
A	1	Window	5077212673010-IL			
	2	Pioneer Badge B	See Contrast table (2)			
	3	Knob	See Contrast table (2)	NSP 51	Bracket	•••••
	4	Cushion	4050211745000-IL	52	Label Trans	5507000003270-IL
NSP	5	Nut	•••••	53	Sheet	1210210235000-IL
	6	Panel	See Contrast table (2)	54	Cushion	4050211365000-IL
	7	Button	See Contrast table (2)	55	Cushion	4050211385000-IL
	8	Button	See Contrast table (2)			
	9	Button	See Contrast table (2)	56	Sheet	1210210772000-IL
	10	Holder	432004078301A-IL	57	P.C.B SUB ASSY (HEADPHONE)	7028067512010-IL
B	11	P.C.B SUB ASSY (FRONT)	7028067511020-IL	58	P.C.B SUB ASSY (VOLUME)	7028067513010-IL
	12	Button	See Contrast table (2)	59	P.C.B SUB ASSY (FUNCTION)	7028067514010-IL
	13	SW,Encoder (S701)	G121123050020-IL	60	P.C.B SUB ASSY (PORTABLE)	7028067518010-IL
	14	Jack,D6.5 (JA701)	G402PJ619AG0Y-IL	61	P.C.B SUB ASSY (INPUT)	7028067531020-IL
	15	Jack,D3.5 (JA703)	G401PJ354H70Y-IL	62	P.C.B SUB ASSY (VIDEO-519)	7028067551010-IL
	16	SW,Encoder (S702)	G121123040010-IL	63	P.C.B SUB ASSY (DSP)	7028067561020-IL
NSP	17	Chassis	3200212676000-IL	64	P.C.B SUB ASSY (SPEAKER-519)	7028067601030-IL
	18	Cushion	4050211605000-IL	⚠ 65	Transistor (Q2071-Q2075)	J5011560Y0000-IL
	19	Foot	4000210391000-IL	⚠ 66	SEMI,TR/GE NPN 2SC (Q2051-Q2055)	J502396400010-IL
C	NSP 20	Heat Sink	2120211378000-IL	⚠ 67	Transistor (Q2011-Q2015)	J5032390Y0000-IL
	21	Bracket	4010056906010-IL	68	Cable,Flat Card 1.25	N712192533810-IL
	22	P.C.B SUB ASSY (AMP)	7028067521010-IL	69	Bushing	2410040353010-IL
	23	P.C.B SUB ASSY (GUIDE-R)	7028067503010-IL	70	CN,Wire	L000211020040-IL
	24	P.C.B SUB ASSY (GUIDE-L)	7028067502010-IL			
NSP	25	Clamp	•••••	S1	Screw	See Contrast table (2)
	26	Spacer	•••••	S2	Screw	BBZ30P080FTC
NSP	27	P.C.B SUB ASSY (MAIN)	7028067501020-IL	S3	Screw	BBT30P100FTB
	28	Heat Sink	2120210958010-IL	S4	Screw, Tap Tite	B020930083B10-IL
	29	Heat Sink	2120000818020-IL	S5	Screw	B028940101B10-IL
D	30	Tuner (JA101)	E903104100030-IL	S6	Screw	BBZ30P180FTC
	31	P.C.B SUB ASSY (HDMI-519)	7028067581010-IL	S7	Screw Tapping Assy	B018230141H11-IL
	32	Optical Receiver (JA105, JA106)	E100116500040-IL	S8	Screw	BBZ30P080FTB
	33	TER,RCA 1Pin (JA102)	G600107A0000Y-IL	S9	Screw	1500001456010-IL
	34	Jack,D3.5 (JA804)	G40130802000Y-IL	S10	Screw, Tap Tite	B020030083F10-IL
	35	TER,RCA 6Pin (JA802-JA804)	G603060056000-IL	⚠ A1	Power Cord	L068250160020-IL
	36	TER,RCA 9Pin (JA1003)	G607902AD016Y-IL			
	37	TER,RCA (JA1002)	G608610D0209Y-IL			
E	38	TER,RCA 3Pin (JA1001)	G606319A1B13Y-IL			
NSP	39	TER,Board Screw 4P	•••••			
	40	TER,Board Push 4P (JA402)	G594408SA030Y-IL			
	41	TER,Board Push 2P (JA102, JA403)	G592212A0300Y-IL			
⚠	42	Power Trans	8200960610520-IL			
	43	Chassis	See Contrast table (2)			
	44	Socket,Power AC	G430000180010-IL			
	45	Cabinet	See Contrast table (2)			
	46	Cushion	4050211205000-IL			
F	47	P.C.B SUB ASSY (H/P GUIDE)	7028067506010-IL			
	48	P.C.B SUB ASSY (P/T)	7028067505010-IL			
	49	P.C.B SUB ASSY (CNT)	7028067504010-IL			

(2) CONTRAST TABLE

VSX-519V-K/MYSXCN5 and VSX-519V-S/MYSXCN5 are constructed the same except for the following:

Mark	No.	Symbol and Description	VSX-519V-K/ MYSXCN5	VSX-519V-S/ MYSXCN5
	2	Pioneer Badge B	XAM3006	Not used
	2	Pioneer Name Plate	Not used	VAM1129
	3	Knob	5080211931100-IL	5087211931000-IL
	6	Panel	3067214161100-IL	3067214161200-IL
	7	Button	5090213751100-IL	5097213751000-IL
	8	Button	5090213761100-IL	5097213761000-IL
	9	Button	5097213771100-IL	5097213771000-IL
	12	Button	5090213741100-IL	5097213741000-IL
	43	Chassis	3207212686110-IL	3207212686100-IL
	45	Cabinet	3007211276010-IL	3007211276000-IL
	S1	Screw	BBT40P080FTB	BBT40P080FNI

A

B

C

D

E

F

- When ordering service parts, be sure to refer to "EXPLODED VIEWS and PARTS LIST" or "PCB PARTS LIST".
- The ⚠ mark found on some component parts indicates the importance of the safety factor of the part. Therefore, when replacing, be sure to use parts of identical designation.
-  : The power supply is shown with the marked box.

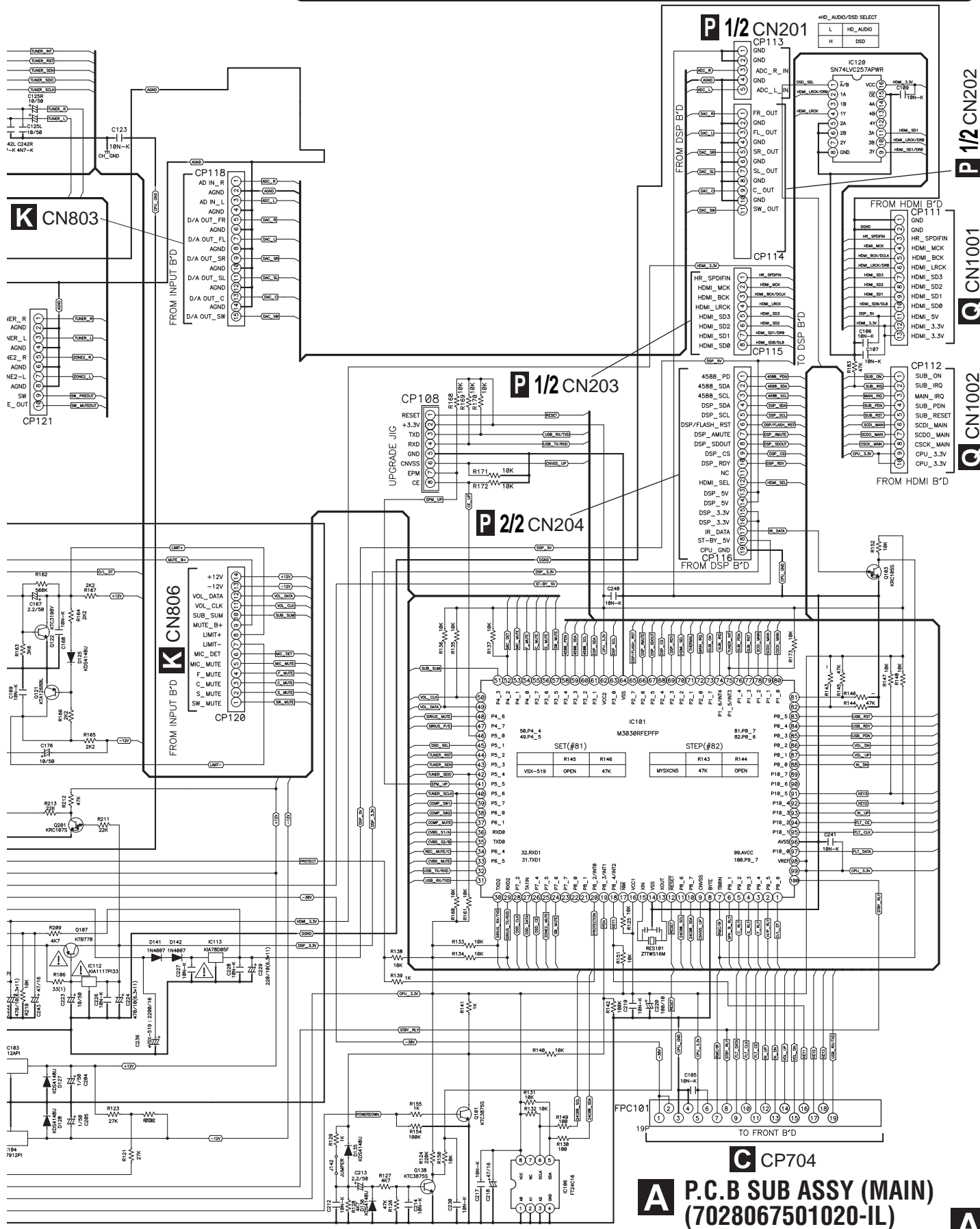

A P.C.B SUB ASSY (MAIN)
(7028067501020-IL)

10.2 P.C.B SUB ASSYS (FRONT), (VOLUME), (FUNCTION), (HEADPHONE) and (PORTABLE)

A
B
C
D
E
F

C P.C.B SUB ASSY (FRONT) (7028067511020-IL)

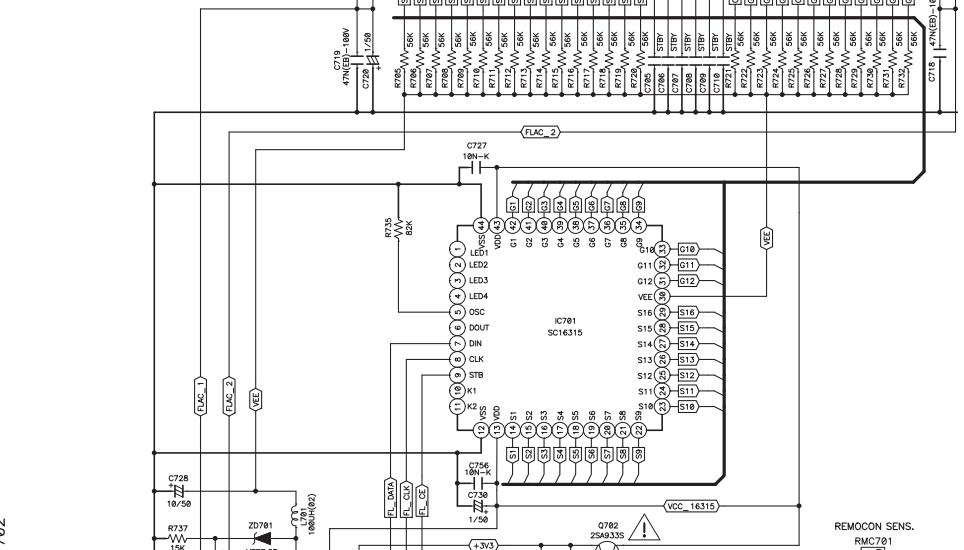
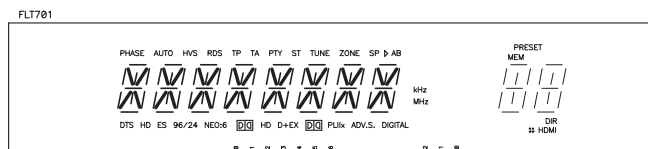

D P.C.B SUB ASSY (VOLUME) (7028067513010-IL)

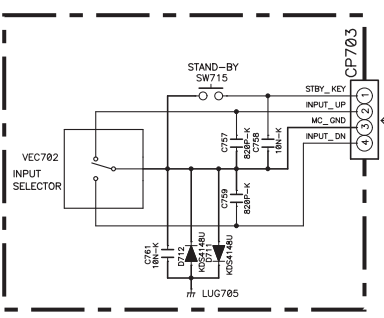
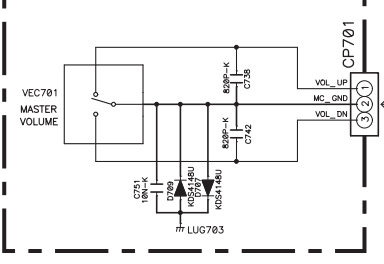

E P.C.B SUB ASSY (FUNCTION) (7028067514010-IL)

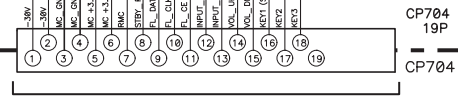

A FPC101

FROM MAIN B'D

VSX-519V-K

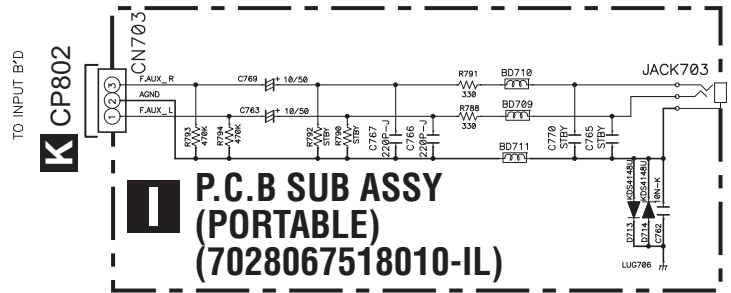
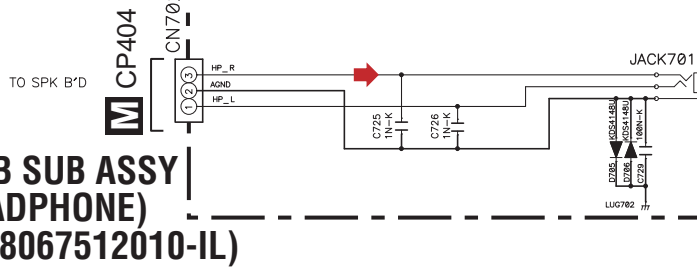
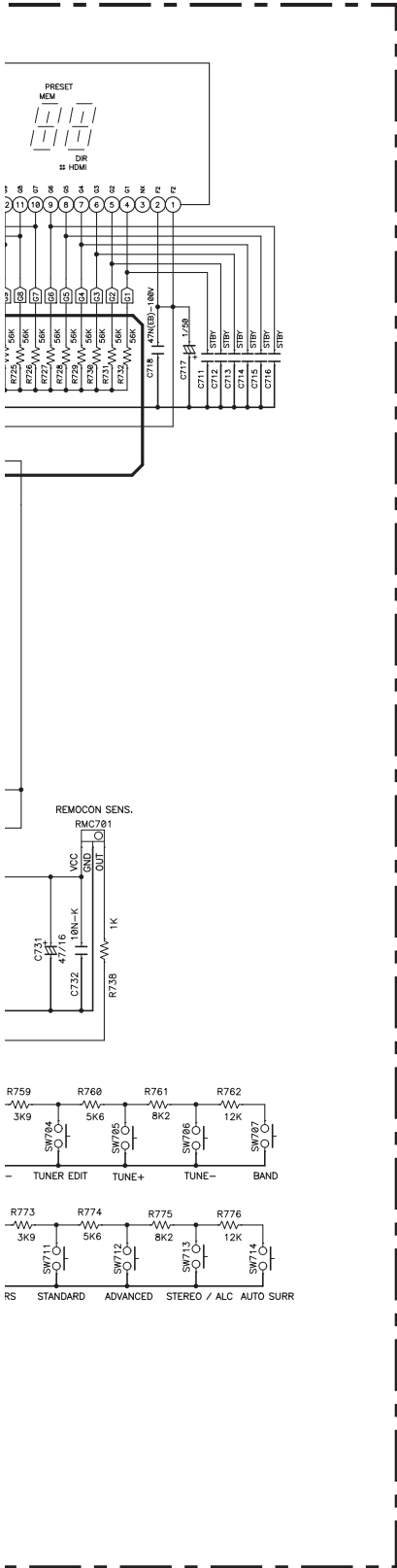

Video Signal Route

Audio Signal Route (L ch)

10.3 P.C.B SUB ASSY (AMP)

J P.C.B SUB ASSY (AMP) (7028067521010-IL)

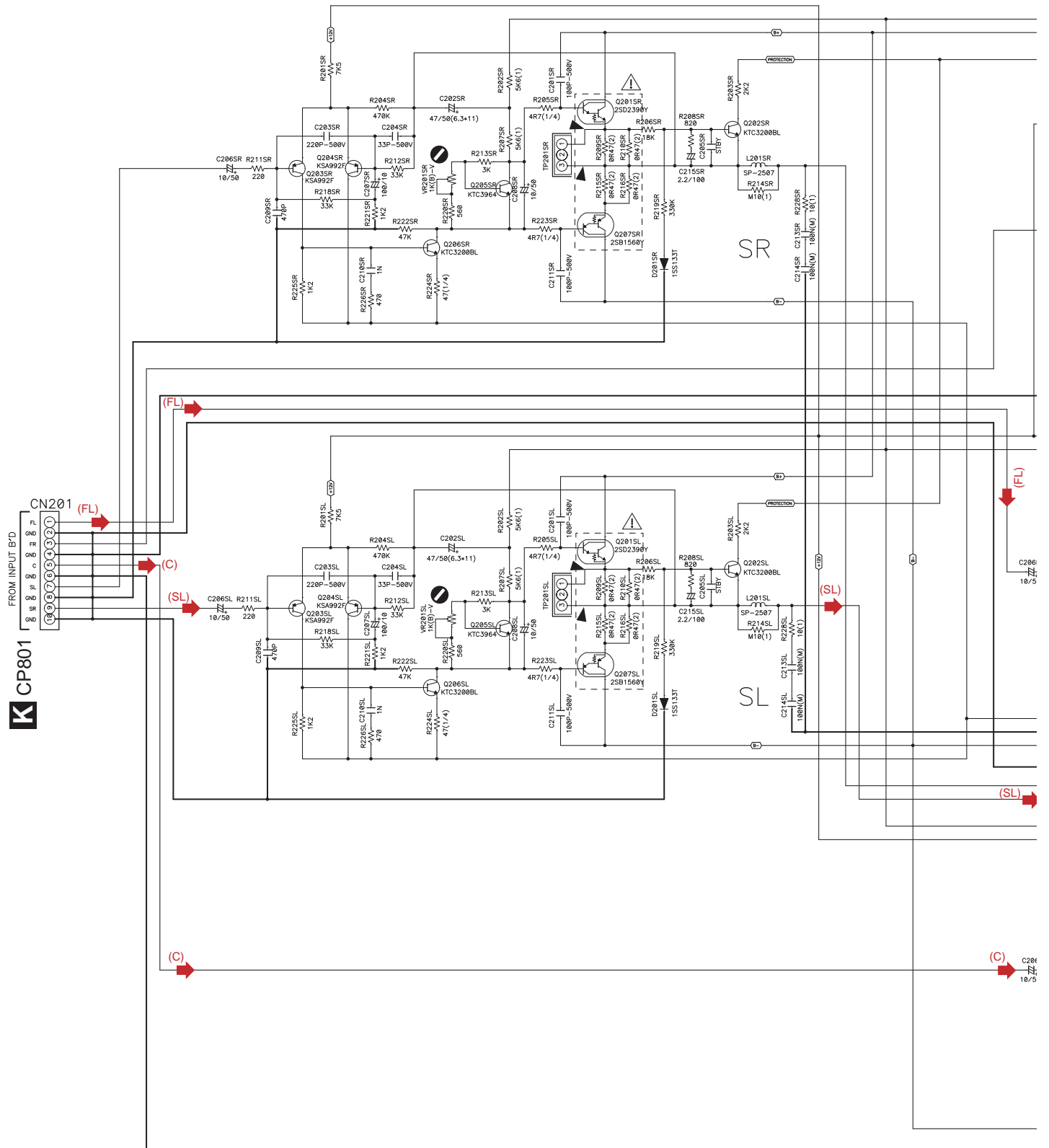

- (FL) → : Audio Signal Route (Front L ch)
- (SL) → : Audio Signal Route (Surround L ch)
- (C) → : Audio Signal Route (Center ch)

J

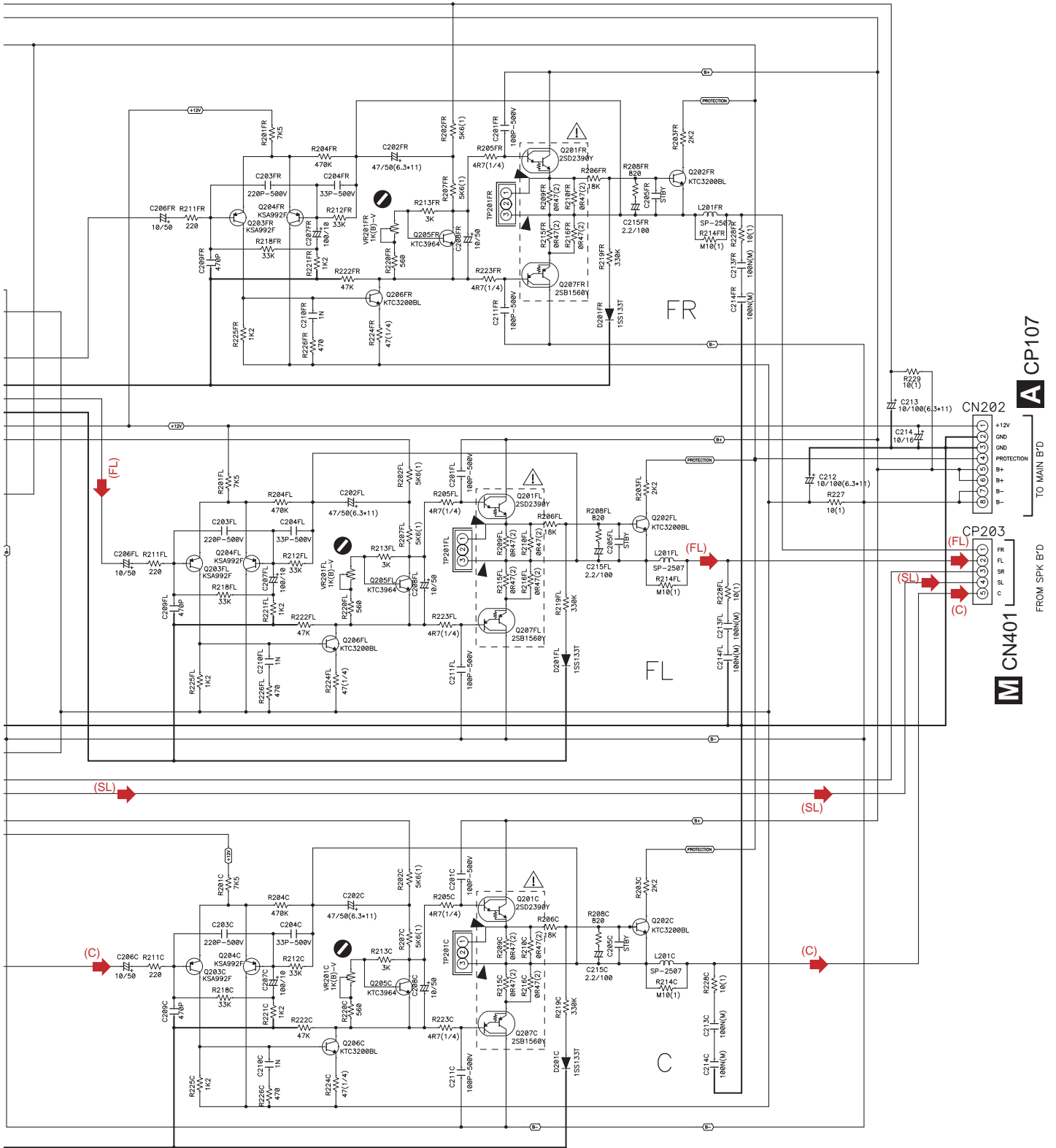

VSX-519-K

10.4 P.C.B SUB ASSY (INPUT)

K P.C.B SUB ASSY (INPUT) (7028067531020-IL)

A
B
C
D
E
F

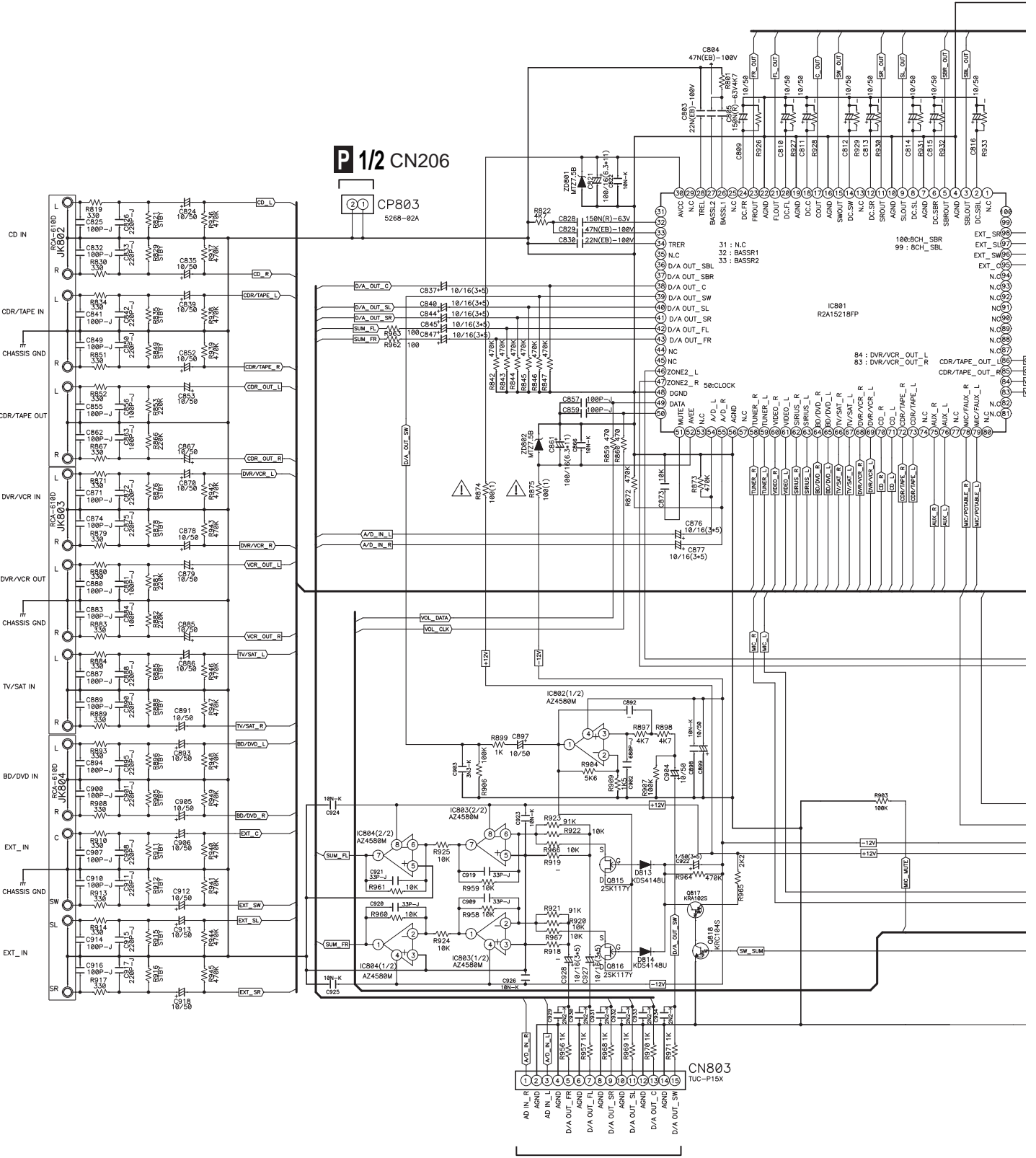

A CP118

TO MAIN B'D

VSX-519V-K



(FL) → Audio Signal Route (Front L ch)
 (SL) → Audio Signal Route (Surround L ch)
 (C) → Audio Signal Route (Center ch)

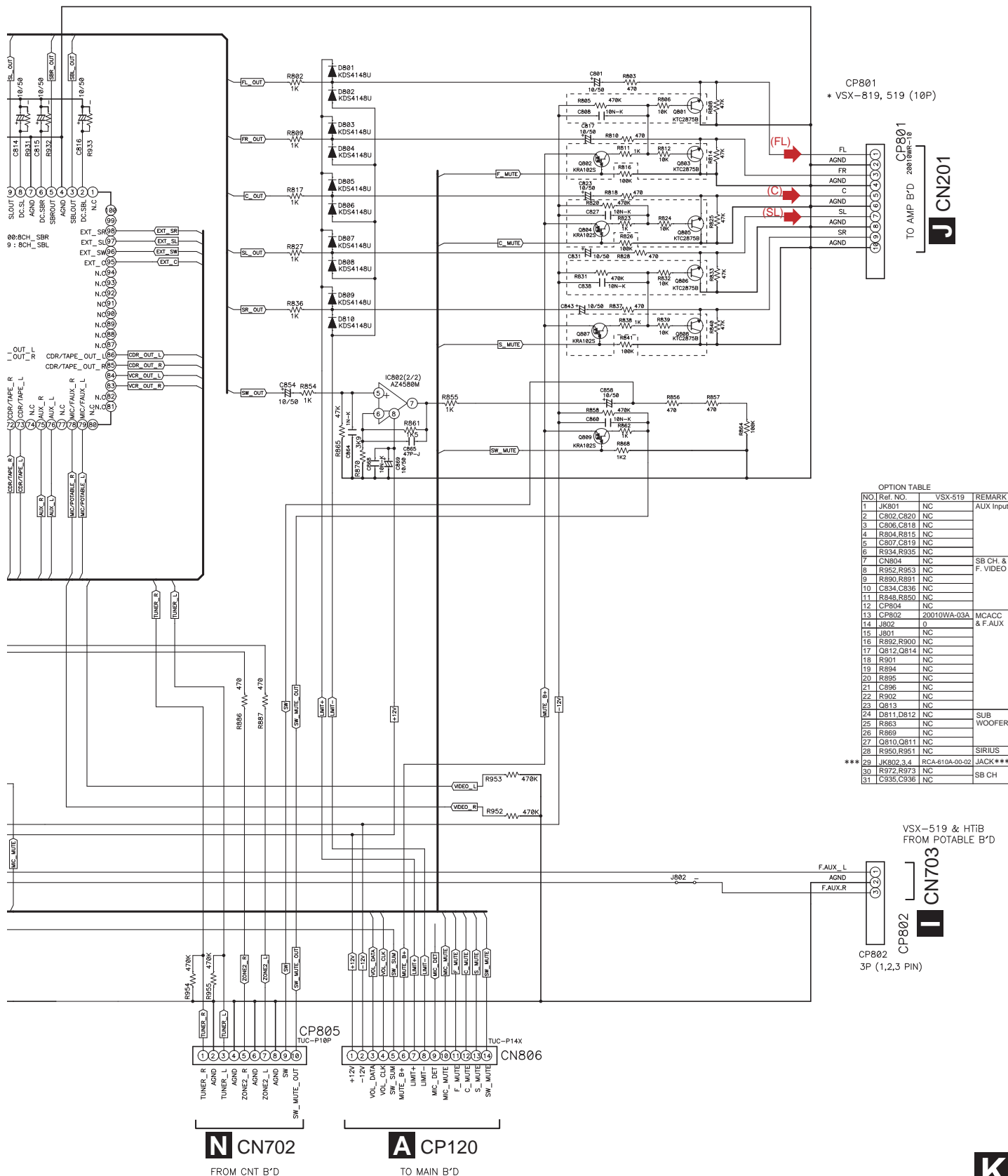

OPTION TABLE

NO	Ref. NO.	VSX-519	REMARK
1	JK801	NC	AUX Input
2	C802,C820	NC	
3	C806,C818	NC	
4	R804,R815	NC	
5	C807,C819	NC	
6	R934,R935	NC	
7	CN804	NC	SB CH. & F. VIDEO
8	R952,R953	NC	
9	R890,R891	NC	
10	C834,C836	NC	
11	R848,R850	NC	
12	CP804	NC	
13	CP802	20010WA-03A	MCACC & F.AUX
14	J802	0	
15	J801	NC	
16	R892,R900	NC	
17	C812,C814	NC	
18	R901	NC	
19	R894	NC	
20	R895	NC	
21	C896	NC	
22	R902	NC	
23	C813	NC	
24	DB11,DB12	NC	SUB WOOFER
25	R863	NC	
26	R869	NC	
27	C810,C811	NC	
28	R950,R951	NC	SIRIUS
29	JK802,3,4	RCA-610A-00-02	JACK***
30	R972,R973	NC	
31	C935,C936	NC	SB CH

VSX-519 & HTIB FROM POTABLE B'D

N CN702
FROM CNT B'D

A CP120
TO MAIN B'D

VSX-519V-K



10.5 P.C.B SUB ASSY (VIDEO-519)

P.C.B SUB ASSY (VIDEO-519) (7028067551010-I)

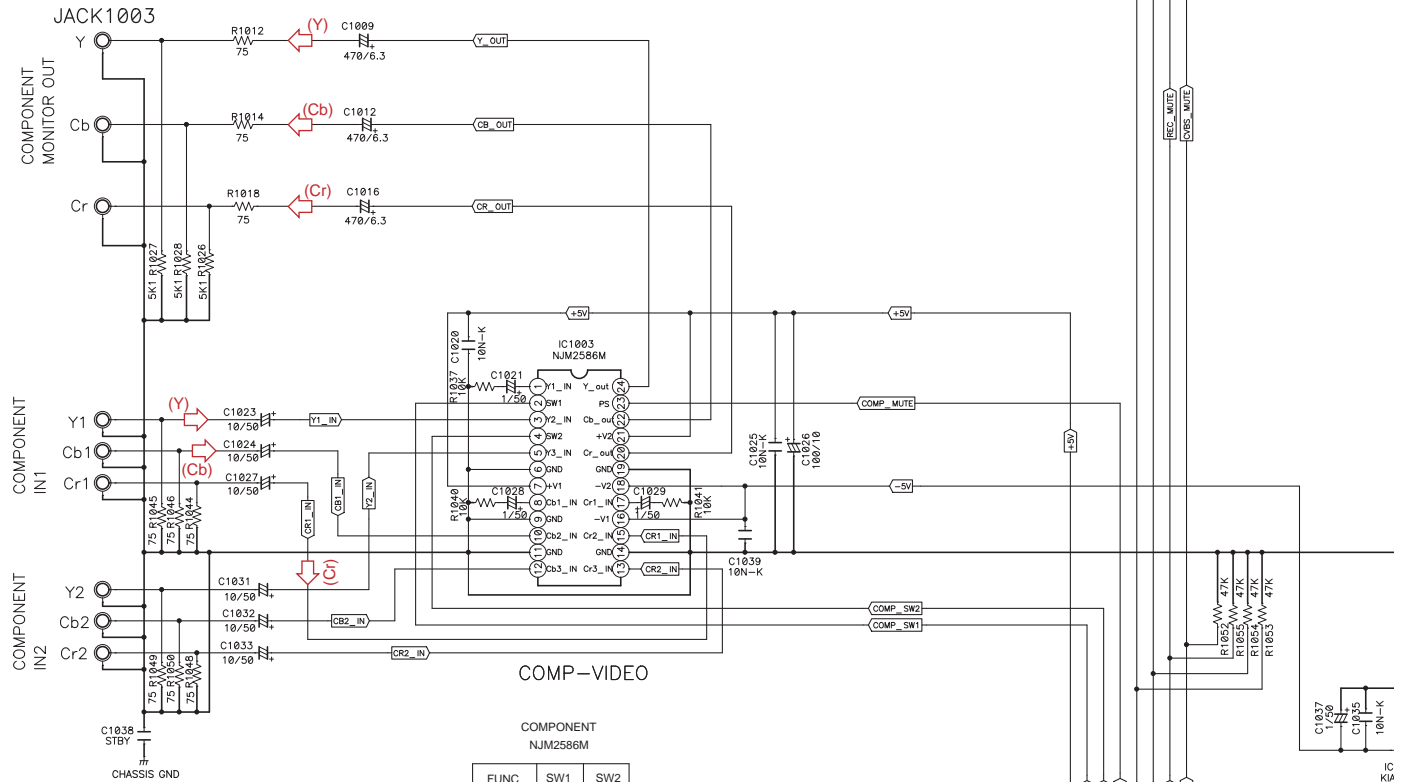
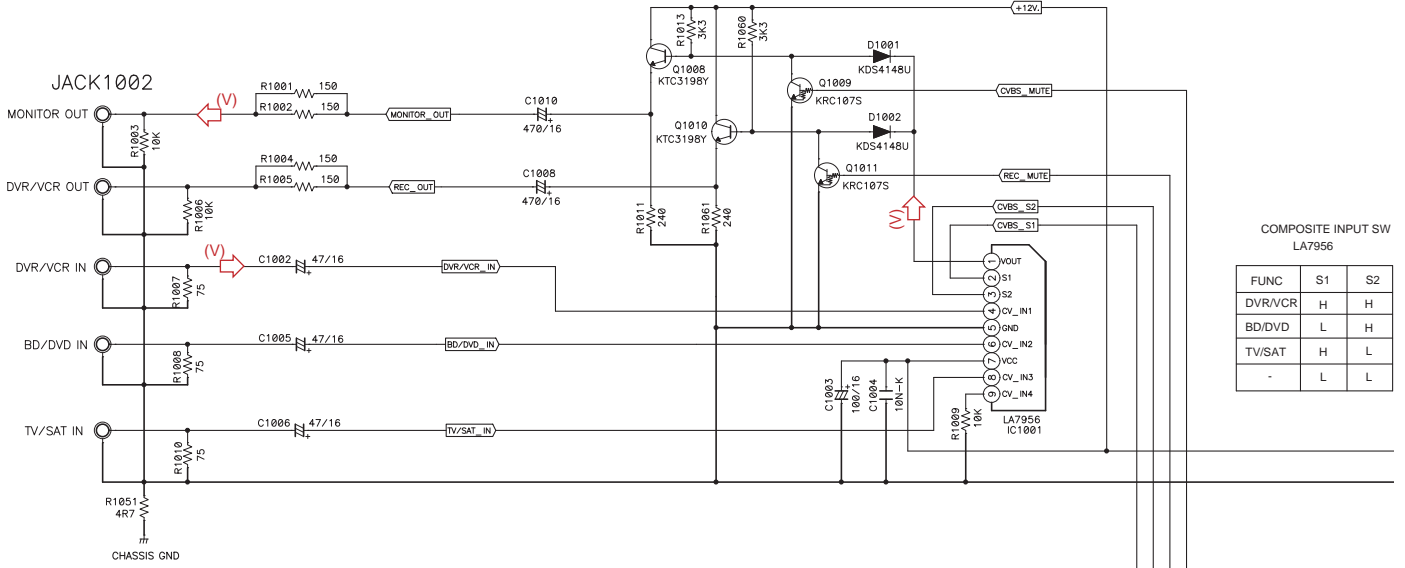

- : Video Signal Route
- : Video Signal Route (Component Y ch)
- : Video Signal Route (Component Cb ch)
- : Video Signal Route (Component Cr ch)

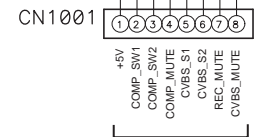

CP122
TO MAIN B'D

COMPOSITE INPUT SW
LA7956

FUNC	S1	S2
DVR/VCR	H	H
BD/DVD	L	H
TV/SAT	H	L
-	L	L

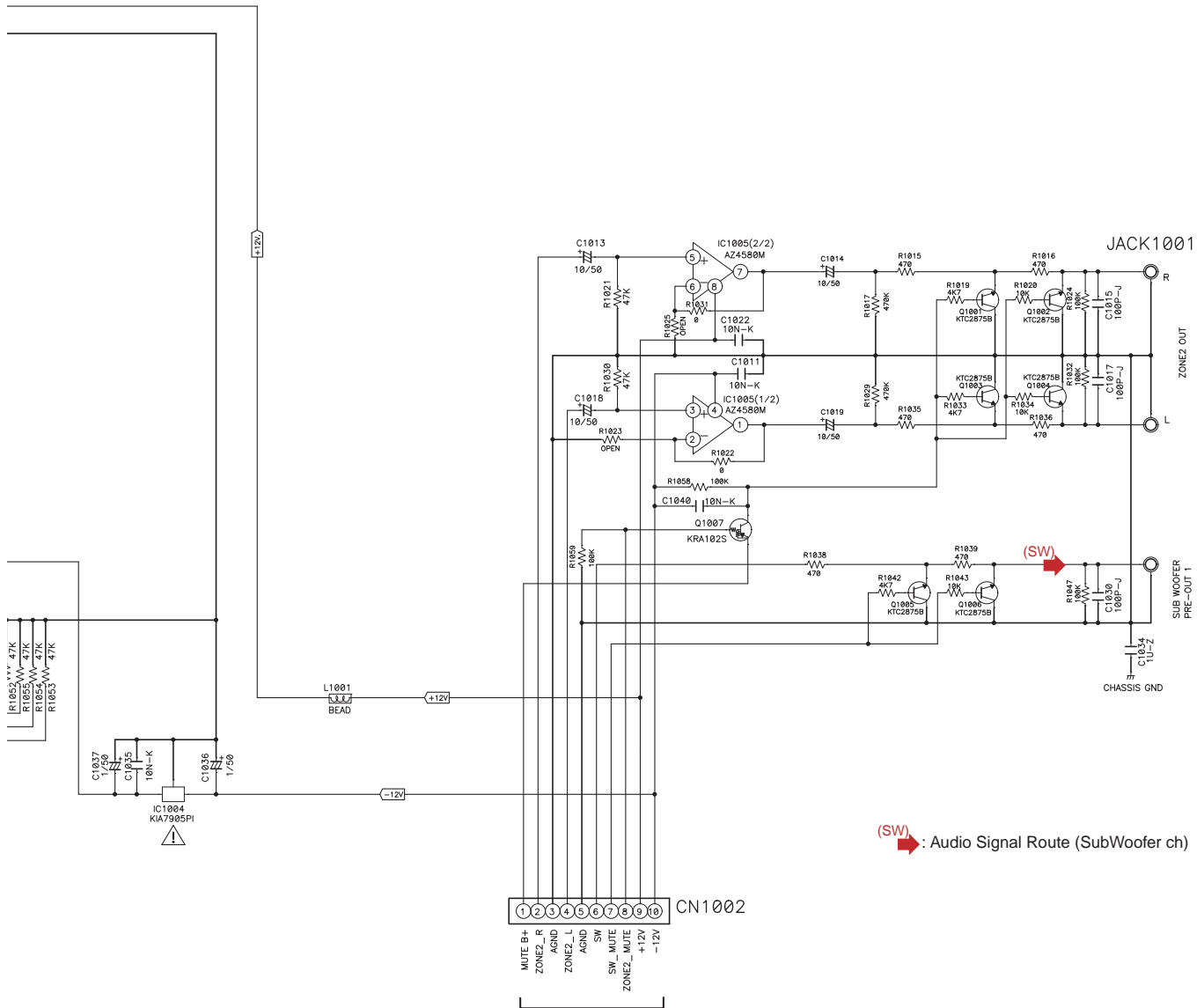

(SW) : Audio Signal Route (SubWoofer ch)

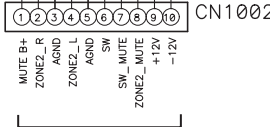

A CP124
TO MAIN B'D

VSX-519V-K

10.6 P.C.B SUB ASSY (SPEAKER-519) and P.C.B SUB ASSY (CNT)

A

B

C

D

E

F

M P.C.B SUB ASSY (SPEAKER-519) (7028067601030-IL)

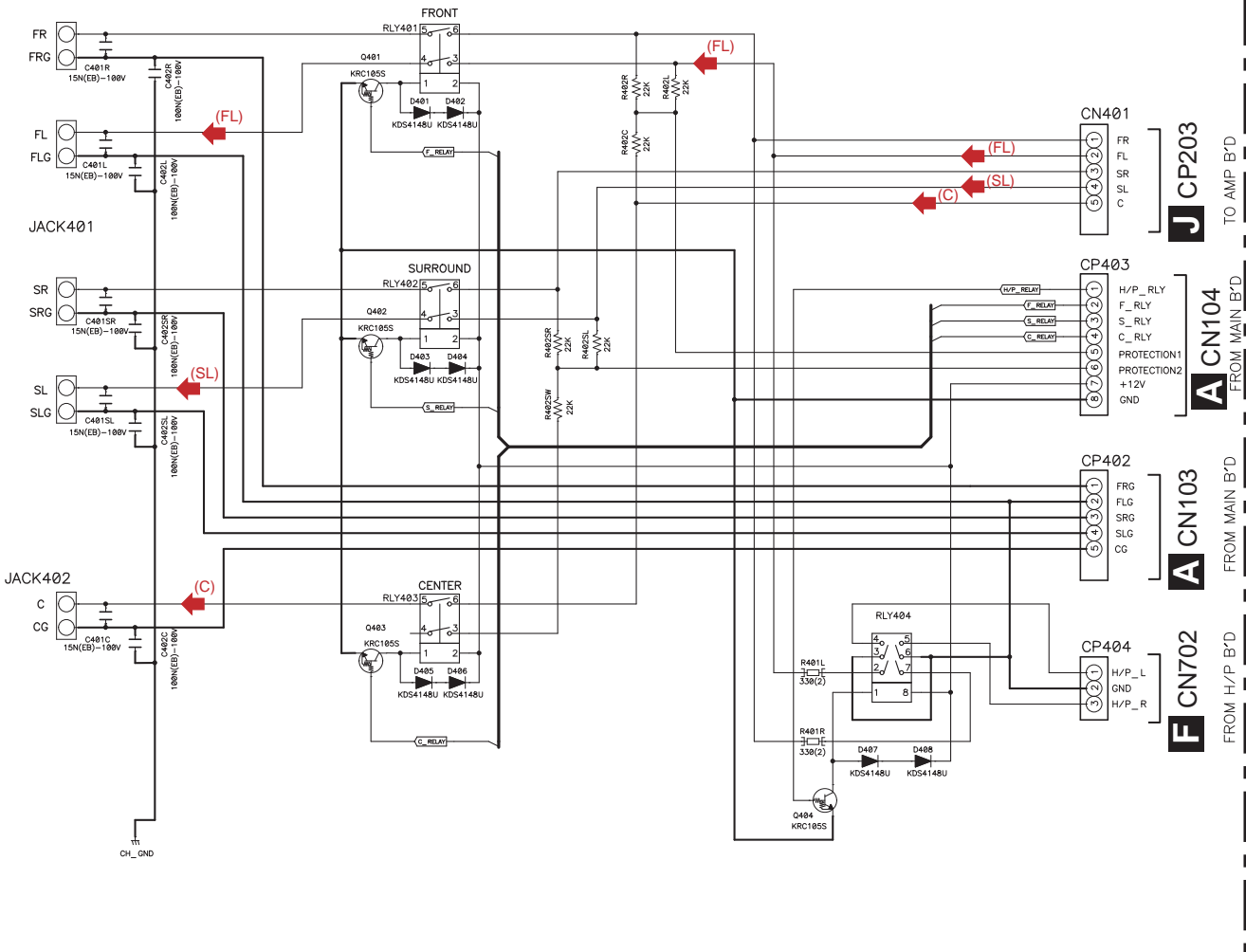

- (FL) : Audio Signal Route (Front L ch)
- (SL) : Audio Signal Route (Surround L ch)
- (C) : Audio Signal Route (Center ch)



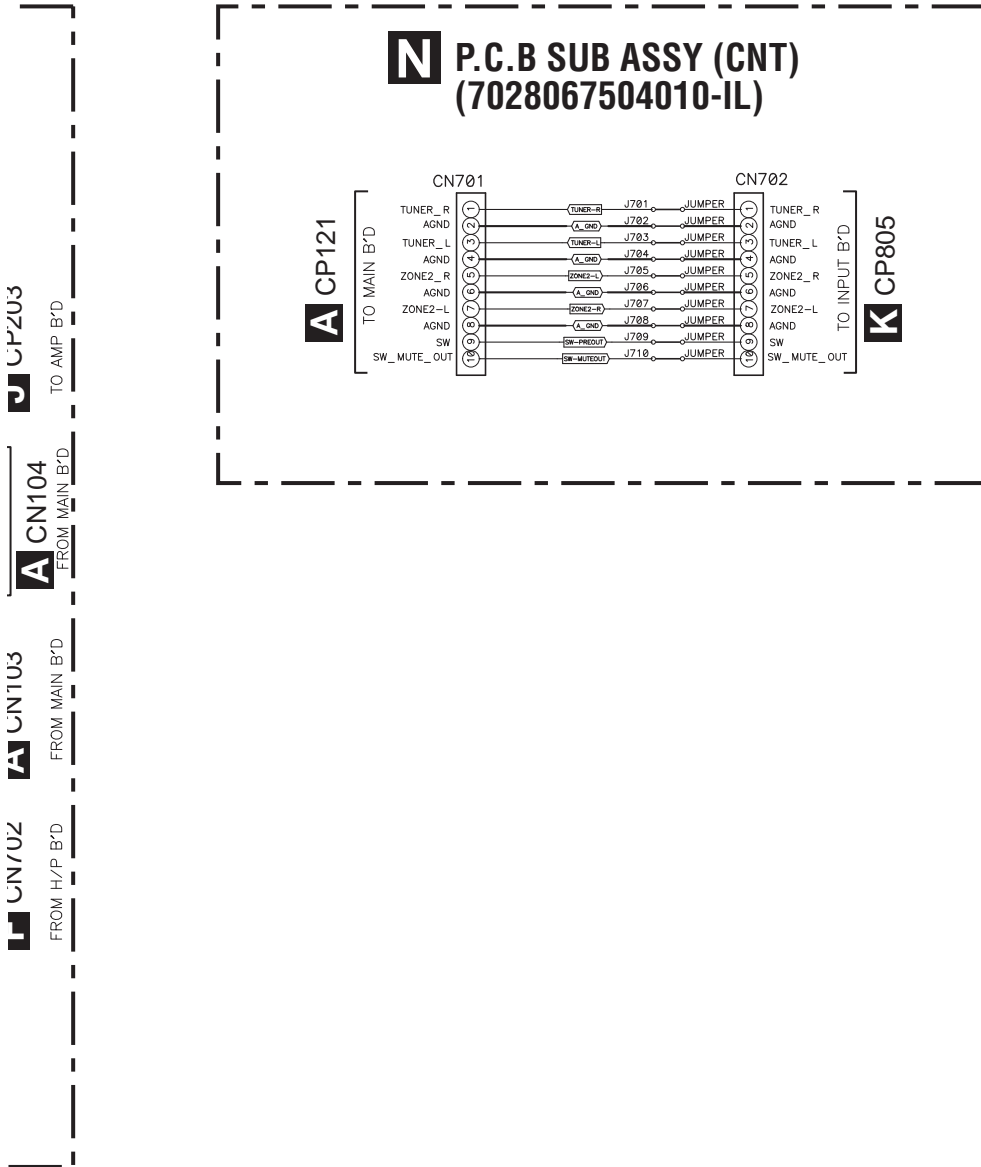

NOTES

- Resistor values are indicated in ohms unless otherwise specified
[k = 1,000 m = 1,000,000]
- Capacitor values are indicated in microfarades unless otherwise specified.
- [p = micro-microfarades]
: These resistor are to be segregated from printed wiring board or other accessible parts.

CAUTION
Safety precaution to be followed during servicing

- Since those parts marked with are critical parts for safety, use only the one described in the parts list
- Before returning the set to the customer make appropriate leakage current or resistance measurements to determine the exposed parts are properly insulated from the supply circuit.

10.7 P.C.B SUB ASSY (DSP) (1/2)

P 1/2 P.C.B SUB ASSY (DSP) (7028067561020-IL)

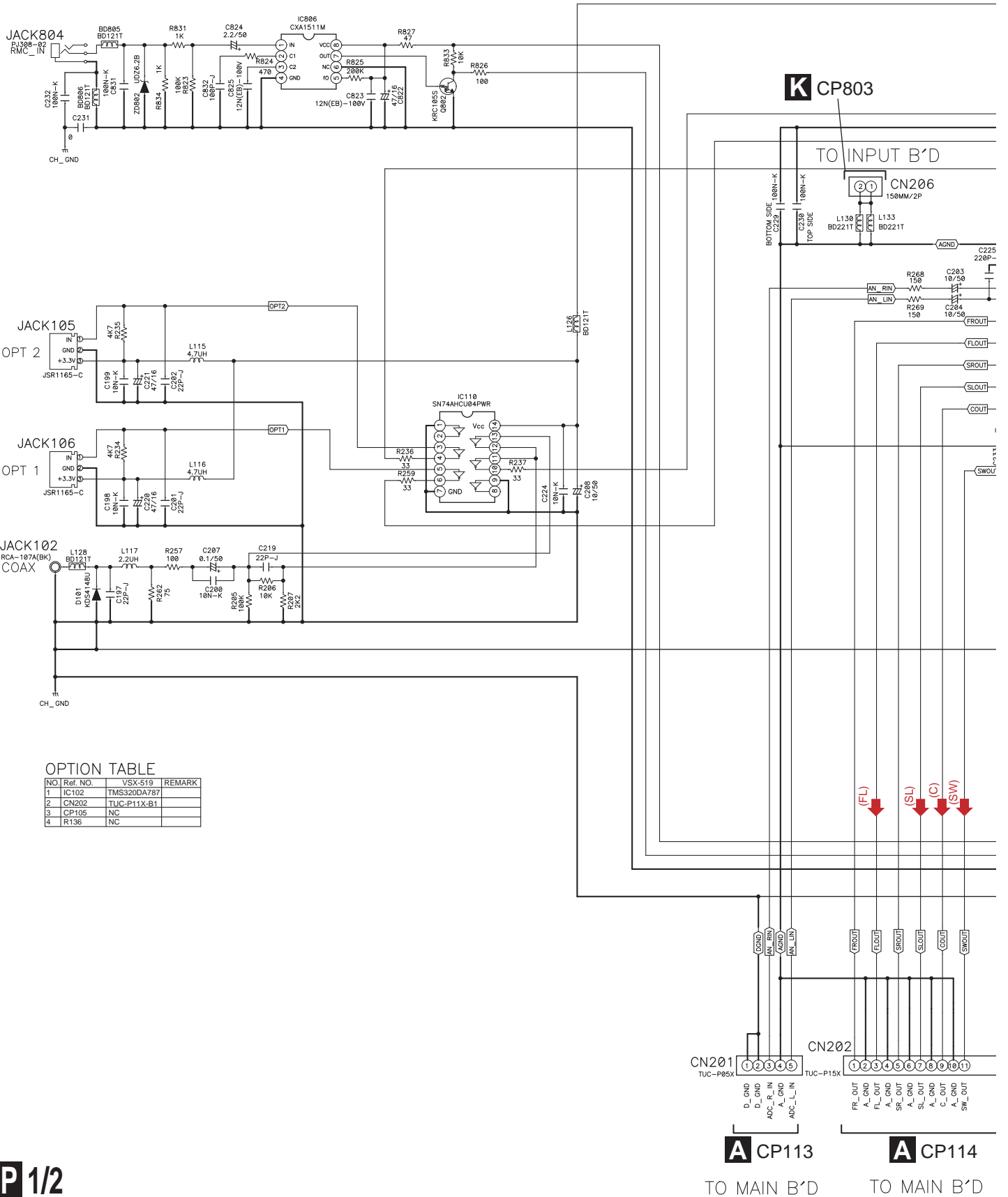

DIR/IR

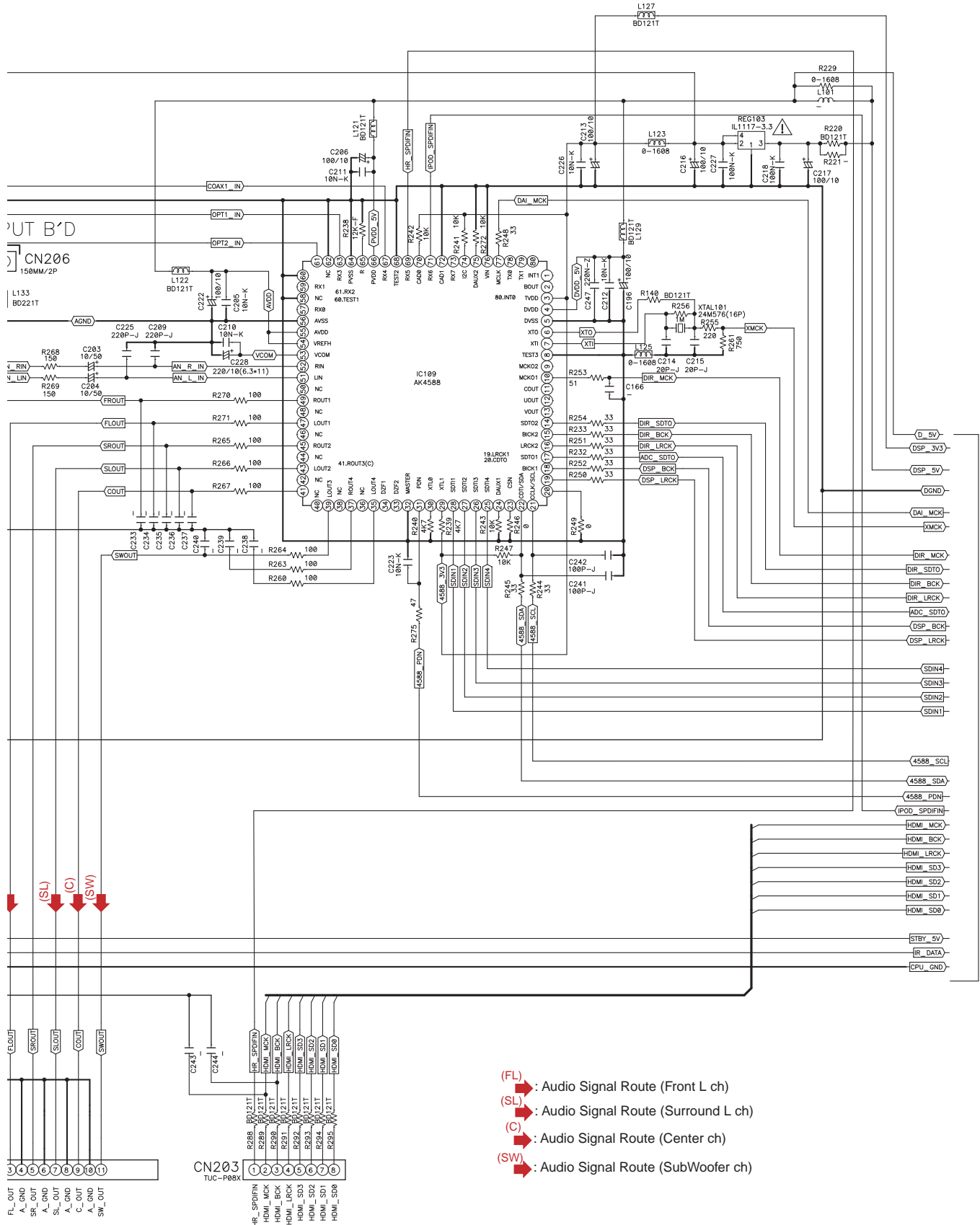

TO DSP SHEET P 2/2

- (FL) : Audio Signal Route (Front L ch)
- (SL) : Audio Signal Route (Surround L ch)
- (C) : Audio Signal Route (Center ch)
- (SW) : Audio Signal Route (SubWoofer ch)

CP114

CP115

TO MAIN B'D

TO MAIN B'D

VSX-519V-K

10.8 P.C.B SUB ASSY (DSP) (2/2)

P 2/2 P.C.B SUB ASSY (DSP) (7028067561020-IL)

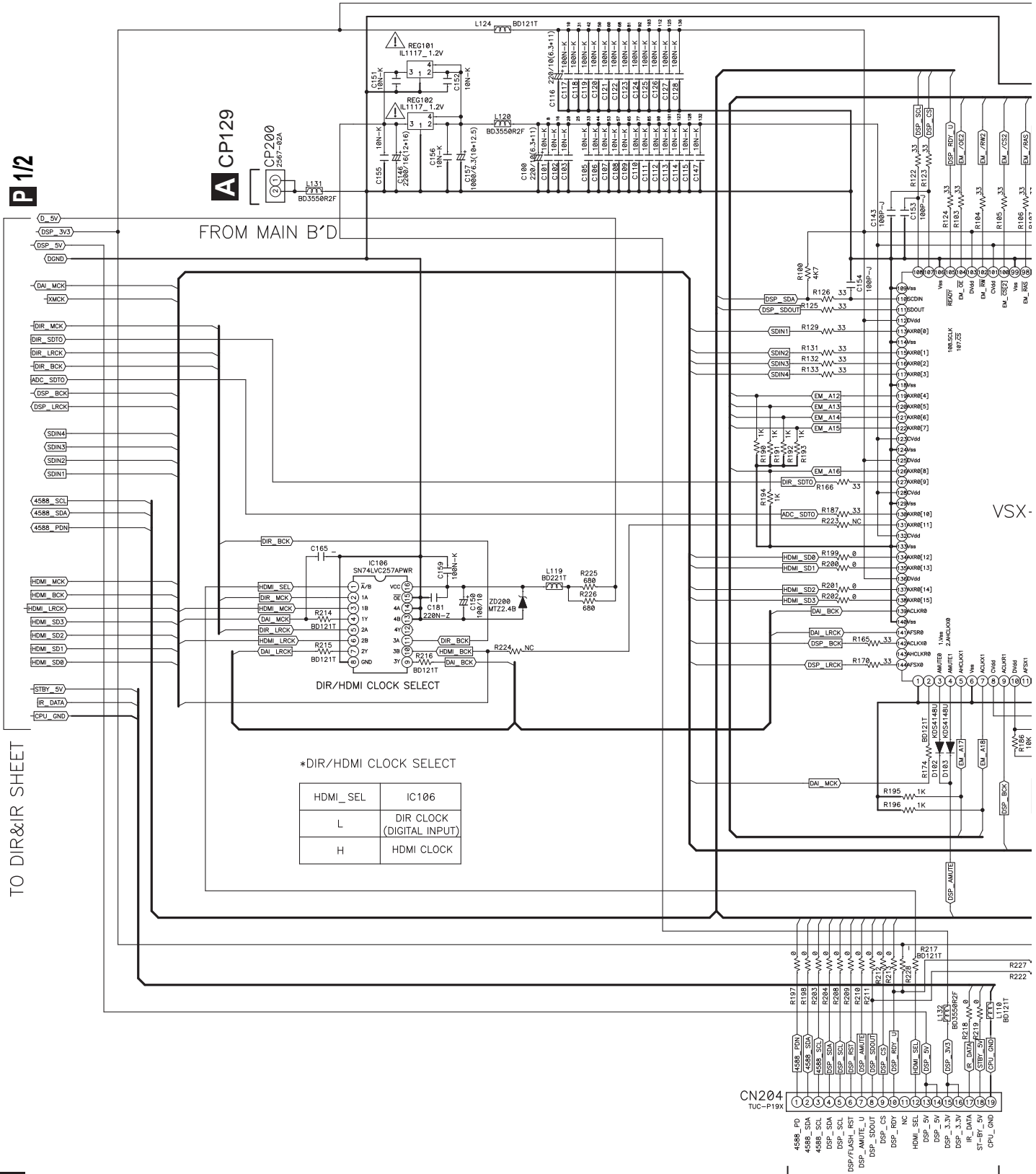

FROM MAIN B'D

*DIR/HDMI CLOCK SELECT

HDMI_SEL	IC106
L	DIR CLOCK (DIGITAL INPUT)
H	HDMI CLOCK

P 1/2

A CP129

CP200
2587-82A

A CP116

TO MAIN B'D

VSX-519V-K

DSP

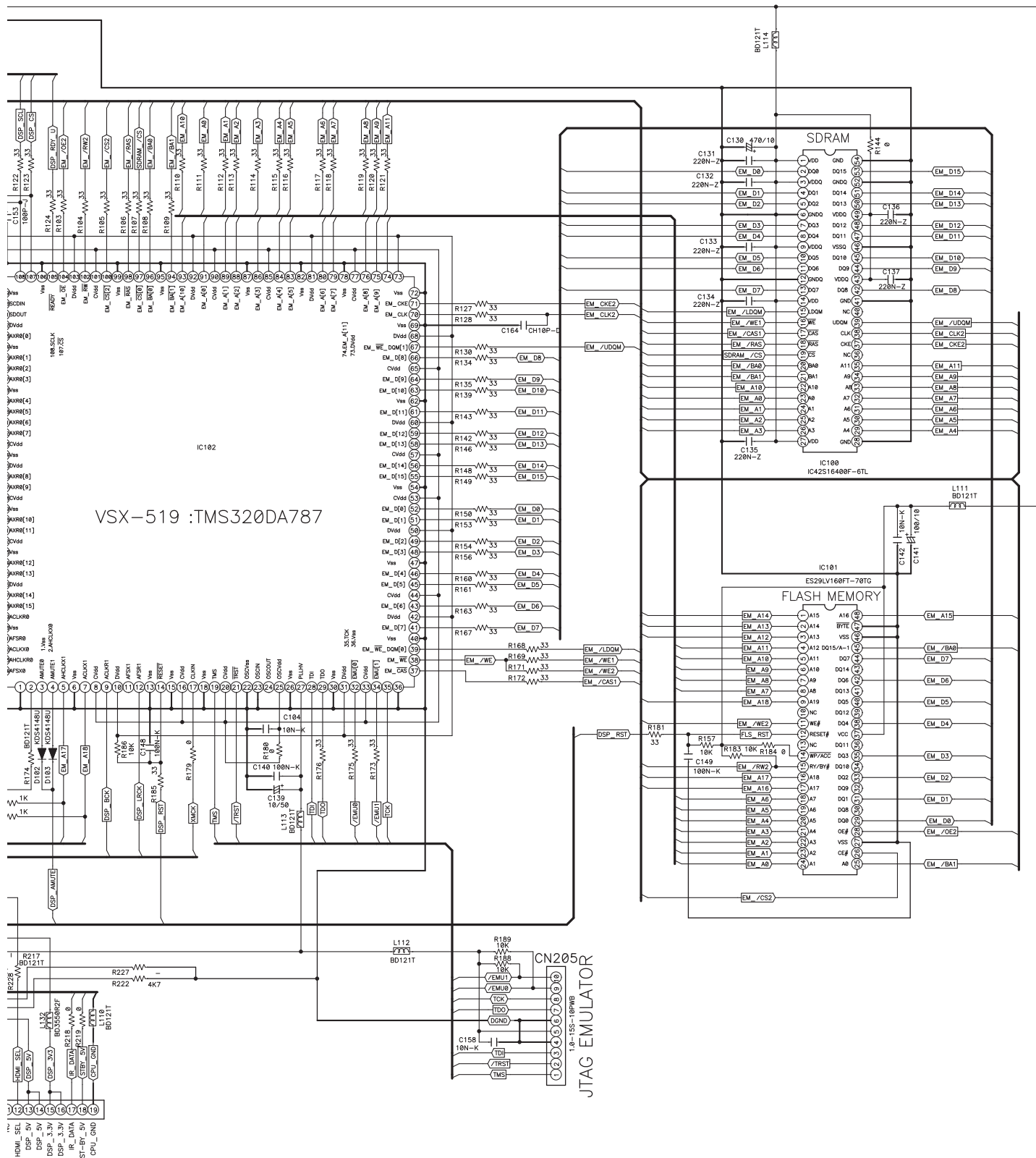

VSX-519 :TMS320DA787

JTAG EMULATOR

VSX-519V-K

11. PCB CONNECTION DIAGRAM

11.1 P.C.B SUB ASSY (MAIN) and P.C.B SUB ASSY (P/T)

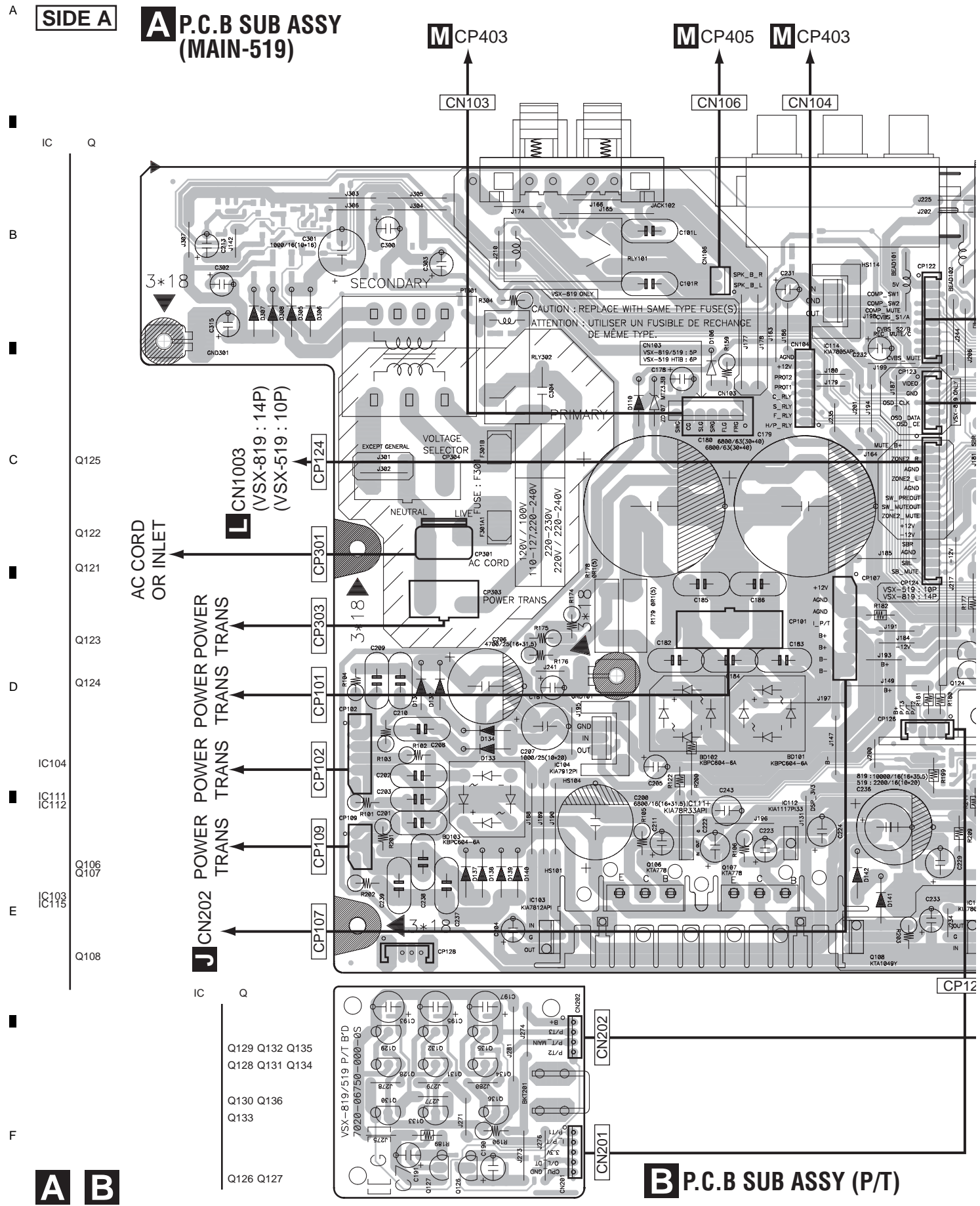

NOTE FOR PCB DIAGRAMS :

1. The parts mounted on this PCB include all necessary parts for several destinations. For further information for respective destinations, be sure to check with the schematic diagram.

2. View point of PCB diagrams.

SIDE A

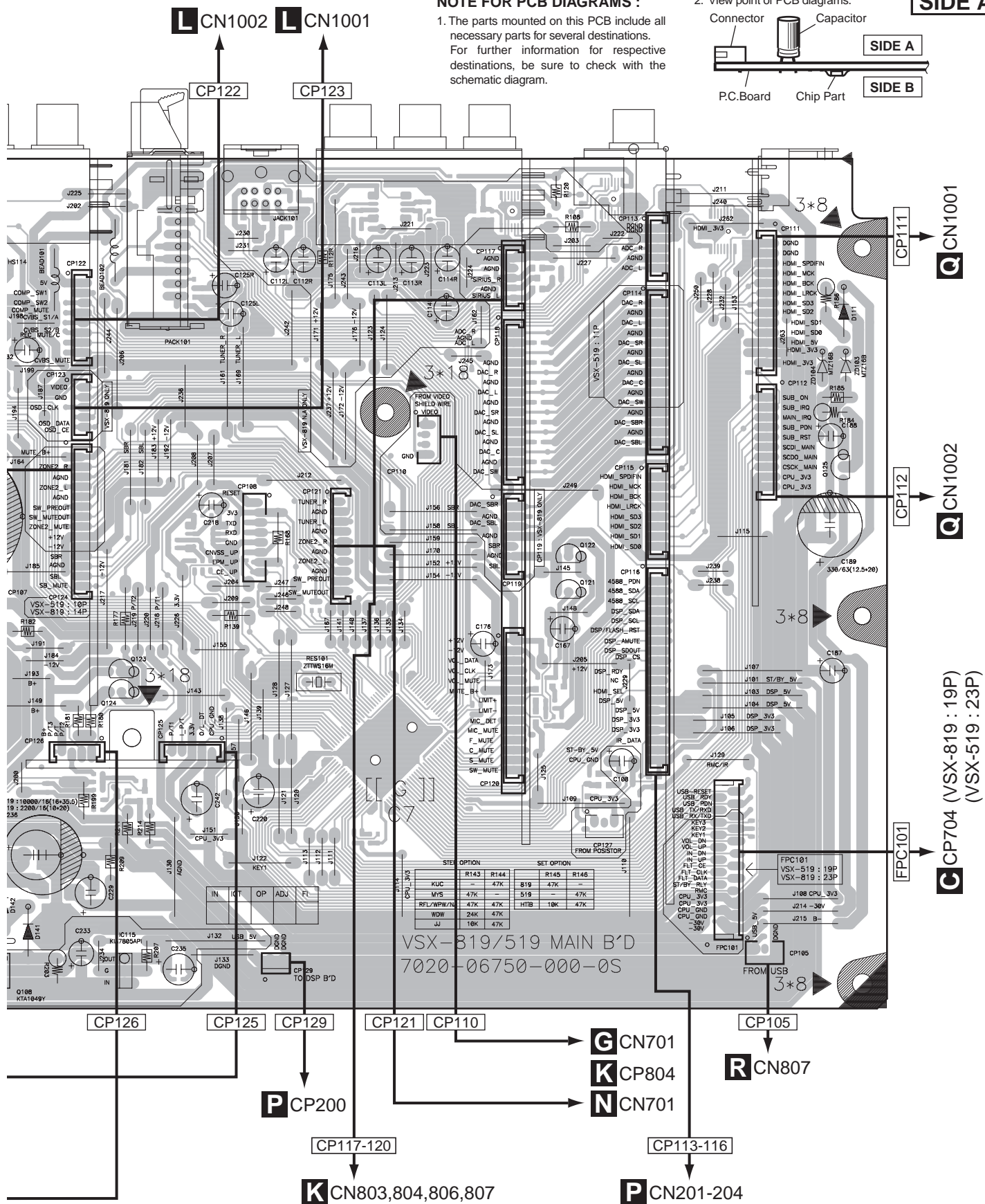
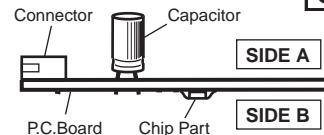

VSX-819/519 MAIN B'D
7020-06750-000-0S

STEP	OPTION	R143	R144	R145	R146
KUC	-	47K	-	819	47K
MYS	-	47K	-	519	47K
RFL/WPW/N	-	47K	47K	HTTB	10K 47K
WDW	-	24K	47K	-	-
WJ	-	10K	47K	-	-

P/T)

A B

VSX-519V-K

SIDE B

P.C.B SUB ASSY (MAIN-519)

A

B

C

D

E

F

- IC Q
- IC108 Q138
- IC110 Q300
- IC109 Q302
- IC120 Q301
- IC301 Q110
- IC302 Q301
- IC106
- IC101
- Q103
- Q202
- Q102
- Q201
- IC113

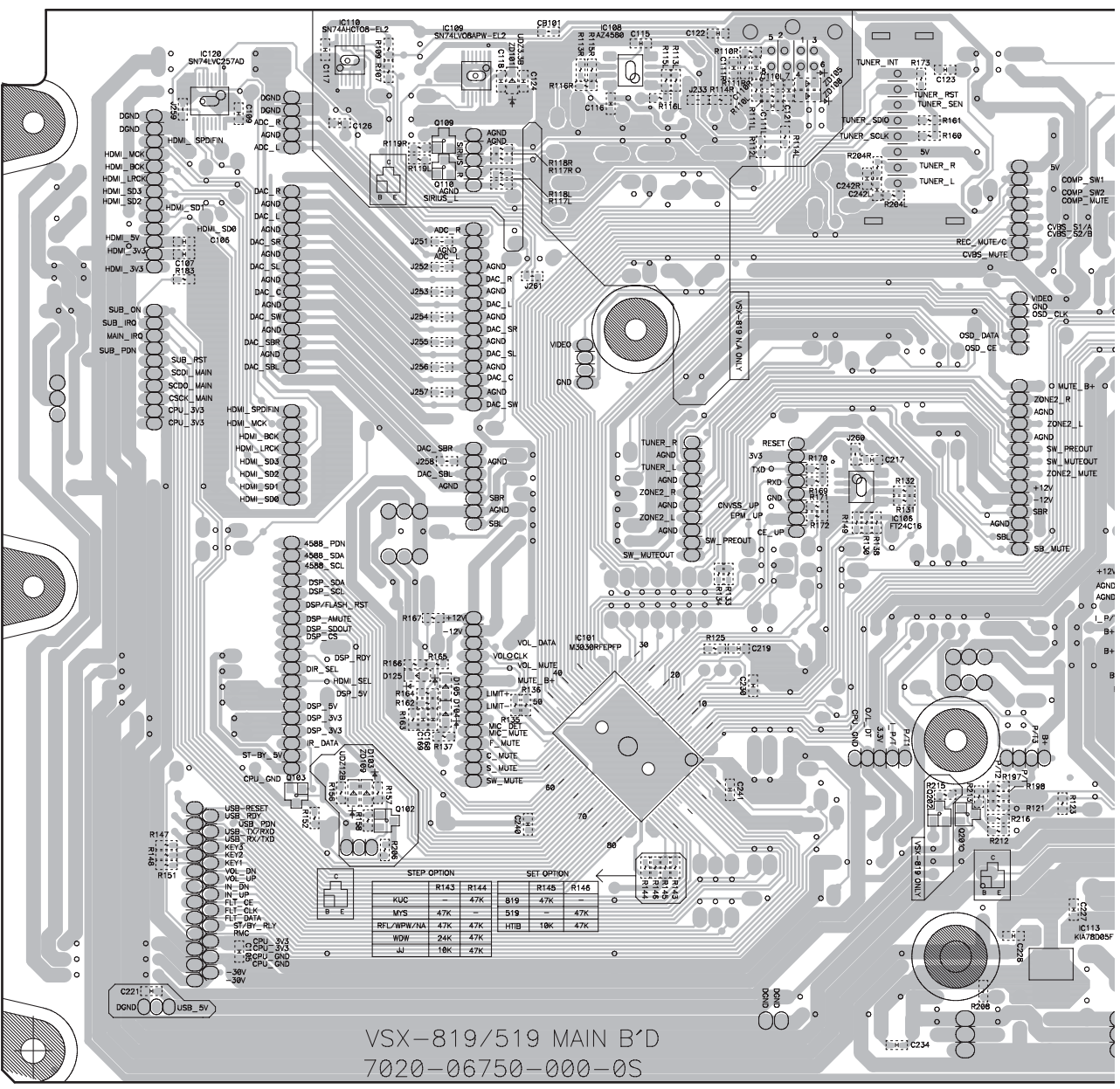

A B

SIDE B

A

B

C

D

E

F

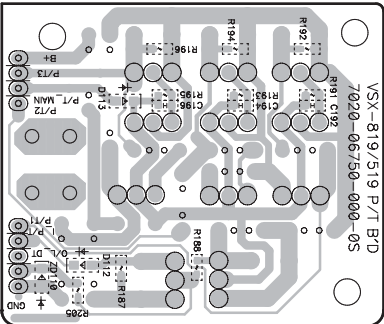
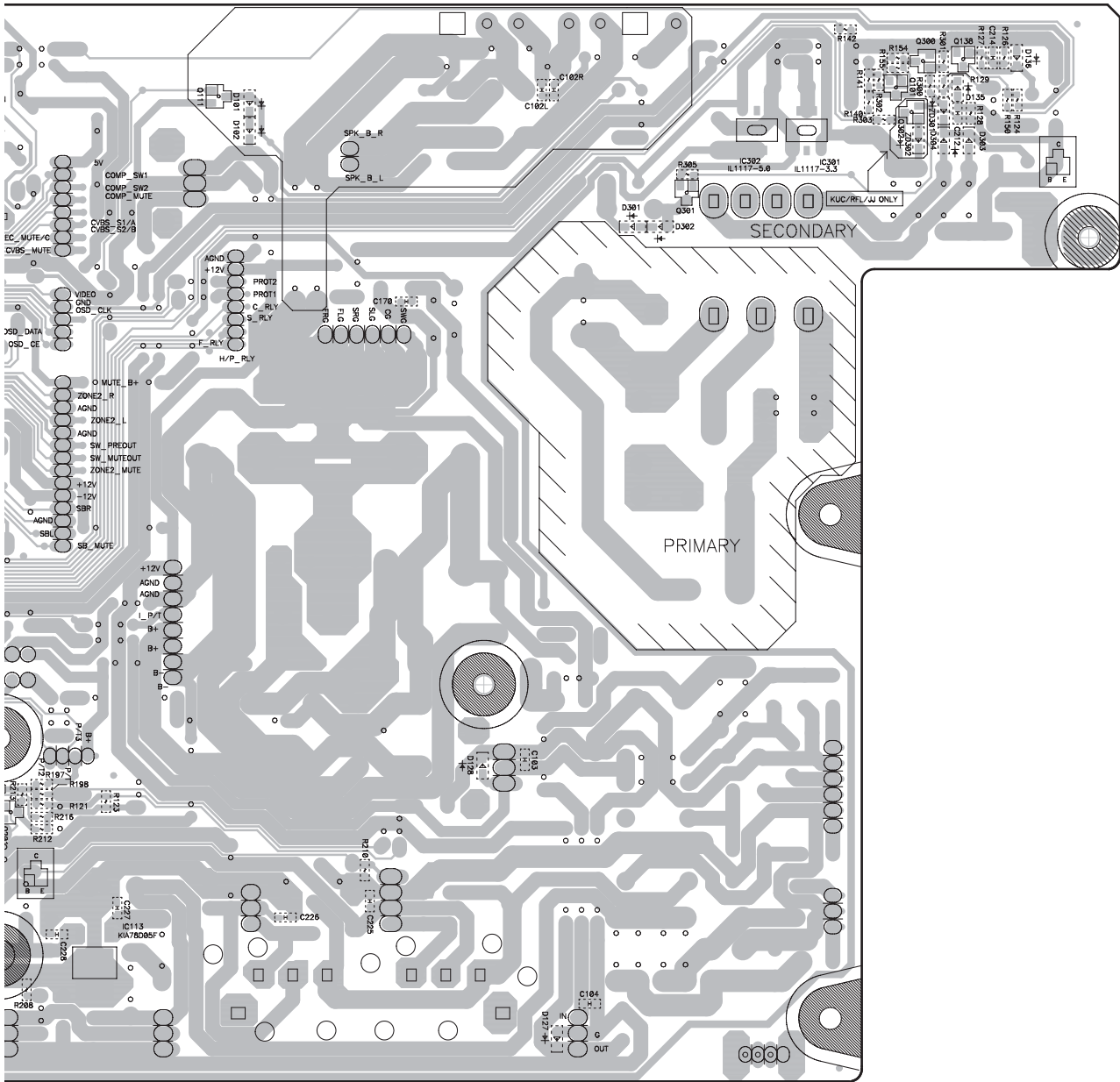

B P.C.B SUB ASSY (P/T)

VSX-519V-K

A B

11.2 P.C.B SUB ASSYS (FRONT)

SIDE A

C P.C.B SUB ASSY (FRONT)

A

IC Q

B

Q702

C

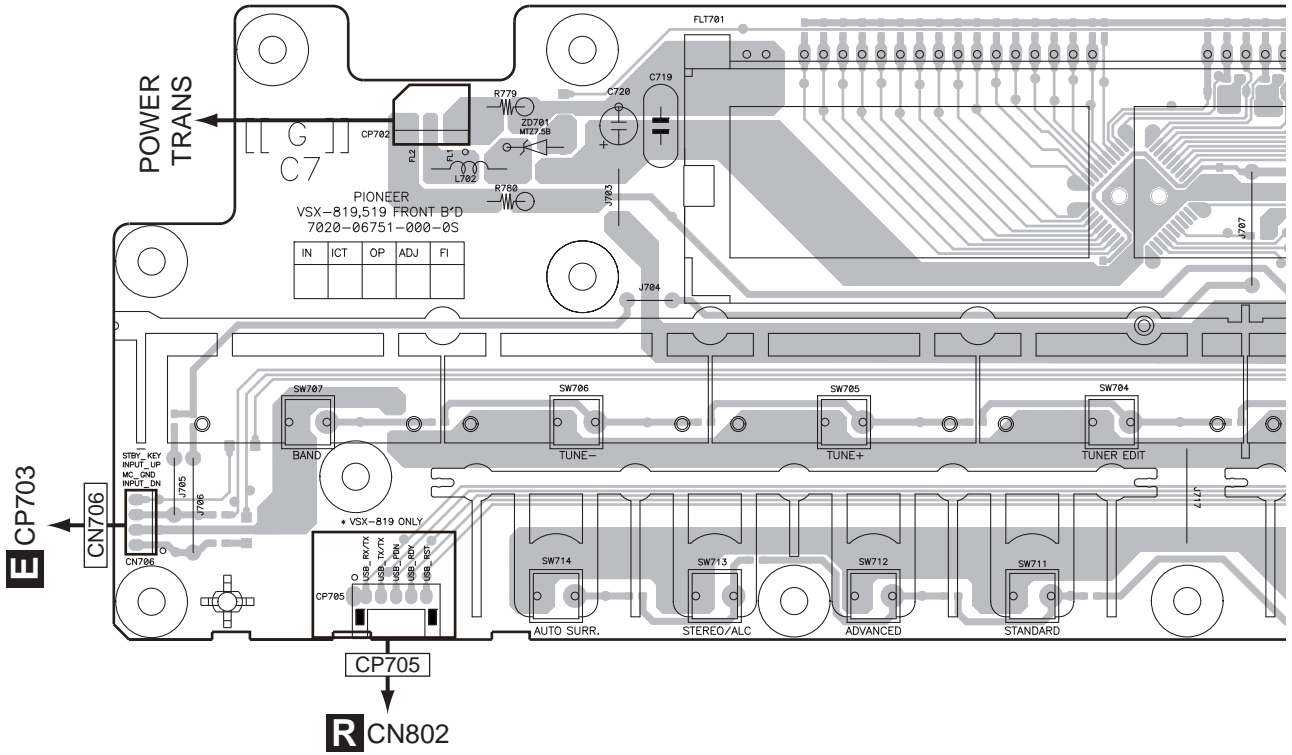

SIDE B

C P.C.B SUB ASSY (FRONT)

D

IC Q

E

Q701

Q703

F

IC701

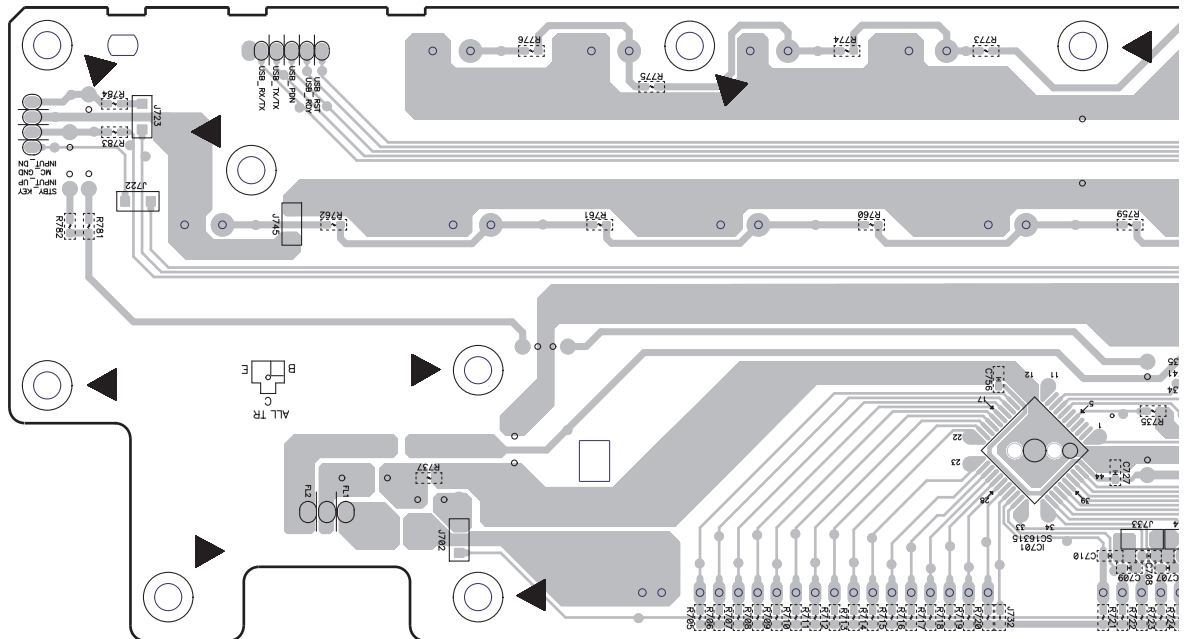

C

SIDE A

A

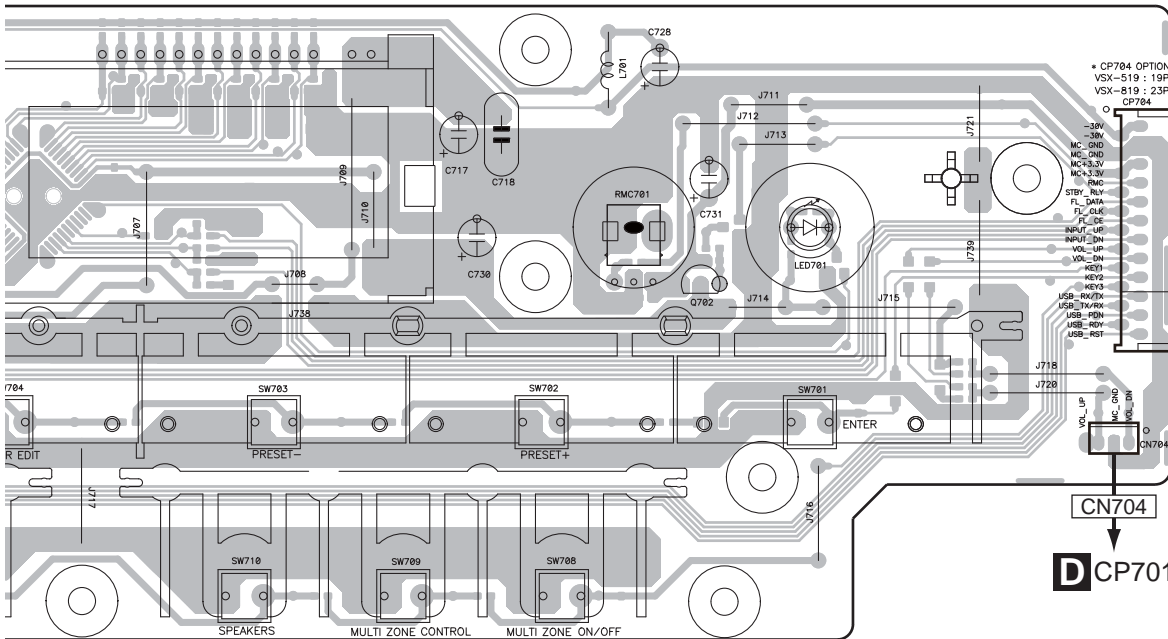

A FPC101
(VSX-819 : 23P)
(VSX-519 : 19P)

D CP701

B

C

SIDE B

D

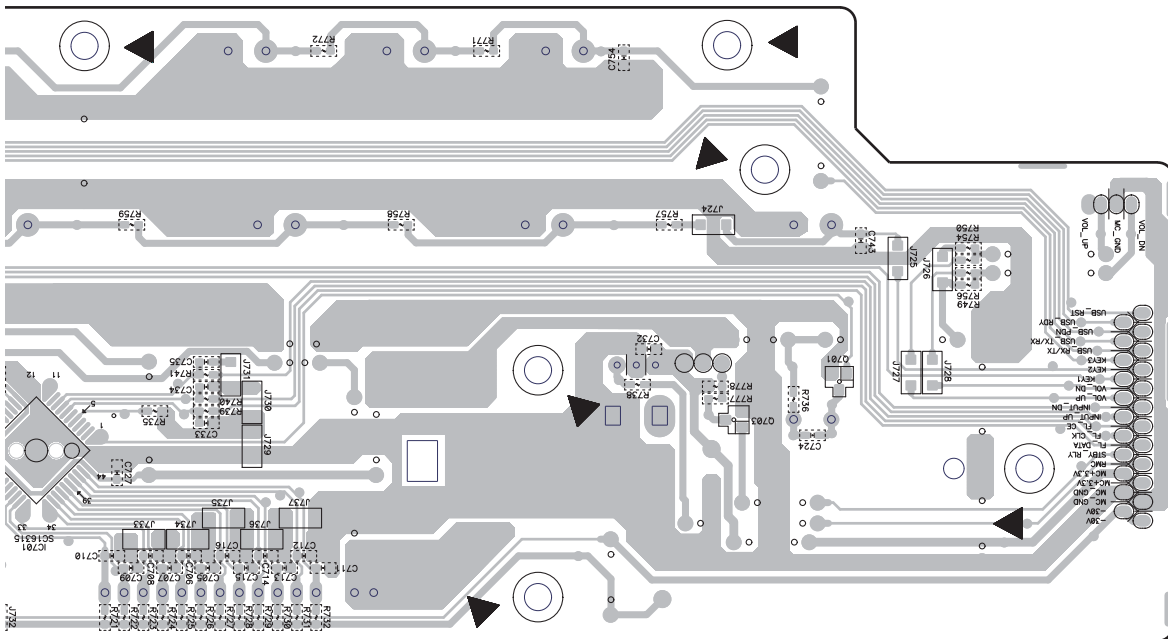

E

F

C

11.3 P.C.B SUB ASSYS (VOLUME), (FUNCTION), (HEADPHONE) and (PORTABLE)

SIDE A

SIDE A

D P.C.B SUB ASSY(VOLUME)

I P.C.B SUB ASSY (PORTABLE)

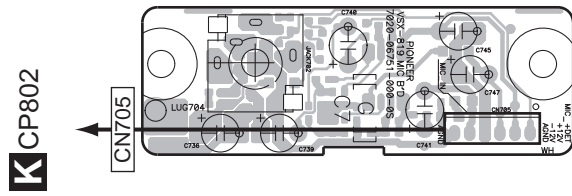
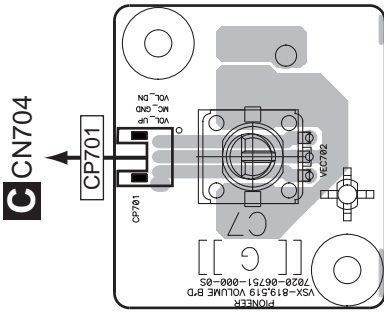

F P.C.B SUB ASSY (HEADPHONE)

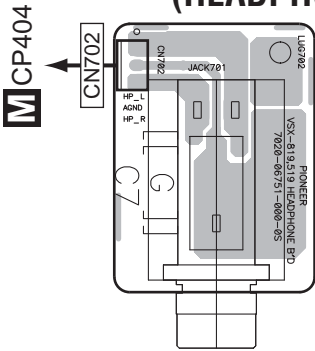

E P.C.B SUB ASSY (FUNCTION)

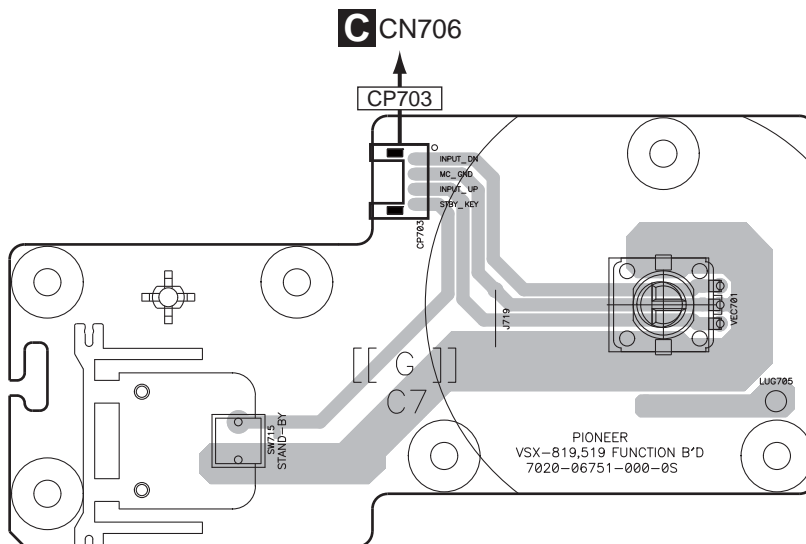

D E F I

SIDE B

SIDE B

A
B
C
D
E
F

I P.C.B SUB ASSY (PORTABLE)

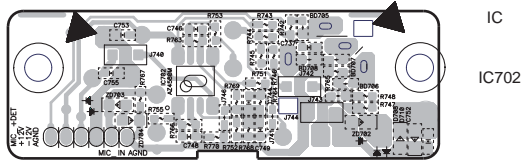

D P.C.B SUB ASSY(VOLUME)

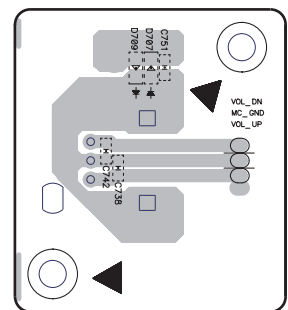

F P.C.B SUB ASSY (HEADPHONE)

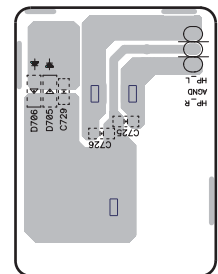

E P.C.B SUB ASSY (FUNCTION)

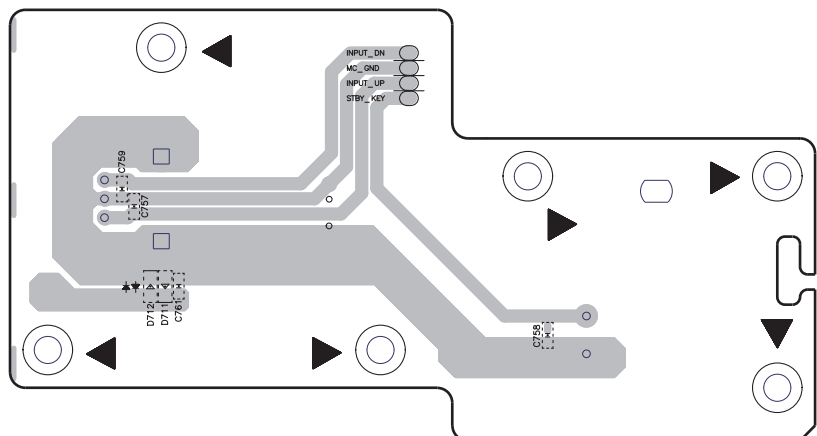

DEFI

11.4 P.C.B SUB ASSY (AMP)

SIDE A

J P.C.B SUB ASSY (AMP)

A

K CP801

A CP107

M CN401

- Q202C
- Q203FR Q204FR Q206C Q204C Q204SR Q203SL Q204SL
- Q204FL Q206SR Q203FL Q203SL Q202SR Q206FR Q206SL Q202FL
- Q206FL Q202FR
- VR201FL VR201FR VR201SR VR201SL
- VR201C
- Q205FR Q205SR Q206C Q201SL
- Q201SR Q201FL Q201C Q201FR Q207FR Q207SL Q207FL Q207SL Q205SL Q205FL

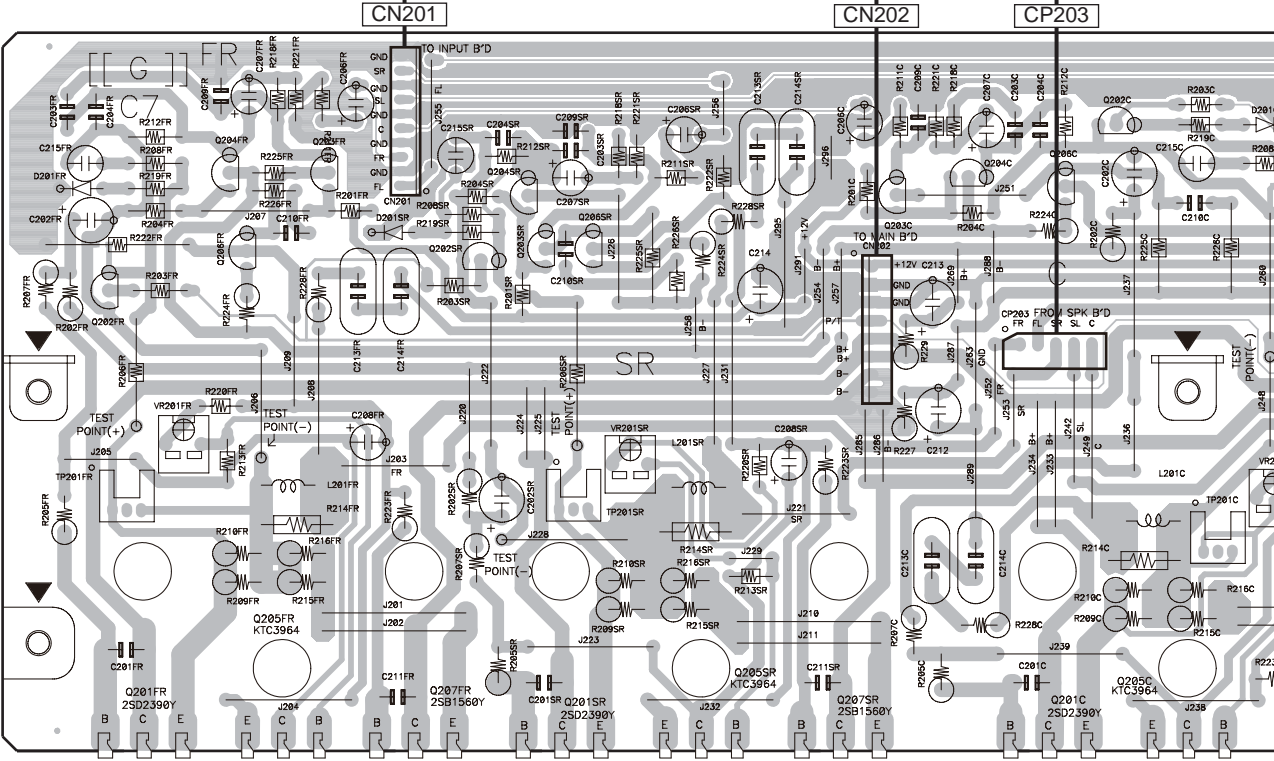

SIDE B

J P.C.B SUB ASSY (AMP)

D

E

F

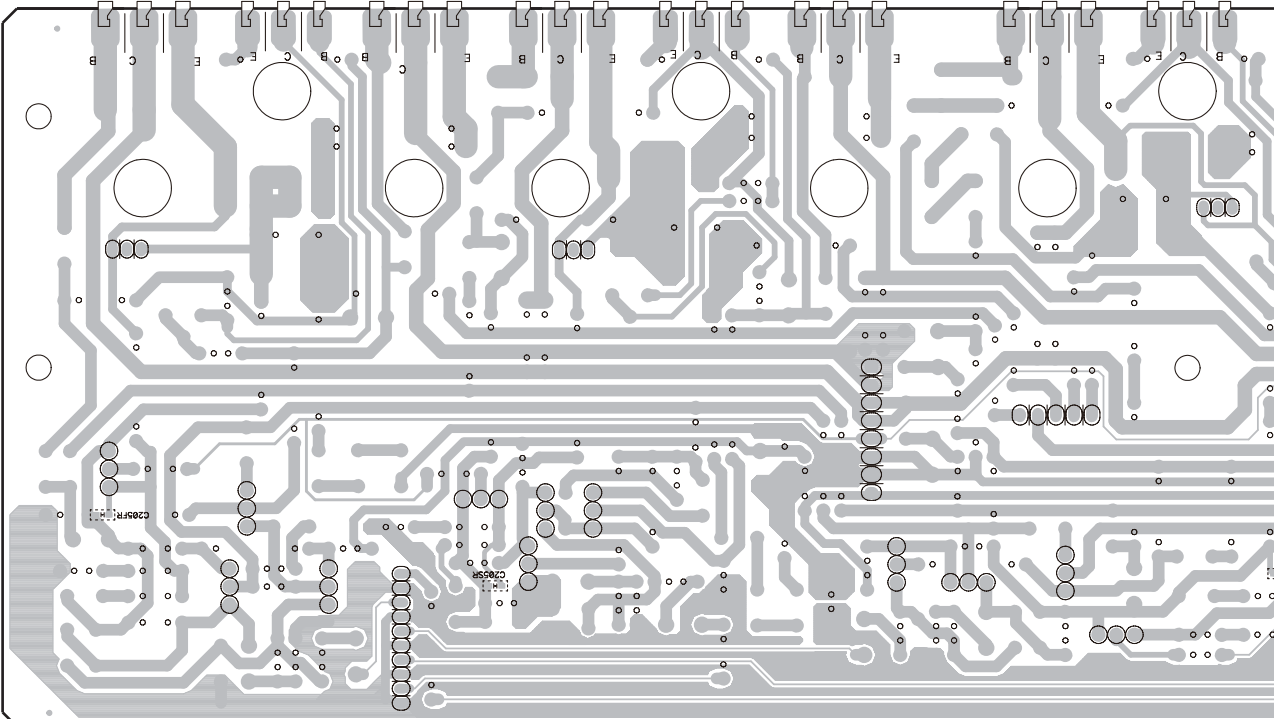

SIDE A

01

A

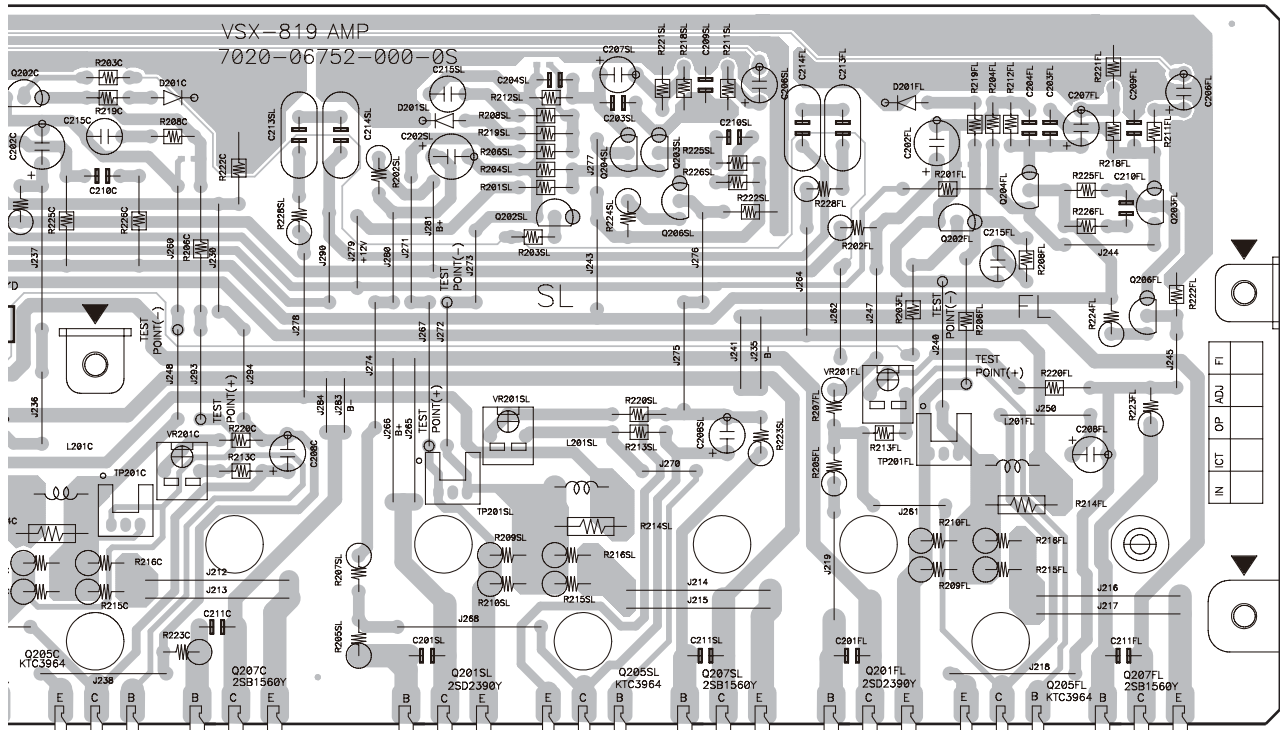

B

C

SIDE B

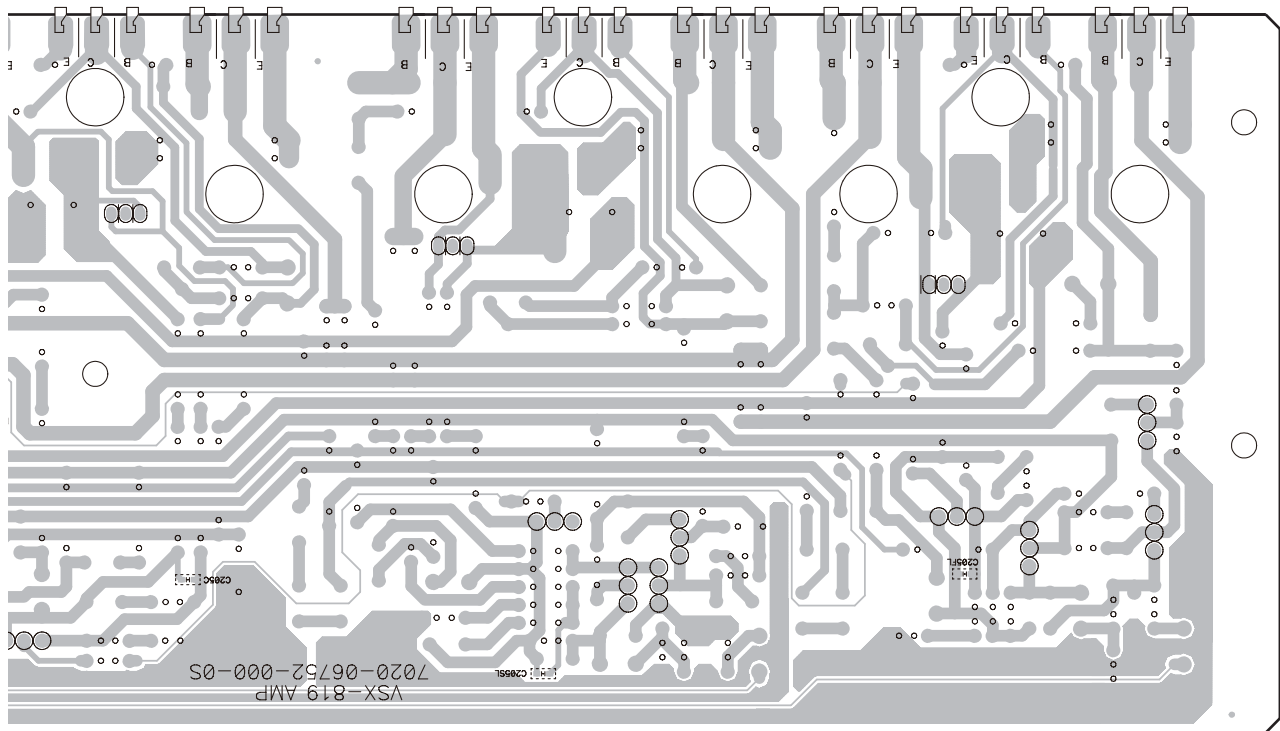

D

E

F

11.5 P.C.B SUB ASSY (INPUT)

SIDE A

SIDE A

K P.C.B SUB ASSY (INPUT)

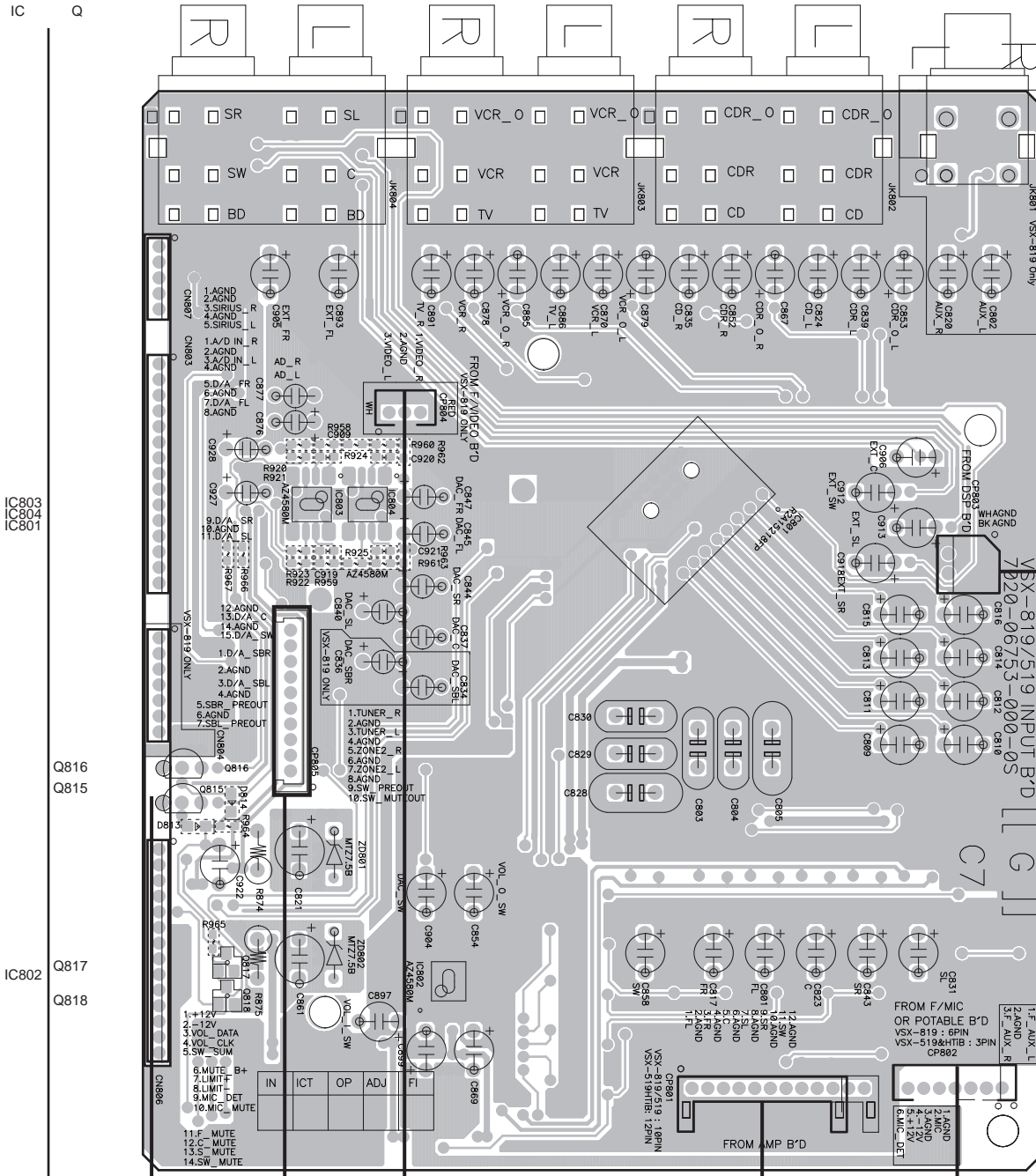

K

VSX-819V-K

K

SIDE B

SIDE B

K P.C.B SUB ASSY (INPUT)

IC Q

IC801

Q812
Q813
Q814
Q801
Q802 Q803
Q805
Q804

IC802

Q807
Q806
Q808

Q809
Q810

Q811

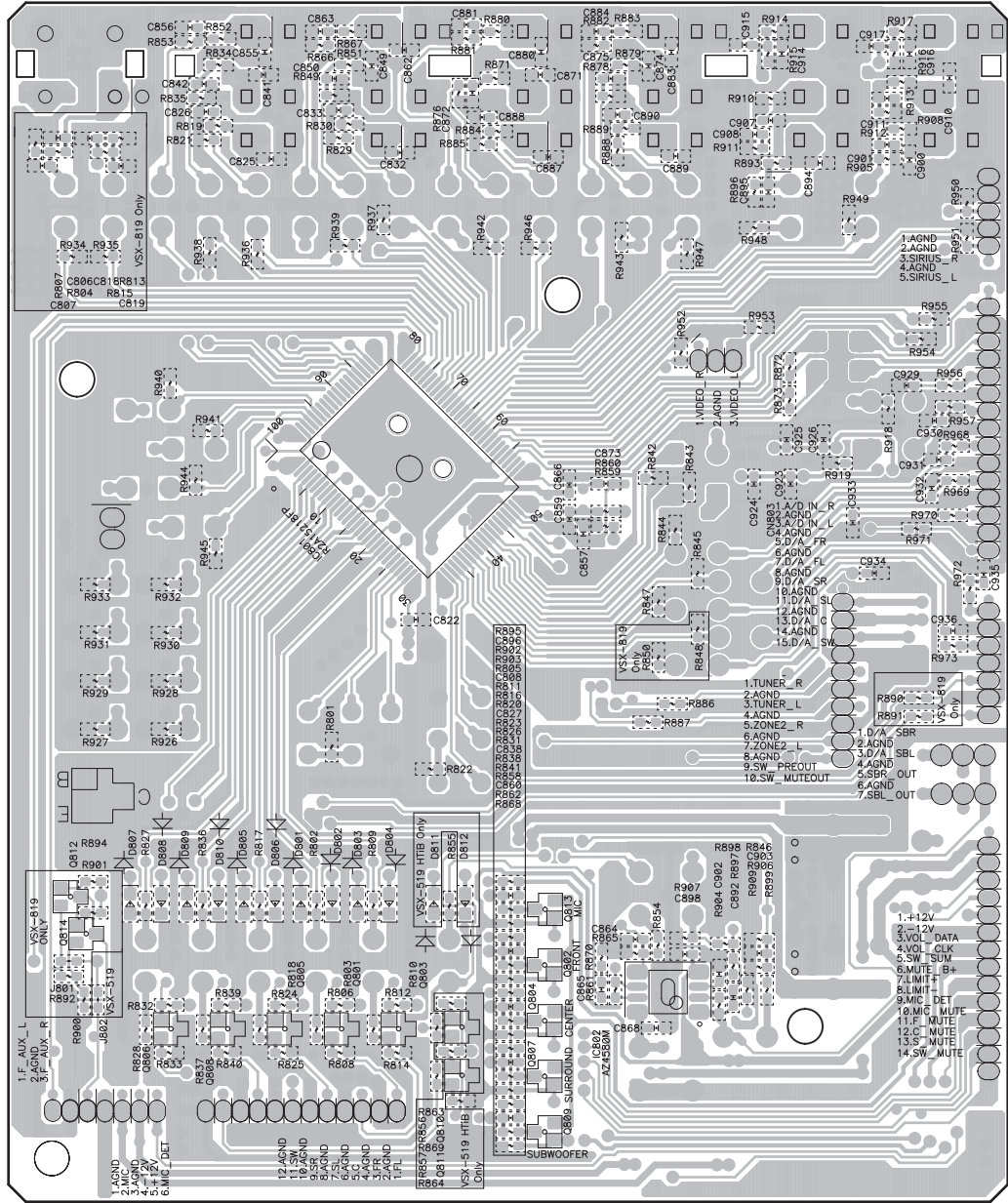

VSX-519V-K



11.6 P.C.B SUB ASSY (VIDEO-519)

SIDE A

P.C.B SUB ASSY (VIDEO-519)

A
B
C
D
E
F

1 2 3 4

IC Q

IC1001

IC1004

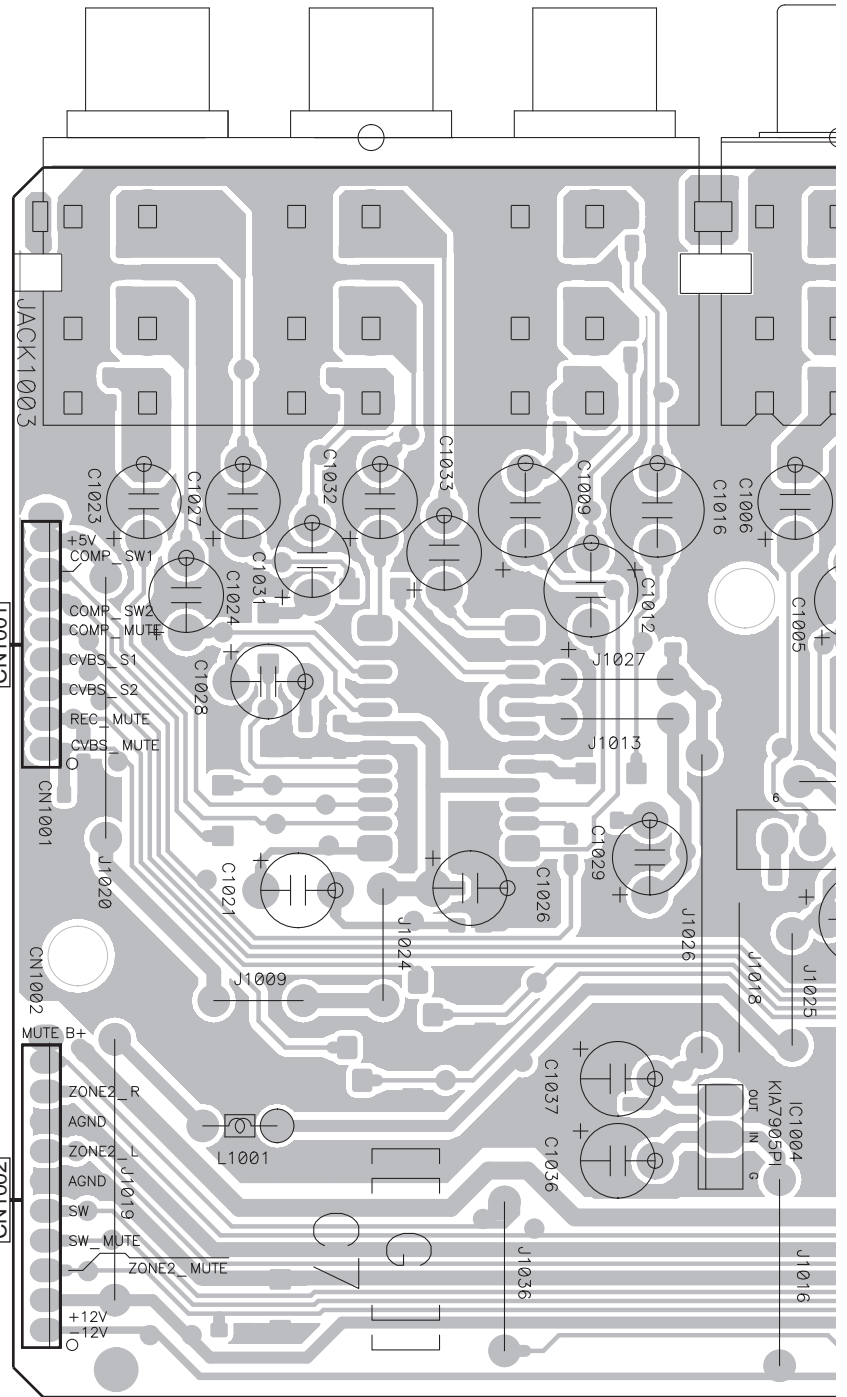

A CP122

A CP123

CNT1001

CNT1002

+5V
COMP SW1
COMP SW2
COMP MUTE
CVBS S1
CVBS S2
REQ MUTE
CVBS MUTE

MUTE B+
ZONE2_R
AGND
ZONE2_L
AGND
SW
SW MUTE
ZONE2_MUTE
+12V
-12V

JACK1003

CNT1001

CNT1002

CNT1001

CNT1002

CNT1001

CNT1002

CNT1001

CNT1002

CNT1001

CNT1002

CNT1001

CNT1002

CNT1001

CNT1002

CNT1001

CNT1002

CNT1001

CNT1002

CNT1001

CNT1002

CNT1001

CNT1002

CNT1001

CNT1002

CNT1001

CNT1002

CNT1001

CNT1002

CNT1001

CNT1002

CNT1001

CNT1002

CNT1001

CNT1002

CNT1001

CNT1002

CNT1001

CNT1002

CNT1001

CNT1002

CNT1001

CNT1002

CNT1001

CNT1002

CNT1001

CNT1002

CNT1001

CNT1002

CNT1001

CNT1002

CNT1001

CNT1002

CNT1001

CNT1002

CNT1001

CNT1002

CNT1001

CNT1002

CNT1001

CNT1002

CNT1001

CNT1002

CNT1001

CNT1002

CNT1001

CNT1002

CNT1001

CNT1002

CNT1001

CNT1002

CNT1001

CNT1002

CNT1001

CNT1002

CNT1001

CNT1002

CNT1001

CNT1002

CNT1001

CNT1002

CNT1001

CNT1002

CNT1001

CNT1002

CNT1001

CNT1002

CNT1001

CNT1002

CNT1001

CNT1002

CNT1001

CNT1002

CNT1001

CNT1002

CNT1001

CNT1002

CNT1001

CNT1002

CNT1001

CNT1002

CNT1001

CNT1002

CNT1001

CNT1002

CNT1001

CNT1002

CNT1001

CNT1002

CNT1001

CNT1002

CNT1001

CNT1002

CNT1001

CNT1002

CNT1001

CNT1002

CNT1001

CNT1002

CNT1001

CNT1002

CNT1001

CNT1002

CNT1001

CNT1002

CNT1001

CNT1002

CNT1001

CNT1002

CNT1001

CNT1002

CNT1001

CNT1002

CNT1001

CNT1002

CNT1001

CNT1002

CNT1001

CNT1002

CNT1001

CNT1002

CNT1001

CNT1002

CNT1001

CNT1002

CNT1001

CNT1002

CNT1001

CNT1002

CNT1001

CNT1002

CNT1001

CNT1002

CNT1001

CNT1002

CNT1001

CNT1002

CNT1001

CNT1002



1 2 3 4

SIDE A

A
B
C
D
E
F

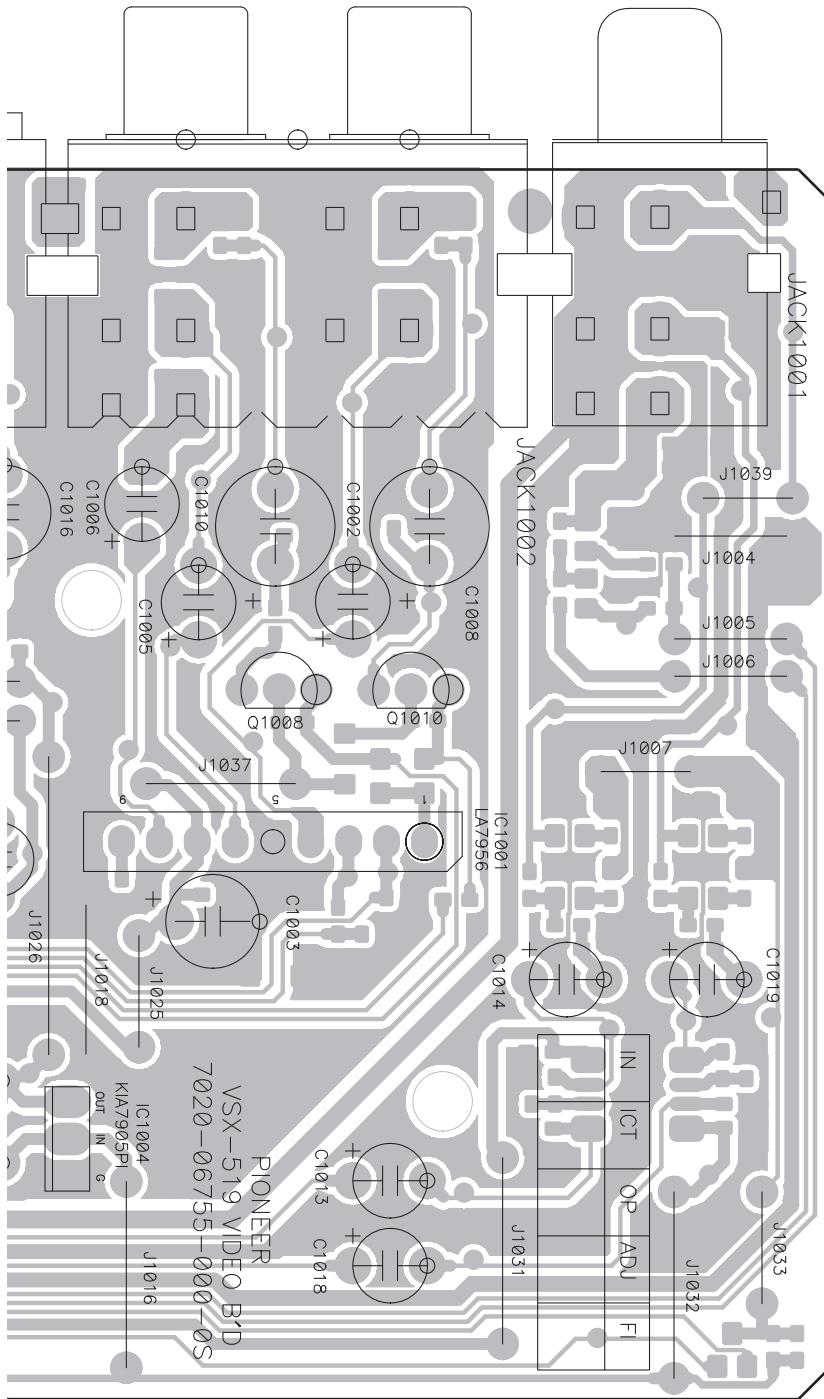

SIDE B

A

L P.C.B SUB ASSY (VIDEO-519)

B

C

D

E

F

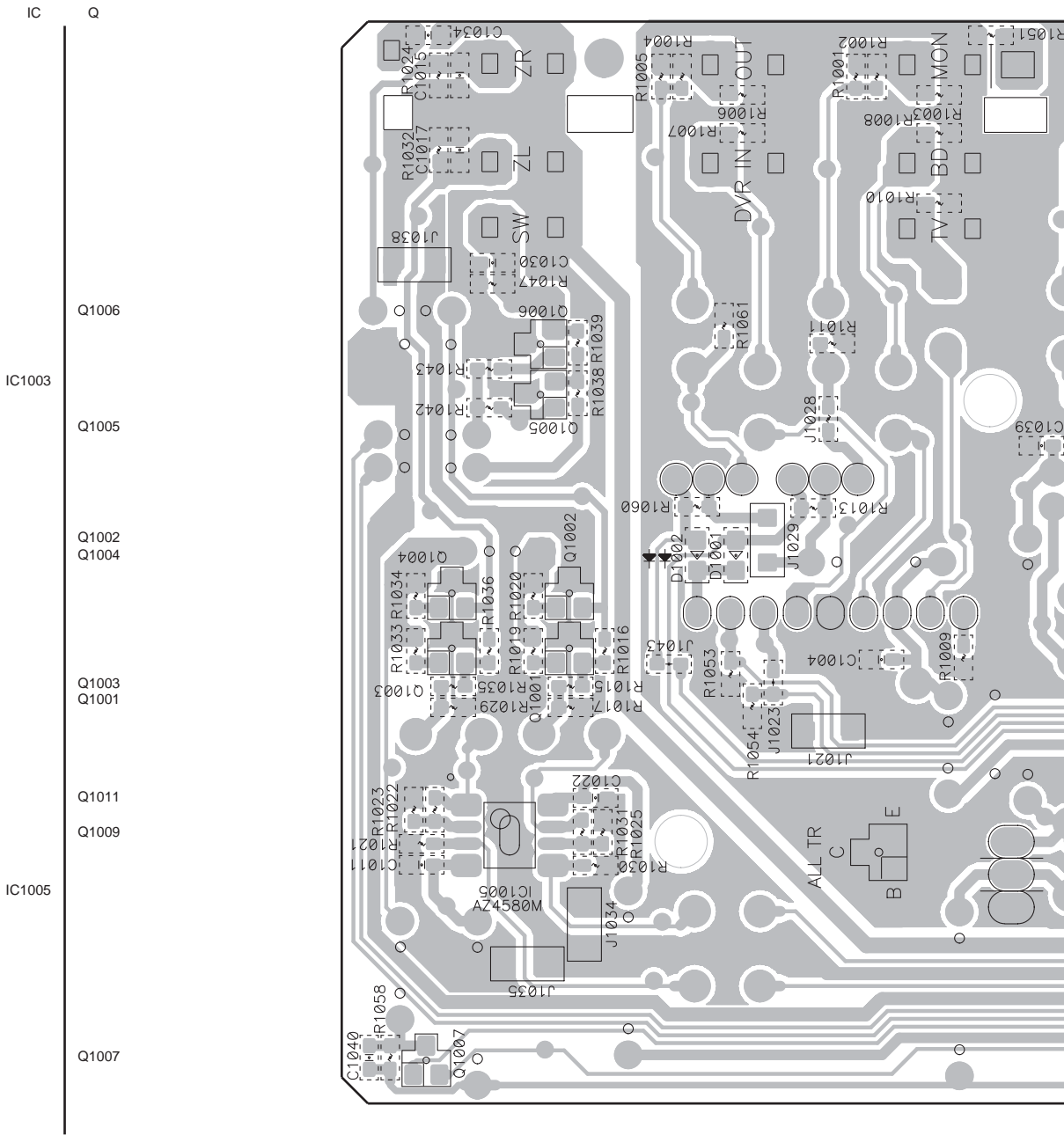

SIDE B

A

B

C

D

E

F

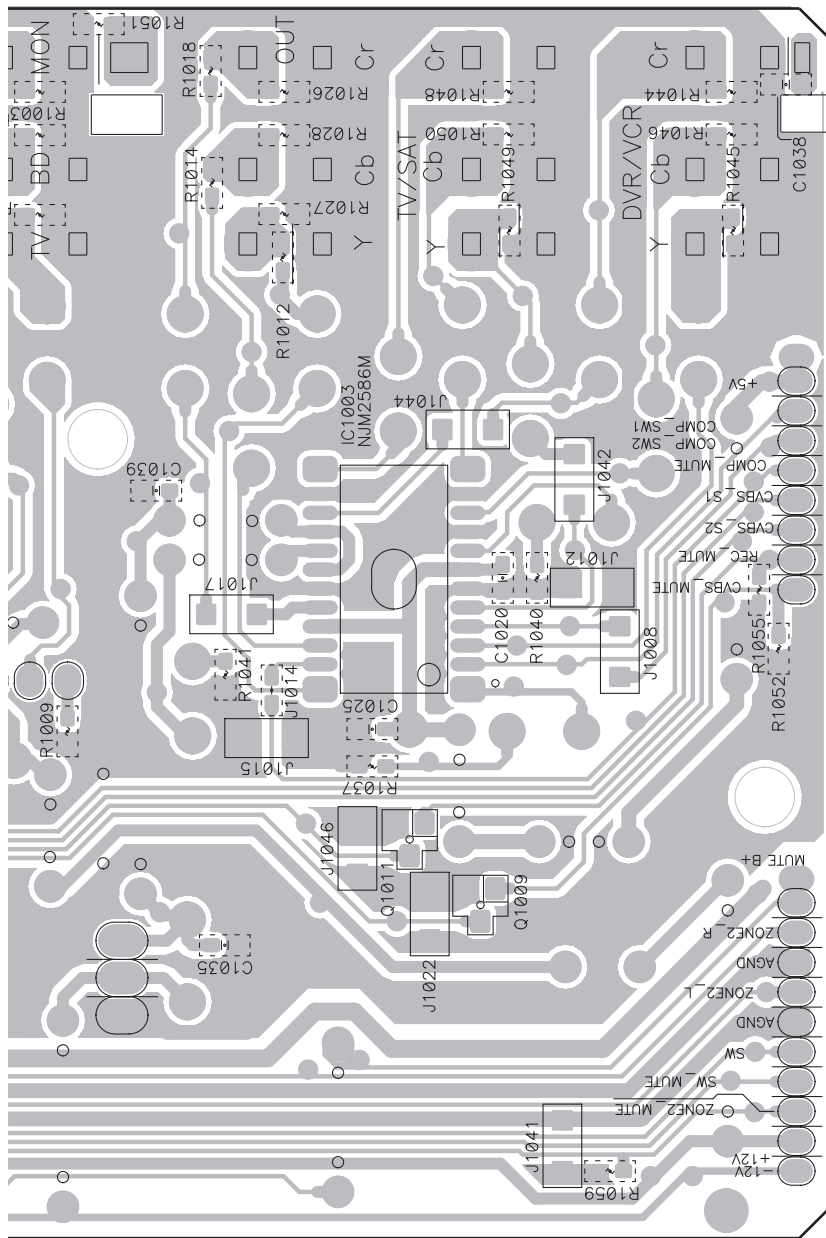

11.7 P.C.B SUB ASSY (SPEAKER-519)

SIDE A

SIDE A

M P.C.B SUB ASSY (SPEAKER-519)

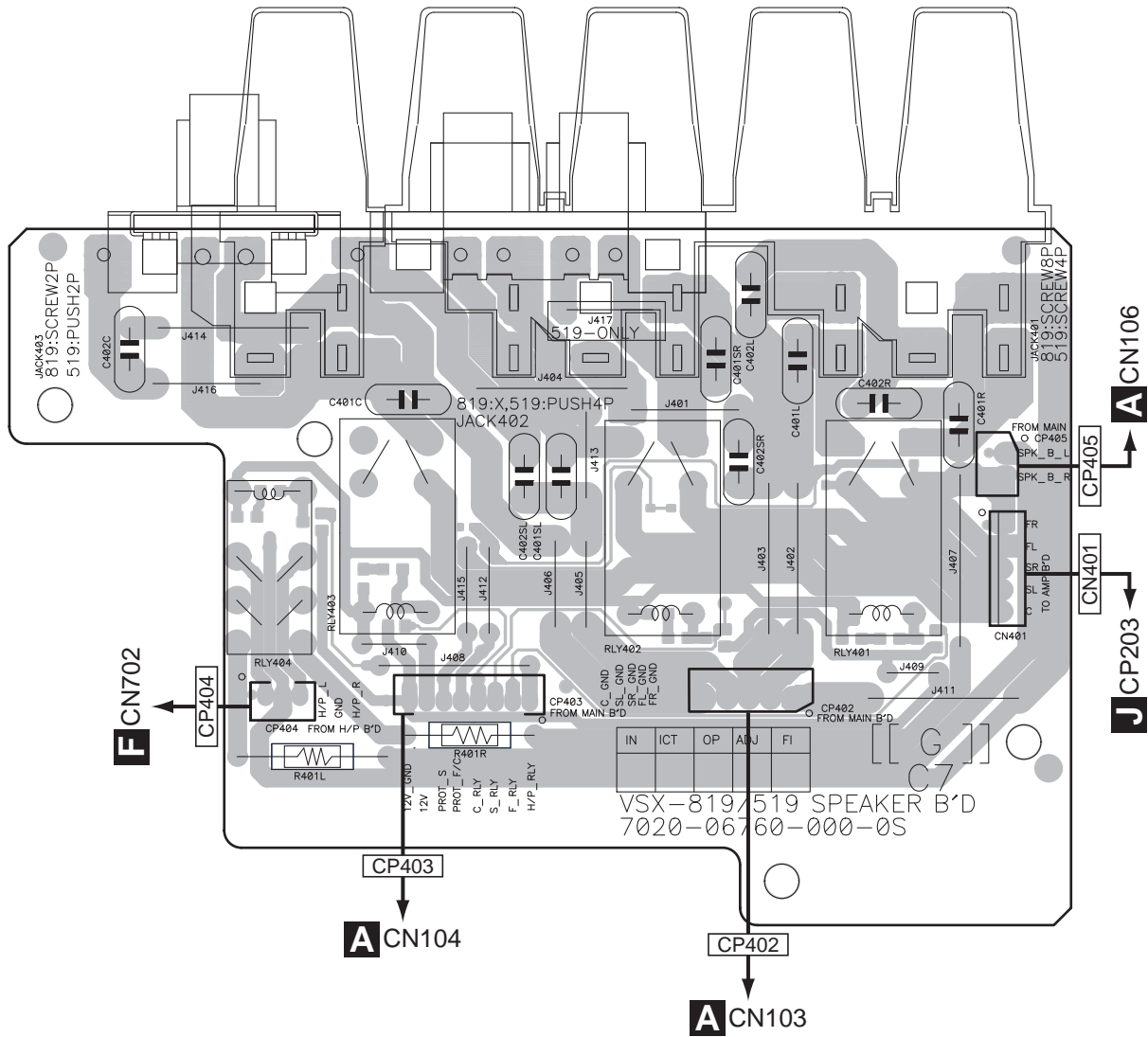

SIDE B

SIDE B

M P.C.B SUB ASSY (SPEAKER-519)

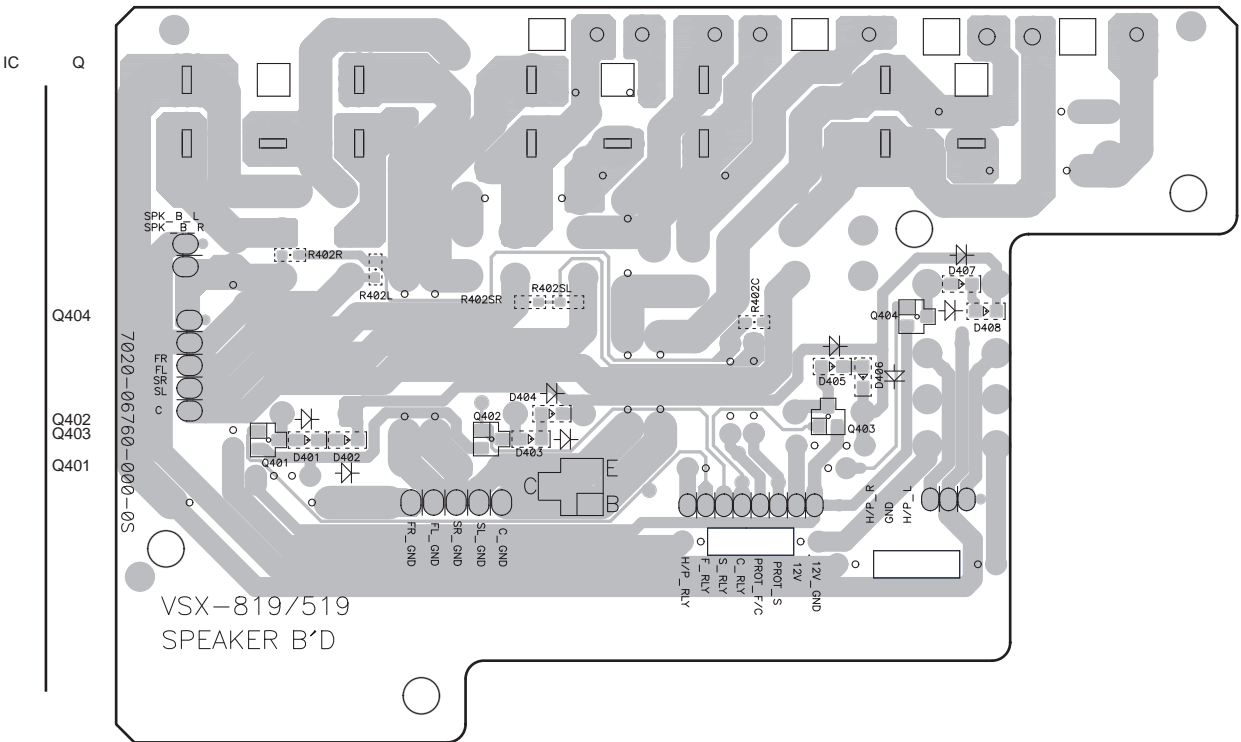

11.8 P.C.B SUB ASSY (DSP) and P.C.B SUB ASSY (CNT)

SIDE A

P P.C.B SUB ASSY (DSP)

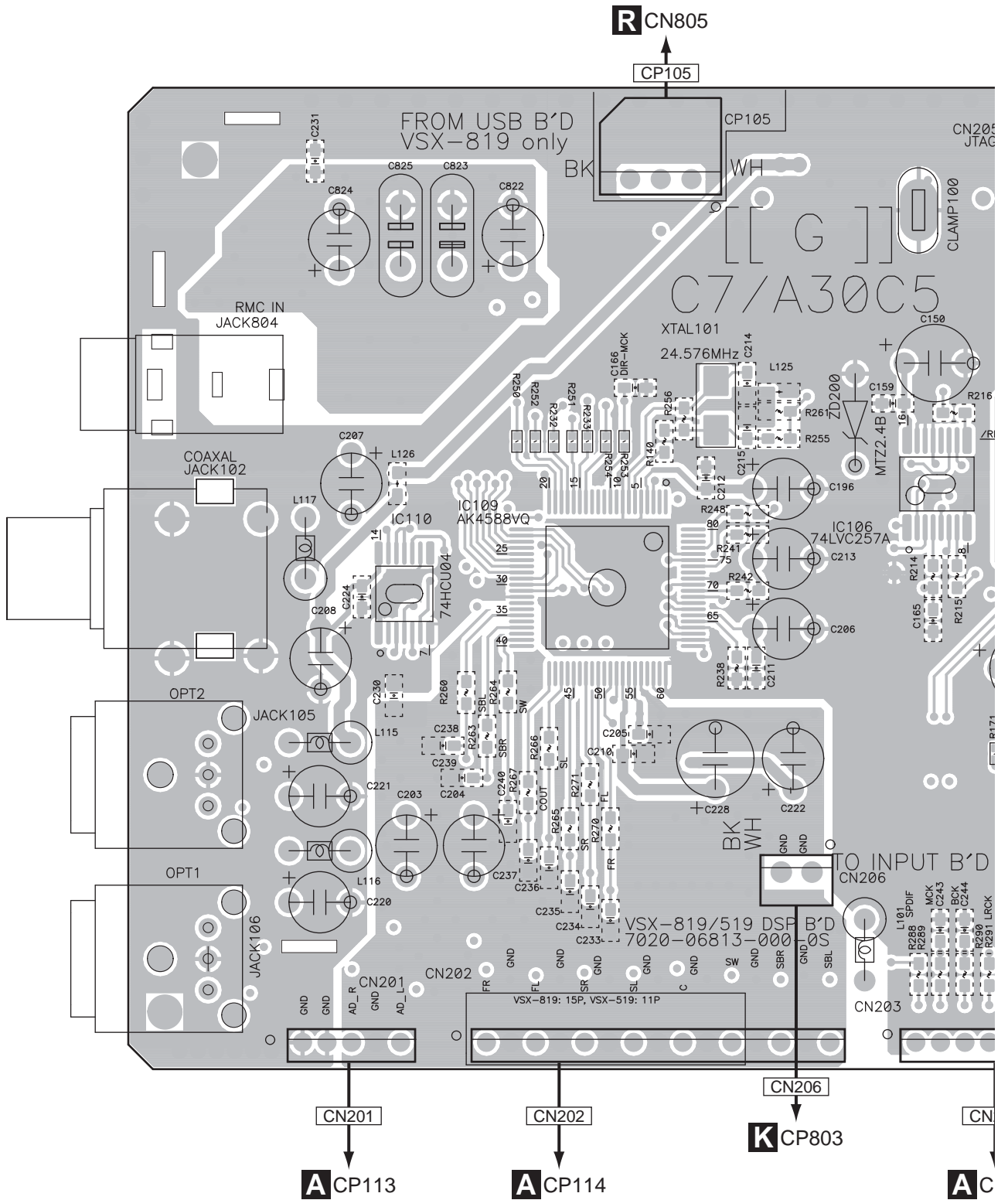

N P

SIDE A

A
B
C
D
E
F

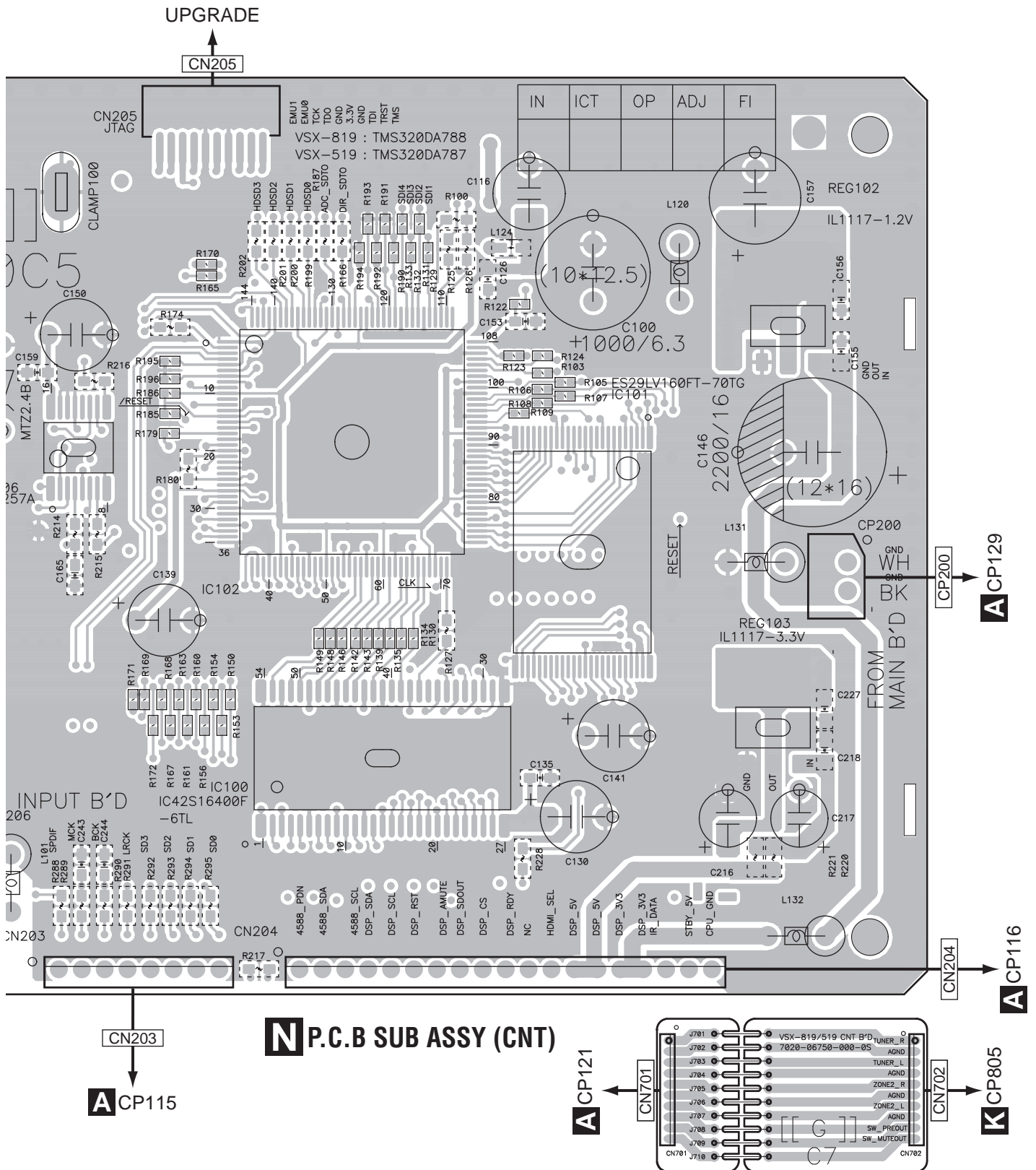

N P.C.B SUB ASSY (CNT)

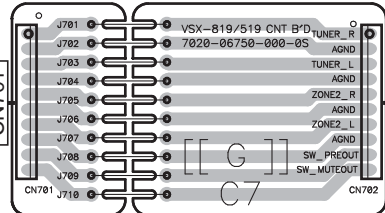

N P

SIDE B

A

P P.C.B SUB ASSY (DSP)

B

C

D

E

F

IC Q

Q802

IC806

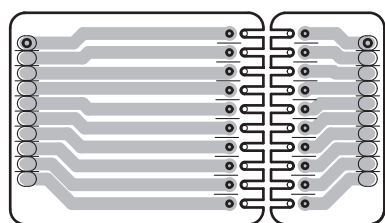
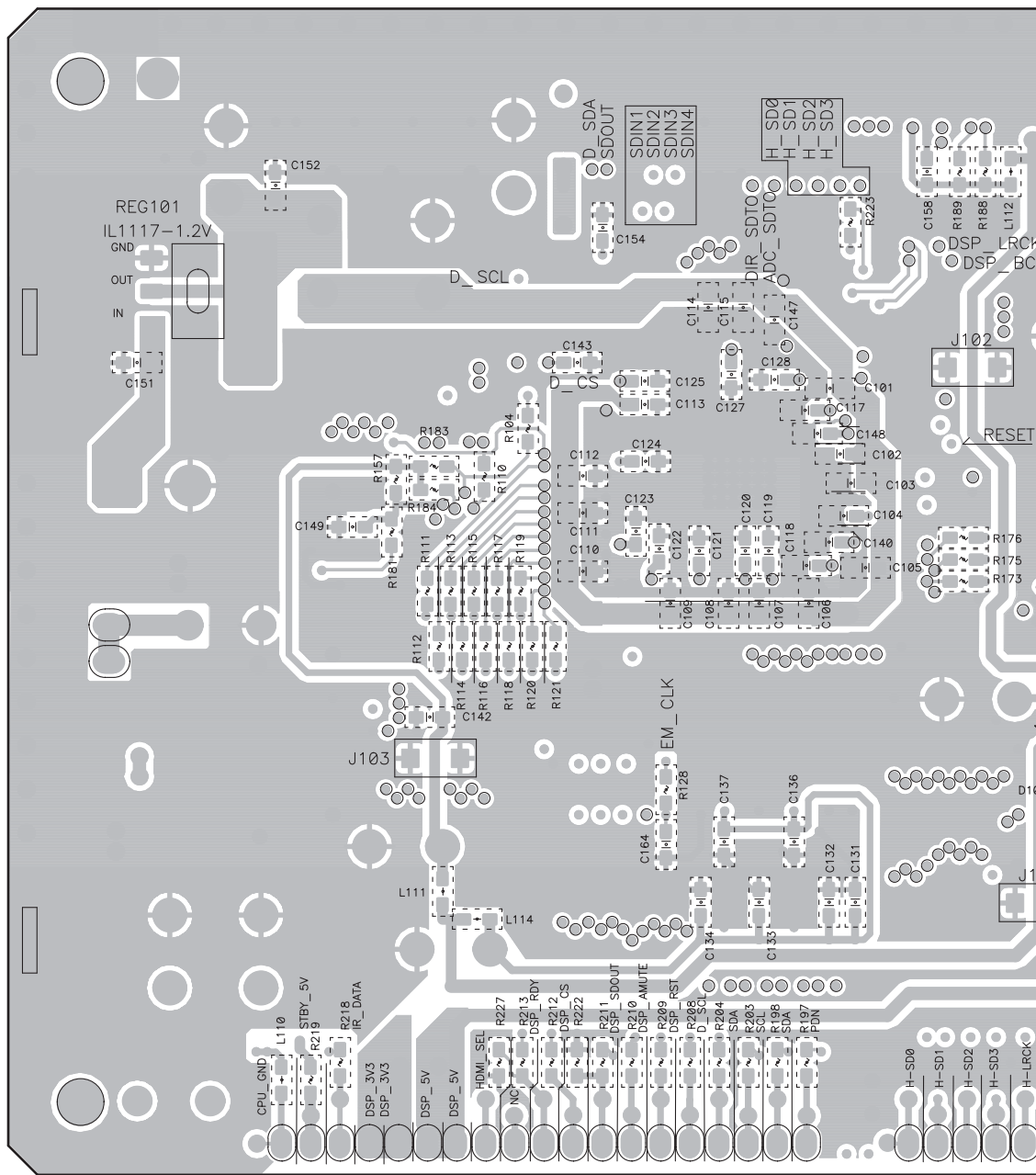

N P.C.B SUB ASSY (CNT)



11.9 P.C.B SUB ASSY (HDMI-519)

SIDE A

SIDE A

Q P.C.B SUB ASSY (HDMI-519)

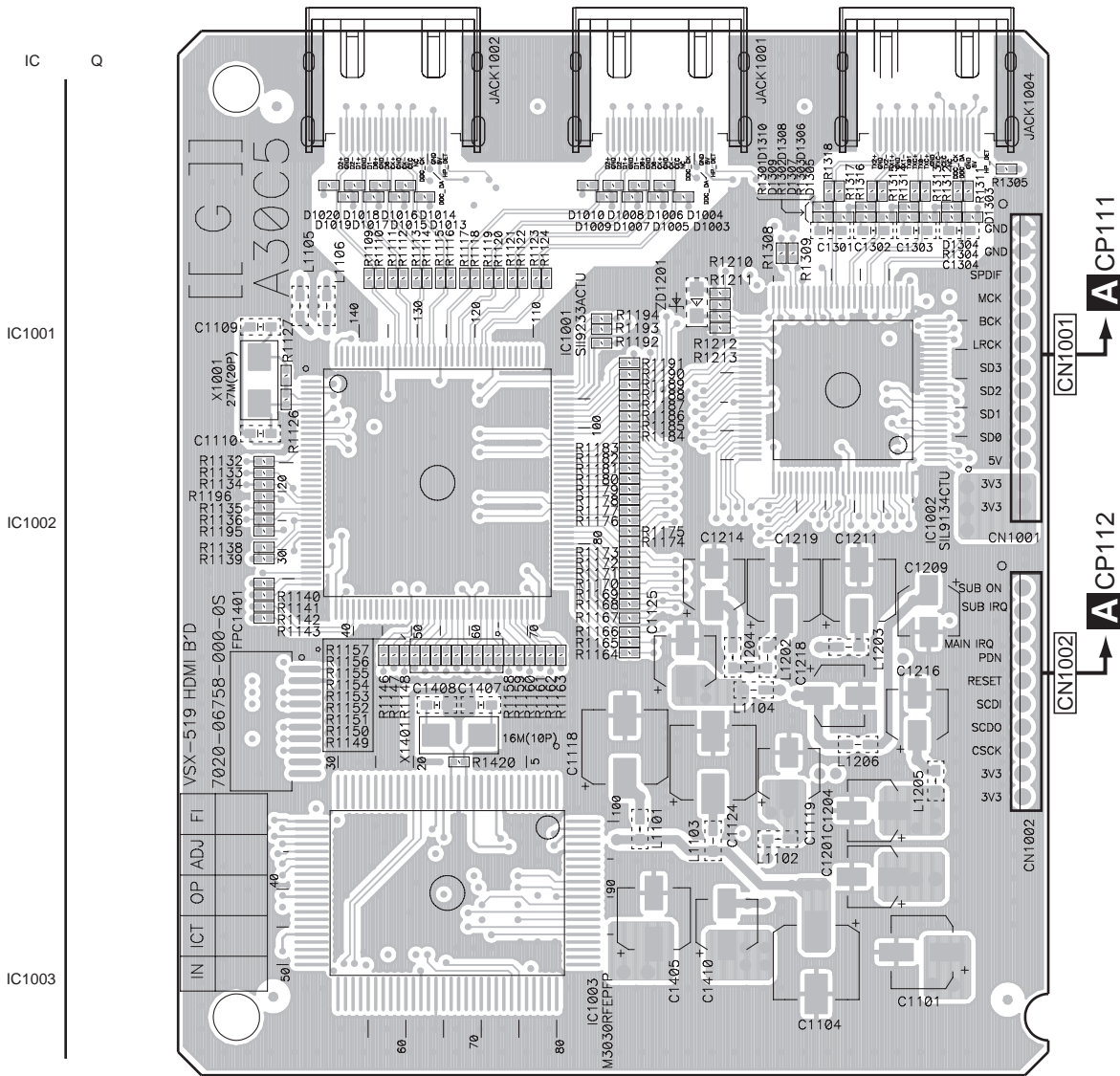

12. PCB PARTS LIST

NOTES: ● Parts marked by "NSP" are generally unavailable because they are not in our Master Spare Parts List.

● The Δ mark found on some component parts indicates the importance of the safety factor of the part. Therefore, when replacing, be sure to use parts of identical designation.

● When ordering resistors, first convert resistance values into code form as shown in the following examples.

Ex.1 When there are 2 effective digits (any digit apart from 0), such as 560 ohm and 47 k ohm (tolerance is shown by J = 5%, and K = 10%).

560 Ω \rightarrow 56 $\times 10^1$ \rightarrow 561.....RD1/APU $\boxed{5}$ $\boxed{6}$ $\boxed{7}$ J

47 k Ω \rightarrow 47 $\times 10^3$ \rightarrow 473.....RD1/APU $\boxed{4}$ $\boxed{7}$ $\boxed{3}$ J

0.5 Ω \rightarrow R50.....RN2H \boxed{R} $\boxed{5}$ $\boxed{0}$ K

1 Ω \rightarrow 1R0.....RSIP $\boxed{7}$ \boxed{R} $\boxed{0}$ K

Ex.2 When there are 3 effective digits (such as in high precision metal film resistors).

5.62 k Ω \rightarrow 562 $\times 10^1$ \rightarrow 5621.....RN1/4PC $\boxed{5}$ $\boxed{6}$ $\boxed{2}$ $\boxed{1}$ F

● Meaning of the figures and others in the parentheses in the parts list.

Example) IC 301 is on the point (face A, 91 of x-axis, and 111 of y-axis) of the corresponding PC board.

IC 301 (A, 91, 111) IC NJM2068V

● PCB PARTS LIST

JA***

RY***

T***

X***

FU***

V***

S***

Q***I - Q***5

● SCHEMATIC DIAGRAM and PCB CONNECTION DIAGRAM

JACK***, JK***

RLY***

PT***

XTAL***, RES*** (CERAMIC)

F***

FLT***

SW***, VEC*** (ENCODER)

Q***FL, Q***FR, Q***C, Q***SL, Q***SR

Mark No.	Description	Part No.	Mark No.	Description	Part No.
----------	-------------	----------	----------	-------------	----------

LIST OF ASSEMBLIES

Δ NSP1..P.C.B TOTAL ASSY (AMP)	7025HK0811012-IL	Δ IC 103	J126781200040-IL
2..P.C.B SUB ASSY (AMP)	7028067521010-IL	Δ IC 104	J126791200060-IL

NSP 1..P.C.B TOTAL ASSY (FRONT)	7025HK0812011-IL	IC 106	J000241600020-IL
2..P.C.B SUB ASSY (FRONT)	7028067511020-IL	IC 109	J040740800230-IL
2..P.C.B SUB ASSY (HEADPHONE)	7028067512010-IL	IC 110	J040740800240-IL
2..P.C.B SUB ASSY (VOLUME)	7028067513010-IL	Δ IC 111,112	J126111733050-IL
2..P.C.B SUB ASSY (FUNCTION)	7028067514010-IL	Δ IC 113-115	J126780500110-IL
2..P.C.B SUB ASSY (PORTABLE)	7028067518010-IL	Δ IC 301	J126111700041-IL
		Δ IC 302	J126111750010-IL

NSP 1..P.C.B TOTAL ASSY (INPUT)	7025HK0812013-IL	Q 101,102,138,300	J522038750210-IL
2..P.C.B SUB ASSY (INPUT)	7028067531020-IL	Q 103,111	J522010500210-IL

NSP 1..P.C.B TOTAL ASSY (VIDEO-519)	7025HK0812014-IL	Δ Q 106,107	J501778000010-IL
2..P.C.B SUB ASSY (VIDEO-519)	7028067551010-IL	Δ Q 108	J5011049Y0010-IL
		Q 121,123,124	J5001268B0050-IL

NSP 1..P.C.B TOTAL ASSY (DSP)	7025HK0812015-IL	Q 122	J5023198Y0000-IL
2..P.C.B SUB ASSY (DSP)	7028067561020-IL	Q 125	J5000916Y0050-IL
		Q 301	J522038750210-IL

NSP 1..P.C.B TOTAL ASSY (HDMI-519)	7025HK0812016-IL	Q 302	J522107S00210-IL
2..P.C.B SUB ASSY (HDMI-519)	7028067581010-IL	D 101-105,125,127	K005041480030-IL

NSP 1..P.C.B TOTAL ASSY (MAIN)	7025HK0812010-IL	Δ D 128,135,136	K005041480030-IL
2..P.C.B SUB ASSY (MAIN)	7028067501020-IL	D 301-304	K005041480030-IL
2..P.C.B SUB ASSY (GUIDE-L)	7028067502010-IL	D 1101-1103 (BD101-103)	K047604000020-IL
2..P.C.B SUB ASSY (GUIDE-R)	7028067503010-IL		
2..P.C.B SUB ASSY (CNT)	7028067504010-IL		
2..P.C.B SUB ASSY (P/T)	7028067505010-IL		
2..P.C.B SUB ASSY (H/P GUIDE)	7028067506010-IL		

NSP 1..P.C.B TOTAL ASSY (SPEAKER)	7025HK0812017-IL		
2..P.C.B SUB ASSY (SPEAKER-519)	7028067601030-IL		

Mark No.	Description	Part No.
----------	-------------	----------

A P.C.B SUB ASSY (MAIN)

SEMICONDUCTORS

IC 101	J020303020030-IL
--------	------------------

MISCELLANEOUS

L 101,102 (BEAD101, 102) BEAD,COIL	7610010030000-IL
JA 101 TUNER	E903104100030-IL
JA 102 TER,BOARD PUSH 2P	G592212A0300Y-IL
RY 101 RELAY	G680120502050-IL
RY 302 RELAY	G680060502010-IL

Δ T 301 POWER TRANS	8200280150420-IL
X 101 RESONATOR,CERAMIC	E830160000060-IL
HS 101 HEAT SINK	2120210958010-IL
HS 104,114 HEAT SINK	2120000818020-IL
Δ FU 301 FUSE GLASS TUBE 20MM	N751226301110-IL

RESISTORS

Mark	No.	Description	Part No.
	R	101-104,201,202	C060R22065050-IL
	R	105,106,203	C060033065050-IL
	R	159	C060015165050-IL
	R	174-176	C060022265050-IL
	R	178,179	C141R10069010-IL
	R	184	C0604R7065050-IL
⚠	R	186	C060022063050-IL
	R	304	C060010063050-IL

CAPACITORS

C	179,180	D040682088010-IL
C	182-186	D02010407H080-IL
C	189	D040331088230-IL
C	200	D040682083000-IL
C	201-203,208-210	D02047306C060-IL

C	206	D040472084020-IL
C	207	D040102084060-IL
C	222,224	D040471081070-IL
C	236	D040103083000-IL
C	237-239,1026,1027	D02047306C060-IL

C	301	D040102083030-IL
C	304	D00847208H010-IL
C	1016,1017 (C101L, C101R)	D02010306C060-IL

B P.C.B SUB ASSY (P/T)**SEMICONDUCTORS**

Q	126,128,131,134	J5001268B0050-IL
Q	127,129,130,132	J5023198Y0000-IL
Q	133,135,136	J5023198Y0000-IL
D	112,113	K005041480030-IL

RESISTORS

R	189	C00004736P520-IL
R	190	C060047363050-IL

C P.C.B SUB ASSY (FRONT)**SEMICONDUCTORS**

IC	701	J127163150010-IL
IC	7011 (RMC701)	E940343800010-IL
⚠	Q 702	J5000933S0050-IL
	Q 703	J522107S00210-IL

MISCELLANEOUS

L	701 COIL	D330101001020-IL
L	702 COIL,FILTER-INDUCTOR	D330100700520-IL
V	701 DISPLAY,FLT	K530126300010-IL
S	701-714 SWITCH 0000 HOLDER	G180040500010-IL 432004078301A-IL

RESISTORS

R	779,780	C0602R2063050-IL
---	---------	------------------

CAPACITORS

C	718,719	D02047306C060-IL
---	---------	------------------

D P.C.B SUB ASSY (VOLUME)**SEMICONDUCTORS**

D	707,709	K005041480030-IL
---	---------	------------------

MISCELLANEOUS

S	702 SW,ENCODER	G121123040010-IL
---	----------------	------------------

Mark	No.	Description	Part No.
------	-----	-------------	----------

E P.C.B SUB ASSY (FUNCTION)**SEMICONDUCTORS**

D	711,712	K005041480030-IL
---	---------	------------------

MISCELLANEOUS

S	701 SW,ENCODER	G121123050020-IL
S	715 SWITCH	G180040500010-IL

F P.C.B SUB ASSY (HEADPHONE)**SEMICONDUCTORS**

D	705,706	K005041480030-IL
---	---------	------------------

MISCELLANEOUS

JA	701 JACK,D6.5	G402PJ619AG0Y-IL
----	---------------	------------------

I P.C.B SUB ASSY (PORTABLE)**SEMICONDUCTORS**

D	713,714	K005041480030-IL
---	---------	------------------

MISCELLANEOUS

JA	703 JACK,D3.5	G401PJ354H70Y-IL
----	---------------	------------------

J P.C.B SUB ASSY (AMP)**SEMICONDUCTORS**

Q	2021-2025,2061-2065	J5023200B0050-IL
Q	2031-2035,2041-2045	J5000992F0050-IL

MISCELLANEOUS

L	2011-2015 COIL,FILTER-INDUCTOR	D330900001330-IL
VR	2011-2015 VR,SEMI CARBON MOLD	C541102315000-IL

RESISTORS

R	227,229	C060010065050-IL
R	2011-2015	C00007526P520-IL
R	2021-2025,2071-2075	C060056265050-IL
R	2031-2035	C00002226P520-IL
R	2041-2045	C00004746P520-IL

R	2051-2055,2231-2235	C0604R7063050-IL
R	2061-2065	C00001036P520-IL
R	2081-2085	C00005626P520-IL
⚠	R 2091-2095,2101-2105	N113136647820-IL
	R 2111-2115	C00002216P520-IL

R	2121-2125,2181-2185	C00003336P520-IL
R	2131-2135	C00003026P520-IL
R	2141-2145	C060010065520-IL
⚠	R 2151-2155,2161-2165	N113136647820-IL
	R 2191-2195	C00003346P520-IL

R	2201-2205	C00005616P520-IL
R	2211-2215,2251-2255	C00001226P520-IL
R	2221-2225	C00004736P520-IL
R	2241-2245	C060047063050-IL
R	2261-2265	C00004716P520-IL

R	2281-2285	N113135610020-IL
---	-----------	------------------

CAPACITORS

C	2011-2015,2111-2115	D00410106D050-IL
C	2031-2035	D00422106D05C-IL
C	2041-2045	D00033006D050-IL
C	2091-2095	D004471277050-IL
C	2101-2105	D004102277050-IL

Mark	No.	Description	Part No.
	C	2131-2135,2141-2145	D020104167050-IL

Mark	No.	Description	Part No.
------	-----	-------------	----------

N P.C.B SUB ASSY (CNT)

P.C.B SUB ASSY (CNT) has no service part.

P P.C.B SUB ASSY (DSP)

SEMICONDUCTORS

IC 100	J001421640040-IL
IC 101	J005291600040-IL
IC 102	J080320788010-IL
⚠ IC 103 (REG103)	J126111700041-IL
IC 106	J040742570030-IL

IC 109	J080458800010-IL
IC 110	J040740400290-IL
IC 806	J030151100010-IL
⚠ IC 1011,1021 (REG101, REG102)	J126111712040-IL
Q 802	J522010500210-IL

D 101-103	K005041480030-IL
-----------	------------------

MISCELLANEOUS

L 115,116 COIL	D3304R7000150-IL
L 117 COIL	D3302R2000150-IL
L 120 BEAD,COIL	7610035500030-IL
JA 102 TER,RCA 1PIN	G600107A0000Y-IL
JA 105,106 OPTICAL RECEIVER	E100116500040-IL

JA 804 JACK,D3.5	G40130802000Y-IL
X 101 CRYSTAL CHIP (24.576 MHz)	E80524R576020-IL

CAPACITORS

C 823,825	D02012306C060-IL
-----------	------------------

Q P.C.B SUB ASSY (HDMI-519)

SEMICONDUCTORS

IC 1001	J040923300030-IL
IC 1002	J040913400010-IL
IC 1003	J020303020030-IL
⚠ IC 1004	J126111712040-IL
⚠ IC 1005	J126111710011-IL

Q 1001-1004	J522390400010-IL
Q 1201	J522104S00210-IL
Q 1204	J500124200010-IL
⚠ Q 1401	J5232114K0010-IL
Q 1402,1403	J522038750210-IL

Q 1405	J522010200210-IL
D 1401	K005041480030-IL

MISCELLANEOUS

JA 1001,1002,1004 CN.WAFER	L109100190050-IL
X 1001 CRYSTAL CHIP (27.000 MHz)	E80527R000010-IL
X 1401 CRYSTAL CHIP (16.000 MHz)	E80516R000010-IL

P.C.B SUB ASSY (GUIDE-L)

MISCELLANEOUS

801 JHMX9800(ON)HAITI)	4330000120000-IL
------------------------	------------------

P.C.B SUB ASSY (GUIDE-R)

MISCELLANEOUS

901 JHMX9800(ON)HAITI)	4330000120000-IL
------------------------	------------------

K P.C.B SUB ASSY (INPUT)

SEMICONDUCTORS

IC 801	J084152180010-IL
IC 802	J121458000020-IL
Q 801,803,805,806	J5222875B0010-IL
Q 802,804,807,809	J520010200210-IL
Q 808	J5222875B0010-IL

D 801-810	K005041480030-IL
-----------	------------------

MISCELLANEOUS

JA 802-804 TER,RCA 6PIN	G603060056000-IL
-------------------------	------------------

RESISTORS

⚠ R 874,875	C060010165060-IL
-------------	------------------

CAPACITORS

C 803,830	D02022306C060-IL
C 804,829	D02047306C060-IL
C 805,828	D020154068050-IL

L P.C.B SUB ASSY (VIDEO-519)

SEMICONDUCTORS

IC 1001	J171795600010-IL
IC 1003	J171258600010-IL
IC 1004	J126790500070-IL
⚠ IC 1005	J121458000020-IL
Q 1001-1006	J5222875B0010-IL

Q 1007,1009,1014	J520010200210-IL
Q 1008,1010	J5023198Y0000-IL
Q 1011,1015	J5200107S0050-IL
Q 1012,1013	J522011000210-IL
D 1001,1002	K005041480030-IL

MISCELLANEOUS

L 1001 BEAD,COIL	7610035500030-IL
JA 1001 TER,RCA 3PIN	G606319A1B13Y-IL
JA 1002 TER,RCA	G608610D0209Y-IL
JA 1003 TER,RCA 9PIN	G607902AD016Y-IL

CAPACITORS

C 1009,1012,1016	D040471081070-IL
------------------	------------------

M P.C.B SUB ASSY (SPEAKER-519)

SEMICONDUCTORS

Q 401-404	J522010500210-IL
D 401-408	K005041480030-IL

MISCELLANEOUS

JA 401 TER,BOARD SCREW 4P	G612405E0200Y-IL
JA 402 TER,BOARD PUSH 4P	G594408SA030Y-IL
JA 403 TER,BOARD PUSH 2P	G592212A0300Y-IL
RY 401-403 RELAY	G680120502050-IL
RY 404 RELAY	G680240202030-IL

RESISTORS

R 4016,4017 (R401L, R401R)	C060033166520-IL
----------------------------	------------------

CAPACITORS

C 4013-4017	D02010306C060-IL
C 4022-4024,4026,4027	D02047306C060-IL