

# Service Manual

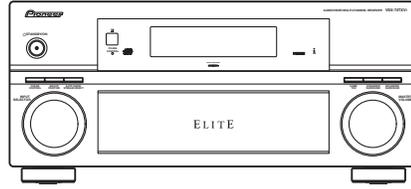

VSX-74TXVi

**PROVISIONAL**

**AUDIO/VIDEO MULTI-CHANNEL RECEIVER**

# VSX-74TXVi

## VSX-74TXVi-S

## VSX-72TXV

## VSX-72TXV-S

**THIS MANUAL IS APPLICABLE TO THE FOLLOWING MODEL(S) AND TYPE(S).**

Model	Type	Power Requirement	Remarks
VSX-74TXVi	KUXJ/CA	AC120V	
VSX-74TXVi-S	KUXJC	AC120V	
VSX-72TXV	KUXJ/CA	AC120V	
VSX-72TXV-S	KUXJC	AC120V	



For details, refer to "Important Check Points for Good Servicing".

# SAFETY INFORMATION



This service manual is intended for qualified service technicians; it is not meant for the casual do-it-yourselfer. Qualified technicians have the necessary test equipment and tools, and have been trained to properly and safely repair complex products such as those covered by this manual.

Improperly performed repairs can adversely affect the safety and reliability of the product and may void the warranty. If you are not qualified to perform the repair of this product properly and safely, you should not risk trying to do so and refer the repair to a qualified service technician.

## WARNING

This product contains lead in solder and certain electrical parts contain chemicals which are known to the state of California to cause cancer, birth defects or other reproductive harm.

Health & Safety Code Section 25249.6 – Proposition 65

## NOTICE

(FOR CANADIAN MODEL ONLY)

Fuse symbols  (fast operating fuse) and/or  (slow operating fuse) on PCB indicate that replacement parts must be of identical designation.

## REMARQUE

(POUR MODÈLE CANADIEN SEULEMENT)

Les symboles de fusible  (fusible de type rapide) et/ou  (fusible de type lent) sur CCI indiquent que les pièces de remplacement doivent avoir la même désignation.

## (FOR USA MODEL ONLY)

### 1. SAFETY PRECAUTIONS

The following check should be performed for the continued protection of the customer and service technician.

#### LEAKAGE CURRENT CHECK

Measure leakage current to a known earth ground (water pipe, conduit, etc.) by connecting a leakage current tester such as Simpson Model 229-2 or equivalent between the earth ground and all exposed metal parts of the appliance (input/output terminals, screwheads, metal overlays, control shaft, etc.). Plug the AC line cord of the appliance directly into a 120V AC 60 Hz outlet and turn the AC power switch on. Any current measured must not exceed 0.5 mA.

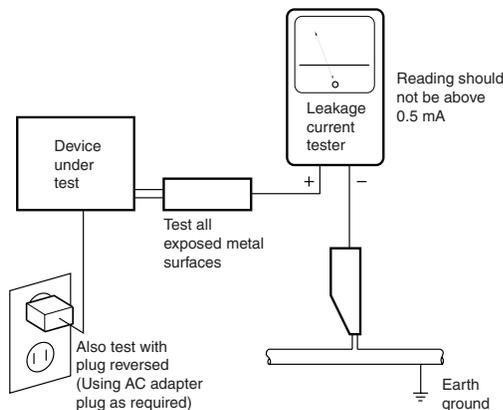

AC Leakage Test

**ANY MEASUREMENTS NOT WITHIN THE LIMITS OUTLINED ABOVE ARE INDICATIVE OF A POTENTIAL SHOCK HAZARD AND MUST BE CORRECTED BEFORE RETURNING THE APPLIANCE TO THE CUSTOMER.**

### 2. PRODUCT SAFETY NOTICE

Many electrical and mechanical parts in the appliance have special safety related characteristics. These are often not evident from visual inspection nor the protection afforded by them necessarily can be obtained by using replacement components rated for voltage, wattage, etc. Replacement parts which have these special safety characteristics are identified in this Service Manual.

Electrical components having such features are identified by marking with a  $\Delta$  on the schematics and on the parts list in this Service Manual.

The use of a substitute replacement component which does not have the same safety characteristics as the PIONEER recommended replacement one, shown in the parts list in this Service Manual, may create shock, fire, or other hazards.

Product Safety is continuously under review and new instructions are issued from time to time. For the latest information, always consult the current PIONEER Service Manual. A subscription to, or additional copies of, PIONEER Service Manual may be obtained at a nominal charge from PIONEER.

## [Important Check Points for Good Servicing]

In this manual, procedures that must be performed during repairs are marked with the below symbol. Please be sure to confirm and follow these procedures.

### 1. Product safety



Please conform to product regulations (such as safety and radiation regulations), and maintain a safe servicing environment by following the safety instructions described in this manual.

- ① Use specified parts for repair.

Use genuine parts. Be sure to use important parts for safety.

- ② Do not perform modifications without proper instructions.

Please follow the specified safety methods when modification (addition/change of parts) is required due to interferences such as radio/TV interference and foreign noise.

- ③ Make sure the soldering of repaired locations is properly performed.

When you solder while repairing, please be sure that there are no cold solder and other debris. Soldering should be finished with the proper quantity. (Refer to the example)

- ④ Make sure the screws are tightly fastened.

Please be sure that all screws are fastened, and that there are no loose screws.

- ⑤ Make sure each connectors are correctly inserted.

Please be sure that all connectors are inserted, and that there are no imperfect insertion.

- ⑥ Make sure the wiring cables are set to their original state.

Please replace the wiring and cables to the original state after repairs. In addition, be sure that there are no pinched wires, etc.

- ⑦ Make sure screws and soldering scraps do not remain inside the product.

Please check that neither solder debris nor screws remain inside the product.

- ⑧ There should be no semi-broken wires, scratches, melting, etc. on the coating of the power cord.

Damaged power cords may lead to fire accidents, so please be sure that there are no damages. If you find a damaged power cord, please exchange it with a suitable one.

- ⑨ There should be no spark traces or similar marks on the power plug.

When spark traces or similar marks are found on the power supply plug, please check the connection and advise on secure connections and suitable usage. Please exchange the power cord if necessary.

- ⑩ Safe environment should be secured during servicing.

When you perform repairs, please pay attention to static electricity, furniture, household articles, etc. in order to prevent injuries. Please pay attention to your surroundings and repair safely.

### 2. Adjustments



To keep the original performance of the products, optimum adjustments and confirmation of characteristics within specification. Adjustments should be performed in accordance with the procedures/instructions described in this manual.

### 3. Lubricants, Glues, and Replacement parts



Use grease and adhesives that are equal to the specified substance. Make sure the proper amount is applied.

### 4. Cleaning



For parts that require cleaning, such as optical pickups, tape deck heads, lenses and mirrors used in projection monitors, proper cleaning should be performed to restore their performances.

### 5. Shipping mode and Shipping screws



To protect products from damages or failures during transit, the shipping mode should be set or the shipping screws should be installed before shipment. Please be sure to follow this method especially if it is specified in this manual.

# CONTENTS

- SAFETY INFORMATION ..... 2
- 1. SPECIFICATIONS ..... 6
- A 2. EXPLODED VIEWS AND PARTS LIST ..... 8
  - 2.1 PACKING ..... 8
  - 2.2 EXTERIOR..... 10
  - 2.3 CHASSIS SECTION ..... 12
  - 2.4 REAR PANEL SECTION..... 14
  - 2.5 POWER AMP BLOCK..... 16
  - 2.6 FRONT PANEL SECTION ..... 18
- 3. BLOCK DIAGRAM AND SCHEMATIC DIAGRAM ..... 20
  - 3.1 BLOCK DIAGRAM ..... 20
    - 3.1.1 OVERALL BLOCK DIAGRAM ..... 20
    - 3.1.2 COMPOSITE V BLOCK DIAGRAM ..... 22
    - 3.1.3 S-VIDEO BLOCK DIAGRAM ..... 23
    - B 3.1.4 COMPONENT & VOL BLOCK DIAGRAM ..... 24
    - 3.1.5 DSP BLOCK DIAGRAM ..... 25
    - 3.1.6 HDMI & DVC BLOCK DIAGRAM ..... 26
    - 3.1.7 MICROCOMPUTER BLOCK DIAGRAM ..... 27
  - 3.2 OVERALL WIRING CONNECTION DIAGRAM..... 28
  - 3.3 AUDIO & MULTI CH IN ASSY ..... 30
  - 3.4 V-AUDIO ASSY ..... 32
  - 3.5 FRONT-IN and HEADPHONE ASSYS..... 34
  - 3.6 BRIDGE1, BRIDGE2, TRANS SIDE and BRIDGE3 ASSYS ..... 36
  - 3.7 COMPOSITE V ASSY ..... 38
  - 3.8 S-VIDEO ASSY..... 40
  - C 3.9 COMPONENT & VOL ASSY (1/4) ..... 42
  - 3.10 COMPONENT & VOL ASSY (2/4) ..... 44
  - 3.11 COMPONENT & VOL ASSY (3/4) ..... 46
  - 3.12 COMPONENT & VOL ASSY (4/4) ..... 48
  - 3.13 DIGITAL MOTHER ASSY (1/8) ..... 50
  - 3.14 DIGITAL MOTHER ASSY (2/8) ..... 52
  - 3.15 DIGITAL MOTHER ASSY (3/8) ..... 54
  - 3.16 DIGITAL MOTHER ASSY (4/8) ..... 56
  - 3.17 DIGITAL MOTHER ASSY (5/8) ..... 58
  - 3.18 DIGITAL MOTHER ASSY (6/8) ..... 60
  - 3.19 DIGITAL MOTHER ASSY (7/8) ..... 62
  - 3.20 DIGITAL MOTHER ASSY (8/8) ..... 64
  - D 3.21 DSP ASSY (1/2)..... 66
  - 3.22 DSP ASSY (2/2)..... 68
  - 3.23 INTERFACE ASSY ..... 70
  - 3.24 POWER AMP IN and POWER PROTECT ASSYS..... 72
  - 3.25 POWER AMP L ASSY ..... 74
  - 3.26 POWER AMP R ASSY..... 76
  - 3.27 LOCAL SUPPLY and DC/DC ASSYS ..... 78
  - 3.28 TRANS2-1, VH-TR, DIODE and SP/PS ASSYS ..... 80
  - 3.29 TRANS2-2, TRANS1 and PRIMARY ASSYS..... 82
  - 3.30 VOLUME, DISPLAY and INPUT SELECT ASSYS..... 84
  - 3.31 PREOUT & CONTROL ASSY..... 86
  - 3.32 1394 ASSY (1/2) ..... 88
  - E 3.33 1394 ASSY (2/2) ..... 90
  - 3.34 HDMI&DVC ASSY (1/2) ..... 92
  - 3.35 HDMI&DVC ASSY (2/2) ..... 94
- 4. PCB CONNECTION DIAGRAM ..... 96
  - 4.1 PRIOUT&CONTROL ASSY ..... 97
  - 4.2 AUDIO&MULTI CH IN ASSY ..... 98
  - 4.3 V-AUDIO ASSY ..... 99
  - 4.4 HEAD PHONE and FRONT-IN ASSYS..... 100
  - 4.5 BRIDGE1 and BRIDGE2 ASSYS ..... 101
  - 4.6 TRANS SIDE and BRIDGE3 ASSYS ..... 102
  - 4.7 COMPOSITE V ASSYS ..... 104
  - 4.8 S-VIDEO ASSY..... 105
  - F 4.9 COMPONENT&VOL ASSY..... 106
  - 4.10 DIGITAL MOTHER ASSY ..... 110
  - 4.11 DSP ASSY ..... 114
  - 4.12 INTERFACE ASSY ..... 116

4.13	POWER AMP IN ASSY .....	120
4.14	POWER PROTECT ASSY.....	121
4.15	POWER AMP L and POWER AMP R ASSYS.....	122
4.16	LOCAL SUPPLY and DC/DC ASSYS.....	126
4.17	TRANS2-1, VH TR, DIODE and TRANS2-2 ASSYS .....	128
4.18	SP/PS ASSY.....	130
4.19	TRANS1 and PRIMARY ASSYS .....	132
4.20	VOLUME, DISPLAY and INPUT SELECT ASSYS .....	134
4.21	HDMI&DVC ASSY .....	138
4.22	1394 ASSY .....	140
5.	PCB PARTS LIST .....	141
6.	ADJUSTMENT .....	188
7.	GENERAL INFORMATION .....	189
7.1	DIAGNOSIS.....	189
7.1.1	TEST MODE.....	189
7.1.2	PROTECTION CIRCUIT SPECIFICATION .....	193
7.1.3	TROUBLESHOOTING THE DSP BLOCK.....	195
7.1.4	DIAGNOSIS OF THE HDMI BLOCK AND RELATED SYSTEMS .....	203
7.1.5	FLOWCHART OF CONNECTION DIAGNOSIS OF THE HDMI BLOCK .....	216
7.1.6	DIAGNOSIS OF THE 1394 ASSY.....	219
7.1.7	iPod INFORMATION.....	224
7.1.8	XM RADIO INFORMATION.....	226
7.1.9	HOW TO REWRITE THE DSP FLASH ROM BY PLAYING BACK A CD.....	227
7.1.10	HOW TO REWRITE THE FLASH ROMS FOR VARIOUS MICROCOMPUTERS.....	230
7.1.11	DISASSEMBLY .....	233
7.1.12	FAILURE DIAGNOSIS OF THE POWER AMP BLOCK .....	242
7.2	PARTS .....	243
7.2.1	IC.....	243
8.	PANEL FACILITIES .....	275

A  
B  
C  
D  
E  
F

# 1. SPECIFICATIONS

## Specifications

### Amplifier section

**Continuous average power output of 140 (or 130) watts\* per channel, min., at 8 ohms, from 20 Hz to 20,000 Hz with no more than 0.09%\*\* total harmonic distortion (front).**

Continuous Power Output (20Hz-20kHz, 8Ω, 0.09%)

Front . . . . . 130 W + 130 W (72TXV)  
140 W + 140 W (74TXVi)  
Center . . . . . 130 W (72TXV), 140 W (74TXVi)  
Surround . . . . . 130 W + 130 W (72TXV)  
140 W + 140 W (74TXVi)

Surround back . . . . . 130 W + 130 W (72TXV)  
140 W + 140 W (74TXVi)

Continuous Power Output (1 kHz, 6 Ω, 1.0%)

Front . . . . . 160 W + 160 W (72TXV)  
180 W + 180 W (74TXVi)  
Center . . . . . 160 W (72TXV), 180 W (74TXVi)  
Surround . . . . . 160 W + 160 W (72TXV)  
180 W + 180 W (74TXVi)

Surround back . . . . . 160 W + 160 W (72TXV)  
180 W + 180 W (74TXVi)

Total harmonic distortion . . . . . 0.05%  
(20 Hz-20 kHz, 120 W, 8 Ω) (72TXV)  
(20 Hz-20 kHz, 130 W, 8 Ω) (74TXVi)

### Audio Section

Input (Sensitivity/Impedance)  
LINE . . . . . 335 mV/47 kΩ

Frequency Response (LINE) . . . . .  
5 Hz to 100,000 Hz  $\pm 3$  dB

Output (Level/Impedance)  
REC . . . . . 335 mV/2.2 kΩ

Tone Control  
BASS . . . . .  $\pm 6$  dB (100 Hz)  
TREBLE . . . . .  $\pm 6$  dB (10 kHz)  
LOUDNESS . . . . . +4/+2 dB (100Hz/10 kHz)  
(at volume position -40 dB)

Signal-to-Noise Ratio (IHF, short circuited, A network)  
LINE . . . . . 103 dB

Signal-to-Noise Ratio [EIA, at 1W (1kHz)]  
LINE . . . . . 83 dB

\* Measured pursuant to the Federal Trade Commission's Trade Regulation rule on Power Output Claims for Amplifiers

\*\* Measured by Audio Spectrum Analyzer

### Composite Video / S-Video Section

Input (Sensitivity/Impedance) . . . . . 1 Vp-p/75 Ω  
Output (Level/Impedance) . . . . . 1 Vp-p/75 Ω  
Signal-to-Noise Ratio . . . . . 65 dB  
Frequency Response . . . . . 5 Hz to 10 MHz

### Component Video Section

Input (Sensitivity/Impedance) . . . . . 1 Vp-p/75 Ω  
Output (Level/Impedance) . . . . . 1 Vp-p/75 Ω  
Signal-to-Noise Ratio . . . . . 65 dB

Frequency Response . . . . . 5 Hz to 100 MHz

### FM Tuner Section

Frequency Range . . . . . 87.5 MHz to 108 MHz  
Usable Sensitivity . . . . .

Mono: 13.2 dBf, IHF (1.3 μV/75 Ω)

50 dB Quieting Sensitivity . . . . . Mono: 20.2 dBf  
Stereo: 38.6 dBf

Signal-to-Noise Ratio . . . . . Mono: 73 dB (at 85 dBf)  
Stereo: 70 dB (at 85 dBf)

Distortion . . . . . Stereo: 0.5% (1 kHz)

Alternate Channel Selectivity . . . . . 60 dB (400 kHz)

Stereo Separation . . . . . 40 dB (1 kHz)

Frequency Response . . . . . 30 Hz to 15 kHz  $\pm 1$  dB

Antenna Input . . . . . 75 Ω unbalanced

### AM Tuner Section

Frequency Range . . . . . 530 kHz to 1,700 kHz

Sensitivity (IHF, Loop antenna) . . . . . 350 μV/m

Selectivity . . . . . 25 dB

Signal-to-Noise Ratio . . . . . 50 dB

Antenna . . . . . Loop antenna

### Miscellaneous

Power Requirements . . . . . AC 120 V, 60 Hz

Power Consumption . . . . . 530 W, 690 VA

In standby . . . . . Less than 0.6 W

AC Outlet . . . . . (switched) 100 W MAX.

Dimensions . . . . . 420 (W) x 187 (H) x 462 (D) mm

(16<sup>9</sup>/<sub>16</sub> (W) x 7<sup>3</sup>/<sub>8</sub> (H) x 18<sup>1</sup>/<sub>4</sub> (D) in.)

Weight (without package) . . . . .

16.0 kg (35.3 lb) (74TXVi)

15.9 kg (35.1 lb) (72TXV)

### Furnished Parts

Setup microphone (for Auto MCACC setup) . . . . . 1

AA/IEC R6P dry cell batteries . . . . . 2

Remote control unit . . . . . 1

AM loop antenna . . . . . 1

FM wire antenna . . . . . 1

Audio control cable for iPod . . . . . 1

Warranty card . . . . . 1

Operating instructions

### Note

- Specifications and the design are subject to possible modifications without notice, due to improvements.

### Cleaning the unit

- Use a polishing cloth or dry cloth to wipe off dust and dirt.
- When the surface is dirty, wipe with a soft cloth dipped in some neutral cleanser diluted five or six times with water, and wrung out well, and again with a dry cloth. Do not use furniture wax or then wipe cleansers.
- Never use thinners, benzine, insecticide sprays or other chemicals on or near this unit, since these will corrode the surface.

# ● Accessories



AM Loop Antenna  
(ATB7013)

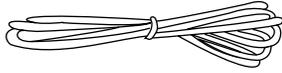

FM Wire Antenna  
(ADH7030)

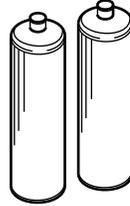

AA/IEC R6P Dry Cell Batteries



Remote Control Unit  
(AXD7409)

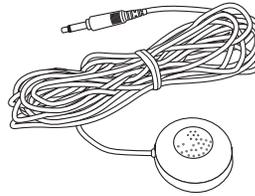

Setup Microphone  
(for Auto MCACC setup)  
(APM7006)

A  
B  
C  
D  
E  
F

# 2. EXPLODED VIEWS AND PARTS LIST

- NOTES:
- Parts marked by "NSP" are generally unavailable because they are not in our Master Spare Parts List.
  - The  mark found on some component parts indicates the importance of the safety factor of the part. Therefore, when replacing, be sure to use parts of identical designation.
  - Screws adjacent to  mark on product are used for disassembly.
  - For the applying amount of lubricants or glue, follow the instructions in this manual. (In the case of no amount instructions, apply as you think it appropriate.)

## 2.1 PACKING

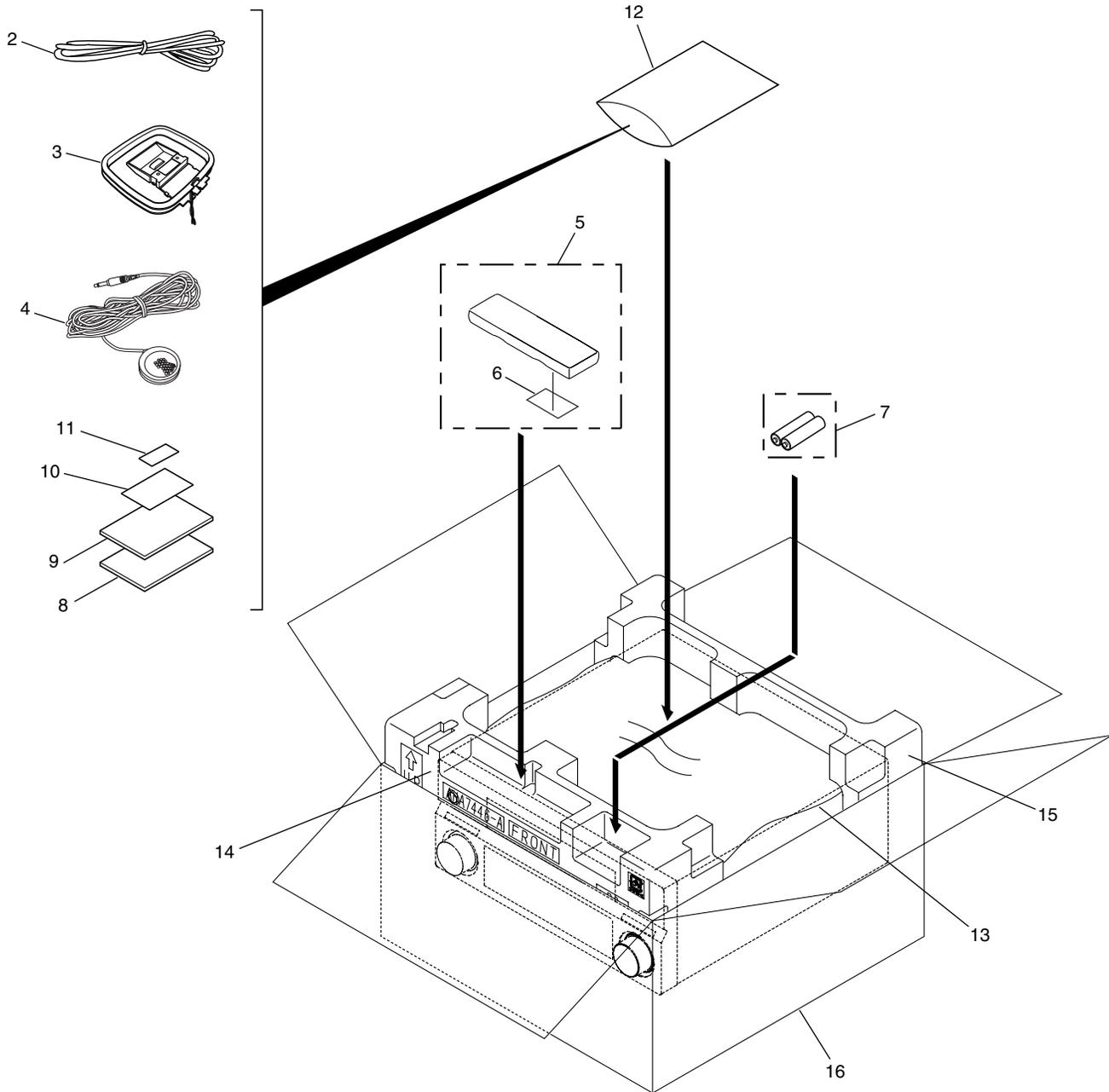



**(1) PACKING SECTION PARTS LIST**

<u>Mark No.</u>	<u>Description</u>	<u>Part No.</u>
1	Audio Control Cable for iPod	ADE7119
2	FM Wire Antenna	ADH7030
3	AM Loop Antenna	ATB7013
4	Setup Microphone (for Auto MCACC setup)	APM7006
5	Remote Control Unit	AXD7409
6	Battery Cover	XZN3140
NSP 7	AA/IEC R6P Dry Cell Batteries	VEM1031
8	Operating Instructions (English)	ARB7334
9	Operating Instructions	ARE7600
10	Caution Sheet SP, E	ARM7056
NSP 11	Warranty Card	ARY7007
NSP 12	Polyethylene Bag	AHG7117
13	Packing Sheet	RHC1023
14	Front Pad 74	AHA7446
15	Rear Pad 74	AHA7447
16	Packing Case	See Contrast table (2)

**(2) CONTRAST TABLE**

VSX-74TXVi/KUXJ/CA, VSX-74TXVi-S/KUXJC, VSX-72TXV/KUXJ/CA and VSX-72TXV-S/KUXJC are constructed the same except for the following:

Mark	No.	Symbol and Description	VSX-74TXVi /KUXJ/CA	VSX-74TXVi-S /KUXJC	VSX-72TXV /KUXJ/CA	VSX-72TXV-S /KUXJC
	16	Packing Case	AHD8345	AHD8396	AHD8346	AHD8397

# 2.2 EXTERIOR

1

2

3

4

A

B

C

D

E

F

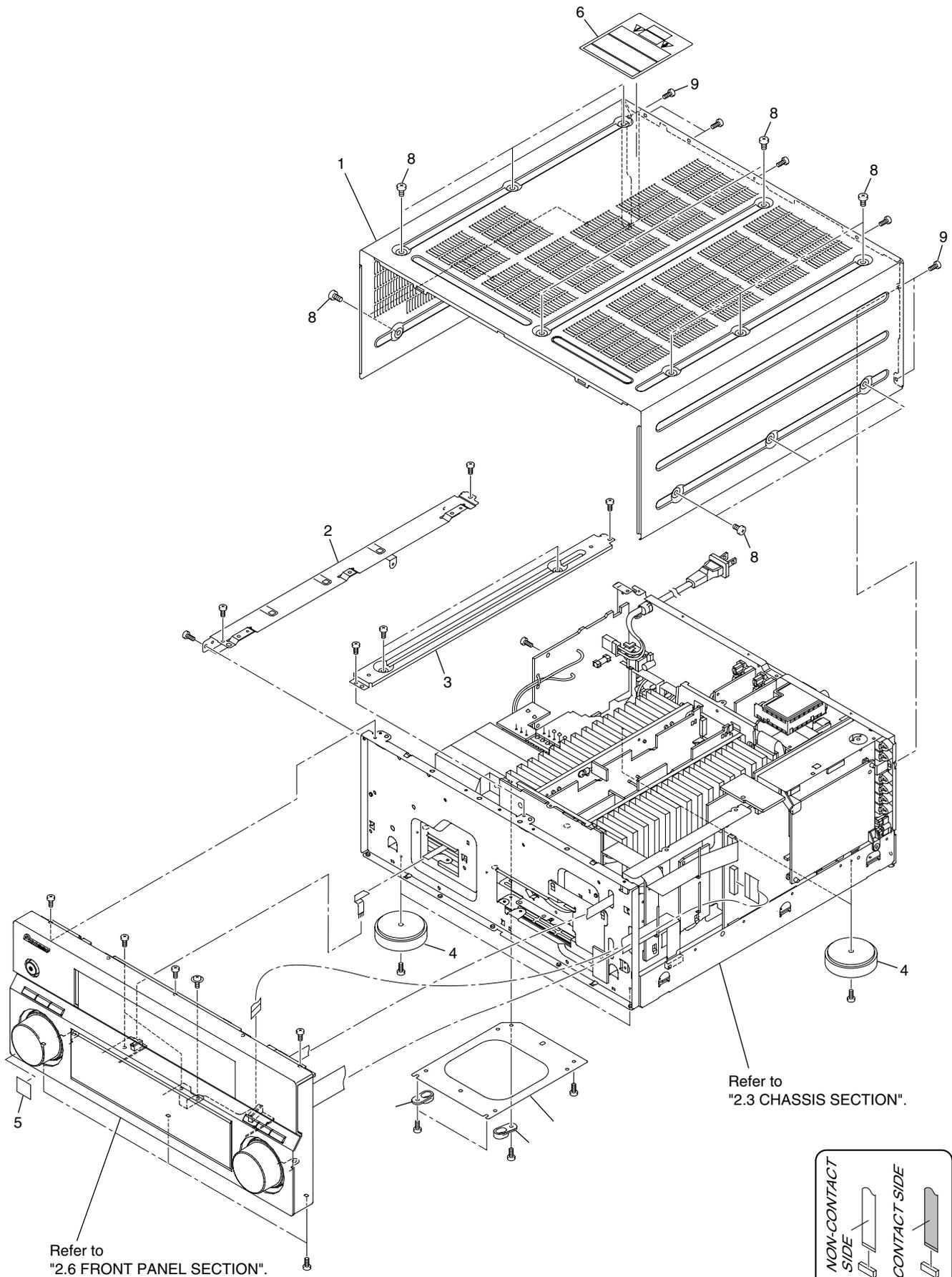

Refer to "2.3 CHASSIS SECTION".

Refer to "2.6 FRONT PANEL SECTION".

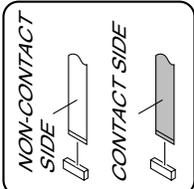

1

2

3

4

**(1) EXTERIOR SECTION PARTS LIST**

<u>Mark No.</u>	<u>Description</u>	<u>Part No.</u>
1	Bonnet	See Contrast table (2)
2	Left Beam 45	ANG7401
3	Center Beam V1	ANG7482
4	Insulator	AMR7198
NSP 5	Energy Star Label	AAX8022
6	Label (DD/DTS/THX)	ARW7320
7	iPod Label	ARW7326
8	Screw	See Contrast table (2)
9	Screw	See Contrast table (2)

**(2) CONTRAST TABLE**

VSX-74TXVi/KUXJ/CA, VSX-74TXVi-S/KUXJC, VSX-72TXV/KUXJ/CA and VSX-72TXV-S/KUXJC are constructed the same except for the following:

<b>Mark</b>	<b>No.</b>	<b>Symbol and Description</b>	<b>VSX-74TXVi /KUXJ/CA</b>	<b>VSX-74TXVi-S /KUXJC</b>	<b>VSX-72TXV /KUXJ/CA</b>	<b>VSX-72TXV-S /KUXJC</b>
	1	Bonnet 74B	AZN8006	Not used	AZN8006	Not used
	1	Bonnet AX4S	Not used	AZN8008	Not used	AZN8008
	8	Screw	BCZ40P060FTB	BCZ40P060FNI	BCZ40P060FTB	BCZ40P060FNI
	9	Screw	BBZ30P080FTB	BBZ30P080FNI	BBZ30P080FTB	BBZ30P080FNI

# 2.3 CHASSIS SECTION

A  
B  
C  
D  
E  
F

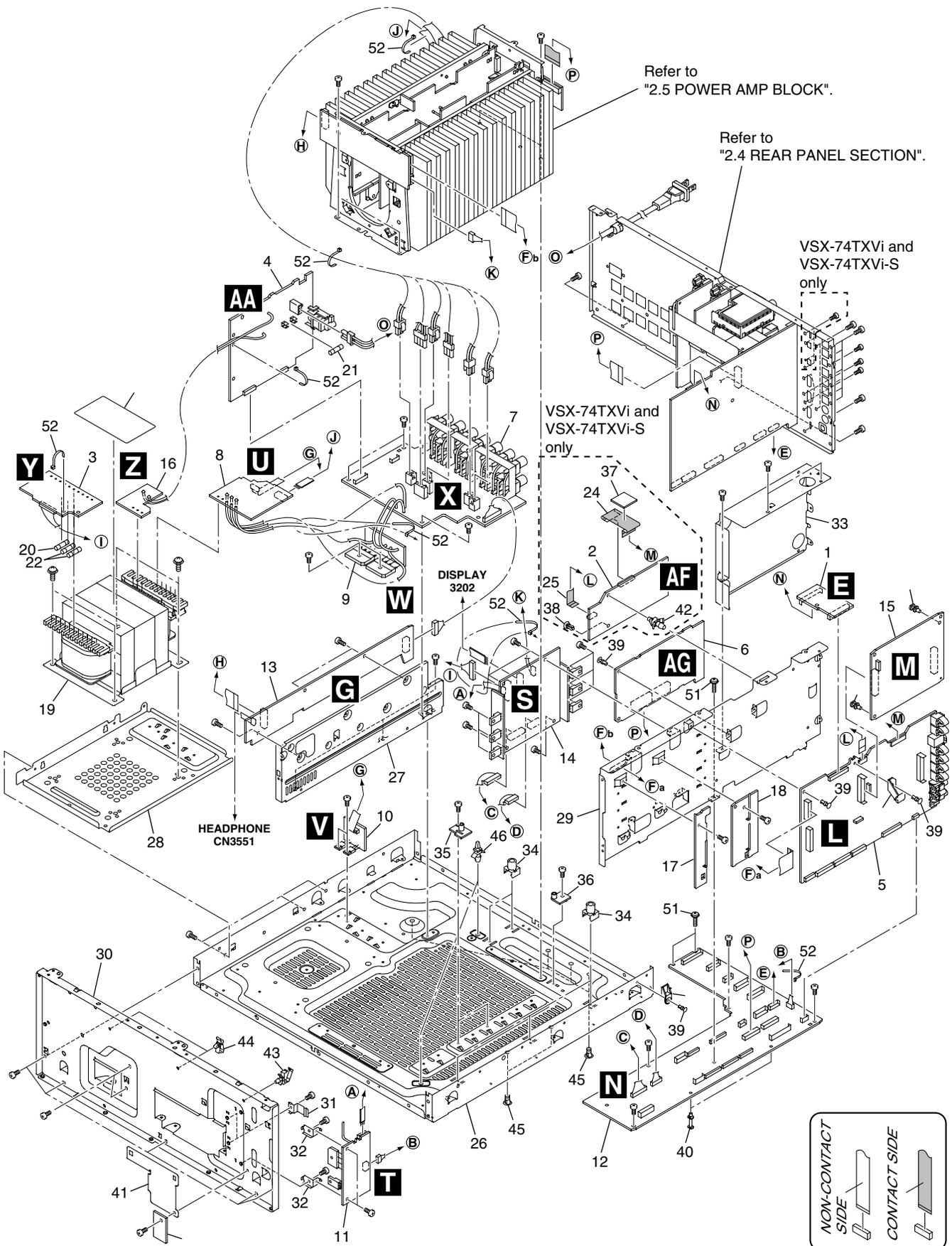

**(1) CHASSIS SECTION PARTS LIST**

<u>Mark No.</u>	<u>Description</u>	<u>Part No.</u>	<u>Mark No.</u>	<u>Description</u>	<u>Part No.</u>
NSP 1	BRIDGE 1 Assy	AWX8667	NSP 31	Transistor Holder	ANG7543
2	1394 Assy	See Contrast table (2)	NSP 32	DC Assy Holder	ANG7544
3	TRANS 2-2 Assy	AWX8626	NSP 33	HDMI Shield	ANK7124
4	PRIMARY Assy	AWX8628	34	PCB Mold	AMR2534
5	DIGITAL MOTHER Assy	See Contrast table (2)	35	Inter Holder A	AMR7500
6	HDMI & DVC Assy	AWQ7024	36	Inter Holder B	AMR7501
7	SP/PS Assy	See Contrast table (2)	37	Shield Cushion	See Contrast table (2)
8	TRANS 2-1 Assy	AWX8646	38	Nyron Rivet	See Contrast table (2)
NSP 9	DIODE Assy	AWX8648	39	Nyron Rivet	AEC7408
10	VH TR Assy	AWX8649	40	Card Spacer	AEC7502
11	DC/DC Assy	AWX8650	NSP 41	FR IN Barrier	AEC7538
12	INTERFACE Assy	AWX8651	42	Locking Card Spacer	See Contrast table (2)
NSP 13	TRANS SIDE Assy	AWX8652	43	Locking Wire Saddle	AEC7550
14	LOCAL SUPPLY Assy	AWX8671	44	Side Clamp	DEC2007
15	DSP Assy	AWX8599	45	Card Spacer	DNK2769
16	TRANS 1 Assy	.....	46	Locking Card Spacer	PNW2917
NSP 17	FFC Guard (Front) Assy	AWX8634	47	.....	
NSP 18	FFC Guard (Side) Assy	AWX8696	48	.....	
⚠ 19	Power Transformer (T1501)	ATS7402	49	.....	
⚠ 20	Fuse (FU4 : 5A/125V)	REK1067	50	.....	
⚠ 21	Fuse (FU1 : 10A/125V)	REK1087	51	Screw 3 x 15	ABA7100
⚠ 22	Fuse (FU5, 6 : 1.25A/125V)	REK1108	NSP 52	Binder (BK-1)	ZCA-BK1
⚠ 23	Fuse (FU7, 8 : 2.5A/125V)	REK1112			
24	22P Flexible Cable (J52)	See Contrast table (2)			
25	10P Flexible Cable (J53)	See Contrast table (2)			
NSP 26	Under Base 72	ANA7182			
27	Under Beam V1	ANG7478			
NSP 28	Trans. Frame 74	ANG7539			
NSP 29	DSP Shield 74	ANG7540			
NSP 30	Panel Stay 74	ANG7541			

**(2) CONTRAST TABLE**

VSX-74TXVi/KUXJ/CA, VSX-74TXVi-S/KUXJC, VSX-72TXV/KUXJ/CA and VSX-72TXV-S/KUXJC are constructed the same except for the following:

Mark	No.	Symbol and Description	VSX-74TXVi /KUXJ/CA	VSX-74TXVi-S /KUXJC	VSX-72TXV /KUXJ/CA	VSX-72TXV-S /KUXJC
	2	1394 Assy	AWK7882	AWK7882	Not used	Not used
	5	DIGITAL MOTHER Assy	AWP7037	AWP7037	AWP7041	AWP7041
	7	SP/PS Assy	AWX8642	AWX8642	AWX8644	AWX8644
	24	22P Flexible Cable (J52)	ADD7517	ADD7517	Not used	Not used
	25	10P Flexible Cable (J53)	ADD7518	ADD7518	Not used	Not used
	37	Shield Cushion	AEB7372	AEB7372	Not used	Not used
	38	Nyron Rivet	AEC7406	AEC7406	Not used	Not used
	42	Locking Card Spacer	AEC7549	AEC7549	Not used	Not used

# 2.4 REAR PANEL SECTION

1

2

3

4

A

B

C

D

E

F

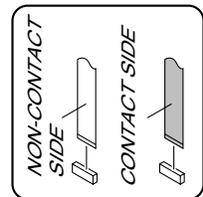
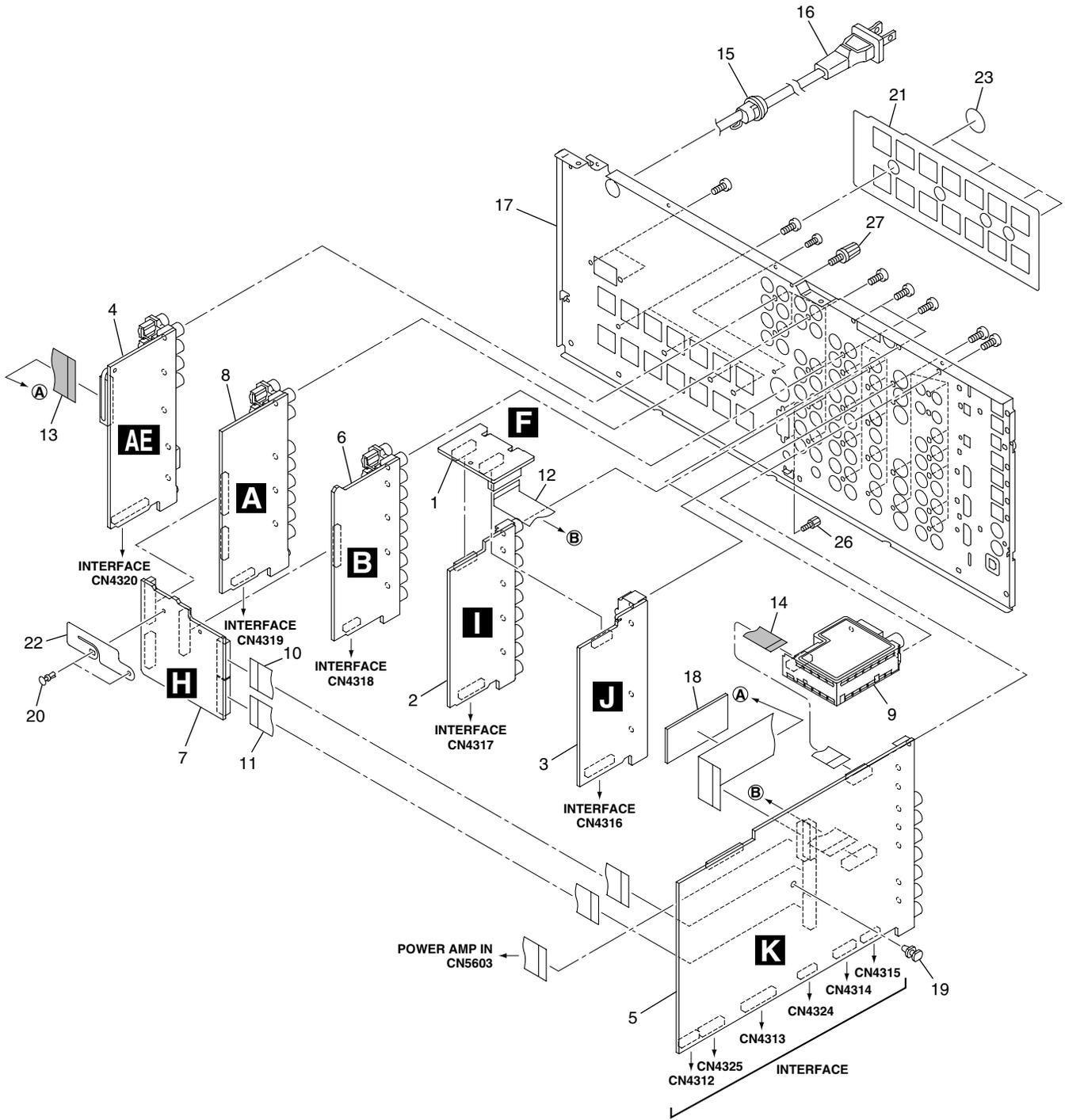

1

2

3

4

**(1) REAR PANEL SECTION PARTS LIST**

<u>Mark No.</u>	<u>Description</u>	<u>Part No.</u>
NSP 1	BRIDGE 2 Assy	AWX8668
2	COMPOSITE V Assy	AWX8620
3	S VIDEO Assy	AWX8622
4	PREOUT & CONTROL Assy	AWX8625
5	COMPONENT & VOL Assy	See Contrast table (2)
6	V-AUDIO Assy	AWX8637
NSP 7	BRIDGE 3 Assy	AWX8669
8	AUDIO & MULTI CH IN Assy	AWX8674
9	FM/AM TUNER Unit	AXX7172
10	19P Flexible Cable (J45)	ADD7511
11	17P Flexible Cable (J46)	ADD7512
12	17P Flexible Cable (J47)	ADD7513
13	26P Flexible Cable (J48)	ADD7514
14	11P Flexible Cable (J54)	ADD7519
15	Cord Stopper	CM-22C
⚠ 16	Power Cord	VDG1075
17	Rear Panel	See Contrast table (2)
18	FFC Cushion	AEB7373
NSP 19	PCB Spacer (3 x 6)	AEC7156
20	Nyron Rivet	AEC7408
21	SP Sheet 74	AEC7537
NSP 22	Connect Barrier	AEC7541
23	Cushion Circle 16B	AED7052
24	•••••	
25	•••••	
26	Screw 2.85 x 7	ABA7078
27	Terminal Screw	AKE-031

**(2) CONTRAST TABLE**

VSX-74TXVi/KUXJ/CA, VSX-74TXVi-S/KUXJC, VSX-72TXV/KUXJ/CA and VSX-72TXV-S/KUXJC are constructed the same except for the following:

Mark	No.	Symbol and Description	VSX-74TXVi /KUXJ/CA	VSX-74TXVi-S /KUXJC	VSX-72TXV /KUXJ/CA	VSX-72TXV-S /KUXJC
	5	COMPONENT & VOL Assy	AWQ7028	AWQ7028	AWQ7030	AWQ7030
	17	Rear Panel 74KU	ANC8324	Not used	Not used	Not used
	17	Rear Panel 74SKU	Not used	ANC8366	Not used	Not used
	17	Rear Panel 72KU	Not used	Not used	ANC8325	Not used
	17	Rear Panel 72SKU	Not used	Not used	Not used	ANC8367

# 2.5 POWER AMP BLOCK

1

2

3

4

A

B

C

D

E

F

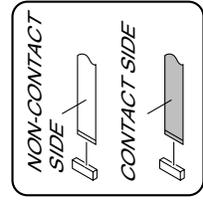
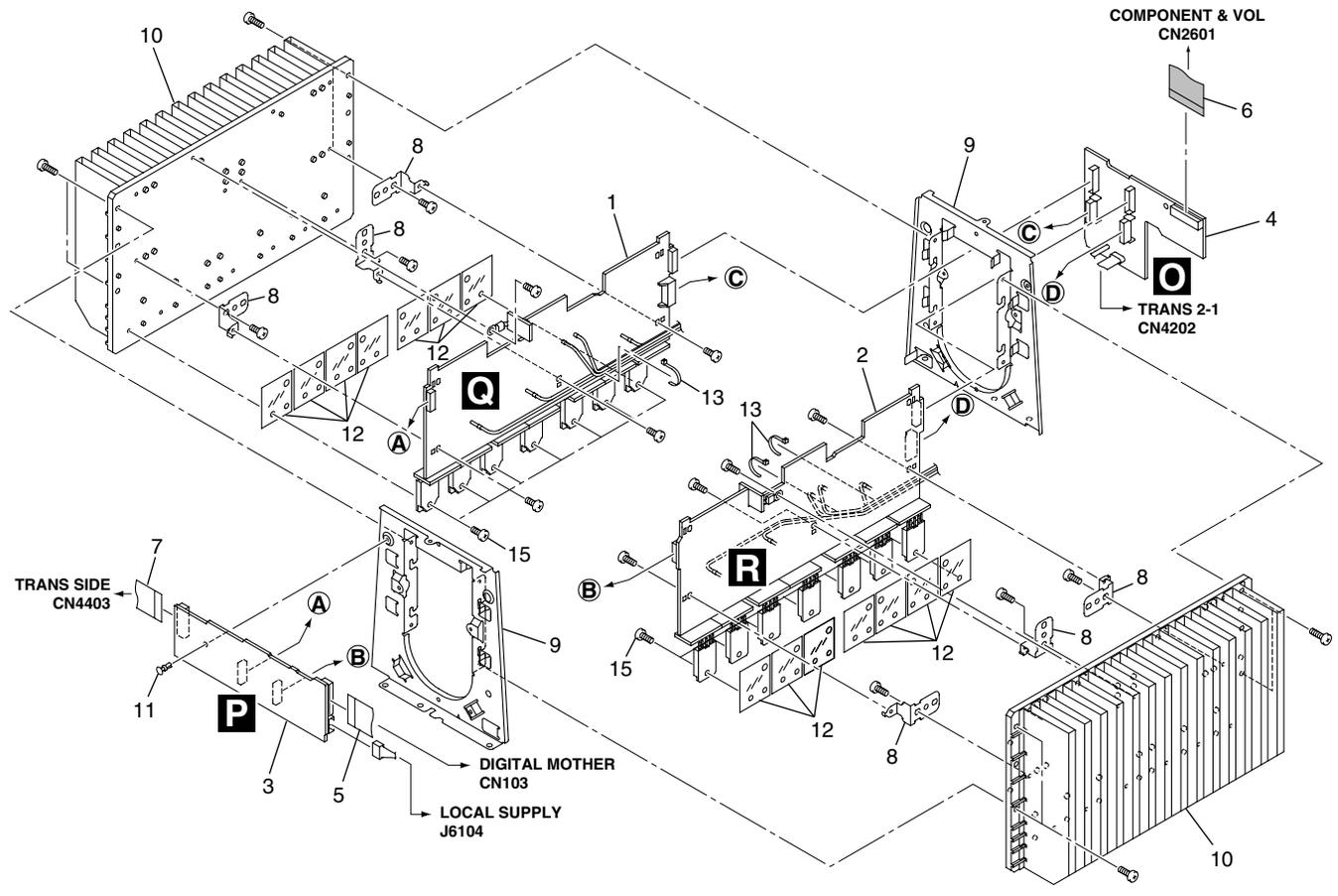

1

2

3

4





# 2.6 FRONT PANEL SECTION

A  
B  
C  
D  
E  
F

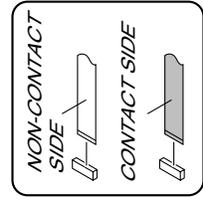
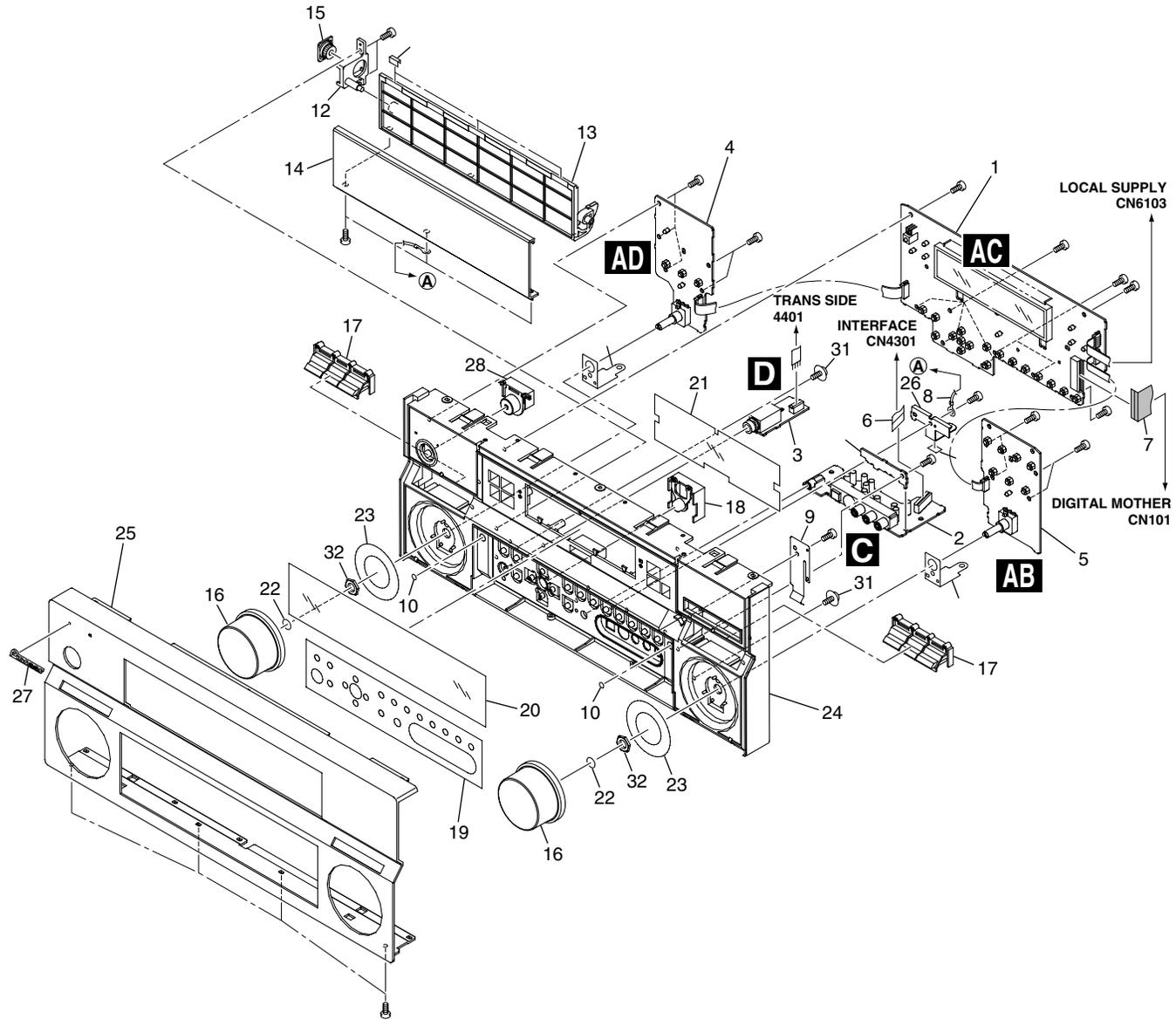

**(1) FRONT PANEL SECTION PARTS LIST**

<u>Mark No.</u>	<u>Description</u>	<u>Part No.</u>	<u>Mark No.</u>	<u>Description</u>	<u>Part No.</u>
1	DISPLAY Assy	See Contrast table (2)	18	ENTER Button	See Contrast table (2)
2	FRONT-IN Assy	AWX8638	19	Door Sheet	See Contrast table (2)
3	HEADPHONE Assy	AWX8639	20	Window	See Contrast table (2)
4	INPUT SELECT Assy	AWX8640			
5	VOLUME Assy	AWX8641	21	Filter	See Contrast table (2)
			22	Ring	ABH7213
6	15P Flexible Cable (J41)	ADD7507	23	Knob Spacer V1	AEC7519
7	23P Flexible Cable (J42)	ADD7508	24	Panel Base	See Contrast table (2)
NSP 8	Cord with Plug	ADH7022	25	Front Panel	See Contrast table (2)
9	Door Spring	ABK7061			
10	Cushion Circle	See Contrast table (2)	26	Earth Plate A	ANG7484
			27	Name Plate	See Contrast table (2)
11	Cushion 11 x 7	AED7092	28	STBY BTN Assy	See Contrast table (2)
12	Door Shaft 35	AMR7295	29	•••••	
13	Door Base	See Contrast table (2)	30	•••••	
14	Door Panel	See Contrast table (2)			
15	Damper Assy (200)	AXA7088	31	Screw	ABA7110
			32	Nut	NK90FCU
16	Rotary Knob	See Contrast table (2)			
17	Hinge Button	See Contrast table (2)			

**(2) CONTRAST TABLE**

VSX-74TXVi/KUXJ/CA, VSX-74TXVi-S/KUXJC, VSX-72TXV/KUXJ/CA and VSX-72TXV-S/KUXJC are constructed the same except for the following:

<u>Mark</u>	<u>No.</u>	<u>Symbol and Description</u>	<u>VSX-74TXVi /KUXJ/CA</u>	<u>VSX-74TXVi-S /KUXJC</u>	<u>VSX-72TXV /KUXJ/CA</u>	<u>VSX-72TXV-S /KUXJC</u>
	1	DISPLAY Assy	AWX8635	AWX8635	AWX8636	AWX8636
	10	Cushion Circle 6B	AED7083	Not used	AED7083	Not used
	10	Cushion Circle 6S	Not used	AED7080	Not used	AED7080
	13	Door Base BK	AMR7508	Not used	AMR7508	Not used
	13	Door Base S	Not used	AMR7510	Not used	AMR7510
	14	Door Panel 74	ANB7369	Not used	ANB7369	Not used
	14	Door Panel 74S	Not used	ANB7391	Not used	ANB7391
	16	Rotary Knob BK	AAA7031	Not used	AAA7031	Not used
	16	Rotary Knob S	Not used	AAA7025	Not used	AAA7025
	17	Hinge Button 74BK	AAD7744	Not used	AAD7744	Not used
	17	Hinge Button AX4S	Not used	AAD7746	Not used	AAD7746
	18	ENTER Button 74BK	AAD7747	Not used	AAD7747	Not used
	18	ENTER Button AX4S	Not used	AAD7749	Not used	AAD7749
	19	Door Sheet 74	AAK8291	Not used	AAK8291	Not used
	19	Door Sheet AX4HY	Not used	AAK8293	Not used	AAK8293
	20	Window 74	AAK8296	Not used	Not used	Not used
	20	Window 74S	Not used	AAK8317	Not used	Not used
	20	Window 72	Not used	Not used	AAK8297	Not used
	20	Window 72S	Not used	Not used	Not used	AAK8318
	21	Filter 74	AAK8308	Not used	AAK8308	Not used
	21	Filter 74S	Not used	AAK8311	Not used	AAK8311
	24	Panel Base 74BK	AMB7900	Not used	AMB7900	Not used
	24	Panel Base 74S	Not used	AMB7907	Not used	AMB7907
	25	Front Panel 74	ANB7374	Not used	Not used	Not used
	25	Front Panel 74S	Not used	ANB7392	Not used	Not used
	25	Front Panel 72	Not used	Not used	ANB7375	Not used
	25	Front Panel 72S	Not used	Not used	Not used	ANB7393
	27	Name Plate B	PAN1376	Not used	PAN1376	Not used
	27	Name Plate	Not used	VAM1124	Not used	VAM1124
	28	STBY BTN 915K Assy	XAD3216	Not used	XAD3216	Not used
	28	STBY BTN 915P Assy	Not used	XAD3217	Not used	XAD3217



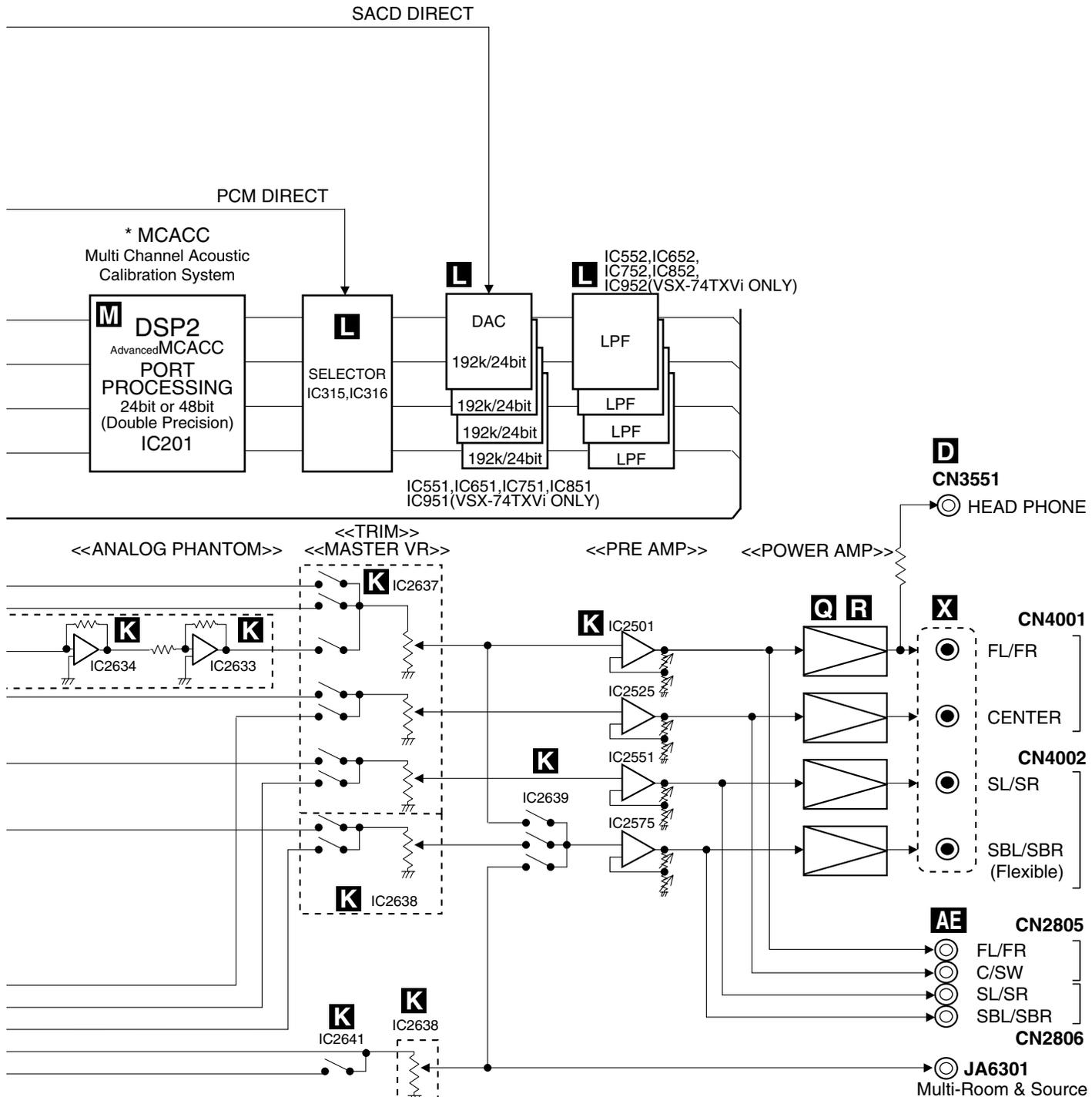

# 3.1.2 COMPOSITE V BLOCK DIAGRAM

A  
B  
C  
D  
E  
F

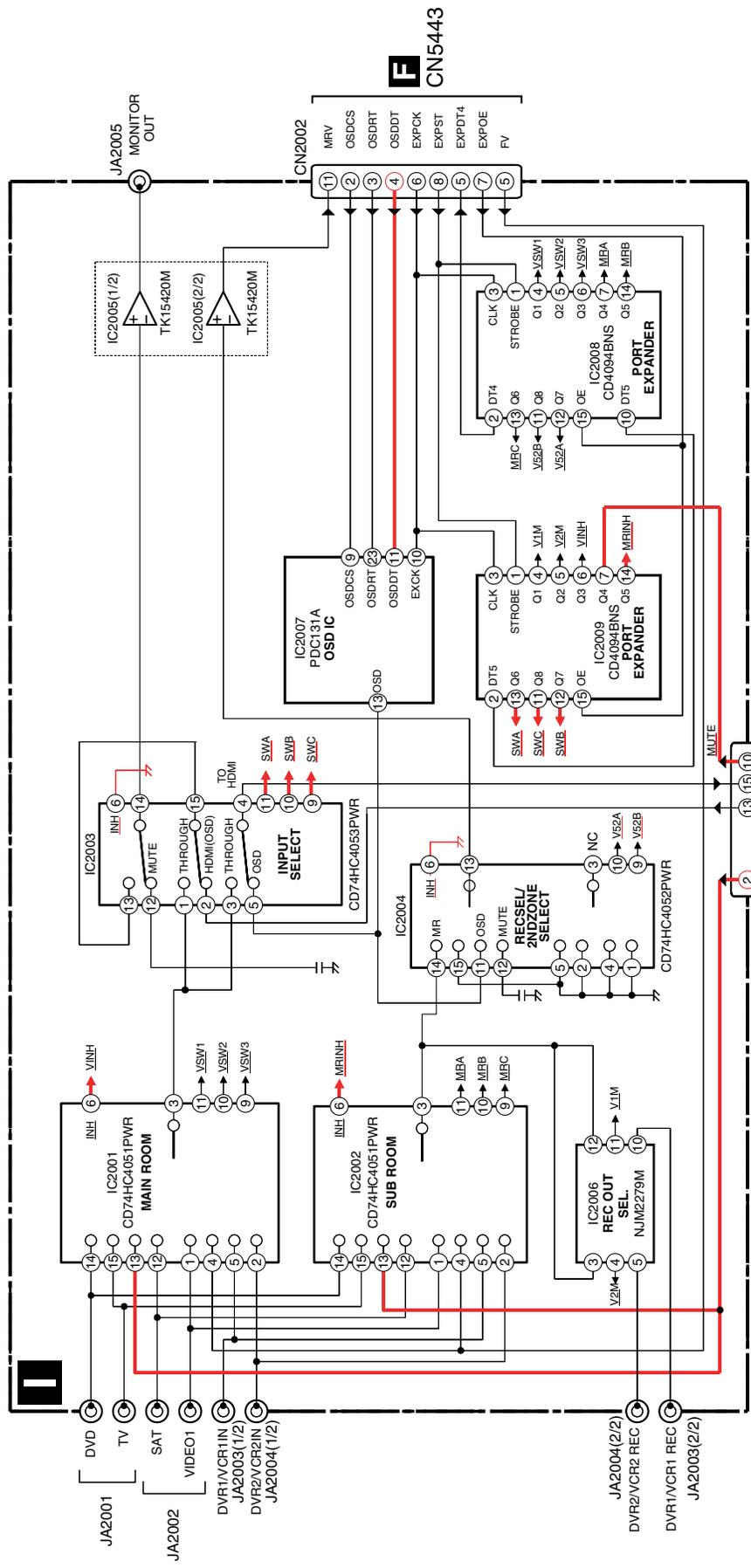

COMPOSITE V ASSY COMPOSITION IC DATA

- <CD4094BNS(EXPANDER IC2008)>
  - CONTROL U-COM PORT
  - EXPST:EXPCKEXPOE
  - INPUT DATA NAME:DT4
  - OUTPUT DATA NAME:DT5
  - EXPST:EXPCKEXPOE
  - O1:VSW1(O2:VSW2(O3:VSW3(O4:MRA
  - O5:MRB(O6:MRC(O7:V52A(O8:V52B
- IC2009
  - CONTROL U-COM PORT
  - EXPST:EXPCKEXPOE
  - INPUT DATA NAME:DT5
  - OUTPUT DATA NAME:DT4
  - EXPANDER PORT NAME
  - O1:V1M(O2:V2M(O3:VIN(O4:MUTE
  - O5:MRINH(O6:SWA(O7:SWB(O8:SWC
- <CD74HC4051PWR X1 (SW IC2001)>
  - USING EXPANDER PORT
  - VSW1:VSW2:VSW3:VINH
- <CD74HC4051PWR X1 (SW IC2002)>
  - USING EXPANDER PORT
  - MRA:MRB:MRC:MRINH
- <CD74HC4053PWR X1 (SW IC2003)>
  - USING EXPANDER PORT
  - SWA:SWB:SWC:VINH
- <CD74HC4052PWR X1 (SW IC2004)>
  - USING EXPANDER PORT
  - V52A:V52B:MRINH
- <NJM2279M (RECOUT SEL IC)>
  - USING EXPANDER PORT
  - V1M:V2M

### 3.1.3 S-VIDEO BLOCK DIAGRAM

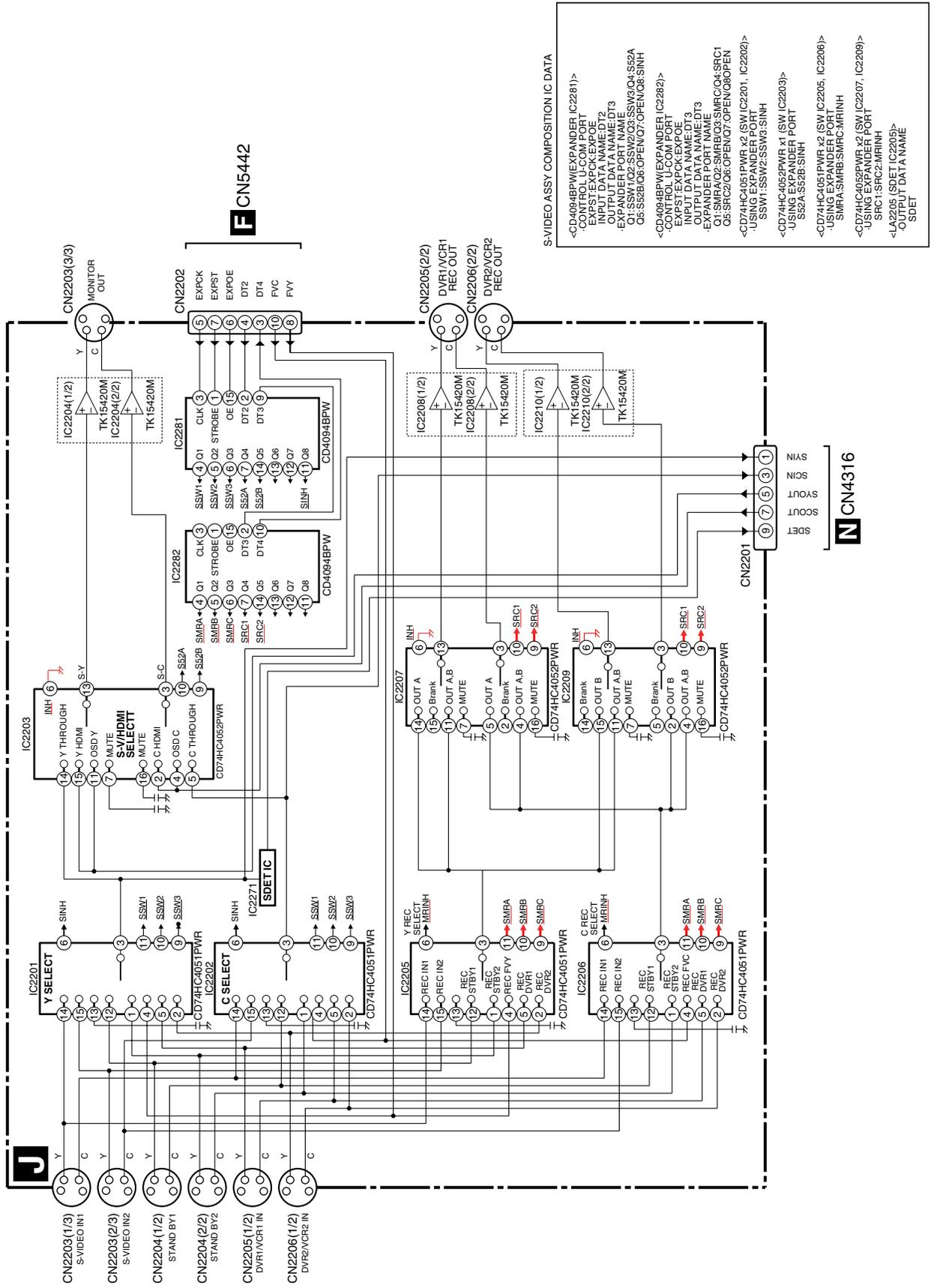

MRINH connect the signal line from the Port expander of COMPOSITE V ASSY.

# 3.1.4 COMPONENT & VOL BLOCK DIAGRAM

A  
B  
C  
D  
E  
F

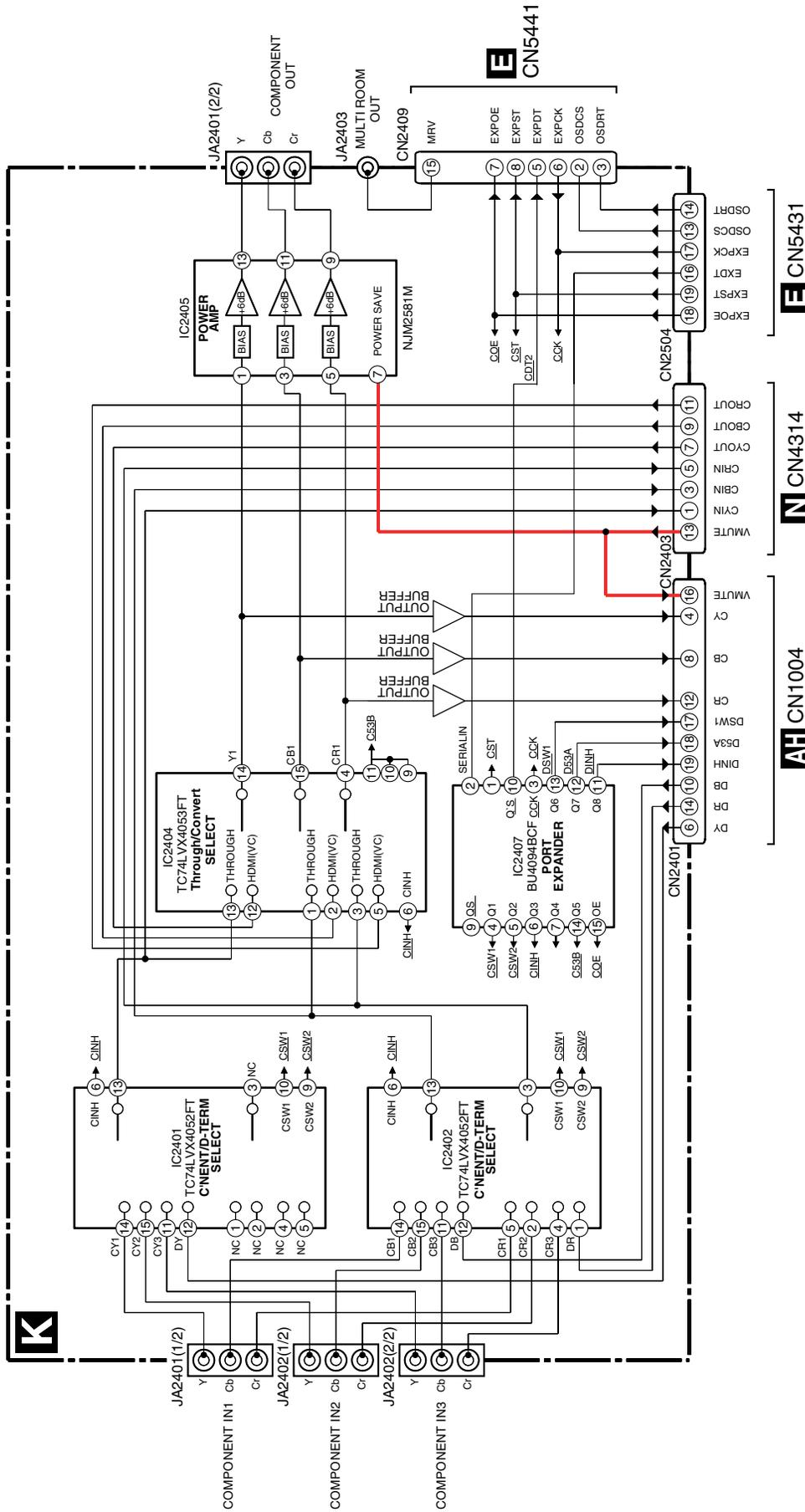

```

COMPONENT & VOL ASSY COMPOSITION IC DATA
<BU4094BCF>(EXPANDER IC2407)>
  -CONTROL U-COM PORT
  -EXPST EXPCK EXPDST
  -OUTPUT DATA NAME: DDT2
  -EXPANDER PORT NAME:
  Q1:CSW1/Q2:CSW2/Q3:CINH/Q4:XMSB
  Q5:CS3B/Q6:DSW1/Q7:D53A/Q8:DNH
  -NJM2581M x1 (V-AMP IC2405)>
  -CONTROL U-COM PORT
  -VMUTE
  <TC74LVX4052FT x2 (SW IC2401, IC2402)>
  -USING EXPANDER PORT
  -CSW1:CSW2:CINH
  <TC74LVX4053FT x1 (SW IC2404)>
  -USING EXPANDER PORT
  -C53B:CINH
  -NJM2581M x1 (V-AMP IC2405)>
  -CONTROL U-COM PORT
  -VMUTE
  
```



### 3.1.5 DSP BLOCK DIAGRAM

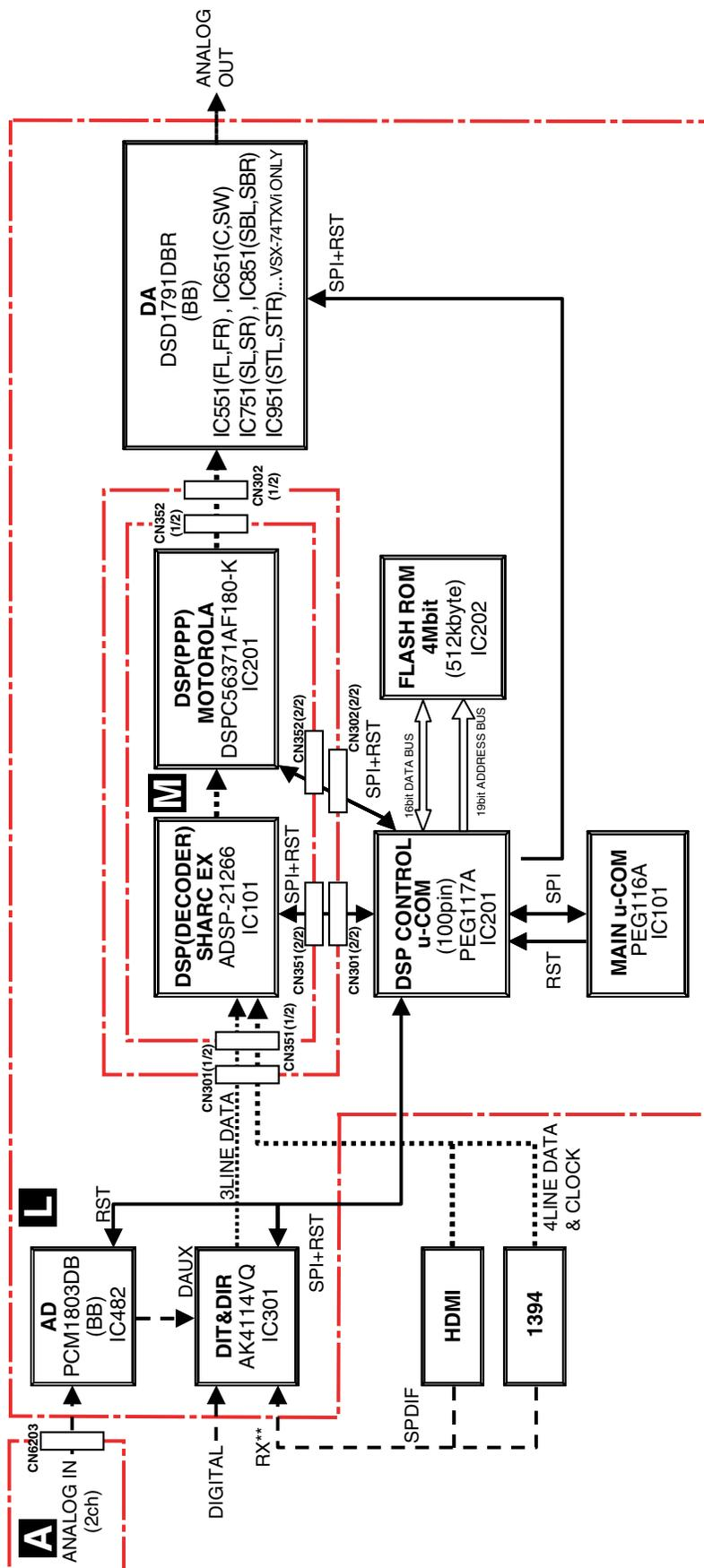

#### 1. Description of Device ICs

IC No	IC Name	Description of function
IC 482	A/D Converter	Converts signals from an analog source into digital signals.
IC 301	Digital Audio Interface Transceiver & Receiver	Selecting digital data.
IC 101	DSP	Decoder for compressed sound such as AC-3 and DTS.
IC 201	DSP	P Company's original processor such as SFC.
IC 201	DSP Microcomputer	Think of these two as a single microcomputer.
IC 202	FLASH ROM	Microcomputer programs are stored in the flash rom.
IC 551, 651, 751, 851, 951	D/A Converter	Converts digital signals into analog signals.

#### 2. Description of Abbreviated Names

Signal name	Formal signal name	Description of signals
SPI	SONY/Philips Digital Interface	Consumer format used for exchanging digital audio signals.
RST	RESET	Reset signal.
PPP	Post Processing Phase	Denotes DSP processing (P Company's original surround processing), which are executed at the latter part of a decoder area.

### 3.1.6 HDMI & DVC BLOCK DIAGRAM

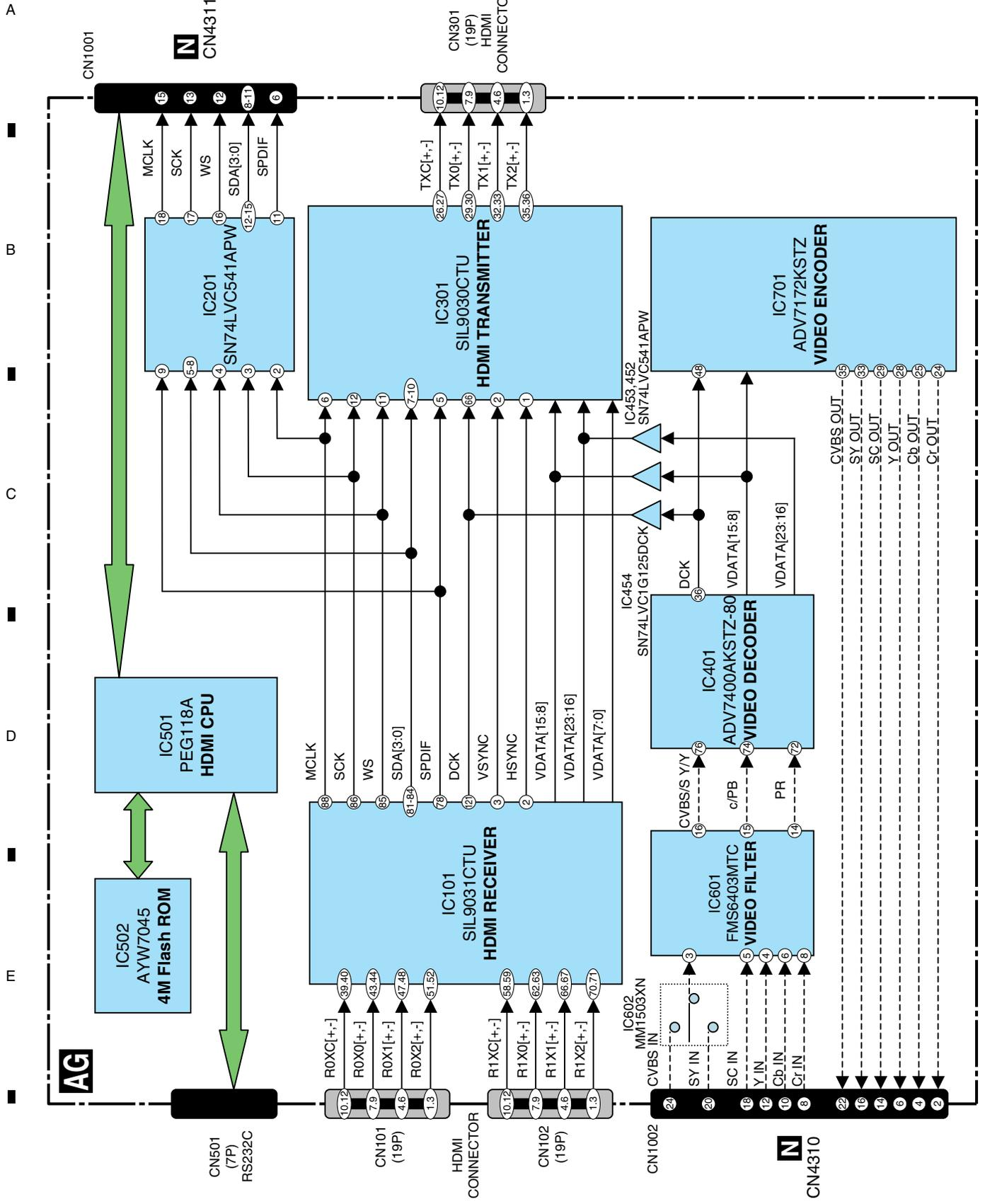

### 3.1.7 MICROCOMPUTER BLOCK DIAGRAM

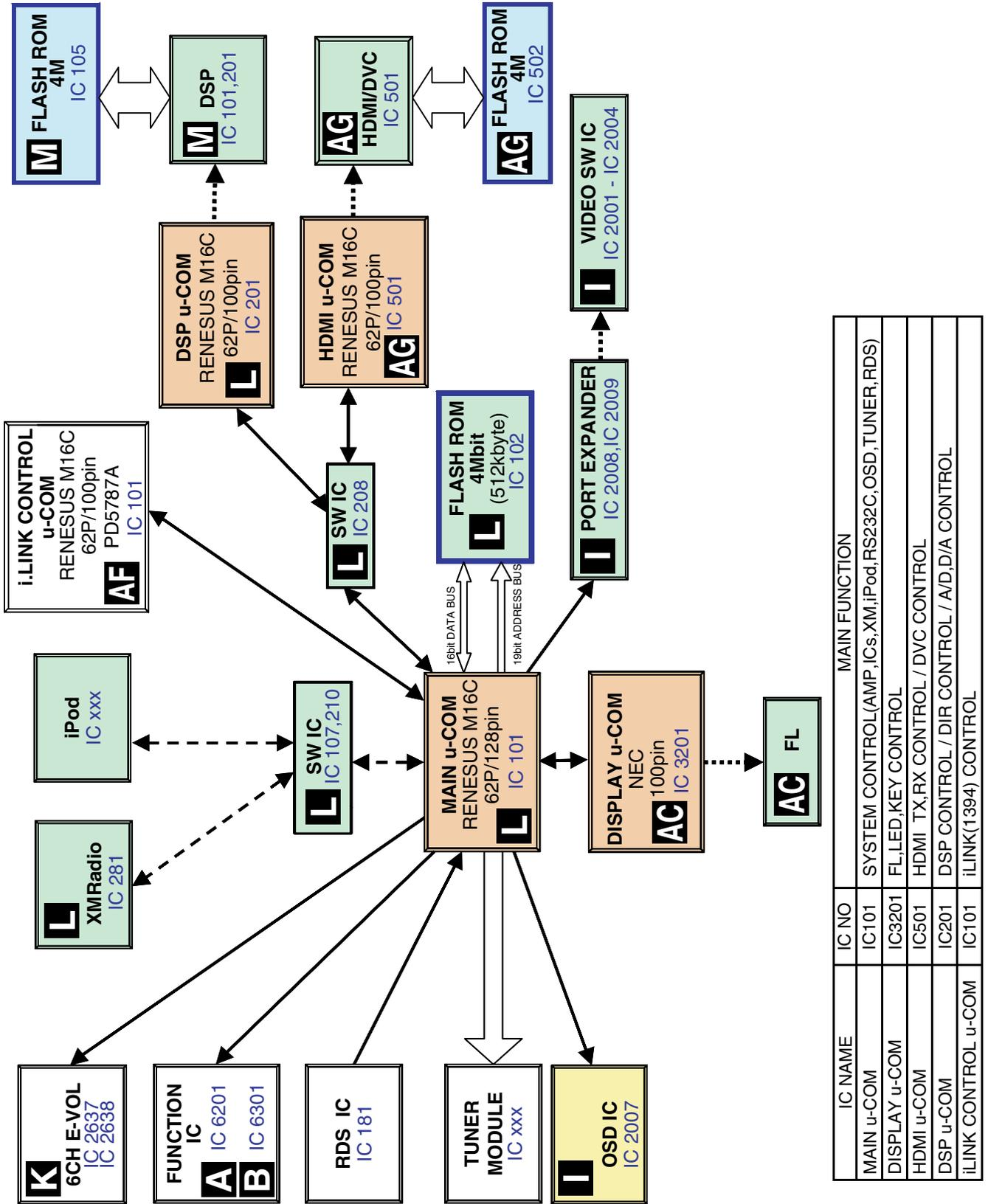

# 3.2 OVERALL WIRING CONNECTION DIAGRAM

The  $\Delta$  mark found on some component parts indicates the importance of the safety factor of the part. Therefore, when replacing, be sure to use parts of identical designation.

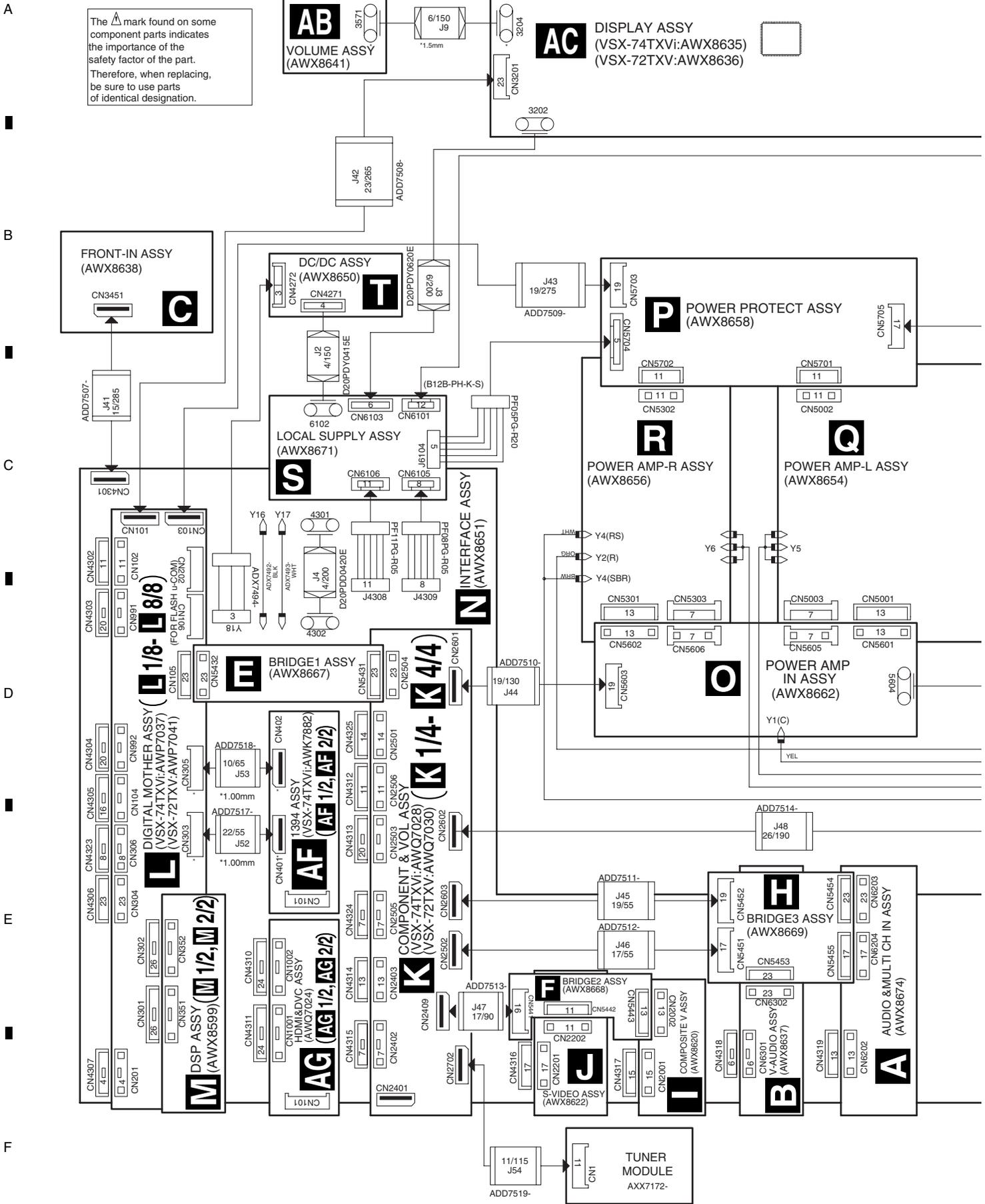

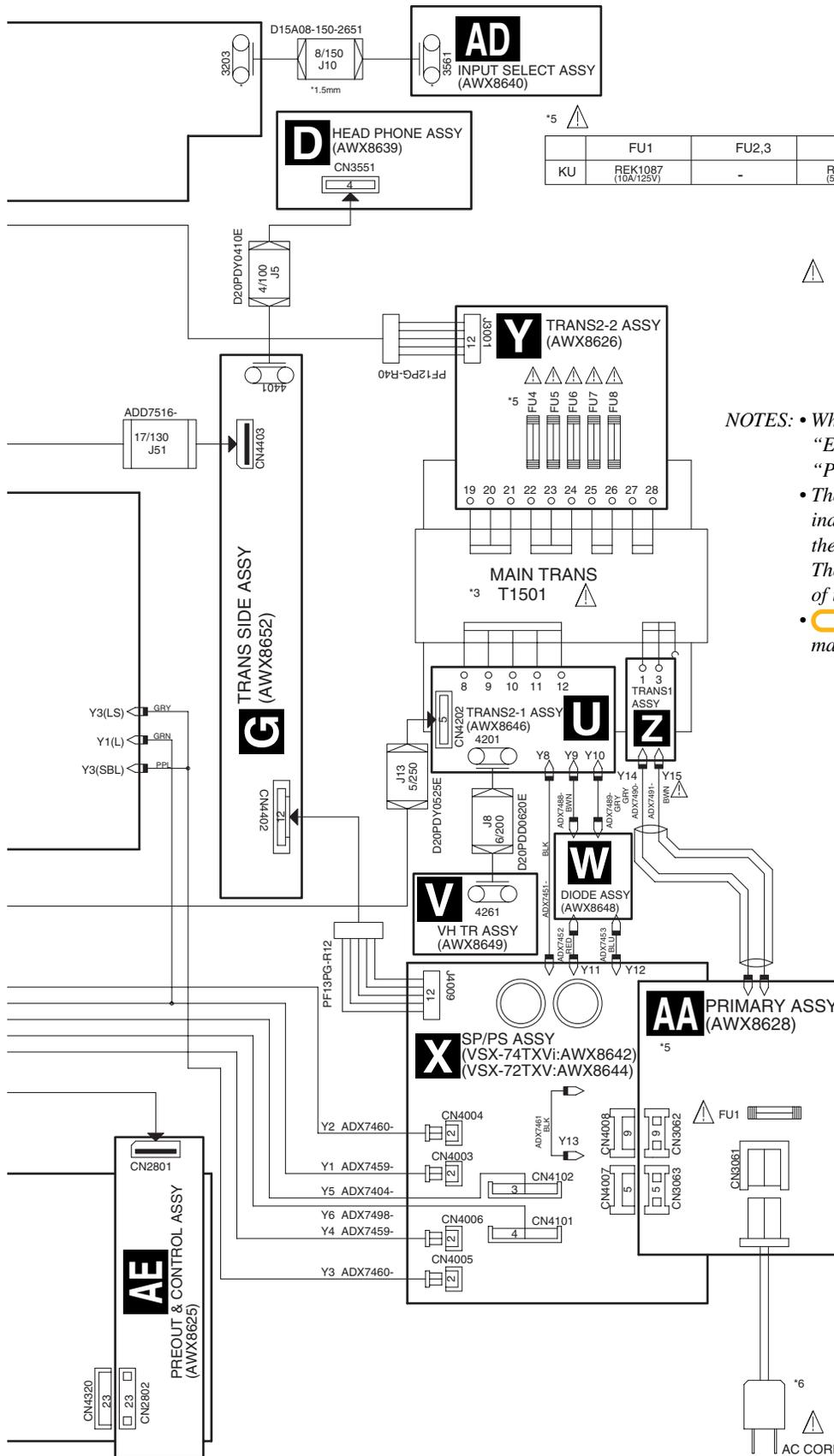

	FU1	FU2,3	FU4	FU5,6	FU7,8
KU	REK1087 (10A/125V)	-	REK1067 (5A/125V)	REK1108 (1.25A/125V)	REK1112 (2.5A/125V)

	*3 MAIN TRANS	*6 AC CORD
KU	ATS7402-	1905:VDG1075

**NOTES:**

- When ordering service parts, be sure to refer to "EXPLODED VIEWS and PARTS LIST" or "PCB PARTS LIST".
- The  $\Delta$  mark found on some component parts indicates the importance of the safety factor of the part. Therefore, when replacing, be sure to use parts of identical designation.
- : The power supply is shown with the marked box.

- BOARD IN
- PF\*\*PG-\*\*\* CABLE WIRE
- 1.25mm FFC (\*:1.00mm FFC)
- 2.0mm FLAT CABLE (\*:1.5mm FLAT CABLE)
- 1.25mm FFC CONNECTOR(L) (\*:1.00mm FFC CONNECTOR)
- 1.25mm FFC CONNECTOR(I) (\*:1.00mm FFC CONNECTOR)
- 2.0mm CABLE HOLDER (\*:1.5mm CABLE HOLDER)
- 2.0mm WIRE TRAP
- B\*B-PH-K-S PH CONNECTOR
- ANOTHER TYPE CODE SOCKET
- ANOTHER TYPE CODE CONNECTOR
- XKP%-A 1.25mm BOARD to BOARD
- XKP%-A 1.25mm BOARD to BOARD
- KP250NA 2.5mm BOARD to BOARD
- 2.5mm BOARD to BOARD
- ANOTHER TYPE BtoB SOCKET
- ANOTHER TYPE BtoB CONNECTOR

'05.2.25 update :TP



# A AUDIO&MULTI CH IN ASSY (AWX8674)

- (F) : AUDIO SIGNAL ROUTE(F)
- (C) : AUDIO SIGNAL ROUTE(C)
- (S) : AUDIO SIGNAL ROUTE(S)
- (SB) : AUDIO SIGNAL ROUTE(SB)
- (SW) : AUDIO SIGNAL ROUTE(SW)
- (PHONO) : AUDIO SIGNAL ROUTE (PHONO)
- (IP) : AUDIO SIGNAL ROUTE(IP)
- (CD) : AUDIO SIGNAL ROUTE (CD)
- (TL) : AUDIO SIGNAL ROUTE (TL)
- (MR) : AUDIO SIGNAL ROUTE (MR)
- (REC) : AUDIO SIGNAL ROUTE (REC)
- (CDR) : AUDIO SIGNAL ROUTE (CDR)
- (MIC) : AUDIO SIGNAL ROUTE (CDR)
- (FVL) : AUDIO SIGNAL ROUTE (FVL)

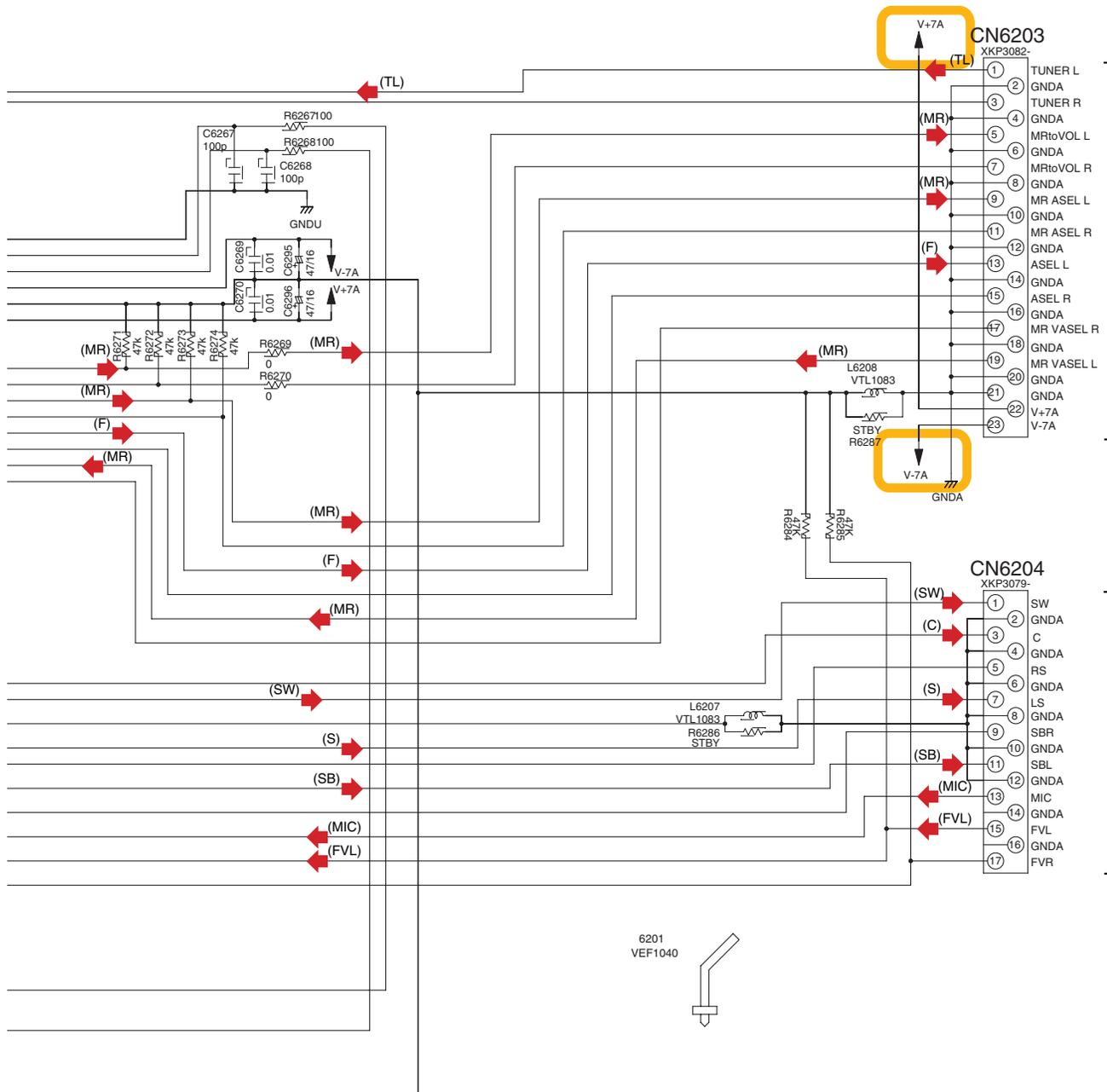

H CN5454

H CN5455

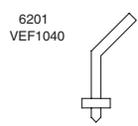

# 3.4 V-AUDIO ASSY

## B V-AUDIO ASSY (AWX8637)

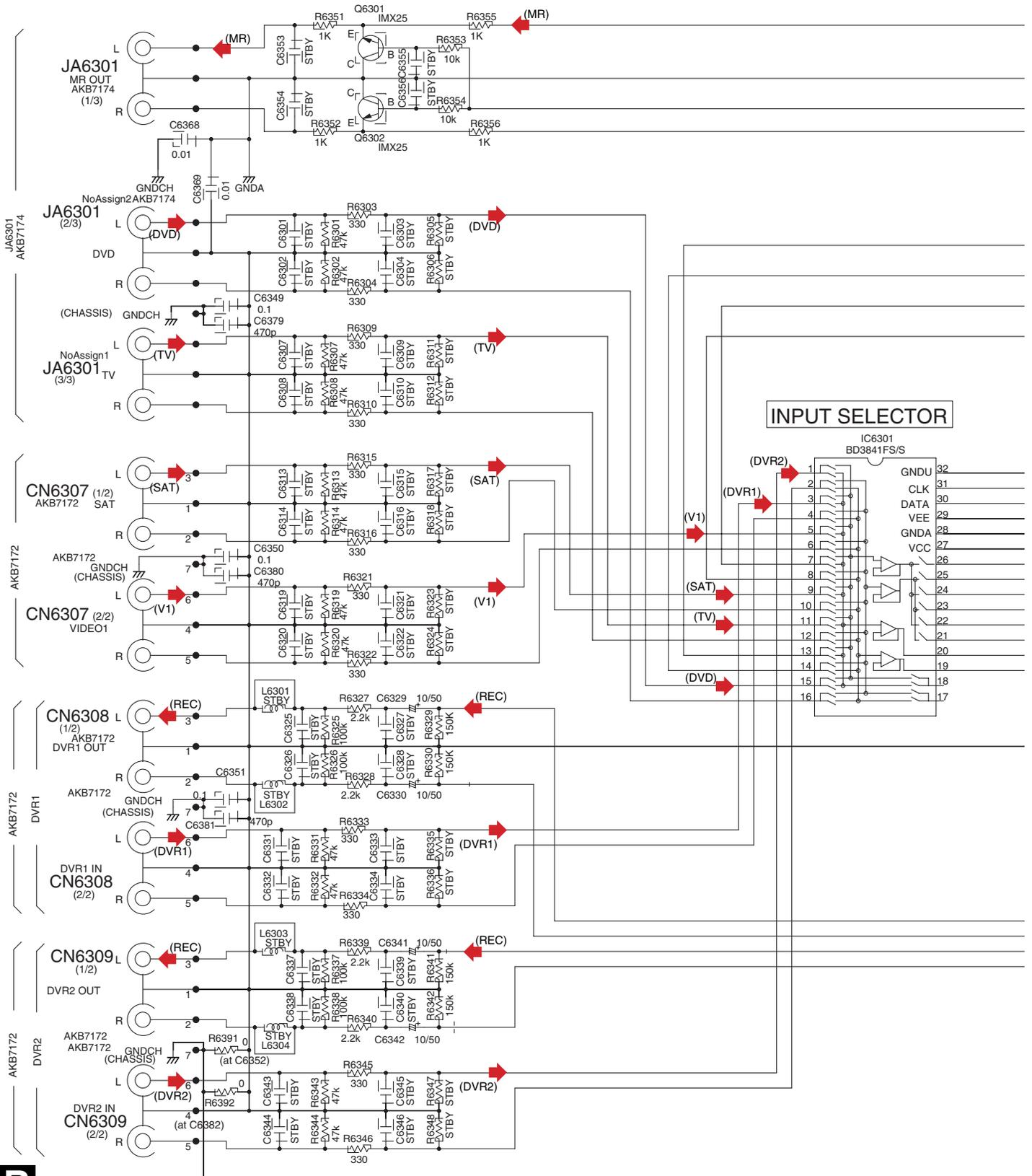



**NOTE**

**1.RESISTORS**  
 Unit: k-k , M-M or unless otherwise noted.  
 Rated power: 1/16W unless otherwise noted.  
 Tolerance: (J) ±5% unless otherwise noted.

**2.CAPACITORS**  
 Unit: p-pF or μF unless otherwise noted.  
 Ratings: Capacity(μF)/Voltage(V) unless otherwise noted.  
 Rated Voltage: 50V expect for electrolytic capacitors.

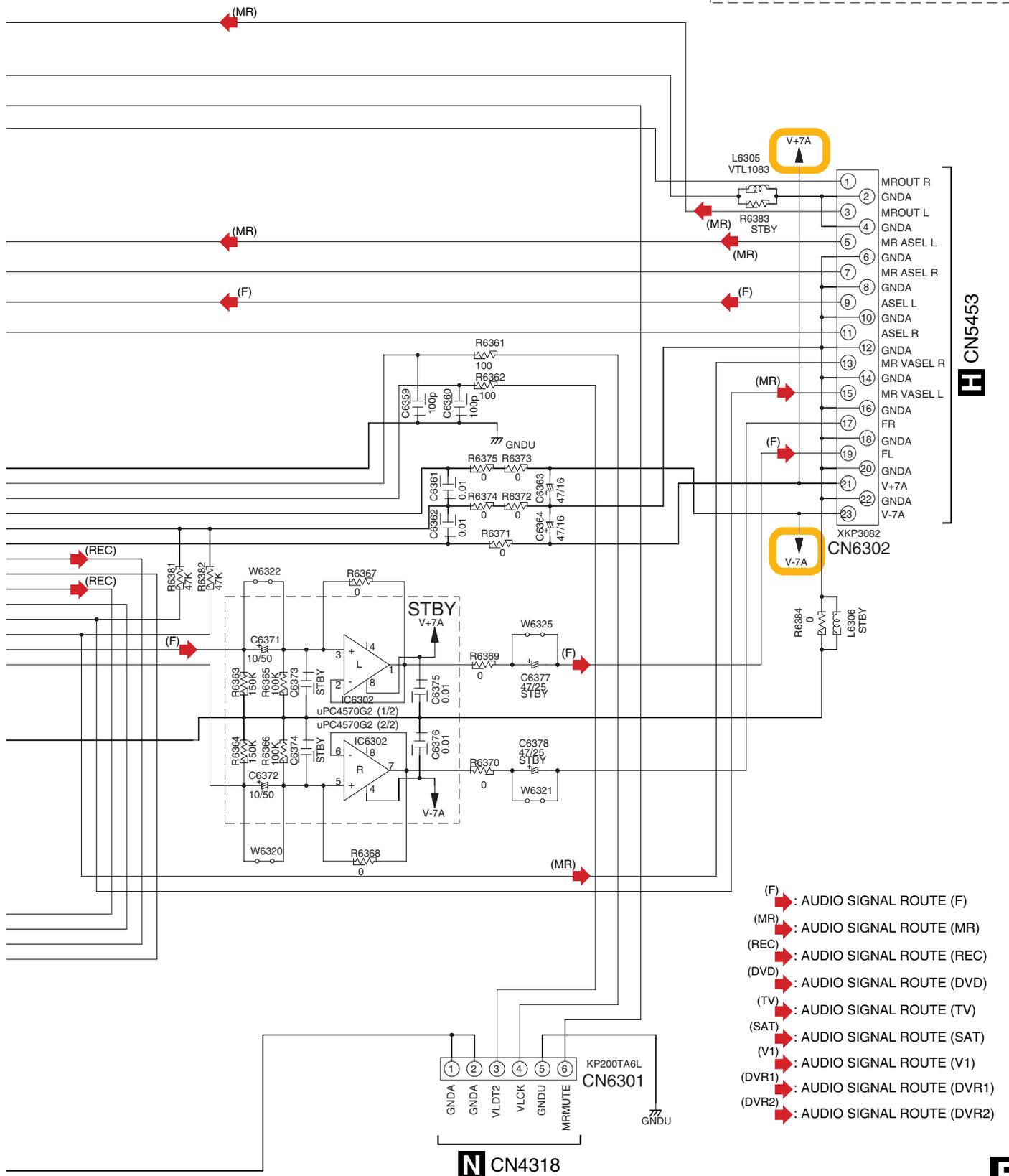

- (F) : AUDIO SIGNAL ROUTE (F)
- (MR) : AUDIO SIGNAL ROUTE (MR)
- (REC) : AUDIO SIGNAL ROUTE (REC)
- (DVD) : AUDIO SIGNAL ROUTE (DVD)
- (TV) : AUDIO SIGNAL ROUTE (TV)
- (SAT) : AUDIO SIGNAL ROUTE (SAT)
- (V1) : AUDIO SIGNAL ROUTE (V1)
- (DVR1) : AUDIO SIGNAL ROUTE (DVR1)
- (DVR2) : AUDIO SIGNAL ROUTE (DVR2)

**N** CN4318

**H** CN5453

**B**



**C** FRONT-IN ASSY  
(AWX8638)

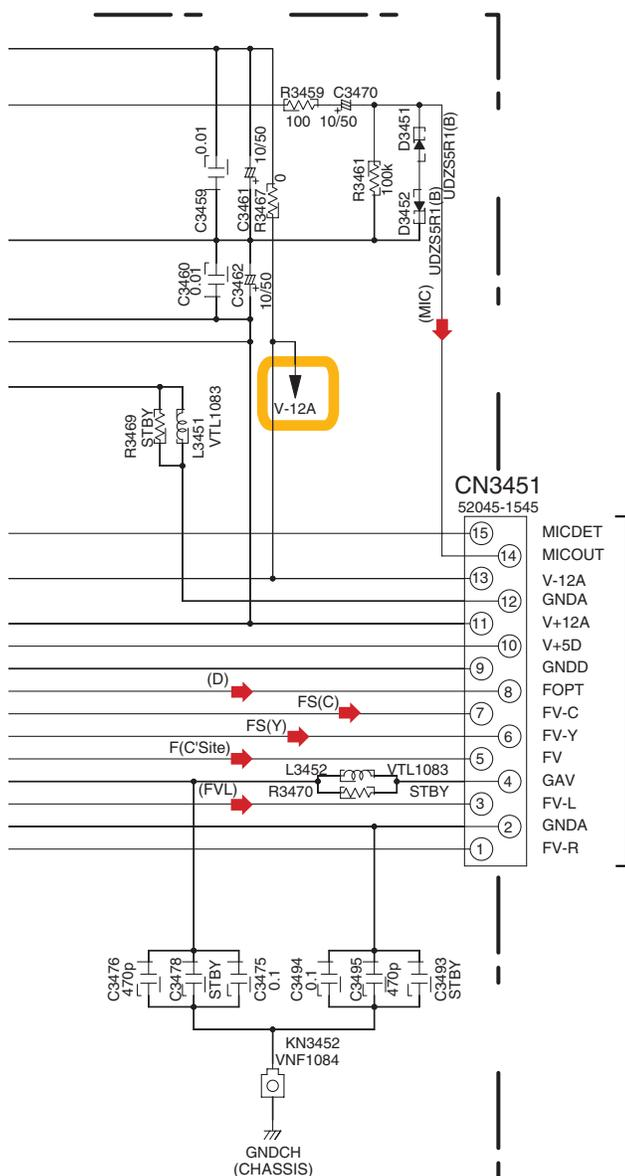

The  $\Delta$  mark found on some component parts indicates the importance of the safety factor of the part. Therefore, when replacing, be sure to use parts of identical designation.

**NOTE**

**1.RESISTORS**  
Unit: k-k, M-M or unless otherwise noted.  
Rated power: 1/16W unless otherwise noted.  
Tolerance: (J)  $\pm$  5% unless otherwise noted.

**2.CAPACITORS**  
Unit: p-pF or  $\mu$ F unless otherwise noted.  
Ratings: Capacity( $\mu$ F)/Voltage(V) unless otherwise noted.  
Rated Voltage: 50V expect for electrolytic capacitors.  
JQ:CEJQ

- FS(Y)  $\rightarrow$  : VIDEO SIGNAL ROUTE FS(Y)
- FS(C)  $\rightarrow$  : VIDEO SIGNAL ROUTE FS(C)
- F(C'Site)  $\rightarrow$  : VIDEO SIGNAL ROUTE F(C'Site)
- (FVL)  $\rightarrow$  : VIDEO SIGNAL ROUTE (VIDEO 2)
- (F)  $\rightarrow$  : AUDIO SIGNAL ROUTE (F)
- (MIC)  $\rightarrow$  : AUDIO SIGNAL ROUTE (MIC)
- (D)  $\rightarrow$  : AUDIO SIGNAL ROUTE (SPDIF)

**N** CN4301

- CN3451**  
52045-1545
- (15) MICDET
  - (14) MICOUT
  - (13) V-12A
  - (12) GNDA
  - (11) V+12A
  - (10) V+5D
  - (9) GNDD
  - (8) FOPT
  - (7) FV-C
  - (6) FV-Y
  - (5) FV
  - (4) GAV
  - (3) FV-L
  - (2) GNDA
  - (1) FV-R



# BRIDGE 3 ASSY (AWX8669)

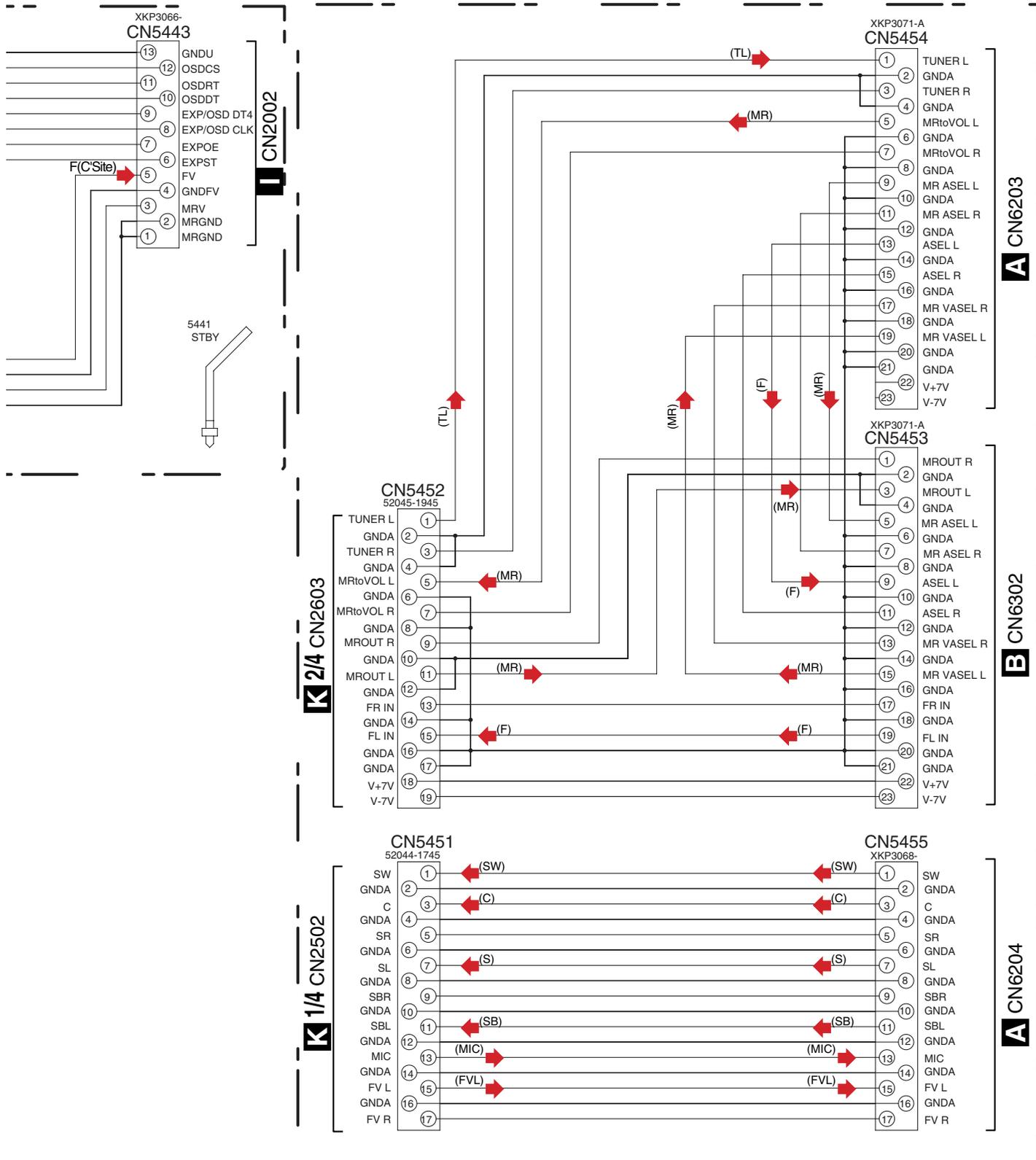

# 3.7 COMPOSITE V ASSY

A

B

C

D

E

F

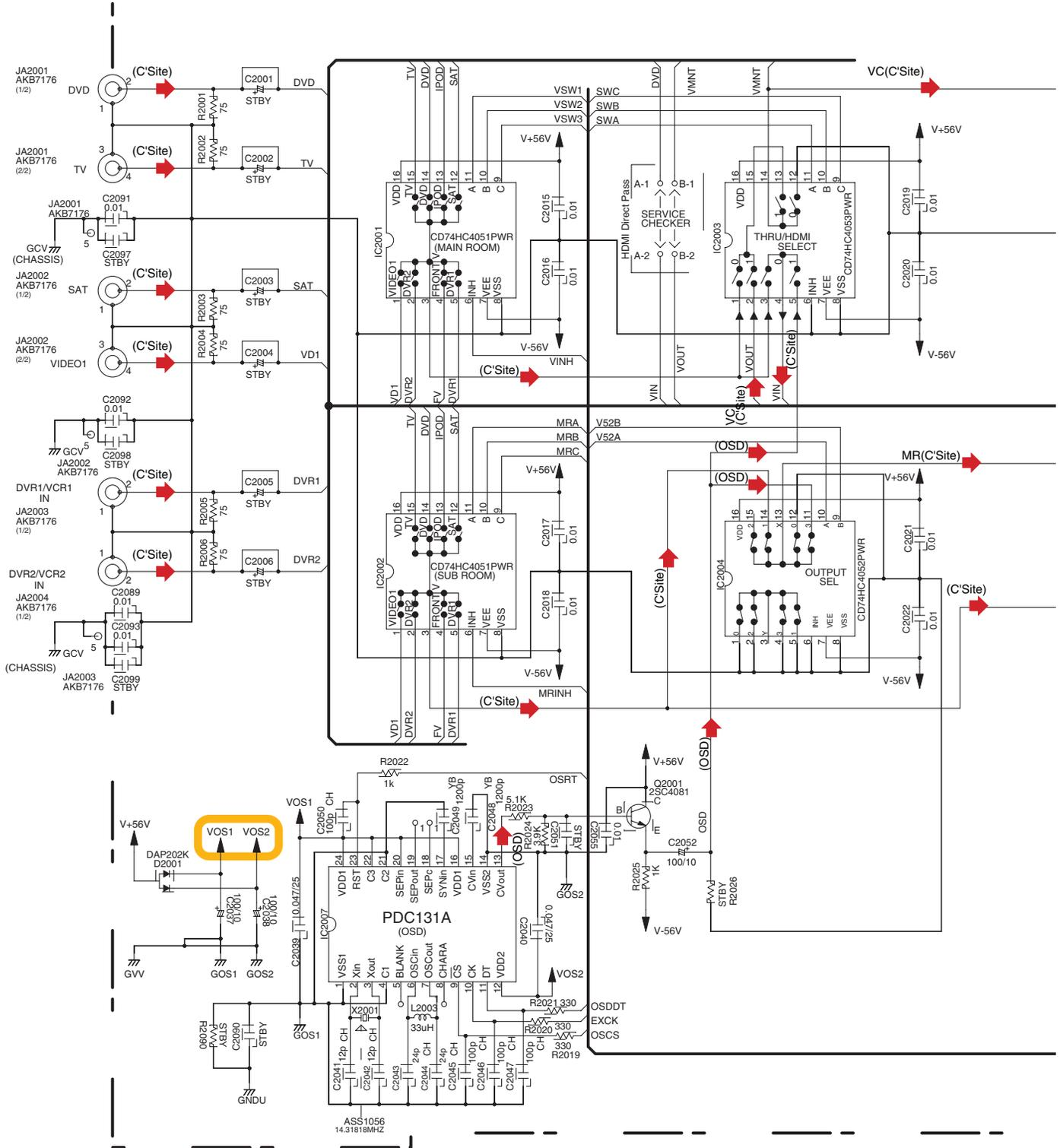

- (C'Site) → VIDEO SIGNAL ROUTE (C'Site)
- F(C'Site) → VIDEO SIGNAL ROUTE F(C'Site)
- MR(C'Site) → VIDEO SIGNAL ROUTE MR(C'Site)
- VC(C'Site) → VIDEO SIGNAL ROUTE VC(C'Site)
- (OSD) → VIDEO SIGNAL ROUTE (OSD)

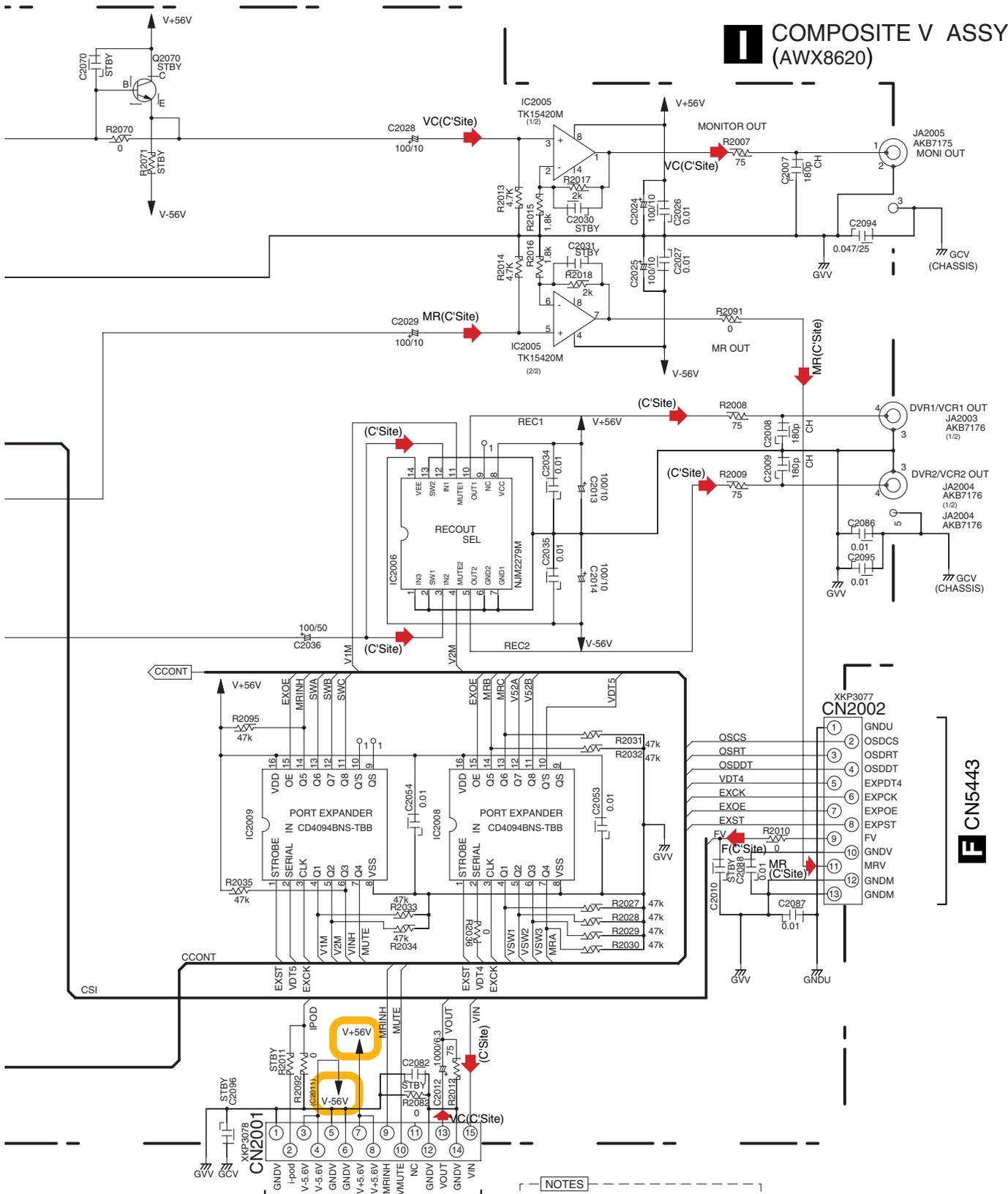

**N CN4317**

- NOTES**
- RESISTORS**  
Unit: k-k, M-M or unless otherwise noted.  
Rated power: 1/16W unless otherwise noted.  
Tolerance: ± 5%(J) unless otherwise noted.
  - CAPACITORS**  
No marked Capacitors are CEAT or CKSRYB.  
Unit: p-pF or μF unless otherwise noted.  
Rated Voltage: shown as "Capacity(μF)/Voltage(V)", or 50V unless otherwise noted.
  - DIODES**  
No marked Diodes are 1SS355.  
\*Parts or parts block marked by "STBY" are standby.

The  $\Delta$  mark found on some component parts indicates the importance of the safety factor of the part. Therefore, when replacing, be sure to use parts of identical designation.

A  
B  
C  
D  
E  
F

# 3.8 S-VIDEO ASSY

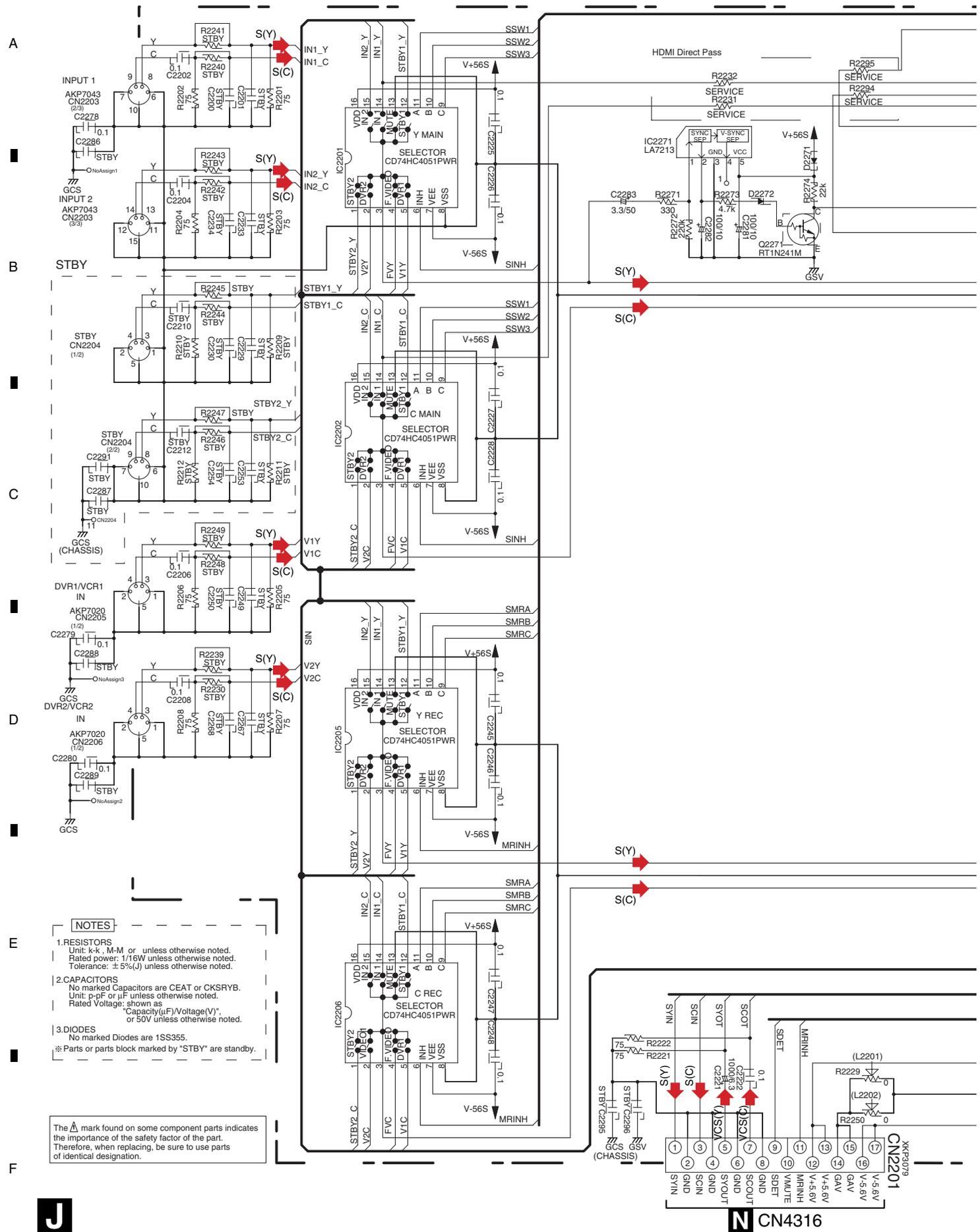

- NOTES**
1. RESISTORS  
Unit: k-k, M-M or unless otherwise noted.  
Rated power: 1/16W unless otherwise noted.  
Tolerance: ± 5%(J) unless otherwise noted.
  2. CAPACITORS  
No marked Capacitors are CEAT or CKSRYB.  
Unit: p-pF or uF unless otherwise noted.  
Rated Voltage: shown as "Capacity(uF)/Voltage(V)", or 50V unless otherwise noted.
  3. DIODES  
No marked Diodes are 1SS355.  
※ Parts or parts block marked by "STBY" are standby.

The  $\Delta$  mark found on some component parts indicates the importance of the safety factor of the part. Therefore, when replacing, be sure to use parts of identical designation.

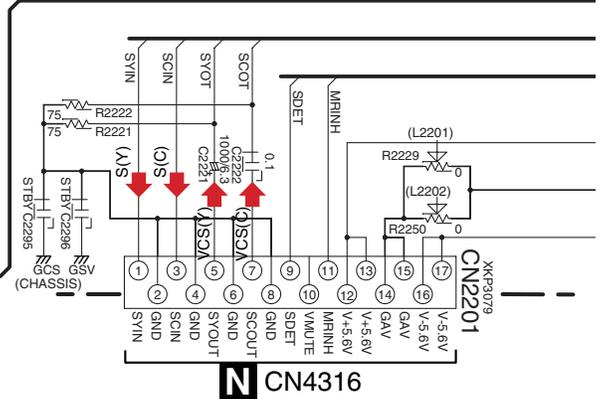



# J S-VIDEO ASSY (AWX8622)

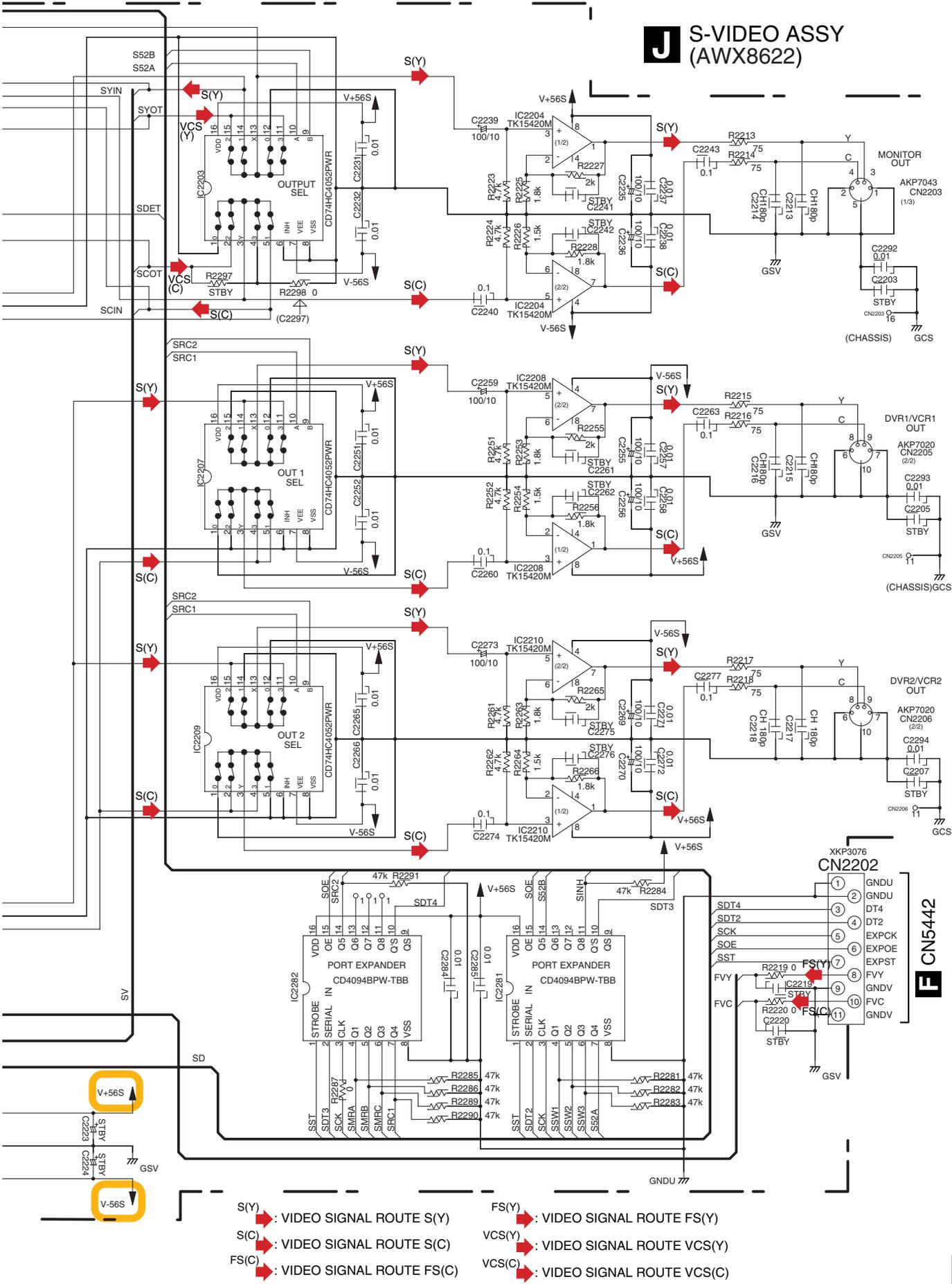

- S(Y) : VIDEO SIGNAL ROUTE S(Y)
- S(C) : VIDEO SIGNAL ROUTE S(C)
- FS(C) : VIDEO SIGNAL ROUTE FS(C)
- FS(Y) : VIDEO SIGNAL ROUTE FS(Y)
- VCS(Y) : VIDEO SIGNAL ROUTE VCS(Y)
- VCS(C) : VIDEO SIGNAL ROUTE VCS(C)





# K 1/4 COMPONENT & VOL ASSY (VSX-74TXVi:AWQ7028) (VSX-72TXV:AWQ7030)

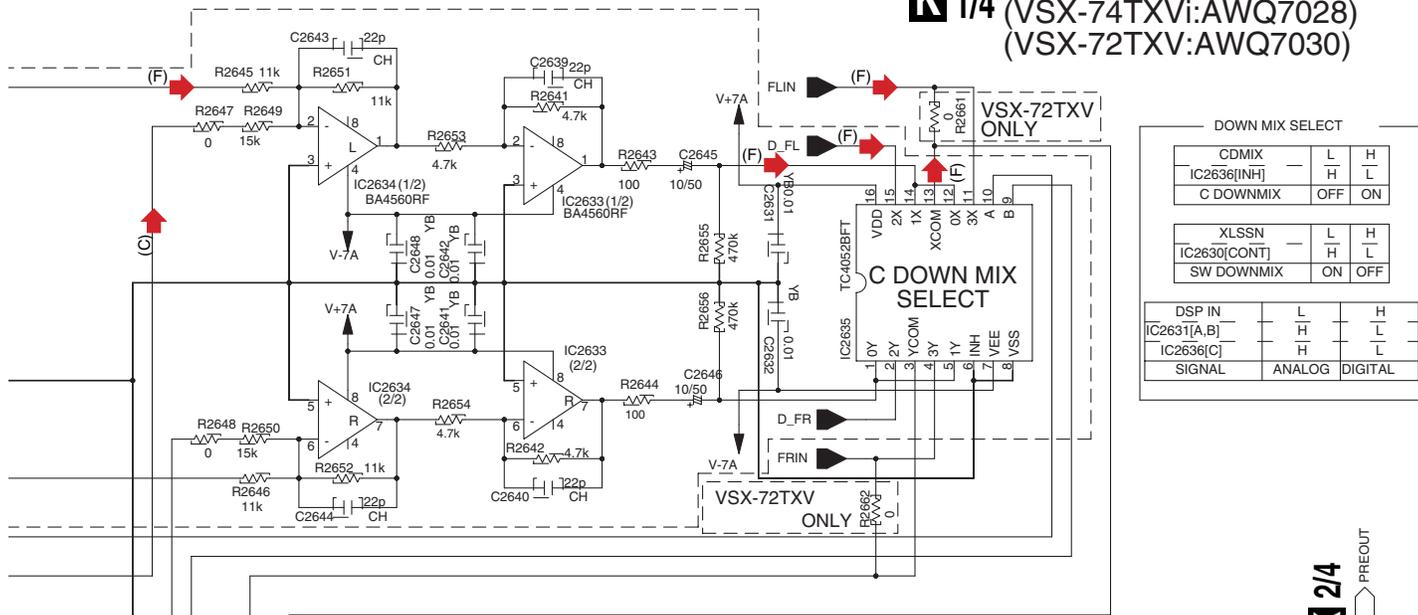

DOWN MIX SELECT			
CDMIX	IC2636[INH]	L	H
C DOWNMIX	OFF	ON	
XLSSN	IC2630[CONT]	L	H
SW DOWNMIX	ON	OFF	
DSP IN	IC2631[A,B]	L	H
IC2636[C]		H	L
SIGNAL	ANALOG	DIGITAL	

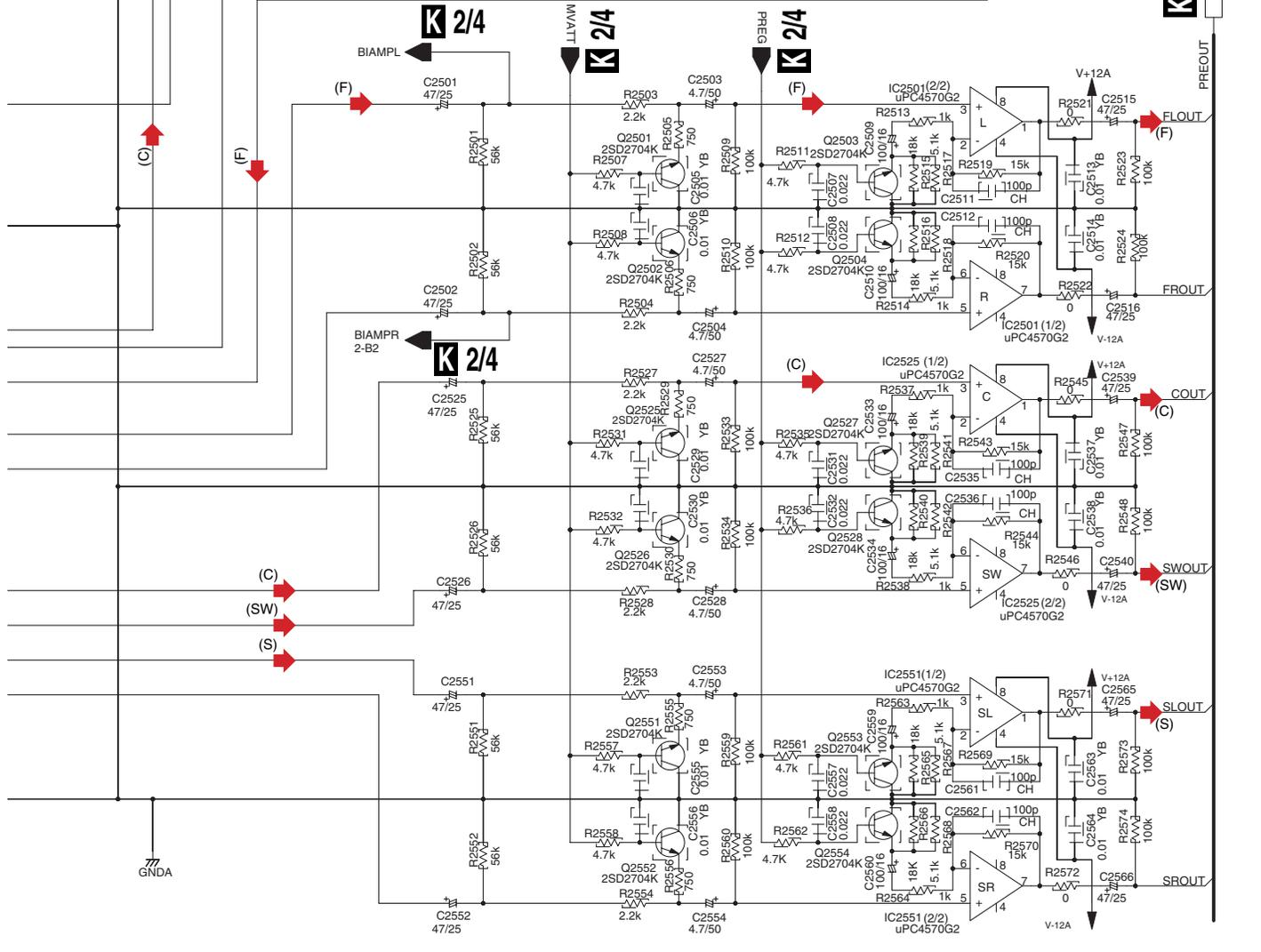

- (F) : AUDIO SIGNAL ROUTE(F)
- (C) : AUDIO SIGNAL ROUTE(C)
- (S) : AUDIO SIGNAL ROUTE(S)
- (SW) : AUDIO SIGNAL ROUTE(SW)
- (MIC) : AUDIO SIGNAL ROUTE(MIC)
- (FVL) : AUDIO SIGNAL ROUTE(VIDEO2)
- (SB) : AUDIO SIGNAL ROUTE(SB)

# 3.10 COMPONENT & VOL ASSY (2/4)

1 2 3 4

A B C D E F

- F(CSite) : VIDEO SIGNAL ROUTE F(CSite)
- FS(C) : VIDEO SIGNAL ROUTE FS(C)
- FS(Y) : VIDEO SIGNAL ROUTE FS(Y)

- (F) : AUDIO SIGNAL ROUTE(F)
- (C) : AUDIO SIGNAL ROUTE(C)
- (S) : AUDIO SIGNAL ROUTE(S)
- (TL) : AUDIO SIGNAL ROUTE(TUNER)
- (MR) : AUDIO SIGNAL ROUTE(MR)

- (SB) : AUDIO SIGNAL ROUTE(SB)
- (SW) : AUDIO SIGNAL ROUTE(SW)
- (MIC) : AUDIO SIGNAL ROUTE(MIC)
- (FVL) : AUDIO SIGNAL ROUTE(VIDEO2)

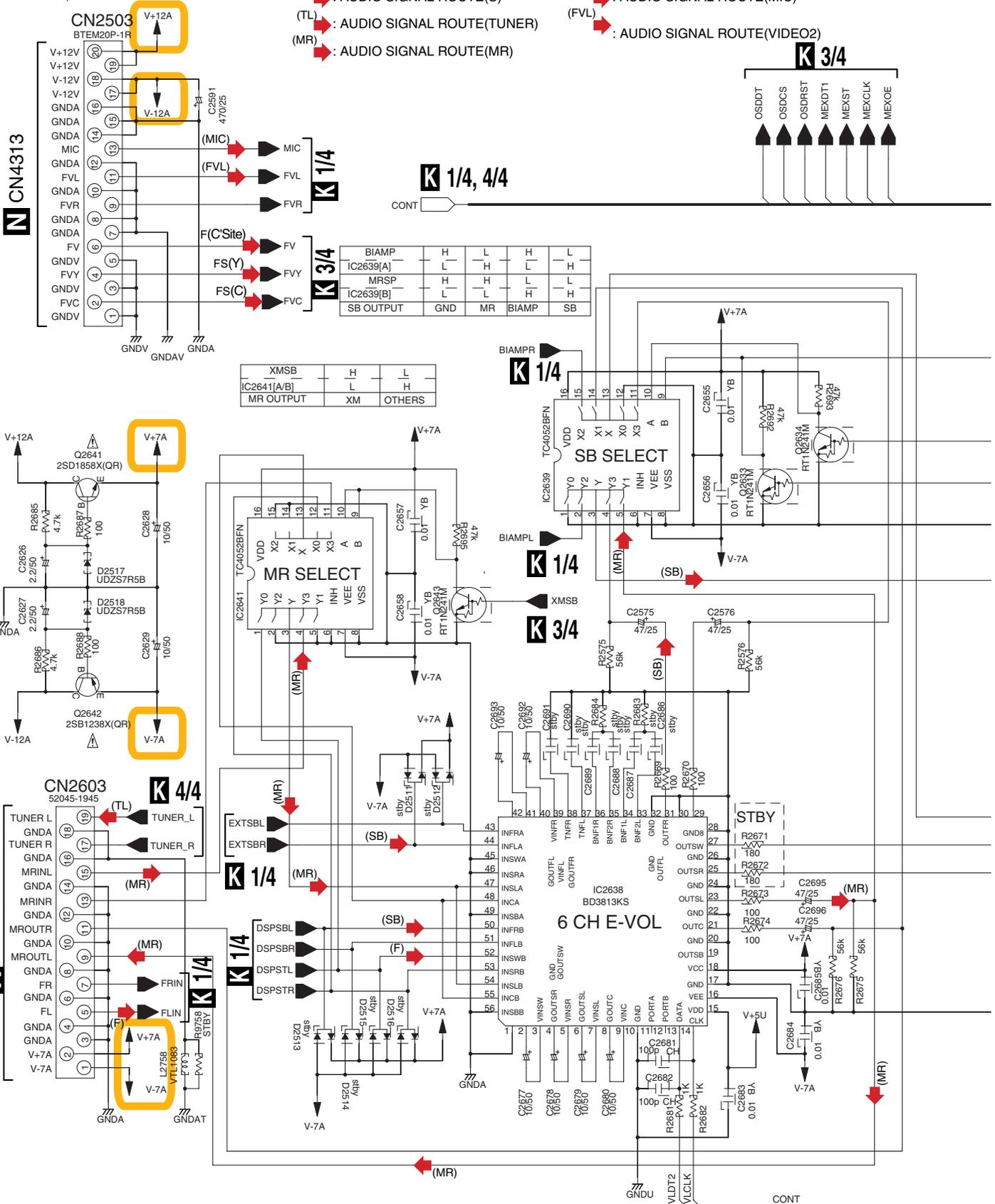

**K 2/4**

1 2 3 4





- C1(Y) → : VIDEO SIGNAL ROUTE C1(Y)
- C1(Cb) → : VIDEO SIGNAL ROUTE C1(Cb)
- C1(Cr) → : VIDEO SIGNAL ROUTE C1(Cr)
- C2(Y) → : VIDEO SIGNAL ROUTE C2(Y)
- C2(Cb) → : VIDEO SIGNAL ROUTE C2(Cb)
- C2(Cr) → : VIDEO SIGNAL ROUTE C2(Cr)
- C3(Y) → : VIDEO SIGNAL ROUTE C3(Y)
- C3(Cb) → : VIDEO SIGNAL ROUTE C3(Cb)
- C3(Cr) → : VIDEO SIGNAL ROUTE C3(Cr)

- MR(C'Site) → : VIDEO SIGNAL ROUTE MR(C'Site)
- F(C'Site) → : VIDEO SIGNAL ROUTE F(C'Site)
- FS(C) → : VIDEO SIGNAL ROUTE FS(C)
- FS(Y) → : VIDEO SIGNAL ROUTE FS(Y)
- C(Y) → : VIDEO SIGNAL ROUTE C(Y)
- C(Cb) → : VIDEO SIGNAL ROUTE C(Cb)
- C(Cr) → : VIDEO SIGNAL ROUTE C(Cr)
- VC(Cr) → : VIDEO SIGNAL ROUTE VC(Cr)
- VC(Cb) → : VIDEO SIGNAL ROUTE VC(Cb)
- VC(Y) → : VIDEO SIGNAL ROUTE VC(Y)

# K3/4 COMPONENT & VOL ASSY (VSX-74TXVi:AWQ7028) (VSX-72TXV:AWQ7030)

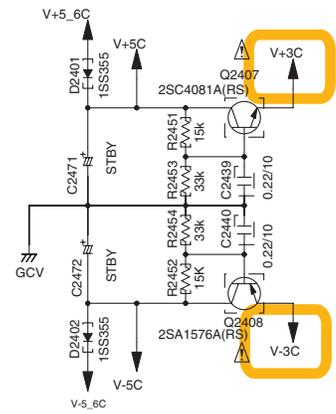
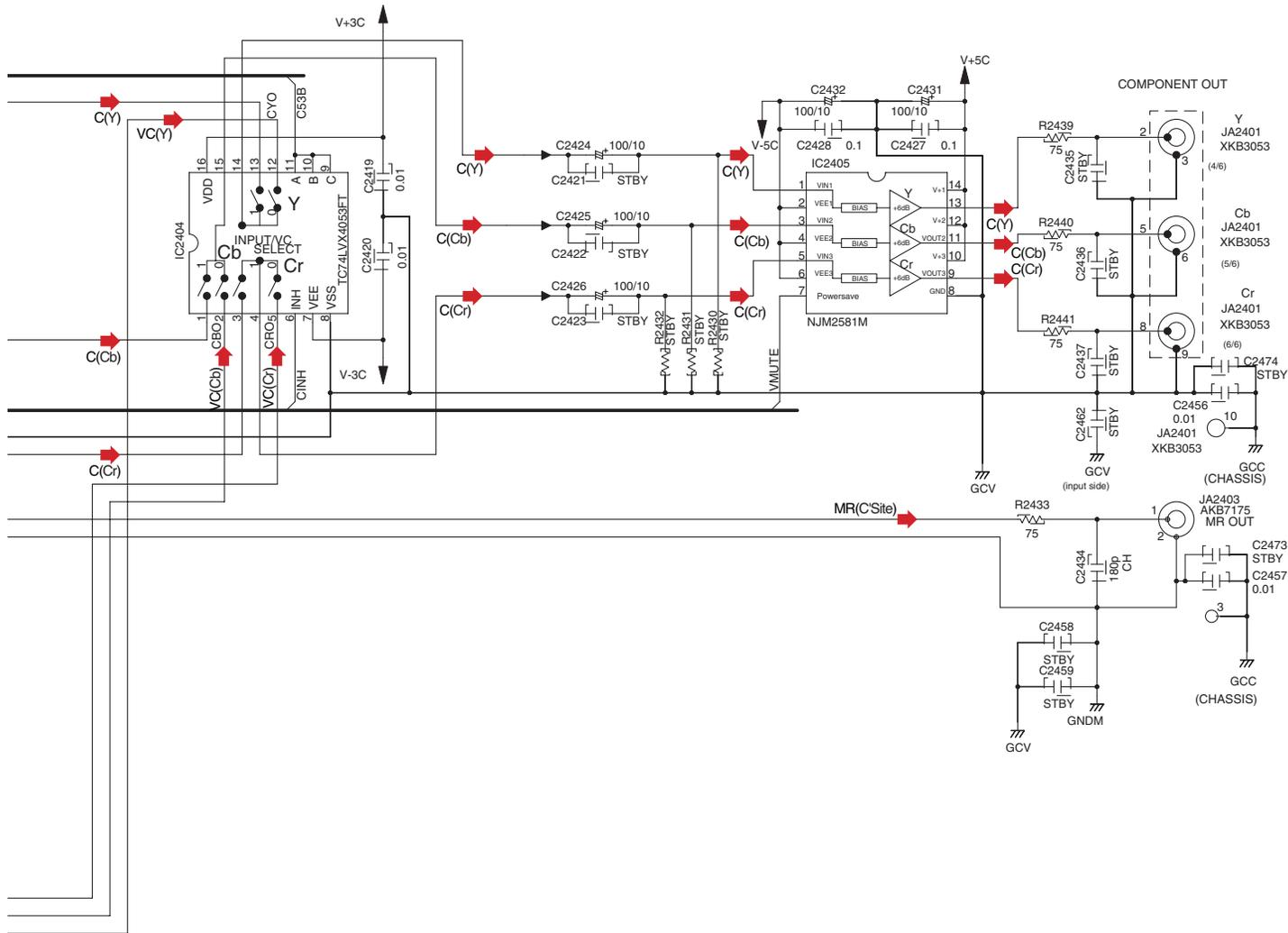

The mark found on some component parts indicates the importance of the safety factor of the part. Therefore, when replacing, be sure to use parts of identical designation.







**K 4/4** COMPONENT & VOL ASSY  
 (VSX-74TXVi:AWQ7028)  
 (VSX-72TXV:AWQ7030)

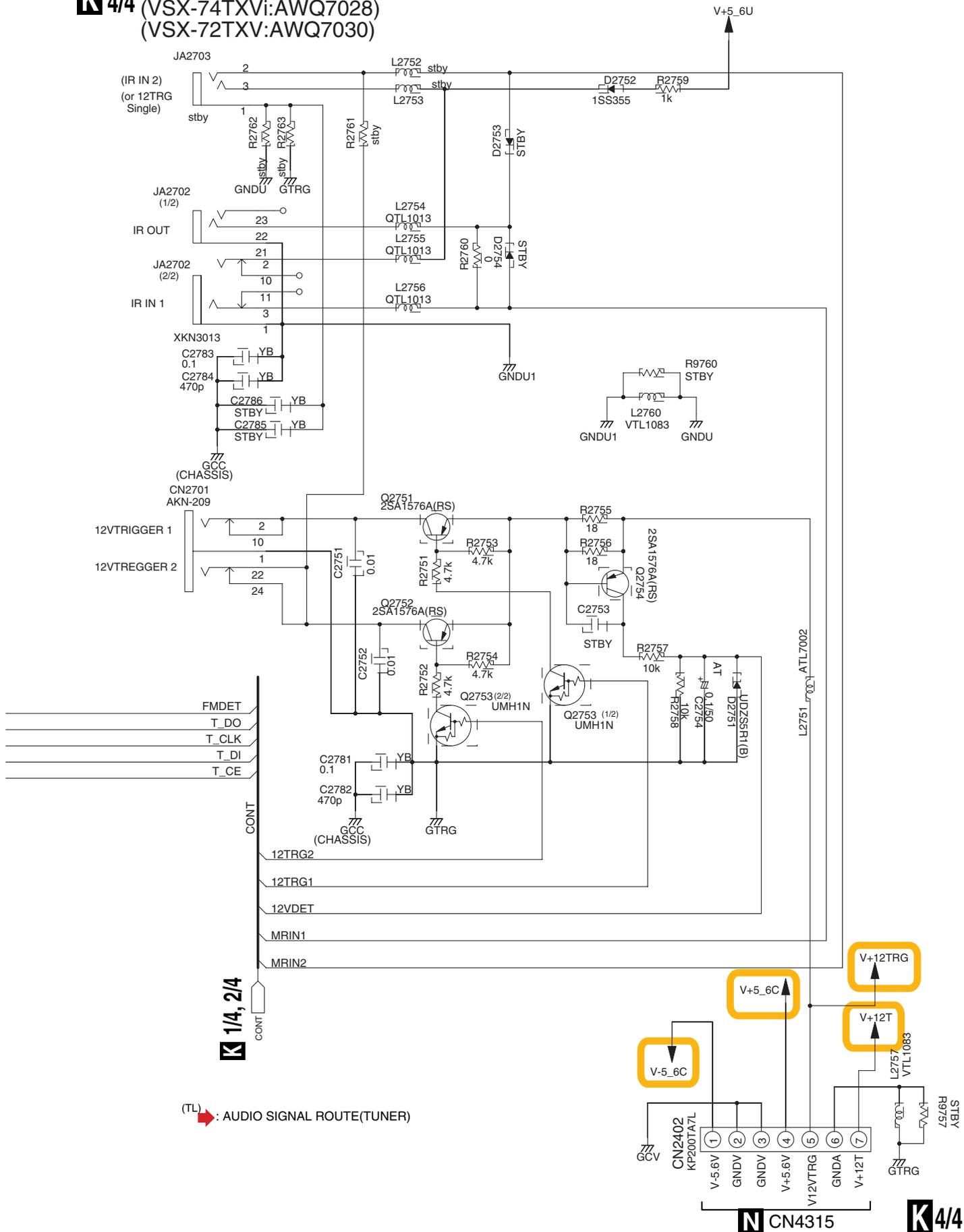

**K 1/4, 2/4**

(TL) → AUDIO SIGNAL ROUTE(TUNER)

**N CN4315**

**K 4/4**

# 3.13 DIGITAL MOTHER ASSY (1/8)

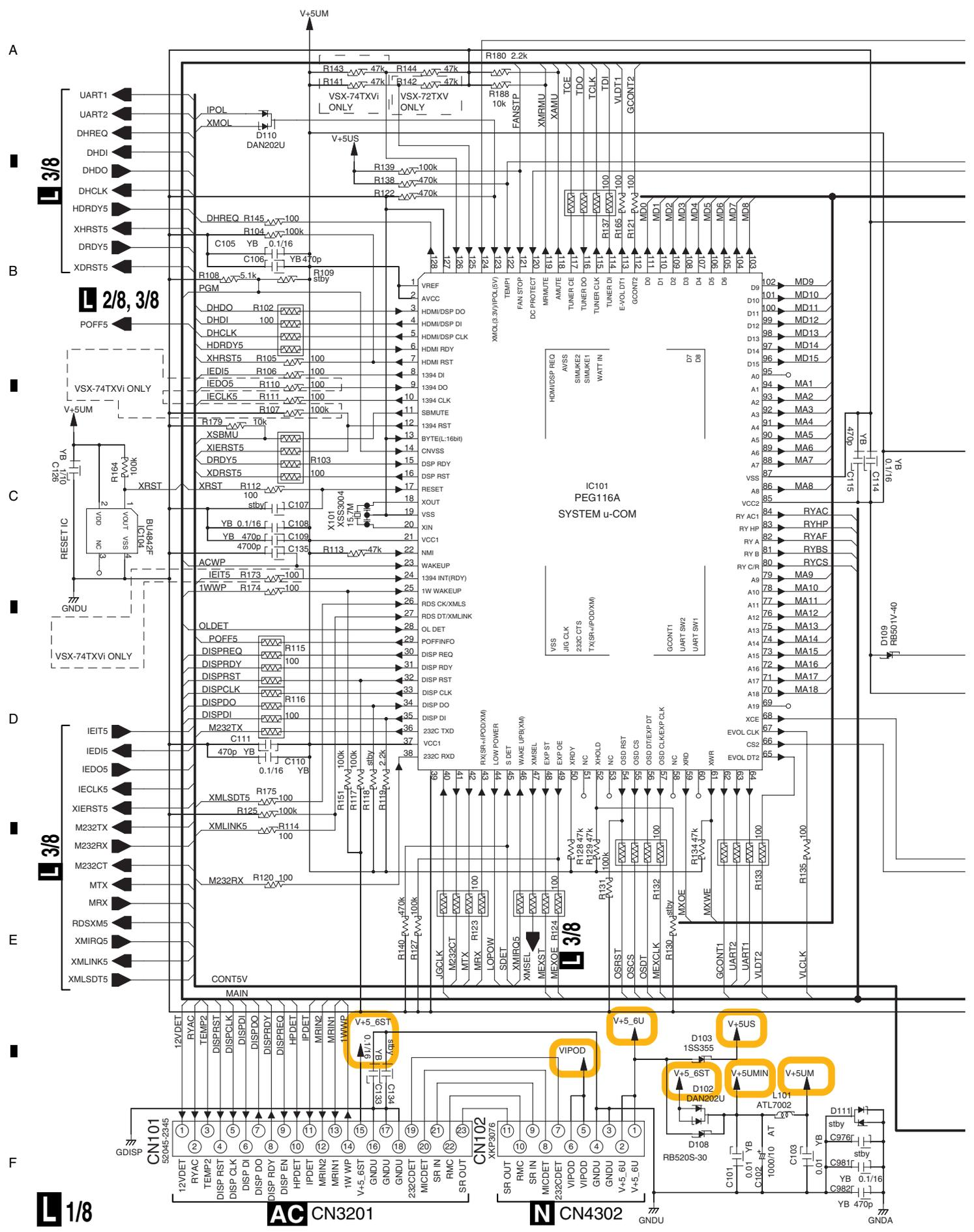

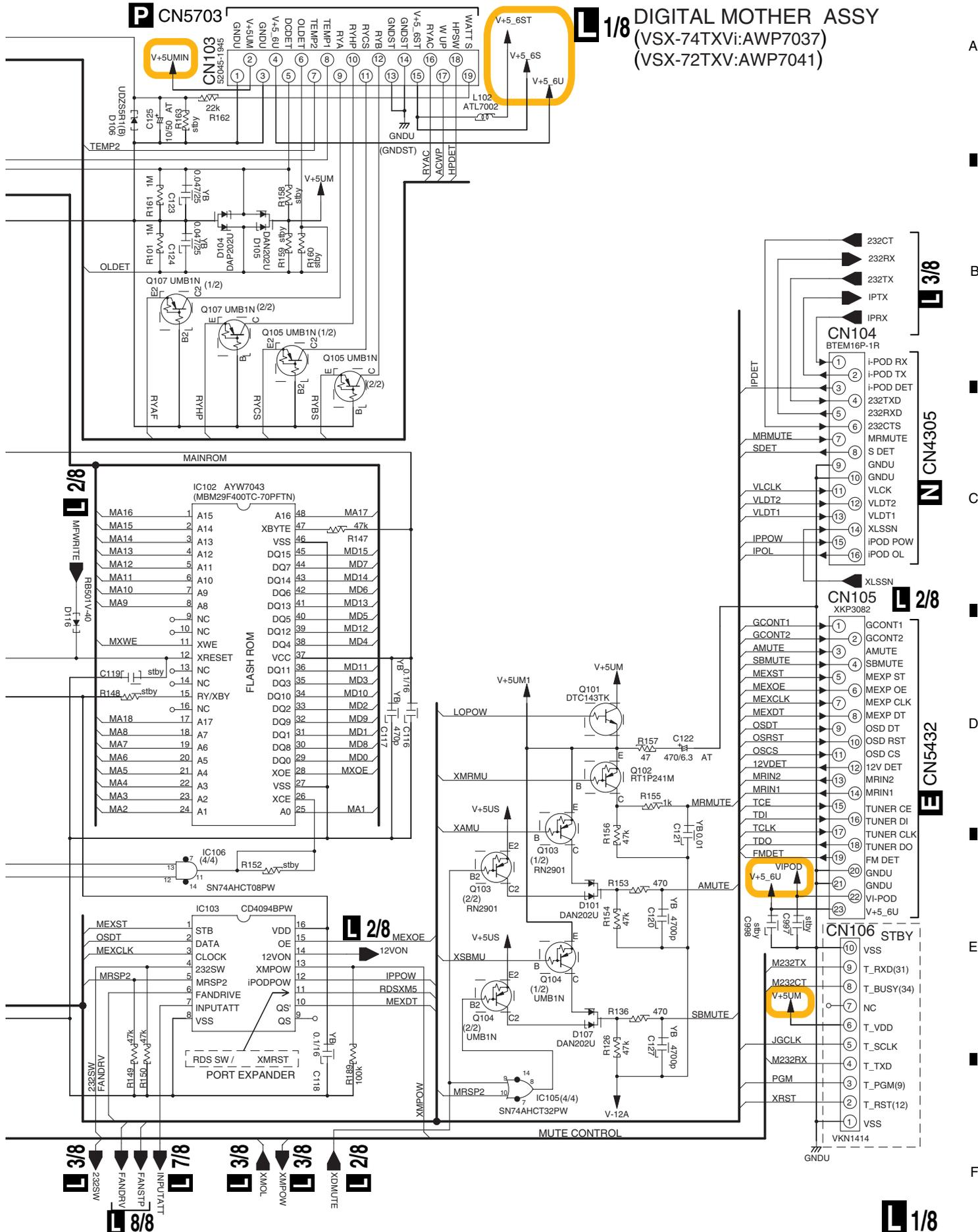



4/8, 5/8

# DIGITAL MOTHER ASSY (VSX-74TXVi:AWP7037) (VSX-72TXV:AWP7041)

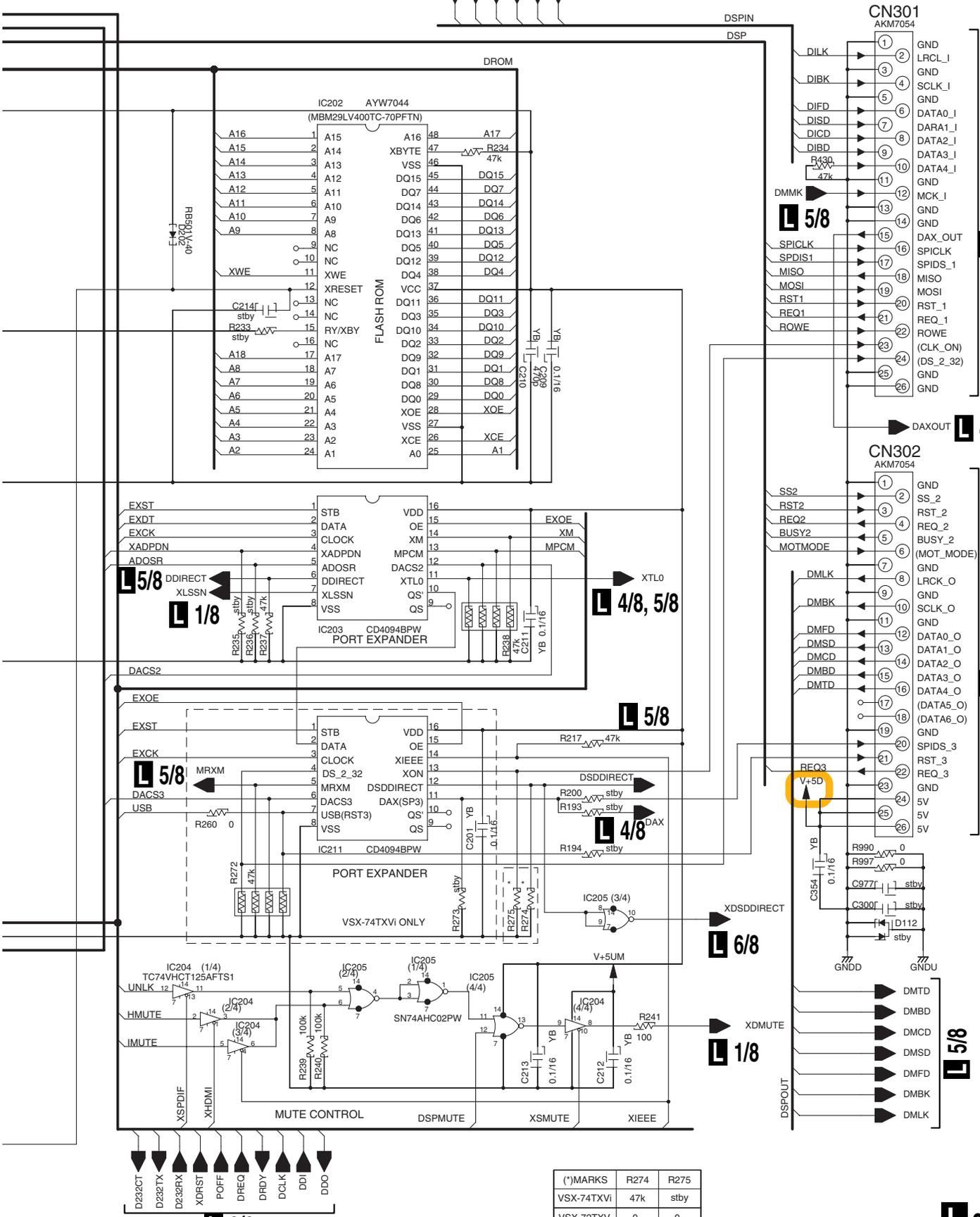

(*)MARKS	R274	R275
VSX-74TXVi	47k	stby
VSX-72TXV	0	0

A

B

C

D

E

F

3/8

2/8

## VSX-74TXVi



**L 3/8** DIGITAL MOTHER ASSY  
 (VSX-74TXVi:AWP7037)  
 (VSX-72TXV:AWP7041)

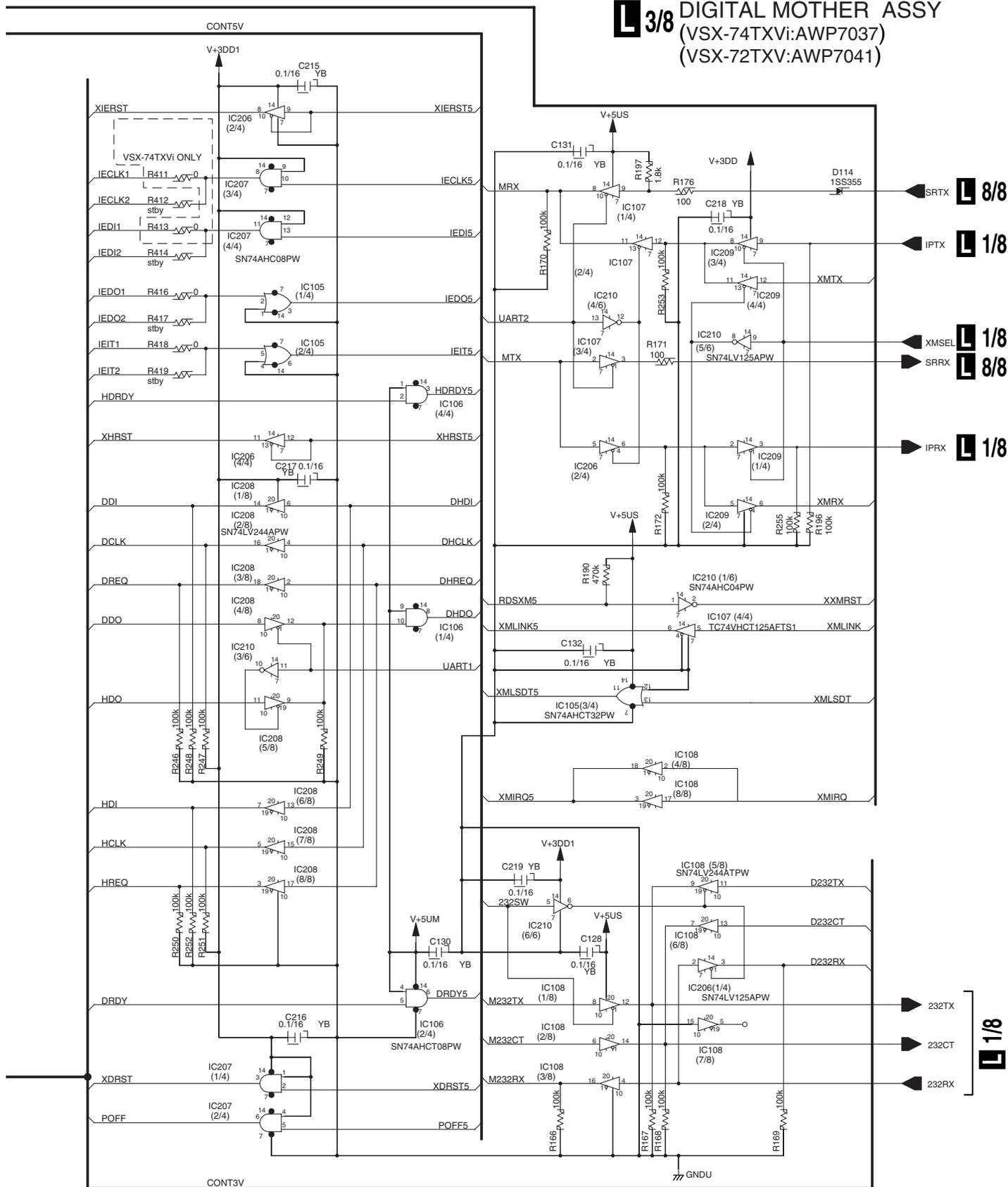

(F) → : AUDIO SIGNAL ROUTE(F)  
 (D) → : AUDIO SIGNAL ROUTE(SPDIF)

# 3.16 DIGITAL MOTHER ASSY (4/8)

(*)MARKS	R338	R342
	R346	R350
	R382	R386
	R390	R332
VSX-74TXVI	stby	
VSX-72TXV	0	

A  
B  
C  
D  
E  
F

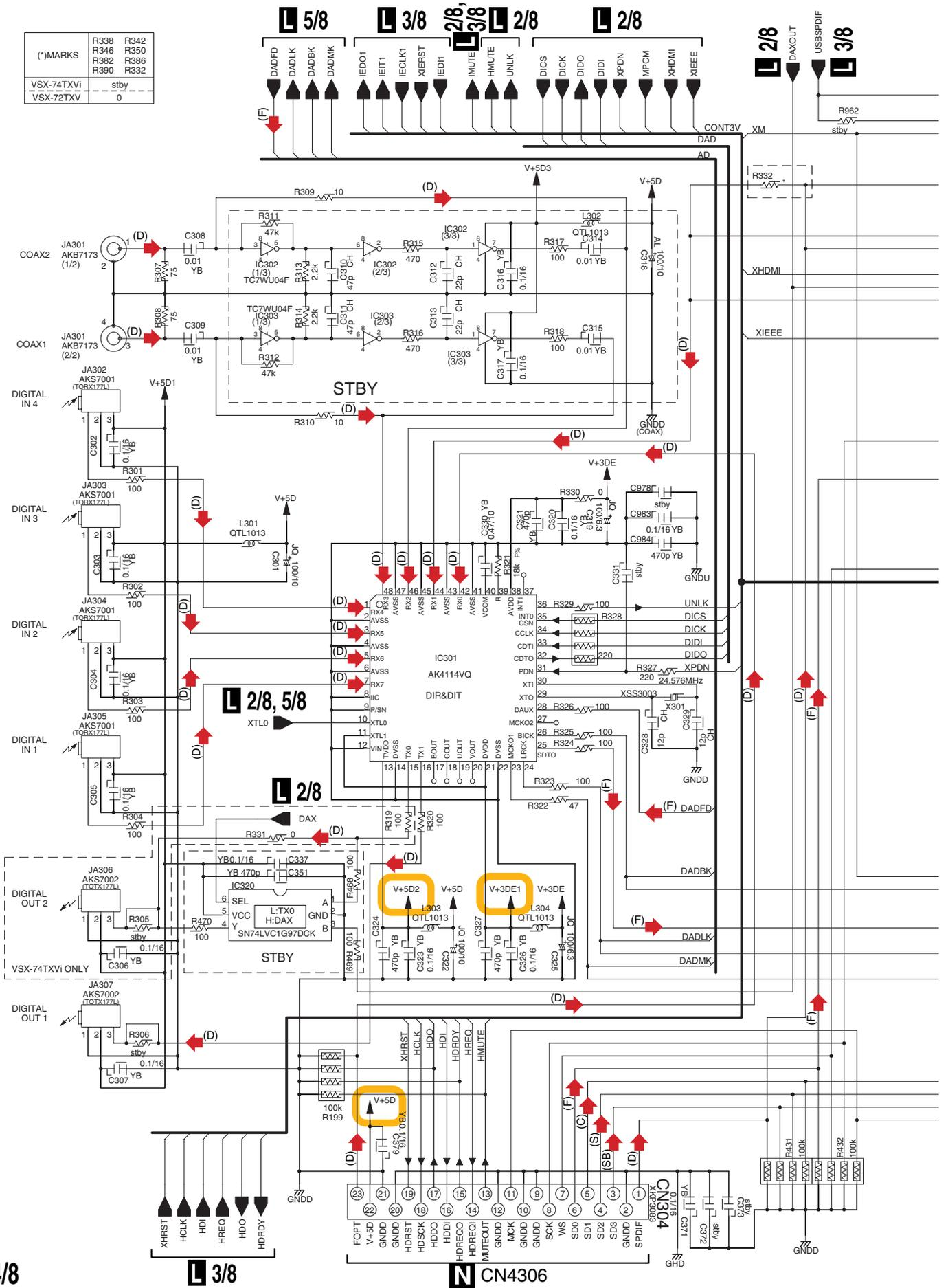

4/8

3/8

CN4306

VSX-74TXVI





# 3.17 DIGITAL MOTHER ASSY (5/8)

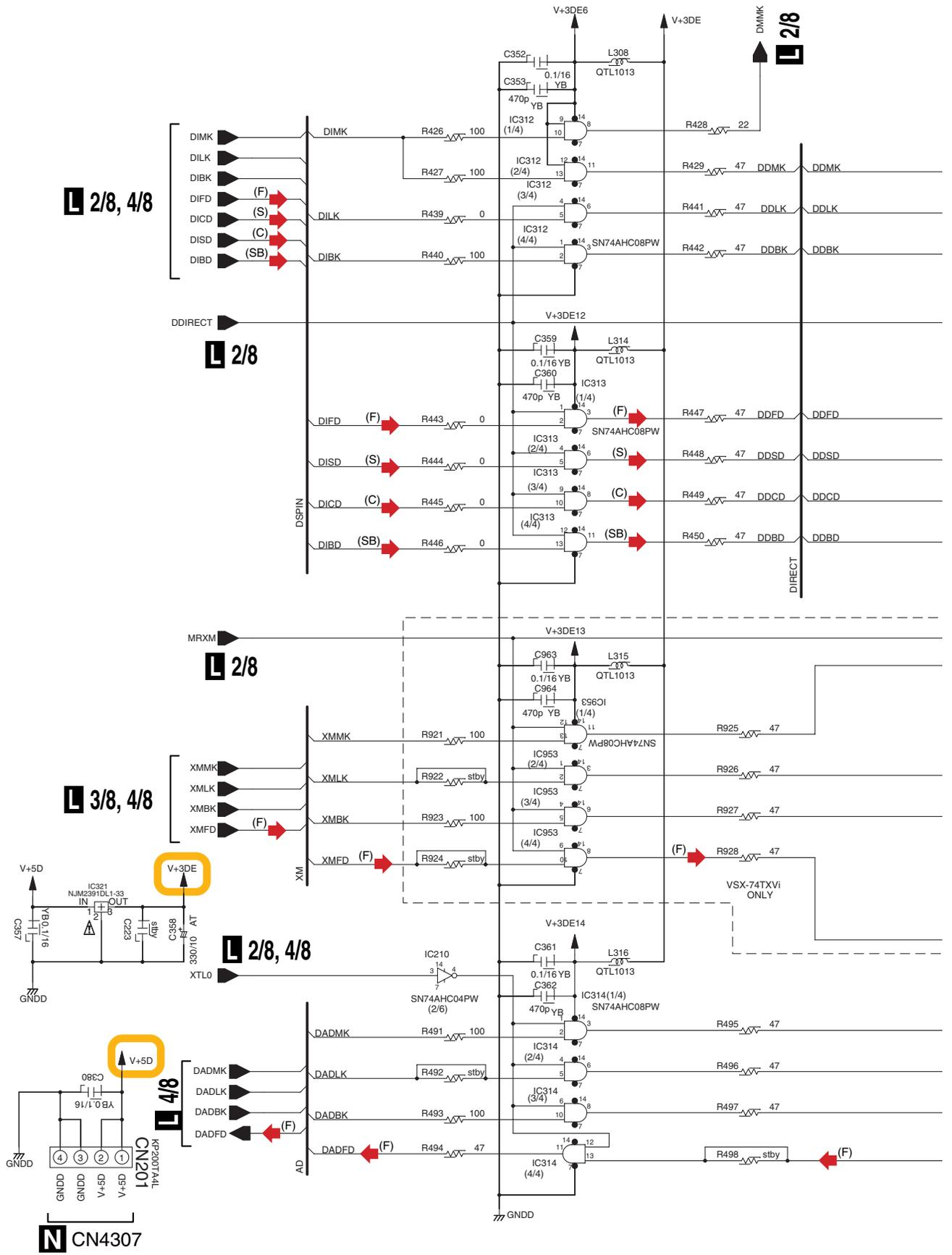

# L 5/8 DIGITAL MOTHER ASSY (VSX-74TXVi:AWP7037) (VSX-72TXV:AWP7041)

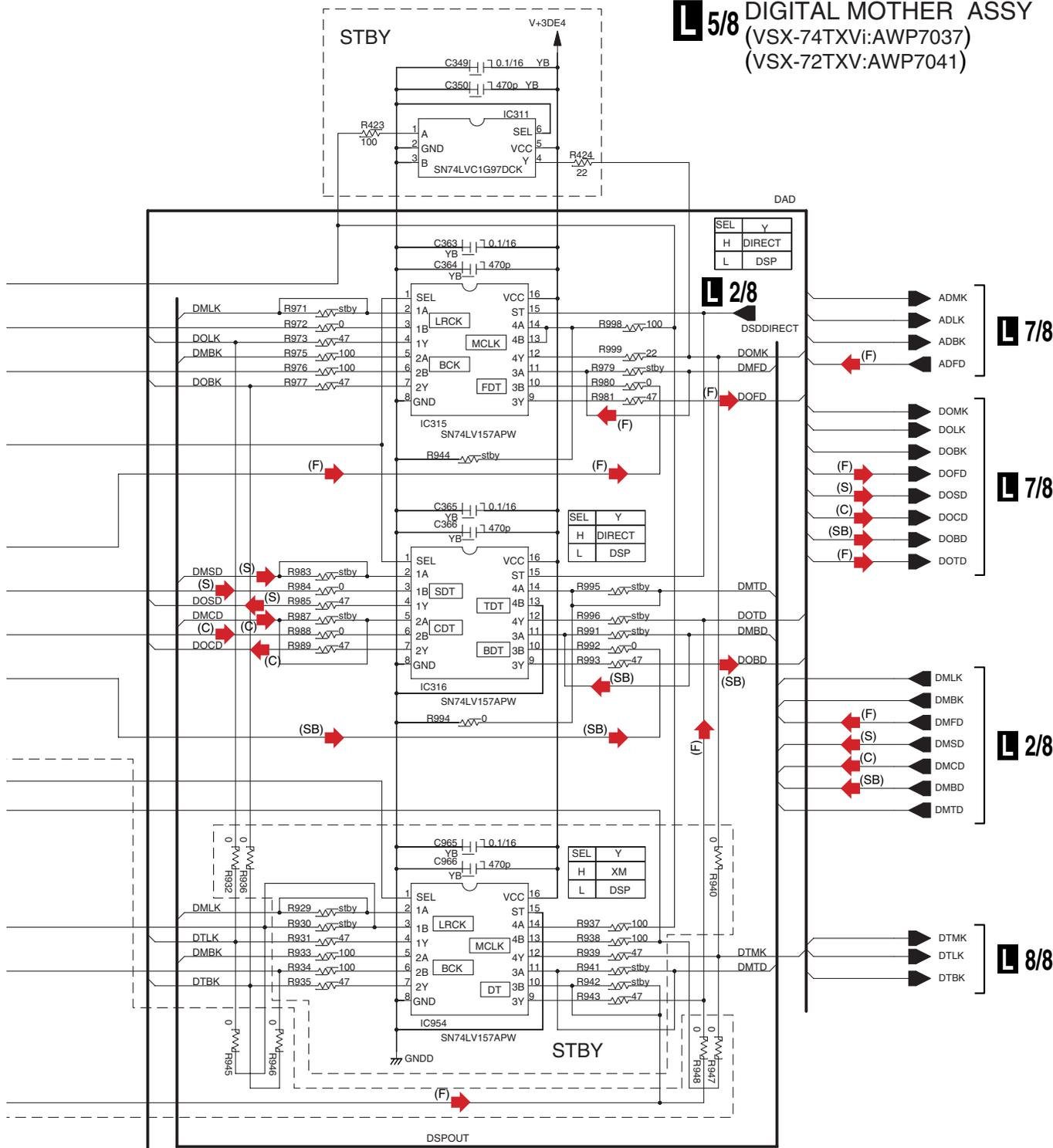

ADMK  
ADLK  
ADBK  
ADFD

(F) : AUDIO SIGNAL ROUTE(F)  
(C) : AUDIO SIGNAL ROUTE(C)  
(S) : AUDIO SIGNAL ROUTE(S)  
(SB) : AUDIO SIGNAL ROUTE(SB)

—NOTE—  
1.RESISTORS  
Unit: k-k, M-M or unless otherwise noted.  
Rated power: 1/16W unless otherwise noted.  
Tolerance: (J) 5% unless otherwise noted.  
2.CAPACITORS  
Unit: p-pF or μF unless otherwise noted.  
Ratings: Capacity(μF)/Voltage(V) unless otherwise noted.  
Rated Voltage: 50V expect for electrolytic capacitors.  
AT:CEAT AL:CEAL

A  
B  
C  
D  
E  
F

L 7/8

L 7/8, 8/8

L 2/8

L 8/8



**L 6/8** DIGITAL MOTHER ASSY  
 (VSX-74TXVi:AWP7037)  
 (VSX-72TXV:AWP7041)

A

B

C

D

E

F

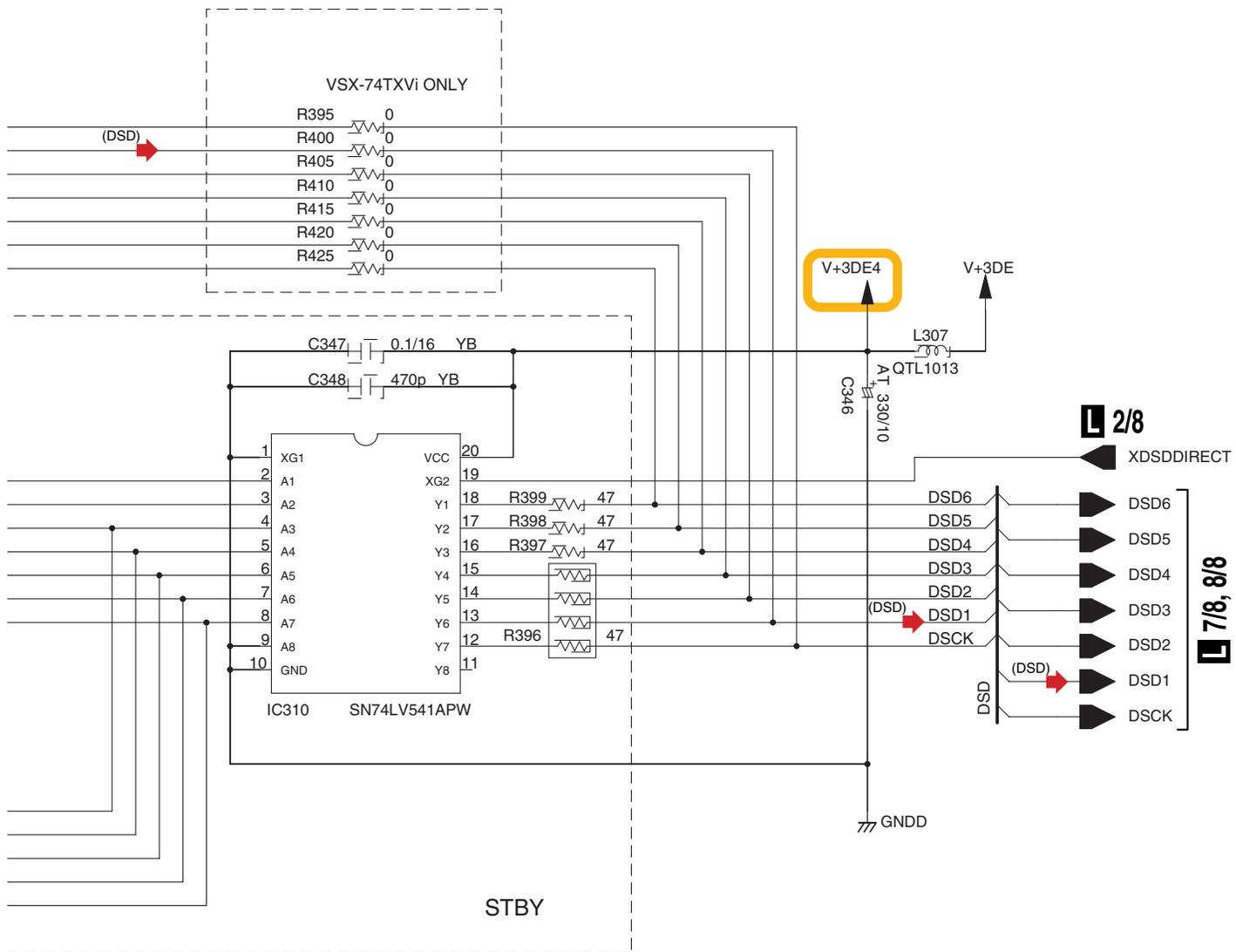

(DSD) → : AUDIO SIGNAL ROUTE(DSD)

# 3.19 DIGITAL MOTHER ASSY (7/8)

A  
B  
C  
D  
E  
F

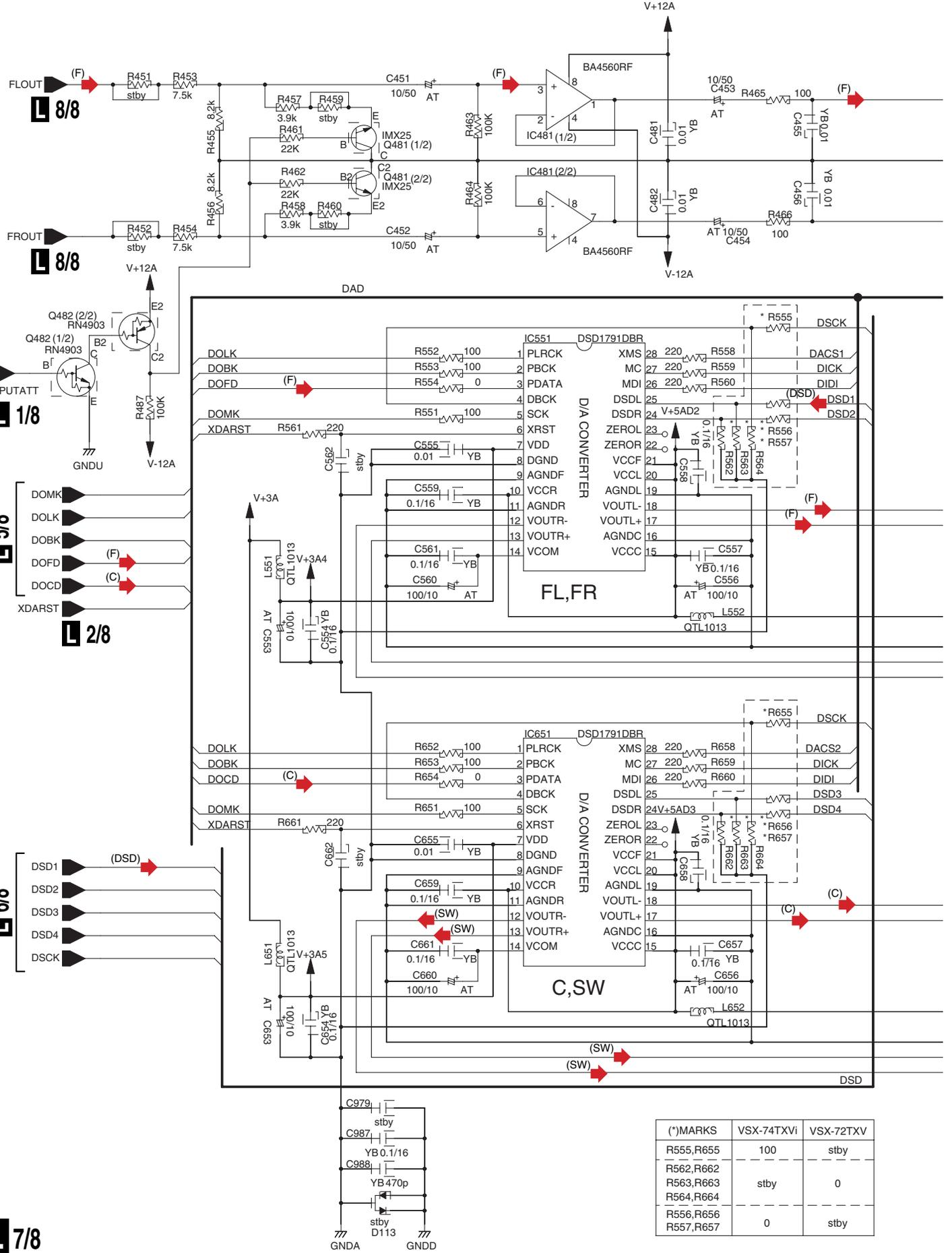

(*)MARKS	VSX-74TXVi	VSX-72TXV
R555,R655	100	stby
R562,R662		
R563,R663	stby	0
R564,R664		
R556,R656		
R557,R657	0	stby

**L7/8** DIGITAL MOTHER ASSY  
 (VSX-74TXVi:AWP7037)  
 (VSX-72TXV:AWP7041)

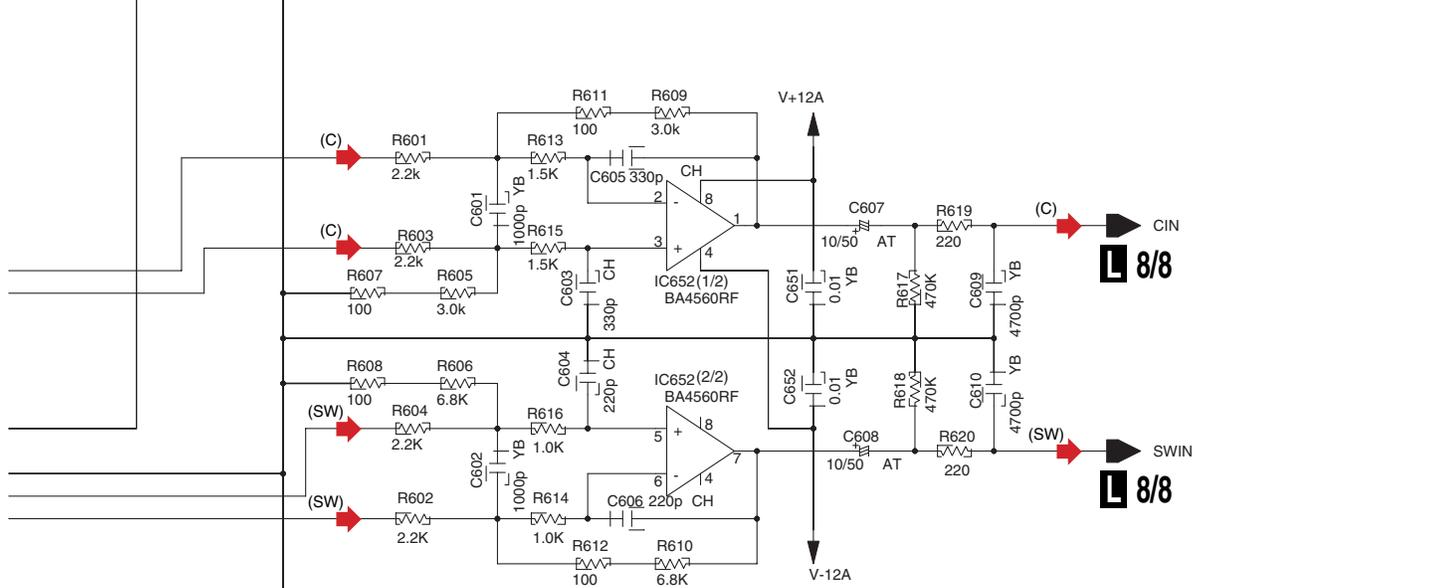
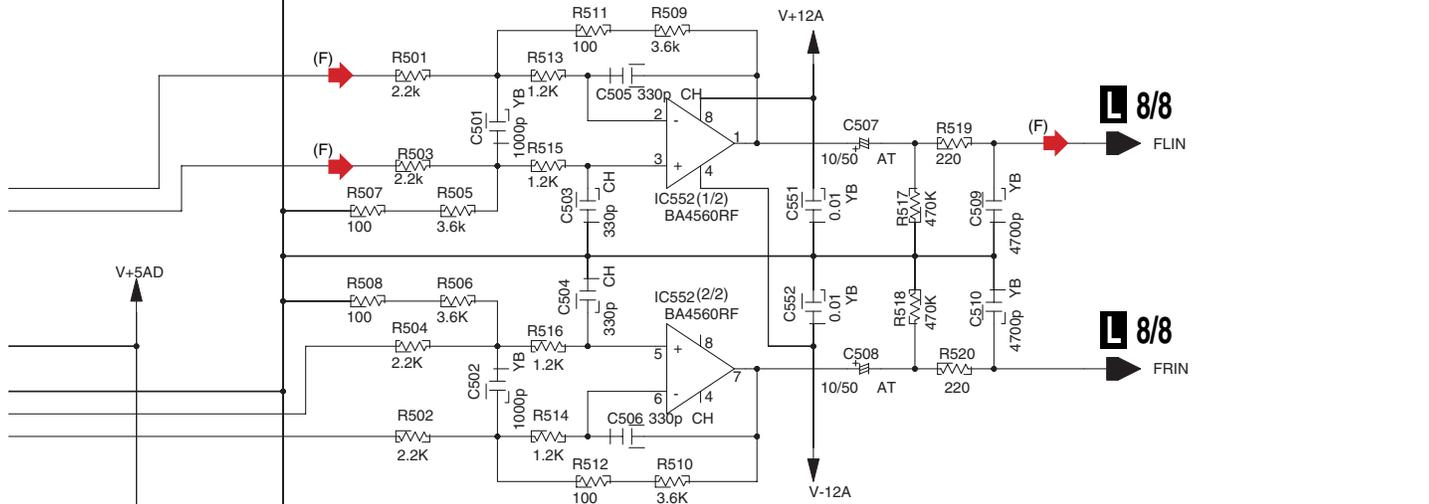
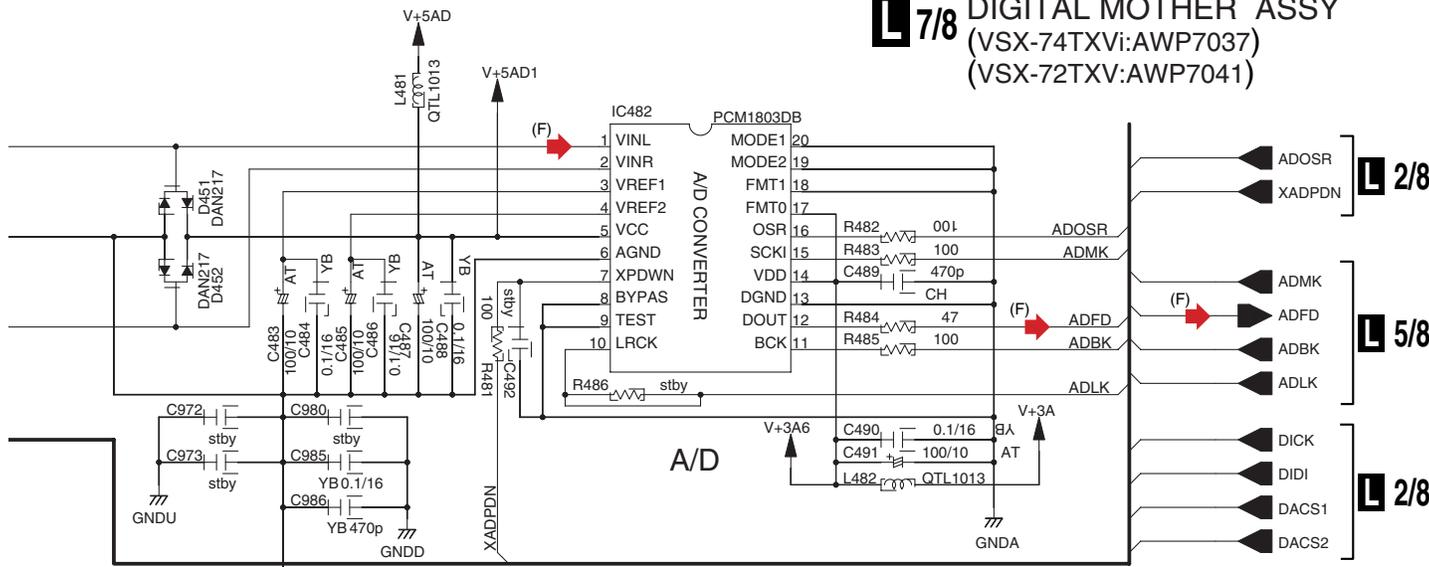

(F) : AUDIO SIGNAL ROUTE(F)      (SW) : AUDIO SIGNAL ROUTE(SW)  
 (C) : AUDIO SIGNAL ROUTE(C)      (DSD) : AUDIO SIGNAL ROUTE(DSD)

# 3.20 DIGITAL MOTHER ASSY (8/8)

1

2

3

4

A

L 6/8

L 5/8

L 2/8

L 5/8

C

D

E

F

(*)MARKS	VSX-74TXVi	VSX-72TXV
R755	100	stby
R762,R763	stby	0
R764	0	stby
R756,R757	0	stby

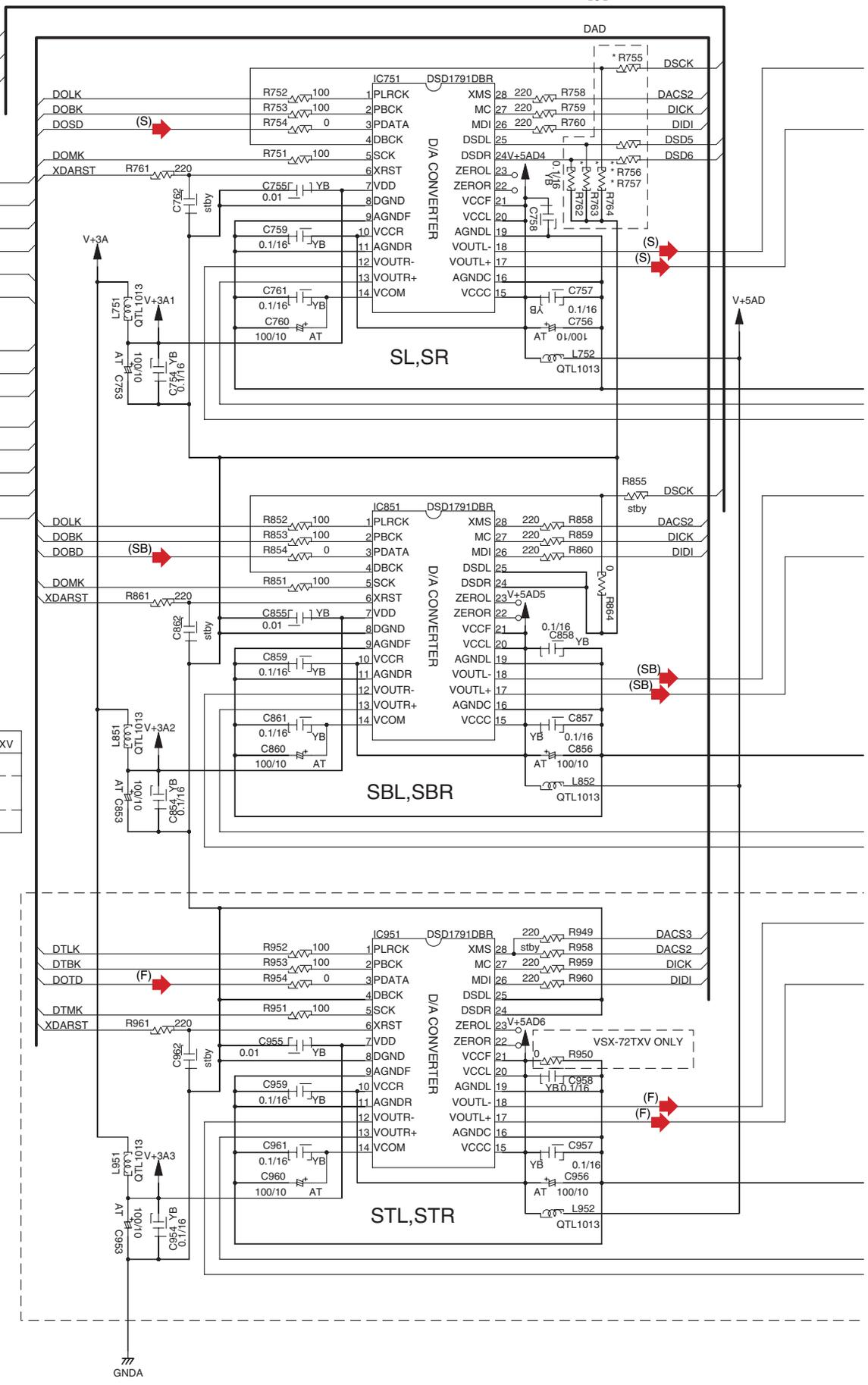

L 8/8

1

2

3

4



**L 8/8** DIGITAL MOTHER ASSY  
 (VSX-74TXVi:AWP7037)  
 (VSX-72TXV:AWP7041)

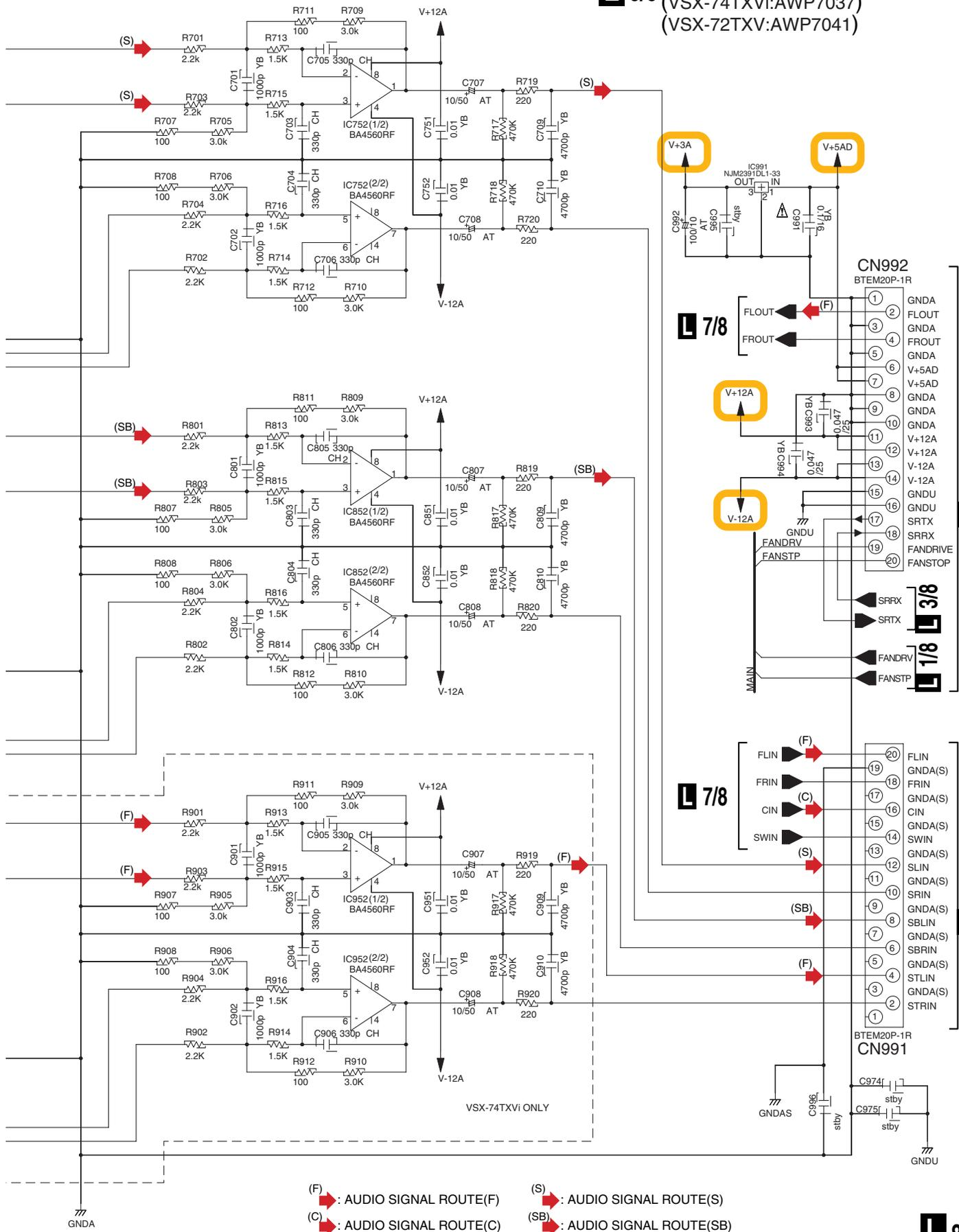

(F) : AUDIO SIGNAL ROUTE(F)  
 (C) : AUDIO SIGNAL ROUTE(C)  
 (S) : AUDIO SIGNAL ROUTE(S)  
 (SB) : AUDIO SIGNAL ROUTE(SB)

A  
B  
C  
D  
E  
F

**L 7/8**

**L 3/8**

**L 7/8**

**L 8/8**

# 3.21 DSP ASSY (1/2)

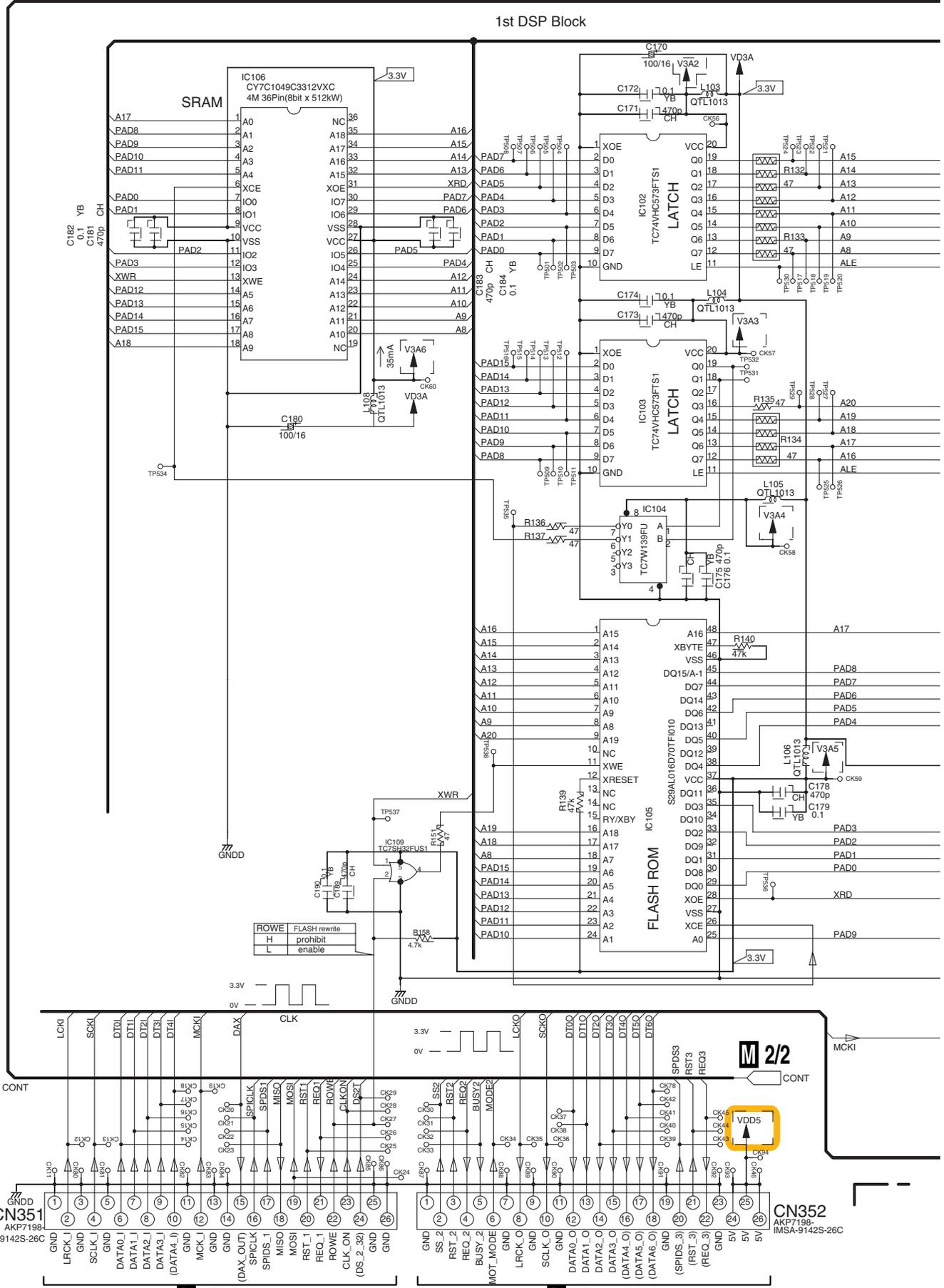

A  
B  
C  
D  
E  
F

M 1/2

L 2/8 CN301

L 2/8 CN302

VSX-74TXvi

# M 1/2 DSP ASSY (AWX8599)

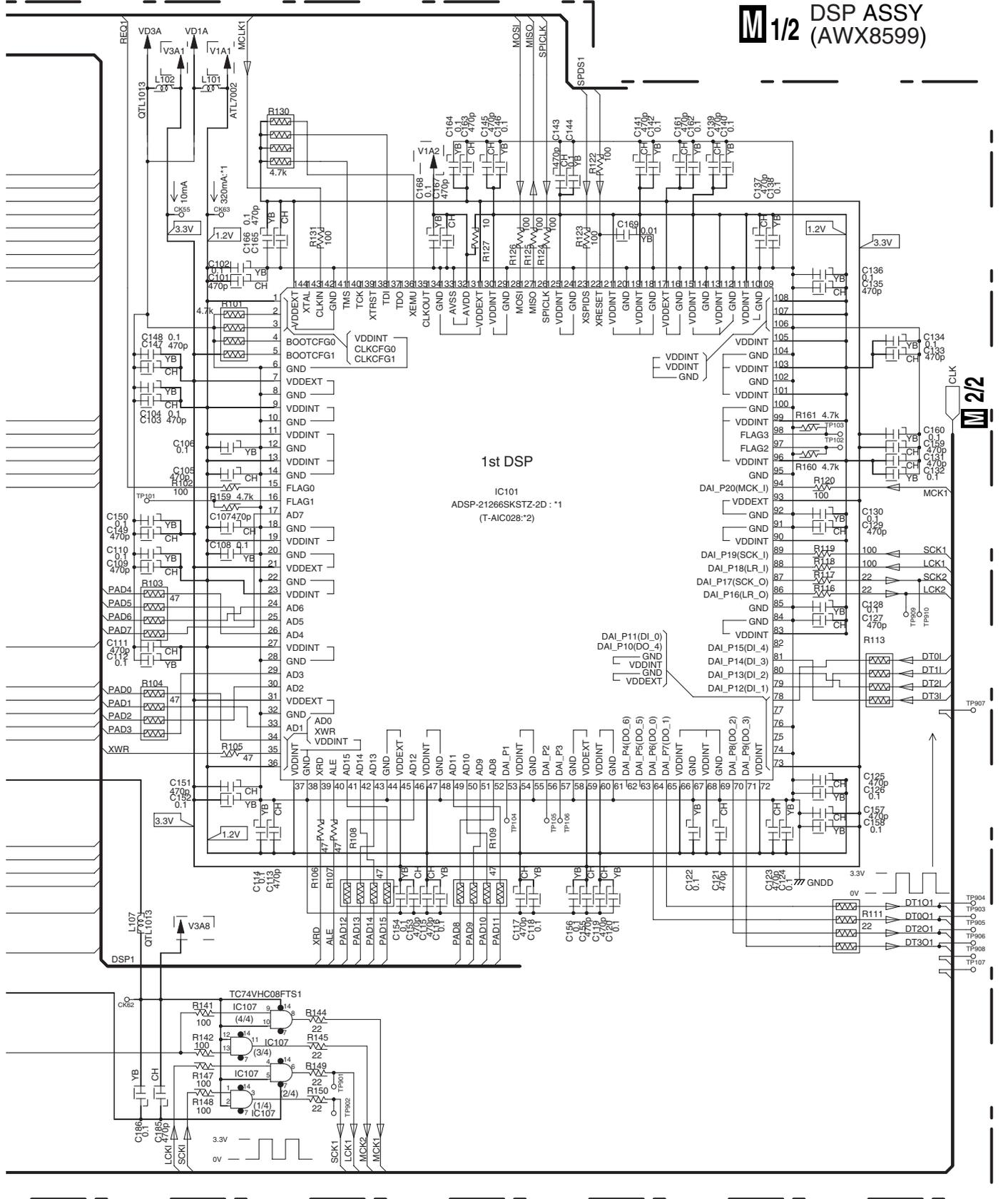

A  
B  
C  
D  
E  
F

# 3.22 DSP ASSY (2/2)

CONT

CLK

DSP MCK ON/OFF Logic			
CLKON	AMX6899	AMX6800	
H	OFF	ON	ON
L	ON	OFF	OFF

CLKON

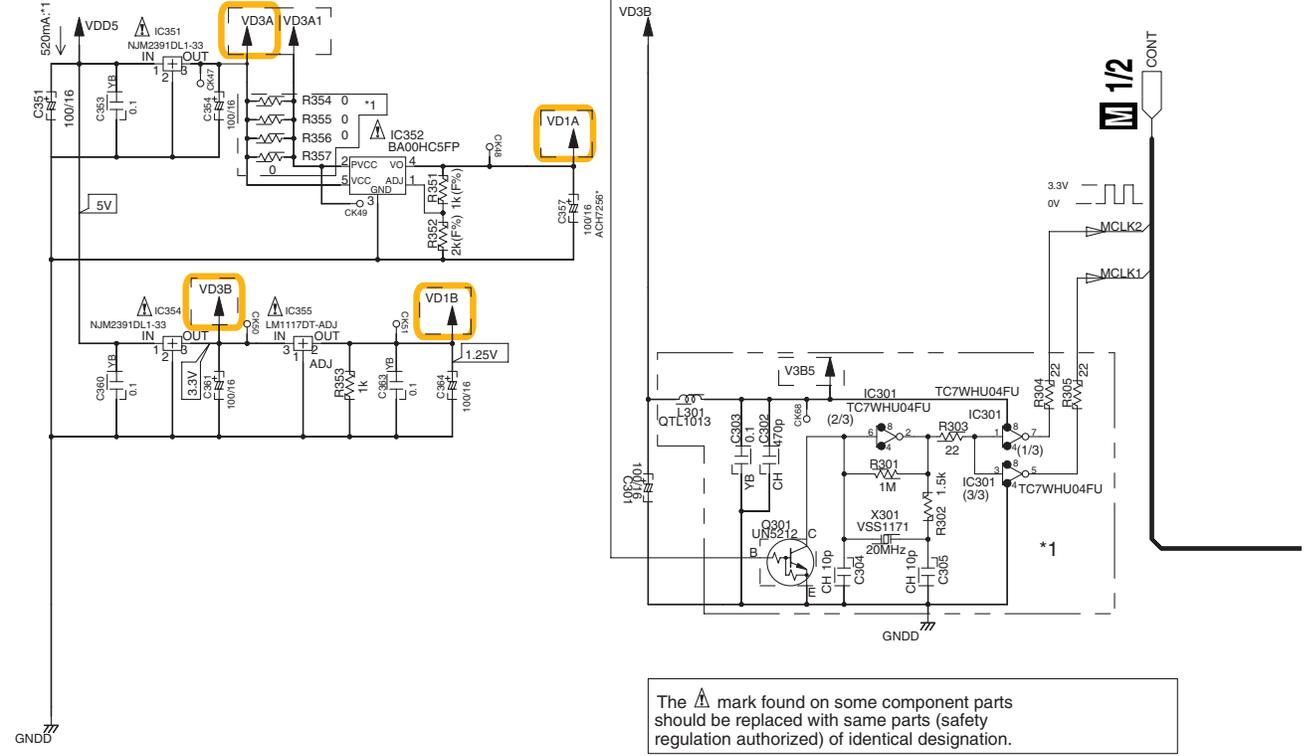

The  $\Delta$  mark found on some component parts should be replaced with same parts (safety regulation authorized) of identical designation.

M 2/2

# M 2/2 DSP ASSY (AWX8599)

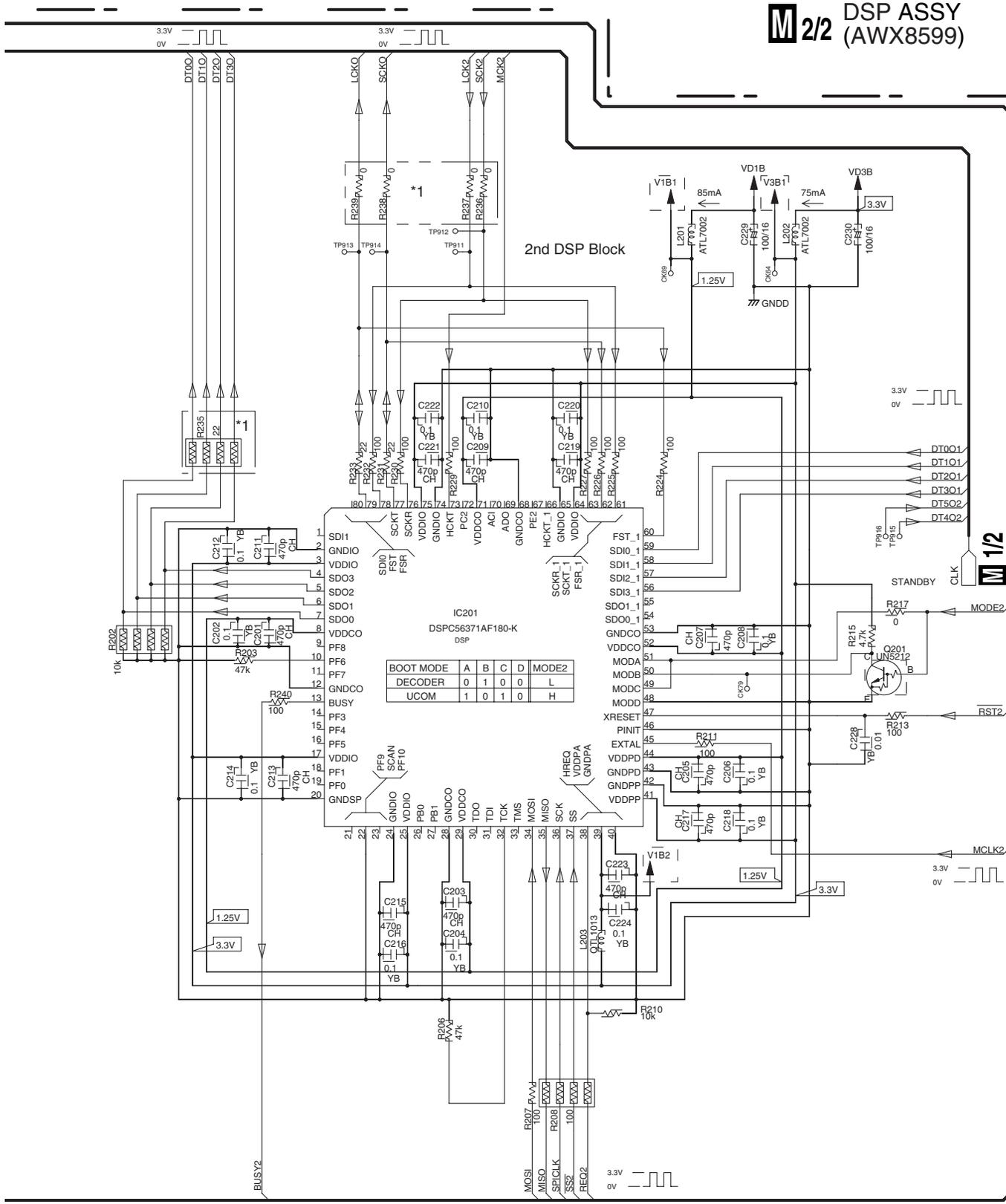

NOTES:  
 NO INDICATED PARTS IS...  
 [Symbol] CCSRCH\*\*\*50-T  
 [Symbol] CKSRYB103K50-T  
 [Symbol] CKSRYB104K16-T  
 [Symbol] CEVW101M\*\*TRB  
 [Symbol] RS1/16S\*\*\*J-T  
 [Symbol] RAB4C\*\*\*J-T  
 UNLESS OTHERWISE NOTED

# 3.23 INTERFACE ASSY

## INTERFACE ASSY (AWX8651)

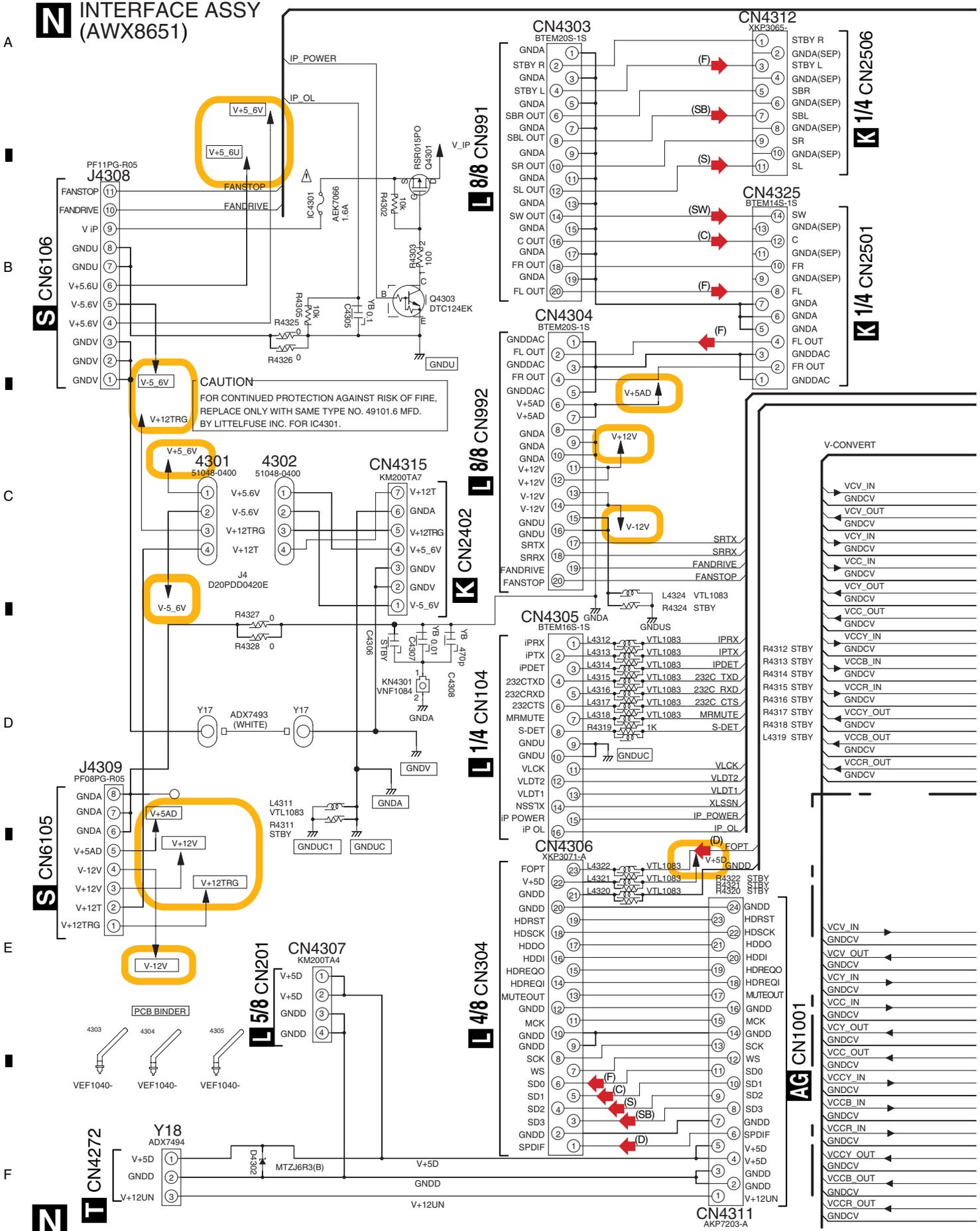

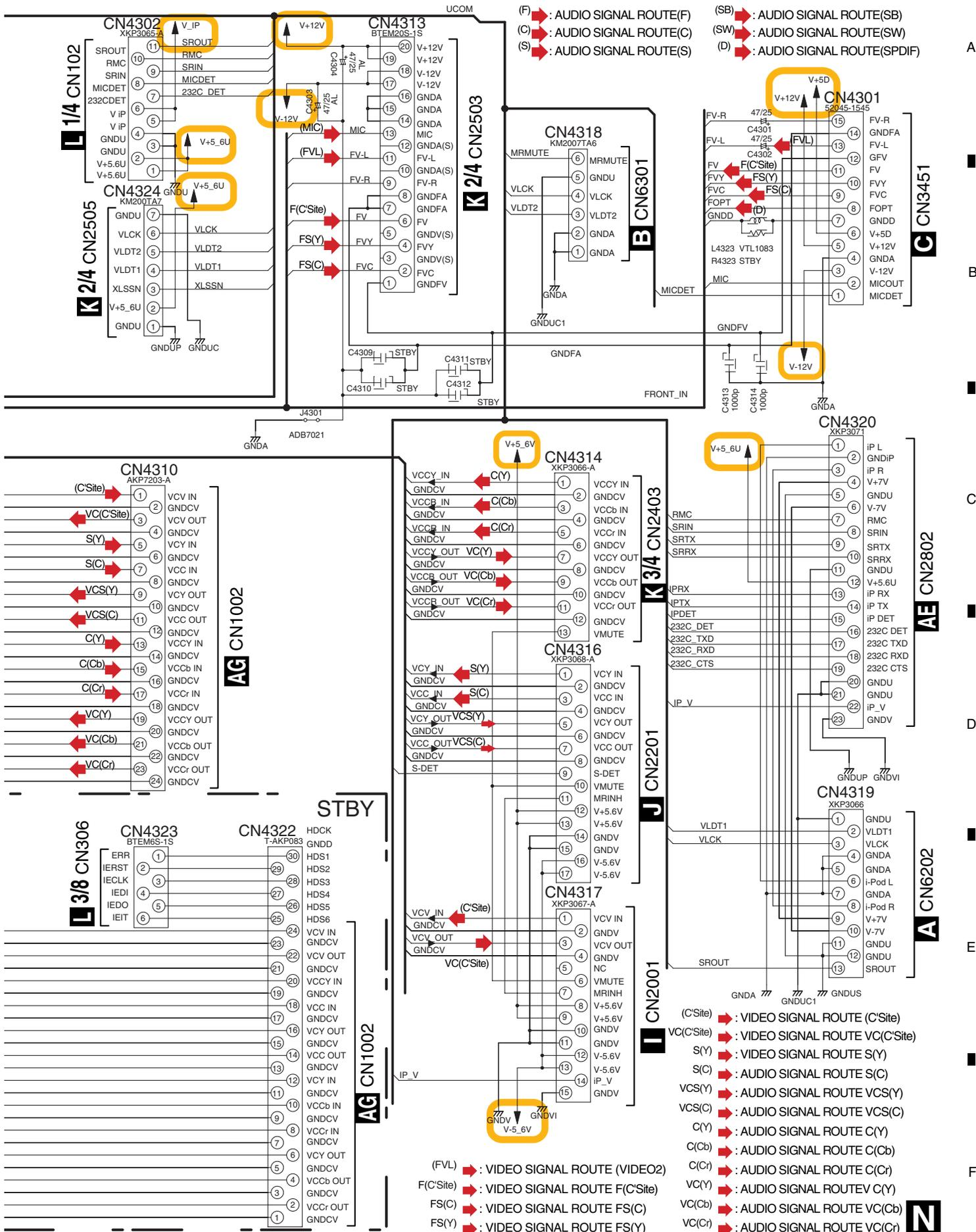

# 3.24 POWER AMP IN and POWER PROTECT ASSYS

A  
B  
C  
D  
E  
F

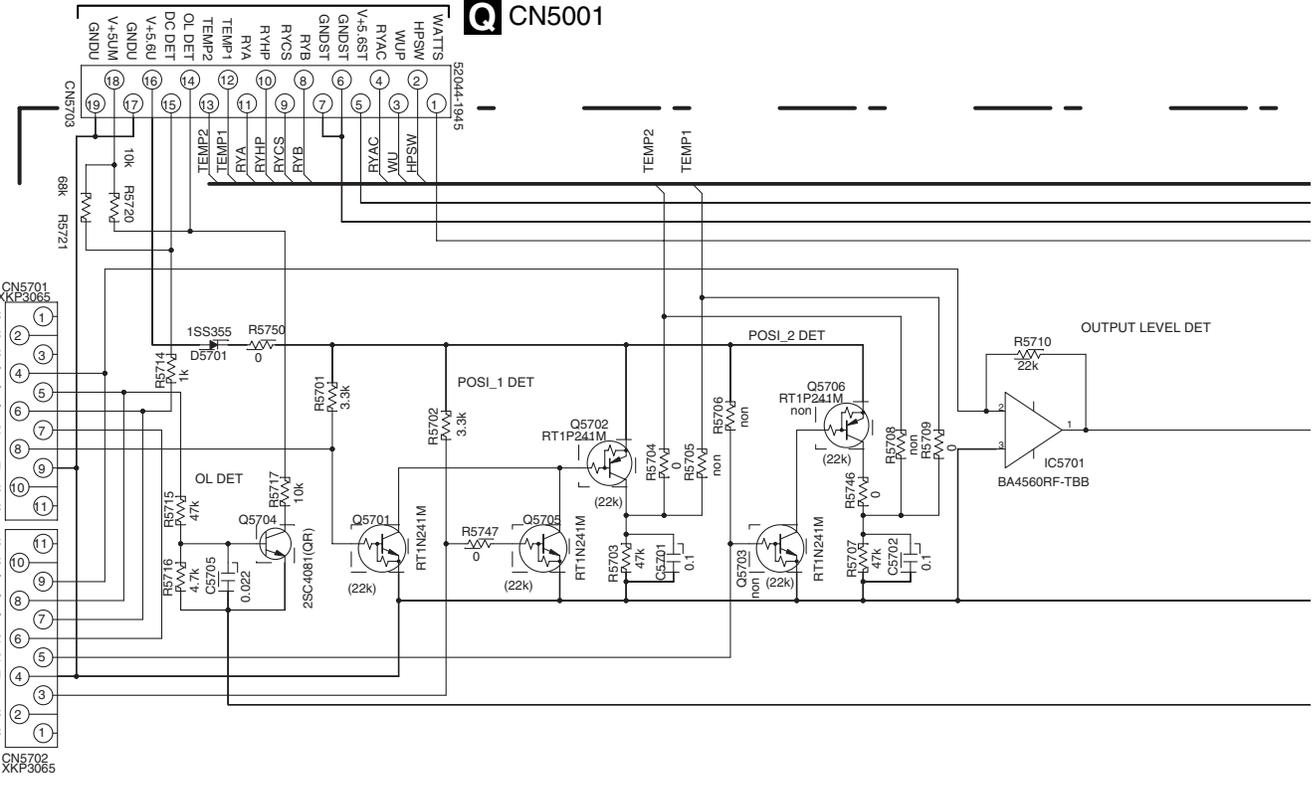
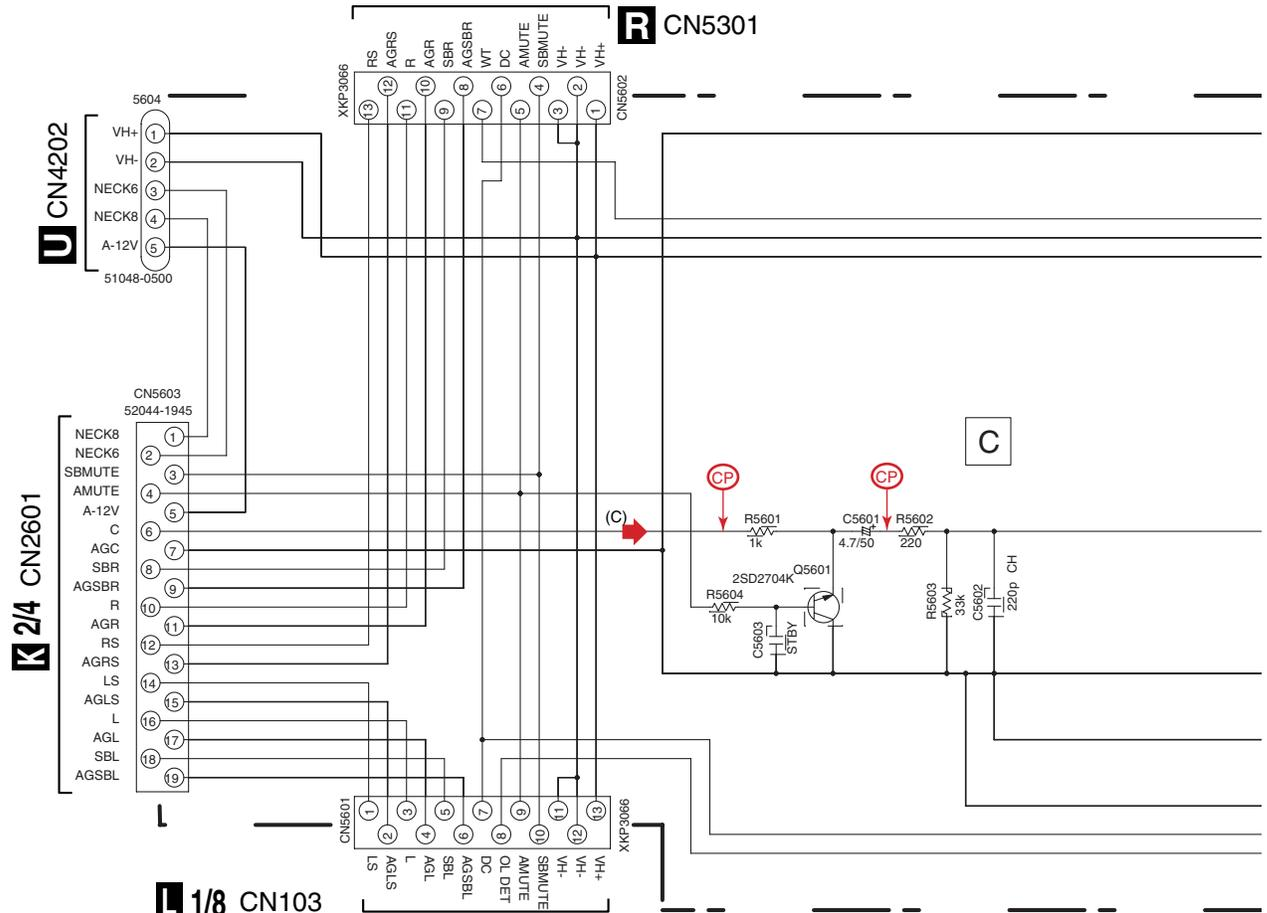

1 2 3 4



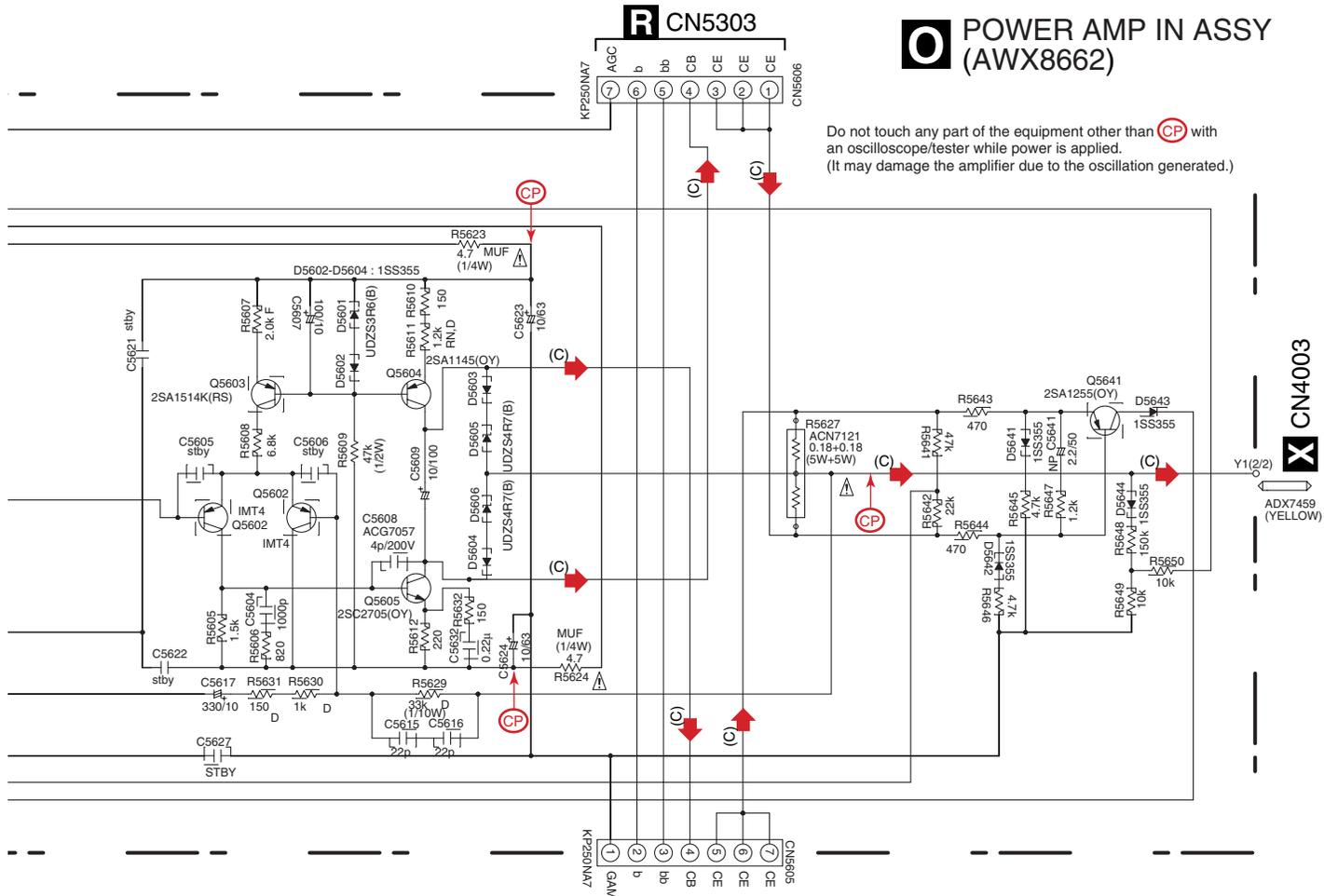

**O POWER AMP IN ASSY (AWX8662)**

Do not touch any part of the equipment other than **CP** with an oscilloscope/tester while power is applied. (It may damage the amplifier due to the oscillation generated.)

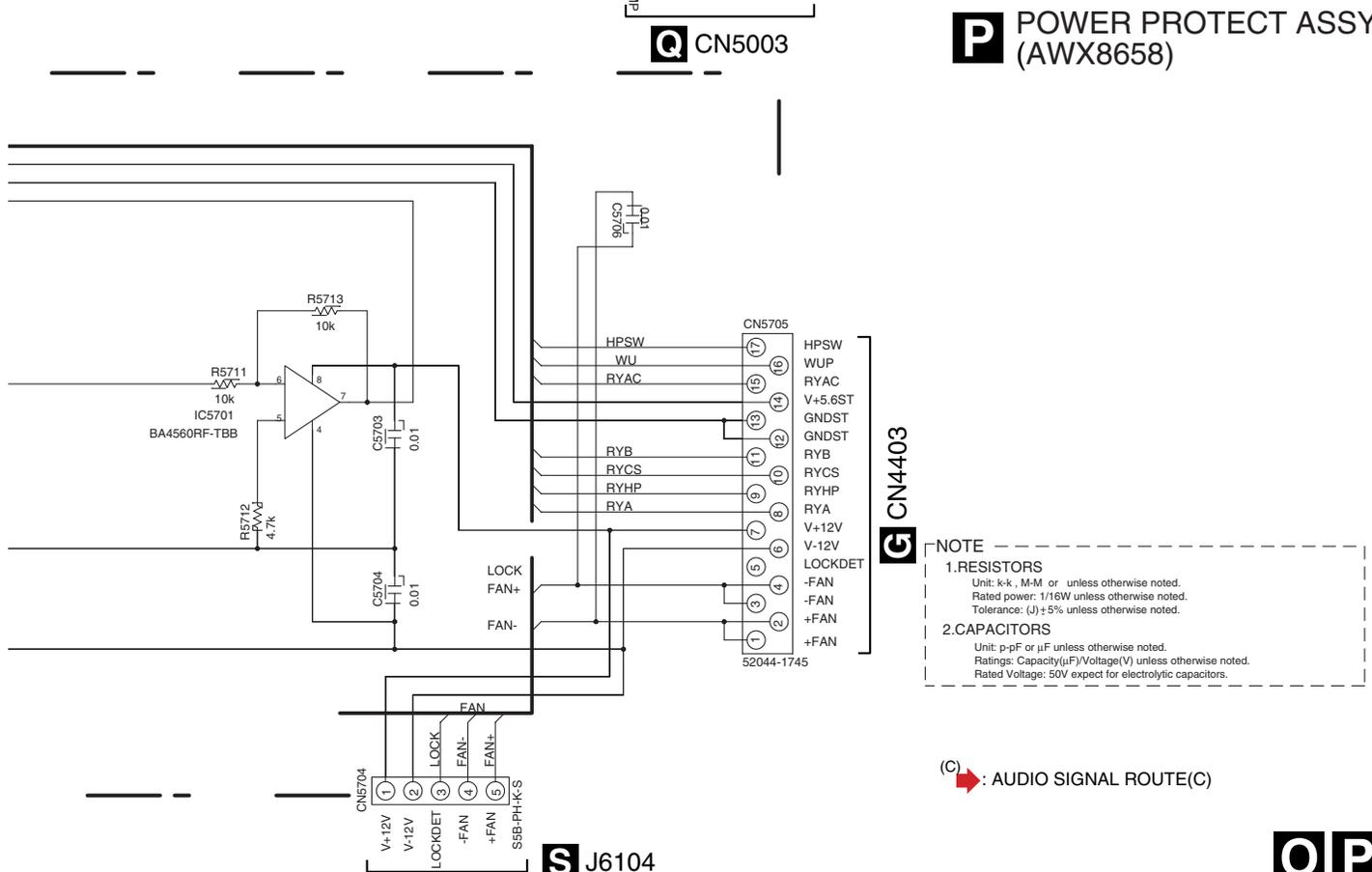

**P POWER PROTECT ASSY (AWX8658)**

**NOTE**  
**1.RESISTORS**  
 Unit: k-k, M-M or unless otherwise noted.  
 Rated power: 1/16W unless otherwise noted.  
 Tolerance: (J) ±5% unless otherwise noted.  
**2.CAPACITORS**  
 Unit: p-pF or μF unless otherwise noted.  
 Ratings: Capacity(μF)/Voltage(V) unless otherwise noted.  
 Rated Voltage: 50V expect for electrolytic capacitors.

(C) : AUDIO SIGNAL ROUTE(C)

**S J6104**

**G CN4403**

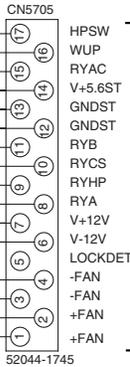

# 3.25 POWER AMP L ASSY

Do not touch any part of the equipment other than (CP) with an oscilloscope/tester while power is applied. (It may damage the amplifier due to the oscillation generated.)

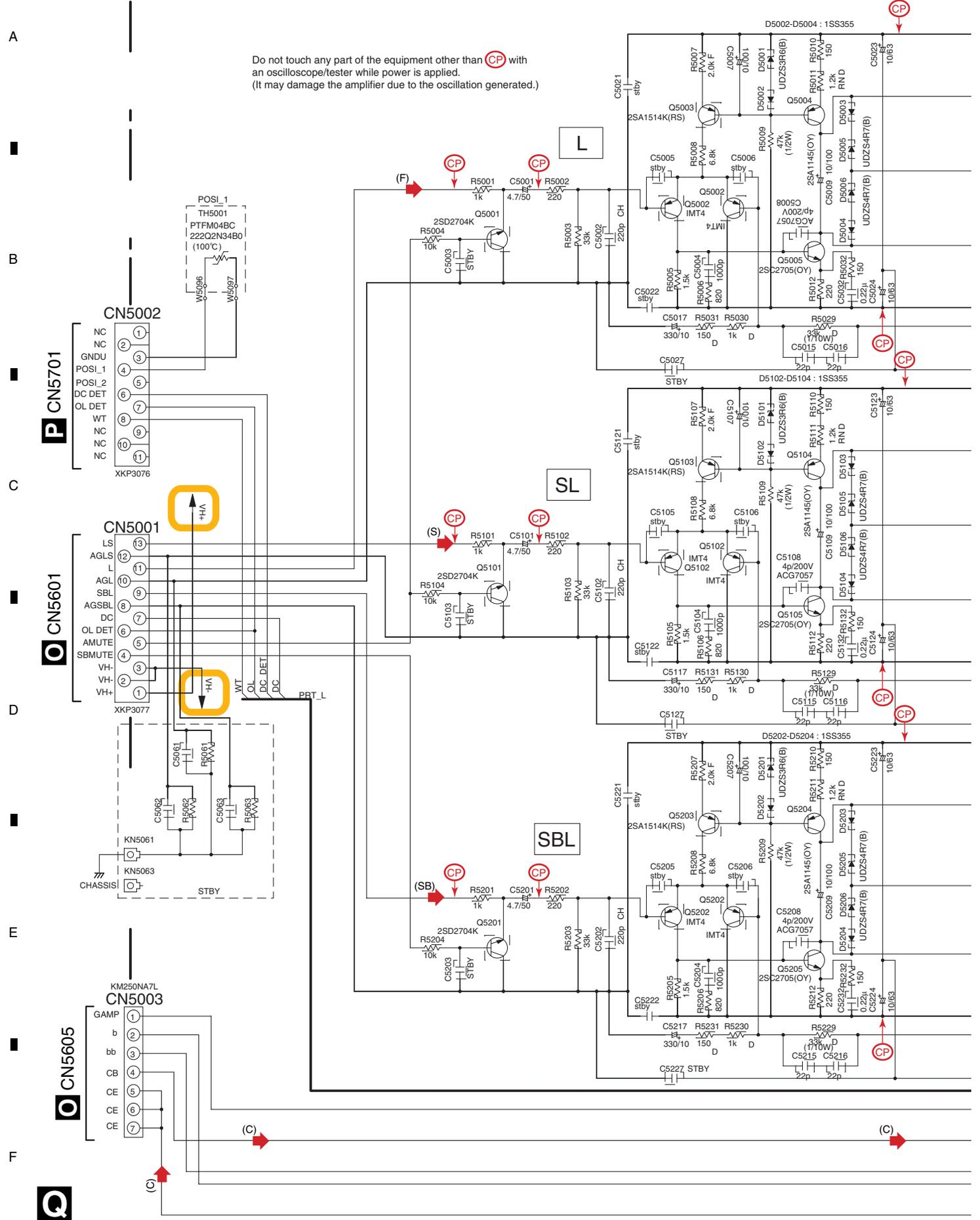

# POWER AMP L ASSY (AWX8654)

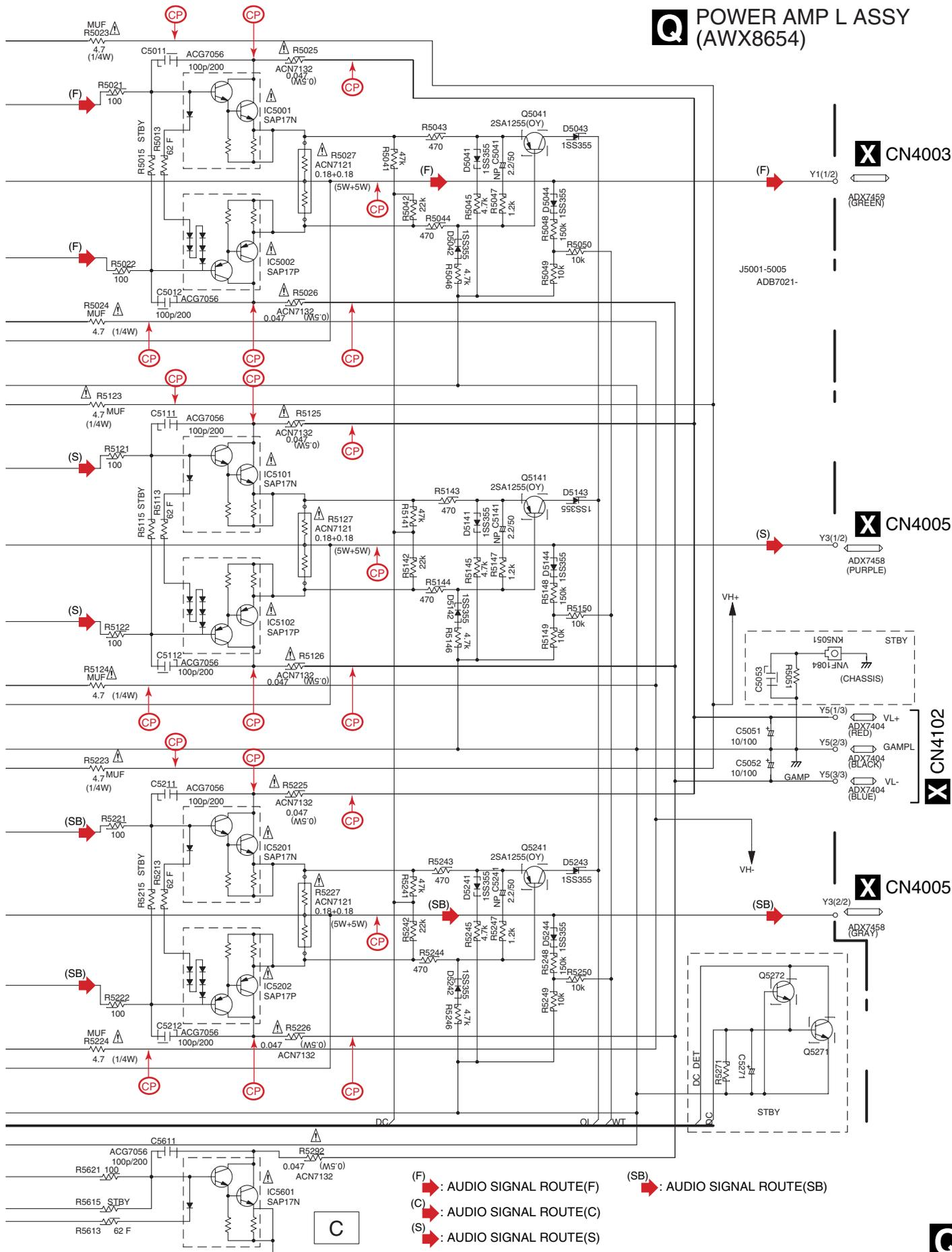

- (F) : AUDIO SIGNAL ROUTE(F)
- (C) : AUDIO SIGNAL ROUTE(C)
- (S) : AUDIO SIGNAL ROUTE(S)
- (SB) : AUDIO SIGNAL ROUTE(SB)

C



# 3.26 POWER AMP R ASSY

1 2 3 4

A

B

C

D

E

F

Do not touch any part of the equipment other than CP with an oscilloscope/tester while power is applied. (It may damage the amplifier due to the oscillation generated.)

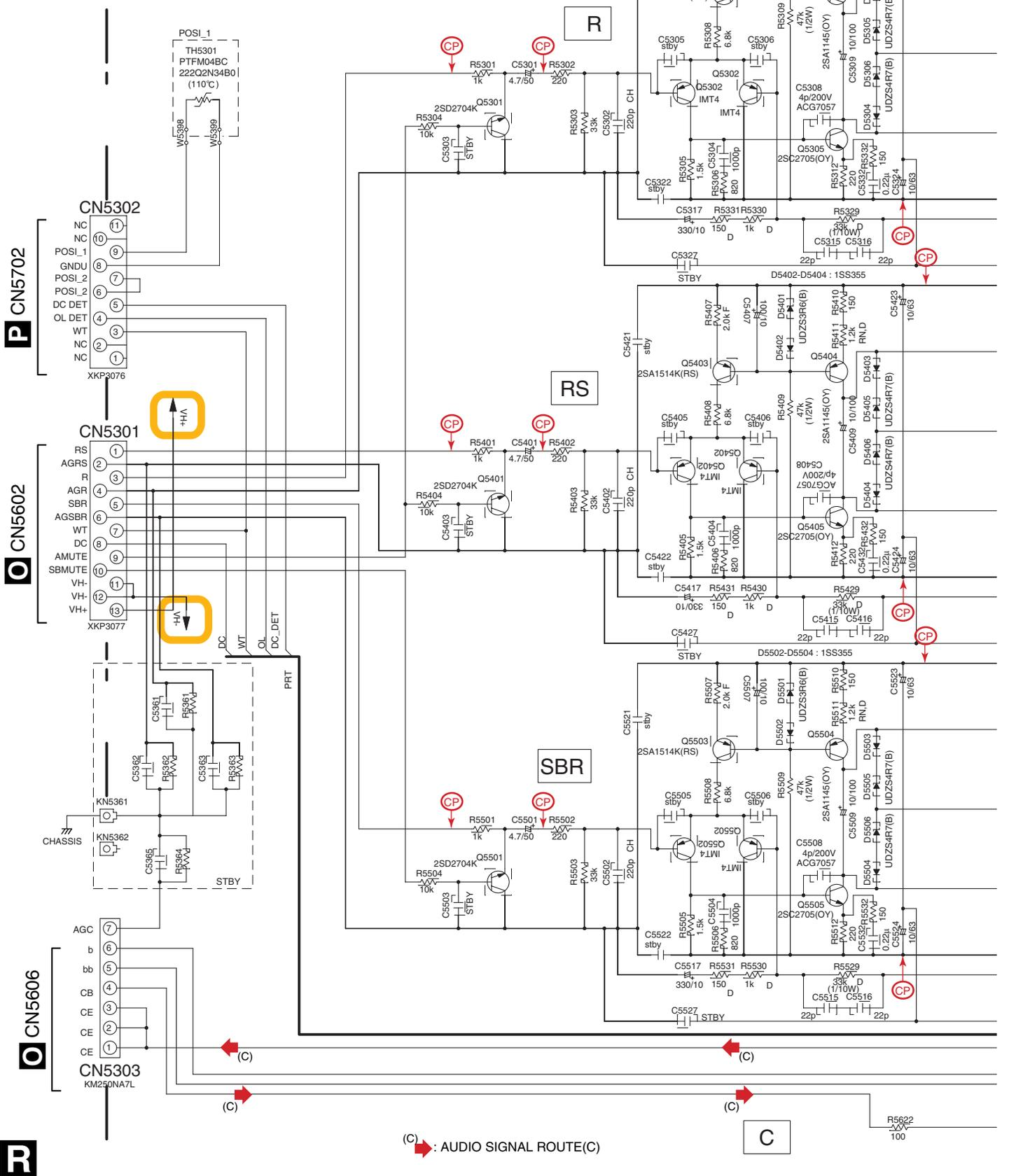

(C) : AUDIO SIGNAL ROUTE(C)

1 2 3 4



# 3.27 LOCAL SUPPLY and DC/DC ASSYS

A  
B  
C  
D  
E  
F

Y J3001

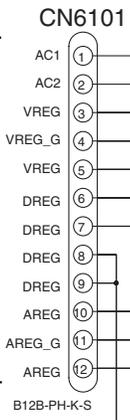

**CAUTION**  
 FOR CONTINUED PROTECTION AGAINST RISK OF FIRE,  
 REPLACE ONLY WITH SAME TYPE NO. 49101.6 MFD.  
 BY LITTELFUSE INC. FOR IC6108.

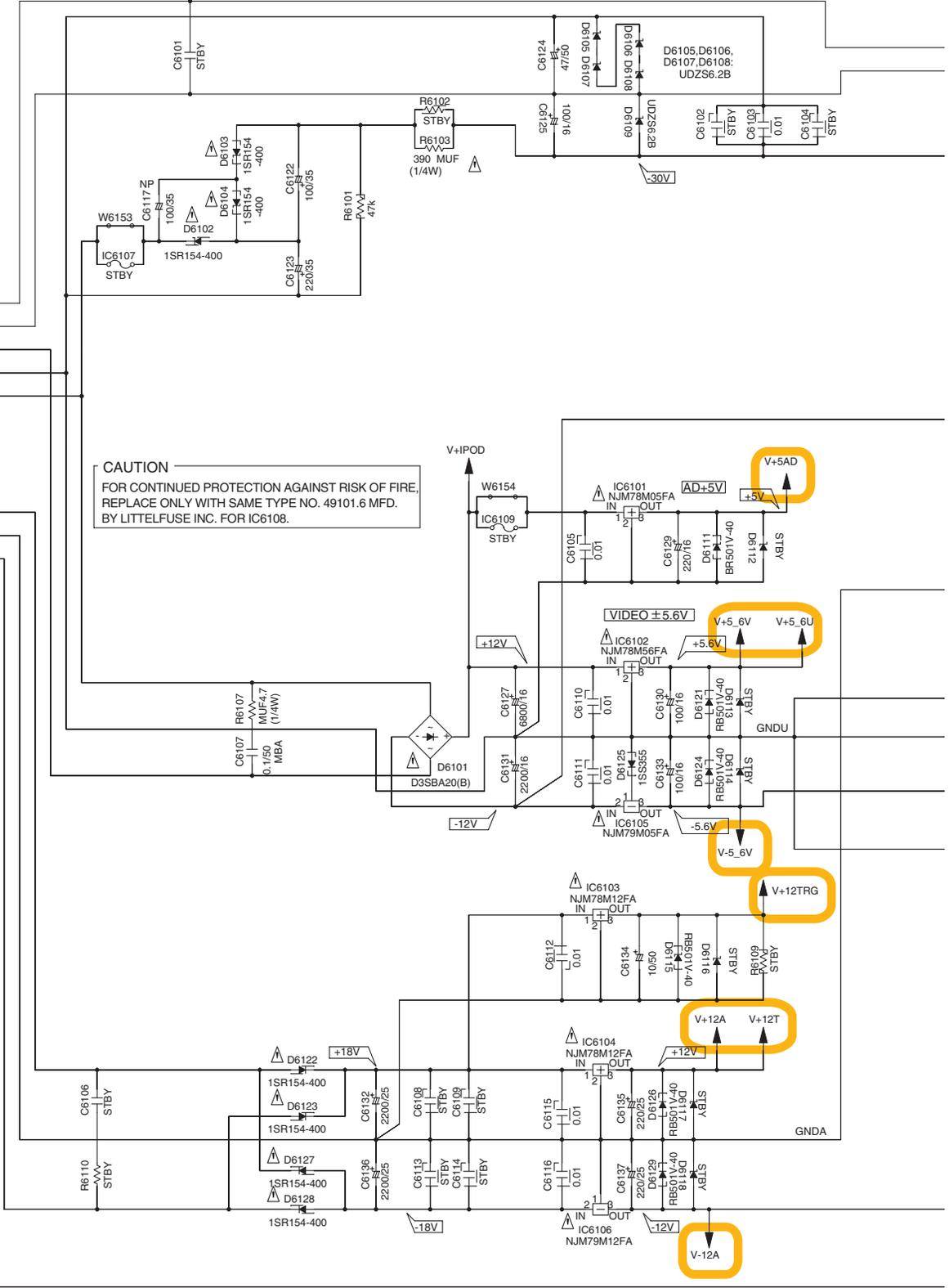

The mark found on some component parts indicates the importance of the safety factor of the part. Therefore, when replacing, be sure to use parts of identical designation.

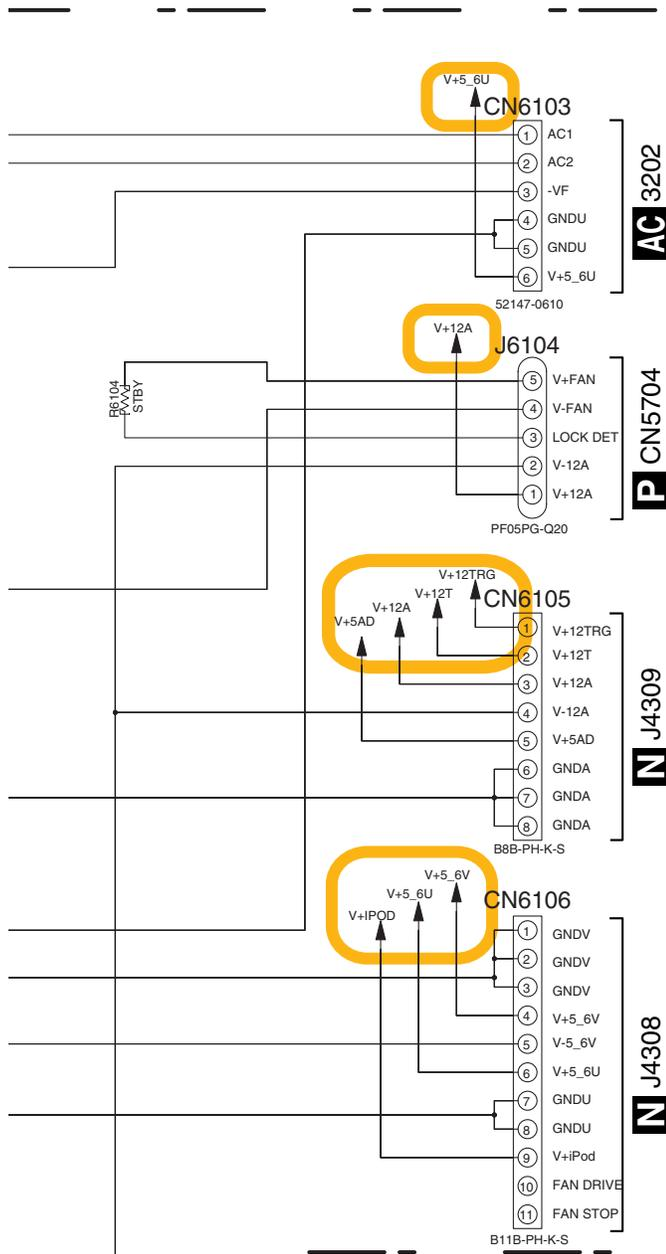

**S** LOCAL SUPPLY ASSY (AWX8671)

NOTE

1. RESISTORS  
 Unit: k-k, M-M or unless otherwise noted.  
 Rated power: 1/16W unless otherwise noted.  
 Tolerance: (J) ±5% unless otherwise noted.

2. CAPACITORS  
 Unit: p-pF or μF unless otherwise noted.  
 Ratings: Capacity(μF)/Voltage(V) unless otherwise noted.  
 Rated Voltage: 50V expect for electrolytic capacitors.

**T** DC/DC ASSY (AWX8650)

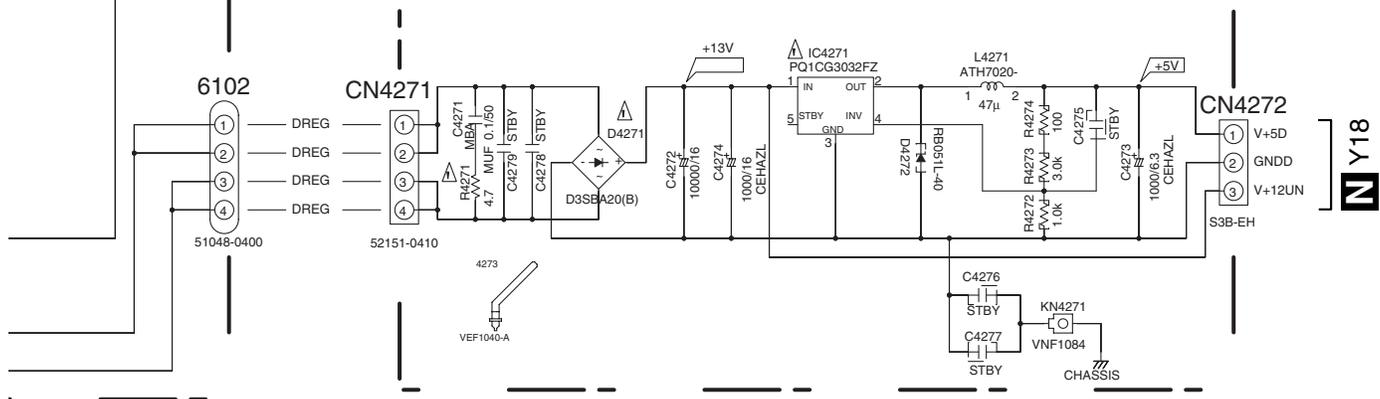





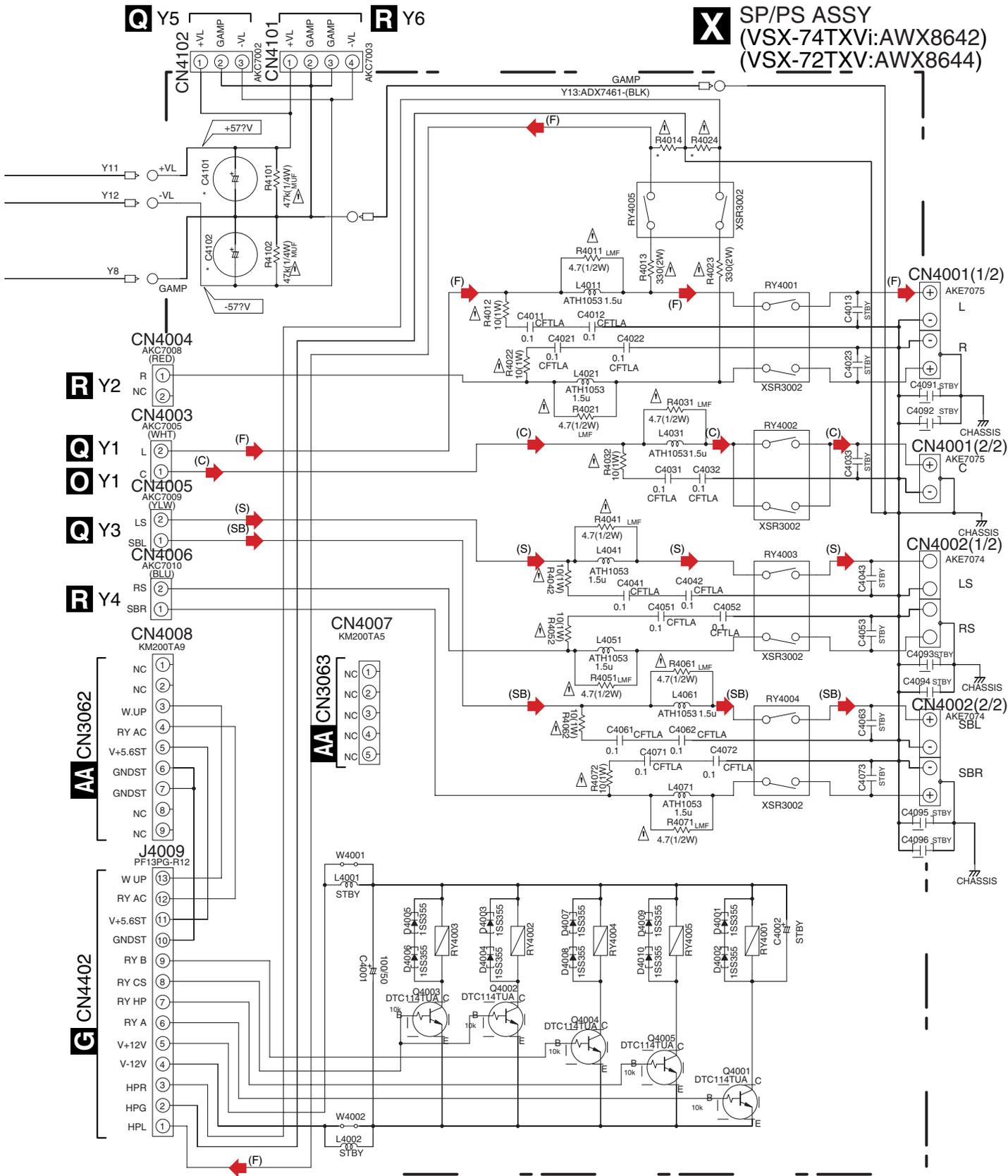

**X** SP/PS ASSY  
 (VSX-74TXVi:AWX8642)  
 (VSX-72TXV:AWX8644)

**PSSP ASSY** \* Mark parts

	VSX-74TXVi	VSX-72TXV
R4014,R4024	STBY	←
C4101,C4102	ACHZ21P (1500071)	ACHZ255 (1000071)

- (F) : AUDIO SIGNAL ROUTE (F)
- (C) : AUDIO SIGNAL ROUTE (C)
- (S) : AUDIO SIGNAL ROUTE (S)
- (SB) : AUDIO SIGNAL ROUTE (SB)



# 3.29 TRANS2-2, TRANS1 and PRIMARY ASSYS

1

2

3

4

A

## Y TRANS2-2 ASSY (AWX8626)

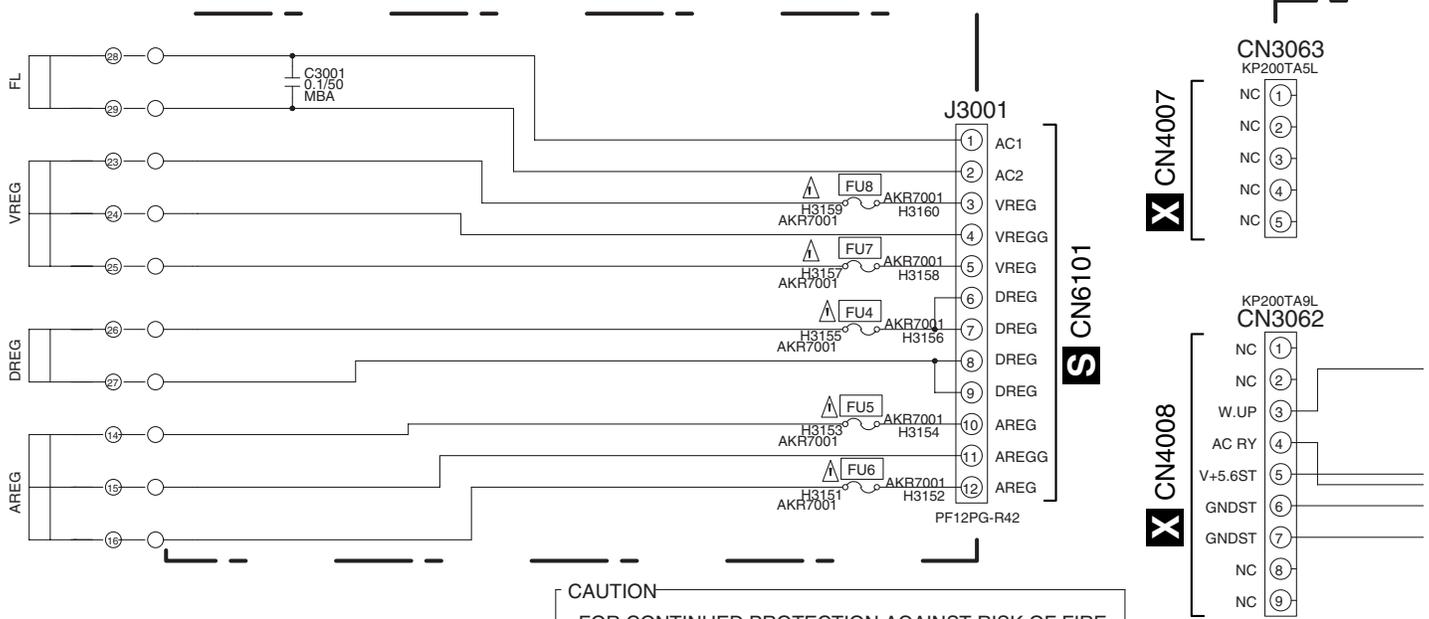

B

C

CAUTION  
FOR CONTINUED PROTECTION AGAINST RISK OF FIRE,  
REPLACE WITH SAME TYPE AND RATINGS OF FUSE.



D

E

F

**Y Z AA**

1

2

3

4

# AA PRIMARY ASSY (AWX8628)

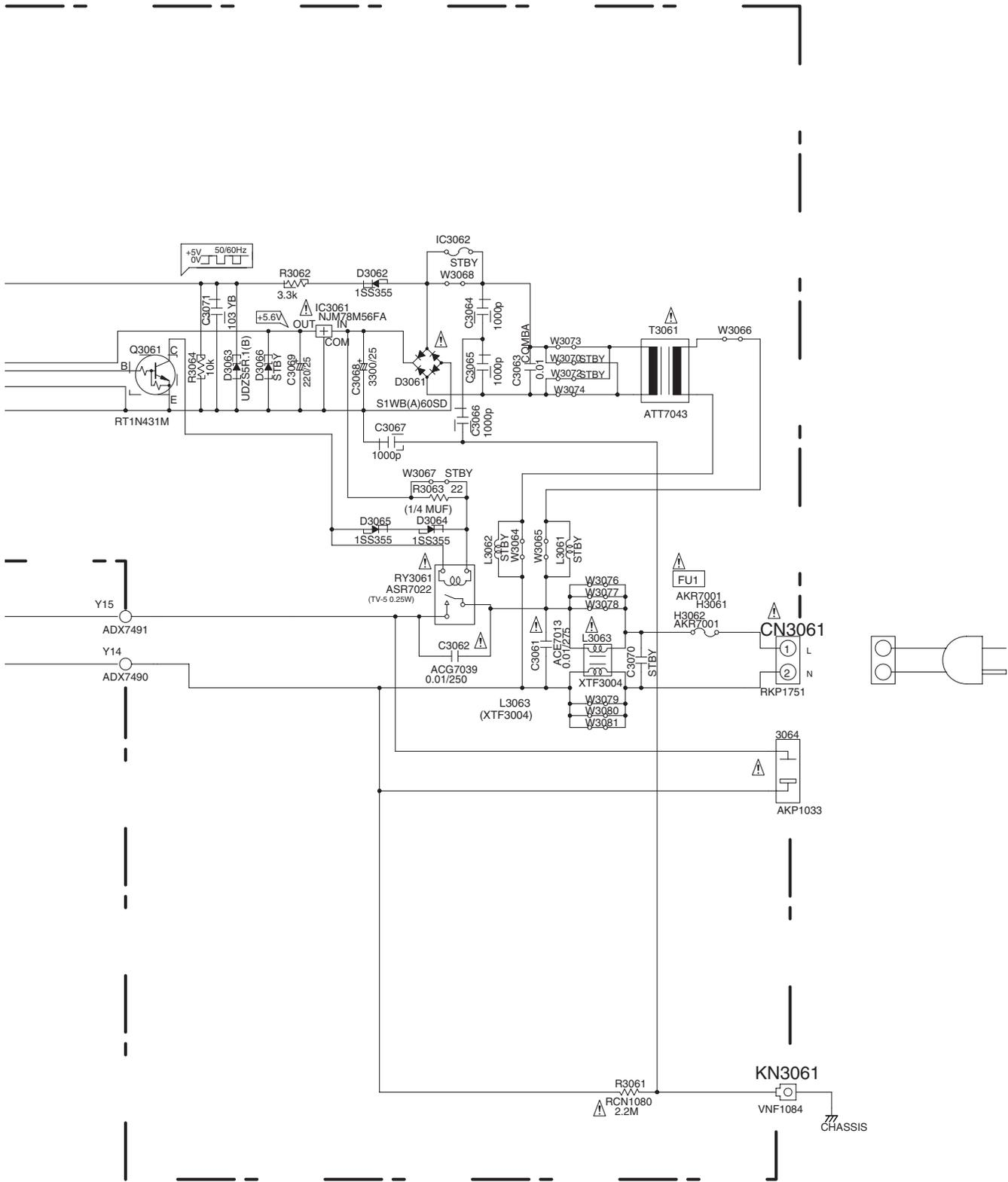

The  mark found on some component parts indicates the importance of the safety factor of the part. Therefore, when replacing, be sure to use parts of identical designation.

# 3.30 VOLUME, DISPLAY and INPUT SELECT ASSYS

## AB VOLUME ASSY(AWX8641)

A

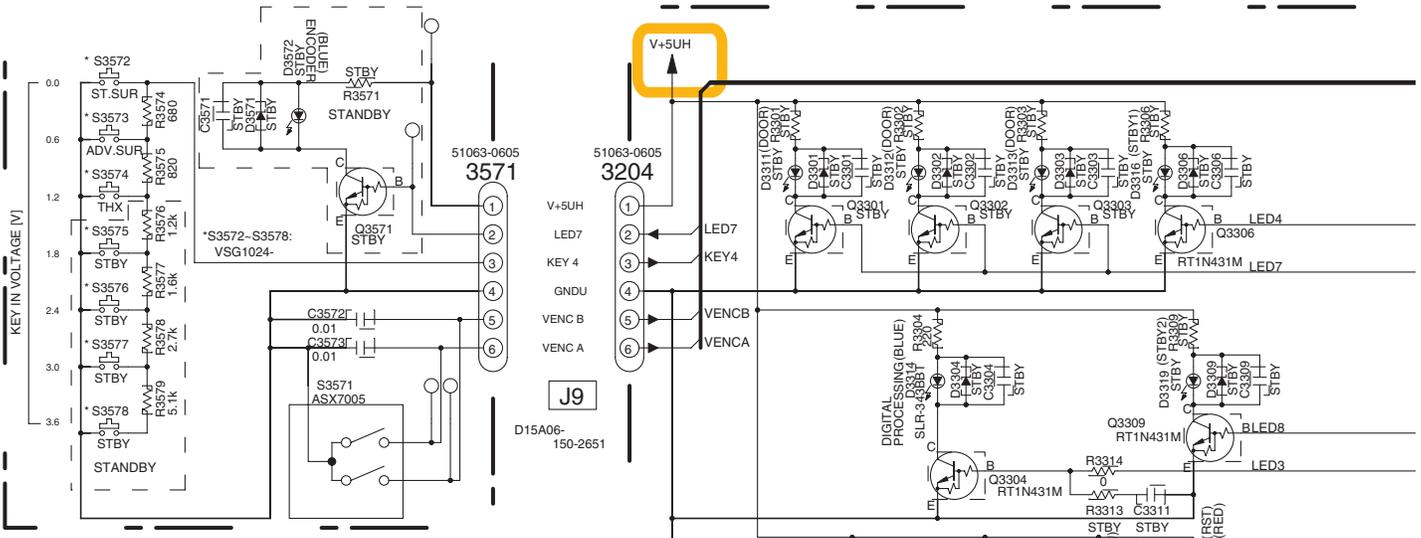

B

C

D

E

F

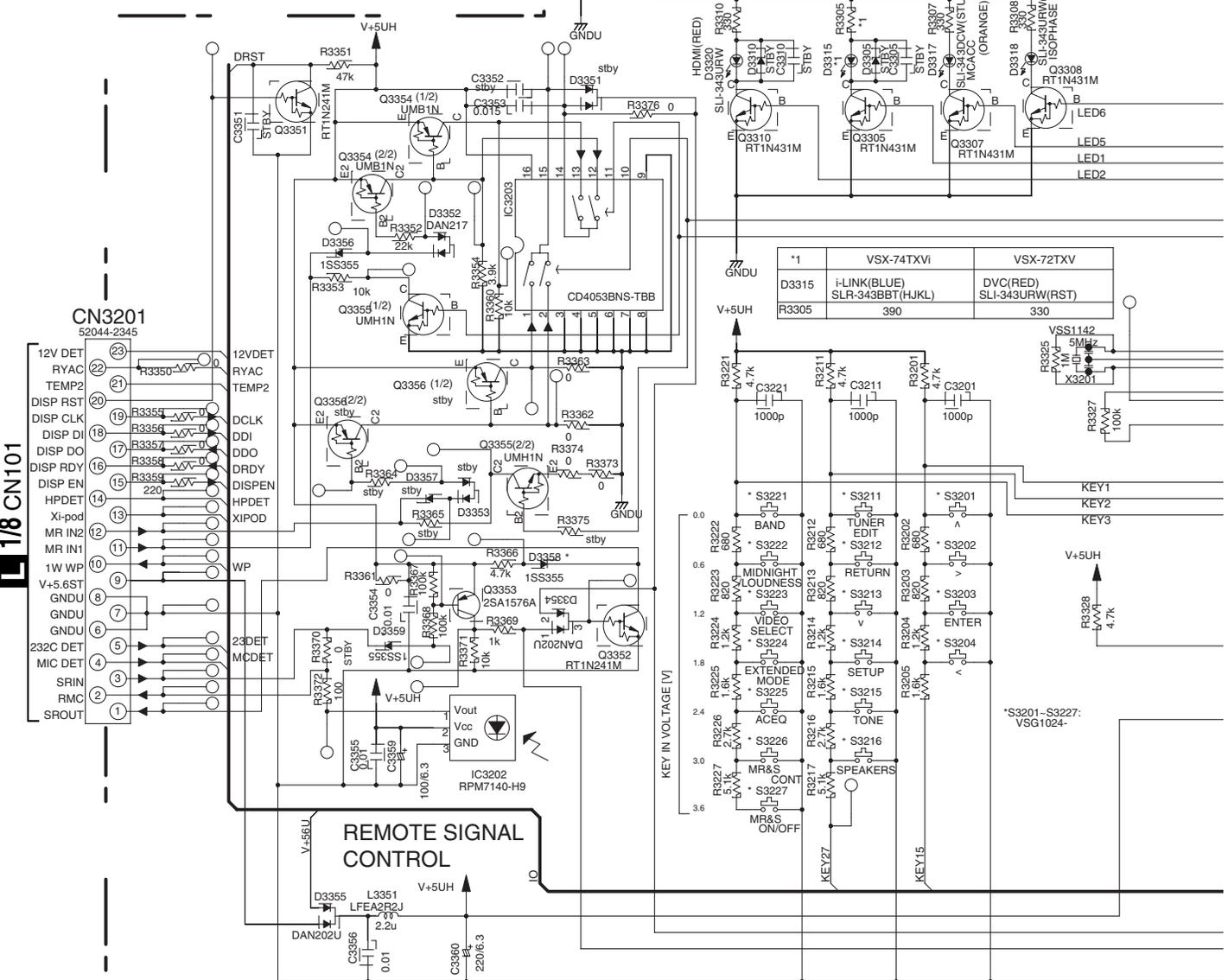

## AB AC

1

2

3

4

**AC** DISPLAY ASSY  
 (VSX-74TXVi:AWX8635)  
 (VSX-72TXV:AWX8636)

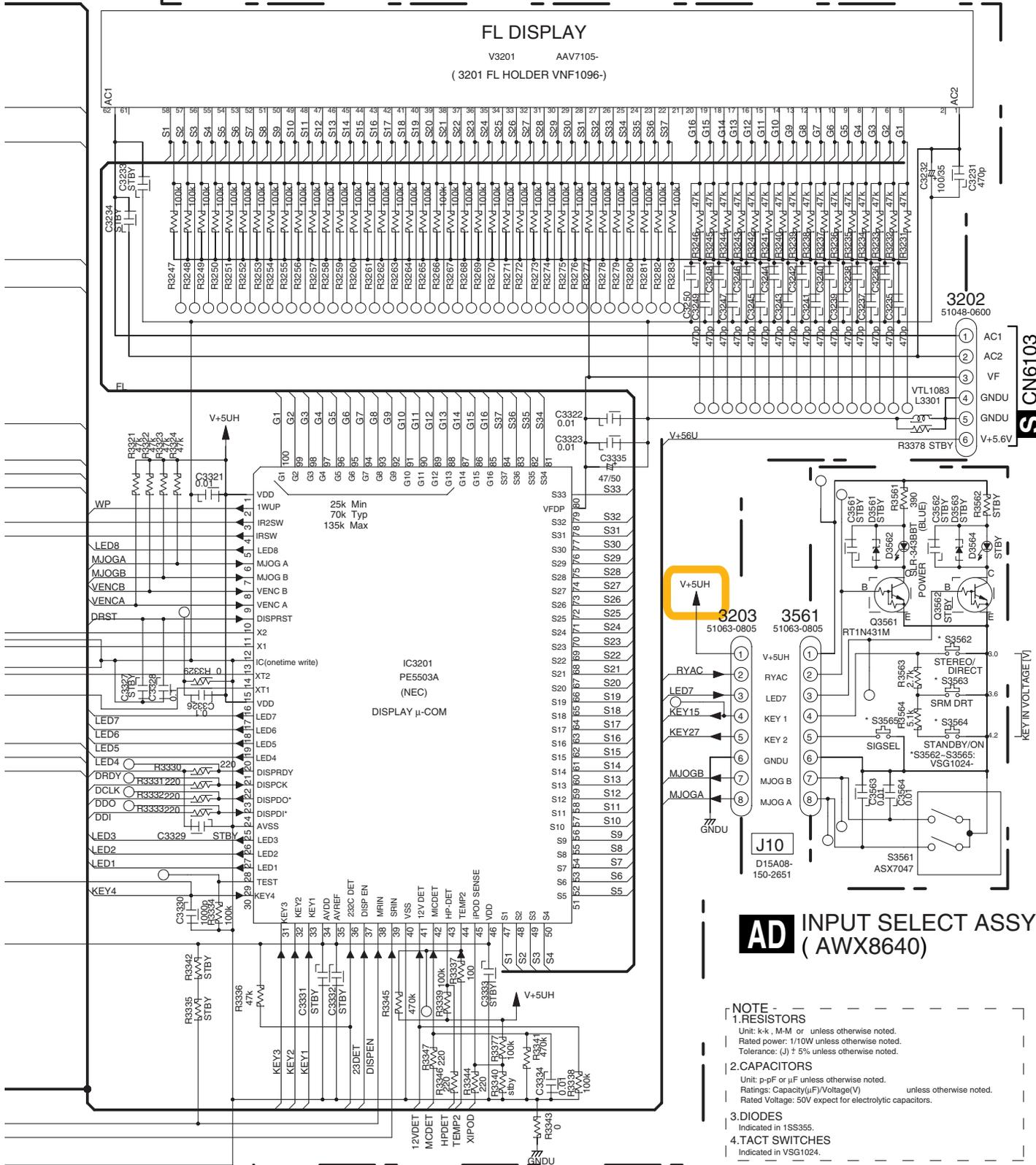

**AD** INPUT SELECT ASSY  
 (AWX8640)

- NOTE -**
- RESISTORS**  
 Unit: k-k, M-M or unless otherwise noted.  
 Rated power: 1/10W unless otherwise noted.  
 Tolerance: (J) ± 5% unless otherwise noted.
  - CAPACITORS**  
 Unit: p-pF or μF unless otherwise noted.  
 Ratings: Capacity(μF)/Voltage(V) unless otherwise noted.  
 Rated Voltage: 50V expect for electrolytic capacitors.
  - DIODES**  
 Indicated in 1SS355.
  - TACT SWITCHES**  
 Indicated in VSG1024.

# 3.31 PREOUT & CONTROL ASSY

1 2 3 4

A  
B  
C  
D  
E  
F

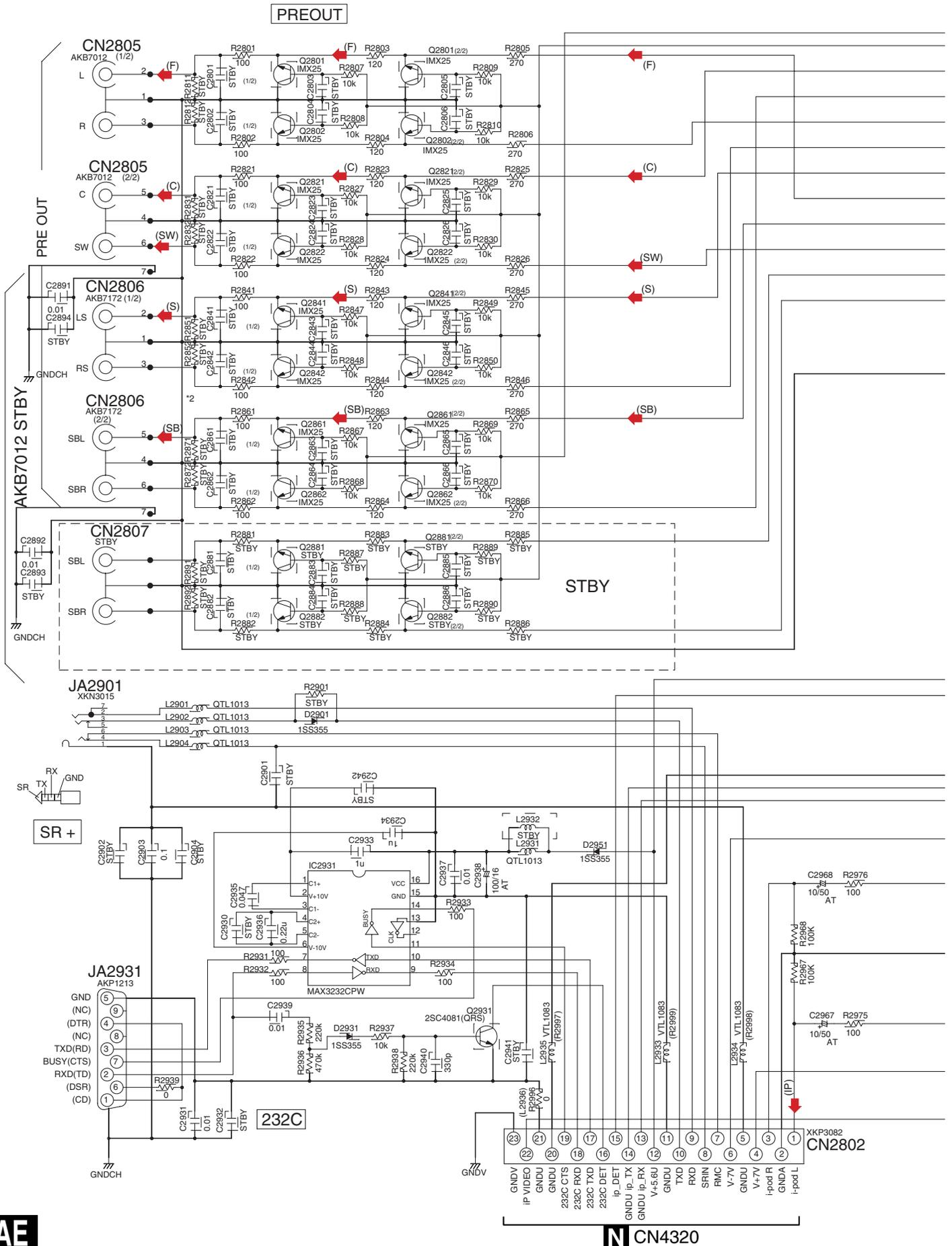

AE CN4320

VSX-74TXVi

1 2 3 4

**AE** PREOUT & CONTROL ASSY (AWX8625)

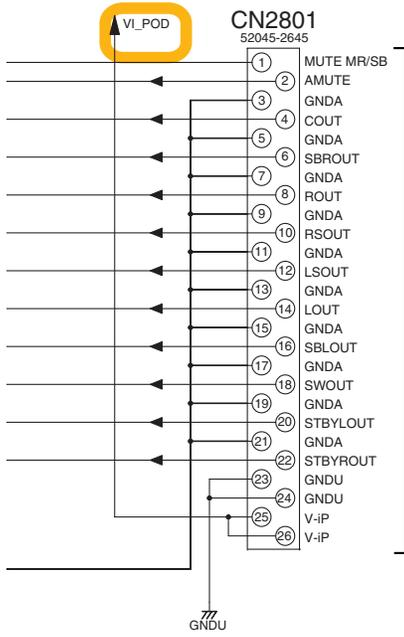

**K** 2/4 CN2602

**NOTE**

**1.RESISTORS**  
Unit: k-k, M-M or unless otherwise noted.  
Rated power: 1/16W unless otherwise noted.  
Tolerance: (J) 5% unless otherwise noted.

**2.CAPACITORS**  
Unit: p-pF or μF unless otherwise noted.  
Ratings: Capacity(μF)/Voltage(V) unless otherwise noted.  
Rated Voltage: 50V expect for electrolytic capacitors.

- (F) → AUDIO SIGNAL ROUTE (F)
- (C) → AUDIO SIGNAL ROUTE (C)
- (S) → AUDIO SIGNAL ROUTE (S)
- (SB) → AUDIO SIGNAL ROUTE (SB)
- (SW) → AUDIO SIGNAL ROUTE (SW)
- (IP) → AUDIO SIGNAL ROUTE (IP)

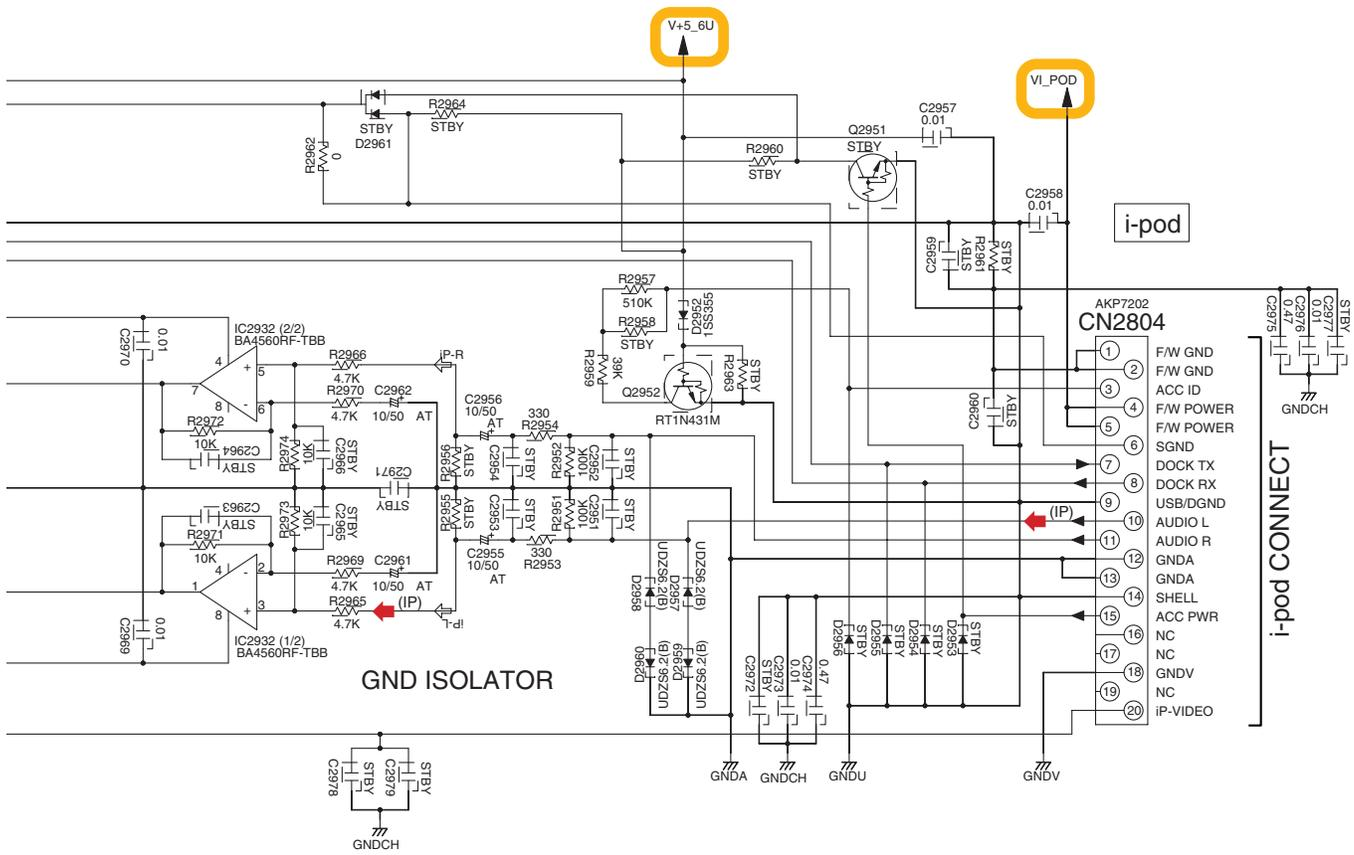





# AF 1/2 1394 ASSY (VSX-74TXVi:AWK7882)

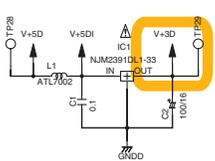

**IMPORTANT PARTS FOR SAFETY**  
Indicated in "STBY" parts are STANDBY.

**CAPACITORS**  
Unit : p-pF or  $\mu$ F unless otherwise noted.  
-F : .CEVW101M16  
-F : .CCSRCH  
-F : .CKSRVB unless otherwise noted.

**RESISTORS**  
Unit : k-k, M-M or  $\Omega$  unless otherwise noted.  
Retard power : 1/16W unless otherwise noted.  
Tolerance : (J)  $\pm 5\%$  unless otherwise noted.

GUID LABEL:VXW1005

JA202  
VKN1800

JA201  
VKN1800

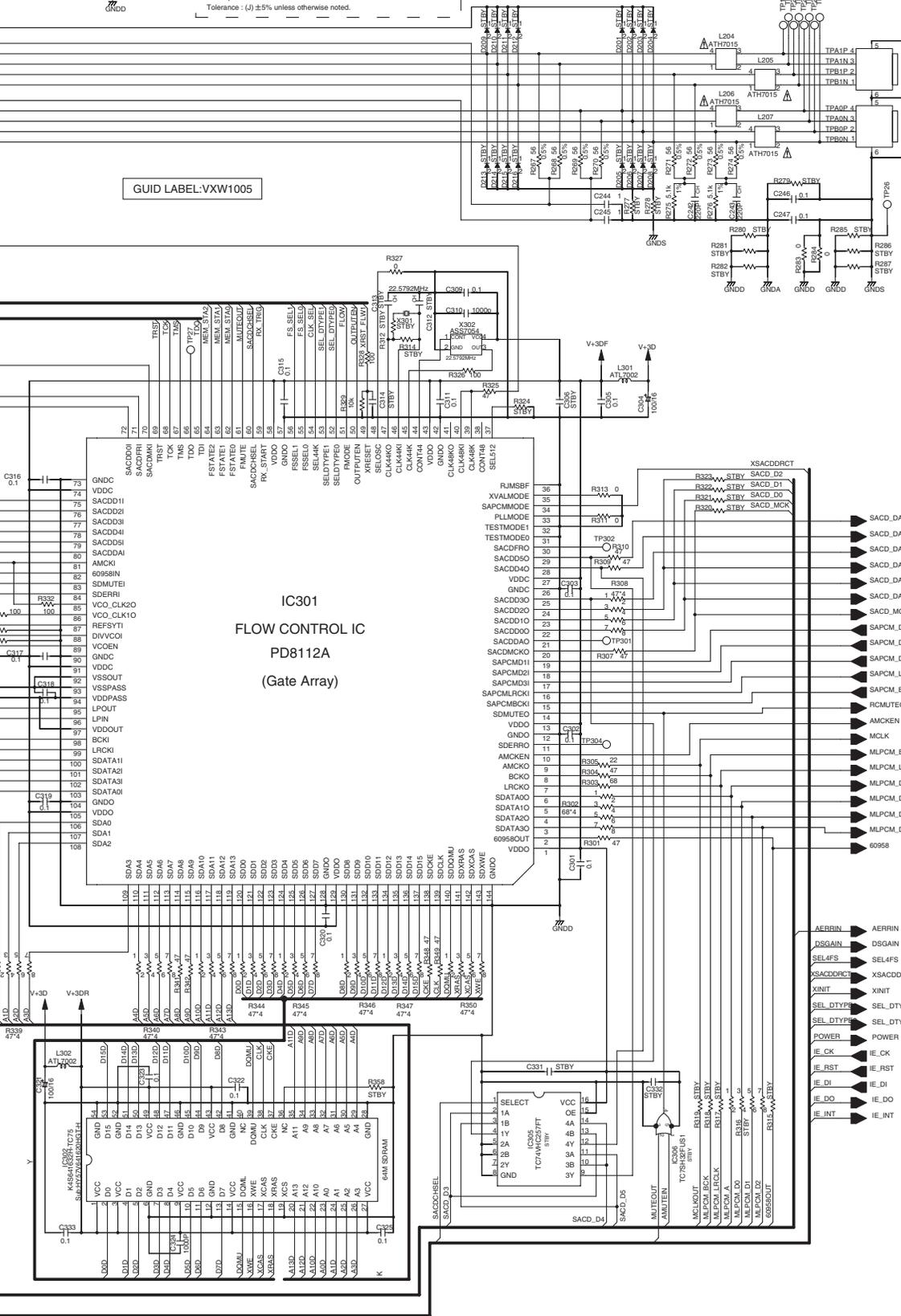

AF 2/2

AF 1/2

# 3.33 1394 ASSY (2/2)

A

B

C

D

E

F

AF 1/2

AF 1/2

AF 2/2

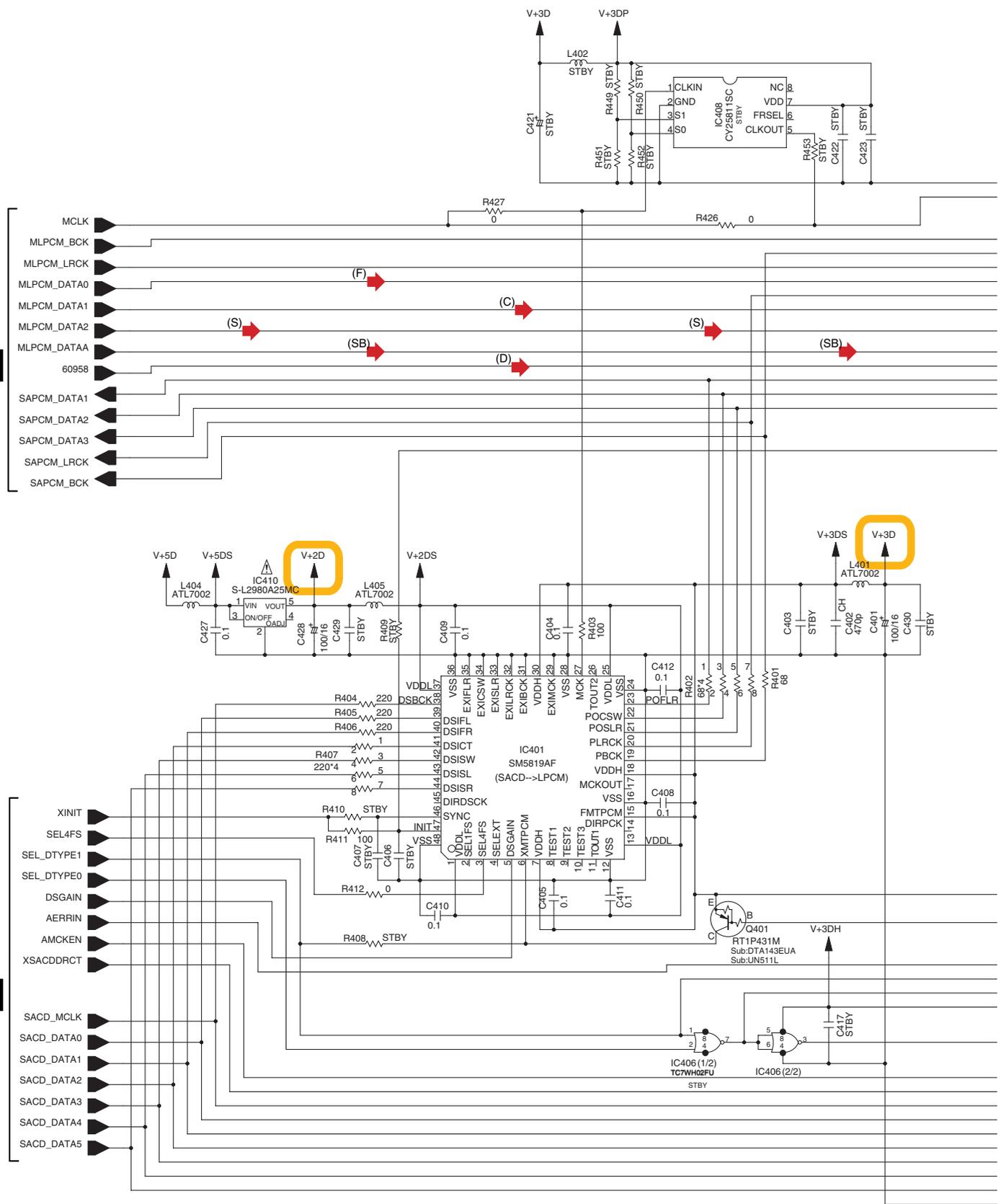

**NOTES**

▲ IMPORTANT PARTS FOR SAFETY  
Indicated in "STBY" parts are STANDBY.

**CAPACITORS**  
Unit : p-pF or μF unless otherwise noted.  
Ratings : Capacity(μF)/Voltage(V)  
Rated Voltage : 50V except for electrolytic capacitors.

⚡ :CEVW101M16  
-|- :CKSRyb unless otherwise noted

**RESISTORS**  
Unit : k-k, M-M or unless otherwise noted.  
Rated power : 1/16W unless otherwise noted.  
Tolerance : (J) ± 5% unless otherwise noted.





# AG 1/2 HDMI&DVC ASSY (AWQ7024)

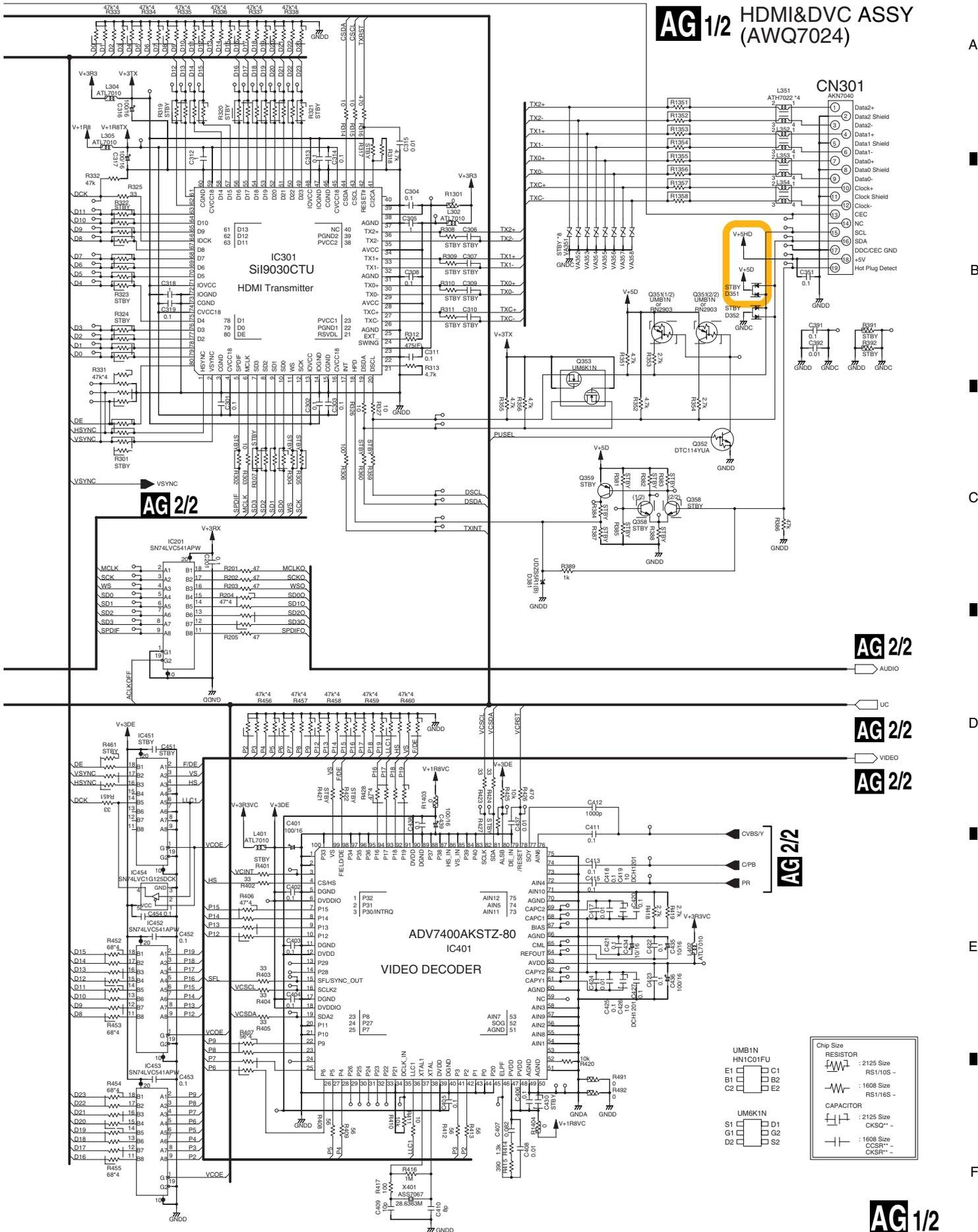

AG 2/2

AG 2/2

AG 2/2

AG 2/2

AG 2/2

Chip Size	RESISTOR
RESISTOR	2125 Size
	RS110S -
	1608 Size
	RS116S -
CAPACITOR	2125 Size
	CKSD** -
	1608 Size
	CKSR** -

# 3.35 HDMI&DVC ASSY (2/2)

AG 1/2

AG 1/2

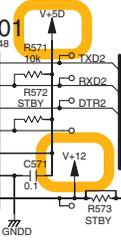

AG 1/2

AG 2/2

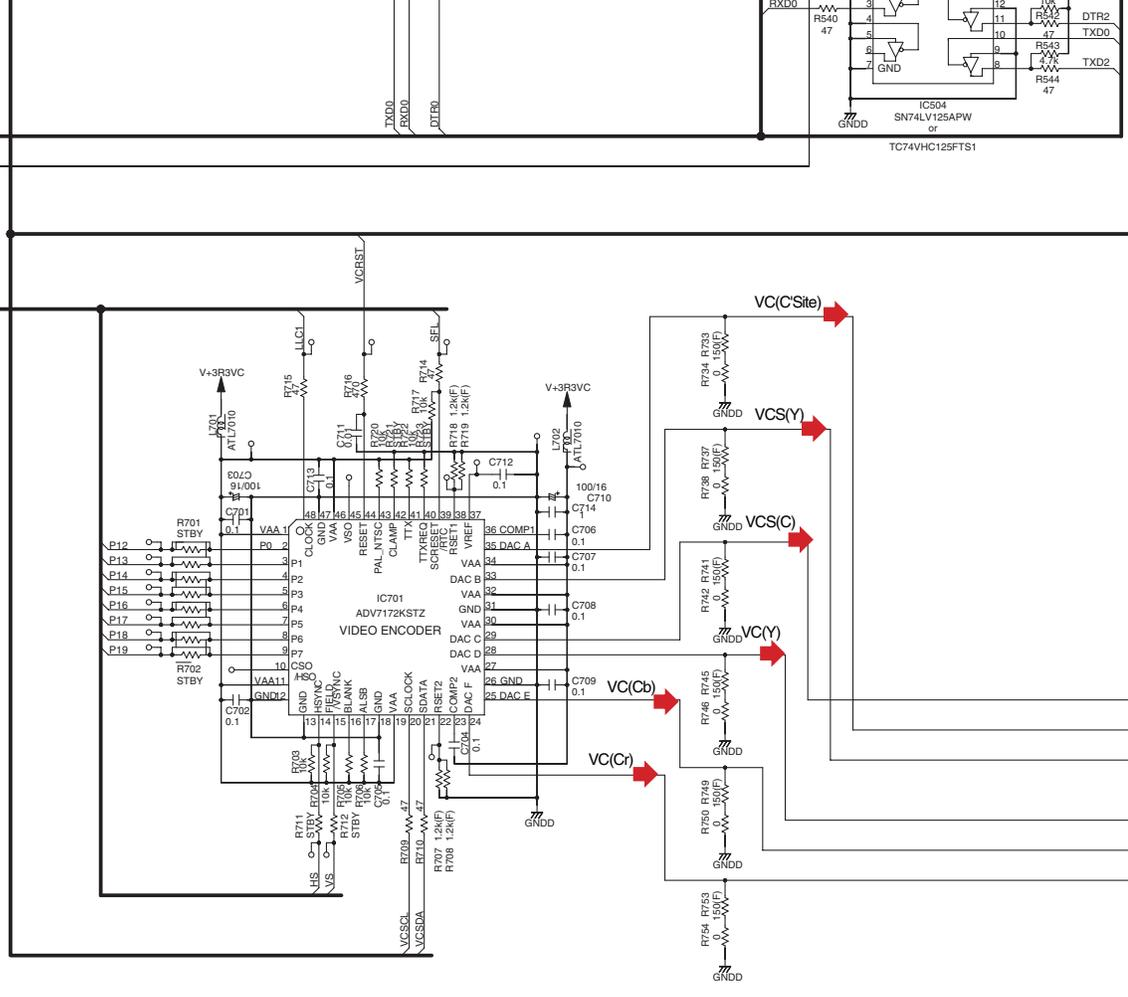
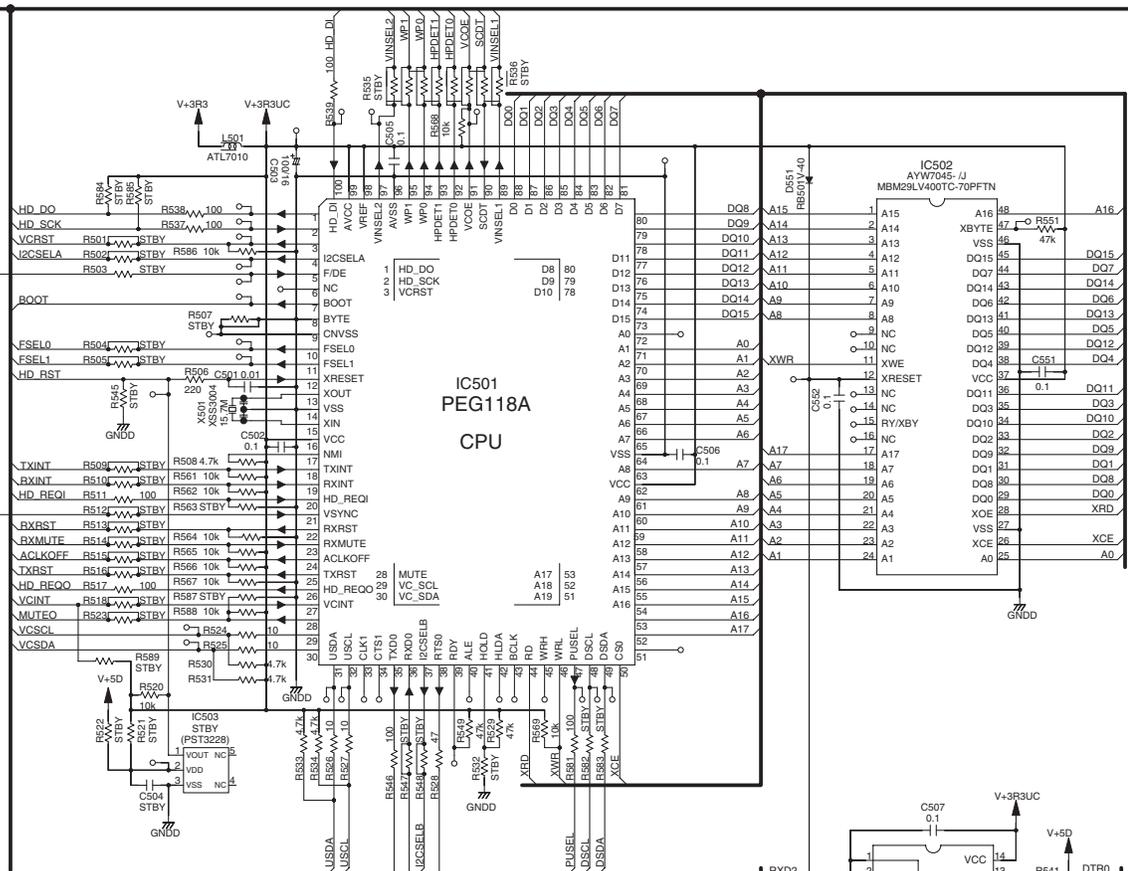

# AG 2/2 HDMI&DVC ASSY (AWQ7024)

- (F) : AUDIO SIGNAL ROUTE(F)
- (C) : AUDIO SIGNAL ROUTE(C)
- (S) : AUDIO SIGNAL ROUTE(S)
- (SB) : AUDIO SIGNAL ROUTE(SB)
- (D) : AUDIO SIGNAL ROUTE(SPDIF)

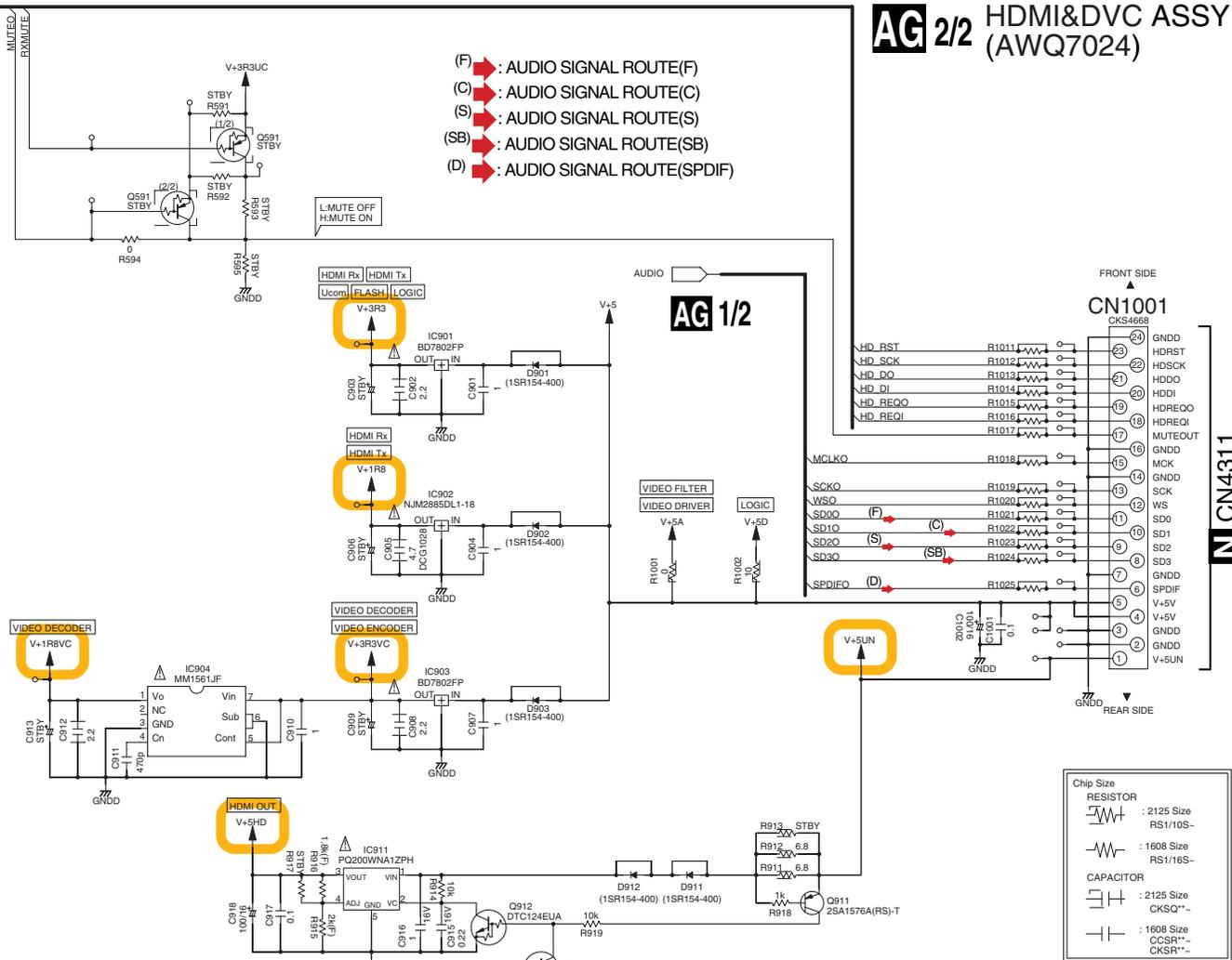

Chip Size  
RESISTOR

- : 2125 Size
- : RS1/10S-
- : 1608 Size
- : RS1/16S-

CAPACITOR

- : 2125 Size
- : CKS0\*\*-
- : 1608 Size
- : CCSR\*\*-
- : CKSR\*\*-

- (C'Site) : VIDEO SIGNAL ROUTE (C'Site)
- VC(C'Site) : VIDEO SIGNAL ROUTE VC(C'Site)
- S(Y) : VIDEO SIGNAL ROUTE S(Y)
- S(C) : AUDIO SIGNAL ROUTE S(C)
- VC(S) : AUDIO SIGNAL ROUTE VC(S)
- VC(C) : AUDIO SIGNAL ROUTE VC(C)
- C(Y) : AUDIO SIGNAL ROUTE C(Y)
- C(Cb) : AUDIO SIGNAL ROUTE C(Cb)
- C(Cr) : AUDIO SIGNAL ROUTE C(Cr)
- VC(Y) : AUDIO SIGNAL ROUTE VC(Y)
- VC(Cb) : AUDIO SIGNAL ROUTE VC(Cb)
- VC(Cr) : AUDIO SIGNAL ROUTE VC(Cr)

## AG 1/2

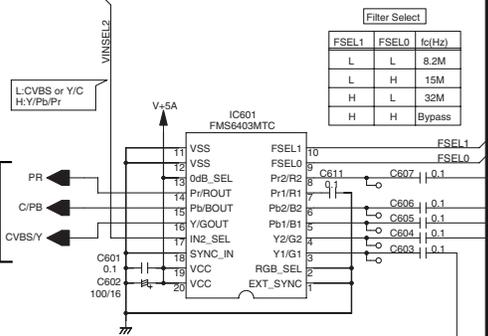

## AG 2/2

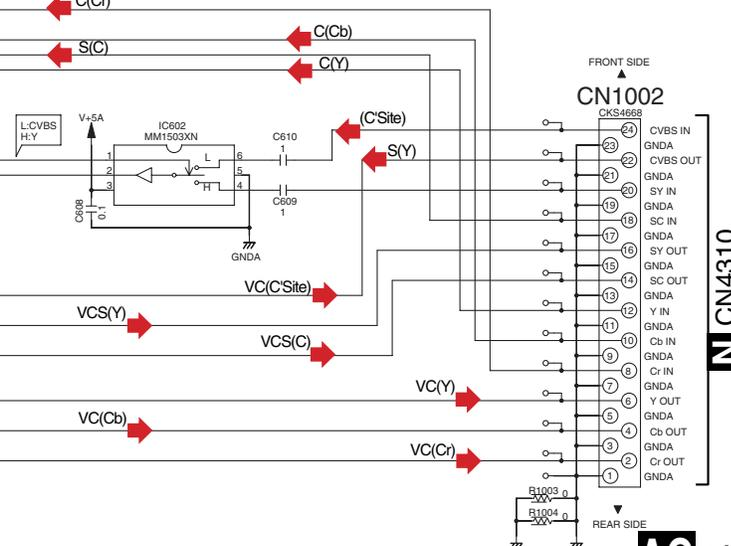
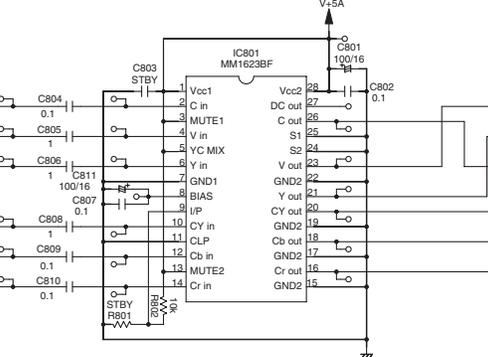

# 4. PCB CONNECTION DIAGRAM

## NOTE FOR PCB DIAGRAMS :

1. Part numbers in PCB diagrams match those in the schematic diagrams.
2. A comparison between the main parts of PCB and schematic diagrams is shown below.

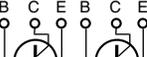
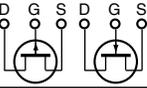
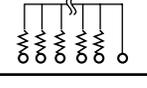
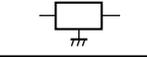
Symbol In PCB Diagrams	Symbol In Schematic Diagrams	Part Name
		Transistor
		Transistor with resistor
		Field effect transistor
		Resistor array
		3-terminal regulator

3. The parts mounted on this PCB include all necessary parts for several destinations.  
For further information for respective destinations, be sure to check with the schematic diagram.
4. View point of PCB diagrams.

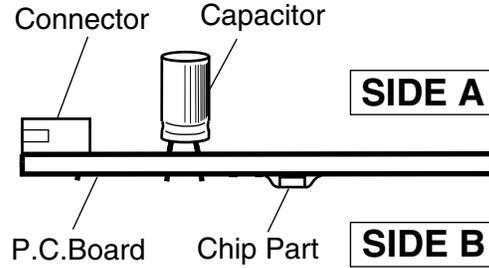



4.1 PRIOUT&CONTROL ASSY

SIDE A

SIDE B

AE PRIOUT&CONTROL ASSY

AE PRIOUT&CONTROL ASSY

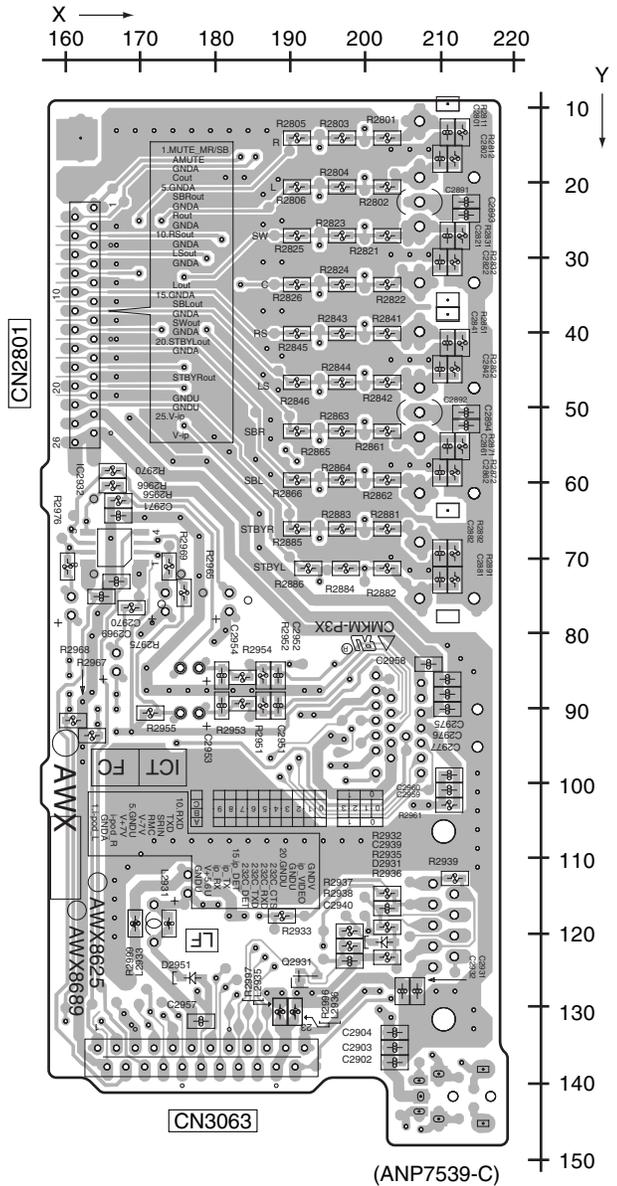
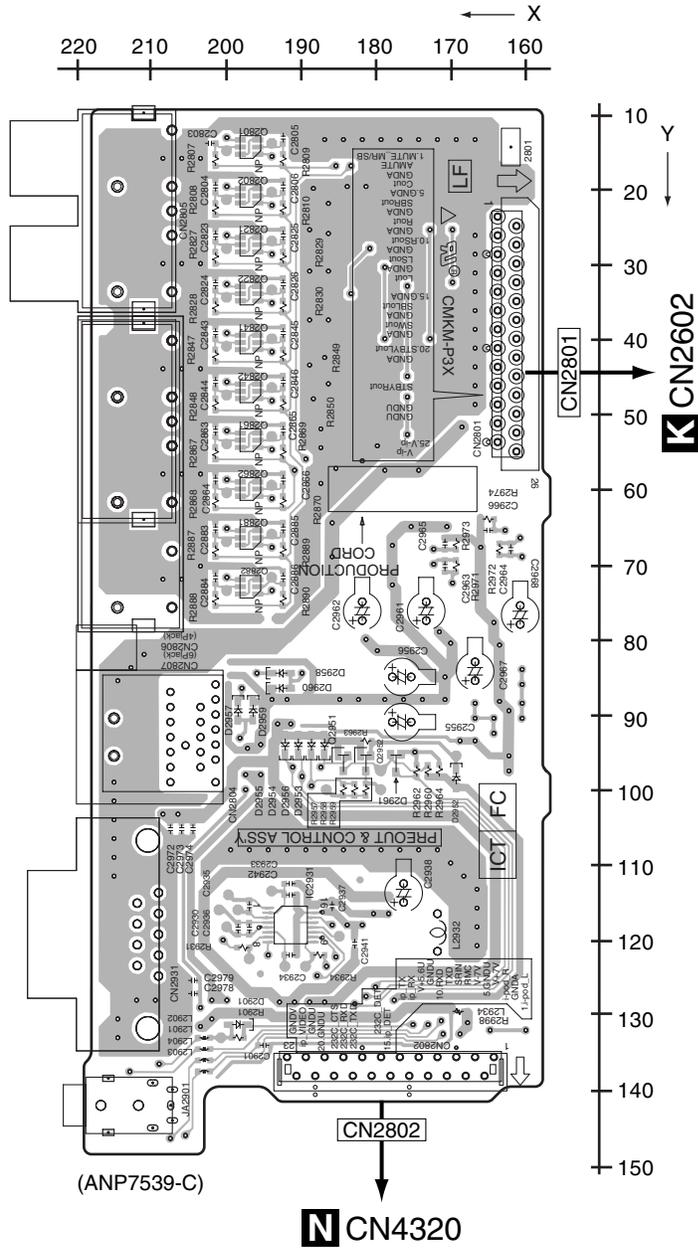

AE

AE

# 4.2 AUDIO&MULTI CH IN ASSY

**SIDE A**

**SIDE B**

## A AUDIO&MULTI CH IN ASSY

## A AUDIO&MULTI CH IN ASSY

A

B

C

D

E

F

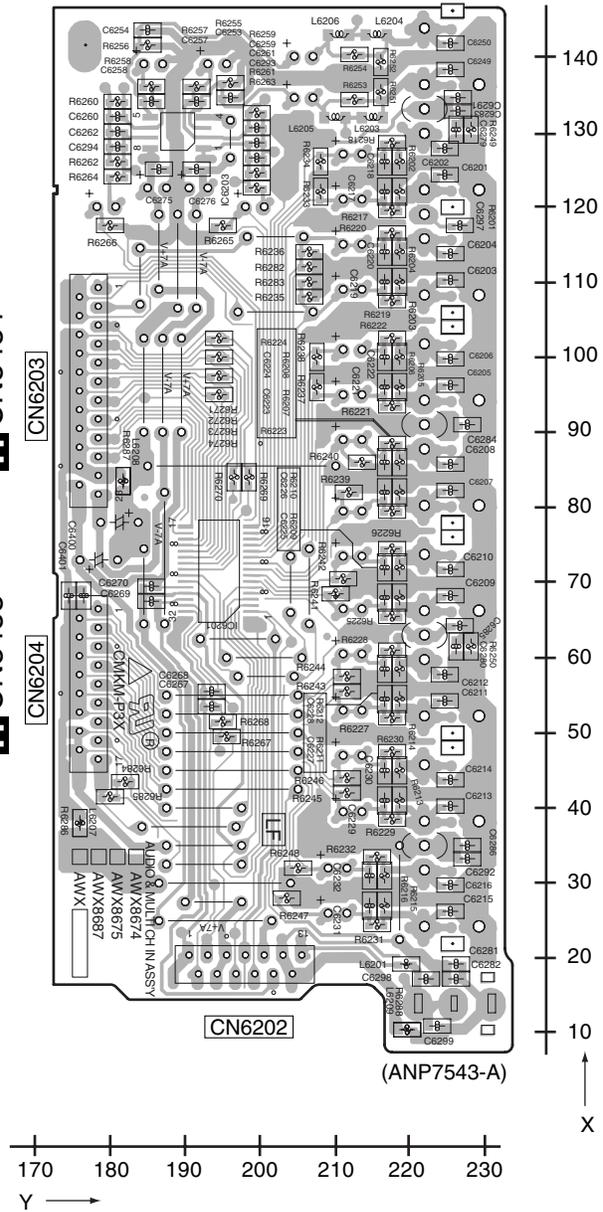
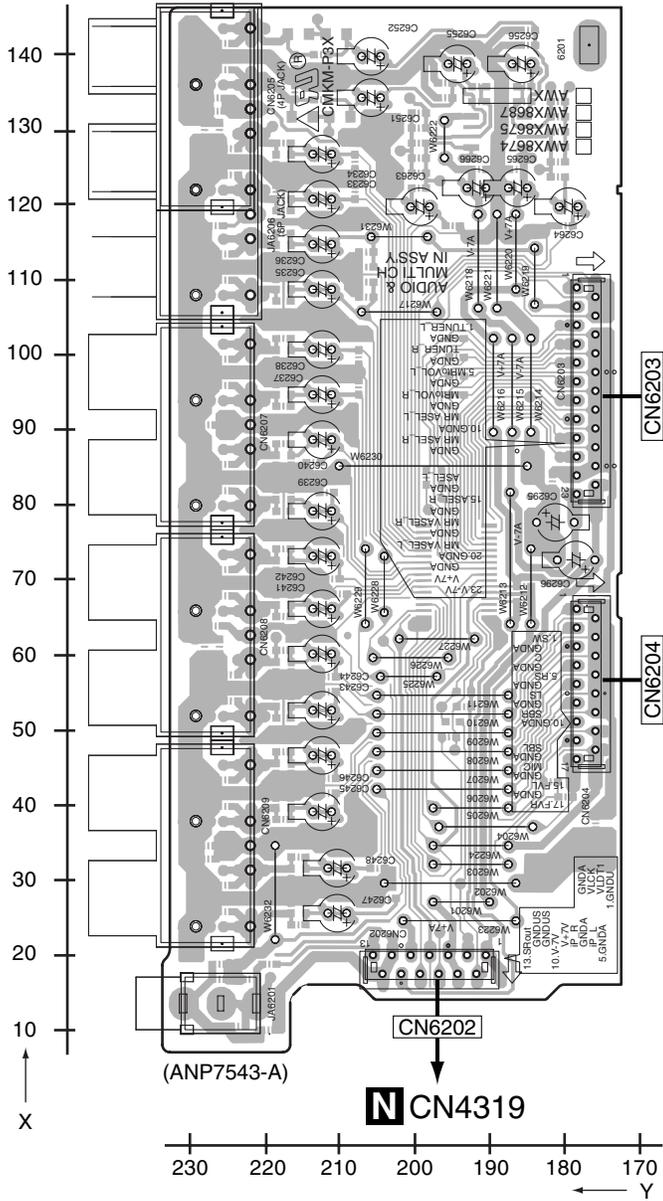

**A**

**A**

# 4.3 V-AUDIO ASSY

**SIDE A**

**SIDE B**

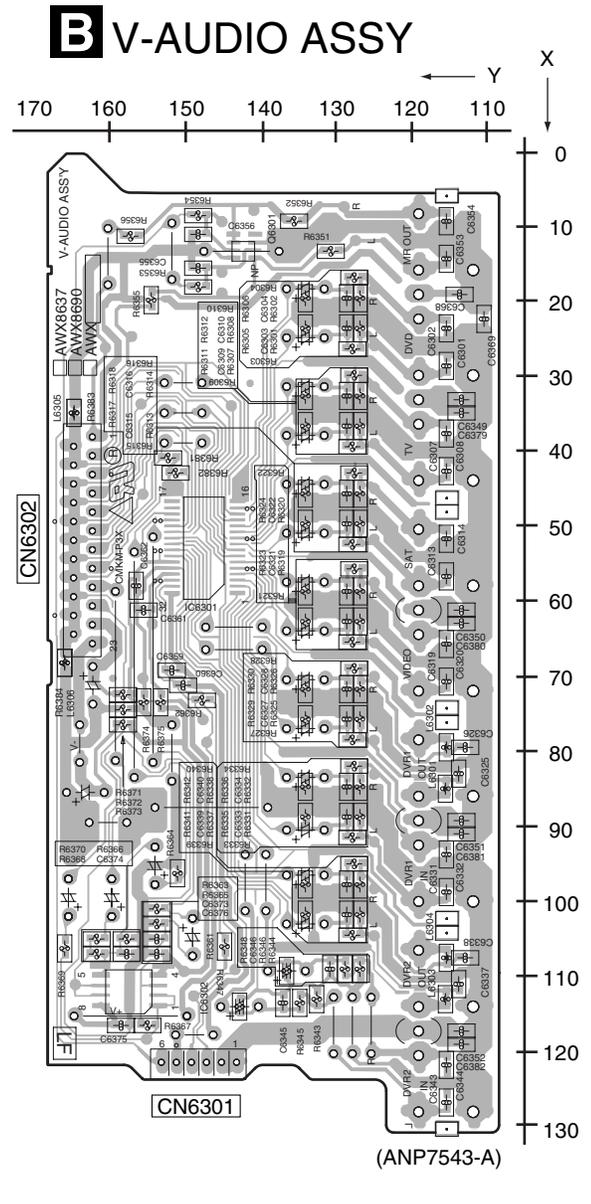
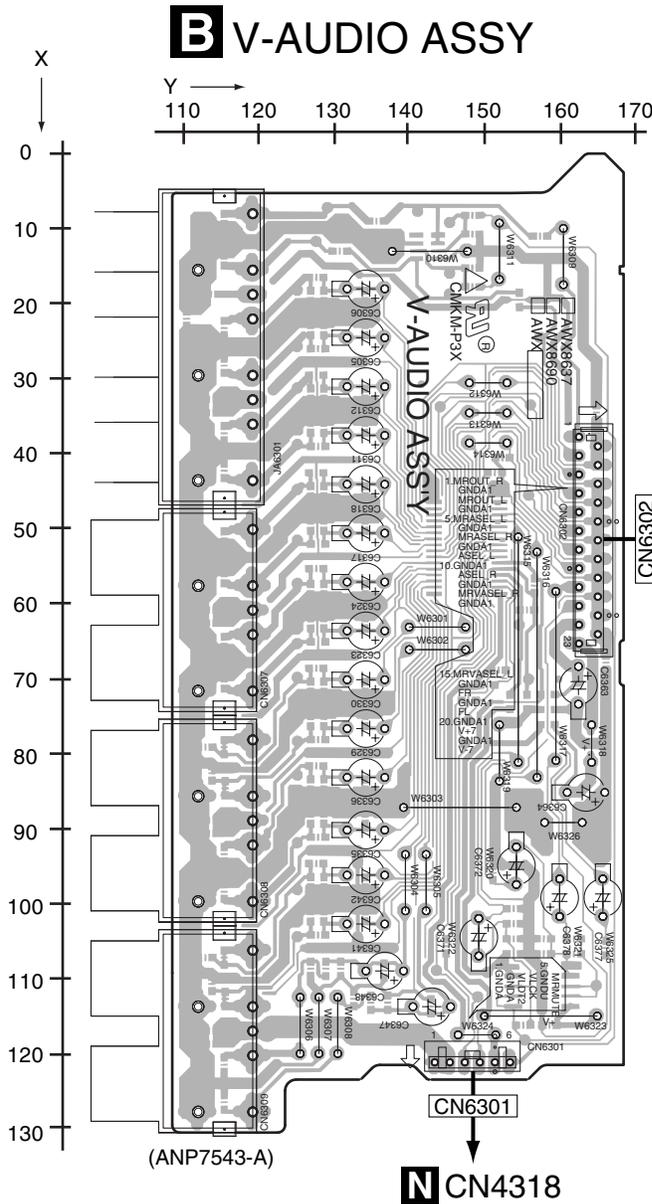

**B**

**B**



# 4.5 BRIDGE1 and BRIDGE2 ASSYS

**SIDE A**

## **E** BRIDGE1 ASSY

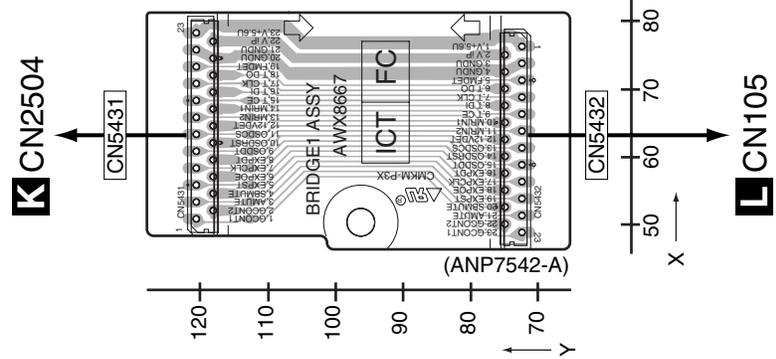

**SIDE A**

**SIDE B**

## **E** BRIDGE1 ASSY

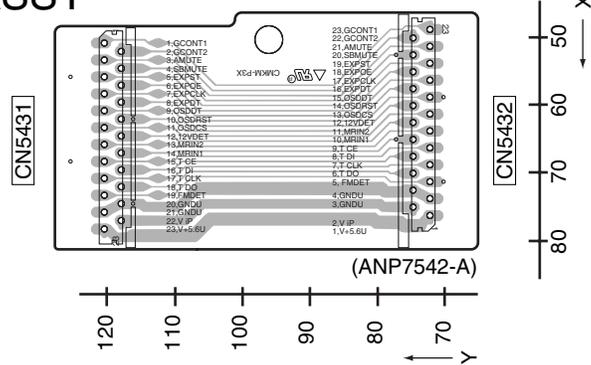

**SIDE B**

**SIDE A**

## **E** BRIDGE2 ASSY

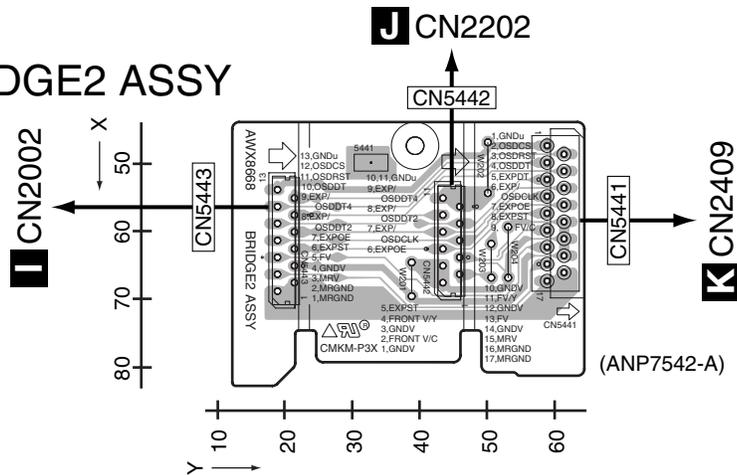

**SIDE A**

**SIDE B**

## **E** BRIDGE2 ASSY

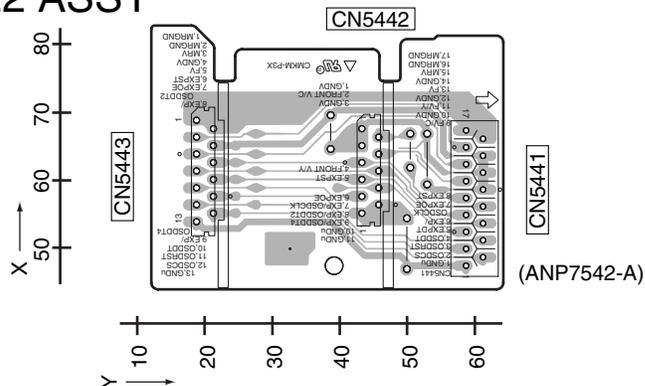

**SIDE B**

**E F**

**E F**

# 4.6 TRANS SIDE and BRIDGE3 ASSYs

**SIDE A**

## G TRANS SIDE ASSY

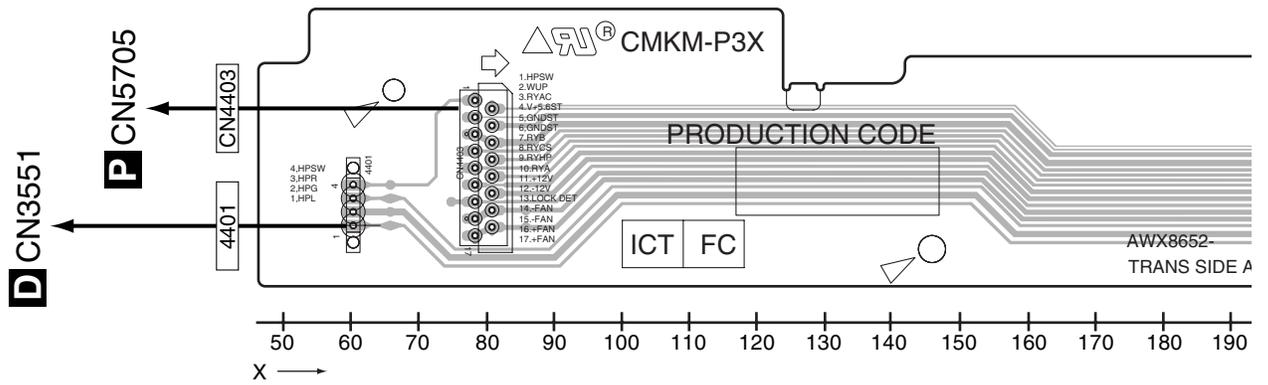

**SIDE B**

## G TRANS SIDE ASSY

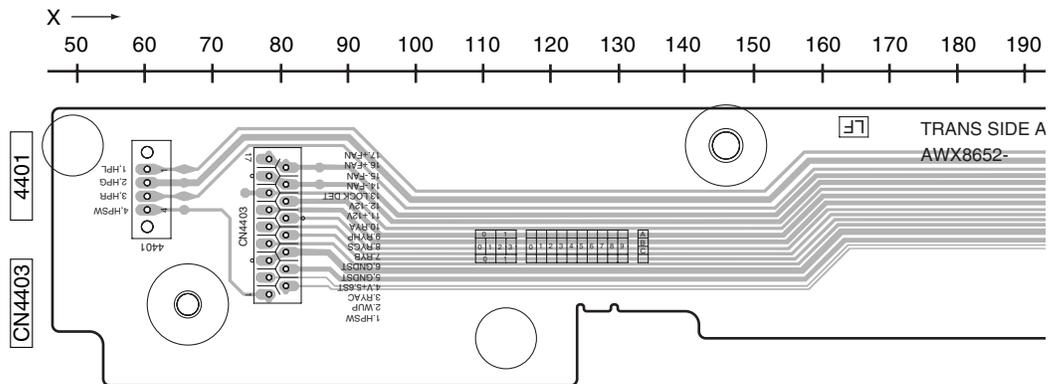

**SIDE A**

## H BRIDGE3 ASSY

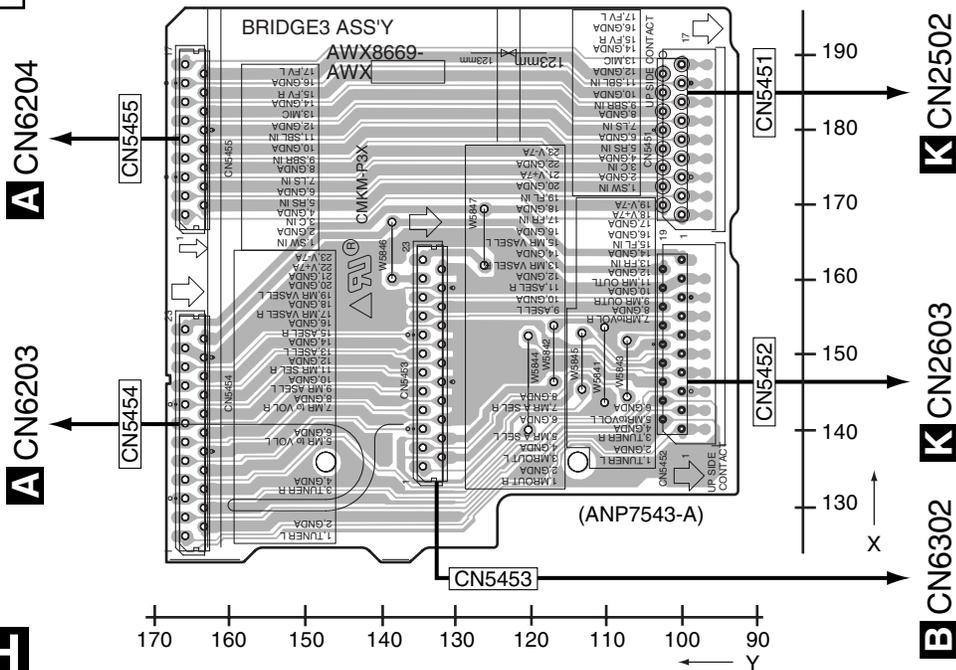

**SIDE A**

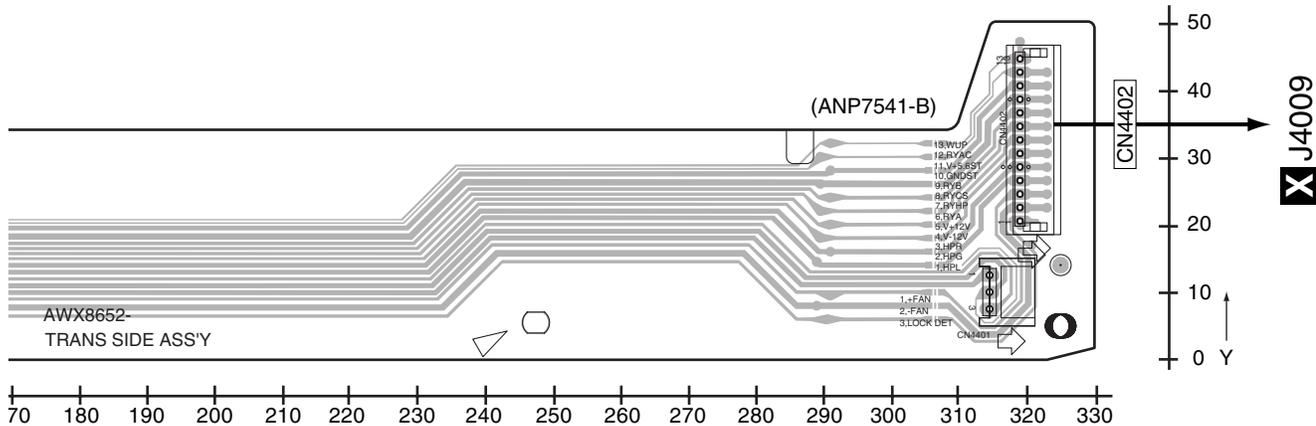

**SIDE B**

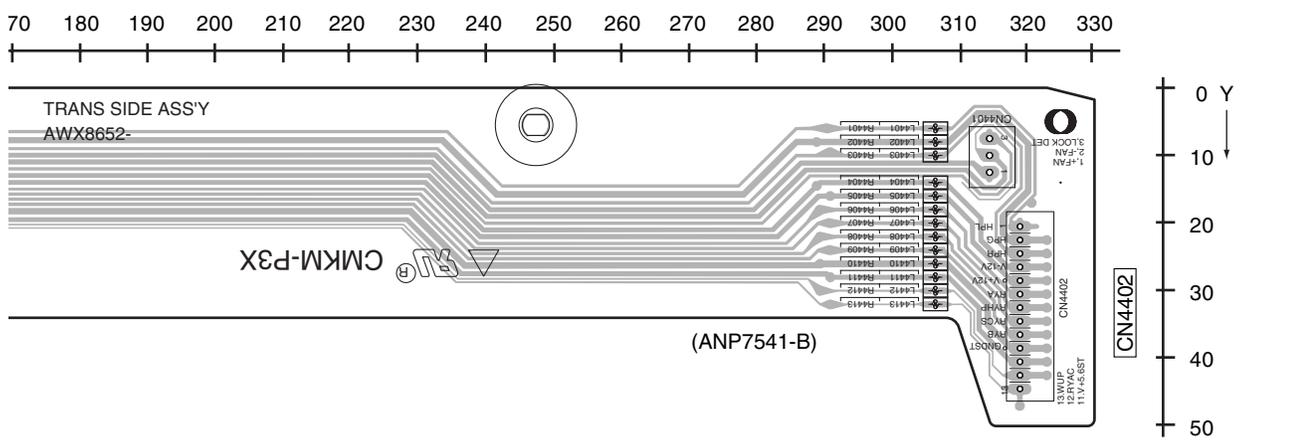

**H BRIDGE3 ASSY**

**SIDE B**

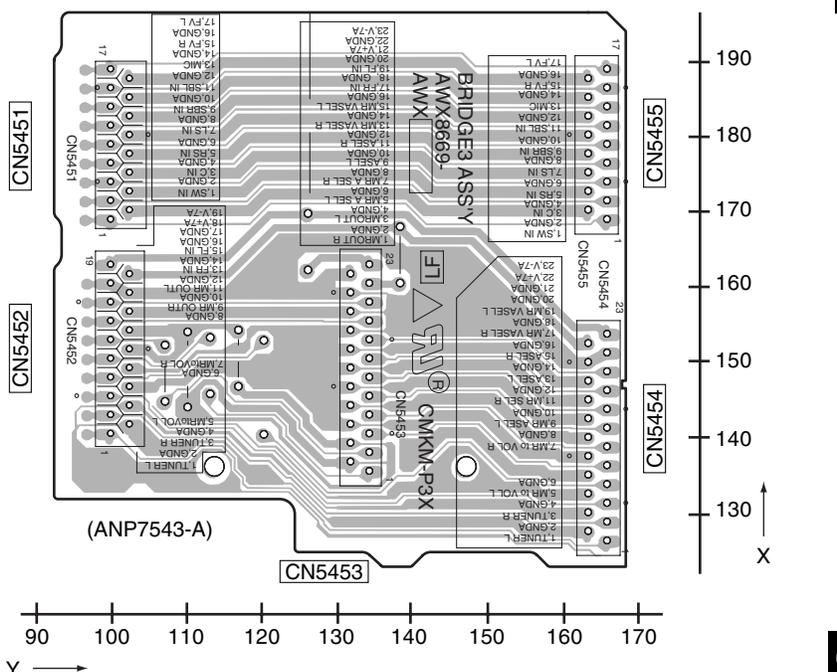

# 4.7 COMPOSITE V ASSYS

**SIDE A**

**SIDE B**

## COMPOSITE V ASSY

## COMPOSITE V ASSY

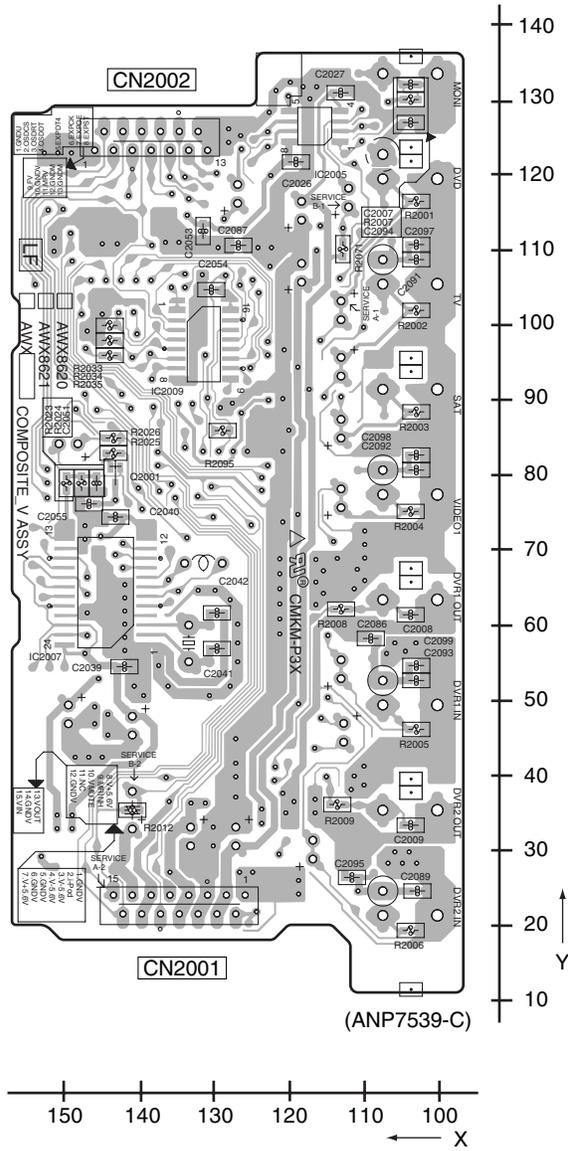
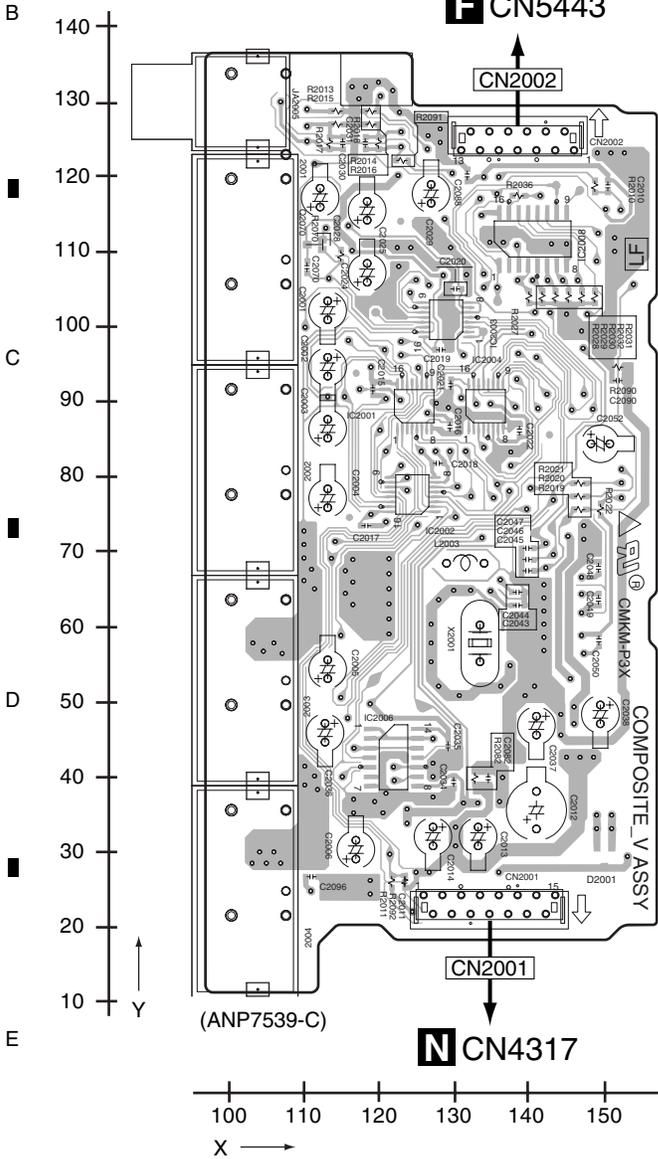



# 4.8 S-VIDEO ASSY

**SIDE A**

**SIDE B**

## J S-VIDEO ASSY

## J S-VIDEO ASSY

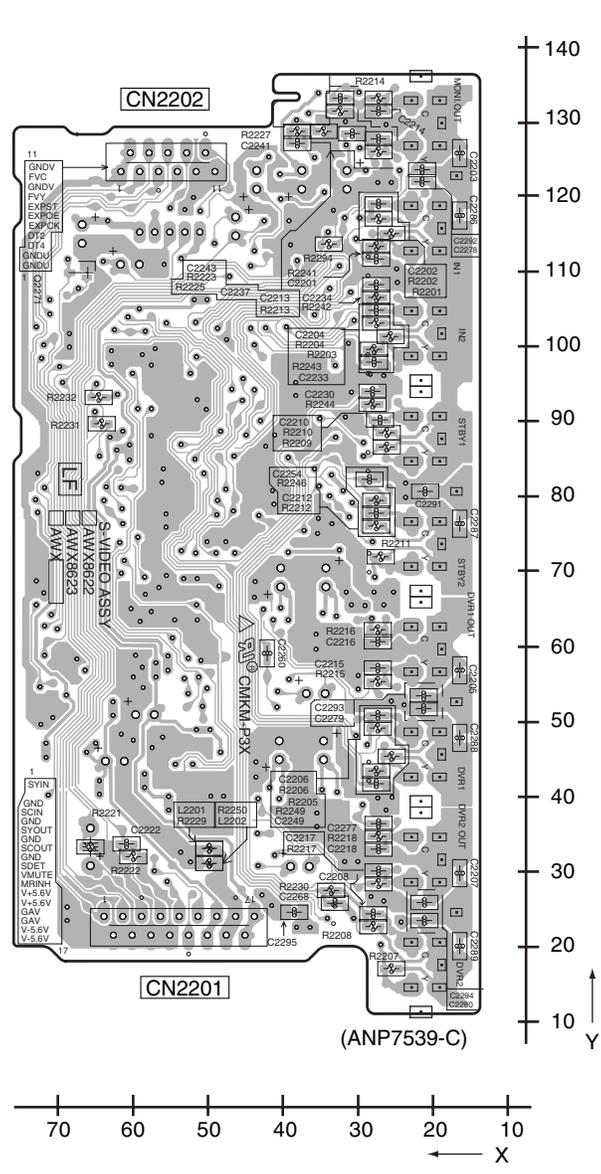
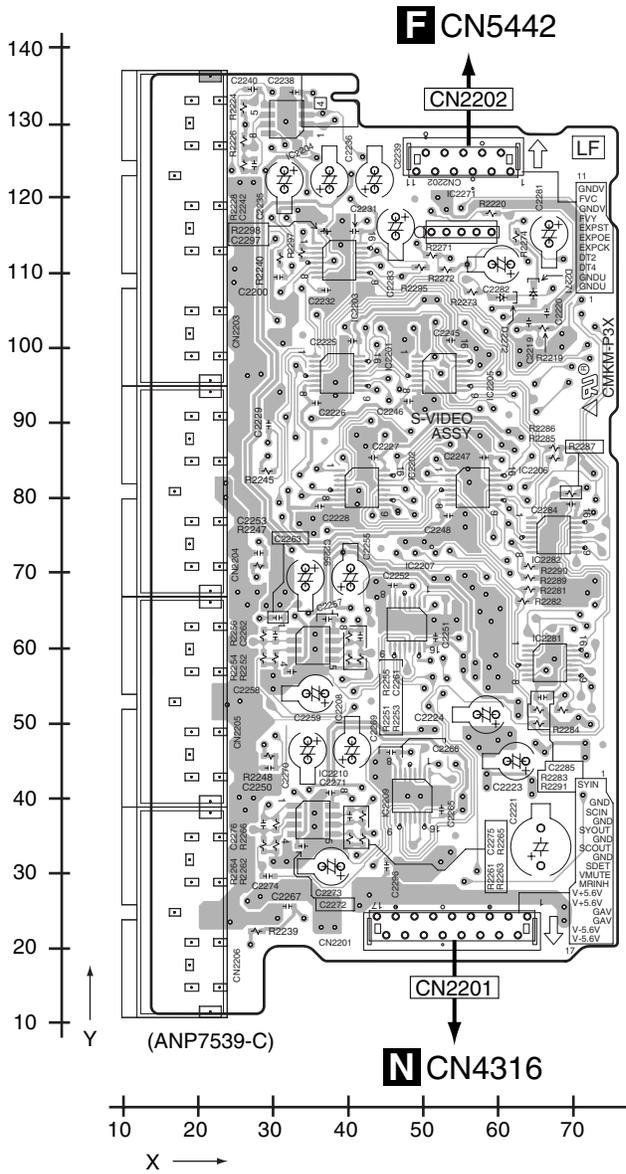

**J**

**J**

# 4.9 COMPONENT&VOL ASSY

**SIDE A**

**K** COMPONENT&VOL ASSY

TUNER MODULE

**H** CN5452

**AE** CN2801

**O** CN5603

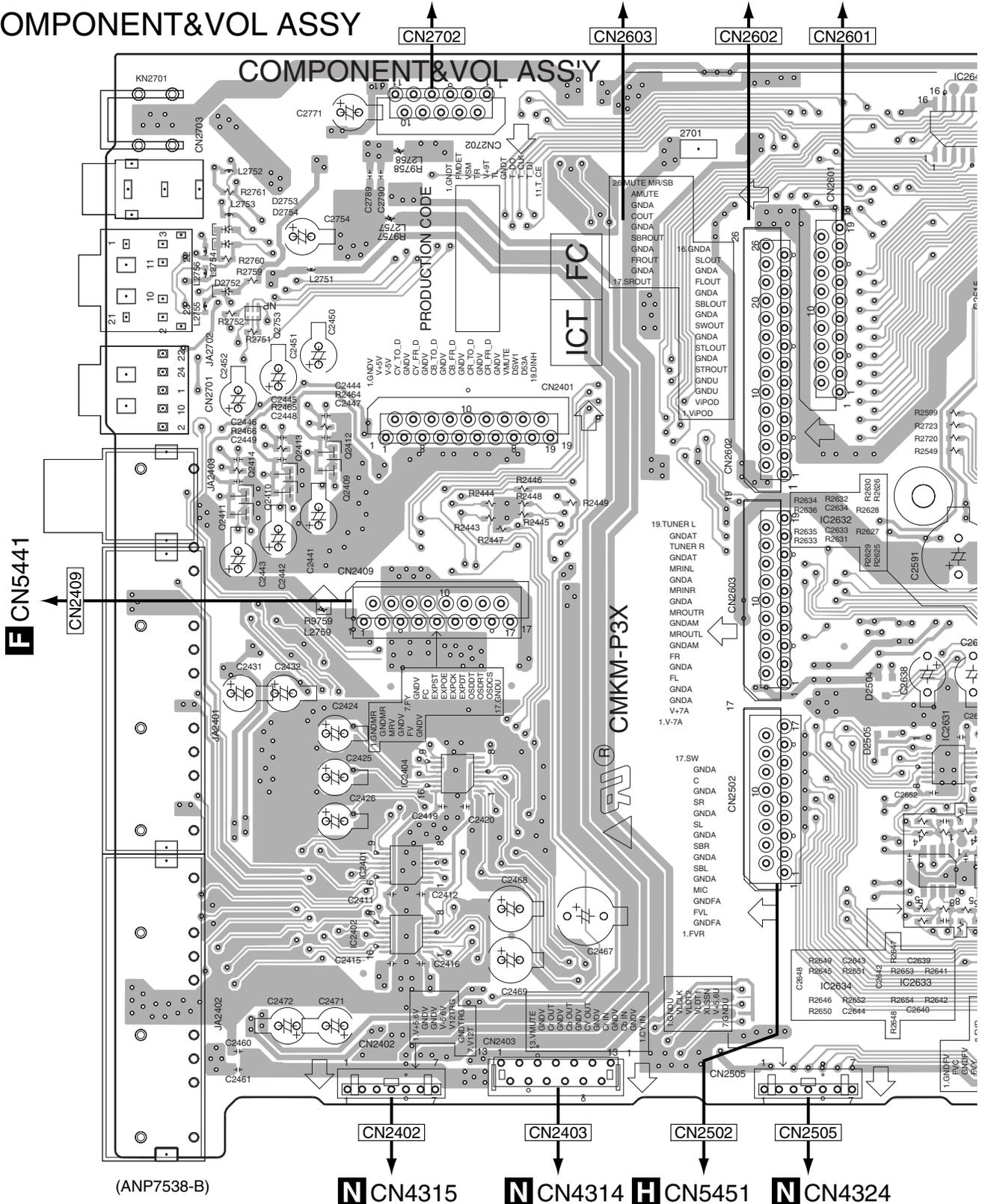

230 220 210 200 190 180 170 160 150 140 130 120 1

VSX-74TXVi



**SIDE B**

A

**K COMPONENT & VOL ASSY**

B

C

D

E

F

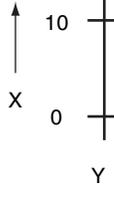
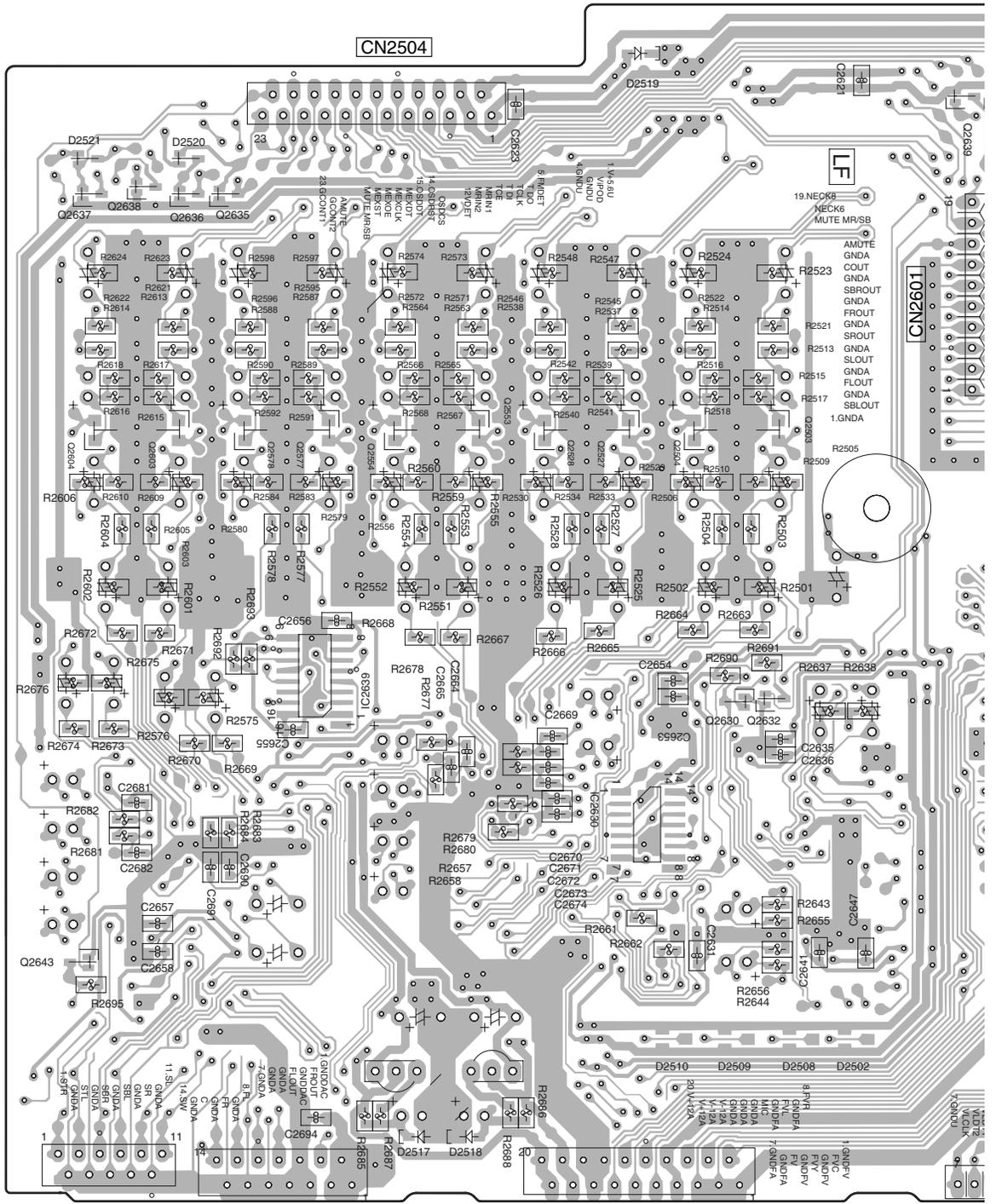
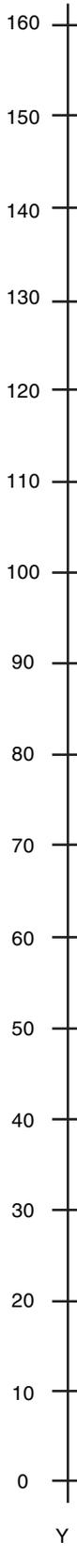

CN2702

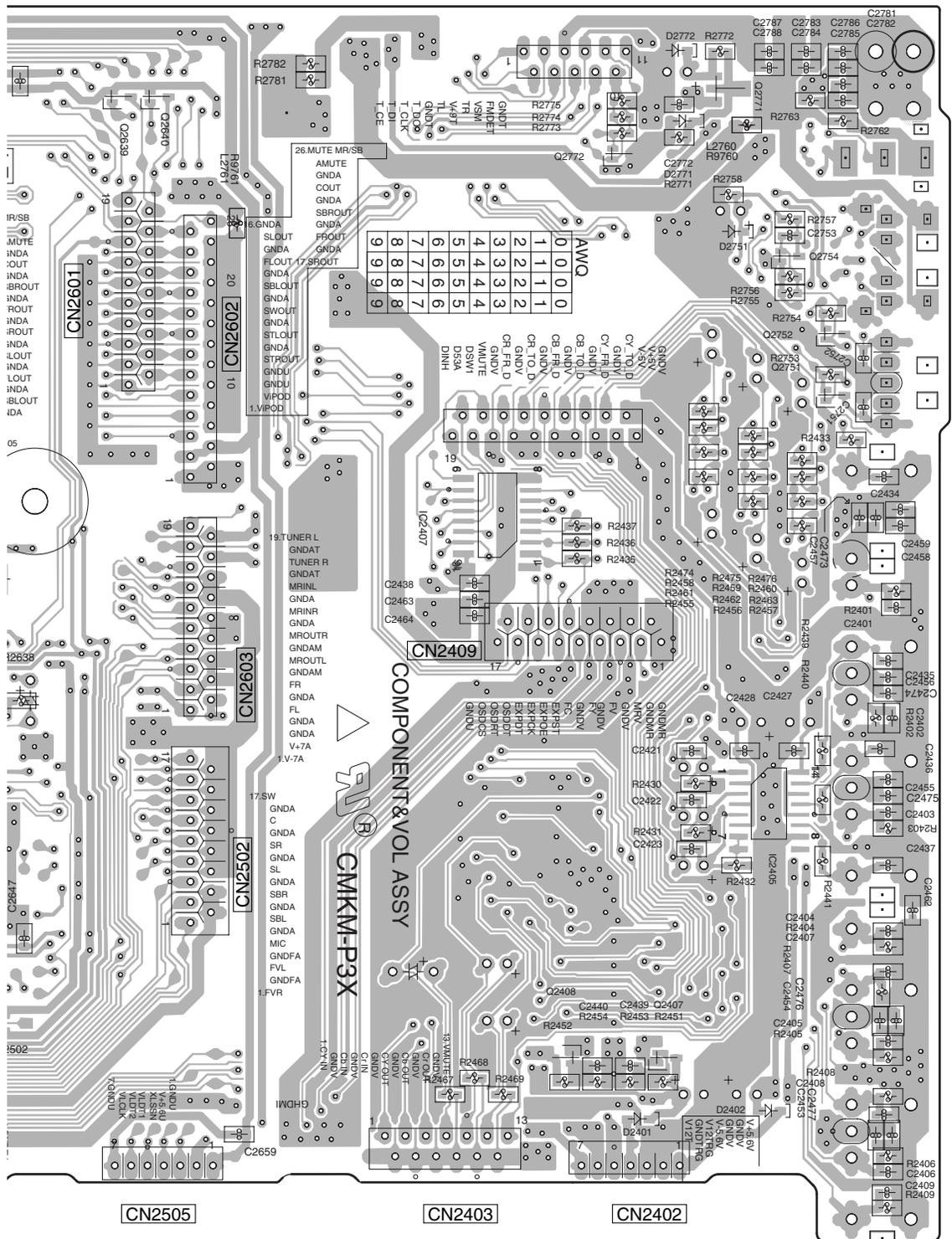

(ANP7538-B)

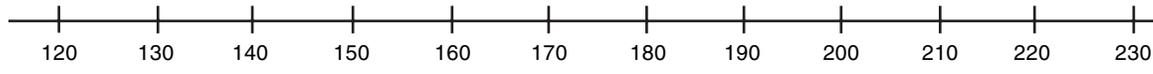



**SIDE A**

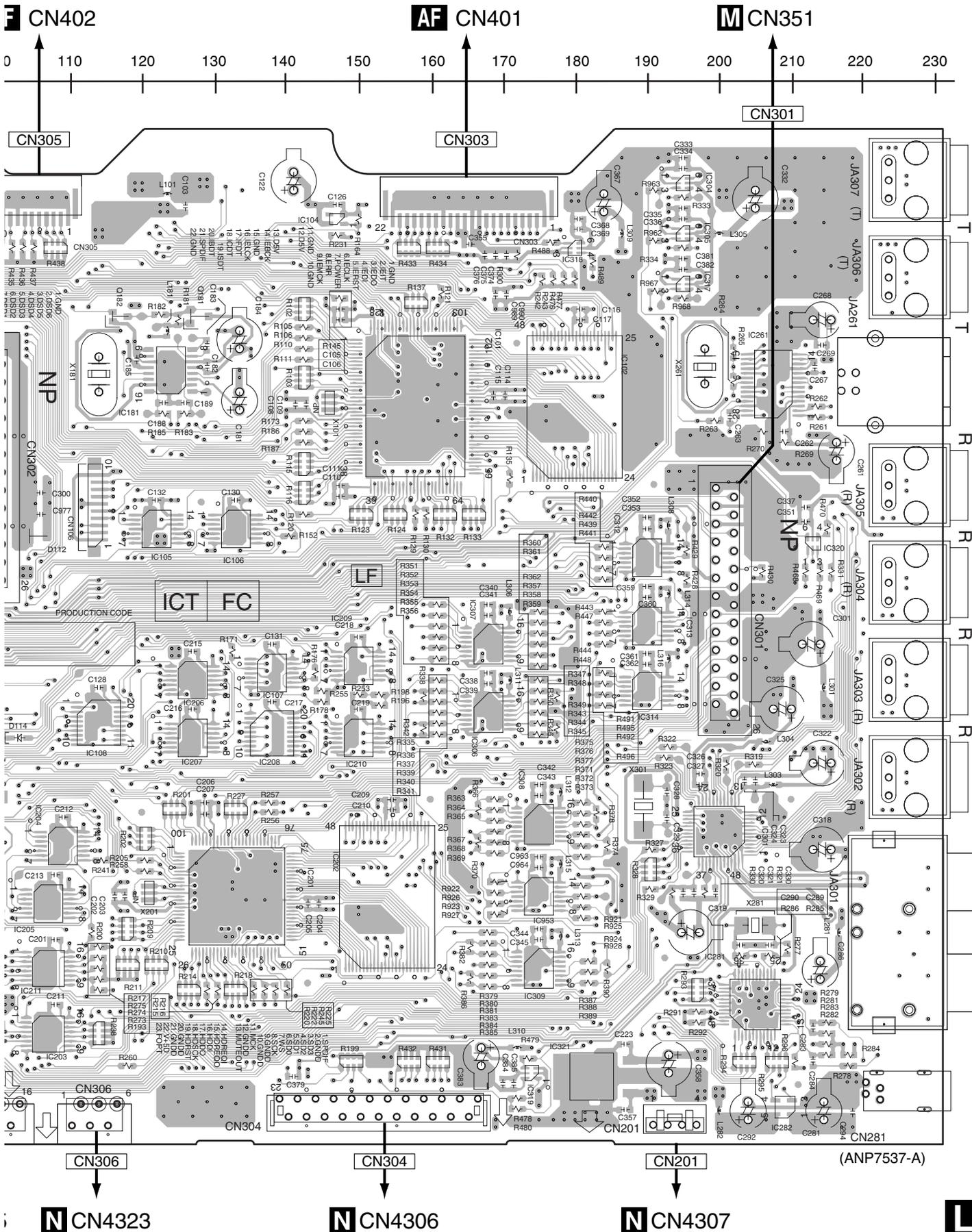

**SIDE B**

# **L** DIGITAL MOTHER ASSY

230 220 210 200 190 180 170 160 150 140 130 120 110

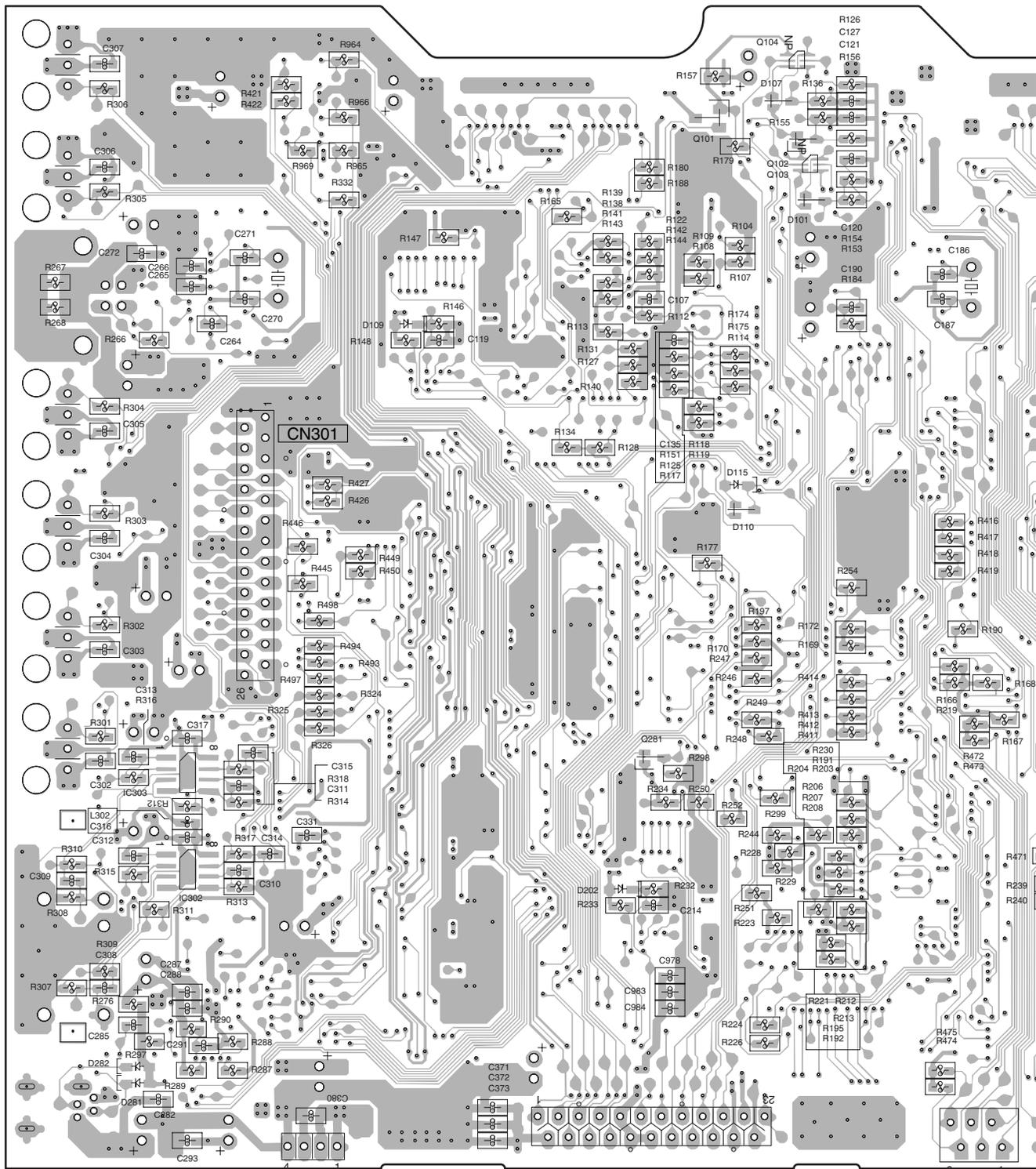

(ANP7537-A)

CN201

CN304

CN306





**SIDE B**

A

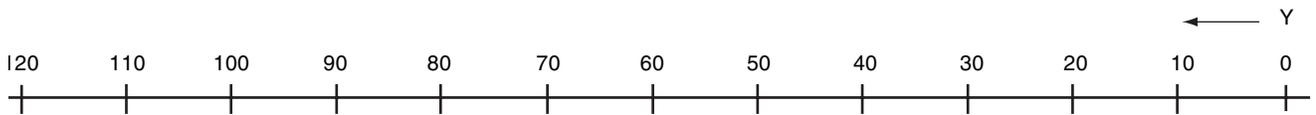

← Y

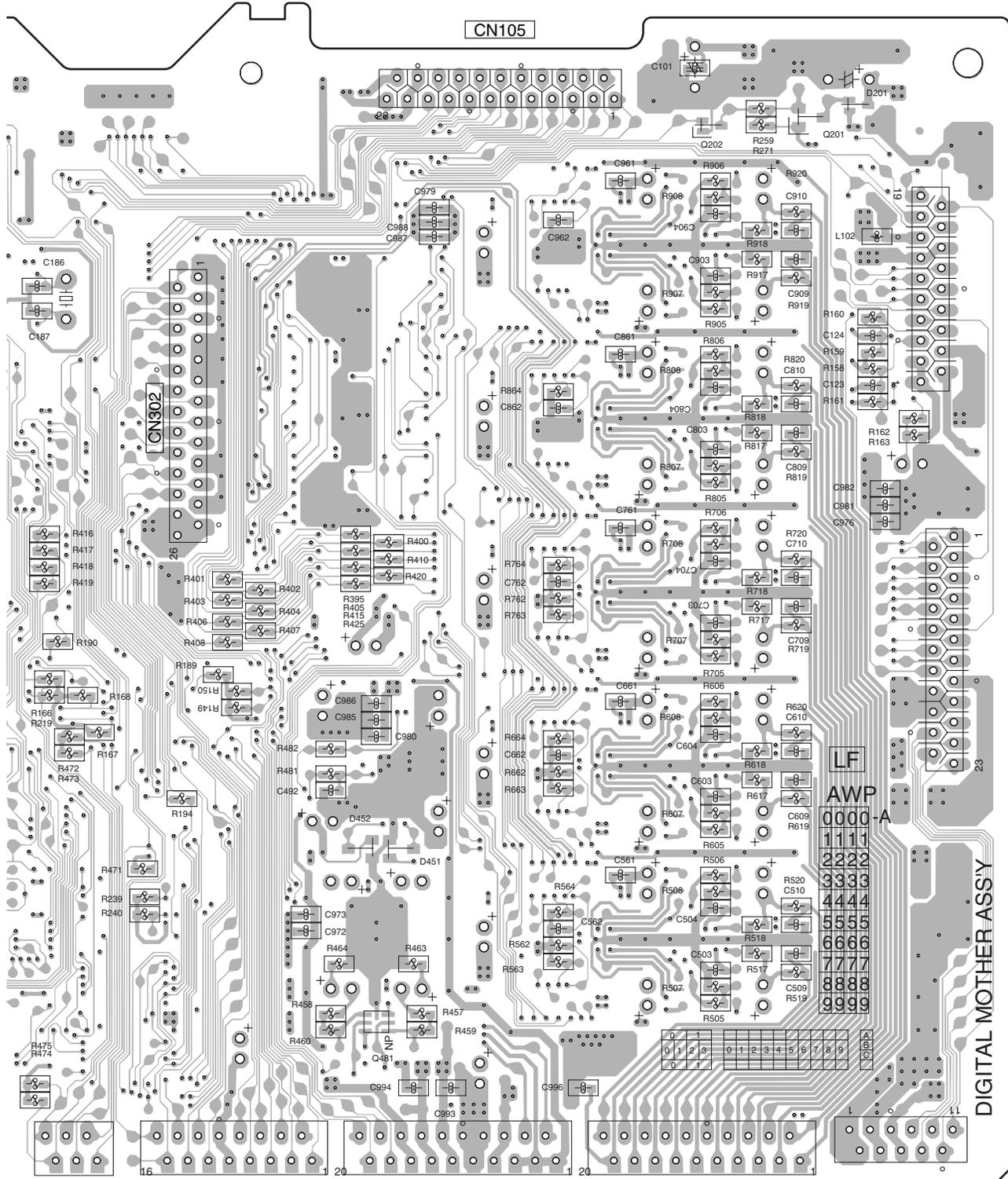

10 X

20 ↓

30

40

50

60

70

80

90

100

110

120

130

140

150

B

C

D

E

F

DIGITAL MOTHER ASSY





SIDE B

SIDE B

# M DSP ASSY

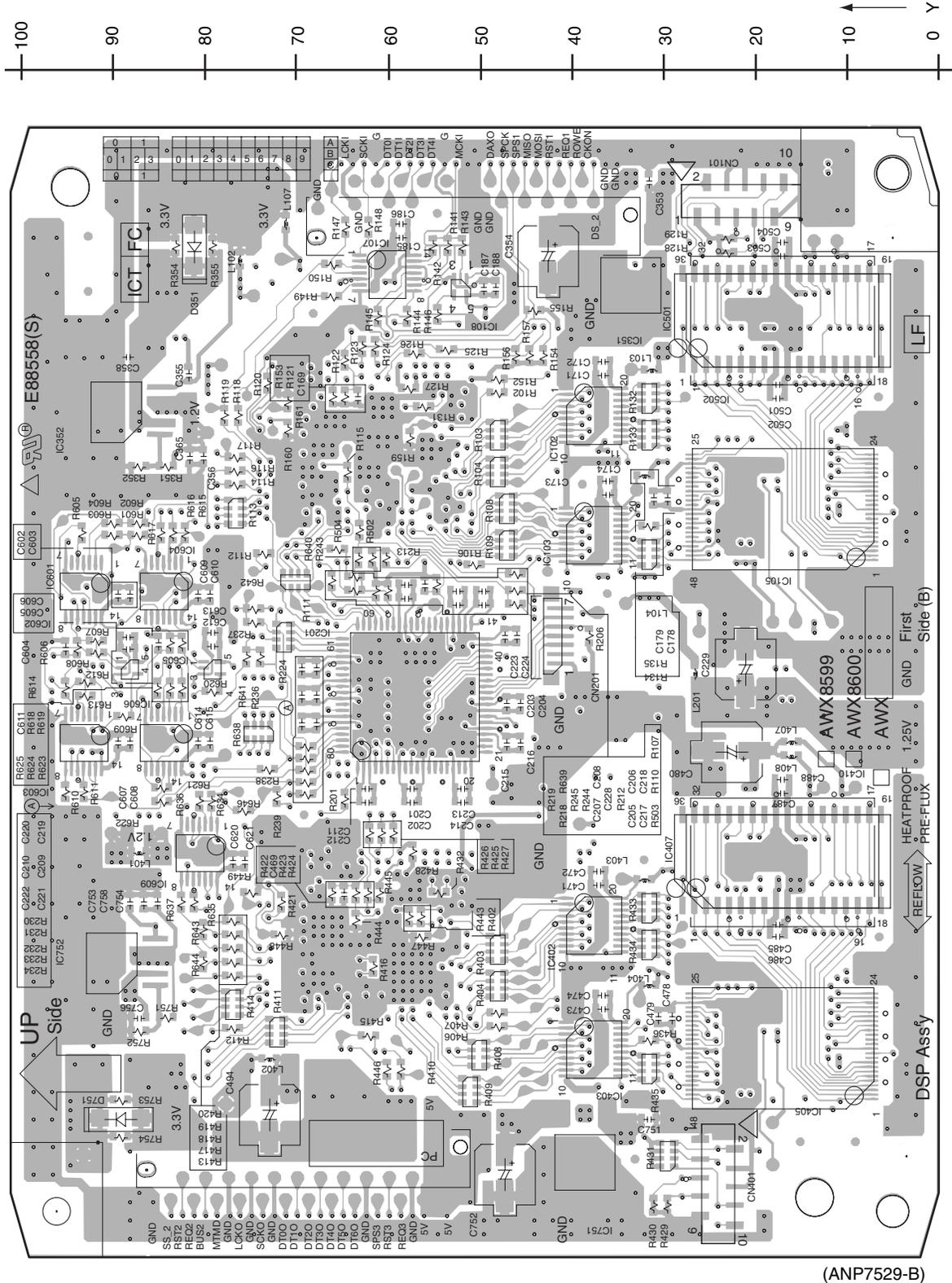

(ANP7529-B)



VSX-74TXVi



**SIDE A**

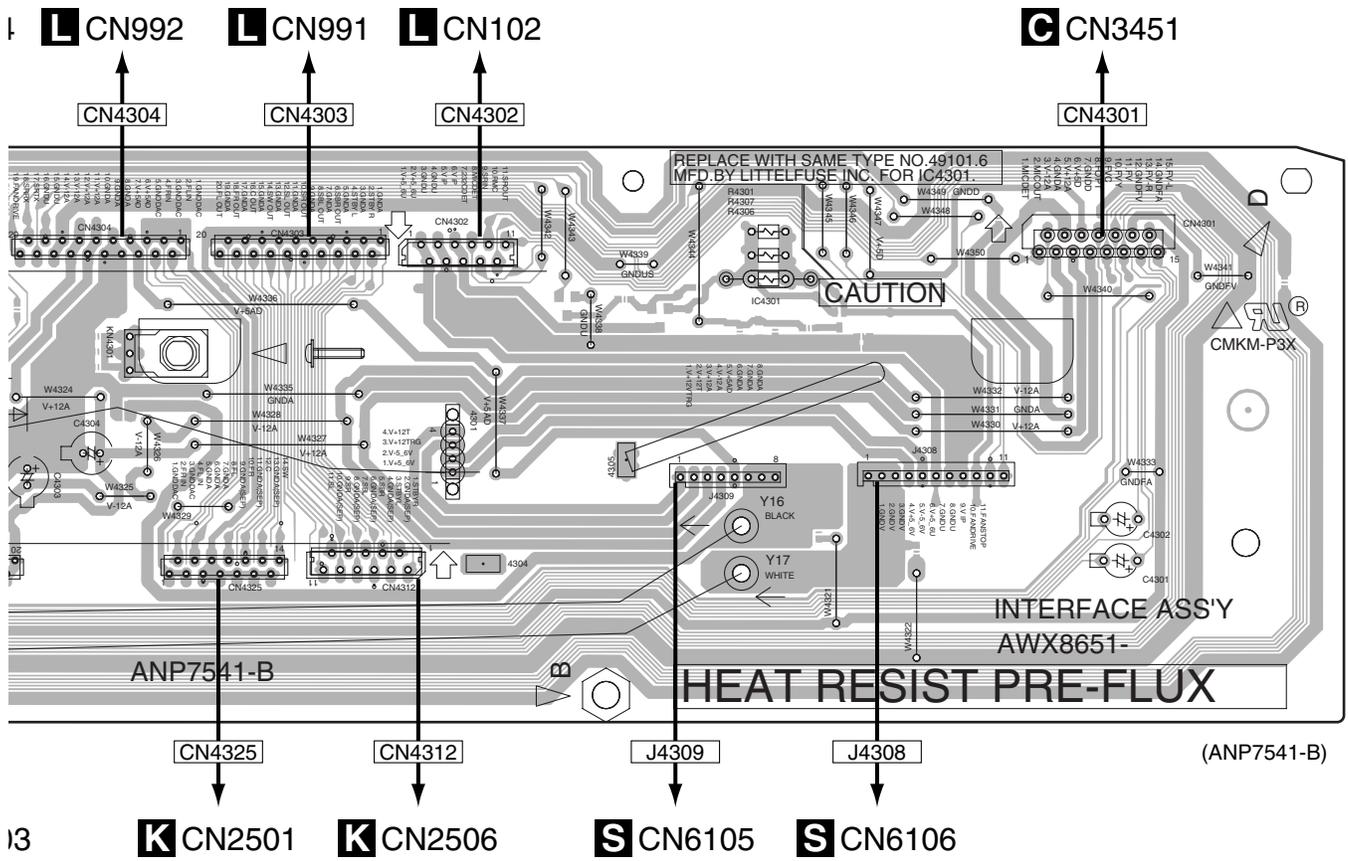

I3 **L** CN992    **L** CN991    **L** CN102    **C** CN3451

**K** CN2501    **K** CN2506    **S** CN6105    **S** CN6106

A  
B  
C  
D  
E  
F

**N**

**SIDE B**

**N** INTERFACE ASSY

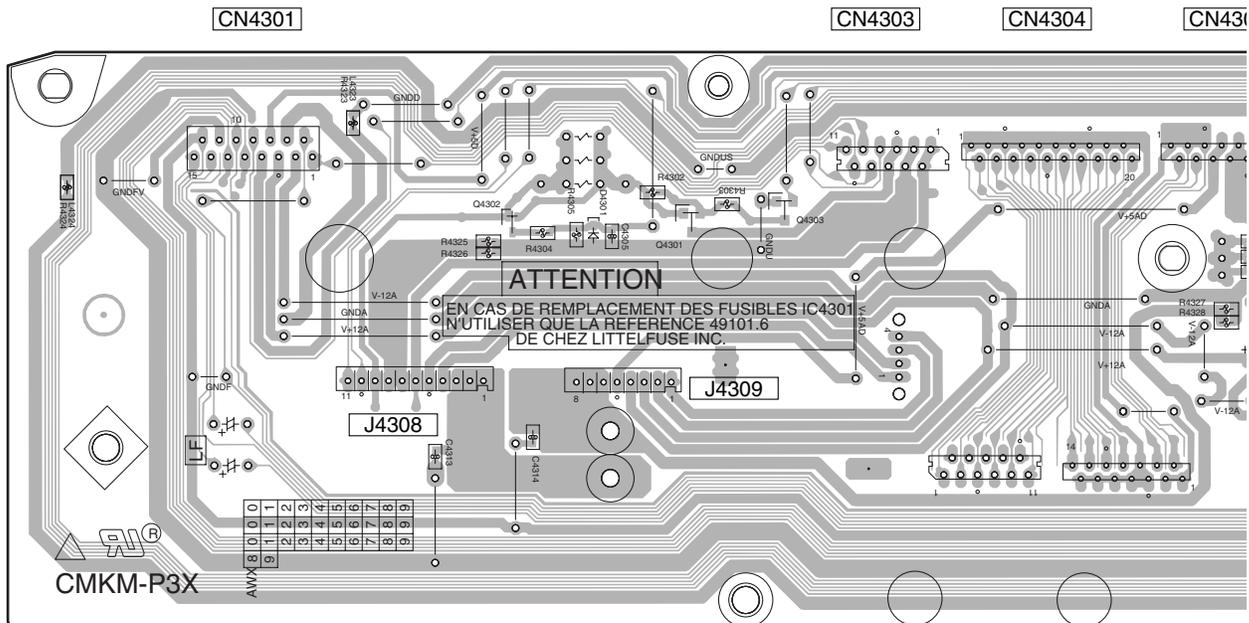

(ANP7540-A)

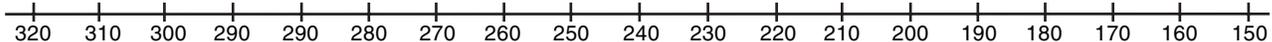

**N**

**SIDE B**

A

B

C

D

E

F

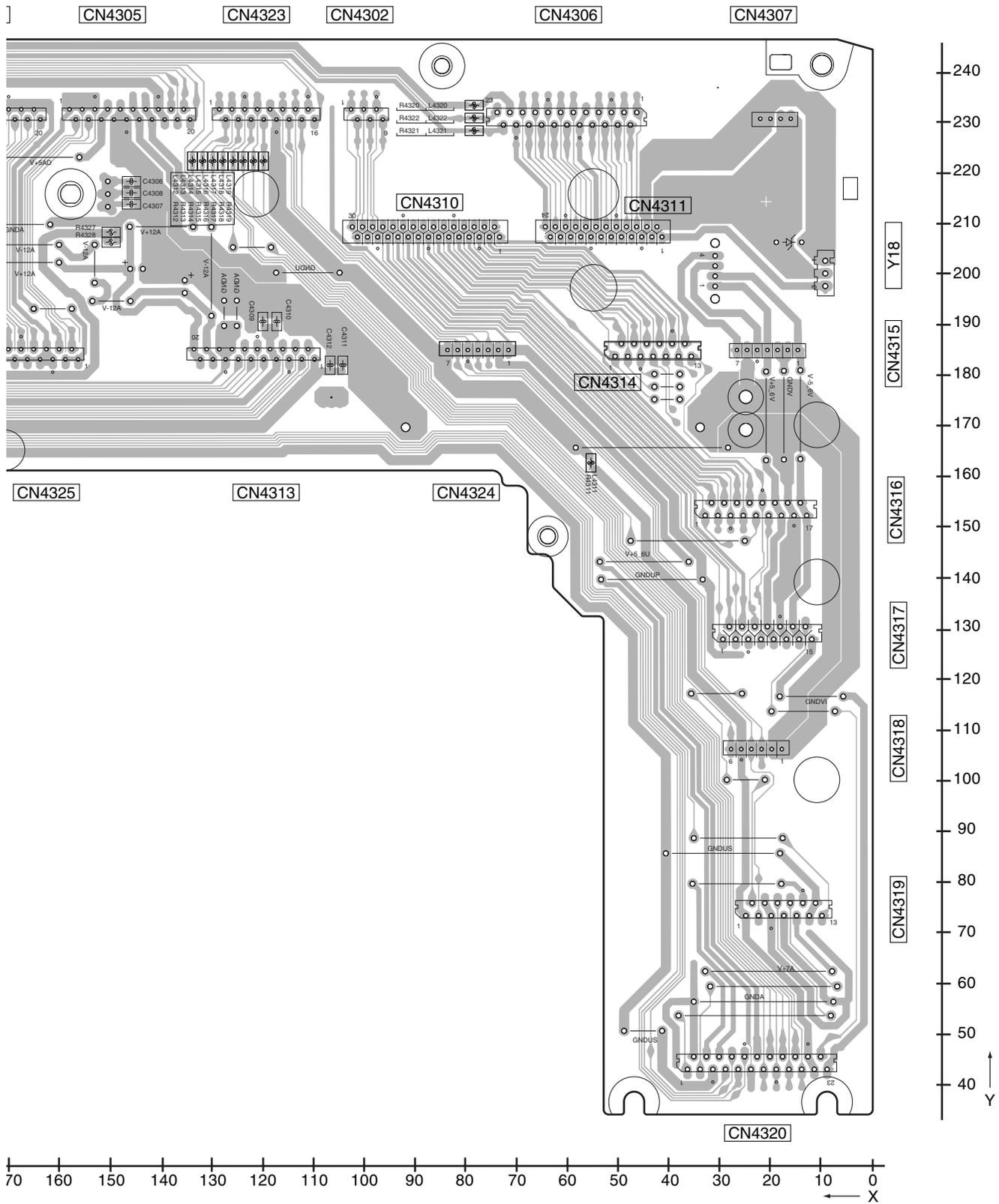

# 4.13 POWER AMP IN ASSY

**SIDE A**

**SIDE A**

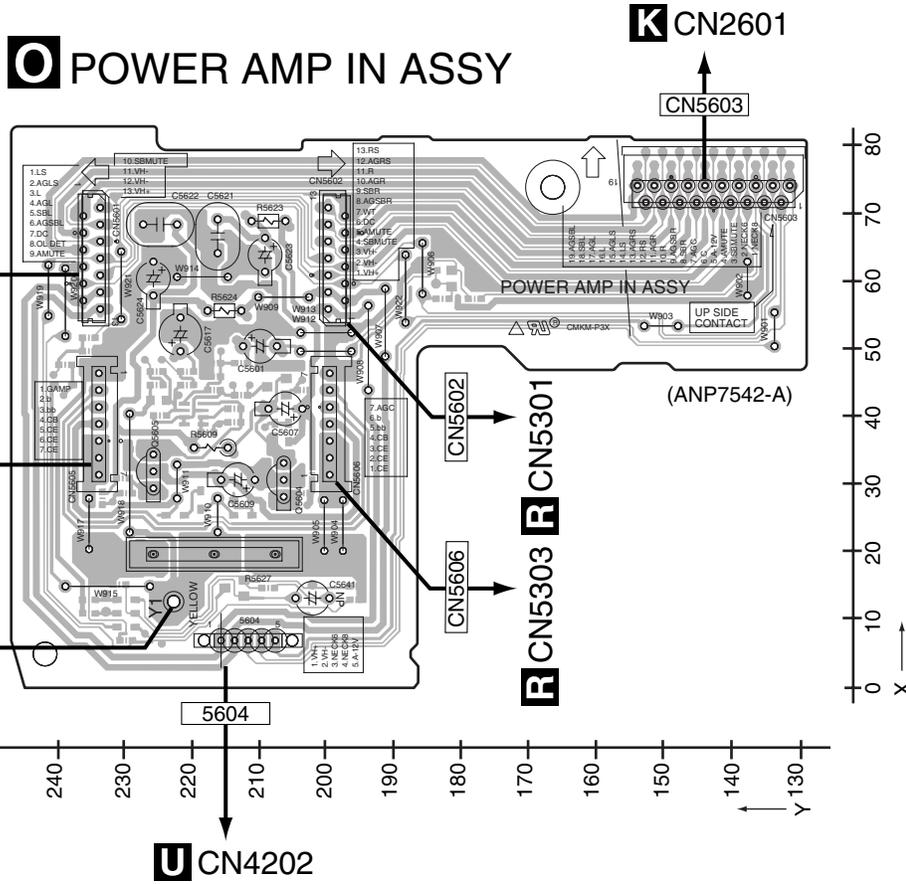

**SIDE B**

**SIDE B**

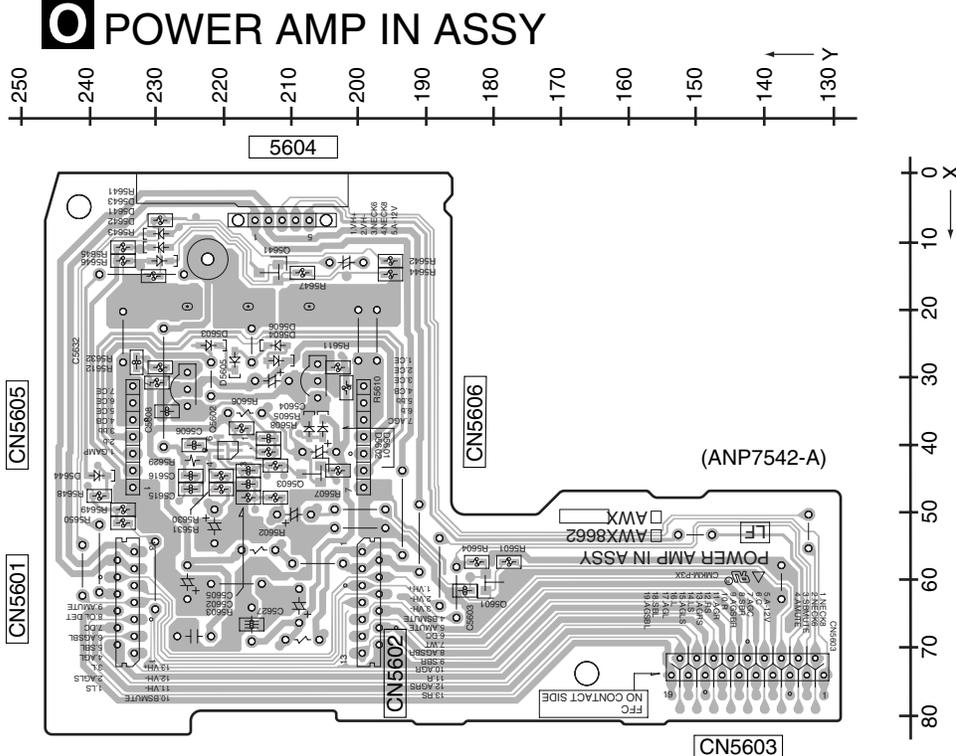



# 4.14 POWER PROTECT ASSY

**SIDE A**

**SIDE A**

## P POWER PROTECT ASSY

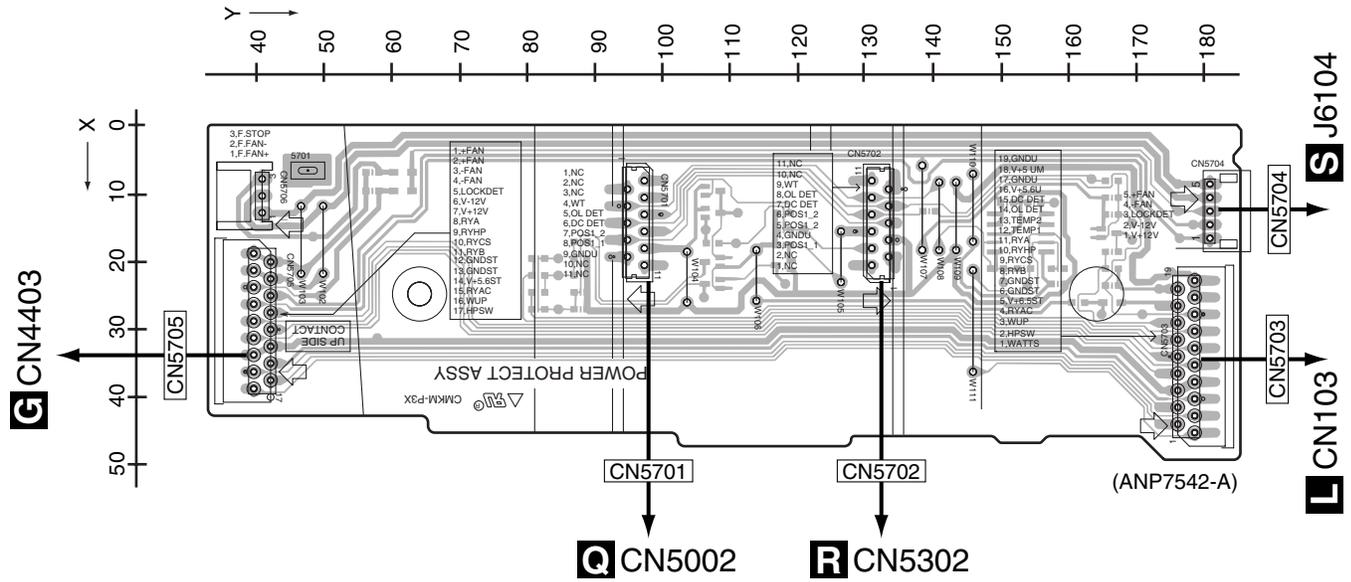

**SIDE B**

**SIDE B**

## P POWER PROTECT ASSY

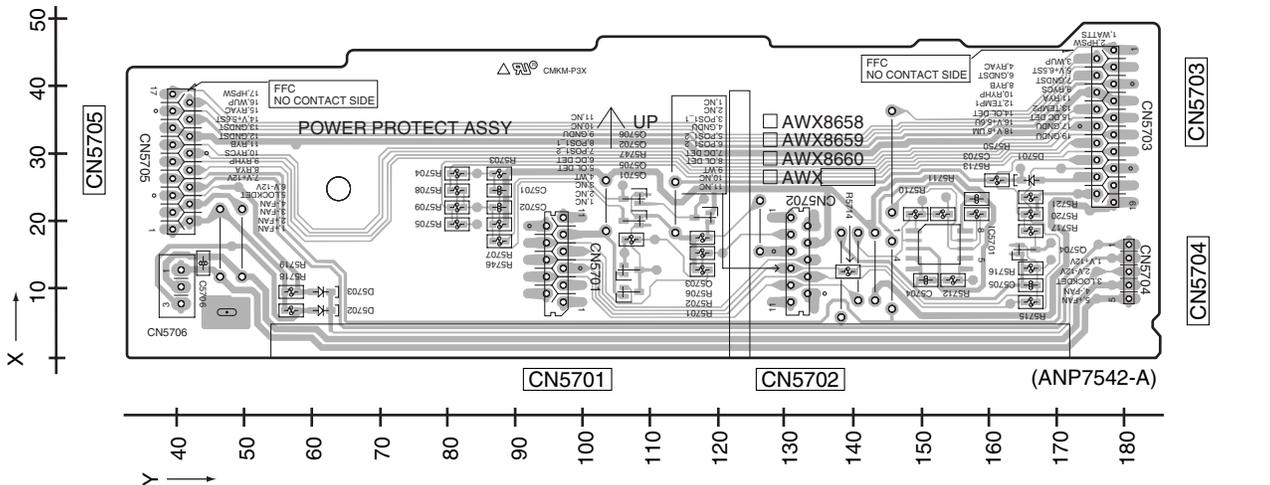

**P**

**P**



**SIDE A**

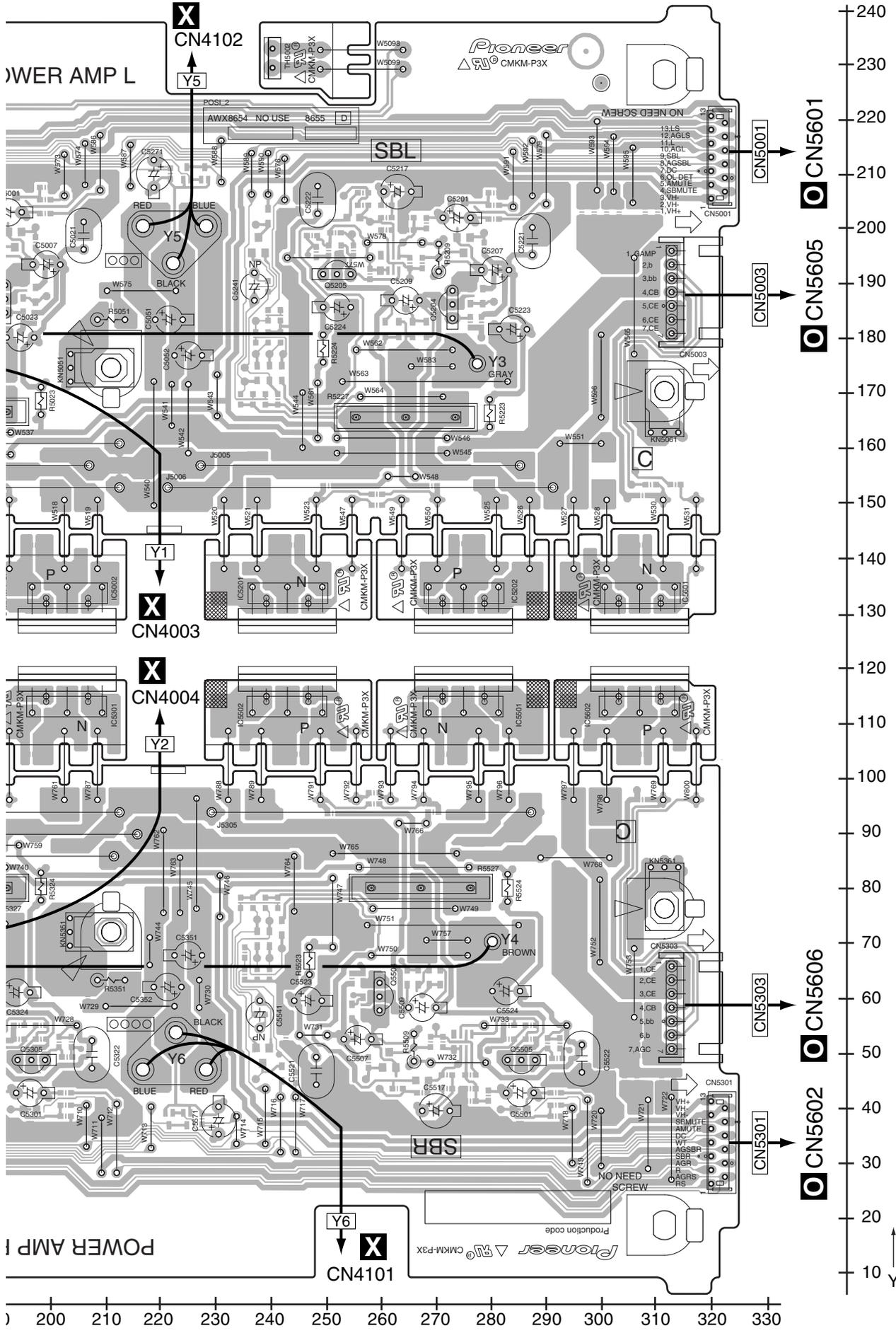

A  
B  
C  
D  
E  
F

**Q R**

**SIDE B**

**Q** POWER AMP  
L ASSY

A

B

C

D

E

F

(ANP7542-A)

(ANP7542-A)

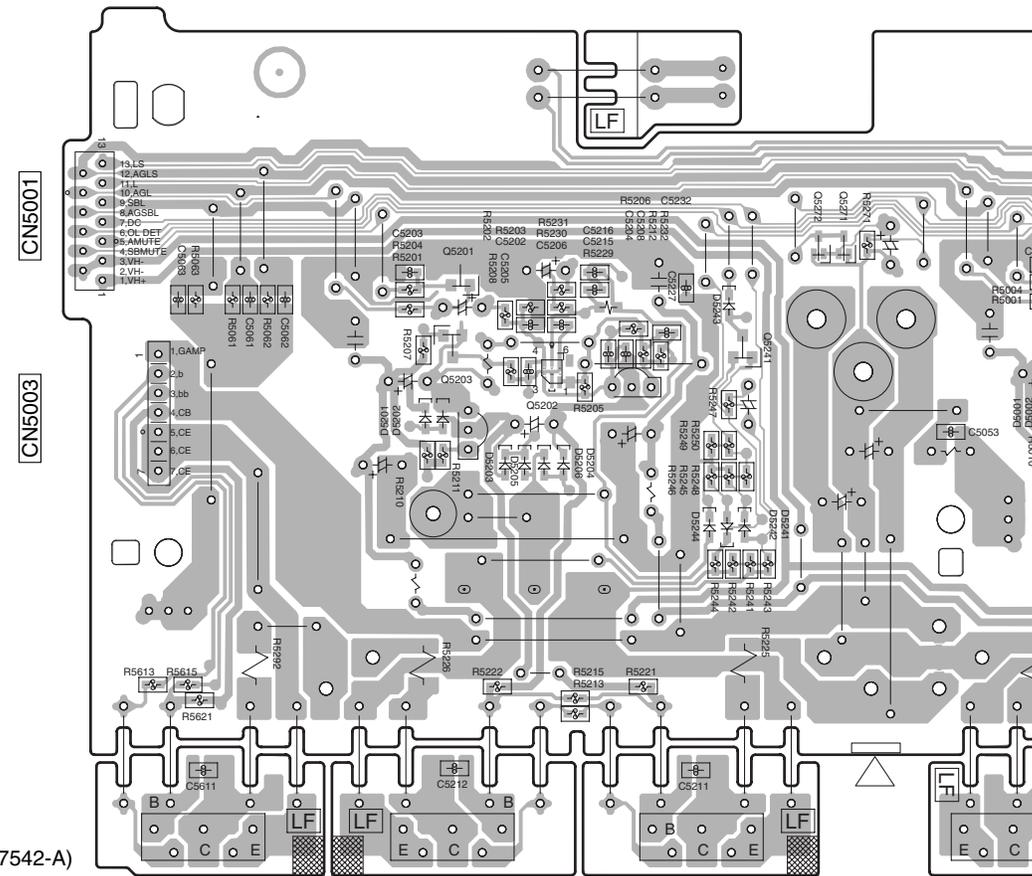

**R** POWER AMP  
R ASSY

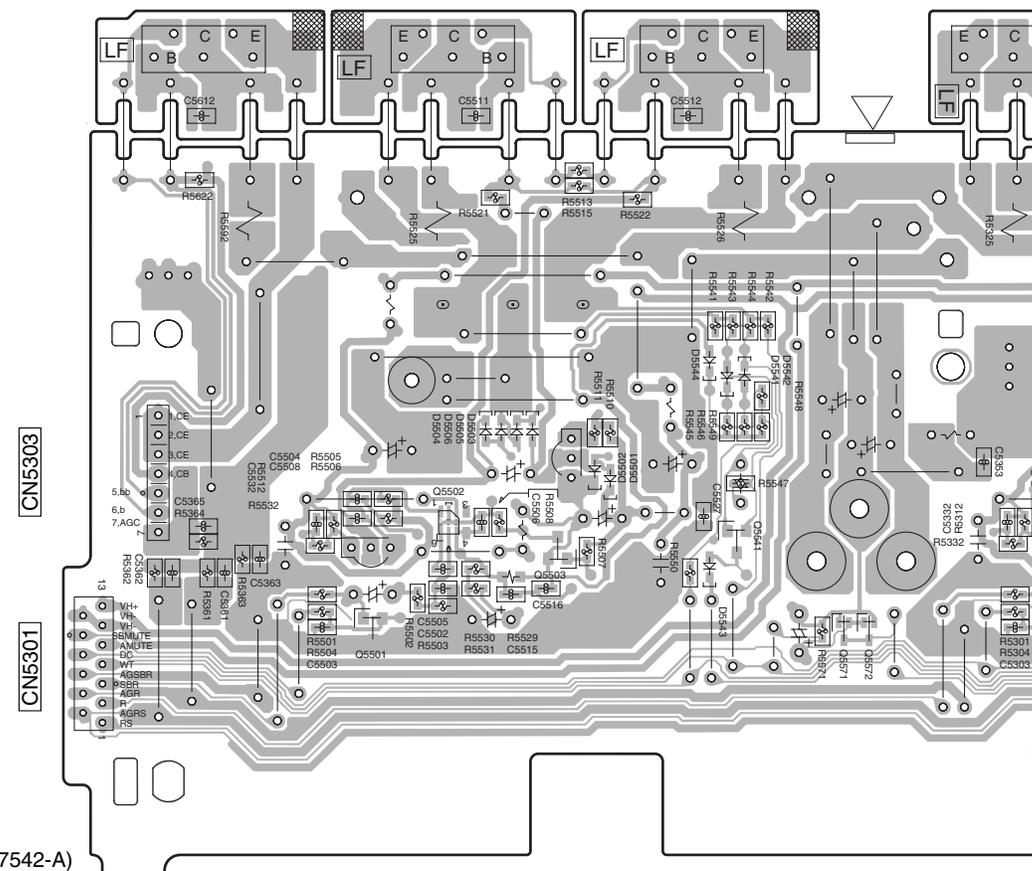

**Q R**

330 320 310 300 290 280 270 260 250 240 230 220 210 200

VSX-74TXVi

**SIDE B**

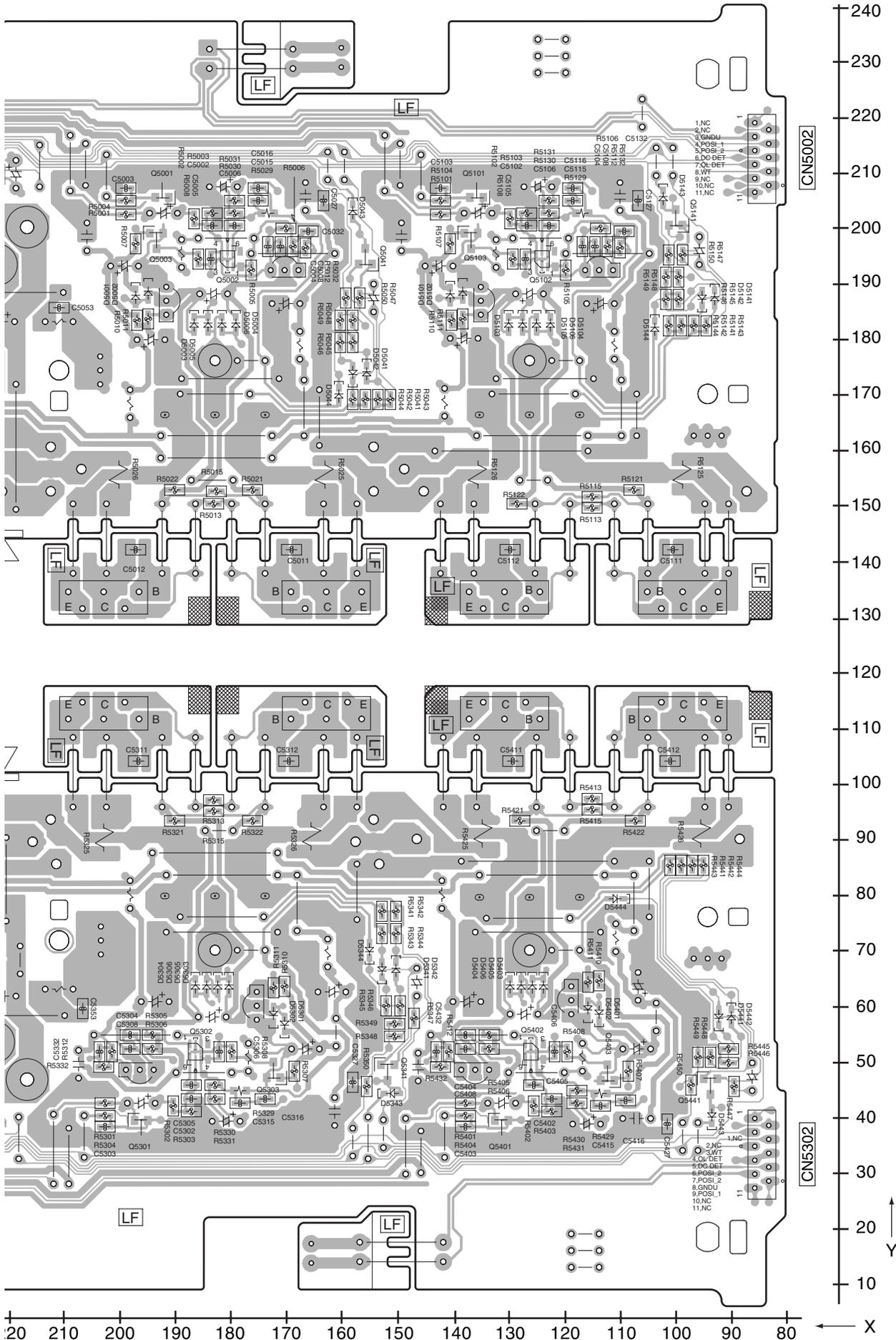

A  
B  
C  
D  
E  
F

**Q R**

# 4.16 LOCAL SUPPLY and DC/DC ASSYS

**SIDE A**

**SIDE A**

## S LOCAL SUPPLY ASSY

A

B

C

D

E

F

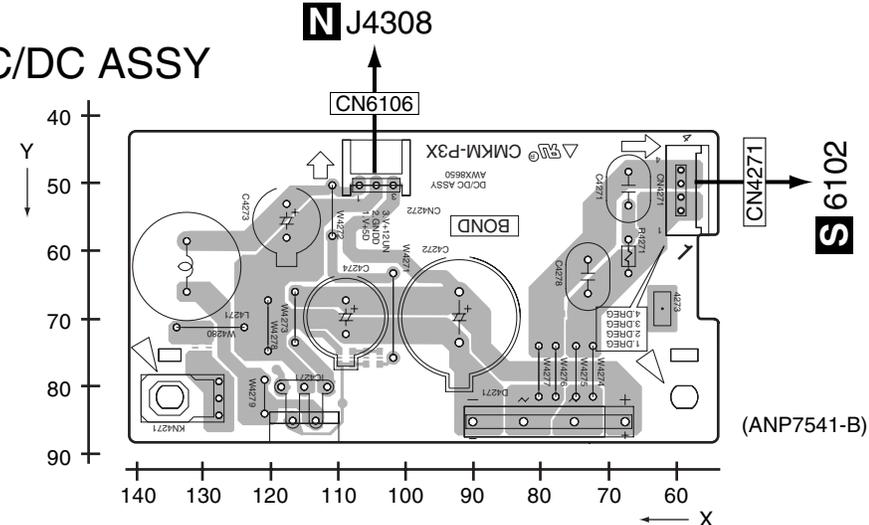
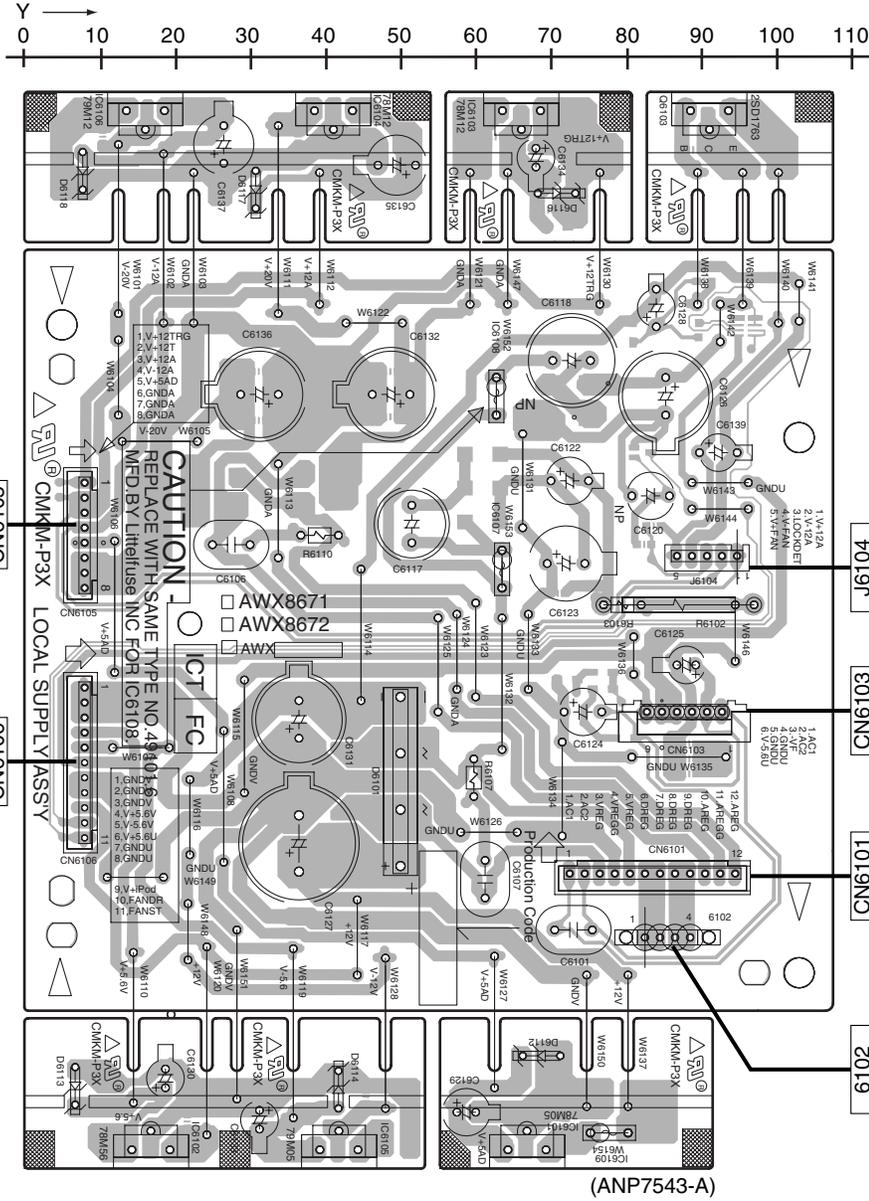

**S T**

**S T**

SIDE B

SIDE B

# S LOCAL SUPPLY ASSY

A

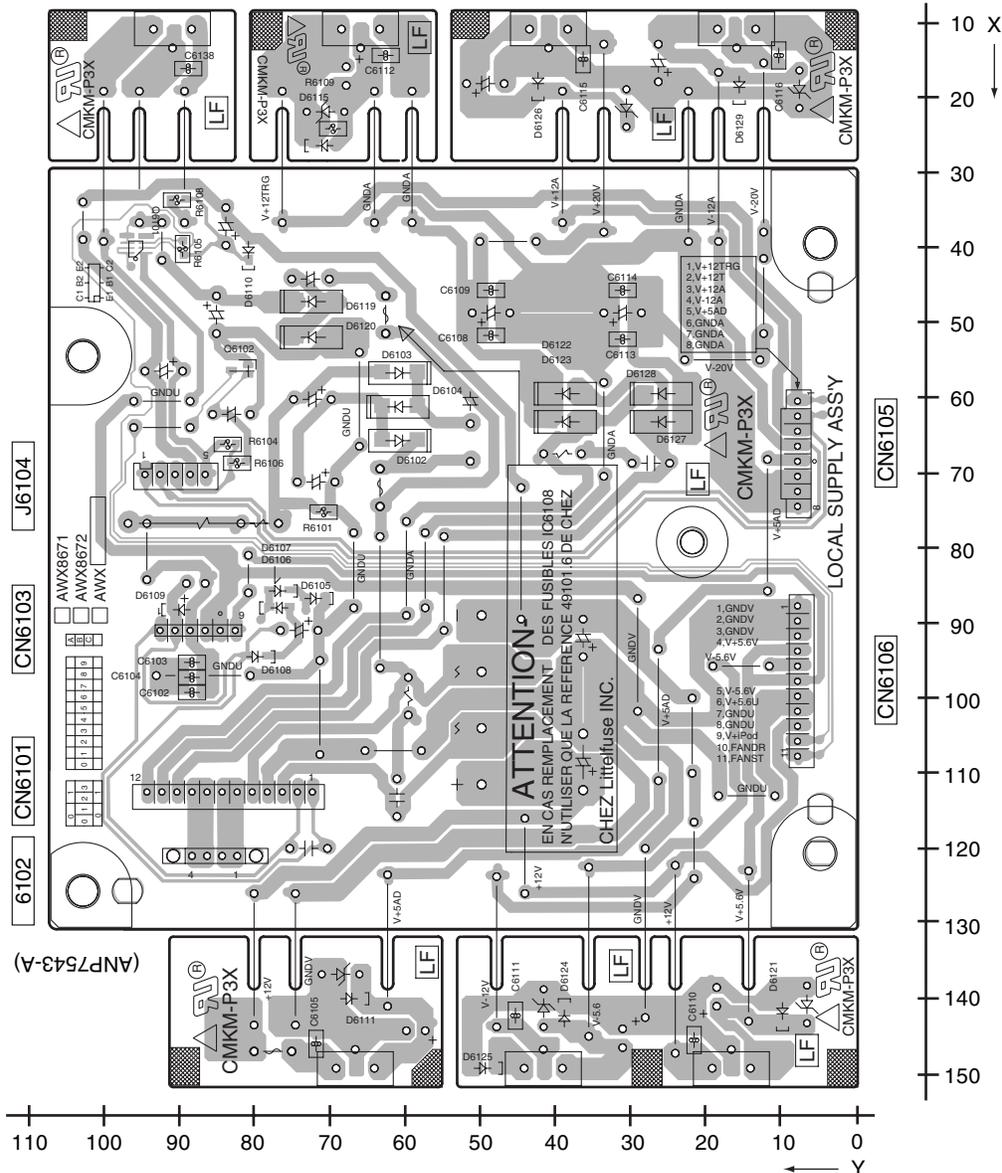

B

C

D

# T DC/DC ASSY

E

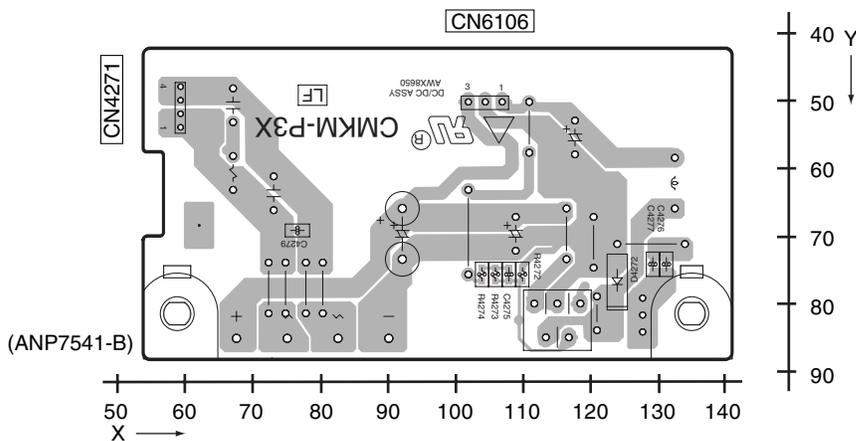

F

S T

S T

# 4.17 TRANS2-1, VH TR, DIODE and TRANS2-2 ASSYS

**SIDE A**

**DIODE ASSY**

**SIDE A**

**V VH TR ASSY**

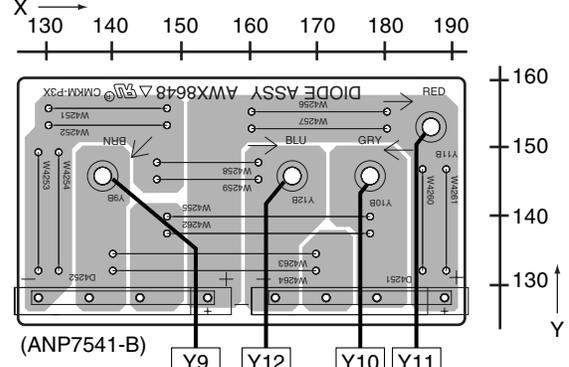
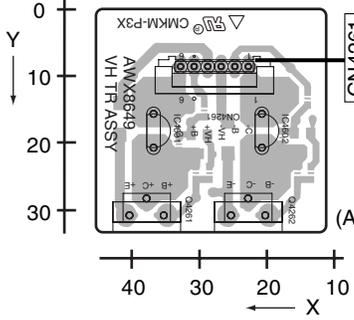

**U TRANS2-1 ASSY**

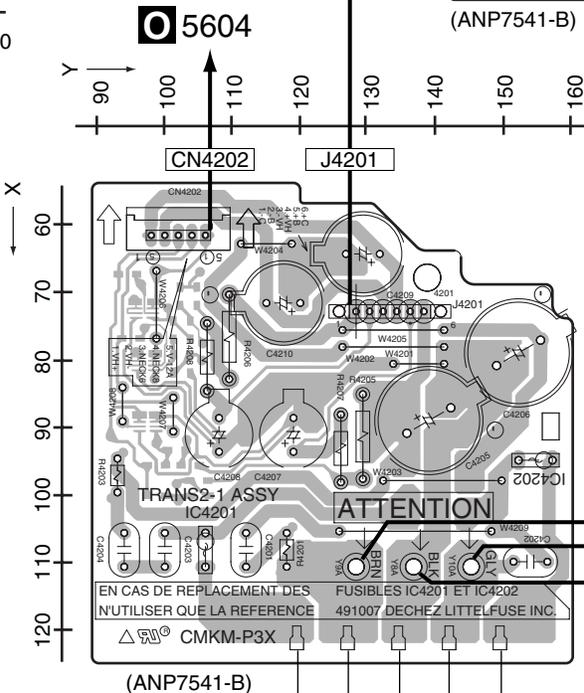

**Z TRANS 1 ASSY**

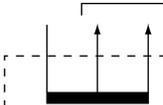

POWER TRANSFORMER

**Y TRANS2-2 ASSY**

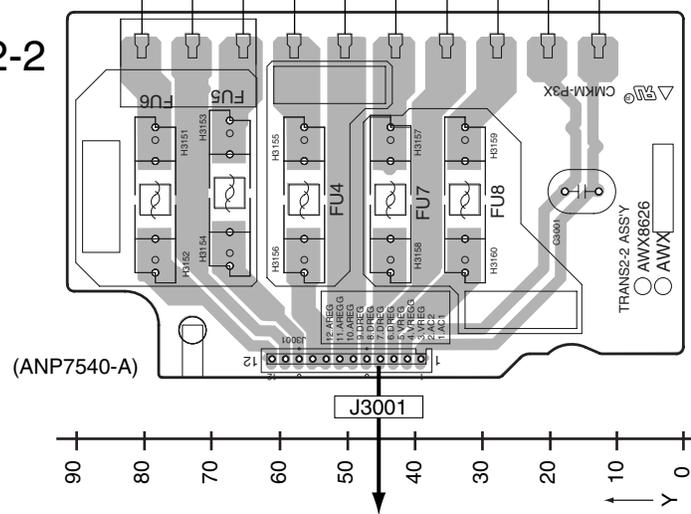

**U V W Y**

**S CN6101**

**U V W Y**



**SIDE B**

# W DIODE ASSY

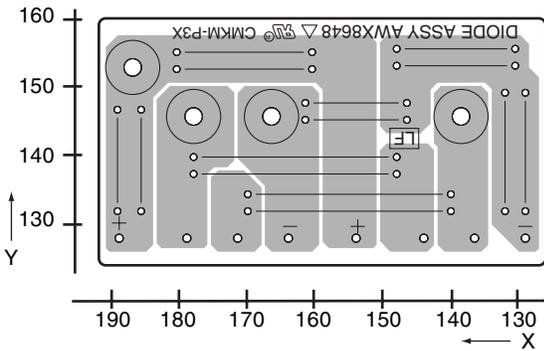

**SIDE B**

# V VH TR ASSY

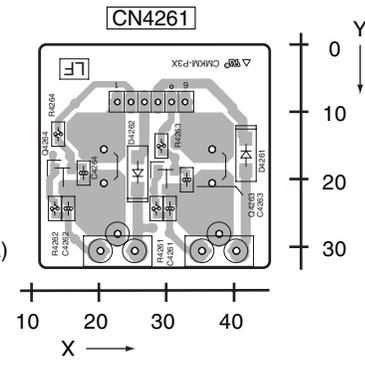

# U TRANS2-1 ASSY

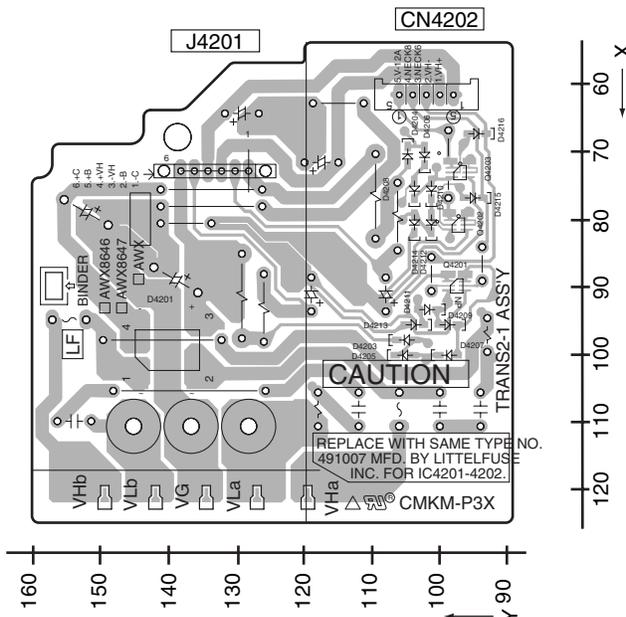

# Y TRANS2-2 ASSY

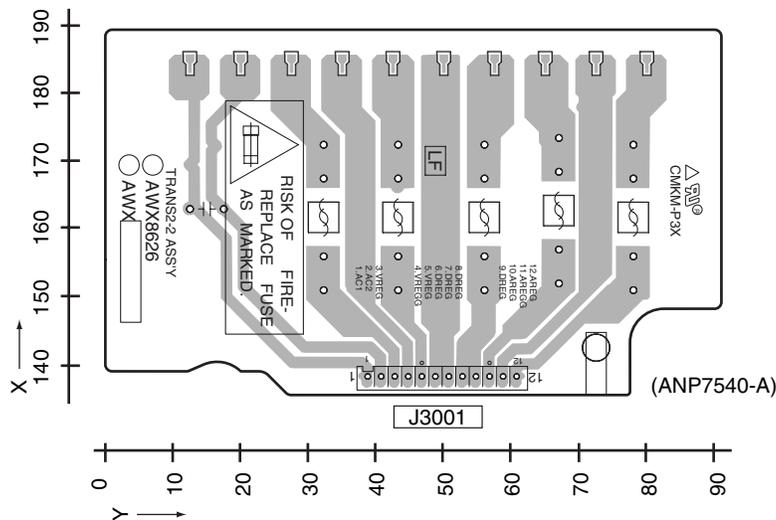

**U V W Y**

**U V W Y**

# 4.18 SP/PS ASSY

**SIDE A**

**SIDE A**

**X** SP/PS ASSY

**G** CN4402

X  
140  
150  
160  
170  
180  
190  
200  
210  
220  
230  
240  
250  
260  
270  
280  
290  
300  
310  
320  
330

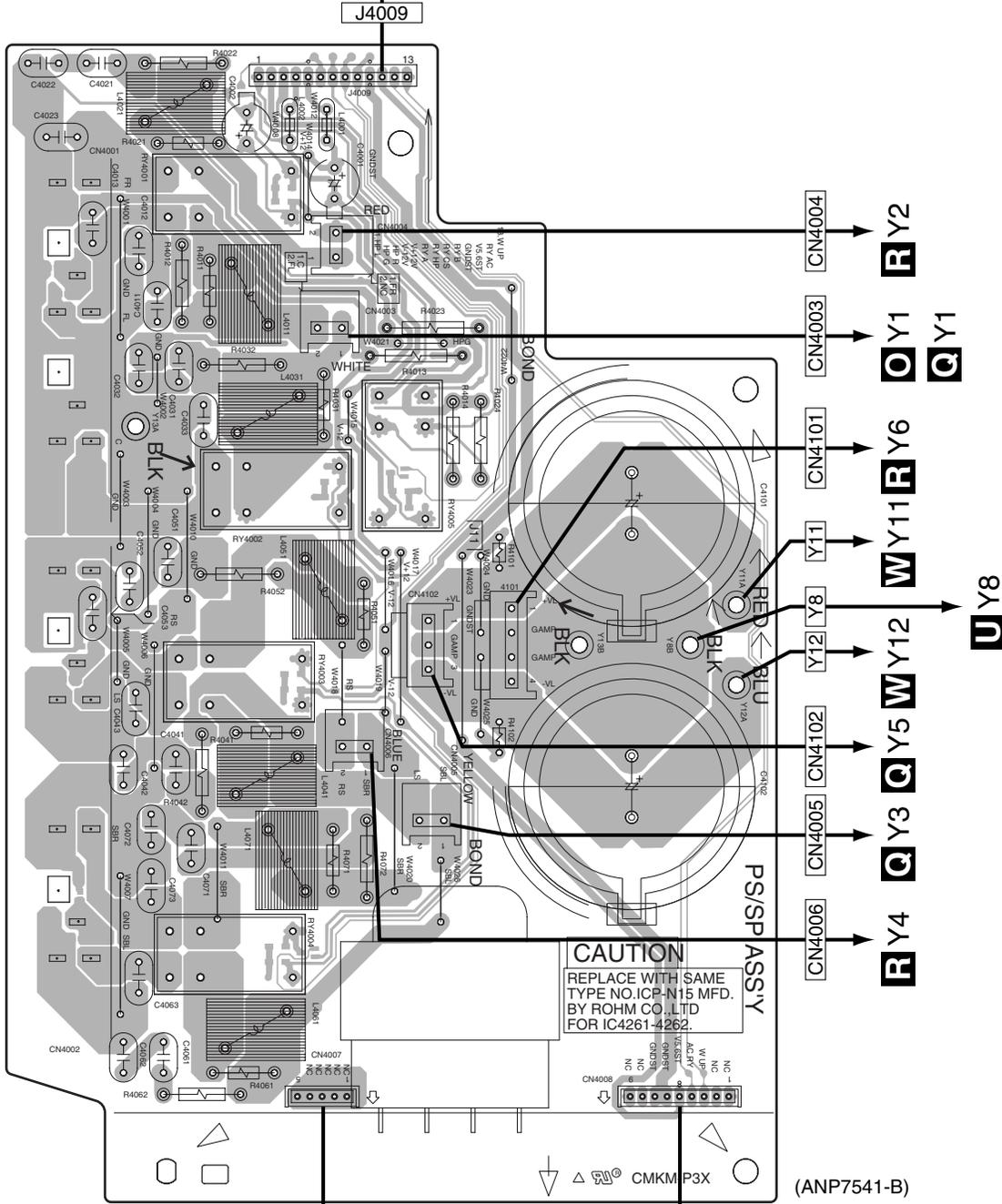

J4009

CN4004

**R** Y2

CN4003

**O** Y1 **Q** Y1

CN4101

**R** Y6

Y11

**W** Y11 **R** Y6

Y11

Y12

**W** Y12 **U** Y8

CN4102

**Q** Y5 **W** Y12

CN4005

**Q** Y3 **Q** Y5

CN4006

**R** Y4

**CAUTION**  
REPLACE WITH SAME  
TYPE NO. ICP-N15 MFD.  
BY ROHM CO., LTD  
FOR IC4261-4262.

PS/PS ASSY

(ANP7541-B)

CN4007

CN4008

Y  
40  
50  
60  
70  
80  
90  
100  
110  
120  
130  
140  
150  
160

**AA** CN3063

**AA** CN3062

**X**

**X**

SIDE B

SIDE B

# X SP/PS ASSY

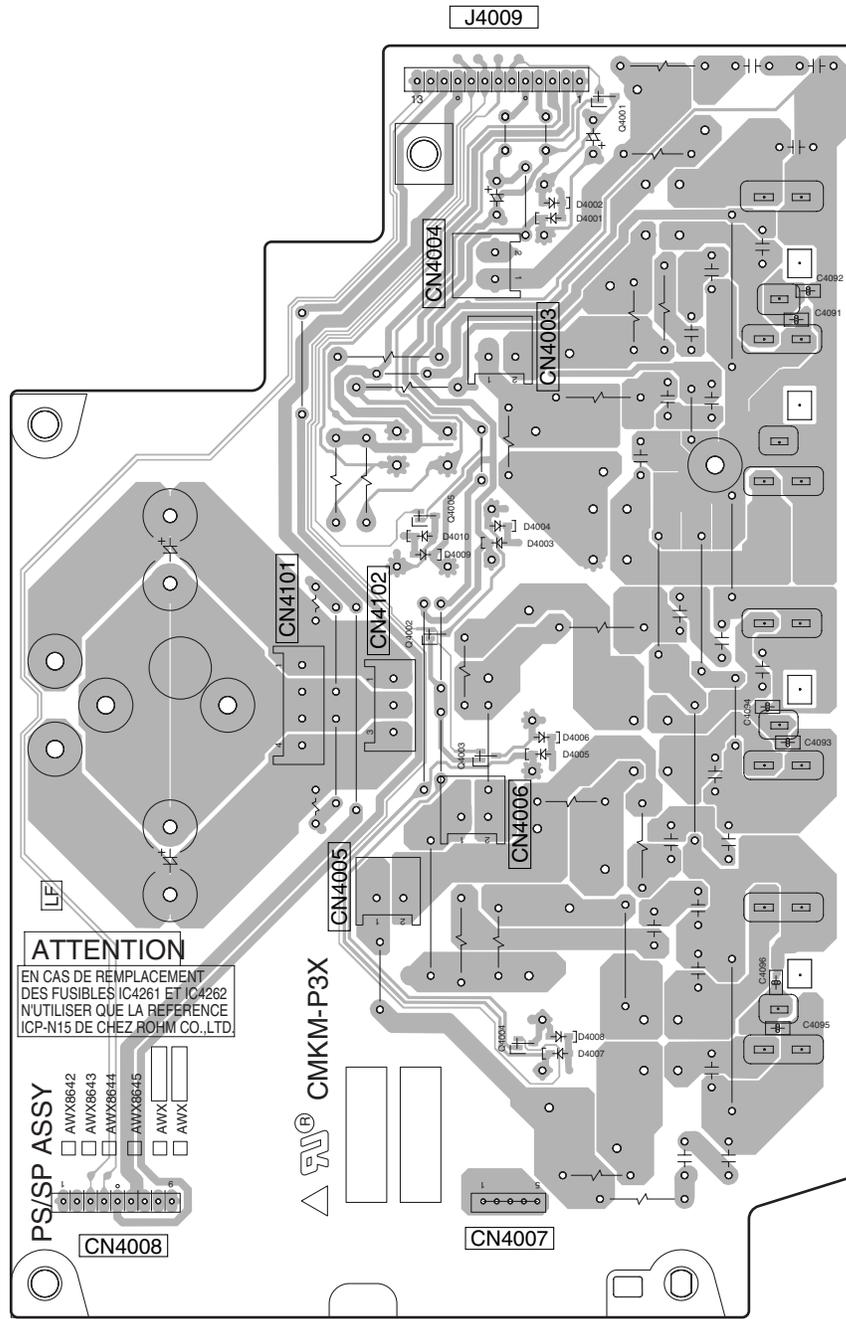

(ANP7540-A)

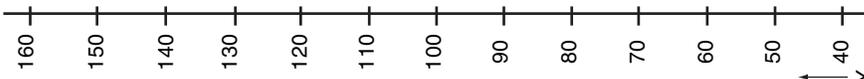

X

X

# 4.19 TRANS1 and PRIMARY ASSYS

**SIDE A**

**SIDE A**

**AA PRIMARY ASSY**

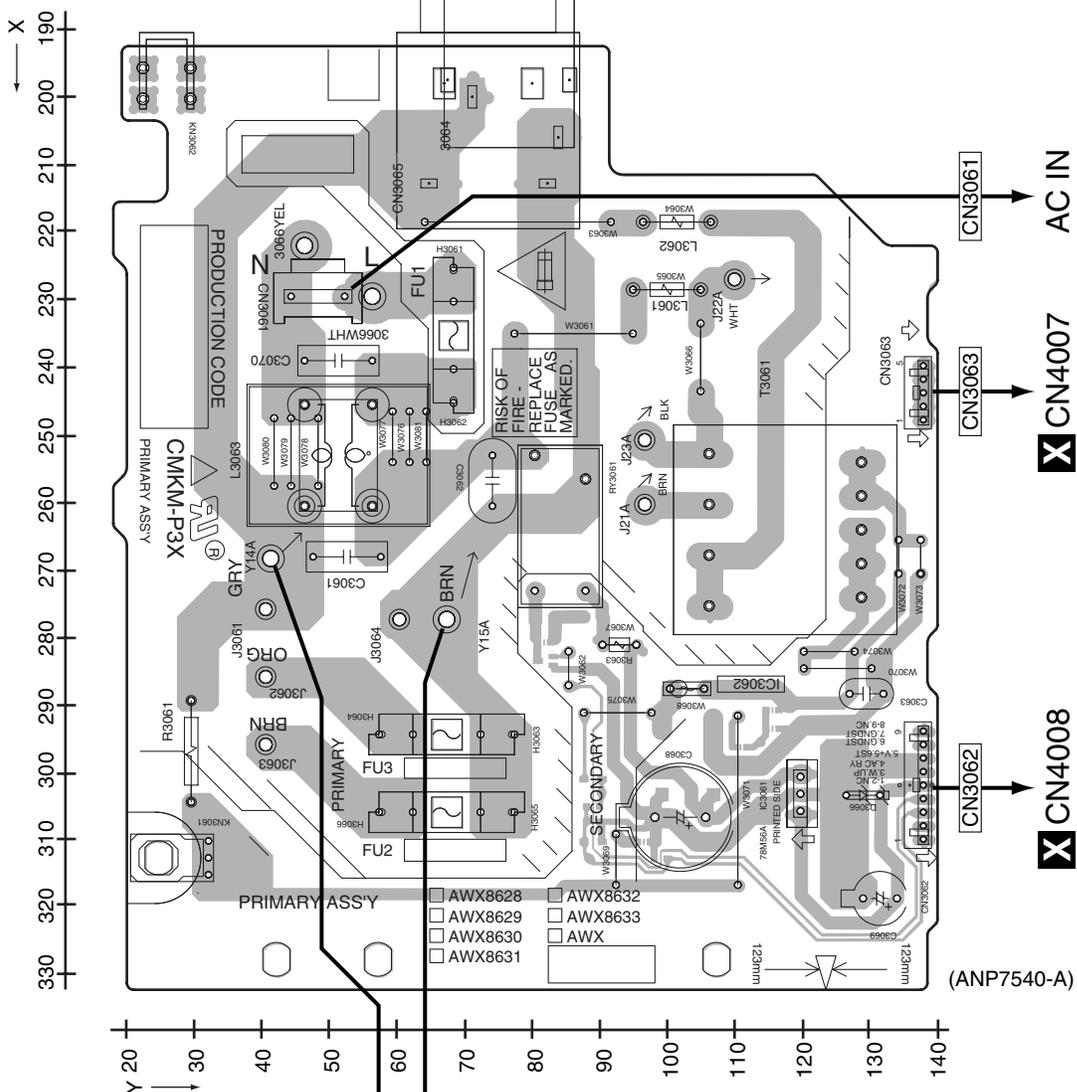

**Z TRANS1 ASSY**

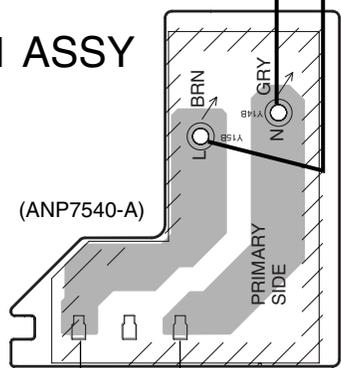

**U TRANS2-1 ASSY**

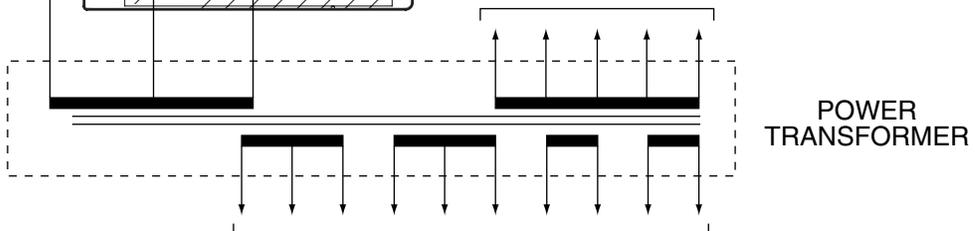

**Y TRANS2-2 ASSY**

VSX-74TXVi

**Z AA**

**Z AA**

SIDE B

SIDE B

# AA PRIMARY ASSY

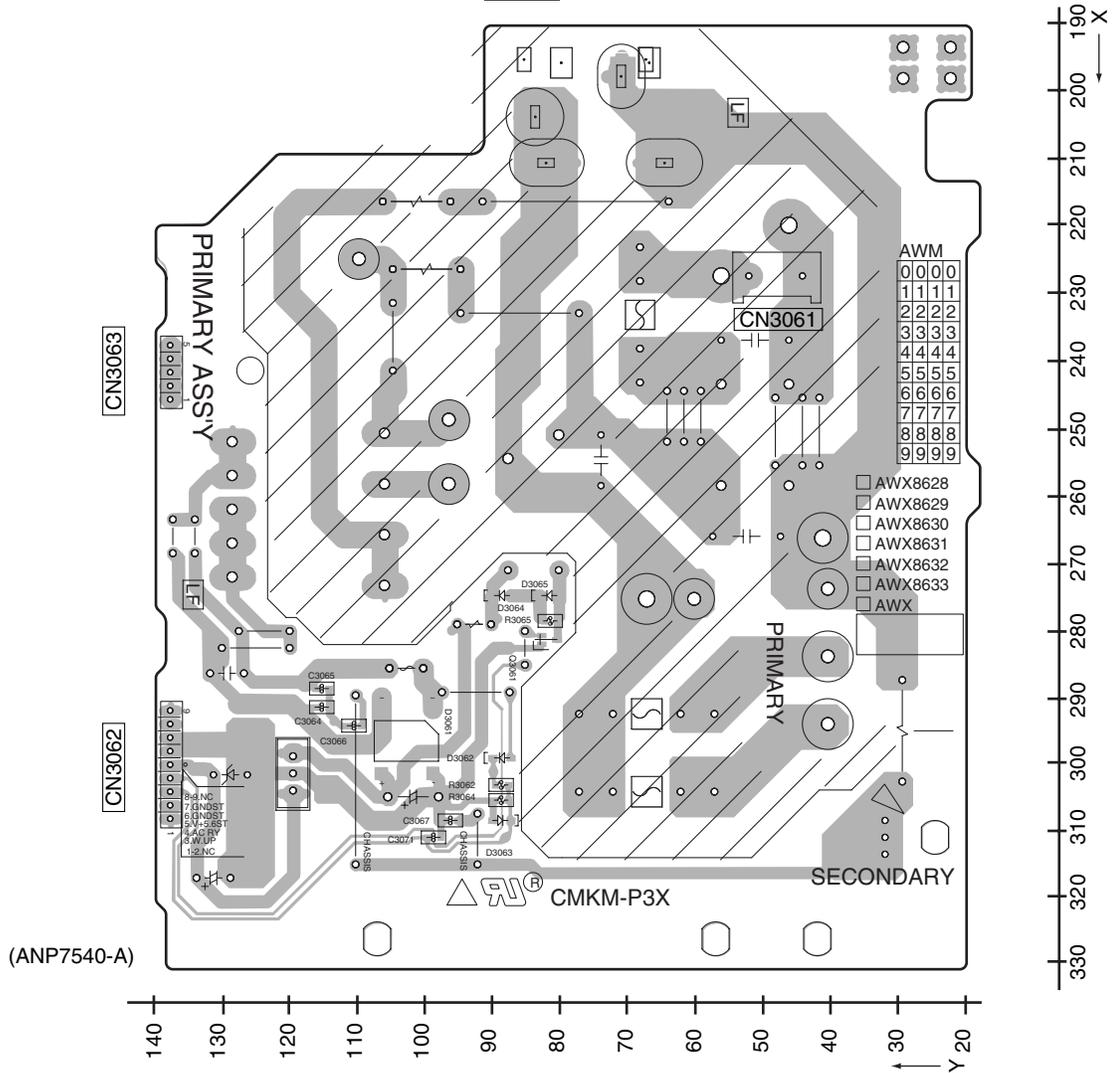

# Z TRANS1 ASSY

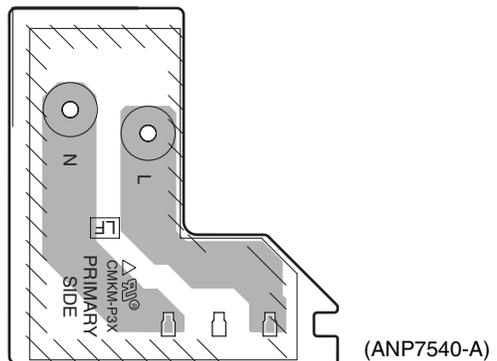

Z AA

Z AA





**SIDE B**

**AB VOLUME ASSY**

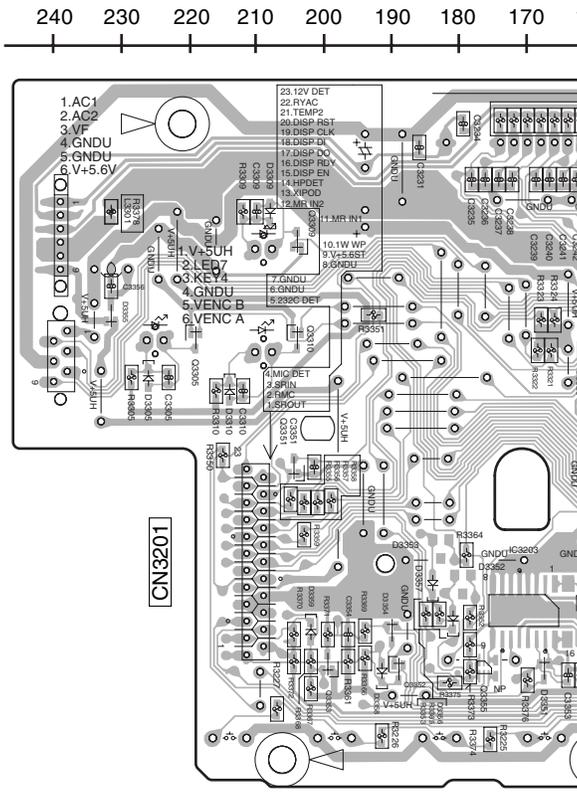
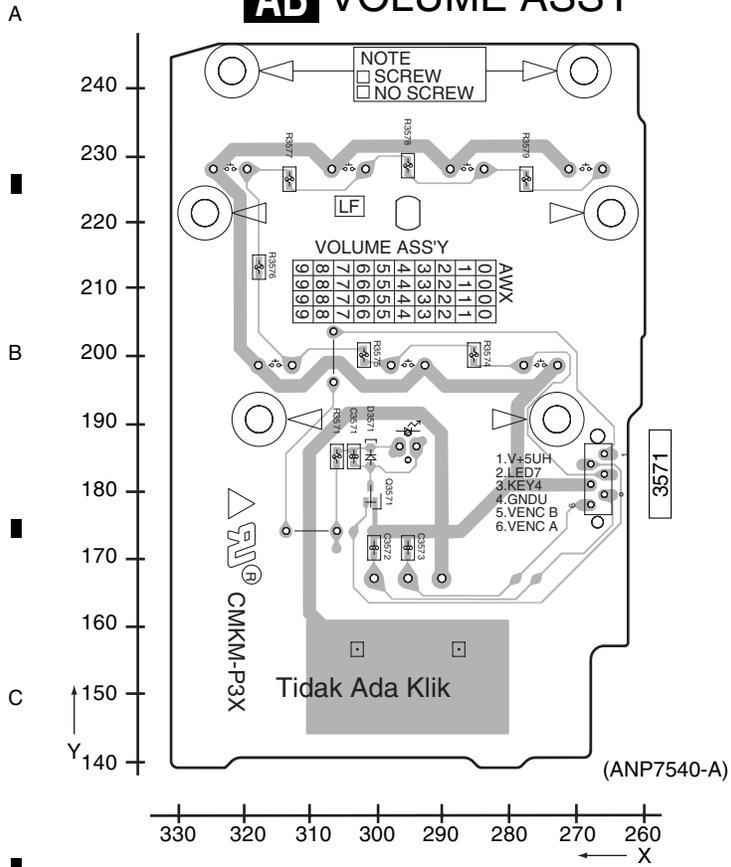

**AC DISPLAY ASSY**

**AB AC**



**SIDE B**

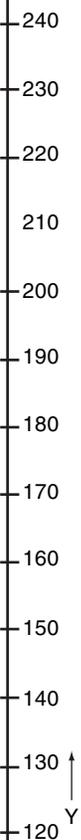
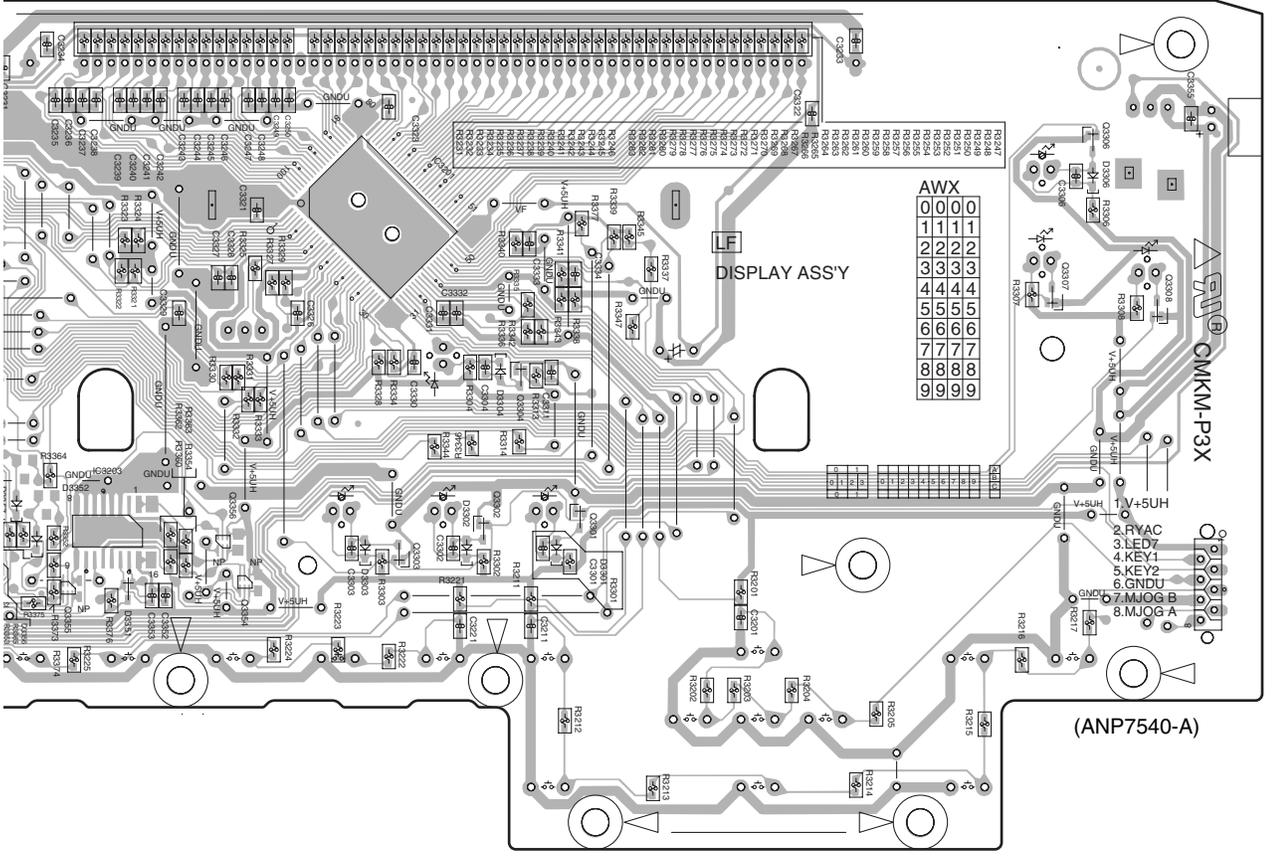
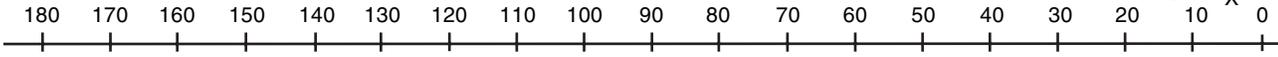

**AD** INPUT SELECT ASSY

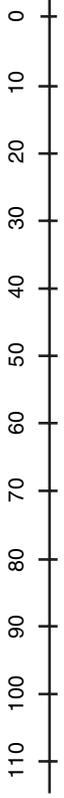
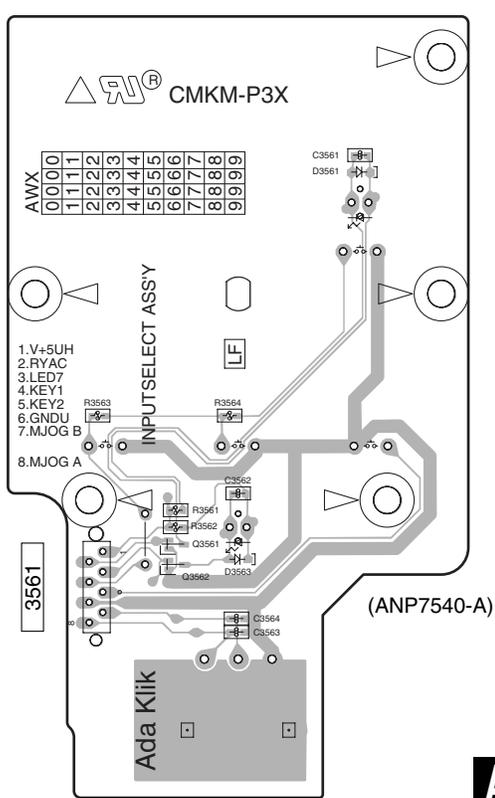

**AC AD**

4.21 HDMI&DVC ASSY

SIDE A

AG HDMI&DVC ASSY

SIDE A

A

B

C

D

E

F

10 20 30 40 50 60 70 80 90

X

10

20

30

40

50

60

70

80

90

100

110

120

130

140

150

160

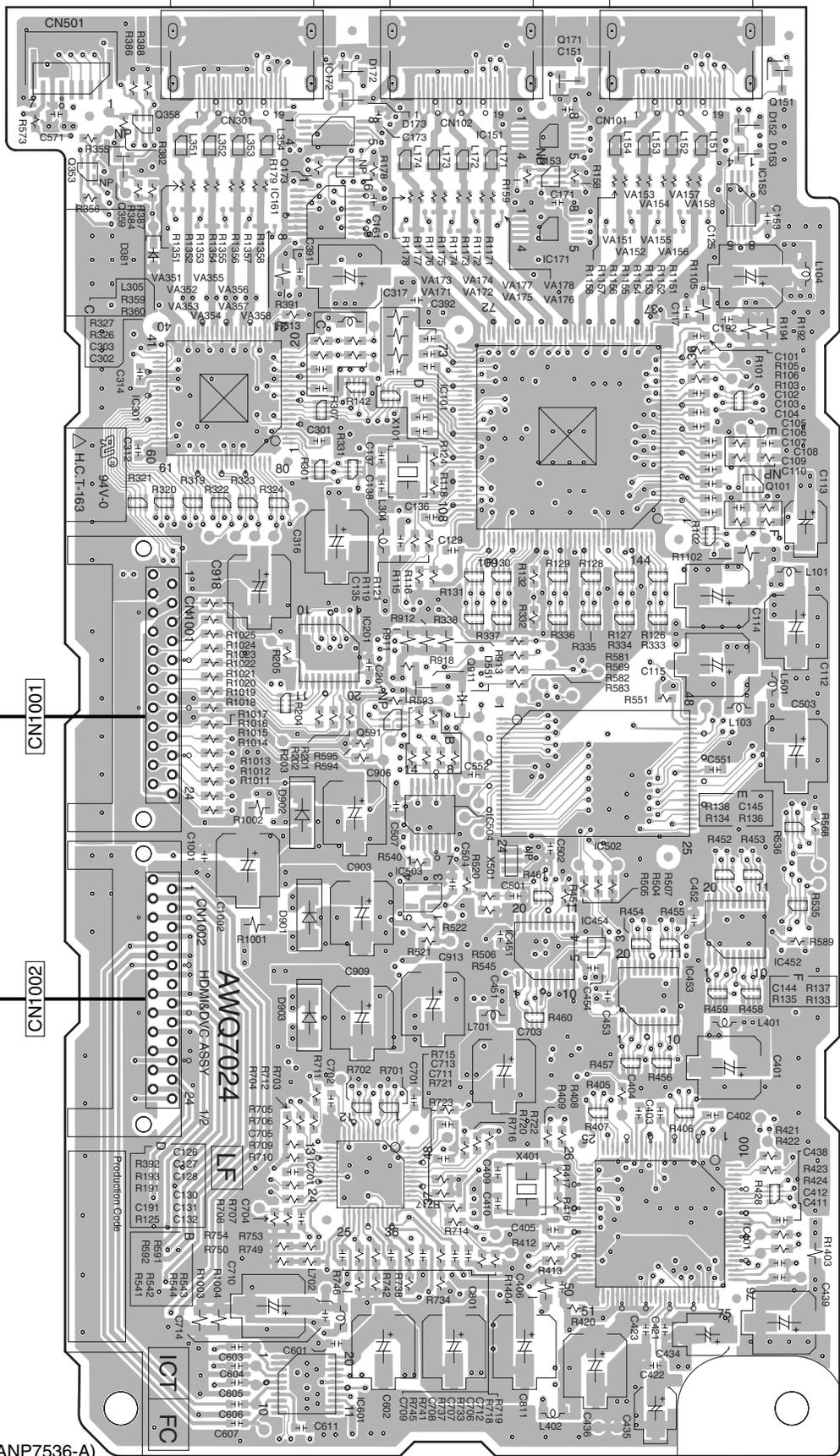

N CN4311

N CN4310

CN1001

CN1002

AWQ7024

Production Code

(ANP7536-A)

VSX-74TXvi

AG

AG



4.22 1394 ASSY

**AF** 1394 ASSY

**SIDE A**

**SIDE A**

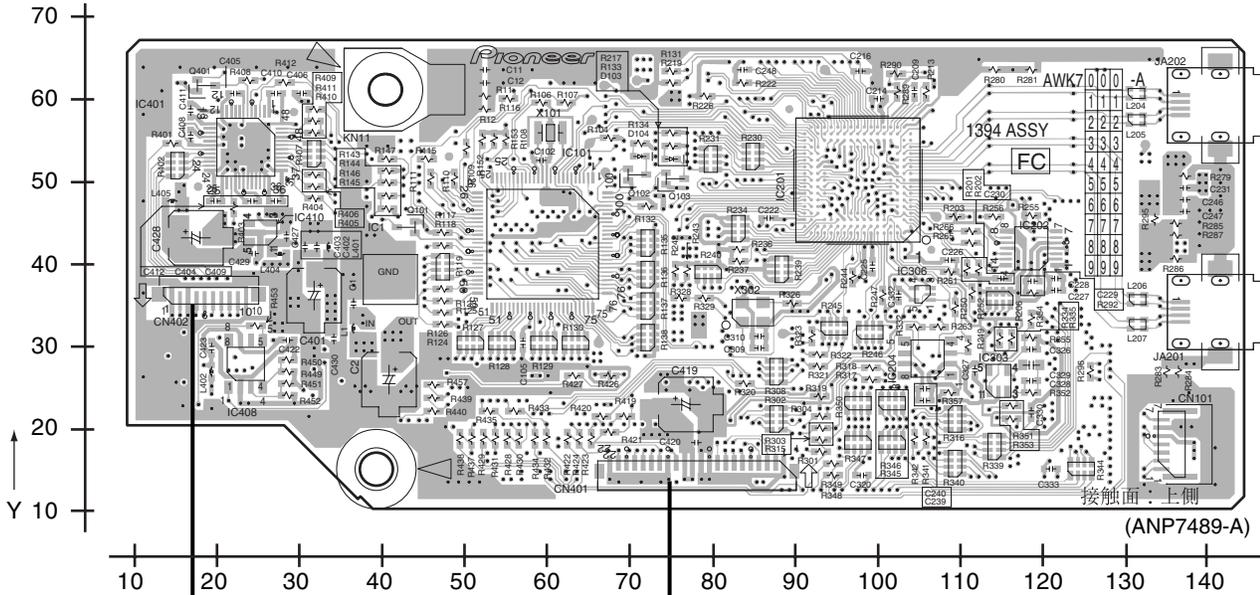

CN402

CN401

**L** CN305

**L** CN303

**SIDE B**

**SIDE B**

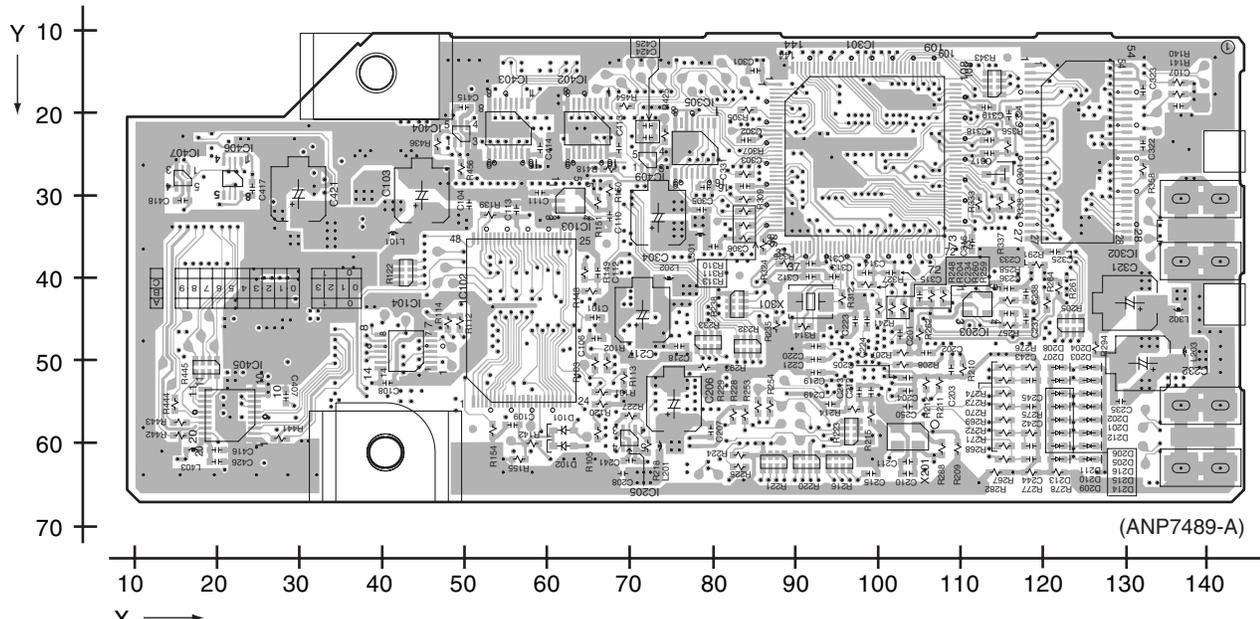

**AF**

**AF**

# 5. PCB PARTS LIST

NOTES: ●Parts marked by "NSP" are generally unavailable because they are not in our Master Spare Parts List.

●The  $\Delta$  mark found on some component parts indicates the importance of the safety factor of the part. Therefore, when replacing, be sure to use parts of identical designation.

●When ordering resistors, first convert resistance values into code form as shown in the following examples.

Ex.1 When there are 2 effective digits (any digit apart from 0), such as 560 ohm and 47k ohm (tolerance is shown by J=5%, and K=10%).

560 $\Omega$	$\rightarrow$	56 x 10 <sup>1</sup>	$\rightarrow$	561	.....	RD1/4PU	$\overline{5}$ $\overline{6}$ $\overline{1}$ J
47k $\Omega$	$\rightarrow$	47 x 10 <sup>3</sup>	$\rightarrow$	473	.....	RD1/4PU	$\overline{4}$ $\overline{7}$ $\overline{3}$ J
0.5 $\Omega$	$\rightarrow$	R50	.....			RN2H	$\overline{R}$ $\overline{5}$ $\overline{0}$ K
1 $\Omega$	$\rightarrow$	1R0	.....			RS1P	$\overline{1}$ $\overline{R}$ $\overline{0}$ K

Ex.2 When there are 3 effective digits (such as in high precision metal film resistors).

5.62k $\Omega$	$\rightarrow$	562 x 10 <sup>1</sup>	$\rightarrow$	5621	.....	RN1/4PC	$\overline{5}$ $\overline{6}$ $\overline{2}$ $\overline{1}$ F
----------------	---------------	-----------------------	---------------	------	-------	---------	---------------------------------------------------------------

## LIST OF ASSEMBLIES

Mark	Symbol and Description	VSX-74TXVi/KUXJ/CA, VSX-74TXVi-S/KUXJC	VSX-72TXV/KUXJ/CA, VSX-72TXV-S/KUXJC
NSP	1..POWER AMP ASSY	AWH7007	AWH7007
	2..POWER AMP-L ASSY	AWX8654	AWX8654
	2..POWER AMP-R ASSY	AWX8656	AWX8656
	2..POWER PROTECT ASSY	AWX8658	AWX8658
	2..POWER AMP IN ASSY	AWX8662	AWX8662
NSP	2..BRIDGE1 ASSY	AWX8667	AWX8667
NSP	2..BRIDGE2 ASSY	AWX8668	AWX8668
	1..1394 ASSY	AWK7882	Not used
NSP	1..COMPLEX ASSY	AWM7975	AWM7979
	2..TRANS 2-2 ASSY	AWX8626	AWX8626
	2..PRIMARY ASSY	AWX8628	AWX8628
NSP	2..FFC GUARD (FRONT)	AWX8634	AWX8634
	2..DISPLAY ASSY	AWX8635	AWX8636
	2..FRONT-IN ASSY	AWX8638	AWX8638
	2..HEADPHONE ASSY	AWX8639	AWX8639
	2..INPUT SELECT ASSY	AWX8640	AWX8640
	2..VOLUME ASSY	AWX8641	AWX8641
	1..DIGITAL MOTHER ASSY	AWP7037	AWP7041
	1..HDMI & DVC ASSY	AWQ7024	AWQ7024
NSP	1..VIDEO ASSY	AWQ7026	AWQ7026
	2..COMPOSITE V ASSY	AWX8620	AWX8620
	2..S VIDEO ASSY	AWX8622	AWX8622
	2..PREOUT & CONTROL ASSY	AWX8625	AWX8625
	1..COMPONENT & VOL ASSY	AWQ7028	AWQ7030
NSP	1..SECONDARY ASSY	AWR7023	AWR7026
	2..SP/PS ASSY	AWX8642	AWX8644
	2..TRANS 2-1 ASSY	AWX8646	AWX8646
NSP	2..DIODE ASSY	AWX8648	AWX8648
	2..VH TR ASSY	AWX8649	AWX8649
	2..DC/DC ASSY	AWX8650	AWX8650
	2..INTERFACE ASSY	AWX8651	AWX8651
NSP	2..TRANS SIDE ASSY	AWX8652	AWX8652
NSP	1..AUDIO ASSY	AWR7030	AWR7030
	2..V-AUDIO ASSY	AWX8637	AWX8637
NSP	2..BRIDGE3 ASSY	AWX8669	AWX8669
	2..LOCAL SUPPLY ASSY	AWX8671	AWX8671
	2..AUDIO & MULTI CH IN ASSY	AWX8674	AWX8674
NSP	2..FFC GUARD (SIDE) ASSY	AWX8696	AWX8696
	1..DSP ASSY	AWX8599	AWX8599
	1..FM/AM TUNER MODULE	AXX7172	AXX7172





**Mark No. Description****Part No.****Mark No. Description****Part No.**

R 6340(B,95 ,128 )

RS1/16S222J

L 3451(B,88 ,65 ) CHIP BEADS

VTL1083

L 3452(B,94 ,50 ) CHIP BEADS

VTL1083

R 6341(B,101 ,134 )

RS1/16S154J

L 3453(B,30 ,26 ) CHIP SOLID INDUCTOR

QTL1013

R 6342(B,97 ,134 )

RS1/16S154J

L 3455(B,88 ,24 ) CHIP BEADS

VTL1083

R 6343(B,113 ,133 )

RS1/16S473J

R 6344(B,109 ,127 )

RS1/16S473J

JA3451(A,12 ,11 ) JACK

RKN1004

R 6345(B,113 ,135 )

RS1/16S331J

JA3452(A,97 ,15 ) FRONT AV INPUT

AKX7019

R 6346(B,109 ,129 )

RS1/16S331J

KN3451(A,13 ,39 ) WRAPPING TERMINAL

VNF1084

R 6351(B,13 ,131 )

RS1/16S102J

KN3452(A,106 ,39 ) WRAPPING TERMINAL

VNF1084

R 6352(B,9 ,136 )

RS1/16S102J

CN3451(A,102 ,53 ) CONNECTOR

52045-1545

R 6353(B,18 ,149 )

RS1/16S103J

**RESISTORS**

R 6354(B,8 ,149 )

RS1/16S103J

R 3451(B,20 ,34 )

RS1/16S682J

R 3452(B,14 ,28 )

RS1/16S104J

R 3453(B,26 ,32 )

RS1/16S101J

R 3454(B,32 ,31 )

RS1/16S104J

R 3455(B,44 ,29 )

RS1/16S333J

R 6355(B,20 ,155 )

RS1/16S102J

R 3456(B,39 ,29 )

RS1/16S432J

R 6356(B,11 ,158 )

RS1/16S102J

R 3457(B,50 ,41 )

RS1/16S432J

R 6361(B,106 ,145 )

RS1/16S101J

R 3458(B,45 ,44 )

RS1/16S333J

R 6362(B,73 ,148 )

RS1/16S101J

R 3459(B,47 ,44 )

RS1/16S101J

R 6367(B,116 ,155 )

RS1/16S0R0J

R 3460(B,7 ,19 )

RS1/16S102J

R 6368(B,107 ,162 )

RS1/16S0R0J

R 3461(B,56 ,44 )

RS1/16S104J

R 6369(B,106 ,166 )

RS1/16S0R0J

R 3462(B,44 ,23 )

RS1/16S101J

R 6370(B,105 ,162 )

RS1/16S0R0J

R 3463(B,34 ,41 )

RS1/16S102J

R 6371(B,72 ,159 )

RS1/16S0R0J

R 3465(B,58 ,46 )

RS1/16S0R0J

R 6372(B,74 ,159 )

RS1/16S0R0J

R 3466(B,60 ,46 )

RS1/16S0R0J

R 6373(B,76 ,159 )

RS1/16S0R0J

R 3467(B,63 ,48 )

RS1/16S0R0J

R 6374(B,73 ,156 )

RS1/16S0R0J

R 3468(B,48 ,34 )

RS1/16S0R0J

R 6375(B,73 ,154 )

RS1/16S0R0J

R 3471(B,53 ,27 )

RS1/16S750J

R 6381(B,41 ,153 )

RS1/16S473J

R 3472(B,55 ,31 )

RS1/16S0R0J

R 6382(B,43 ,152 )

RS1/16S473J

R 3473(B,60 ,26 )

RS1/16S750J

R 6383(B,35 ,165 )

RS1/16S0R0J

R 3474(B,60 ,30 )

RS1/16S0R0J

R 6384(B,68 ,166 )

RS1/16S0R0J

R 3475(B,65 ,24 )

RS1/16S750J

R 6391

RS1/16S0R0J

R 3476(B,64 ,31 )

RS1/16S0R0J

R 6392

RS1/16S0R0J

R 3480(B,47 ,29 )

RS1/16S101J

R 3481(B,77 ,23 )

RS1/16S104J

**CAPACITORS**

C 6329(A,77 ,137 )

CEAT100M50

R 3482(B,105 ,23 )

RS1/16S104J

C 6330(A,70 ,137 )

CEAT100M50

R 3483(B,75 ,27 )

RS1/16S221J

C 6341(A,103 ,137 )

CEAT100M50

R 3484(B,101 ,27 )

RS1/16S221J

C 6342(A,96 ,137 )

CEAT100M50

R 3485(B,75 ,31 )

RS1/16S104J

C 6349(B,33 ,114 )

CKSRYB104K16

R 3486(B,93 ,24 )

RS1/16S104J

C 6350(B,61 ,114 )

CKSRYB104K16

R 3487(B,73 ,35 )

RS1/16S221J

C 6351(B,89 ,114 )

CKSRYB104K16

R 3488(B,93 ,28 )

RS1/16S221J

C 6359(B,69 ,152 )

CCSRCH101J50

R 3489(B,96 ,49 )

RS1/16S101J

C 6360(B,71 ,151 )

CCSRCH101J50

R 3490(B,101 ,47 )

RS1/16S101J

C 6361(B,61 ,156 )

CKSRYB103K50

R 3491(B,89 ,38 )

RS1/16S153J

C 6362(B,58 ,157 )

CKSRYB103K50

R 3492(B,91 ,38 )

RS1/16S153J

C 6363(A,68 ,163 )

CEAT470M16

R 3493(B,87 ,38 )

RS1/16S470J

C 6364(A,85 ,166 )

CEAT470M16

R 3494(B,101 ,43 )

RS1/16S470J

C 6368(B,19 ,114 )

CKSRYB103K50

R 3496(B,101 ,23 )

RS1/16S0R0J

C 6369(B,22 ,111 )

CKSRYB103K50

R 3497(B,78 ,26 )

RS1/16S0R0J

C 6379(B,35 ,114 )

CKSRYB471K50

R 3498(B,95 ,36 )

RS1/16S0R0J

C 6380(B,63 ,114 )

CKSRYB471K50

R 3499(B,97 ,36 )

RS1/16S0R0J

C 6381(B,91 ,114 )

CKSRYB471K50

**C FRONT-IN ASSY  
MISCELLANEOUS**

IC 3451(B,43 ,37 ) OP-AMP IC

BA4560RF

**CAPACITORS**

C 3451(B,12 ,28 )

CCSRCH471J50

Q 3451(B,83 ,33 ) CHIP TRANSISTOR

HN1C01FU

C 3452(A,29 ,36 )

CEAT100M50

D 3451(B,58 ,42 ) DIODE

UDZS5R1(B)

C 3453(B,30 ,31 )

CCSRCH101J50

D 3452(B,60 ,42 ) DIODE

UDZS5R1(B)

C 3454(B,45 ,29 )

CCSRCH220J50

D 3453(B,24 ,36 ) DIODE

UDZS5R1(B)

C 3455(B,44 ,44 )

CCSRCH220J50

D 3454(B,35 ,31 ) DIODE

DAN217

C 3457(A,31 ,41 )

CEAT100M50



5	6	7	8
Mark No.	Description	Part No.	Mark No. Description Part No.
C 3459(B,36 ,35 )		CKSRYP103K50	L 4402(B,307 ,8 ) CHIP BEADS VTL1083
C 3460(B,48 ,38 )		CKSRYP103K50	L 4403(B,307 ,10 ) CHIP BEADS VTL1083
C 3461(A,41 ,44 )		CEAT100M50	L 4404(B,307 ,14 ) CHIP BEADS VTL1083
C 3462(A,53 ,38 )		CEAT100M50	L 4405(B,307 ,16 ) CHIP BEADS VTL1083
C 3463(B,7 ,27 )		CKSRYP105K6R3	L 4406(B,307 ,18 ) CHIP BEADS VTL1083
C 3464(B,8 ,34 )		CKSRYP104K16	L 4407(B,307 ,20 ) CHIP BEADS VTL1083
C 3465(B,6 ,34 )		CKSRYP103K50	L 4408(B,307 ,22 ) CHIP BEADS VTL1083
C 3467(B,32 ,26 )		CKSRYP104K16	L 4409(B,307 ,24 ) CHIP BEADS VTL1083
C 3470(A,50 ,44 )		CEAT100M50	L 4410(B,307 ,26 ) CHIP BEADS VTL1083
C 3471(B,51 ,28 )		CKSRYP104K25	L 4411(B,307 ,28 ) CHIP BEADS VTL1083
C 3475(B,104 ,32 )		CKSRYP104K16	L 4412(B,307 ,30 ) CHIP BEADS VTL1083
C 3476(B,104 ,35 )		CKSRYP471K50	L 4413(B,307 ,32 ) CHIP BEADS VTL1083
C 3481(B,79 ,23 )		CCSRCH221J50	J 5 JUMPER WIRE D20PDY0410E
C 3482(B,103 ,23 )		CCSRCH221J50	CN4402(A,319 ,21 ) KR CONNECTOR S13B-PH
C 3483(A,72 ,32 )		CEAT100M50	CN4403(A,79 ,28 ) CONNECTOR 52045-1745
C 3484(A,96 ,31 )		CEAT100M50	4401(A,61 ,9 ) 4P CABLE HOLDER 51048-0400
C 3485(B,75 ,35 )		CCSRCH101J50	
C 3486(B,91 ,26 )		CCSRCH101J50	
C 3489(B,87 ,33 )		CKSRYP103K50	
C 3490(B,93 ,38 )		CKSRYP103K50	
C 3491(A,90 ,34 ) ELECT. CAPACITOR		CEAT330M25	CN5451(A,169 ,100 ) 17P CONNECTOR 52044-1745
C 3492(A,95 ,43 ) ELECT. CAPACITOR		CEAT330M25	CN5452(A,140 ,100 ) 19P CONNECTOR 52044-1945
C 3494(B,106 ,29 )		CKSRYP104K16	CN5453(A,135 ,134 ) 23P PLUG XKP3071
C 3495(B,103 ,29 )		CKSRYP471K50	CN5454(A,126 ,166 ) 23P PLUG XKP3071
			CN5455(A,169 ,166 ) 17P PLUG XKP3068
C 3496(B,75 ,23 )		CKSRYP103K50	

### **D** HEADPHONE ASSY MISCELLANEOUS

L 3551(B,129 ,129 ) CHIP BEADS	VTL1083
KN3551(A,119 ,114 ) WRAPPING TERMINAL	VNF1084
CN3551(A,133 ,128 ) 4P JUMPER CONNECTOR	52147-0410
3551(A,127 ,85 ) PHONE JACK	AKN7029

### **RESISTORS**

R 3551(B,132 ,97 )	RS1/16S102J
--------------------	-------------

### **CAPACITORS**

C 3551(B,131 ,114 )	CKSRYP392K50
C 3552(B,122 ,100 )	CKSRYP392K50
C 3553(B,124 ,110 )	CCSRCH471J50
C 3554(B,122 ,110 )	CKSRYP103K50
C 3555(B,119 ,110 )	CKSRYP104K16

### **E** BRIDGE1 ASSY MISCELLANEOUS

CN5431(A,51 ,120 ) 23P PLUG	XKP3071
CN5432(A,77 ,72 ) 23P PLUG	XKP3071

### **F** BRIDGE2 ASSY MISCELLANEOUS

CN5441(A,48 ,59 ) CONNECTOR	52045-1745
CN5442(A,68 ,43 ) 11P PLUG	XKP3065
CN5443(A,69 ,19 ) 13P PLUG	XKP3066

### **G** TRANS SIDE ASSY MISCELLANEOUS

L 4401(B,307 ,6 ) CHIP BEADS	VTL1083
------------------------------	---------

### **H** BRIDGE3 ASSY MISCELLANEOUS

CN5451(A,169 ,100 ) 17P CONNECTOR	52044-1745
CN5452(A,140 ,100 ) 19P CONNECTOR	52044-1945
CN5453(A,135 ,134 ) 23P PLUG	XKP3071
CN5454(A,126 ,166 ) 23P PLUG	XKP3071
CN5455(A,169 ,166 ) 17P PLUG	XKP3068

### **I** COMPOSITE V ASSY MISCELLANEOUS

IC 2001(A,125 ,89 ) IC	CD74HC4051PW
IC 2002(A,125 ,77 ) IC	CD74HC4051PW
IC 2003(A,129 ,101 ) IC	CD74HC4053PW
IC 2004(A,134 ,89 ) IC	CD74HC4052PW
IC 2005(B,117 ,126 ) VIDEO AMP IC	TK15420M

IC 2006(A,122 ,42 ) VIDEO SW IC	NJM2279M
IC 2007(B,145 ,64 ) CHARACTER GENERATOR	PDC131A
IC 2008(A,141 ,111 ) LOGIC IC	CD4094BNS
IC 2009(B,132 ,97 ) LOGIC IC	CD4094BNS
Q 2001(B,143 ,80 ) TRANSISTOR	2SC4081

D 2001(A,150 ,29 ) DIODE	DAP202K
L 2003(A,129 ,68 ) AXIAL INDUCTOR	LAU330J
JA 2005(A,95 ,130 ) PIN JACK(1P)	AKB7175
X 2001(A,134 ,55 ) CRYSTAL RESONATOR	ASS1056
CN2001(A,144 ,24 ) 15P SOCKET	XKP3078

CN2002(A,131 ,123 ) 13P SOCKET	XKP3077
2001(A,95 ,109 ) PIN JACK(2P)	AKB7176
2003(A,95 ,53 ) PIN JACK(2P)	AKB7176
2004(A,95 ,25 ) PIN JACK(2P)	AKB7176
2002(A,95 ,81 ) PIN JACK(2P)	AKB7176

### **RESISTORS**

R 2001(B,103 ,116 )	RS1/16S750J
R 2002(B,103 ,102 )	RS1/16S750J
R 2003(B,103 ,88 )	RS1/16S750J
R 2004(B,104 ,75 )	RS1/16S750J
R 2005(B,103 ,46 )	RS1/16S750J

R 2006(B,104 ,19 )	RS1/16S750J
R 2007(B,104 ,130 )	RS1/16S750J
R 2008(B,113 ,62 )	RS1/16S750J
R 2009(B,114 ,36 )	RS1/16S750J
R 2010(A,149 ,118 )	RS1/16S0R0J

**Mark No. Description****Part No.****Mark No. Description****Part No.**

R 2012(B,141 ,35 )  
R 2013(A,115 ,128 )  
R 2014(A,119 ,128 )  
R 2015(A,115 ,127 )  
R 2016(A,119 ,127 )

RS1/16S750J  
RS1/16S472J  
RS1/16S472J  
RS1/16S182J  
RS1/16S182J

C 2043(A,139 ,63 )  
  
C 2044(A,139 ,64 )  
C 2045(A,140 ,67 )  
C 2046(A,140 ,69 )  
C 2047(A,140 ,70 )  
C 2048(A,149 ,68 )

CCSRCH240J50  
  
CCSRCH240J50  
CCSRCH101J50  
CCSRCH101J50  
CCSRCH101J50  
CKSRBY122K50

R 2017(A,114 ,124 )  
R 2018(A,120 ,124 )  
R 2019(A,147 ,75 )  
R 2020(A,147 ,77 )  
R 2021(A,147 ,79 )

RS1/16S202J  
RS1/16S202J  
RS1/16S331J  
RS1/16S331J  
RS1/16S331J

C 2049(A,149 ,63 )  
C 2050(A,149 ,58 )  
C 2052(A,148 ,84 )  
C 2053(B,132 ,112 )  
C 2054(B,131 ,105 )

CKSRBY122K50  
CCSRCH101J50  
CEAT101M10  
CKSRBY103K50  
CKSRBY103K50

R 2022(A,150 ,75 )  
R 2023(B,150 ,79 )  
R 2024(B,148 ,79 )  
R 2025(B,144 ,83 )  
R 2027(A,140 ,104 )

RS1/16S102J  
RS1/16S512J  
RS1/16S392J  
RS1/16S102J  
RS1/16S473J

C 2055(B,147 ,76 )  
C 2086(B,109 ,58 )  
C 2087(B,127 ,110 )  
C 2088(A,132 ,120 )  
C 2089(B,103 ,25 )

CKSRBY103K50  
CKSRBY103K50  
CKSRBY103K50  
CKSRBY103K50  
CKSRBY103K50

R 2028(A,142 ,104 )  
R 2029(A,144 ,104 )  
R 2030(A,145 ,104 )  
R 2031(A,149 ,104 )  
R 2032(A,147 ,104 )

RS1/16S473J  
RS1/16S473J  
RS1/16S473J  
RS1/16S473J  
RS1/16S473J

C 2091(B,103 ,109 )  
C 2092(B,103 ,81 )  
C 2093(B,103 ,53 )  
C 2094(B,104 ,127 )

CKSRBY103K50  
CKSRBY103K50  
CKSRBY103K50  
CKSRBY473K25

R 2033(B,144 ,100 )  
R 2034(B,144 ,98 )  
R 2035(B,144 ,96 )  
R 2036(A,139 ,117 )  
R 2070(A,115 ,109 )

RS1/16S473J  
RS1/16S473J  
RS1/16S473J  
RS1/16S0R0J  
RS1/16S0R0J

R 2082(A,133 ,40 )  
R 2091(A,123 ,122 )  
R 2092(A,124 ,26 )  
R 2095(B,129 ,86 )  
R 9095

RS1/16S0R0J  
RS1/16S0R0J  
RS1/16S0R0J  
RS1/16S473J  
RS1/16S0R0J

IC 2201(A,39 ,96 ) IC  
IC 2202(A,42 ,81 ) IC  
IC 2203(A,39 ,111 ) IC  
IC 2204(A,32 ,130 ) VIDEO AMP IC  
IC 2205(A,52 ,96 ) IC

CD74HC4051PW  
CD74HC4051PW  
CD74HC4052PW  
TK15420M  
CD74HC4051PW

## **J** S VIDEO ASSY MISCELLANEOUS

IC 2206(A,57 ,81 ) IC  
IC 2207(A,48 ,63 ) IC  
IC 2208(A,36 ,60 ) VIDEO AMP IC  
IC 2209(A,49 ,40 ) IC  
IC 2210(A,36 ,37 ) VIDEO AMP IC

CD74HC4051PW  
CD74HC4052PW  
TK15420M  
CD74HC4052PW  
TK15420M

IC 2271(A,51 ,115 ) IC  
IC 2281(A,67 ,58 ) LOGIC IC  
IC 2282(A,68 ,75 ) LOGIC IC  
Q 2271(B,67 ,110 ) TRANSISTOR  
D 2271(A,65 ,107 ) DIODE

LA7213  
CD4094BPW  
CD4094BPW  
RT1N241M  
1SS355

D 2272(A,61 ,106 ) DIODE  
CN2201(A,64 ,24 ) 17P SOCKET  
CN2202(A,62 ,123 ) 11P SOCKET  
CN2203(A,12 ,116 ) SOCKET  
CN2205(A,12 ,53 ) SOCKET

1SS355  
XKP3079  
XKP3076  
AKP7043  
AKP7020

CN2206(A,12 ,25 ) SOCKET

AKP7020

## **RESISTORS**

R 2201(B,26 ,115 )  
R 2202(B,28 ,117 )  
R 2203(B,26 ,101 )  
R 2204(B,28 ,103 )  
R 2205(B,26 ,45 )

RS1/16S750J  
RS1/16S750J  
RS1/16S750J  
RS1/16S750J  
RS1/16S750J

R 2206(B,28 ,49 )  
R 2207(B,26 ,17 )  
R 2208(B,28 ,23 )  
R 2213(B,28 ,126 )  
R 2214(B,28 ,133 )

RS1/16S750J  
RS1/16S750J  
RS1/16S750J  
RS1/16S750J  
RS1/16S750J

R 2215(B,28 ,55 )  
R 2216(B,28 ,62 )  
R 2217(B,28 ,28 )

RS1/16S750J  
RS1/16S750J  
RS1/16S750J

## **CAPACITORS**

C 2007(B,104 ,132 )  
C 2008(B,104 ,61 )  
C 2009(B,104 ,33 )  
C 2012(A,141 ,33 ) ELECT. CAPACITOR  
C 2013(A,133 ,33 )

CCSRCH181J50  
CCSRCH181J50  
CCSRCH181J50  
CEAT102M6R3  
CEAT101M10

C 2014(A,127 ,33 )  
C 2015(A,119 ,91 )  
C 2016(A,130 ,86 )  
C 2017(A,118 ,73 )  
C 2018(A,128 ,81 )

CEAT101M10  
CKSRBY103K50  
CKSRBY103K50  
CKSRBY103K50  
CKSRBY103K50

C 2019(A,128 ,97 )  
C 2020(A,130 ,105 )  
C 2021(A,130 ,92 )  
C 2022(A,139 ,86 )  
C 2024(A,119 ,106 )

CKSRBY103K50  
CKSRBY103K50  
CKSRBY103K50  
CKSRBY103K50  
CEAT101M10

C 2025(A,119 ,114 )  
C 2026(B,119 ,122 )  
C 2027(B,113 ,131 )  
C 2028(A,112 ,116 )  
C 2029(A,127 ,116 )

CEAT101M10  
CKSRBY103K50  
CKSRBY103K50  
CEAT101M10  
CEAT101M10

C 2034(A,130 ,39 )  
C 2035(A,129 ,44 )  
C 2036(A,113 ,47 )  
C 2037(A,141 ,48 )  
C 2038(A,150 ,49 )

CKSRBY103K50  
CKSRBY103K50  
CEAT100M50  
CEAT101M10  
CEAT101M10

C 2039(B,142 ,54 )  
C 2040(B,143 ,74 )  
C 2041(B,130 ,57 )  
C 2042(B,130 ,62 )

CKSRBY473K25  
CKSRBY473K25  
CCSRCH120J50  
CCSRCH120J50





5		6		7		8	
Mark No.	Description	Part No.	Mark No.	Description	Part No.	Mark No.	Description
R 2503(B,93 ,103 )		RS1/16S222J	R 2564(B,115 ,61 )		RS1/16S102J		
R 2504(B,93 ,100 )		RS1/16S222J	R 2565(B,111 ,68 )		RS1/16S183J		
R 2505(B,99 ,108 )		RS1/16S751J	R 2566(B,111 ,63 )		RS1/16S183J		A
R 2506(B,99 ,95 )		RS1/16S751J	R 2567(B,109 ,68 )		RS1/16S512J		
R 2507(A,92 ,108 )		RS1/16S472J	R 2568(B,109 ,63 )		RS1/16S512J		
R 2508(A,92 ,96 )		RS1/16S472J	R 2569(A,117 ,71 )		RS1/16S153J		
R 2509(B,99 ,104 )		RS1/16S104J	R 2570(A,117 ,59 )		RS1/16S153J		
R 2510(B,99 ,99 )		RS1/16S104J	R 2571(B,117 ,70 )		RS1/16S0R0J		
R 2511(A,105 ,105 )		RS1/16S472J	R 2572(B,117 ,61 )		RS1/16S0R0J		
R 2512(A,105 ,98 )		RS1/16S472J	R 2573(B,124 ,70 )		RS1/16S104J		
R 2513(B,115 ,106 )		RS1/16S102J	R 2574(B,124 ,61 )		RS1/16S104J		
R 2514(B,115 ,97 )		RS1/16S102J	R 2575(B,73 ,38 )		RS1/16S563J		
R 2515(B,111 ,104 )		RS1/16S183J	R 2576(B,73 ,33 )		RS1/16S563J		
R 2516(B,111 ,99 )		RS1/16S183J	R 2577(B,93 ,49 )		RS1/16S202J		B
R 2517(B,109 ,104 )		RS1/16S512J	R 2578(B,93 ,46 )		RS1/16S202J		
R 2518(B,109 ,99 )		RS1/16S512J	R 2579(B,99 ,54 )		RS1/16S751J		
R 2519(A,117 ,107 )		RS1/16S153J	R 2580(B,99 ,41 )		RS1/16S751J		
R 2520(A,117 ,96 )		RS1/16S153J	R 2581(A,92 ,55 )		RS1/16S472J		
R 2521(B,117 ,106 )		RS1/16S0R0J	R 2582(A,92 ,42 )		RS1/16S472J		
R 2522(B,117 ,97 )		RS1/16S0R0J	R 2583(B,99 ,50 )		RS1/16S104J		
R 2523(B,124 ,106 )		RS1/16S104J	R 2584(B,99 ,45 )		RS1/16S104J		
R 2524(B,124 ,97 )		RS1/16S104J	R 2585(A,105 ,51 )		RS1/16S472J		
R 2525(B,86 ,87 )		RS1/16S563J	R 2586(A,105 ,44 )		RS1/16S472J		
R 2526(B,86 ,81 )		RS1/16S563J	R 2587(B,115 ,52 )		RS1/16S102J		
R 2527(B,93 ,85 )		RS1/16S222J	R 2588(B,115 ,43 )		RS1/16S102J		C
R 2528(B,93 ,82 )		RS1/16S222J	R 2589(B,111 ,50 )		RS1/16S822J		
R 2529(B,99 ,90 )		RS1/16S751J	R 2590(B,111 ,45 )		RS1/16S822J		
R 2530(B,99 ,77 )		RS1/16S751J	R 2591(B,109 ,50 )		RS1/16S822J		
R 2531(A,92 ,89 )		RS1/16S472J	R 2592(B,109 ,45 )		RS1/16S822J		
R 2532(A,92 ,77 )		RS1/16S472J	R 2593(A,117 ,53 )		RS1/16S153J		
R 2533(B,99 ,86 )		RS1/16S104J	R 2594(A,117 ,42 )		RS1/16S153J		
R 2534(B,99 ,81 )		RS1/16S104J	R 2595(B,117 ,52 )		RS1/16S0R0J		
R 2535(A,105 ,87 )		RS1/16S472J	R 2596(B,117 ,43 )		RS1/16S0R0J		
R 2536(A,105 ,80 )		RS1/16S472J	R 2597(B,124 ,52 )		RS1/16S104J		
R 2537(B,115 ,88 )		RS1/16S102J	R 2598(B,124 ,43 )		RS1/16S104J		
R 2538(B,115 ,79 )		RS1/16S102J	R 2599(A,107 ,114 )		RS1/16S473J		D
R 2539(B,111 ,86 )		RS1/16S183J	R 2625(A,58 ,99 )		RS1/16S242J		
R 2540(B,109 ,81 )		RS1/16S183J	R 2626(A,74 ,99 )		RS1/16S242J		
R 2541(B,109 ,86 )		RS1/16S512J	R 2627(A,60 ,100 )		RS1/16S560J		
R 2542(B,111 ,81 )		RS1/16S512J	R 2628(A,72 ,100 )		RS1/16S560J		
R 2543(A,117 ,89 )		RS1/16S153J	R 2629(A,58 ,101 )		RS1/16S332J		
R 2544(A,117 ,77 )		RS1/16S153J	R 2630(A,74 ,101 )		RS1/16S332J		
R 2545(B,117 ,88 )		RS1/16S0R0J	R 2631(A,59 ,103 )		RS1/16S0R0J		
R 2546(B,117 ,79 )		RS1/16S0R0J	R 2632(A,73 ,103 )		RS1/16S0R0J		
R 2547(B,124 ,88 )		RS1/16S104J	R 2633(A,59 ,106 )		RS1/16S222J		
R 2548(B,124 ,79 )		RS1/16S104J	R 2634(A,73 ,106 )		RS1/16S222J		
R 2549(A,102 ,114 )		RS1/16S473J	R 2635(A,61 ,106 )		RS1/16S101J		
R 2551(B,86 ,69 )		RS1/16S563J	R 2636(A,72 ,106 )		RS1/16S101J		
R 2552(B,86 ,63 )		RS1/16S563J	R 2637(B,71 ,113 )		RS1/16S474J		
R 2553(B,93 ,67 )		RS1/16S222J	R 2638(B,71 ,117 )		RS1/16S474J		
R 2554(B,93 ,64 )		RS1/16S222J	R 2641(A,50 ,109 )		RS1/16S472J		
R 2555(B,99 ,72 )		RS1/16S751J	R 2642(A,39 ,109 )		RS1/16S472J		
R 2556(B,99 ,59 )		RS1/16S751J	R 2643(B,48 ,106 )		RS1/16S101J		
R 2557(A,92 ,72 )		RS1/16S472J	R 2644(B,41 ,106 )		RS1/16S101J		
R 2558(A,92 ,60 )		RS1/16S472J	R 2645(A,49 ,118 )		RS1/16S113J		
R 2559(B,99 ,68 )		RS1/16S104J	R 2646(A,39 ,118 )		RS1/16S113J		
R 2560(B,99 ,63 )		RS1/16S104J	R 2647(A,52 ,113 )		RS1/16S0R0J		F
R 2561(A,105 ,69 )		RS1/16S472J	R 2648(A,37 ,113 )		RS1/16S0R0J		
R 2562(A,105 ,62 )		RS1/16S472J	R 2649(A,51 ,118 )		RS1/16S153J		
R 2563(B,115 ,70 )		RS1/16S102J	R 2650(A,37 ,118 )		RS1/16S153J		

	<u>Mark No.</u>	<u>Description</u>	<u>Part No.</u>	<u>Mark No.</u>	<u>Description</u>	<u>Part No.</u>
	R 2651(A,50 ,115 )		RS1/16S113J	C 2419(A,53 ,184 )		CKSRYB103K50
A	R 2652(A,39 ,115 )		RS1/16S113J	C 2420(A,53 ,181 )		CKSRYB103K50
	R 2653(A,50 ,112 )		RS1/16S472J	C 2424(A,63 ,200 )		CEAT101M10
	R 2654(A,39 ,112 )		RS1/16S472J	C 2425(A,57 ,200 )		CEAT101M10
	R 2655(B,46 ,106 )		RS1/16S474J	C 2426(A,51 ,200 )		CEAT101M10
	R 2656(B,43 ,106 )		RS1/16S474J	C 2427(B,65 ,211 )		CKSRYB104K16
B	R 2657(B,60 ,75 )		RS1/16S0R0J	C 2428(B,65 ,205 )		CKSRYB104K16
	R 2658(B,57 ,74 )		RS1/16S0R0J	C 2431(A,69 ,213 )		CEAT101M10
	R 2663(B,81 ,104 )		RS1/16S101J	C 2432(A,69 ,207 )		CEAT101M10
	R 2664(B,81 ,96 )		RS1/16S101J	C 2434(B,99 ,222 )		CCSRCH181J50
	R 2665(B,81 ,85 )		RS1/16S101J	C 2438(B,86 ,172 )		CKSRYB103K50
B	R 2666(B,80 ,79 )		RS1/16S101J	C 2439(B,27 ,191 )		CKSRYB224K10
	R 2667(B,80 ,68 )		RS1/16S101J	C 2440(B,27 ,187 )		CKSRYB224K10
	R 2668(B,80 ,64 )		RS1/16S101J	C 2453(B,18 ,221 )		CKSRYB103K50
	R 2669(B,67 ,40 )		RS1/16S101J	C 2454(B,32 ,222 )		CKSRYB103K50
	R 2670(B,67 ,36 )		RS1/16S101J	C 2455(B,62 ,223 )		CKSRYB103K50
C	R 2673(B,69 ,27 )		RS1/16S101J	C 2456(B,74 ,223 )		CKSRYB103K50
	R 2674(B,69 ,22 )		RS1/16S101J	C 2457(B,94 ,219 )		CKSRYB103K50
	R 2675(B,75 ,26 )		RS1/16S563J	C 2460(A,20 ,212 )		CKSRYB104K16
	R 2676(B,75 ,22 )		RS1/16S563J	C 2467(A,38 ,167 )	ELECT. CAPACITOR	CEAT102M6R3
	R 2677(B,63 ,65 )		RS1/16S102J	C 2468(A,39 ,176 )		CEAT471M6R3
C	R 2678(B,67 ,65 )		RS1/16S102J	C 2469(A,32 ,176 )		CEAT471M6R3
	R 2681(B,56 ,28 )		RS1/16S102J	C 2501(A,84 ,105 )		CEAT470M25
	R 2682(B,58 ,28 )		RS1/16S102J	C 2502(A,84 ,98 )		CEAT470M25
	R 2685(B,23 ,57 )		RS1/16S472J	C 2503(A,101 ,107 )		CEAT4R7M50
	R 2686(B,23 ,76 )		RS1/16S472J	C 2504(A,101 ,96 )		CEAT4R7M50
D	R 2687(B,23 ,59 )		RS1/16S101J	C 2505(A,96 ,104 )		CKSRYB103K50
	R 2688(B,23 ,74 )		RS1/16S101J	C 2506(A,96 ,100 )		CKSRYB103K50
	R 2689(A,59 ,94 )		RS1/16S473J	C 2507(A,107 ,104 )		CKSRYB223K50
	R 2690(B,75 ,100 )		RS1/16S473J	C 2508(A,107 ,99 )		CKSRYB223K50
	R 2691(B,77 ,105 )		RS1/16S473J	C 2509(A,109 ,107 )		CEAT101M16
D	R 2692(B,77 ,41 )		RS1/16S473J	C 2510(A,109 ,96 )		CEAT101M16
	R 2693(B,77 ,43 )		RS1/16S473J	C 2511(A,117 ,109 )		CCSRCH101J50
	R 2694(A,133 ,41 )		RS1/16S102J	C 2512(A,117 ,95 )		CCSRCH101J50
	R 2695(B,38 ,24 )		RS1/16S473J	C 2513(A,120 ,100 )		CKSRYB103K50
	R 2697(A,133 ,23 )		RS1/16S472J	C 2514(A,120 ,103 )		CKSRYB103K50
E	R 2719(A,134 ,36 )		RS1/16S102J	C 2515(A,121 ,107 )		CEAT470M25
	R 2720(A,104 ,114 )		RS1/16S473J	C 2516(A,121 ,96 )		CEAT470M25
	R 2721(A,133 ,33 )		RS1/16S473J	C 2525(A,84 ,87 )		CEAT470M25
	R 2722(A,133 ,27 )		RS1/16S472J	C 2526(A,84 ,80 )		CEAT470M25
	R 2723(A,105 ,114 )		RS1/16S473J	C 2527(A,101 ,89 )		CEAT4R7M50
E	R 2751(A,118 ,210 )		RS1/16S472J	C 2528(A,101 ,78 )		CEAT4R7M50
	R 2752(A,121 ,213 )		RS1/16S472J	C 2529(A,96 ,86 )		CKSRYB103K50
	R 2753(B,111 ,216 )		RS1/16S472J	C 2530(A,96 ,82 )		CKSRYB103K50
	R 2754(B,119 ,216 )		RS1/16S472J	C 2531(A,107 ,86 )		CKSRYB223K50
	R 2755(B,121 ,211 )		RS1/16S180J	C 2532(A,107 ,81 )		CKSRYB223K50
E	R 2756(B,123 ,211 )		RS1/16S180J	C 2533(A,109 ,89 )		CEAT101M16
	R 2757(B,130 ,211 )		RS1/16S103J	C 2534(A,109 ,78 )		CEAT101M16
	R 2758(B,133 ,203 )		RS1/16S103J	C 2535(A,117 ,90 )		CCSRCH101J50
	R 2759(A,125 ,210 )		RS1/16S102J	C 2536(A,117 ,78 )		CCSRCH101J50
	R 2760(A,128 ,214 )		RS1/16S0R0J	C 2537(A,120 ,82 )		CKSRYB103K50
F	R 2771(B,140 ,197 )		RS1/16S0R0J	C 2538(A,120 ,85 )		CKSRYB103K50
	R 2772(B,151 ,202 )		RS1/16S391J	C 2539(A,121 ,89 )		CEAT470M25
	R 9761(B,130 ,143 )		RS1/16S0R0J	C 2540(A,121 ,78 )		CEAT470M25
				C 2551(A,84 ,69 )		CEAT470M25
				C 2552(A,84 ,62 )		CEAT470M25
	<b>CAPACITORS</b>					
	C 2411(A,41 ,191 )	CKSRYB103K50				
	C 2412(A,41 ,187 )	CKSRYB103K50	C 2553(A,101 ,71 )		CEAT4R7M50	
	C 2415(A,32 ,191 )	CKSRYB103K50	C 2554(A,101 ,60 )		CEAT4R7M50	
	C 2416(A,32 ,187 )	CKSRYB103K50	C 2555(A,96 ,68 )		CKSRYB103K50	
			C 2556(A,96 ,64 )		CKSRYB103K50	



**Mark No. Description Part No.**

Q 2501(A,93 ,104 ) CHIP TRANSISTOR 2SD2704K  
 Q 2502(A,93 ,99 ) CHIP TRANSISTOR 2SD2704K  
 Q 2503(B,105 ,105 ) CHIP TRANSISTOR 2SD2704K

A

Q 2504(B,105 ,98 ) CHIP TRANSISTOR 2SD2704K  
 Q 2525(A,93 ,86 ) CHIP TRANSISTOR 2SD2704K  
 Q 2526(A,93 ,81 ) CHIP TRANSISTOR 2SD2704K  
 Q 2527(B,105 ,87 ) CHIP TRANSISTOR 2SD2704K  
 Q 2528(B,105 ,80 ) CHIP TRANSISTOR 2SD2704K

Q 2551(A,93 ,68 ) CHIP TRANSISTOR 2SD2704K  
 Q 2552(A,93 ,63 ) CHIP TRANSISTOR 2SD2704K  
 Q 2553(B,105 ,69 ) CHIP TRANSISTOR 2SD2704K  
 Q 2554(B,105 ,62 ) CHIP TRANSISTOR 2SD2704K  
 Q 2575(A,93 ,50 ) CHIP TRANSISTOR 2SD2704K

B

Q 2576(A,93 ,45 ) CHIP TRANSISTOR 2SD2704K  
 Q 2577(B,105 ,51 ) CHIP TRANSISTOR 2SD2704K  
 Q 2578(B,105 ,44 ) CHIP TRANSISTOR 2SD2704K  
 Q 2631(A,55 ,94 ) TRANSISTOR RT1N241M  
 Q 2633(A,82 ,48 ) TRANSISTOR RT1N241M

Q 2634(A,79 ,48 ) TRANSISTOR RT1N241M  
 Q 2635(B,133 ,41 ) DIGITAL TR(SC-70) RT1P241M  
 Q 2636(B,133 ,36 ) DIGITAL TR(SC-70) RT1P241M  
 Q 2637(B,133 ,24 ) DIGITAL TR(SC-70) RT1P241M  
 Q 2638(B,134 ,31 ) DIGITAL TR(SC-70) RT1P241M

C

Q 2639(B,145 ,129 ) DIGITAL TR(SC-70) RT1P241M  
 Q 2640(B,145 ,134 ) DIGITAL TR(SC-70) RT1P241M  
 △ Q 2641(A,28 ,58 ) TRANSISTOR 2SD1858X  
 △ Q 2642(A,28 ,75 ) TRANSISTOR 2SB1238X  
 Q 2644(A,134 ,30 ) TRANSISTOR UMH1N

Q 2645(A,58 ,96 ) DIGITAL TR(SC-70) RT1P241M  
 Q 2751(B,109 ,216 ) TRANSISTOR 2SA1576A  
 Q 2752(B,116 ,216 ) TRANSISTOR 2SA1576A  
 Q 2753(A,121 ,210 ) TRANSISTOR UMH1N  
 Q 2754(B,126 ,211 ) TRANSISTOR 2SA1576A

D

Q 2771(B,146 ,203 ) TRANSISTOR 2SD1664  
 D 2401(B,20 ,192 ) DIODE 1SS355  
 D 2402(B,21 ,208 ) DIODE 1SS355  
 D 2503(A,22 ,37 ) DIODE DAN217  
 D 2504(A,70 ,124 ) DIODE DAN217

D 2505(A,62 ,124 ) DIODE DAN217  
 D 2517(B,20 ,64 ) DIODE UDZS7R5(B)  
 D 2518(B,20 ,69 ) DIODE UDZS7R5(B)  
 D 2519(B,150 ,90 ) DIODE 1SS355  
 D 2520(B,138 ,36 ) DIODE DAP202U

E

D 2521(B,138 ,24 ) DIODE DAN202U  
 D 2751(B,129 ,204 ) DIODE UDZS5R1(B)  
 D 2752(A,124 ,214 ) DIODE 1SS355  
 D 2772(B,151 ,197 ) DIODE UDZS10(B)  
 L 2751(A,127 ,202 ) CHIP SOLID INDUCTOR ATL7002

L 2754(A,129 ,217 ) CHIP SOLID INDUCTOR QTL1013  
 L 2755(A,122 ,217 ) CHIP SOLID INDUCTOR QTL1013  
 L 2756(A,126 ,217 ) CHIP SOLID INDUCTOR QTL1013  
 L 2757(A,134 ,191 ) CHIP BEADS VTL1083  
 L 2758(A,143 ,190 ) CHIP BEADS VTL1083

F

L 2759(A,80 ,201 ) CHIP BEADS VTL1083  
 L 2760(B,142 ,205 ) CHIP BEADS VTL1083  
 JA 2401(A,68 ,231 ) 6P RCA PINJACK XKB3053  
 JA 2402(A,26 ,231 ) 6P RCA PINJACK XKB3053  
 JA 2403(A,96 ,231 ) PIN JACK(1P) AKB7175

JA 2702(A,125 ,231 ) 2P JACK XKN3013  
 KN2701(A,144 ,226 ) SCREW PLATE VNE1948

**Mark No. Description Part No.**

CN2402(A,14 ,197 ) 7P SOCKET KP200TA7L  
 CN2403(A,18 ,176 ) 13P SOCKET XKP3077  
 CN2409(A,78 ,195 ) CONNECTOR 52045-1745

CN2501(A,14 ,55 ) B TO B CONNCTOR BTEM14P-1R  
 CN2502(A,44 ,137 ) CONNECTOR 52045-1745  
 CN2503(A,14 ,102 ) B TO B CONNCTOR BTEM20P-1R  
 CN2504(A,143 ,72 ) 23P SOCKET XKP3082  
 CN2505(A,14 ,140 ) 7P SOCKET KP200TA7L

CN2506(A,18 ,20 ) 11P SOCKET XKP3076  
 CN2601(A,110 ,130 ) 19P CONNECTOR 52045-1945  
 CN2602(A,99 ,137 ) 26P CONNECTOR 52045-2645  
 CN2603(A,70 ,137 ) 19P CONNECTOR 52045-1945  
 CN2701(A,110 ,231 ) JACK AKN-209

CN2702(A,151 ,178 ) CONNECTOR 52045-1145  
 2701(A,143 ,149 ) PCB BINDER VEF1040

**RESISTORS**

R 2401(B,85 ,224 ) RS1/16S750J  
 R 2402(B,69 ,221 ) RS1/16S750J  
 R 2403(B,56 ,223 ) RS1/16S750J  
 R 2404(B,41 ,223 ) RS1/16S750J  
 R 2405(B,28 ,223 ) RS1/16S750J

R 2406(B,16 ,223 ) RS1/16S750J  
 R 2407(B,36 ,222 ) RS1/16S750J  
 R 2408(B,23 ,223 ) RS1/16S750J  
 R 2409(B,9 ,222 ) RS1/16S750J  
 R 2433(B,103 ,218 ) RS1/16S750J

R 2439(B,65 ,215 ) RS1/16S750J  
 R 2440(B,59 ,215 ) RS1/16S750J  
 R 2441(B,52 ,215 ) RS1/16S750J  
 R 2443(A,93 ,178 ) RS1/16S473J  
 R 2444(A,95 ,178 ) RS1/16S473J

R 2445(A,93 ,173 ) RS1/16S473J  
 R 2446(A,97 ,173 ) RS1/16S473J  
 R 2447(A,91 ,176 ) RS1/16S473J  
 R 2448(A,95 ,173 ) RS1/16S473J  
 R 2449(A,95 ,166 ) RS1/16S473J

R 2451(B,25 ,195 ) RS1/16S153J  
 R 2452(B,25 ,183 ) RS1/16S153J  
 R 2453(B,25 ,191 ) RS1/16S333J  
 R 2454(B,25 ,187 ) RS1/16S333J  
 R 2467(B,23 ,169 ) RS1/16S750J

R 2468(B,25 ,172 ) RS1/16S750J  
 R 2469(B,23 ,176 ) RS1/16S750J  
 R 2501(B,86 ,104 ) RS1/16S563J  
 R 2502(B,86 ,99 ) RS1/16S563J  
 R 2503(B,93 ,103 ) RS1/16S222J

R 2504(B,93 ,100 ) RS1/16S222J  
 R 2505(B,99 ,108 ) RS1/16S751J  
 R 2506(B,99 ,95 ) RS1/16S751J  
 R 2507(A,92 ,108 ) RS1/16S472J  
 R 2508(A,92 ,96 ) RS1/16S472J

R 2509(B,99 ,104 ) RS1/16S104J  
 R 2510(B,99 ,99 ) RS1/16S104J  
 R 2511(A,105 ,105 ) RS1/16S472J  
 R 2512(A,105 ,98 ) RS1/16S472J  
 R 2513(B,115 ,106 ) RS1/16S102J

R 2514(B,115 ,97 ) RS1/16S102J  
 R 2515(B,111 ,104 ) RS1/16S183J  
 R 2516(B,111 ,99 ) RS1/16S183J



5		6		7		8	
Mark No.	Description	Part No.	Mark No.	Description	Part No.		
R 2517(B,109,104)		RS1/16S512J	R 2578(B,93,46)		RS1/16S202J		
R 2518(B,109,99)		RS1/16S512J	R 2579(B,99,54)		RS1/16S751J		
R 2519(A,117,107)		RS1/16S153J	R 2580(B,99,41)		RS1/16S751J	A	
R 2520(A,117,96)		RS1/16S153J	R 2581(A,92,55)		RS1/16S472J		
R 2521(B,117,106)		RS1/16S0R0J	R 2582(A,92,42)		RS1/16S472J		
R 2522(B,117,97)		RS1/16S0R0J	R 2583(B,99,50)		RS1/16S104J		
R 2523(B,124,106)		RS1/16S104J	R 2584(B,99,45)		RS1/16S104J		
R 2524(B,124,97)		RS1/16S104J	R 2585(A,105,51)		RS1/16S472J		
R 2525(B,86,87)		RS1/16S563J	R 2586(A,105,44)		RS1/16S472J		
R 2526(B,86,81)		RS1/16S563J	R 2587(B,115,52)		RS1/16S102J		
R 2527(B,93,85)		RS1/16S222J	R 2588(B,115,43)		RS1/16S102J		
R 2528(B,93,82)		RS1/16S222J	R 2589(B,111,50)		RS1/16S822J		
R 2529(B,99,90)		RS1/16S751J	R 2590(B,111,45)		RS1/16S822J		
R 2530(B,99,77)		RS1/16S751J	R 2591(B,109,50)		RS1/16S822J	B	
R 2531(A,92,89)		RS1/16S472J	R 2592(B,109,45)		RS1/16S822J		
R 2532(A,92,77)		RS1/16S472J	R 2593(A,117,53)		RS1/16S153J		
R 2533(B,99,86)		RS1/16S104J	R 2594(A,117,42)		RS1/16S153J		
R 2534(B,99,81)		RS1/16S104J	R 2595(B,117,52)		RS1/16S0R0J		
R 2535(A,105,87)		RS1/16S472J	R 2596(B,117,43)		RS1/16S0R0J		
R 2536(A,105,80)		RS1/16S472J	R 2597(B,124,52)		RS1/16S104J		
R 2537(B,115,88)		RS1/16S102J	R 2598(B,124,43)		RS1/16S104J		
R 2538(B,115,79)		RS1/16S102J	R 2599(A,107,114)		RS1/16S473J		
R 2539(B,111,86)		RS1/16S183J	R 2625(A,58,99)		RS1/16S242J		
R 2540(B,109,81)		RS1/16S183J	R 2626(A,74,99)		RS1/16S242J		
R 2541(B,109,86)		RS1/16S512J	R 2627(A,60,100)		RS1/16S560J	C	
R 2542(B,111,81)		RS1/16S512J	R 2628(A,72,100)		RS1/16S560J		
R 2543(A,117,89)		RS1/16S153J	R 2629(A,58,101)		RS1/16S332J		
R 2544(A,117,77)		RS1/16S153J	R 2630(A,74,101)		RS1/16S332J		
R 2545(B,117,88)		RS1/16S0R0J	R 2631(A,59,103)		RS1/16S0R0J		
R 2546(B,117,79)		RS1/16S0R0J	R 2632(A,73,103)		RS1/16S0R0J		
R 2547(B,124,88)		RS1/16S104J	R 2633(A,59,106)		RS1/16S222J		
R 2548(B,124,79)		RS1/16S104J	R 2634(A,73,106)		RS1/16S222J		
R 2549(A,102,114)		RS1/16S473J	R 2635(A,61,106)		RS1/16S101J		
R 2551(B,86,69)		RS1/16S563J	R 2636(A,72,106)		RS1/16S101J		
R 2552(B,86,63)		RS1/16S563J	R 2637(B,71,113)		RS1/16S474J		
R 2553(B,93,67)		RS1/16S222J	R 2638(B,71,117)		RS1/16S474J	D	
R 2554(B,93,64)		RS1/16S222J	R 2659(A,48,80)		RS1/16S0R0J		
R 2555(B,99,72)		RS1/16S751J	R 2660(A,46,85)		RS1/16S0R0J		
R 2556(B,99,59)		RS1/16S751J	R 2661(B,46,90)		RS1/16S0R0J		
R 2557(A,92,72)		RS1/16S472J	R 2662(B,43,93)		RS1/16S0R0J		
R 2558(A,92,60)		RS1/16S472J	R 2663(B,81,104)		RS1/16S101J		
R 2559(B,99,68)		RS1/16S104J	R 2664(B,81,96)		RS1/16S101J		
R 2560(B,99,63)		RS1/16S104J	R 2665(B,81,85)		RS1/16S101J		
R 2561(A,105,69)		RS1/16S472J	R 2666(B,80,79)		RS1/16S101J		
R 2562(A,105,62)		RS1/16S472J	R 2667(B,80,68)		RS1/16S101J		
R 2563(B,115,70)		RS1/16S102J	R 2668(B,80,64)		RS1/16S101J		
R 2564(B,115,61)		RS1/16S102J	R 2669(B,67,40)		RS1/16S101J	E	
R 2565(B,111,68)		RS1/16S183J	R 2670(B,67,36)		RS1/16S101J		
R 2566(B,111,63)		RS1/16S183J	R 2673(B,69,27)		RS1/16S101J		
R 2567(B,109,68)		RS1/16S512J	R 2674(B,69,22)		RS1/16S101J		
R 2568(B,109,63)		RS1/16S512J	R 2675(B,75,26)		RS1/16S563J		
R 2569(A,117,71)		RS1/16S153J	R 2676(B,75,22)		RS1/16S563J		
R 2570(A,117,59)		RS1/16S153J	R 2677(B,63,65)		RS1/16S102J		
R 2571(B,117,70)		RS1/16S0R0J	R 2678(B,67,65)		RS1/16S102J		
R 2572(B,117,61)		RS1/16S0R0J	R 2681(B,56,28)		RS1/16S102J		
R 2573(B,124,70)		RS1/16S104J	R 2682(B,58,28)		RS1/16S102J		
R 2574(B,124,61)		RS1/16S104J	R 2685(B,23,57)		RS1/16S472J	F	
R 2575(B,73,38)		RS1/16S563J	R 2686(B,23,76)		RS1/16S472J		
R 2576(B,73,33)		RS1/16S563J	R 2687(B,23,59)		RS1/16S101J		
R 2577(B,93,49)		RS1/16S202J	R 2688(B,23,74)		RS1/16S101J		

Mark No.	Description	Part No.	Mark No.	Description	Part No.
R 2689(A,59 ,94 )		RS1/16S473J	C 2508(A,107 ,99 )		CKSRYB223K50
R 2692(B,77 ,41 )		RS1/16S473J	C 2509(A,109 ,107 )		CEAT101M16
A R 2693(B,77 ,43 )		RS1/16S473J	C 2510(A,109 ,96 )		CEAT101M16
R 2694(A,133 ,41 )		RS1/16S102J	C 2511(A,117 ,109 )		CCSRCH101J50
R 2697(A,133 ,23 )		RS1/16S472J	C 2512(A,117 ,95 )		CCSRCH101J50
R 2698(A,37 ,24 )		RS1/16S0R0J	C 2513(A,120 ,100 )		CKSRYB103K50
R 2699(A,38 ,36 )		RS1/16S0R0J	C 2514(A,120 ,103 )		CKSRYB103K50
R 2719(A,134 ,36 )		RS1/16S102J	C 2515(A,121 ,107 )		CEAT470M25
R 2720(A,104 ,114 )		RS1/16S473J	C 2516(A,121 ,96 )		CEAT470M25
R 2721(A,133 ,33 )		RS1/16S473J	C 2525(A,84 ,87 )		CEAT470M25
R 2722(A,133 ,27 )		RS1/16S472J	C 2526(A,84 ,80 )		CEAT470M25
R 2723(A,105 ,114 )		RS1/16S473J	C 2527(A,101 ,89 )		CEAT4R7M50
R 2751(A,118 ,210 )		RS1/16S472J	C 2528(A,101 ,78 )		CEAT4R7M50
R 2752(A,121 ,213 )		RS1/16S472J	C 2529(A,96 ,86 )		CKSRYB103K50
R 2753(B,111 ,216 )		RS1/16S472J	C 2530(A,96 ,82 )		CKSRYB103K50
R 2754(B,119 ,216 )		RS1/16S472J	C 2531(A,107 ,86 )		CKSRYB223K50
R 2755(B,121 ,211 )		RS1/16S180J	C 2532(A,107 ,81 )		CKSRYB223K50
R 2756(B,123 ,211 )		RS1/16S180J	C 2533(A,109 ,89 )		CEAT101M16
R 2757(B,130 ,211 )		RS1/16S103J	C 2534(A,109 ,78 )		CEAT101M16
R 2758(B,133 ,203 )		RS1/16S103J	C 2535(A,117 ,90 )		CCSRCH101J50
R 2759(A,125 ,210 )		RS1/16S102J	C 2536(A,117 ,78 )		CCSRCH101J50
R 2760(A,128 ,214 )		RS1/16S0R0J	C 2537(A,120 ,82 )		CKSRYB103K50
R 2771(B,140 ,197 )		RS1/16S0R0J	C 2538(A,120 ,85 )		CKSRYB103K50
R 2772(B,151 ,202 )		RS1/16S391J	C 2539(A,121 ,89 )		CEAT470M25
C R 9761(B,130 ,143 )		RS1/16S0R0J	C 2540(A,121 ,78 )		CEAT470M25

### CAPACITORS

C 2411(A,41 ,191 )		CKSRYB103K50	C 2553(A,101 ,71 )		CEAT4R7M50
C 2412(A,41 ,187 )		CKSRYB103K50	C 2554(A,101 ,60 )		CEAT4R7M50
C 2415(A,32 ,191 )		CKSRYB103K50	C 2555(A,96 ,68 )		CKSRYB103K50
C 2416(A,32 ,187 )		CKSRYB103K50	C 2556(A,96 ,64 )		CKSRYB103K50
C 2419(A,53 ,184 )		CKSRYB103K50	C 2557(A,107 ,68 )		CKSRYB223K50
C 2420(A,53 ,181 )		CKSRYB103K50	C 2558(A,107 ,63 )		CKSRYB223K50
C 2424(A,63 ,200 )		CEAT101M10	C 2559(A,109 ,71 )		CEAT101M16
C 2425(A,57 ,200 )		CEAT101M10	C 2560(A,109 ,60 )		CEAT101M16
C 2426(A,51 ,200 )		CEAT101M10	C 2561(A,117 ,72 )		CCSRCH101J50
C 2427(B,65 ,211 )		CKSRYB104K16	C 2562(A,117 ,60 )		CCSRCH101J50
C 2428(B,65 ,205 )		CKSRYB104K16	C 2563(A,120 ,64 )		CKSRYB103K50
C 2431(A,69 ,213 )		CEAT101M10	C 2564(A,120 ,67 )		CKSRYB103K50
C 2432(A,69 ,207 )		CEAT101M10	C 2565(A,121 ,71 )		CEAT470M25
C 2434(B,99 ,222 )		CCSRCH181J50	C 2566(A,121 ,60 )		CEAT470M25
C 2438(B,86 ,172 )		CKSRYB103K50	C 2575(A,70 ,39 )		CEAT470M25
C 2439(B,27 ,191 )		CKSRYB224K10	C 2576(A,70 ,33 )		CEAT470M25
C 2440(B,27 ,187 )		CKSRYB224K10	C 2577(A,101 ,53 )		CEAT4R7M50
C 2453(B,18 ,221 )		CKSRYB103K50	C 2578(A,101 ,42 )		CEAT4R7M50
C 2454(B,32 ,222 )		CKSRYB103K50	C 2579(A,96 ,50 )		CKSRYB103K50
C 2455(B,62 ,223 )		CKSRYB103K50	C 2580(A,96 ,46 )		CKSRYB103K50
C 2456(B,74 ,223 )		CKSRYB103K50	C 2581(A,107 ,50 )		CKSRYB223K50
C 2457(B,94 ,219 )		CKSRYB103K50	C 2582(A,107 ,45 )		CKSRYB223K50
C 2460(A,20 ,212 )		CKSRYB104K16	C 2583(A,109 ,53 )		CEAT101M16
C 2467(A,38 ,167 )	ELECT. CAPACITOR	CEAT102M6R3	C 2584(A,109 ,42 )		CEAT101M16
C 2468(A,39 ,176 )		CEAT471M6R3	C 2585(A,117 ,54 )		CCSRCH101J50
C 2469(A,32 ,176 )		CEAT471M6R3	C 2586(A,117 ,41 )		CCSRCH101J50
C 2501(A,84 ,105 )		CEAT470M25	C 2587(A,120 ,46 )		CKSRYB103K50
C 2502(A,84 ,98 )		CEAT470M25	C 2588(A,120 ,49 )		CKSRYB103K50
C 2503(A,101 ,107 )		CEAT4R7M50	C 2589(A,121 ,53 )		CEAT470M25
C 2504(A,101 ,96 )		CEAT4R7M50	C 2590(A,121 ,42 )		CEAT470M25
F C 2505(A,96 ,104 )		CKSRYB103K50	C 2621(B,147 ,117 )		CKSRYB103K50
C 2506(A,96 ,100 )		CKSRYB103K50	C 2623(B,144 ,75 )		CKSRYB104K16
C 2507(A,107 ,104 )		CKSRYB223K50	C 2626(A,23 ,61 )		CEAT2R2M50

5		6		7		8	
Mark No.	Description	Part No.	Mark No.	Description	Part No.		
C 2627(A,23 ,69 )		CEAT2R2M50	IC 105 (A,63 ,122 )	LOGIC IC	SN74AHCT32PW		
C 2628(A,34 ,61 )		CEAT100M50					
C 2629(A,34 ,70 )		CEAT100M50	IC 106 (A,63 ,133 )	LOGIC IC	SN74AHCT08PW		
C 2633(A,61 ,103 )		CCSRCH101J50	IC 107 (A,83 ,138 )	IC	TC74VHCT125AFTS1	A	
C 2634(A,72 ,103 )		CCSRCH101J50	IC 108 (A,90 ,114 )	LOGIC IC	SN74LV244ATPW		
C 2635(B,68 ,107 )		CKSRYP103K50	IC 201 (A,114 ,133 )	CPU	PEG117A		
C 2636(B,66 ,107 )		CKSRYP103K50	IC 202 (A,114 ,154 )	FLASH ROM	AYW7080		
			IC2	FLASH MEMORY(4M)	MBM29LV400TC-70PFTN		
C 2637(A,74 ,112 )		CEAT100M50	IC 203 (A,133 ,107 )	LOGIC IC	CD4094BPW		
C 2638(A,74 ,118 )		CEAT100M50	IC 204 (A,107 ,109 )	IC	TC74VHCT125AFTS1		
C 2649(A,61 ,94 )		CKSRYP103K50	IC 205 (A,115 ,107 )	LOGIC IC	SN74AHC02PW		
C 2650(A,55 ,88 )		CKSRYP103K50	IC 206 (A,84 ,127 )	LOGIC IC	SN74LV125APW		
C 2655(B,69 ,48 )		CKSRYP103K50	IC 207 (A,92 ,127 )	LOGIC IC	SN74AHC08PW		
C 2656(B,82 ,54 )		CKSRYP103K50	IC 208 (A,92 ,138 )	LOGIC IC	SN74LV244APW		
C 2660(A,50 ,59 )		CEAT100M50	IC 209 (A,82 ,150 )	LOGIC IC	SN74LV125APW	B	
C 2661(A,56 ,59 )		CEAT100M50	IC 210 (A,92 ,150 )	LOGIC IC	SN74AHC04PW		
C 2662(A,62 ,59 )		CEAT100M50	IC 211 (A,124 ,107 )	LOGIC IC	CD4094BPW		
C 2663(A,68 ,59 )		CEAT100M50	△ IC 221 (A,121 ,92 )	IC	NJM2391DL1-33		
C 2664(B,66 ,69 )		CCSRCH101J50	IC 261 (A,43 ,208 )	USB CODEC IC	PCM2902EG		
C 2665(B,64 ,67 )		CCSRCH101J50	IC 281 (A,129 ,205 )	XM/DT IC	F2602E-01		
C 2666(A,70 ,67 )		CKSRYP103K50	△ IC 282 (A,143 ,209 )	LOAD SWITCHING	AAT4618IGV-0.5-1		
C 2667(A,71 ,69 )		CKSRYP103K50	IC 301 (A,105 ,200 )	DA I/F TRANSCEIVER	AK4114VQ		
C 2668(A,70 ,71 )		CKSRYP103K50	IC 304 (A,15 ,195 )	LOGIC IC	SN74LVC1G97DCK		
C 2675(A,67 ,86 )		CEAT100M50	IC 305 (A,22 ,195 )	LOGIC IC	SN74LVC1G97DCK		
C 2676(A,73 ,86 )		CEAT100M50	IC 306 (A,89 ,168 )	LOGIC IC	SN74LV157APW		
C 2677(A,46 ,19 )		CEAT100M50	IC 307 (A,79 ,168 )	LOGIC IC	SN74LV157APW	C	
C 2678(A,51 ,19 )		CEAT100M50	IC 308 (A,104 ,175 )	LOGIC IC	SN74LV157APW		
C 2679(A,57 ,19 )		CEAT100M50	IC 309 (A,124 ,175 )	LOGIC IC	SN74LV157APW		
C 2680(A,63 ,19 )		CEAT100M50	IC 312 (A,67 ,190 )	LOGIC IC	SN74AHC08PW		
C 2681(B,60 ,30 )		CCSRCH101J50	IC 313 (A,77 ,190 )	LOGIC IC	SN74AHC08PW		
C 2682(B,54 ,30 )		CCSRCH101J50	IC 314 (A,86 ,190 )	LOGIC IC	SN74AHC08PW		
C 2683(A,62 ,28 )		CKSRYP103K50	IC 315 (A,53 ,79 )	LOGIC IC	SN74LV157APW		
C 2684(A,64 ,31 )		CKSRYP103K50	IC 316 (A,64 ,79 )	LOGIC IC	SN74LV157APW		
C 2685(A,62 ,32 )		CKSRYP103K50	IC 318 (A,24 ,180 )	LOGIC IC	SN74LVC1G97DCK		
C 2692(A,48 ,44 )		CEAT100M50	△ IC 321 (A,139 ,183 )	IC	NJM2391DL1-33		
C 2693(A,42 ,44 )		CEAT100M50	IC 481 (A,119 ,77 )	OP-AMP IC	BA4560RF		
C 2695(A,72 ,27 )		CEAT470M25	IC 482 (A,98 ,76 )	A/D CONVERTER	PCM1803DB	D	
C 2696(A,72 ,21 )		CEAT470M25	IC 551 (A,119 ,52 )	D/A CONVERTER IC	DSD1791DBR		
C 2698(A,131 ,24 )		CKSRYP104K16	IC 552 (A,119 ,35 )	OP-AMP IC	BA4560RF		
C 2699(A,131 ,42 )		CKSRYP473K25	IC 651 (A,98 ,52 )	D/A CONVERTER IC	DSD1791DBR		
C 2700(A,131 ,22 )		CKSRYP224K16	IC 652 (A,98 ,35 )	OP-AMP IC	BA4560RF		
C 2714(A,131 ,35 )		CKSRYP473K25	IC 751 (A,77 ,52 )	D/A CONVERTER IC	DSD1791DBR		
C 2716(A,131 ,28 )		CKSRYP224K16	IC 752 (A,77 ,35 )	OP-AMP IC	BA4560RF		
C 2717(A,131 ,26 )		CKSRYP104K16	IC 851 (A,56 ,52 )	D/A CONVERTER IC	DSD1791DBR		
C 2751(B,107 ,220 )		CKSRYP103K50	IC 852 (A,56 ,35 )	OP-AMP IC	BA4560RF		
C 2752(B,113 ,220 )		CKSRYP103K50	IC 951 (A,35 ,52 )	D/A CONVERTER IC	DSD1791DBR		
C 2754(A,131 ,205 )	ELECT. CAPACITOR	CEATR10M50	IC 952 (A,35 ,35 )	OP-AMP IC	BA4560RF		
C 2771(A,148 ,198 )		CEAT101M16	IC 953 (A,114 ,175 )	LOGIC IC	SN74AHC08PW	E	
C 2781(B,151 ,217 )		CKSRYP104K16	△ IC 991 (A,136 ,54 )	IC	NJM2391DL1-33		
C 2782(B,149 ,217 )		CKSRYP471K50	Q 101 (B,21 ,146 )	TRANSISTOR	DTC143TK		
C 2783(B,151 ,213 )		CKSRYP104K16	Q 102 (B,24 ,134 )	DIGITAL TR(SC-70)	RT1P241M		
C 2784(B,149 ,213 )		CKSRYP471K50	Q 103 (B,27 ,134 )	CHIP TR(DUAL)	RN2901		
			Q 104 (B,14 ,135 )	CHIP TR (PNP X 2)	UMB1N		
			Q 105 (A,23 ,17 )	CHIP TR (PNP X 2)	UMB1N		
			Q 106 (A,139 ,87 )	TRANSISTOR	RT1N241M		
			Q 107 (A,28 ,17 )	CHIP TR (PNP X 2)	UMB1N		
			Q 108 (A,138 ,70 )	CHIP TR (PNP X 2)	UMB1N		
			Q 201 (B,20 ,24 )	TRANSISTOR	2SA1036K	F	
			Q 202 (B,21 ,36 )	TRANSISTOR	RT1N241M		
			Q 281 (B,99 ,153 )	DIGITAL TR(SC-70)	RT1P441M		
			Q 481 (B,129 ,77 )	TRANSISTOR	IMX25		
IC 101 (A,46 ,158 )	CPU	PEG116A					
IC 102 (A,46 ,180 )	FLASH ROM	AYW7076					
IC1	FLASH MEMORY (4M)	MBM29F400TC-70PFTN					
IC 103 (A,89 ,94 )	LOGIC IC	CD4094BPW					
IC 104 (A,20 ,147 )	RESET IC	BU4842F					

## **L** DIGITAL MOTHER ASSY (VSX-74TXVi)

### MISCELLANEOUS

	<u>Mark No.</u>	<u>Description</u>	<u>Part No.</u>	<u>Mark No.</u>	<u>Description</u>	<u>Part No.</u>
	Q 482	(A,139 ,76 ) CHIP TRANSISTOR	RN4903	X 261	(A,38 ,198 ) CRYSTAL RESONATOR	ASS7047
	D 101	(B,31 ,133 ) DIODE	DAN202U	X 281	(A,118 ,205 ) CRYSTAL RESONATOR	ASS7065
A	D 102	(A,107 ,8 ) DIODE	DAN202U	X 301	(A,102 ,190 ) CRYSTAL RESONATOR	XSS3003
	D 103	(A,112 ,8 ) DIODE	1SS355	CN101	(A,70 ,7 ) 23P CONNECTOR	52045-2345
	D 104	(A,51 ,17 ) DIODE	DAP202U	CN102	(A,142 ,19 ) 11P SOCKET	XKP3076
	D 105	(A,48 ,17 ) DIODE	DAN202U	CN103	(A,52 ,11 ) 19P CONNECTOR	52045-1945
	D 106	(A,57 ,12 ) DIODE	UDZS5R1(B)	CN104	(A,146 ,84 ) B TO B CONNCTOR	BTEM16P-1R
	D 107	(B,19 ,137 ) DIODE	DAN202U	CN105	(A,17 ,48 ) 23P SOCKET	XKP3082
	D 108	(A,110 ,8 ) DIODE	RB520S-30	CN201	(A,146 ,191 ) 4P SOCKET	KP200TA4L
	D 109	(B,46 ,183 ) CHIP DIODE	RB501V-40	CN281	(A,141 ,232 ) 4P SOCKET	AKP7201
	D 110	(B,69 ,142 ) DIODE	DAN202U	CN301	(A,57 ,200 ) 26P PLUG	AKM7054
	D 114	(A,92 ,103 ) DIODE	1SS355	CN302	(A,39 ,98 ) 26P PLUG	AKM7054
B	D 116	(A,140 ,83 ) CHIP DIODE	RB501V-40	CN303	(A,18 ,165 ) 22P CONNECTOR	RKN1063
	D 201	(B,18 ,18 ) DIODE	DAN202U	CN304	(A,142 ,167 ) 23P SOCKET	XKP3083
	D 202	(B,115 ,157 ) CHIP DIODE	RB501V-40	CN305	(A,17 ,105 ) 10P CONNECTOR	AKN7041
	D 281	(B,138 ,215 ) DIODE	UDZS5R6(B)	CN991	(A,146 ,25 ) B TO B CONNCTOR	BTEM20P-1R
	D 282	(B,136 ,215 ) DIODE	UDZS5R6(B)	CN992	(A,146 ,55 ) B TO B CONNCTOR	BTEM20P-1R
	D 451	(B,108 ,74 ) DIODE	DAN217	<b>RESISTORS</b>		
	D 452	(B,108 ,79 ) DIODE	DAN217	R 101	(A,45 ,17 )	RS1/16S105J
	L 101	(A,17 ,124 ) CHIP SOLID INDUCTOR	ATL7002	R 102	(A,33 ,143 )	RAB4C101J
	L 102	(B,34 ,16 ) CHIP SOLID INDUCTOR	ATL7002	R 103	(A,42 ,143 )	RAB4C101J
	L 201	(A,129 ,98 ) CHIP SOLID INDUCTOR	QTL1013	R 104	(B,37 ,142 )	RS1/16S104J
	L 281	(A,119 ,217 ) CHIP SOLID INDUCTOR	QTL1013	R 105	(A,35 ,143 )	RS1/16S101J
	L 282	(A,144 ,200 ) CHIP SOLID INDUCTOR	ATL7002	R 106	(A,37 ,143 )	RS1/16S101J
C	L 301	(A,85 ,215 ) CHIP SOLID INDUCTOR	QTL1013	R 107	(B,39 ,142 )	RS1/16S104J
	L 303	(A,99 ,208 ) CHIP SOLID INDUCTOR	QTL1013	R 108	(B,41 ,147 )	RS1/16S512J
	L 304	(A,93 ,207 ) CHIP SOLID INDUCTOR	QTL1013	R 110	(A,38 ,143 )	RS1/16S101J
	L 305	(A,22 ,200 ) CHIP SOLID INDUCTOR	QTL1013	R 111	(A,40 ,143 )	RS1/16S101J
	L 306	(A,75 ,171 ) CHIP SOLID INDUCTOR	QTL1013	R 112	(B,45 ,153 )	RS1/16S101J
	L 307	(A,80 ,82 ) CHIP SOLID INDUCTOR	QTL1013	R 113	(B,47 ,158 )	RS1/16S473J
	L 308	(A,63 ,193 ) CHIP SOLID INDUCTOR	QTL1013	R 114	(B,54 ,143 )	RS1/16S101J
	L 309	(A,22 ,187 ) CHIP SOLID INDUCTOR	QTL1013	R 115	(A,54 ,143 )	RAB4C101J
	L 311	(A,84 ,171 ) CHIP SOLID INDUCTOR	QTL1013	R 116	(A,58 ,143 )	RAB4C101J
	L 312	(A,100 ,178 ) CHIP SOLID INDUCTOR	QTL1013	R 117	(B,54 ,150 )	RS1/16S104J
	L 313	(A,120 ,178 ) CHIP SOLID INDUCTOR	QTL1013	R 119	(B,58 ,147 )	RS1/16S222J
D	L 314	(A,72 ,193 ) CHIP SOLID INDUCTOR	QTL1013	R 120	(A,61 ,143 )	RS1/16S101J
	L 315	(A,110 ,178 ) CHIP SOLID INDUCTOR	QTL1013	R 121	(A,30 ,162 )	RS1/16S101J
	L 316	(A,81 ,193 ) CHIP SOLID INDUCTOR	QTL1013	R 122	(B,36 ,153 )	RS1/16S474J
	L 481	(A,108 ,86 ) CHIP SOLID INDUCTOR	QTL1013	R 123	(A,61 ,150 )	RAB4C101J
	L 482	(A,89 ,79 ) CHIP SOLID INDUCTOR	QTL1013	R 124	(A,61 ,155 )	RAB4C101J
	L 551	(A,114 ,61 ) CHIP SOLID INDUCTOR	QTL1013	R 125	(B,52 ,150 )	RS1/16S104J
	L 552	(A,128 ,48 ) CHIP SOLID INDUCTOR	QTL1013	R 126	(B,17 ,129 )	RS1/16S473J
	L 651	(A,94 ,61 ) CHIP SOLID INDUCTOR	QTL1013	R 127	(B,51 ,155 )	RS1/16S104J
	L 652	(A,107 ,48 ) CHIP SOLID INDUCTOR	QTL1013	R 128	(B,61 ,159 )	RS1/16S473J
	L 751	(A,72 ,61 ) CHIP SOLID INDUCTOR	QTL1013	R 129	(A,61 ,158 )	RS1/16S473J
E	L 752	(A,86 ,48 ) CHIP SOLID INDUCTOR	QTL1013	R 131	(B,49 ,155 )	RS1/16S104J
	L 851	(A,51 ,61 ) CHIP SOLID INDUCTOR	QTL1013	R 132	(A,61 ,162 )	RAB4C101J
	L 852	(A,65 ,48 ) CHIP SOLID INDUCTOR	QTL1013	R 133	(A,61 ,166 )	RAB4C101J
	L 951	(A,30 ,61 ) CHIP SOLID INDUCTOR	QTL1013	R 134	(B,61 ,163 )	RS1/16S473J
	L 952	(A,44 ,48 ) CHIP SOLID INDUCTOR	QTL1013	R 135	(A,56 ,171 )	RS1/16S101J
	JA261	(A,43 ,232 ) USB CONNECTOR	DKN1237	R 136	(B,19 ,132 )	RS1/16S471J
	JA301	(A,119 ,232 ) PIN JACK(2P)	AKB7173	R 137	(A,32 ,158 )	RAB4C101J
	JA302	(A,98 ,232 ) OPT. LINK IN	AKS7001	R 138	(B,38 ,158 )	RS1/16S474J
	JA303	(A,84 ,232 ) OPT. LINK IN	AKS7001	R 139	(B,36 ,158 )	RS1/16S104J
	JA304	(A,70 ,232 ) OPT. LINK IN	AKS7001	R 140	(B,53 ,155 )	RS1/16S474J
	JA305	(A,57 ,232 ) OPT. LINK IN	AKS7001	R 141	(B,41 ,158 )	RS1/16S473J
F	JA306	(A,28 ,232 ) OPT. LINK OUT	AKS7002	R 143	(B,43 ,158 )	RS1/16S473J
	JA307	(A,15 ,232 ) OPT. LINK OUT	AKS7002	R 144	(B,40 ,153 )	RS1/16S473J
	X 101	(A,46 ,146 ) CERAMIC RESONATOR	XSS3004	R 145	(A,31 ,148 )	RS1/16S101J
	X 201	(A,114 ,121 ) CERAMIC RESONATOR	XSS3004			

5		6		7		8	
Mark No.	Description	Part No.	Mark No.	Description	Part No.		
R 146	(B,46 ,179)	RS1/16S104J	R 228	(B,110 ,136)	RS1/16S473J		
R 147	(B,36 ,178)	RS1/16S473J	R 230	(B,104 ,129)	RS1/16S101J		
R 149	(B,91 ,93)	RS1/16S473J	R 231	(A,22 ,147)	RS1/16S104J		
R 150	(B,89 ,93)	RS1/16S473J	R 232	(B,115 ,153)	RS1/16S104J		A
R 151	(B,50 ,150)	RS1/16S104J	R 234	(B,104 ,151)	RS1/16S473J		
R 153	(B,31 ,129)	RS1/16S471J	R 237	(A,134 ,99)	RS1/16S473J		
R 154	(B,29 ,129)	RS1/16S473J	R 238	(A,133 ,114)	RAB4C473J		
R 155	(B,21 ,132)	RS1/16S102J	R 239	(B,114 ,105)	RS1/16S104J		
R 156	(B,24 ,129)	RS1/16S473J	R 240	(B,116 ,105)	RS1/16S104J		
R 157	(B,16 ,145)	RS1/16S470J	R 241	(A,109 ,115)	RS1/16S101J		
R 161	(B,54 ,17)	RS1/16S105J	R 242	(A,29 ,176)	RS1/16S104J		
R 162	(B,56 ,12)	RS1/16S223J	R 243	(A,29 ,177)	RS1/16S104J		
R 164	(A,20 ,150)	RS1/16S104J	R 244	(B,108 ,138)	RS1/16S473J		
R 165	(B,33 ,163)	RS1/16S101J	R 246	(B,89 ,140)	RS1/16S104J		
R 166	(B,88 ,116)	RS1/16S104J	R 247	(B,87 ,140)	RS1/16S104J		
R 167	(B,94 ,110)	RS1/16S104J	R 248	(B,96 ,139)	RS1/16S104J		
R 168	(B,90 ,112)	RS1/16S104J	R 249	(B,94 ,140)	RS1/16S104J		
R 169	(B,85 ,129)	RS1/16S104J	R 250	(B,104 ,147)	RS1/16S104J		
R 170	(B,85 ,140)	RS1/16S104J	R 251	(B,115 ,140)	RS1/16S104J		
R 171	(A,80 ,133)	RS1/16S101J	R 252	(B,106 ,143)	RS1/16S104J		
R 172	(B,83 ,129)	RS1/16S104J	R 253	(A,86 ,150)	RS1/16S104J		
R 173	(A,48 ,143)	RS1/16S101J	R 255	(A,86 ,145)	RS1/16S104J		
R 174	(B,50 ,143)	RS1/16S101J	R 256	(A,102 ,138)	RS1/16S101J		
R 175	(B,52 ,143)	RS1/16S101J	R 258	(A,111 ,121)	RS1/16S101J		
R 176	(A,83 ,144)	RS1/16S101J	R 259	(B,19 ,30)	RS1/16S222J		C
R 179	(B,25 ,143)	RS1/16S103J	R 260	(A,138 ,118)	RS1/16S0R0J		
R 180	(B,27 ,153)	RS1/16S222J	R 261	(A,48 ,214)	RS1/16S220J		
R 188	(B,29 ,153)	RS1/16S103J	R 262	(A,46 ,214)	RS1/16S220J		
R 189	(B,87 ,96)	RS1/16S104J	R 263	(A,48 ,200)	RS1/16S470J		
R 190	(B,83 ,115)	RS1/16S474J	R 264	(A,43 ,202)	RS1/16S105J		
R 191	(B,106 ,129)	RS1/16S473J	R 265	(A,39 ,202)	RS1/16S222J		
R 192	(B,121 ,131)	RS1/16S473J	R 266	(B,48 ,213)	RS1/16S152J		
R 195	(B,123 ,131)	RS1/16S473J	R 267	(B,41 ,225)	RS1/16S0R0J		
R 196	(A,88 ,153)	RS1/16S104J	R 268	(B,44 ,225)	RS1/16S0R0J		
R 197	(B,83 ,140)	RS1/16S182J	R 271	(B,21 ,30)	RS1/16S473J		
R 199	(A,137 ,149)	RAB4C104J	R 272	(A,125 ,99)	RAB4C473J		D
R 201	(A,102 ,125)	RAB4C101J	R 274	(A,124 ,114)	RS1/16S473J		
R 202	(A,106 ,121)	RAB4C101J	R 277	(A,121 ,210)	RS1/16S471J		
R 203	(B,108 ,129)	RS1/16S472J	R 281	(A,133 ,215)	RS1/16S101J		
R 204	(B,108 ,133)	RS1/16S473J	R 282	(A,136 ,215)	RS1/16S101J		
R 205	(A,109 ,121)	RS1/16S101J	R 283	(A,135 ,215)	RS1/16S102J		
R 206	(B,111 ,130)	RS1/16S101J	R 284	(A,136 ,218)	RS1/16S102J		
R 207	(B,113 ,130)	RS1/16S473J	R 285	(A,122 ,207)	RS1/16S0R0J		
R 208	(B,115 ,130)	RS1/16S473J	R 286	(A,122 ,203)	RS1/16S105J		
R 209	(A,119 ,118)	RAB4C101J	R 287	(B,137 ,204)	RS1/16S104J		
R 210	(A,124 ,122)	RAB4C101J	R 288	(B,133 ,204)	RS1/16S104J		
R 211	(A,124 ,118)	RAB4C473J	R 289	(B,137 ,209)	RS1/16S104J		E
R 214	(A,127 ,127)	RAB4C101J	R 290	(B,132 ,209)	RS1/16S104J		
R 215	(A,127 ,129)	RS1/16S101J	R 291	(A,130 ,197)	RS1/16S104J		
R 216	(A,127 ,131)	RS1/16S101J	R 292	(A,132 ,197)	RS1/16S104J		
R 217	(A,121 ,114)	RS1/16S473J	R 293	(A,127 ,197)	RAB4C101J		
R 218	(A,127 ,133)	RAB4C101J	R 294	(A,137 ,204)	RAB4C101J		
R 220	(A,127 ,136)	RS1/16S101J	R 295	(A,137 ,208)	RAB4C101J		
R 221	(B,117 ,133)	RS1/16S473J	R 298	(B,101 ,150)	RS1/16S104J		
R 222	(A,127 ,137)	RS1/16S473J	R 299	(B,104 ,138)	RS1/16S101J		
R 223	(B,118 ,138)	RS1/16S473J	R 301	(B,96 ,220)	RS1/16S101J		
R 224	(B,131 ,139)	RS1/16S101J	R 302	(B,83 ,219)	RS1/16S101J		
R 225	(A,127 ,140)	RS1/16S101J	R 303	(B,69 ,219)	RS1/16S101J		F
R 226	(B,133 ,139)	RS1/16S101J	R 304	(B,56 ,219)	RS1/16S101J		
R 227	(A,102 ,133)	RAB4C101J	R 307	(B,127 ,223)	RS1/16S750J		

	<u>Mark No.</u>	<u>Description</u>	<u>Part No.</u>	<u>Mark No.</u>	<u>Description</u>	<u>Part No.</u>
	R 308	(B,116 ,223)	RS1/16S750J	R 415	(B,74 ,79)	RS1/16SOR0J
	R 309	(B,125 ,219)	RS1/16S100J	R 416	(B,70 ,117)	RS1/16SOR0J
	R 310	(B,112 ,223)	RS1/16S100J	R 418	(B,74 ,117)	RS1/16SOR0J
A	R 319	(A,96 ,205)	RS1/16S101J	R 420	(B,75 ,75)	RS1/16SOR0J
	R 320	(A,96 ,201)	RS1/16S101J	R 422	(B,19 ,197)	RS1/16SOR0J
	R 321	(A,114 ,198)	RS1/16S1802F	R 425	(B,76 ,79)	RS1/16SOR0J
	R 322	(A,93 ,193)	RS1/16S470J	R 426	(B,68 ,192)	RS1/16S101J
	R 323	(A,95 ,193)	RS1/16S101J	R 427	(B,66 ,192)	RS1/16S101J
	R 324	(B,91 ,193)	RS1/16S101J	R 428	(A,70 ,196)	RS1/16S220J
	R 325	(B,93 ,193)	RS1/16S101J	R 429	(A,66 ,196)	RS1/16S470J
	R 326	(B,95 ,193)	RS1/16S101J	R 430	(A,69 ,206)	RS1/16S473J
	R 327	(A,108 ,191)	RS1/16S221J	R 431	(A,137 ,161 ) RESISTOR ARRAY	RAB4C104J
	R 328	(A,110 ,191)	RAB4C221J	R 432	(A,137 ,157 ) RESISTOR ARRAY	RAB4C104J
	R 329	(A,113 ,191)	RS1/16S101J	R 433	(A,24 ,157 ) RESISTOR ARRAY	RAB4C104J
B	R 330	(A,114 ,194)	RS1/16S0R0J	R 434	(A,24 ,161 ) RESISTOR ARRAY	RAB4C104J
	R 331	(A,69 ,216)	RS1/16S0R0J	R 435	(A,24 ,102)	RS1/16S104J
	R 333	(A,17 ,195)	RS1/16S101J	R 436	(A,24 ,104)	RS1/16S104J
	R 335	(A,84 ,161)	RS1/16S101J	R 437	(A,24 ,105)	RS1/16S104J
	R 336	(A,86 ,161)	RS1/16S101J	R 438	(A,24 ,108 ) RESISTOR ARRAY	RAB4C104J
	R 337	(A,87 ,161)	RS1/16S470J	R 439	(A,69 ,184)	RS1/16S0R0J
	R 339	(A,89 ,161)	RS1/16S101J	R 440	(A,66 ,184)	RS1/16S101J
	R 340	(A,90 ,161)	RS1/16S101J	R 441	(A,70 ,184)	RS1/16S470J
	R 341	(A,92 ,161)	RS1/16S470J	R 442	(A,67 ,184)	RS1/16S470J
	R 343	(A,89 ,175)	RS1/16S101J	R 443	(A,75 ,184)	RS1/16S0R0J
C	R 344	(A,90 ,175)	RS1/16S101J	R 444	(A,78 ,184)	RS1/16S0R0J
	R 345	(A,92 ,175)	RS1/16S470J	R 445	(B,78 ,195)	RS1/16S0R0J
	R 347	(A,84 ,175)	RS1/16S101J	R 446	(B,73 ,195)	RS1/16S0R0J
	R 348	(A,86 ,175)	RS1/16S101J	R 447	(A,76 ,184)	RS1/16S470J
	R 349	(A,87 ,175)	RS1/16S470J	R 448	(A,79 ,184)	RS1/16S470J
	R 351	(A,74 ,161)	RS1/16S101J	R 449	(B,74 ,188)	RS1/16S470J
	R 352	(A,75 ,161)	RS1/16S101J	R 450	(B,76 ,188)	RS1/16S470J
	R 353	(A,77 ,161)	RS1/16S470J	R 453	(A,130 ,73)	RS1/16S752J
	R 356	(A,81 ,161)	RS1/16S470J	R 454	(A,130 ,80)	RS1/16S752J
	R 359	(A,82 ,175)	RS1/16S470J	R 455	(A,130 ,75)	RS1/16S822J
	R 360	(A,75 ,175)	RS1/16S101J	R 456	(A,130 ,78)	RS1/16S822J
D	R 361	(A,76 ,175)	RS1/16S101J	R 457	(B,128 ,71)	RS1/16S392J
	R 362	(A,78 ,175)	RS1/16S470J	R 458	(B,128 ,82)	RS1/16S392J
	R 363	(A,101 ,169)	RS1/16S101J	R 461	(A,137 ,76)	RS1/16S223J
	R 364	(A,102 ,169)	RS1/16S101J	R 462	(A,137 ,77)	RS1/16S223J
	R 365	(A,104 ,169)	RS1/16S470J	R 463	(B,122 ,72)	RS1/16S104J
	R 369	(A,108 ,169)	RS1/16S470J	R 464	(B,122 ,81)	RS1/16S104J
	R 373	(A,109 ,181)	RS1/16S470J	R 465	(A,108 ,73)	RS1/16S101J
	R 375	(A,101 ,181)	RS1/16S101J	R 466	(A,108 ,79)	RS1/16S101J
	R 376	(A,103 ,181)	RS1/16S101J	R 472	(B,95 ,114)	RS1/16S0R0J
	R 377	(A,104 ,181)	RS1/16S470J	R 473	(B,97 ,114)	RS1/16S0R0J
	R 379	(A,119 ,168)	RS1/16S101J	R 474	(B,139 ,118)	RS1/16S0R0J
E	R 380	(A,121 ,168)	RS1/16S101J	R 475	(B,137 ,118)	RS1/16S0R0J
	R 381	(A,122 ,168)	RS1/16S470J	R 480	(A,144 ,172)	RS1/16S0R0J
	R 383	(A,124 ,168)	RS1/16S101J	R 481	(B,99 ,82)	RS1/16S101J
	R 384	(A,125 ,168)	RS1/16S101J	R 482	(B,96 ,82)	RS1/16S101J
	R 385	(A,127 ,168)	RS1/16S470J	R 483	(A,91 ,76)	RS1/16S101J
	R 387	(A,123 ,182)	RS1/16S101J	R 484	(A,99 ,82)	RS1/16S470J
	R 388	(A,125 ,182)	RS1/16S101J	R 485	(A,98 ,82)	RS1/16S101J
	R 389	(A,126 ,182)	RS1/16S470J	R 487	(A,137 ,74)	RS1/16S104J
	R 395	(B,70 ,79)	RS1/16S0R0J	R 488	(A,23 ,177)	RS1/16S101J
	R 400	(B,71 ,75)	RS1/16S0R0J	R 489	(A,26 ,183)	RS1/16S470J
	R 405	(B,72 ,79)	RS1/16S0R0J	R 491	(A,83 ,184)	RS1/16S101J
	R 410	(B,73 ,75)	RS1/16S0R0J	R 493	(B,87 ,193)	RS1/16S101J
F	R 411	(B,96 ,129)	RS1/16S0R0J	R 494	(B,85 ,193)	RS1/16S470J
	R 413	(B,92 ,129)	RS1/16S0R0J	R 495	(A,85 ,184)	RS1/16S470J

5		6		7		8	
Mark No.	Description	Part No.	Mark No.	Description	Part No.		
R 496	(A,88 ,184)	RS1/16S470J	R 658	(A,106 ,59)	RS1/16S221J		
R 497	(B,89 ,193)	RS1/16S470J	R 659	(A,106 ,58)	RS1/16S221J		
R 501	(A,127 ,40)	RS1/16S222J	R 660	(A,106 ,56)	RS1/16S221J		
R 502	(A,111 ,40)	RS1/16S222J	R 661	(A,91 ,53)	RS1/16S221J		A
R 503	(A,124 ,40)	RS1/16S222J	R 701	(A,85 ,40)	RS1/16S222J		
R 504	(A,115 ,40)	RS1/16S222J	R 702	(A,69 ,40)	RS1/16S222J		
R 505	(B,127 ,36)	RS1/16S362J	R 703	(A,82 ,40)	RS1/16S222J		
R 506	(B,111 ,36)	RS1/16S362J	R 704	(A,73 ,40)	RS1/16S222J		
R 507	(B,125 ,36)	RS1/16S101J	R 705	(B,85 ,36)	RS1/16S302J		
R 508	(B,113 ,36)	RS1/16S101J	R 706	(B,69 ,36)	RS1/16S302J		
R 509	(A,127 ,34)	RS1/16S362J	R 707	(B,83 ,36)	RS1/16S101J		
R 510	(A,111 ,34)	RS1/16S362J	R 708	(B,71 ,36)	RS1/16S101J		
R 511	(A,127 ,36)	RS1/16S101J	R 709	(A,85 ,34)	RS1/16S302J		
R 512	(A,111 ,36)	RS1/16S101J	R 710	(A,69 ,34)	RS1/16S302J		B
R 513	(A,127 ,37)	RS1/16S122J	R 711	(A,85 ,36)	RS1/16S101J		
R 514	(A,111 ,37)	RS1/16S122J	R 712	(A,69 ,36)	RS1/16S101J		
R 515	(A,125 ,38)	RS1/16S122J	R 713	(A,85 ,37)	RS1/16S152J		
R 516	(A,114 ,38)	RS1/16S122J	R 714	(A,69 ,37)	RS1/16S152J		
R 517	(B,121 ,31)	RS1/16S474J	R 715	(A,83 ,38)	RS1/16S152J		
R 518	(B,117 ,31)	RS1/16S474J	R 716	(A,72 ,38)	RS1/16S152J		
R 519	(B,123 ,26)	RS1/16S221J	R 717	(B,79 ,31)	RS1/16S474J		
R 520	(B,115 ,26)	RS1/16S221J	R 718	(B,75 ,31)	RS1/16S474J		
R 551	(A,112 ,54)	RS1/16S101J	R 719	(B,81 ,26)	RS1/16S221J		
R 552	(A,112 ,58)	RS1/16S101J	R 720	(B,73 ,26)	RS1/16S221J		
R 553	(A,112 ,56)	RS1/16S101J	R 751	(A,70 ,54)	RS1/16S101J		C
R 554	(A,112 ,59)	RS1/16S0R0J	R 752	(A,70 ,58)	RS1/16S101J		
R 555	(A,112 ,55)	RS1/16S101J	R 753	(A,70 ,56)	RS1/16S101J		
R 556	(A,127 ,55)	RS1/16S0R0J	R 754	(A,70 ,59)	RS1/16S0R0J		
R 557	(A,127 ,53)	RS1/16S0R0J	R 755	(A,70 ,55)	RS1/16S101J		
R 558	(A,127 ,59)	RS1/16S221J	R 756	(A,85 ,55)	RS1/16S0R0J		
R 559	(A,127 ,58)	RS1/16S221J	R 757	(A,85 ,53)	RS1/16S0R0J		
R 560	(A,127 ,56)	RS1/16S221J	R 758	(A,85 ,59)	RS1/16S221J		
R 561	(A,112 ,53)	RS1/16S221J	R 759	(A,85 ,58)	RS1/16S221J		
R 601	(A,106 ,40)	RS1/16S222J	R 760	(A,85 ,56)	RS1/16S221J		
R 602	(A,90 ,40)	RS1/16S222J	R 761	(A,70 ,53)	RS1/16S221J		
R 603	(A,103 ,40)	RS1/16S222J	R 801	(A,64 ,40)	RS1/16S222J		D
R 604	(A,94 ,40)	RS1/16S222J	R 802	(A,48 ,40)	RS1/16S222J		
R 605	(B,106 ,36)	RS1/16S302J	R 803	(A,61 ,40)	RS1/16S222J		
R 606	(B,90 ,36)	RS1/16S682J	R 804	(A,52 ,40)	RS1/16S222J		
R 607	(B,104 ,36)	RS1/16S101J	R 805	(B,64 ,36)	RS1/16S302J		
R 608	(B,92 ,36)	RS1/16S101J	R 806	(B,48 ,36)	RS1/16S302J		
R 609	(A,106 ,34)	RS1/16S302J	R 807	(B,62 ,36)	RS1/16S101J		
R 610	(A,90 ,34)	RS1/16S682J	R 808	(B,50 ,36)	RS1/16S101J		
R 611	(A,106 ,36)	RS1/16S101J	R 809	(A,64 ,34)	RS1/16S302J		
R 612	(A,90 ,36)	RS1/16S101J	R 810	(A,48 ,34)	RS1/16S302J		
R 613	(A,106 ,37)	RS1/16S152J	R 811	(A,64 ,36)	RS1/16S101J		
R 614	(A,90 ,37)	RS1/16S102J	R 812	(A,48 ,36)	RS1/16S101J		E
R 615	(A,104 ,38)	RS1/16S152J	R 813	(A,64 ,37)	RS1/16S152J		
R 616	(A,93 ,38)	RS1/16S102J	R 814	(A,48 ,37)	RS1/16S152J		
R 617	(B,100 ,31)	RS1/16S474J	R 815	(A,62 ,38)	RS1/16S152J		
R 618	(B,96 ,31)	RS1/16S474J	R 816	(A,51 ,38)	RS1/16S152J		
R 619	(B,102 ,26)	RS1/16S221J	R 817	(B,58 ,31)	RS1/16S474J		
R 620	(B,94 ,26)	RS1/16S221J	R 818	(B,54 ,31)	RS1/16S474J		
R 651	(A,91 ,54)	RS1/16S101J	R 819	(B,60 ,26)	RS1/16S221J		
R 652	(A,91 ,58)	RS1/16S101J	R 820	(B,52 ,26)	RS1/16S221J		
R 653	(A,91 ,56)	RS1/16S101J	R 851	(A,49 ,54)	RS1/16S101J		
R 654	(A,91 ,59)	RS1/16S0R0J	R 852	(A,49 ,58)	RS1/16S101J		
R 655	(A,91 ,55)	RS1/16S101J	R 853	(A,49 ,56)	RS1/16S101J		F
R 656	(A,106 ,55)	RS1/16S0R0J	R 854	(A,49 ,59)	RS1/16S0R0J		
R 657	(A,106 ,53)	RS1/16S0R0J	R 858	(A,64 ,59)	RS1/16S221J		

**Mark No. Description****Part No.****Mark No. Description****Part No.**

R 859 (A,64 ,58 )  
R 860 (A,64 ,56 )  
R 861 (A,49 ,53 )  
R 864 (B,53 ,55 )

RS1/16S221J  
RS1/16S221J  
RS1/16S221J  
RS1/16S0R0J

R 994 (A,59 ,85 )  
R 997  
R 998 (A,50 ,85 )  
R 999 (A,51 ,85 )

RS1/16S0R0J  
RS1/16S0R0J  
RS1/16S101J  
RS1/16S220J

R 901 (A,43 ,40 )  
R 902 (A,27 ,40 )  
R 903 (A,40 ,40 )  
R 904 (A,31 ,40 )  
R 905 (B,43 ,36 )

RS1/16S222J  
RS1/16S222J  
RS1/16S222J  
RS1/16S222J  
RS1/16S302J

R 9983  
R 9984  
R 9989  
R 9990

RS1/16S0R0J  
RS1/16S0R0J  
RS1/16S0R0J  
RS1/16S0R0J

R 906 (B,27 ,36 )  
R 907 (B,41 ,36 )  
R 908 (B,29 ,36 )  
R 909 (A,43 ,34 )  
R 910 (A,27 ,34 )

RS1/16S302J  
RS1/16S101J  
RS1/16S101J  
RS1/16S302J  
RS1/16S302J

**CAPACITORS**

C 101 (B,14 ,38 )  
C 102 (A,11 ,38 ) ELECTR.CAPACITOR  
C 103 (A,18 ,126 )  
C 105 (A,33 ,148 )  
C 106 (A,34 ,148 )

CKSRYB103K50  
CEAT102M10  
CKSRYB103K50  
CKSRYB104K16  
CKSRYB471K50

R 911 (A,43 ,36 )  
R 912 (A,27 ,36 )  
R 913 (A,43 ,37 )  
R 914 (A,27 ,37 )  
R 915 (A,41 ,38 )

RS1/16S101J  
RS1/16S101J  
RS1/16S152J  
RS1/16S152J  
RS1/16S152J

C 108 (A,46 ,141 )  
C 109 (A,46 ,143 )  
C 110 (A,59 ,148 )  
C 111 (A,57 ,148 )  
C 114 (A,45 ,170 )

CKSRYB104K16  
CKSRYB471K50  
CKSRYB104K16  
CKSRYB471K50  
CKSRYB104K16

R 916 (A,30 ,38 )  
R 917 (B,37 ,31 )  
R 918 (B,33 ,31 )  
R 919 (B,39 ,26 )  
R 920 (B,31 ,26 )

RS1/16S152J  
RS1/16S474J  
RS1/16S474J  
RS1/16S221J  
RS1/16S221J

C 115 (A,45 ,169 )  
C 116 (A,33 ,181 )  
C 117 (A,34 ,181 )  
C 118 (A,86 ,94 )  
C 120 (B,26 ,129 )

CKSRYB471K50  
CKSRYB104K16  
CKSRYB471K50  
CKSRYB104K16  
CKSRYB472K50

R 921 (A,113 ,181 )  
R 923 (A,115 ,169 )  
R 925 (A,114 ,181 )  
R 926 (A,114 ,169 )  
R 927 (A,117 ,169 )

RS1/16S101J  
RS1/16S101J  
RS1/16S470J  
RS1/16S470J  
RS1/16S470J

C 121 (B,21 ,129 )  
C 122 (A,16 ,141 )  
C 123 (B,52 ,17 )  
C 124 (B,46 ,17 )  
C 125 (A,62 ,13 )

CKSRYB103K50  
CEAT471M6R3  
CKSRYB473K25  
CKSRYB473K25  
CEAT100M50

R 928 (A,117 ,181 )  
R 945 (A,37 ,70 )  
R 946 (A,42 ,70 )  
R 947 (A,37 ,87 )  
R 948 (A,42 ,87 )

RS1/16S470J  
RS1/16S0R0J  
RS1/16S0R0J  
RS1/16S0R0J  
RS1/16S0R0J

C 126 (A,18 ,147 )  
C 127 (B,19 ,129 )  
C 128 (A,85 ,114 )  
C 130 (A,59 ,133 )  
C 131 (A,79 ,138 )

CKSRYB105K10  
CKSRYB472K50  
CKSRYB104K16  
CKSRYB104K16  
CKSRYB104K16

R 949 (A,43 ,61 )  
R 951 (A,28 ,54 )  
R 952 (A,28 ,58 )  
R 953 (A,28 ,56 )  
R 954 (A,28 ,59 )

RS1/16S221J  
RS1/16S101J  
RS1/16S101J  
RS1/16S101J  
RS1/16S0R0J

C 132 (A,59 ,122 )  
C 133 (A,93 ,17 )  
C 135 (B,48 ,150 )  
C 201 (A,120 ,108 )  
C 202 (A,114 ,116 )

CKSRYB104K16  
CKSRYB104K16  
CKSRYB472K50  
CKSRYB104K16  
CKSRYB104K16

R 959 (A,43 ,58 )  
R 960 (A,43 ,56 )  
R 961 (A,28 ,53 )  
R 963 (A,16 ,191 )  
R 964 (B,14 ,190 )

RS1/16S221J  
RS1/16S221J  
RS1/16S221J  
RS1/16S0R0J  
RS1/16S101J

C 203 (A,114 ,118 )  
C 204 (A,115 ,145 )  
C 205 (A,115 ,143 )  
C 206 (A,101 ,129 )  
C 207 (A,103 ,129 )

CKSRYB471K50  
CKSRYB104K16  
CKSRYB471K50  
CKSRYB104K16  
CKSRYB471K50

R 966 (B,21 ,190 )  
R 969 (B,25 ,195 )  
R 972 (A,50 ,73 )  
R 973 (A,52 ,73 )  
R 975 (A,53 ,73 )

RS1/16S101J  
RS1/16S0R0J  
RS1/16S0R0J  
RS1/16S470J  
RS1/16S101J

C 208 (A,15 ,17 ) ELECTR.CAPACITOR  
C 209 (A,101 ,155 )  
C 210 (A,102 ,155 )  
C 211 (A,129 ,108 )  
C 212 (A,103 ,109 )

CEAT102M10  
CKSRYB104K16  
CKSRYB471K50  
CKSRYB104K16  
CKSRYB104K16

R 976 (A,55 ,73 )  
R 977 (A,56 ,73 )  
R 980 (A,54 ,85 )  
R 981 (A,56 ,85 )  
R 984 (A,61 ,73 )

RS1/16S101J  
RS1/16S470J  
RS1/16S0R0J  
RS1/16S470J  
RS1/16S0R0J

C 213 (A,111 ,108 )  
C 215 (A,80 ,127 )  
C 216 (A,88 ,127 )  
C 217 (A,87 ,138 )  
C 218 (A,78 ,150 )

CKSRYB104K16  
CKSRYB104K16  
CKSRYB104K16  
CKSRYB104K16  
CKSRYB104K16

R 985 (A,62 ,73 )  
R 988 (A,65 ,73 )  
R 989 (A,67 ,73 )  
R 990  
R 992 (A,65 ,85 )

RS1/16S470J  
RS1/16S0R0J  
RS1/16S470J  
RS1/16S0R0J  
RS1/16S0R0J

C 219 (A,88 ,150 )  
C 221 (A,129 ,89 )  
C 222 (A,131 ,93 )  
C 261 (A,51 ,216 )  
C 262 (A,50 ,209 )

CKSRYB104K16  
CKSRYB104K16  
CEAT331M10  
CEAT470M16  
CKSRYB104K16

R 993 (A,67 ,85 )

RS1/16S470J



5		6		7		8	
Mark No.	Description	Part No.	Mark No.	Description	Part No.		
C 263	(A,48 ,202 )	CKSRYP104K16	C 358	(A,136 ,193 )	CEAT331M10		
C 264	(B,46 ,206 )	CKSRYP104K16	C 359	(A,71 ,190 )	CKSRYP104K16		
C 265	(B,42 ,209 )	CKSRYP104K16	C 360	(A,73 ,190 )	CKSRYP471K50		
C 266	(B,39 ,209 )	CKSRYP104K16	C 361	(A,80 ,190 )	CKSRYP104K16		A
C 267	(A,41 ,213 )	CKSRYP104K16	C 362	(A,82 ,190 )	CKSRYP471K50		
C 269	(A,38 ,214 )	CKSRYP104K16	C 363	(A,47 ,79 )	CKSRYP104K16		
C 270	(B,43 ,202 )	CCSRCH180J50	C 364	(A,49 ,79 )	CKSRYP471K50		
C 271	(B,38 ,202 )	CCSRCH220J50	C 365	(A,59 ,79 )	CKSRYP104K16		
C 272	(B,38 ,215 )	CKSRYP103K50	C 366	(A,60 ,79 )	CKSRYP471K50		
C 281	(A,145 ,215 )	CEAT470M16	C 367	(A,19 ,184 )	CEAT101M10		
C 282	(B,140 ,213 )	CKSRYP104K16	C 368	(A,20 ,181 )	CKSRYP104K16		
C 283	(A,132 ,213 )	CKSRYP104K16	C 369	(A,21 ,181 )	CKSRYP471K50		
C 284	(A,137 ,213 )	CKSRYP104K16	C 371	(B,141 ,172 )	CKSRYP104K16		
C 285	(B,131 ,216 )	CKSRYP104K16	C 372	(B,143 ,172 )	CKSRYP472K50		
C 286	(A,126 ,214 )	CEAT470M16	C 374	(A,25 ,171 )	CKSRYP104K16		B
C 287	(B,127 ,209 )	CKSRYP104K16	C 375	(A,25 ,169 )	CKSRYP472K50		
C 288	(B,129 ,209 )	CKSRYP471K50	C 377	(A,24 ,101 )	CKSRYP104K16		
C 289	(A,121 ,207 )	CCSRCH100D50	C 379	(A,139 ,141 )	CKSRYP104K16		
C 290	(A,121 ,203 )	CCSRCH100D50	C 380	(B,142 ,194 )	CKSRYP104K16		
C 293	(B,145 ,209 )	CKSRYP105K10	C 451	(A,125 ,71 )	CEAT100M50		
C 301	(A,79 ,214 )	CEJQ101M10	C 452	(A,125 ,82 )	CEAT100M50		
C 302	(B,99 ,220 )	CKSRYP104K16	C 453	(A,112 ,74 )	CEAT100M50		
C 303	(B,86 ,219 )	CKSRYP104K16	C 454	(A,112 ,80 )	CEAT100M50		
C 304	(B,72 ,219 )	CKSRYP104K16	C 455	(A,108 ,75 )	CKSRYP103K50		
C 305	(B,59 ,219 )	CKSRYP104K16	C 456	(A,108 ,78 )	CKSRYP103K50		C
C 306	(B,27 ,219 )	CKSRYP104K16	C 481	(A,115 ,77 )	CKSRYP103K50		
C 307	(B,15 ,219 )	CKSRYP104K16	C 482	(A,123 ,76 )	CKSRYP103K50		
C 308	(B,127 ,219 )	CKSRYP103K50	C 483	(A,104 ,69 )	CEAT101M10		
C 309	(B,114 ,223 )	CKSRYP103K50	C 484	(A,99 ,72 )	CKSRYP104K16		
C 319	(A,119 ,195 )	CEJQ101M6R3	C 485	(A,92 ,69 )	CEAT101M10		
C 320	(A,114 ,195 )	CKSRYP104K16	C 486	(A,96 ,72 )	CKSRYP104K16		
C 321	(A,114 ,197 )	CKSRYP471K50	C 487	(A,105 ,84 )	CEAT101M10		
C 322	(A,96 ,216 )	CEJQ101M10	C 488	(A,104 ,77 )	CKSRYP104K16		
C 323	(A,98 ,205 )	CKSRYP104K16	C 489	(A,91 ,80 )	CKSRYP471K50		
C 324	(A,98 ,204 )	CKSRYP471K50	C 490	(A,91 ,78 )	CKSRYP104K16		
C 325	(A,88 ,210 )	CEJQ101M6R3	C 491	(A,90 ,83 )	CEAT101M10		D
C 326	(A,97 ,197 )	CKSRYP104K16	C 501	(A,127 ,39 )	CKSRYP102K50		
C 327	(A,99 ,197 )	CKSRYP471K50	C 502	(A,111 ,39 )	CKSRYP102K50		
C 328	(A,100 ,193 )	CCSRCH120J50	C 503	(B,123 ,36 )	CCSRCH331J50		
C 329	(A,103 ,193 )	CCSRCH120J50	C 504	(B,115 ,36 )	CCSRCH331J50		
C 330	(A,114 ,200 )	CKSRYP474K10	C 505	(A,125 ,35 )	CCSRCH331J50		
C 332	(A,19 ,205 )	CEAT101M10	C 506	(A,114 ,35 )	CCSRCH331J50		
C 333	(A,12 ,195 )	CKSRYP104K16	C 507	(A,127 ,30 )	CEAT100M50		
C 334	(A,13 ,195 )	CKSRYP471K50	C 508	(A,111 ,30 )	CEAT100M50		
C 335	(A,19 ,195 )	CKSRYP104K16	C 509	(B,121 ,26 )	CKSRYP472K50		
C 336	(A,20 ,195 )	CKSRYP471K50	C 510	(B,117 ,26 )	CKSRYP472K50		E
C 338	(A,83 ,168 )	CKSRYP104K16	C 551	(A,119 ,31 )	CKSRYP103K50		
C 339	(A,85 ,168 )	CKSRYP471K50	C 552	(A,120 ,39 )	CKSRYP103K50		
C 340	(A,74 ,168 )	CKSRYP104K16	C 553	(A,118 ,64 )	CEAT101M10		
C 341	(A,75 ,168 )	CKSRYP471K50	C 554	(A,112 ,51 )	CKSRYP104K16		
C 342	(A,99 ,175 )	CKSRYP104K16	C 555	(A,119 ,59 )	CKSRYP103K50		
C 343	(A,100 ,175 )	CKSRYP471K50	C 556	(A,127 ,44 )	CEAT101M10		
C 344	(A,119 ,175 )	CKSRYP104K16	C 557	(A,125 ,48 )	CKSRYP104K16		
C 345	(A,120 ,175 )	CKSRYP471K50	C 558	(A,125 ,50 )	CKSRYP104K16		
C 346	(A,84 ,79 )	CEAT331M10	C 559	(A,112 ,49 )	CKSRYP104K16		
C 352	(A,61 ,190 )	CKSRYP104K16	C 560	(A,111 ,44 )	CEAT101M10		
C 353	(A,63 ,190 )	CKSRYP471K50	C 561	(B,111 ,47 )	CKSRYP104K16		
C 354	(A,66 ,94 )	CKSRYP104K16	C 601	(A,106 ,39 )	CKSRYP102K50		
C 355	(A,24 ,166 )	CKSRYP104K16	C 602	(A,90 ,39 )	CKSRYP102K50		F
C 357	(A,144 ,187 )	CKSRYP104K16	C 603	(B,102 ,36 )	CCSRCH331J50		

1

2

3

4

**Mark No. Description****Part No.****Mark No. Description****Part No.**

C 604 (B,94 ,36 )  
C 605 (A,104 ,35 )  
C 606 (A,93 ,35 )  
A C 607 (A,106 ,30 )  
C 608 (A,90 ,30 )

CCSRCH221J50  
CCSRCH331J50  
CCSRCH221J50  
CEAT100M50  
CEAT100M50

C 901 (A,43 ,39 )  
C 902 (A,27 ,39 )  
C 903 (B,39 ,36 )  
C 904 (B,31 ,36 )  
C 905 (A,41 ,35 )

CKSRYB102K50  
CKSRYB102K50  
CCSRCH331J50  
CCSRCH331J50  
CCSRCH331J50

C 609 (B,100 ,26 )  
C 610 (B,96 ,26 )  
C 651 (A,98 ,31 )  
C 652 (A,99 ,39 )  
C 653 (A,97 ,64 )

CKSRYB472K50  
CKSRYB472K50  
CKSRYB103K50  
CKSRYB103K50  
CEAT101M10

C 906 (A,30 ,35 )  
C 907 (A,43 ,30 )  
C 908 (A,27 ,30 )  
C 909 (B,37 ,26 )  
C 910 (B,33 ,26 )

CCSRCH331J50  
CEAT100M50  
CEAT100M50  
CKSRYB472K50  
CKSRYB472K50

C 654 (A,91 ,51 )  
C 655 (A,98 ,59 )  
C 656 (A,106 ,44 )  
B C 657 (A,104 ,48 )  
C 658 (A,104 ,50 )

CKSRYB104K16  
CKSRYB103K50  
CEAT101M10  
CKSRYB104K16  
CKSRYB104K16

C 951 (A,35 ,31 )  
C 952 (A,36 ,39 )  
C 953 (A,34 ,64 )  
C 954 (A,28 ,51 )  
C 955 (A,35 ,59 )

CKSRYB103K50  
CKSRYB103K50  
CEAT101M10  
CKSRYB104K16  
CKSRYB103K50

C 659 (A,91 ,49 )  
C 660 (A,90 ,44 )  
C 661 (B,90 ,47 )  
C 701 (A,85 ,39 )  
C 702 (A,69 ,39 )

CKSRYB104K16  
CEAT101M10  
CKSRYB104K16  
CKSRYB102K50  
CKSRYB102K50

C 956 (A,43 ,44 )  
C 957 (A,41 ,48 )  
C 958 (A,41 ,50 )  
C 959 (A,28 ,49 )  
C 960 (A,27 ,44 )

CEAT101M10  
CKSRYB104K16  
CKSRYB104K16  
CKSRYB104K16  
CEAT101M10

C 703 (B,81 ,36 )  
C 704 (B,73 ,36 )  
C 705 (A,83 ,35 )  
C 706 (A,72 ,35 )  
C 707 (A,85 ,30 )

CCSRCH331J50  
CCSRCH331J50  
CCSRCH331J50  
CCSRCH331J50  
CEAT100M50

C 961 (B,27 ,47 )  
C 963 (A,109 ,175 )  
C 964 (A,110 ,175 )  
C 979 (B,31 ,70 )  
C 980 (B,95 ,77 )

CKSRYB104K16  
CKSRYB104K16  
CKSRYB471K50  
CKSRYB472K50  
CKSRYB472K50

C 708 (A,69 ,30 )  
C 709 (B,79 ,26 )  
C 710 (B,75 ,26 )  
C 751 (A,77 ,31 )  
C 752 (A,78 ,39 )

CEAT100M50  
CKSRYB472K50  
CKSRYB472K50  
CKSRYB103K50  
CKSRYB103K50

C 981 (B,67 ,15 )  
C 982 (B,65 ,15 )  
C 985 (B,93 ,77 )  
C 986 (B,91 ,77 )  
C 987 (B,34 ,70 )

CKSRYB104K16  
CKSRYB471K50  
CKSRYB104K16  
CKSRYB471K50  
CKSRYB104K16

C 753 (A,76 ,64 )  
C 754 (A,70 ,51 )  
C 755 (A,77 ,59 )  
C 756 (A,85 ,44 )  
C 757 (A,83 ,48 )

CEAT101M10  
CKSRYB104K16  
CKSRYB103K50  
CEAT101M10  
CKSRYB104K16

C 988 (B,32 ,70 )  
C 991 (A,140 ,57 )  
C 992 (A,134 ,64 )  
C 993 (B,137 ,68 )  
C 994 (B,137 ,72 )

CKSRYB471K50  
CKSRYB104K16  
CEAT101M10  
CKSRYB473K25  
CKSRYB473K25

D C 758 (A,83 ,50 )  
C 759 (A,70 ,49 )  
C 760 (A,69 ,44 )  
C 761 (B,69 ,47 )  
C 801 (A,64 ,39 )

CKSRYB104K16  
CKSRYB104K16  
CEAT101M10  
CKSRYB104K16  
CKSRYB102K50

C 802 (A,48 ,39 )  
C 803 (B,60 ,36 )  
C 804 (B,52 ,36 )  
C 805 (A,62 ,35 )  
C 806 (A,51 ,35 )

CKSRYB102K50  
CCSRCH331J50  
CCSRCH331J50  
CCSRCH331J50  
CCSRCH331J50

E C 807 (A,64 ,30 )  
C 808 (A,48 ,30 )  
C 809 (B,58 ,26 )  
C 810 (B,54 ,26 )  
C 851 (A,56 ,31 )

CEAT100M50  
CEAT100M50  
CKSRYB472K50  
CKSRYB472K50  
CKSRYB103K50

C 852 (A,57 ,39 )  
C 853 (A,55 ,64 )  
C 854 (A,49 ,51 )  
C 855 (A,56 ,59 )  
C 856 (A,64 ,44 )

CKSRYB103K50  
CEAT101M10  
CKSRYB104K16  
CKSRYB103K50  
CEAT101M10

F C 857 (A,62 ,48 )  
C 858 (A,62 ,50 )  
C 859 (A,49 ,49 )  
C 860 (A,48 ,44 )  
C 861 (B,48 ,47 )

CKSRYB104K16  
CKSRYB104K16  
CKSRYB104K16  
CEAT101M10  
CKSRYB104K16

## **L DIGITAL MOTHER ASSY (VSX-72TXV)**

### **MISCELLANEOUS**

IC 101 (A,46 ,158 ) CPU	PEG116A
IC 102 (A,46 ,180 ) FLASH ROM	AYW7076
IC1 FLASH MEMORY (4M)	MBM29F400TC-70PFTN
IC 103 (A,89 ,94 ) LOGIC IC	CD4094BPW
IC 104 (A,20 ,147 ) RESET IC	BU4842F
IC 105 (A,63 ,122 ) LOGIC IC	SN74AHCT32PW
IC 106 (A,63 ,133 ) LOGIC IC	SN74AHCT08PW
IC 107 (A,83 ,138 ) IC	TC74VHCT125AFTS1
IC 108 (A,90 ,114 ) LOGIC IC	SN74LV244ATPW
IC 201 (A,114 ,133 ) CPU	PEG117A
IC 202 (A,114 ,154 ) FLASH ROM	AYW7080
IC2 FLASH MEMORY(4M)	MBM29LV400TC-70PFTN
IC 203 (A,133 ,107 ) LOGIC IC	CD4094BPW
IC 204 (A,107 ,109 ) IC	TC74VHCT125AFTS1
IC 205 (A,115 ,107 ) LOGIC IC	SN74AHC02PW
IC 206 (A,84 ,127 ) LOGIC IC	SN74LV125APW
IC 207 (A,92 ,127 ) LOGIC IC	SN74AHC08PW
IC 208 (A,92 ,138 ) LOGIC IC	SN74LV244APW
IC 209 (A,82 ,150 ) LOGIC IC	SN74LV125APW
IC 210 (A,92 ,150 ) LOGIC IC	SN74AHC04PW
⚠ IC 221 (A,121 ,92 ) IC	NJM2391DL1-33
IC 281 (A,129 ,205 ) XM/DT IC	F2602E-01

1

2

3

4



	1	2	3	4		
	<u>Mark No.</u>	<u>Description</u>	<u>Part No.</u>	<u>Mark No.</u>	<u>Description</u>	<u>Part No.</u>
A	R 125	(B,52,150)	RS1/16S104J	R 208	(B,115,130)	RS1/16S473J
	R 126	(B,17,129)	RS1/16S473J	R 209	(A,119,118)	RAB4C101J
	R 127	(B,51,155)	RS1/16S104J	R 210	(A,124,122)	RAB4C101J
	R 128	(B,61,159)	RS1/16S473J	R 211	(A,124,118)	RAB4C473J
	R 129	(A,61,158)	RS1/16S473J	R 214	(A,127,127)	RAB4C101J
	R 131	(B,49,155)	RS1/16S104J	R 215	(A,127,129)	RS1/16S101J
	R 132	(A,61,162)	RAB4C101J	R 216	(A,127,131)	RS1/16S101J
	R 133	(A,61,166)	RAB4C101J	R 217	(A,121,114)	RS1/16S473J
	R 134	(B,61,163)	RS1/16S473J	R 218	(A,127,133)	RAB4C101J
	R 135	(A,56,171)	RS1/16S101J	R 220	(A,127,136)	RS1/16S101J
B	R 136	(B,19,132)	RS1/16S471J	R 221	(B,117,133)	RS1/16S473J
	R 137	(A,32,158)	RAB4C101J	R 222	(A,127,137)	RS1/16S473J
	R 138	(B,38,158)	RS1/16S474J	R 223	(B,118,138)	RS1/16S473J
	R 139	(B,36,158)	RS1/16S104J	R 224	(B,131,139)	RS1/16S101J
	R 140	(B,53,155)	RS1/16S474J	R 225	(A,127,140)	RS1/16S101J
	R 142	(B,38,153)	RS1/16S473J	R 226	(B,133,139)	RS1/16S101J
	R 144	(B,40,153)	RS1/16S473J	R 227	(A,102,133)	RAB4C101J
	R 145	(A,31,148)	RS1/16S101J	R 229	(B,112,138)	RS1/16S473J
	R 146	(B,46,179)	RS1/16S104J	R 230	(B,104,129)	RS1/16S101J
	R 147	(B,36,178)	RS1/16S473J	R 231	(A,22,147)	RS1/16S104J
C	R 149	(B,91,93)	RS1/16S473J	R 232	(B,115,153)	RS1/16S104J
	R 150	(B,89,93)	RS1/16S473J	R 234	(B,104,151)	RS1/16S473J
	R 151	(B,50,150)	RS1/16S104J	R 237	(A,134,99)	RS1/16S473J
	R 153	(B,31,129)	RS1/16S471J	R 238	(A,133,114)	RAB4C473J
	R 154	(B,29,129)	RS1/16S473J	R 239	(B,114,105)	RS1/16S104J
	R 155	(B,21,132)	RS1/16S102J	R 240	(B,116,105)	RS1/16S104J
	R 156	(B,24,129)	RS1/16S473J	R 241	(A,109,115)	RS1/16S101J
	R 157	(B,16,145)	RS1/16S470J	R 242	(A,29,176)	RS1/16S104J
	R 161	(B,54,17)	RS1/16S105J	R 243	(A,29,177)	RS1/16S104J
	R 162	(B,56,12)	RS1/16S223J	R 244	(B,108,138)	RS1/16S473J
D	R 164	(A,20,150)	RS1/16S104J	R 246	(B,89,140)	RS1/16S104J
	R 165	(B,33,163)	RS1/16S101J	R 247	(B,87,140)	RS1/16S104J
	R 166	(B,88,116)	RS1/16S104J	R 248	(B,96,139)	RS1/16S104J
	R 167	(B,94,110)	RS1/16S104J	R 249	(B,94,140)	RS1/16S104J
	R 168	(B,90,112)	RS1/16S104J	R 250	(B,104,147)	RS1/16S104J
	R 169	(B,85,129)	RS1/16S104J	R 251	(B,115,140)	RS1/16S104J
	R 170	(B,85,140)	RS1/16S104J	R 252	(B,106,143)	RS1/16S104J
	R 171	(A,80,133)	RS1/16S101J	R 253	(A,86,150)	RS1/16S104J
	R 172	(B,83,129)	RS1/16S104J	R 255	(A,86,145)	RS1/16S104J
	R 174	(B,50,143)	RS1/16S101J	R 256	(A,102,138)	RS1/16S101J
	R 175	(B,52,143)	RS1/16S101J	R 258	(A,111,121)	RS1/16S101J
	R 176	(A,83,144)	RS1/16S101J	R 259	(B,19,30)	RS1/16S222J
	R 179	(B,25,143)	RS1/16S103J	R 267	(B,41,225)	RS1/16S0R0J
	R 180	(B,27,153)	RS1/16S222J	R 268	(B,44,225)	RS1/16S0R0J
	R 188	(B,29,153)	RS1/16S103J	R 269	(A,51,209)	RS1/16S0R0J
E	R 189	(B,87,96)	RS1/16S104J	R 270	(A,50,206)	RS1/16S0R0J
	R 190	(B,83,115)	RS1/16S474J	R 271	(B,21,30)	RS1/16S473J
	R 191	(B,106,129)	RS1/16S473J	R 274	(A,124,114)	RS1/16S0R0J
	R 192	(B,121,131)	RS1/16S473J	R 275	(A,123,114)	RS1/16S0R0J
	R 195	(B,123,131)	RS1/16S473J	R 277	(A,121,210)	RS1/16S471J
	R 196	(A,88,153)	RS1/16S104J	R 281	(A,133,215)	RS1/16S101J
	R 197	(B,83,140)	RS1/16S182J	R 282	(A,136,215)	RS1/16S101J
	R 199	(A,137,149) RESISTOR ARRAY	RAB4C104J	R 283	(A,135,215)	RS1/16S102J
	R 201	(A,102,125)	RAB4C101J	R 284	(A,136,218)	RS1/16S102J
	R 202	(A,106,121)	RAB4C101J	R 285	(A,122,207)	RS1/16S0R0J
F	R 203	(B,108,129)	RS1/16S472J	R 286	(A,122,203)	RS1/16S105J
	R 204	(B,108,133)	RS1/16S473J	R 287	(B,137,204)	RS1/16S104J
	R 205	(A,109,121)	RS1/16S101J	R 288	(B,133,204)	RS1/16S104J
	R 206	(B,111,130)	RS1/16S101J	R 289	(B,137,209)	RS1/16S104J
	R 207	(B,113,130)	RS1/16S473J	R 290	(B,132,209)	RS1/16S104J

5		6		7		8	
Mark No.	Description	Part No.	Mark No.	Description	Part No.		
R 291	(A,130 ,197 )	RS1/16S104J	R 439	(A,69 ,184 )	RS1/16S0R0J		
R 292	(A,132 ,197 )	RS1/16S104J	R 440	(A,66 ,184 )	RS1/16S101J		
R 293	(A,127 ,197 )	RAB4C101J	R 441	(A,70 ,184 )	RS1/16S470J		A
R 294	(A,137 ,204 )	RAB4C101J	R 442	(A,67 ,184 )	RS1/16S470J		
R 295	(A,137 ,208 )	RAB4C101J	R 443	(A,75 ,184 )	RS1/16S0R0J		
R 298	(B,101 ,150 )	RS1/16S104J	R 444	(A,78 ,184 )	RS1/16S0R0J		
R 299	(B,104 ,138 )	RS1/16S101J	R 445	(B,78 ,195 )	RS1/16S0R0J		
R 300	(A,25 ,172 )	RS1/16S0R0J	R 446	(B,73 ,195 )	RS1/16S0R0J		
R 301	(B,96 ,220 )	RS1/16S101J	R 447	(A,76 ,184 )	RS1/16S470J		
R 302	(B,83 ,219 )	RS1/16S101J	R 448	(A,79 ,184 )	RS1/16S470J		
R 303	(B,69 ,219 )	RS1/16S101J	R 449	(B,74 ,188 )	RS1/16S470J		
R 304	(B,56 ,219 )	RS1/16S101J	R 450	(B,76 ,188 )	RS1/16S470J		
R 307	(B,127 ,223 )	RS1/16S750J	R 453	(A,130 ,73 )	RS1/16S752J		
R 308	(B,116 ,223 )	RS1/16S750J	R 454	(A,130 ,80 )	RS1/16S752J		B
R 309	(B,125 ,219 )	RS1/16S100J	R 455	(A,130 ,75 )	RS1/16S822J		
R 310	(B,112 ,223 )	RS1/16S100J	R 456	(A,130 ,78 )	RS1/16S822J		
R 320	(A,96 ,201 )	RS1/16S101J	R 457	(B,128 ,71 )	RS1/16S392J		
R 321	(A,114 ,198 )	RS1/16S1802F	R 458	(B,128 ,82 )	RS1/16S392J		
R 322	(A,93 ,193 )	RS1/16S470J	R 461	(A,137 ,76 )	RS1/16S223J		
R 323	(A,95 ,193 )	RS1/16S101J	R 462	(A,137 ,77 )	RS1/16S223J		
R 324	(B,91 ,193 )	RS1/16S101J	R 463	(B,122 ,72 )	RS1/16S104J		
R 325	(B,93 ,193 )	RS1/16S101J	R 464	(B,122 ,81 )	RS1/16S104J		
R 326	(B,95 ,193 )	RS1/16S101J	R 465	(A,108 ,73 )	RS1/16S101J		
R 327	(A,108 ,191 )	RS1/16S221J	R 466	(A,108 ,79 )	RS1/16S101J		
R 328	(A,110 ,191 )	RAB4C221J	R 472	(B,95 ,114 )	RS1/16S0R0J		C
R 329	(A,113 ,191 )	RS1/16S101J	R 473	(B,97 ,114 )	RS1/16S0R0J		
R 330	(A,114 ,194 )	RS1/16S0R0J	R 474	(B,139 ,118 )	RS1/16S0R0J		
R 332	(B,31 ,190 )	RS1/16S0R0J	R 475	(B,137 ,118 )	RS1/16S0R0J		
R 338	(A,86 ,159 )	RS1/16S0R0J	R 480	(A,144 ,172 )	RS1/16S0R0J		
R 342	(A,91 ,159 )	RS1/16S0R0J	R 481	(B,99 ,82 )	RS1/16S101J		
R 346	(A,91 ,178 )	RS1/16S0R0J	R 482	(B,96 ,82 )	RS1/16S101J		
R 350	(A,86 ,178 )	RS1/16S0R0J	R 483	(A,91 ,76 )	RS1/16S101J		
R 351	(A,74 ,161 )	RS1/16S101J	R 484	(A,99 ,82 )	RS1/16S470J		
R 352	(A,75 ,161 )	RS1/16S101J	R 485	(A,98 ,82 )	RS1/16S101J		
R 353	(A,77 ,161 )	RS1/16S470J	R 487	(A,137 ,74 )	RS1/16S104J		
R 356	(A,81 ,161 )	RS1/16S470J	R 491	(A,83 ,184 )	RS1/16S101J		D
R 359	(A,82 ,175 )	RS1/16S470J	R 493	(B,87 ,193 )	RS1/16S101J		
R 360	(A,75 ,175 )	RS1/16S101J	R 494	(B,85 ,193 )	RS1/16S470J		
R 361	(A,76 ,175 )	RS1/16S101J	R 495	(A,85 ,184 )	RS1/16S470J		
R 362	(A,78 ,175 )	RS1/16S470J	R 496	(A,88 ,184 )	RS1/16S470J		
R 363	(A,101 ,169 )	RS1/16S101J	R 497	(B,89 ,193 )	RS1/16S470J		
R 364	(A,102 ,169 )	RS1/16S101J	R 499	(A,23 ,98 )	RS1/16S0R0J		
R 365	(A,104 ,169 )	RS1/16S470J	R 501	(A,127 ,40 )	RS1/16S222J		
R 369	(A,108 ,169 )	RS1/16S470J	R 502	(A,111 ,40 )	RS1/16S222J		
R 373	(A,109 ,181 )	RS1/16S470J	R 503	(A,124 ,40 )	RS1/16S222J		
R 375	(A,101 ,181 )	RS1/16S101J	R 504	(A,115 ,40 )	RS1/16S222J		E
R 376	(A,103 ,181 )	RS1/16S101J	R 505	(B,127 ,36 )	RS1/16S362J		
R 377	(A,104 ,181 )	RS1/16S470J	R 506	(B,111 ,36 )	RS1/16S362J		
R 382	(A,121 ,166 )	RS1/16S0R0J	R 507	(B,125 ,36 )	RS1/16S101J		
R 386	(A,125 ,166 )	RS1/16S0R0J	R 508	(B,113 ,36 )	RS1/16S101J		
R 390	(A,124 ,185 )	RS1/16S0R0J	R 509	(A,127 ,34 )	RS1/16S362J		
R 416	(B,70 ,117 )	RS1/16S0R0J	R 510	(A,111 ,34 )	RS1/16S362J		
R 418	(B,74 ,117 )	RS1/16S0R0J	R 511	(A,127 ,36 )	RS1/16S101J		
R 426	(B,68 ,192 )	RS1/16S101J	R 512	(A,111 ,36 )	RS1/16S101J		
R 427	(B,66 ,192 )	RS1/16S101J	R 513	(A,127 ,37 )	RS1/16S122J		
R 428	(A,70 ,196 )	RS1/16S220J	R 514	(A,111 ,37 )	RS1/16S122J		
R 429	(A,66 ,196 )	RS1/16S470J	R 515	(A,125 ,38 )	RS1/16S122J		F
R 430	(A,69 ,206 )	RS1/16S473J	R 516	(A,114 ,38 )	RS1/16S122J		
R 431	(A,137 ,161 ) RESISTOR ARRAY	RAB4C104J	R 517	(B,121 ,31 )	RS1/16S474J		
R 432	(A,137 ,157 ) RESISTOR ARRAY	RAB4C104J	R 518	(B,117 ,31 )	RS1/16S474J		

	<u>Mark No.</u>	<u>Description</u>	<u>Part No.</u>	<u>Mark No.</u>	<u>Description</u>	<u>Part No.</u>
A	R 519	(B,123 ,26)	RS1/16S221J	R 717	(B,79 ,31 )	RS1/16S474J
	R 520	(B,115 ,26)	RS1/16S221J	R 718	(B,75 ,31 )	RS1/16S474J
	R 551	(A,112 ,54)	RS1/16S101J	R 719	(B,81 ,26)	RS1/16S221J
	R 552	(A,112 ,58)	RS1/16S101J	R 720	(B,73 ,26)	RS1/16S221J
	R 553	(A,112 ,56)	RS1/16S101J	R 751	(A,70 ,54)	RS1/16S101J
	R 554	(A,112 ,59)	RS1/16S0R0J	R 752	(A,70 ,58)	RS1/16S101J
	R 558	(A,127 ,59)	RS1/16S221J	R 753	(A,70 ,56)	RS1/16S101J
	R 559	(A,127 ,58)	RS1/16S221J	R 754	(A,70 ,59)	RS1/16S0R0J
	R 560	(A,127 ,56)	RS1/16S221J	R 758	(A,85 ,59)	RS1/16S221J
	R 561	(A,112 ,53)	RS1/16S221J	R 759	(A,85 ,58)	RS1/16S221J
B	R 562	(B,120 ,55)	RS1/16S0R0J	R 760	(A,85 ,56)	RS1/16S221J
	R 563	(B,122 ,55)	RS1/16S0R0J	R 761	(A,70 ,53)	RS1/16S221J
	R 564	(B,116 ,55)	RS1/16S0R0J	R 762	(B,78 ,55)	RS1/16S0R0J
	R 601	(A,106 ,40)	RS1/16S222J	R 763	(B,80 ,55)	RS1/16S0R0J
	R 602	(A,90 ,40)	RS1/16S222J	R 764	(B,74 ,55)	RS1/16S0R0J
	R 603	(A,103 ,40)	RS1/16S222J	R 801	(A,64 ,40)	RS1/16S222J
	R 604	(A,94 ,40)	RS1/16S222J	R 802	(A,48 ,40)	RS1/16S222J
	R 605	(B,106 ,36)	RS1/16S302J	R 803	(A,61 ,40)	RS1/16S222J
	R 606	(B,90 ,36)	RS1/16S682J	R 804	(A,52 ,40)	RS1/16S222J
	R 607	(B,104 ,36)	RS1/16S101J	R 805	(B,64 ,36)	RS1/16S302J
C	R 608	(B,92 ,36)	RS1/16S101J	R 806	(B,48 ,36)	RS1/16S302J
	R 609	(A,106 ,34)	RS1/16S302J	R 807	(B,62 ,36)	RS1/16S101J
	R 610	(A,90 ,34)	RS1/16S682J	R 808	(B,50 ,36)	RS1/16S101J
	R 611	(A,106 ,36)	RS1/16S101J	R 809	(A,64 ,34)	RS1/16S302J
	R 612	(A,90 ,36)	RS1/16S101J	R 810	(A,48 ,34)	RS1/16S302J
	R 613	(A,106 ,37)	RS1/16S152J	R 811	(A,64 ,36)	RS1/16S101J
	R 614	(A,90 ,37)	RS1/16S102J	R 812	(A,48 ,36)	RS1/16S101J
	R 615	(A,104 ,38)	RS1/16S152J	R 813	(A,64 ,37)	RS1/16S152J
	R 616	(A,93 ,38)	RS1/16S102J	R 814	(A,48 ,37)	RS1/16S152J
	R 617	(B,100 ,31)	RS1/16S474J	R 815	(A,62 ,38)	RS1/16S152J
D	R 618	(B,96 ,31)	RS1/16S474J	R 816	(A,51 ,38)	RS1/16S152J
	R 619	(B,102 ,26)	RS1/16S221J	R 817	(B,58 ,31)	RS1/16S474J
	R 620	(B,94 ,26)	RS1/16S221J	R 818	(B,54 ,31)	RS1/16S474J
	R 651	(A,91 ,54)	RS1/16S101J	R 819	(B,60 ,26)	RS1/16S221J
	R 652	(A,91 ,58)	RS1/16S101J	R 820	(B,52 ,26)	RS1/16S221J
	R 653	(A,91 ,56)	RS1/16S101J	R 851	(A,49 ,54)	RS1/16S101J
	R 654	(A,91 ,59)	RS1/16S0R0J	R 852	(A,49 ,58)	RS1/16S101J
	R 658	(A,106 ,59)	RS1/16S221J	R 853	(A,49 ,56)	RS1/16S101J
	R 659	(A,106 ,58)	RS1/16S221J	R 854	(A,49 ,59)	RS1/16S0R0J
	R 660	(A,106 ,56)	RS1/16S221J	R 858	(A,64 ,59)	RS1/16S221J
E	R 661	(A,91 ,53)	RS1/16S221J	R 859	(A,64 ,58)	RS1/16S221J
	R 662	(B,99 ,55)	RS1/16S0R0J	R 860	(A,64 ,56)	RS1/16S221J
	R 663	(B,101 ,55)	RS1/16S0R0J	R 861	(A,49 ,53)	RS1/16S221J
	R 664	(B,95 ,55)	RS1/16S0R0J	R 864	(B,53 ,55)	RS1/16S0R0J
	R 701	(A,85 ,40)	RS1/16S222J	R 950	(A,43 ,55)	RS1/16S0R0J
	R 702	(A,69 ,40)	RS1/16S222J	R 972	(A,50 ,73)	RS1/16S0R0J
	R 703	(A,82 ,40)	RS1/16S222J	R 973	(A,52 ,73)	RS1/16S470J
	R 704	(A,73 ,40)	RS1/16S222J	R 975	(A,53 ,73)	RS1/16S101J
	R 705	(B,85 ,36)	RS1/16S302J	R 976	(A,55 ,73)	RS1/16S101J
	R 706	(B,69 ,36)	RS1/16S302J	R 977	(A,56 ,73)	RS1/16S470J
	R 707	(B,83 ,36)	RS1/16S101J	R 980	(A,54 ,85)	RS1/16S0R0J
	R 708	(B,71 ,36)	RS1/16S101J	R 981	(A,56 ,85)	RS1/16S470J
	R 709	(A,85 ,34)	RS1/16S302J	R 984	(A,61 ,73)	RS1/16S0R0J
	R 710	(A,69 ,34)	RS1/16S302J	R 985	(A,62 ,73)	RS1/16S470J
	R 711	(A,85 ,36)	RS1/16S101J	R 988	(A,65 ,73)	RS1/16S0R0J
F	R 712	(A,69 ,36)	RS1/16S101J	R 989	(A,67 ,73)	RS1/16S470J
	R 713	(A,85 ,37)	RS1/16S152J	R 990		RS1/16S0R0J
	R 714	(A,69 ,37)	RS1/16S152J	R 992	(A,65 ,85)	RS1/16S0R0J
	R 715	(A,83 ,38)	RS1/16S152J	R 993	(A,67 ,85)	RS1/16S470J
	R 716	(A,72 ,38)	RS1/16S152J	R 994	(A,59 ,85)	RS1/16S0R0J



**Mark No. Description****Part No.****Mark No. Description****Part No.**

C 483 (A,104 ,69)  
C 484 (A,99 ,72)  
C 485 (A,92 ,69)  
C 486 (A,96 ,72)  
C 487 (A,105 ,84)

CEAT101M10  
CKSRYB104K16  
CEAT101M10  
CKSRYB104K16  
CEAT101M10

C 710 (B,75 ,26)  
C 751 (A,77 ,31)  
C 752 (A,78 ,39)  
C 753 (A,76 ,64)  
C 754 (A,70 ,51)

CKSRYB472K50  
CKSRYB103K50  
CKSRYB103K50  
CEAT101M10  
CKSRYB104K16

C 488 (A,104 ,77)  
C 489 (A,91 ,80)  
C 490 (A,91 ,78)  
C 491 (A,90 ,83)  
C 501 (A,127 ,39)

CKSRYB104K16  
CKSRYB471K50  
CKSRYB104K16  
CEAT101M10  
CKSRYB102K50

C 755 (A,77 ,59)  
C 756 (A,85 ,44)  
C 757 (A,83 ,48)  
C 758 (A,83 ,50)  
C 759 (A,70 ,49)

CKSRYB103K50  
CEAT101M10  
CKSRYB104K16  
CKSRYB104K16  
CKSRYB104K16

C 502 (A,111 ,39)  
C 503 (B,123 ,36)  
C 504 (B,115 ,36)  
C 505 (A,125 ,35)  
C 506 (A,114 ,35)

CKSRYB102K50  
CCSRCH331J50  
CCSRCH331J50  
CCSRCH331J50  
CCSRCH331J50

C 760 (A,69 ,44)  
C 761 (B,69 ,47)  
C 801 (A,64 ,39)  
C 802 (A,48 ,39)  
C 803 (B,60 ,36)

CEAT101M10  
CKSRYB104K16  
CKSRYB102K50  
CKSRYB102K50  
CCSRCH331J50

C 507 (A,127 ,30)  
C 508 (A,111 ,30)  
C 509 (B,121 ,26)  
C 510 (B,117 ,26)  
C 551 (A,119 ,31)

CEAT100M50  
CEAT100M50  
CKSRYB472K50  
CKSRYB472K50  
CKSRYB103K50

C 804 (B,52 ,36)  
C 805 (A,62 ,35)  
C 806 (A,51 ,35)  
C 807 (A,64 ,30)  
C 808 (A,48 ,30)

CCSRCH331J50  
CCSRCH331J50  
CCSRCH331J50  
CEAT100M50  
CEAT100M50

C 552 (A,120 ,39)  
C 553 (A,118 ,64)  
C 554 (A,112 ,51)  
C 555 (A,119 ,59)  
C 556 (A,127 ,44)

CKSRYB103K50  
CEAT101M10  
CKSRYB104K16  
CKSRYB103K50  
CEAT101M10

C 809 (B,58 ,26)  
C 810 (B,54 ,26)  
C 851 (A,56 ,31)  
C 852 (A,57 ,39)  
C 853 (A,55 ,64)

CKSRYB472K50  
CKSRYB472K50  
CKSRYB103K50  
CKSRYB103K50  
CEAT101M10

C 557 (A,125 ,48)  
C 558 (A,125 ,50)  
C 559 (A,112 ,49)  
C 560 (A,111 ,44)  
C 561 (B,111 ,47)

CKSRYB104K16  
CKSRYB104K16  
CKSRYB104K16  
CEAT101M10  
CKSRYB104K16

C 854 (A,49 ,51)  
C 855 (A,56 ,59)  
C 856 (A,64 ,44)  
C 857 (A,62 ,48)  
C 858 (A,62 ,50)

CKSRYB104K16  
CKSRYB103K50  
CEAT101M10  
CKSRYB104K16  
CKSRYB104K16

C 601 (A,106 ,39)  
C 602 (A,90 ,39)  
C 603 (B,102 ,36)  
C 604 (B,94 ,36)  
C 605 (A,104 ,35)

CKSRYB102K50  
CKSRYB102K50  
CCSRCH331J50  
CCSRCH221J50  
CCSRCH331J50

C 859 (A,49 ,49)  
C 860 (A,48 ,44)  
C 861 (B,48 ,47)  
C 979 (B,31 ,70)  
C 980 (B,95 ,77)

CKSRYB104K16  
CEAT101M10  
CKSRYB104K16  
CKSRYB472K50  
CKSRYB472K50

C 606 (A,93 ,35)  
C 607 (A,106 ,30)  
C 608 (A,90 ,30)  
C 609 (B,100 ,26)  
C 610 (B,96 ,26)

CCSRCH221J50  
CEAT100M50  
CEAT100M50  
CKSRYB472K50  
CKSRYB472K50

C 981 (B,67 ,15)  
C 982 (B,65 ,15)  
C 985 (B,93 ,77)  
C 986 (B,91 ,77)  
C 987 (B,34 ,70)

CKSRYB104K16  
CKSRYB471K50  
CKSRYB104K16  
CKSRYB471K50  
CKSRYB104K16

C 651 (A,98 ,31)  
C 652 (A,99 ,39)  
C 653 (A,97 ,64)  
C 654 (A,91 ,51)  
C 655 (A,98 ,59)

CKSRYB103K50  
CKSRYB103K50  
CEAT101M10  
CKSRYB104K16  
CKSRYB103K50

C 988 (B,32 ,70)  
C 991 (A,140 ,57)  
C 992 (A,134 ,64)  
C 993 (B,137 ,68)  
C 994 (B,137 ,72)

CKSRYB471K50  
CKSRYB104K16  
CEAT101M10  
CKSRYB473K25  
CKSRYB473K25

C 656 (A,106 ,44)  
C 657 (A,104 ,48)  
C 658 (A,104 ,50)  
C 659 (A,91 ,49)  
C 660 (A,90 ,44)

CEAT101M10  
CKSRYB104K16  
CKSRYB104K16  
CKSRYB104K16  
CEAT101M10

## **M** DSP ASSY **MISCELLANEOUS**

IC 101 (A,35 ,60) DSP IC  
IC 102 (B,32 ,38) LOGIC IC (LATCHES)  
IC 103 (B,45 ,38) LOGIC IC (LATCHES)  
IC 104 (A,42 ,22) 2 TO 4 LINE DECODER  
IC 105 (B,42 ,17) FLASH ROM  
IC1 FLASH MEMORY IC

ADSP-21266SKSTZ-2D  
TC74VHC573FSTS1  
TC74VHC573FSTS1  
TC7W139FU  
AYW7081  
S29AL016D70TFI010

C 661 (B,90 ,47)  
C 701 (A,85 ,39)  
C 702 (A,69 ,39)  
C 703 (B,81 ,36)  
C 704 (B,73 ,36)

CKSRYB104K16  
CKSRYB102K50  
CKSRYB102K50  
CCSRCH331J50  
CCSRCH331J50

IC 106 (A,25 ,17) SRAM(4M)  
IC 107 (B,16 ,60) LOGIC IC  
IC 109 (A,40 ,15) LOGIC IC  
IC 201 (B,62 ,57) DSP IC  
IC 301 (A,70 ,41) LOGIC IC

CY7C1049C3312VXC  
SN74AHC08PW  
SN74AHC1G32DCK  
DSPC56371AF180  
TC7WHU04FU

C 705 (A,83 ,35)  
C 706 (A,72 ,35)  
C 707 (A,85 ,30)  
C 708 (A,69 ,30)  
C 709 (B,79 ,26)

CCSRCH331J50  
CCSRCH331J50  
CEAT100M50  
CEAT100M50  
CKSRYB472K50





1

2

3

4

**Mark No. Description****Part No.****Mark No. Description****Part No.**

C 118 (A,51 ,59)  
C 119 (A,49 ,65)  
C 120 (A,51 ,65)

CKSRYB104K16  
CCSRCH471J50  
CKSRYB104K16

C 181 (A,18 ,18)  
C 182 (A,17 ,18)  
C 183 (A,32 ,17)

CCSRCH471J50  
CKSRYB104K16  
CCSRCH471J50

A

C 121 (A,49 ,68)  
C 122 (A,51 ,68)  
C 123 (A,49 ,70)  
C 124 (A,51 ,70)  
C 125 (A,44 ,76)

CCSRCH471J50  
CKSRYB104K16  
CCSRCH471J50  
CKSRYB104K16  
CCSRCH471J50

C 184 (A,34 ,17)  
C 185 (B,12 ,59)  
C 186 (B,11 ,59)  
C 189 (A,38 ,15)  
C 190 (A,36 ,15)

CKSRYB104K16  
CCSRCH471J50  
CKSRYB104K16  
CCSRCH471J50  
CKSRYB104K16

C 126 (A,44 ,77)  
C 127 (A,41 ,76)  
C 128 (A,41 ,77)  
C 129 (A,38 ,76)  
C 130 (A,38 ,77)

CKSRYB104K16  
CCSRCH471J50  
CKSRYB104K16  
CCSRCH471J50  
CKSRYB104K16

C 201 (B,72 ,57)  
C 202 (B,74 ,57)  
C 203 (B,63 ,47)  
C 204 (B,63 ,46)  
C 205 (B,52 ,52)

CCSRCH471J50  
CKSRYB104K16  
CCSRCH471J50  
CKSRYB104K16  
CCSRCH471J50

B

C 131 (A,32 ,76)  
C 132 (A,32 ,77)  
C 133 (A,29 ,76)  
C 134 (A,29 ,77)  
C 135 (A,26 ,76)

CCSRCH471J50  
CKSRYB104K16  
CCSRCH471J50  
CKSRYB104K16  
CCSRCH471J50

C 206 (B,51 ,52)  
C 207 (B,51 ,58)  
C 208 (B,50 ,58)  
C 209 (B,62 ,68)  
C 210 (B,62 ,69)

CKSRYB104K16  
CCSRCH471J50  
CKSRYB104K16  
CCSRCH471J50  
CKSRYB104K16

C 136 (A,26 ,77)  
C 137 (A,20 ,71)  
C 138 (A,19 ,71)  
C 139 (A,20 ,69)  
C 140 (A,19 ,69)

CKSRYB104K16  
CCSRCH471J50  
CKSRYB104K16  
CCSRCH471J50  
CKSRYB104K16

C 211 (B,72 ,62)  
C 212 (B,74 ,62)  
C 213 (B,72 ,52)  
C 214 (B,74 ,52)  
C 215 (B,67 ,47)

CCSRCH471J50  
CKSRYB104K16  
CCSRCH471J50  
CKSRYB104K16  
CCSRCH471J50

C

C 141 (A,20 ,63)  
C 142 (A,19 ,63)  
C 143 (A,20 ,60)  
C 144 (A,19 ,60)  
C 145 (A,20 ,57)

CCSRCH471J50  
CKSRYB104K16  
CCSRCH471J50  
CKSRYB104K16  
CCSRCH471J50

C 216 (B,67 ,46)  
C 217 (B,52 ,50)  
C 218 (B,51 ,50)  
C 219 (B,59 ,68)  
C 220 (B,59 ,69)

CKSRYB104K16  
CCSRCH471J50  
CKSRYB104K16  
CCSRCH471J50  
CKSRYB104K16

C 146 (A,19 ,57)  
C 147 (A,27 ,46)  
C 148 (A,27 ,44)  
C 149 (A,35 ,42)  
C 150 (A,35 ,41)

CKSRYB104K16  
CCSRCH471J50  
CKSRYB104K16  
CCSRCH471J50  
CKSRYB104K16

C 221 (B,65 ,68)  
C 222 (B,65 ,69)  
C 223 (B,56 ,47)  
C 224 (B,56 ,46)  
C 228 (B,50 ,56)

CCSRCH471J50  
CKSRYB104K16  
CCSRCH471J50  
CKSRYB104K16  
CKSRYB103K50

D

C 151 (A,43 ,46)  
C 152 (A,43 ,44)  
C 153 (A,49 ,54)  
C 154 (A,51 ,54)  
C 155 (A,49 ,62)

CCSRCH471J50  
CKSRYB104K16  
CCSRCH471J50  
CKSRYB104K16  
CCSRCH471J50

C 302 (A,73 ,41)  
C 303 (A,74 ,41)  
C 304 (A,69 ,36)  
C 305 (A,73 ,36)  
C 351 (A,115 ,46)

CCSRCH471J50  
CKSRYB104K16  
CCSRCH100D50  
CCSRCH100D50  
CEWW101M16

C 156 (A,51 ,62)  
C 157 (A,47 ,76)  
C 158 (A,47 ,77)  
C 159 (A,35 ,76)  
C 160 (A,35 ,77)

CKSRYB104K16  
CCSRCH471J50  
CKSRYB104K16  
CCSRCH471J50  
CKSRYB104K16

C 353 (B,6 ,32)  
C 354 (B,14 ,43)  
C 357 (A,29 ,88) CHIP OS CAPACITOR  
C 360 (A,56 ,16)  
C 361 (A,53 ,21)

CKSRYB104K16  
CEWW101M16  
ACH7256  
CKSRYB104K16  
CEWW101M16

E

C 161 (A,20 ,66)  
C 162 (A,19 ,66)  
C 163 (A,19 ,54)  
C 164 (A,18 ,54)  
C 165 (A,20 ,51)

CCSRCH471J50  
CKSRYB104K16  
CCSRCH471J50  
CKSRYB104K16  
CCSRCH471J50

C 364 (A,65 ,21) CHIP ELECT.CAPACITOR

CEWW101M4

C 166 (A,19 ,51)  
C 167 (A,22 ,54)  
C 168 (A,21 ,54)  
C 169 (B,30 ,63)  
C 171 (B,27 ,37)

CKSRYB104K16  
CCSRCH471J50  
CKSRYB104K16  
CKSRYB103K50  
CCSRCH471J50

## **N** INTERFACE ASSY **MISCELLANEOUS**

△ IC 4301(A,239 ,227) PROTECTOR(1.6A)  
Q 4301(B,229 ,221) CHIP TRANSISTOR  
Q 4303(B,215 ,223) TRANSISTOR  
D 4302(A,14 ,206) DIODE  
L 4311(B,56 ,163) CHIP BEADS

AEK7066  
RSR015P03  
RT1N241C  
MTZJ6R2(B)  
VTL1083

F

C 172 (B,26 ,37)  
C 173 (B,40 ,36)  
C 174 (B,39 ,36)  
C 175 (A,42 ,20)  
C 176 (A,42 ,18)

CKSRYB104K16  
CCSRCH471J50  
CKSRYB104K16  
CCSRCH471J50  
CKSRYB104K16

L 4312(B,134 ,222) CHIP BEADS  
L 4313(B,132 ,222) CHIP BEADS  
L 4314(B,130 ,222) CHIP BEADS  
L 4315(B,128 ,222) CHIP BEADS  
L 4316(B,126 ,222) CHIP BEADS

VTL1083  
VTL1083  
VTL1083  
VTL1083  
VTL1083

C 178 (B,41 ,30)  
C 179 (B,41 ,31)

CCSRCH471J50  
CKSRYB104K16

L 4317(B,124 ,222) CHIP BEADS

VTL1083

1

2

3

4

5	6	
Mark No.	Description	Part No.
L 4318(B,122 ,222 )	CHIP BEADS	VTL1083
L 4320(B,79 ,233 )	CHIP BEADS	VTL1083
L 4321(B,79 ,228 )	CHIP BEADS	VTL1083
L 4322(B,79 ,231 )	CHIP BEADS	VTL1083
L 4323(B,279 ,236 )	CHIP BEADS	VTL1083
L 4324(B,321 ,226 )	CHIP BEADS	VTL1083
J 4	4PJUMPER WIRE	D20PDD0420E
J 4308(A,260 ,197 )	CONNECTOR ASS'Y	PF11PG-R05
J 4309(A,232 ,197 )	CONNECTOR ASS'Y	PF08PG-R05
KN4301(A,151 ,218 )	WRAPPING TERMINAL	VNF1084
CN4301(A,285 ,231 )	CONNECTOR	52045-1545
CN4302(A,194 ,232 )	11P PLUG	XKP3065
CN4303(A,188 ,232 )	B TO B CONNCTOR	BTEM20S-1S
CN4304(A,158 ,232 )	B TO B CONNCTOR	BTEM20S-1S
CN4305(A,311 ,219 )	B TO B CONNCTOR	BTEM16S-1S
CN4305(A,86 ,35 )	B TO B CONNCTOR	BTEM16S-1S
CN4305(A,315 ,113 )	B TO B CONNCTOR	BTEM16S-1S
CN4305(A,242 ,24 )	B TO B CONNCTOR	BTEM16S-1S
CN4305(A,109 ,52 )	B TO B CONNCTOR	BTEM16S-1S
CN4305(A,129 ,232 )	B TO B CONNCTOR	BTEM16S-1S
CN4305(A,323 ,171 )	B TO B CONNCTOR	BTEM16S-1S
CN4306(A,46 ,232 )	23P PLUG	XKP3071
CN4307(A,22 ,230 )	4P PLUG	KM200TA4
CN431024P	SOCKET	AKP7203
CN4311(A,42 ,207 )	24P SOCKET	AKP7203
CN4312(A,192 ,184 )	11P PLUG	XKP3065
CN4313(A,110 ,183 )	B TO B CONNCTOR	BTEM20S-1S
CN4314(A,51 ,184 )	13P PLUG	XKP3066
CN4315(A,15 ,185 )	7P PLUG	KM200TA7
CN4316(A,33 ,152 )	17P PLUG	XKP3068
CN4317(A,30 ,128 )	15P PLUG	XKP3067
CN4318(A,18 ,106 )	6P PLUG	KM200TA6
CN4319(A,25 ,73 )	13P PLUG	XKP3066
CN4320(A,37 ,43 )	23P PLUG	XKP3071
CN4324(A,72 ,185 )	7P PLUG	KM200TA7
CN4325(A,157 ,183 )	B TO B CONNCTOR	BTEM14S-1S
Y 18 (A,9 ,202 )	3P HOUSING WIRE ASSY	ADX7494
4305(A,224 ,200 )	PCB BINDER	VEF1040
4304(A,203 ,184 )	PCB BINDER	VEF1040
4304(A,5 ,5 )	PCB BINDER	VEF1040
4304(A,62 ,79 )	PCB BINDER	VEF1040
4304(A,64 ,27 )	PCB BINDER	VEF1040
4304(A,144 ,4 )	PCB BINDER	VEF1040
4304(A,243 ,4 )	PCB BINDER	VEF1040
4304(A,109 ,6 )	PCB BINDER	VEF1040
4304(A,137 ,78 )	PCB BINDER	VEF1040
4304(A,156 ,116 )	PCB BINDER	VEF1040
4304(A,51 ,127 )	PCB BINDER	VEF1040
4304(A,51 ,65 )	PCB BINDER	VEF1040
4304(A,62 ,152 )	PCB BINDER	VEF1040
4304(A,169 ,216 )	PCB BINDER	VEF1040
4304(A,319 ,235 )	PCB BINDER	VEF1040
4304(A,41 ,37 )	PCB BINDER	VEF1040
4304(A,16 ,37 )	PCB BINDER	VEF1040
4304(A,216 ,165 )	PCB BINDER	VEF1040
4304(A,6 ,237 )	PCB BINDER	VEF1040
4304(A,301 ,189 )	PCB BINDER	VEF1040
4303(A,107 ,175 )	PCB BINDER	VEF1040
4302(A,31 ,197 )	4P CABLE HOLDER	51048-0400
4301(A,198 ,198 )	4P CABLE HOLDER	51048-0400
Y 17	AWG14 BOARD IN	ADX7493

7	8	
Mark No.	Description	Part No.
<b>RESISTORS</b>		
R 4302(B,235 ,225 )		RS1/16S103J
R 4303(B,224 ,224 )		RS1/16S101J
R 4305(B,246 ,219 )		RS1/16S103J
R 4319(B,120 ,222 )		RS1/16S102J
R 4327(B,150 ,208 )		RS1/16S0R0J
R 4328(B,150 ,206 )		RS1/16S0R0J
<b>CAPACITORS</b>		
C 4301(A,300 ,185 )		CEAT470M25
C 4302(A,300 ,191 )		CEAT470M25
C 4303(A,136 ,199 )	ELECTR. CAPACITOR	CEAL470M25
C 4304(A,146 ,201 )	ELECTR. CAPACITOR	CEAL470M25
C 4305(B,241 ,219 )		CKSRYB104K25
C 4307(B,146 ,214 )		CKSRYB103K50
C 4308(B,146 ,216 )		CKSRYB471K50
C 4313(B,267 ,186 )		CKSRYB102K50
C 4314(B,252 ,189 )		CKSRYB102K50
<b>POWER AMP IN ASSY</b>		
<b>MISCELLANEOUS</b>		
Q 5601(B,61 ,180 )	CHIP TRANSISTOR	2SD2704K
Q 5602(B,41 ,219 )	TRANSISTOR	IMT4
Q 5603(B,45 ,207 )	CHIP TRANSISTOR	2SA1514K
Q 5604(A,28 ,206 )	TRANSISTOR	2SA1145
Q 5605(A,30 ,225 )	TRANSISTOR	2SC2705
Q 5641(B,15 ,213 )	CHIP TR	2SA1255
D 5601(B,38 ,205 )	CHIP ZENER DIODE	UDZS3R6(B)
D 5602(B,38 ,207 )	DIODE	1SS355
D 5603(B,26 ,222 )	DIODE	1SS355
D 5604(B,28 ,212 )	DIODE	1SS355
D 5605(B,28 ,218 )	DIODE	UDZS4R7(B)
D 5606(B,26 ,212 )	DIODE	UDZS4R7(B)
D 5641(B,11 ,229 )	DIODE	1SS355
D 5642(B,13 ,229 )	DIODE	1SS355
D 5643(B,9 ,229 )	DIODE	1SS355
D 5644(B,45 ,238 )	DIODE	1SS355
CN5601(A,71 ,233 )	13P PLUG	XKP3066
CN5602(A,56 ,199 )	13P PLUG	XKP3066
CN5603(A,74 ,131 )	19P CONNECTOR	52044-1945
CN5605(A,47 ,233 )	SOCKET 7-P	KP250NA7
CN5606(A,32 ,199 )	SOCKET 7-P	KP250NA7
5604(A,7 ,215 )	5P CABLE HOLDER	51048-0500
<b>RESISTORS</b>		
R 5601(B,58 ,178 )		RS1/16S102J
R 5602(B,48 ,212 )		RS1/16S221J
R 5603(B,48 ,216 )		RS1/16S333J
R 5604(B,58 ,182 )		RS1/16S103J
R 5605(B,41 ,213 )		RS1/16S152J
R 5606(B,38 ,217 )		RS1/16S821J
R 5607(B,44 ,203 )		RS1/16S2001F
R 5608(B,43 ,212 )		RS1/16S682J
R 5609(A,36 ,214 )	CARBON FILM RESISTOR	RD1/2VM473J
R 5610(B,32 ,202 )		RS1/16S151J
R 5611(B,29 ,203 )		RN1/16SE1201D
R 5612(B,31 ,230 )		RS1/16S221J
⚠ 5623(A,69 ,206 )	CARBON FILM RESISTOR	RD1/4MUF4R7J
⚠ 5624(A,56 ,217 )	CARBON FILM RESISTOR	RD1/4MUF4R7J
⚠ 5627(A,20 ,225 )	RESISTOR (0.18, 5W)	ACN7121

**Mark No. Description****Part No.****Mark No. Description****Part No.**

R 5629(B,43 ,224 )  
R 5630(B,45 ,220 )  
A R 5631(B,47 ,220 )  
R 5632(B,29 ,229 )  
R 5641(B,7 ,229 )

RN1/10SE3302D  
RN1/16SE1001D  
RN1/16SE1500D  
RS1/16S151J  
RS1/16S473J

R 5721(B,24 ,166 )  
R 5746(B,17 ,88 )  
R 5747(B,18 ,107 )  
R 5750(B,26 ,161 )

RS1/16S683J  
RS1/16S0R0J  
RS1/16S0R0J  
RS1/16S0R0J

R 5642(B,13 ,195 )  
R 5643(B,15 ,230 )  
R 5644(B,15 ,195 )  
R 5645(B,11 ,235 )  
R 5646(B,13 ,235 )

RS1/16S223J  
RS1/16S471J  
RS1/16S471J  
RS1/16S472J  
RS1/16S472J

**CAPACITORS**

C 5701(B,25 ,88 )  
C 5702(B,22 ,88 )  
C 5703(B,24 ,158 )  
C 5704(B,12 ,151 )  
C 5705(B,11 ,166 )

CKSRYB104K50  
CKSRYB104K50  
CKSRYB104K50  
CKSRYB104K50  
CKSRYB223K50

R 5647(B,15 ,208 )  
R 5648(B,48 ,238 )  
R 5649(B,50 ,235 )  
B R 5650(B,52 ,235 )

RS1/16S122J  
RS1/16S154J  
RS1/16S103J  
RS1/16S103J

C 5706(B,14 ,44 )

CKSRYB103K50

**CAPACITORS**

C 5601(A,51 ,212 )  
C 5602(B,46 ,216 )  
C 5604(B,39 ,213 )  
C 5607(A,41 ,203 )  
C 5608(B,35 ,228 ) CAPACITOR(CERAMIC)

CEAT4R7M50  
CCSRCH221J50  
CKSRYB102K50  
CEAT101M10  
ACG7057

C 5609(A,31 ,210 ) ELECT. CAPACITOR  
C 5615(B,47 ,225 )  
C 5616(B,45 ,225 )  
C 5617(A,50 ,221 )  
C 5623(A,67 ,209 )

CEAT100M2A  
CCSRCH220J50  
CCSRCH220J50  
CEAT331M10  
CEAT100M63

C 5624(A,63 ,225 )  
C 5632(B,28 ,233 )  
C 5641(A,13 ,199 )

CEAT100M63  
CKSRYB224K16  
CEANP2R2M50

**Q POWER AMP-L ASSY  
MISCELLANEOUS**

△ IC 5001(A,169 ,134 ) DARLINGTON POWER IC SAP17N(OY)  
△ IC 5002(A,209 ,134 ) DARLINGTON POWER IC SAP17P(OY)  
△ IC 5101(A,105 ,134 ) DARLINGTON POWER IC SAP17N(OY)  
△ IC 5102(A,137 ,134 ) DARLINGTON POWER IC SAP17P(OY)  
△ IC 5201(A,249 ,134 ) DARLINGTON POWER IC SAP17N(OY)

△ IC 5202(A,281 ,134 ) DARLINGTON POWER IC SAP17P(OY)  
△ IC 5601(A,313 ,134 ) DARLINGTON POWER IC SAP17N(OY)  
Q 5001(B,193 ,207 ) CHIP TRANSISTOR 2SD2704K  
Q 5002(B,181 ,194 ) TRANSISTOR IMT4

Q 5004(A,192 ,184 ) TRANSISTOR 2SA1145  
Q 5005(A,168 ,192 ) TRANSISTOR 2SC2705  
Q 5041(B,156 ,195 ) CHIP TR 2SA1255  
Q 5101(B,136 ,207 ) CHIP TRANSISTOR 2SD2704K  
Q 5102(B,124 ,194 ) TRANSISTOR IMT4

Q 5103(B,137 ,198 ) CHIP TRANSISTOR 2SA1514K  
Q 5104(A,135 ,184 ) TRANSISTOR 2SA1145  
Q 5105(A,112 ,192 ) TRANSISTOR 2SC2705  
Q 5141(B,100 ,202 ) CHIP TR 2SA1255  
Q 5201(B,274 ,206 ) CHIP TRANSISTOR 2SD2704K

Q 5202(B,262 ,193 ) TRANSISTOR IMT4  
Q 5203(B,275 ,197 ) CHIP TRANSISTOR 2SA1514K  
Q 5204(A,273 ,183 ) TRANSISTOR 2SA1145  
Q 5205(A,250 ,191 ) TRANSISTOR 2SC2705  
Q 5241(B,238 ,197 ) CHIP TR 2SA1255

D 5001(B,197 ,188 ) CHIP ZENER DIODE UDZS3R6(B)  
D 5002(B,195 ,188 ) DIODE 1SS355  
D 5003(B,187 ,183 ) DIODE 1SS355  
D 5004(B,179 ,183 ) DIODE 1SS355  
D 5005(B,184 ,183 ) DIODE UDZS4R7(B)

D 5006(B,182 ,183 ) DIODE UDZS4R7(B)  
D 5041(B,156 ,174 ) DIODE 1SS355  
D 5042(B,158 ,174 ) DIODE 1SS355  
D 5043(B,158 ,203 ) DIODE 1SS355  
D 5044(B,161 ,170 ) DIODE 1SS355

D 5101(B,141 ,188 ) CHIP ZENER DIODE UDZS3R6(B)  
D 5102(B,139 ,188 ) DIODE 1SS355  
D 5103(B,130 ,183 ) DIODE 1SS355  
D 5104(B,123 ,183 ) DIODE 1SS355  
D 5105(B,128 ,183 ) DIODE UDZS4R7(B)

D 5106(B,125 ,183 ) DIODE UDZS4R7(B)  
D 5141(B,93 ,187 ) DIODE 1SS355  
D 5142(B,96 ,187 ) DIODE 1SS355  
D 5143(B,103 ,205 ) DIODE 1SS355  
D 5144(B,104 ,182 ) DIODE 1SS355

**P POWER PROTECT ASSY  
MISCELLANEOUS**

IC 5701(B,17 ,153 ) OP-AMP IC  
Q 5701(B,10 ,107 ) TRANSISTOR  
Q 5702(B,20 ,107 ) DIGITAL TR(SC-70)  
Q 5704(B,16 ,166 ) TRANSISTOR  
Q 5705(B,13 ,107 ) TRANSISTOR

BA4560RF  
RT1N241M  
RT1P241M  
2SC4081  
RT1N241M

D 5701(B,26 ,166 ) DIODE  
CN5701(A,8 ,97 ) 11P PLUG  
CN5702(A,21 ,131 ) 11P PLUG  
CN5703(A,46 ,178 ) 19P CONNECTOR  
CN5704(A,17 ,181 ) CONNECTOR

1SS355  
XKP3065  
XKP3065  
52044-1945  
S5B-PH

CN5705(A,19 ,39 ) 17P CONNECTOR

52044-1745

**RESISTORS**

E R 5701(B,13 ,118 )  
R 5702(B,16 ,118 )  
R 5703(B,27 ,88 )  
R 5704(B,27 ,81 )  
R 5707(B,20 ,88 )

RS1/16S332J  
RS1/16S332J  
RS1/16S473J  
RS1/16S0R0J  
RS1/16S473J

R 5709(B,22 ,81 )  
R 5710(B,21 ,149 )  
R 5711(B,21 ,153 )  
R 5712(B,12 ,155 )  
R 5713(B,21 ,158 )

RS1/16S0R0J  
RS1/16S223J  
RS1/16S103J  
RS1/16S472J  
RS1/16S103J

R 5714(B,13 ,139 )  
R 5715(B,8 ,166 )  
R 5716(B,13 ,166 )  
R 5717(B,19 ,166 )  
R 5720(B,21 ,166 )

RS1/16S102J  
RS1/16S473J  
RS1/16S472J  
RS1/16S103J  
RS1/16S103J

5	6	7	8
Mark No.	Description	Part No.	Mark No. Description Part No.
			R 5111(B,139,184) RN1/16SE1201D
D 5201(B,279,187)	CHIP ZENER DIODE	UDZS3R6(B)	
D 5202(B,276,187)	DIODE	1SS355	R 5112(B,113,197) RS1/16S221J
D 5203(B,268,181)	DIODE	1SS355	R 5113(B,115,150) CHIP RESISTOR RS1/16S62R0F
D 5204(B,261,181)	DIODE	1SS355	R 5121(B,108,153) RS1/16S101J
D 5205(B,266,181)	DIODE	UDZS4R7(B)	R 5122(B,129,150) RS1/16S101J
			△ R 5123(A,142,166) CARBON FILM RESISTOR RD1/4MUF4R7J
D 5206(B,263,181)	DIODE	UDZS4R7(B)	
D 5241(B,238,173)	DIODE	1SS355	△ R 5124(A,111,176) CARBON FILM RESISTOR RD1/4MUF4R7J
D 5242(B,240,173)	DIODE	1SS355	△ R 5125(B,99,156) CHIP RESISTOR ACN7132
D 5243(B,240,202)	DIODE	1SS355	△ R 5126(B,136,156) CHIP RESISTOR ACN7132
D 5244(B,242,173)	DIODE	1SS355	△ R 5127(A,136,166) RESISTOR (0.18, 5W) ACN7121
			R 5129(B,117,203) RN1/10SE3302D
△ TH5001(A,160,229)	POSISTOR	PTFM04BC222Q2N34B0	
CN5001(A,320,205)	13P SOCKET	XKP3077	R 5130(B,123,203) RN1/16SE1001D
CN5002(A,86,219)	11P SOCKET	XKP3076	R 5131(B,123,205) RN1/16SE1500D
CN5003(A,313,196)	7-P PLUG	KM250NA7L	R 5132(B,110,196) RS1/16S151J
			R 5141(B,97,182) RS1/16S473J
			R 5142(B,99,182) RS1/16S223J
<b>RESISTORS</b>			
R 5001(B,199,202)		RS1/16S102J	
R 5002(B,187,202)		RS1/16S221J	R 5143(B,95,182) RS1/16S471J
R 5003(B,184,203)		RS1/16S333J	R 5144(B,102,182) RS1/16S471J
R 5004(B,199,205)		RS1/16S103J	R 5145(B,100,187) RS1/16S472J
R 5005(B,177,192)		RS1/16S152J	R 5146(B,102,187) RS1/16S472J
			R 5147(B,99,195) RS1/16S122J
R 5006(B,170,200)		RS1/16S821J	
R 5007(B,197,197)		RS1/16S2001F	R 5148(B,100,191) RS1/16S154J
R 5008(B,186,194)		RS1/16S682J	R 5149(B,102,191) RS1/16S103J
R 5009(A,189,193)	CARBON FILM RESISTOR	RD1/2VM473J	R 5150(B,102,195) RS1/16S103J
R 5010(B,197,183)		RS1/16S151J	R 5201(B,281,201) RS1/16S102J
			R 5202(B,268,201) RS1/16S221J
R 5011(B,195,184)		RN1/16SE1201D	
R 5012(B,169,197)		RS1/16S221J	R 5203(B,265,202) RS1/16S333J
R 5013(B,183,150)	CHIP RESISTOR	RS1/16S62R0F	R 5204(B,281,204) RS1/16S103J
R 5021(B,176,153)		RS1/16S101J	R 5205(B,258,191) RS1/16S152J
R 5022(B,190,153)		RS1/16S101J	R 5206(B,252,199) RS1/16S821J
			R 5207(B,279,196) RS1/16S2001F
△ R 5023(A,198,166)	CARBON FILM RESISTOR	RD1/4MUF4R7J	
△ R 5024(A,168,176)	CARBON FILM RESISTOR	RD1/4MUF4R7J	R 5208(B,268,193) RS1/16S682J
△ R 5025(B,163,156)	CHIP RESISTOR	ACN7132	R 5209(A,271,192) CARBON FILM RESISTOR RD1/2VM473J
△ R 5026(B,200,156)	CHIP RESISTOR	ACN7132	R 5210(B,278,183) RS1/16S151J
△ R 5027(A,192,166)	RESISTOR (0.18, 5W)	ACN7121	R 5211(B,276,183) RN1/16SE1201D
			R 5212(B,251,196) RS1/16S221J
R 5029(B,174,203)		RN1/10SE3302D	
R 5030(B,180,203)		RN1/16SE1001D	R 5213(B,259,149) CHIP RESISTOR RS1/16S62R0F
R 5031(B,180,205)		RN1/16SE1500D	R 5221(B,251,153) RS1/16S101J
R 5032(B,167,196)		RS1/16S151J	R 5222(B,269,153) RS1/16S101J
R 5041(B,154,169)		RS1/16S473J	△ R 5223(A,280,164) CARBON FILM RESISTOR RD1/4MUF4R7J
			△ R 5224(A,250,175) CARBON FILM RESISTOR RD1/4MUF4R7J
R 5042(B,156,169)		RS1/16S223J	
R 5043(B,152,169)		RS1/16S471J	△ R 5225(B,238,156) CHIP RESISTOR ACN7132
R 5044(B,158,169)		RS1/16S471J	△ R 5226(B,279,156) CHIP RESISTOR ACN7132
R 5045(B,158,179)		RS1/16S472J	△ R 5227(A,274,165) RESISTOR (0.18, 5W) ACN7121
R 5046(B,161,179)		RS1/16S472J	R 5229(B,255,202) RN1/10SE3302D
			R 5230(B,261,202) RN1/16SE1001D
R 5047(B,157,187)		RS1/16S122J	
R 5048(B,158,183)		RS1/16S154J	R 5231(B,261,204) RN1/16SE1500D
R 5049(B,161,183)		RS1/16S103J	R 5232(B,248,195) RS1/16S151J
R 5050(B,160,187)		RS1/16S103J	R 5241(B,237,169) RS1/16S473J
R 5101(B,143,202)		RS1/16S102J	R 5242(B,239,169) RS1/16S223J
			R 5243(B,235,169) RS1/16S471J
R 5102(B,130,202)		RS1/16S221J	
R 5103(B,127,203)		RS1/16S333J	R 5244(B,241,169) RS1/16S471J
R 5104(B,143,205)		RS1/16S103J	R 5245(B,240,180) RS1/16S472J
R 5105(B,120,192)		RS1/16S152J	R 5246(B,242,180) RS1/16S472J
R 5106(B,114,200)		RS1/16S821J	R 5247(B,240,189) RS1/16S122J
			R 5248(B,237,180) RS1/16S154J
R 5107(B,141,197)		RS1/16S2001F	
R 5108(B,130,194)		RS1/16S682J	R 5249(B,242,184) RS1/16S103J
R 5109(A,133,193)	CARBON FILM RESISTOR	RD1/2VM473J	R 5250(B,240,184) RS1/16S103J
R 5110(B,141,183)		RS1/16S151J	△ R 5292(B,300,156) CHIP RESISTOR ACN7132
			R 5613(B,314,153) CHIP RESISTOR RS1/16S62R0F

**Mark No. Description****Part No.**

R 5621(B,308 ,151 )

RS1/16S101J

**Mark No. Description****Part No.**

△ IC 5502(A,237 ,112 ) DARLINGTON POWER IC SAP17P(OY)

△ IC 5602(A,301 ,112 ) DARLINGTON POWER IC SAP17P(OY)

Q 5301(B,196 ,38 ) CHIP TRANSISTOR 2SD2704K

Q 5302(B,187 ,52 ) TRANSISTOR IMT4

Q 5303(B,173 ,49 ) CHIP TRANSISTOR 2SA1514K

**CAPACITORS**

C 5001(A,190 ,203 )

CEAT4R7M50

C 5002(B,184 ,200 )

CCSRCH221J50

C 5004(B,174 ,197 )

CKSRYB102K50

C 5007(A,202 ,193 )

CEAT101M10

C 5008(B,171 ,197 ) CAPACITOR(CERAMIC)

ACG7057

C 5009(A,186 ,188 ) ELECT. CAPACITOR

CEAT100M2A

C 5011(B,169 ,142 ) CAPACITOR(CERAMIC)

ACG7056

C 5012(B,197 ,142 ) CAPACITOR(CERAMIC)

ACG7056

C 5015(B,175 ,205 )

CCSRCH220J50

C 5016(B,175 ,207 )

CCSRCH220J50

C 5017(A,179 ,207 )

CEAT331M10

C 5023(A,197 ,180 )

CEAT100M63

C 5024(A,173 ,186 )

CEAT100M63

C 5032(B,166 ,199 )

CKSRYB224K16

C 5041(A,155 ,190 )

CEANP2R2M50

C 5051(A,219 ,183 ) ELECT. CAPACITOR

CEAT100M2A

C 5052(A,223 ,177 ) ELECT. CAPACITOR

CEAT100M2A

C 5101(A,133 ,203 )

CEAT4R7M50

C 5102(B,127 ,200 )

CCSRCH221J50

C 5104(B,117 ,197 )

CKSRYB102K50

C 5107(A,145 ,193 )

CEAT101M10

C 5108(B,115 ,197 ) CAPACITOR(CERAMIC)

ACG7057

C 5109(A,129 ,188 ) ELECT. CAPACITOR

CEAT100M2A

C 5111(B,101 ,142 ) CAPACITOR(CERAMIC)

ACG7056

C 5112(B,130 ,142 ) CAPACITOR(CERAMIC)

ACG7056

C 5115(B,119 ,205 )

CCSRCH220J50

C 5116(B,119 ,207 )

CCSRCH220J50

C 5117(A,123 ,207 )

CEAT331M10

C 5123(A,141 ,180 )

CEAT100M63

C 5124(A,116 ,186 )

CEAT100M63

C 5132(B,110 ,199 )

CKSRYB224K16

C 5141(A,96 ,198 )

CEANP2R2M50

C 5201(A,271 ,202 )

CEAT4R7M50

C 5202(B,265 ,199 )

CCSRCH221J50

C 5204(B,255 ,196 )

CKSRYB102K50

C 5207(A,283 ,192 )

CEAT101M10

C 5208(B,253 ,196 ) CAPACITOR(CERAMIC)

ACG7057

C 5209(A,267 ,187 ) ELECT. CAPACITOR

CEAT100M2A

C 5211(B,244 ,142 ) CAPACITOR(CERAMIC)

ACG7056

C 5212(B,275 ,142 ) CAPACITOR(CERAMIC)

ACG7056

C 5215(B,257 ,204 )

CCSRCH220J50

C 5216(B,257 ,206 )

CCSRCH220J50

C 5217(A,261 ,206 )

CEAT331M10

C 5223(A,287 ,181 )

CEAT100M63

C 5224(A,255 ,185 )

CEAT100M63

C 5232(B,248 ,198 )

CKSRYB224K16

C 5241(A,237 ,192 )

CEANP2R2M50

C 5611(B,307 ,142 ) CAPACITOR(CERAMIC)

ACG7056

Q 5304(A,176 ,63 ) TRANSISTOR

2SA1145

Q 5305(A,199 ,49 ) TRANSISTOR

2SC2705

Q 5341(B,152 ,48 ) CHIP TR

2SA1255

Q 5401(B,132 ,38 ) CHIP TRANSISTOR

2SD2704K

Q 5402(B,126 ,52 ) TRANSISTOR

IMT4

Q 5403(B,113 ,48 ) CHIP TRANSISTOR

2SA1514K

Q 5404(A,119 ,64 ) TRANSISTOR

2SA1145

Q 5405(A,139 ,49 ) TRANSISTOR

2SC2705

Q 5441(B,94 ,46 ) CHIP TR

2SA1255

Q 5501(B,285 ,38 ) CHIP TRANSISTOR

2SD2704K

Q 5502(B,276 ,52 ) TRANSISTOR

IMT4

Q 5503(B,262 ,49 ) CHIP TRANSISTOR

2SA1514K

Q 5504(A,260 ,63 ) TRANSISTOR

2SA1145

Q 5505(A,288 ,49 ) TRANSISTOR

2SC2705

Q 5541(B,239 ,49 ) CHIP TR

2SA1255

Q 5571(B,225 ,38 ) TRANSISTOR

2SC4081

Q 5572(B,222 ,38 ) TRANSISTOR

2SC4081

D 5301(B,171 ,57 ) CHIP ZENER DIODE

UDZS3R6(B)

D 5302(B,173 ,59 ) DIODE

1SS355

D 5303(B,181 ,64 ) DIODE

1SS355

D 5304(B,187 ,64 ) DIODE

1SS355

D 5305(B,183 ,64 ) DIODE

UDZS4R7(B)

D 5306(B,185 ,64 ) DIODE

UDZS4R7(B)

D 5341(B,153 ,67 ) DIODE

1SS355

D 5342(B,151 ,67 ) DIODE

1SS355

D 5343(B,151 ,44 ) DIODE

1SS355

D 5344(B,155 ,70 ) DIODE

1SS355

D 5401(B,114 ,59 ) CHIP ZENER DIODE

UDZS3R6(B)

D 5402(B,116 ,60 ) DIODE

1SS355

D 5403(B,124 ,64 ) DIODE

1SS355

D 5404(B,130 ,64 ) DIODE

1SS355

D 5405(B,126 ,64 ) DIODE

UDZS4R7(B)

D 5406(B,128 ,64 ) DIODE

UDZS4R7(B)

D 5441(B,93 ,58 ) DIODE

1SS355

D 5442(B,90 ,58 ) DIODE

1SS355

D 5443(B,94 ,40 ) DIODE

1SS355

D 5444(B,111 ,79 ) DIODE

1SS355

D 5501(B,255 ,57 ) CHIP ZENER DIODE

UDZS3R6(B)

D 5502(B,257 ,59 ) DIODE

1SS355

D 5503(B,265 ,64 ) DIODE

1SS355

D 5504(B,271 ,64 ) DIODE

1SS355

D 5505(B,267 ,64 ) DIODE

UDZS4R7(B)

D 5506(B,269 ,64 ) DIODE

UDZS4R7(B)

D 5541(B,240 ,71 ) DIODE

1SS355

D 5542(B,238 ,71 ) DIODE

1SS355

D 5543(B,242 ,46 ) DIODE

1SS355

D 5544(B,242 ,73 ) DIODE

1SS355

△ TH5301(A,166 ,17 ) POSISTOR PTFM04BC22202N34B0

CN5301(A,320 ,26 ) 13P SOCKET

XKP3077

CN5302(A,86 ,40 ) 11P SOCKET

XKP3076

CN5303(A,313 ,66 ) 7-P PLUG

KM250NA7L

**RESISTORS**

R 5301(B,203 ,43 )

RS1/16S102J

R 5302(B,191 ,42 )

RS1/16S221J

**R POWER AMP-R ASSY****MISCELLANEOUS**

△ IC 5301(A,197 ,112 ) DARLINGTON POWER IC SAP17N(OY)

△ IC 5302(A,157 ,112 ) DARLINGTON POWER IC SAP17P(OY)

△ IC 5401(A,125 ,112 ) DARLINGTON POWER IC SAP17N(OY)

△ IC 5402(A,93 ,112 ) DARLINGTON POWER IC SAP17P(OY)

△ IC 5501(A,269 ,112 ) DARLINGTON POWER IC SAP17N(OY)

5		6		7		8		
Mark No.	Description	Part No.	Mark No.	Description	Part No.	Mark No.	Description	
R 5303(B,187,41)		RS1/16S333J	R 5445(B,91,52)		RS1/16S472J			
R 5304(B,203,40)		RS1/16S103J	R 5446(B,91,50)		RS1/16S472J			
R 5305(B,194,55)		RS1/16S152J	R 5447(B,90,46)		RS1/16S122J			
R 5306(B,194,52)		RS1/16S821J	R 5448(B,94,51)		RS1/16S154J		A	
R 5307(B,169,48)		RS1/16S2001F	R 5449(B,96,51)		RS1/16S103J			
R 5308(B,180,52)		RS1/16S682J	R 5450(B,98,46)		RS1/16S103J			
R 5309(A,177,48)	CARBON FILM RESISTOR	RD1/2VM473J	R 5501(B,292,43)		RS1/16S102J			
R 5310(B,171,64)		RS1/16S151J	R 5502(B,280,42)		RS1/16S221J			
R 5311(B,173,63)		RN1/16SE1201D	R 5503(B,276,41)		RS1/16S333J			
R 5312(B,202,52)		RS1/16S221J	R 5504(B,292,40)		RS1/16S103J			
R 5313(B,183,97)	CHIP RESISTOR	RS1/16S62R0F	R 5505(B,283,55)		RS1/16S152J			
R 5321(B,190,93)		RS1/16S101J	R 5506(B,283,52)		RS1/16S821J			
R 5322(B,176,93)		RS1/16S101J	R 5507(B,258,48)		RS1/16S2001F			
△ R 5323(A,163,72)	CARBON FILM RESISTOR	RD1/4MUF4R7J	R 5508(B,269,52)		RS1/16S682J		B	
△ R 5324(A,198,83)	CARBON FILM RESISTOR	RD1/4MUF4R7J	R 5509(A,266,48)	CARBON FILM RESISTOR	RD1/2VM473J			
△ R 5325(B,203,90)	CHIP RESISTOR	ACN7132	R 5510(B,255,63)		RS1/16S151J			
△ R 5326(B,166,91)	CHIP RESISTOR	ACN7132	R 5511(B,257,63)		RN1/16SE1201D			
△ R 5327(A,174,80)	RESISTOR (0.18, 5W)	ACN7121	R 5512(B,290,52)		RS1/16S221J			
R 5329(B,179,45)		RN1/10SE3302D	R 5513(B,259,97)	CHIP RESISTOR	RS1/16S62R0F			
R 5330(B,183,46)		RN1/16SE1001D	R 5521(B,270,94)		RS1/16S101J			
R 5331(B,183,43)		RN1/16SE1500D	R 5522(B,251,93)		RS1/16S101J			
R 5332(B,203,49)		RS1/16S151J	△ R 5523(A,247,69)	CARBON FILM RESISTOR	RD1/4MUF4R7J			
R 5341(B,153,77)		RS1/16S473J	△ R 5524(A,283,82)	CARBON FILM RESISTOR	RD1/4MUF4R7J			
R 5342(B,151,77)		RS1/16S223J	△ R 5525(B,277,91)	CHIP RESISTOR	ACN7132			
R 5343(B,153,73)		RS1/16S471J	△ R 5526(B,238,91)	CHIP RESISTOR	ACN7132		C	
R 5344(B,151,73)		RS1/16S471J	△ R 5527(A,258,80)	RESISTOR (0.18, 5W)	ACN7121			
R 5345(B,152,60)		RS1/16S472J	R 5529(B,268,45)		RN1/10SE3302D			
R 5346(B,150,60)		RS1/16S472J	R 5530(B,272,46)		RN1/16SE1001D			
R 5347(B,147,58)		RS1/16S122J	R 5531(B,272,43)		RN1/16SE1500D			
R 5348(B,151,55)		RS1/16S154J	R 5532(B,292,49)		RS1/16S151J			
R 5349(B,151,57)		RS1/16S103J	R 5541(B,241,77)		RS1/16S473J			
R 5350(B,156,46)		RS1/16S103J	R 5542(B,235,77)		RS1/16S223J			
R 5401(B,138,43)		RS1/16S102J	R 5543(B,239,77)		RS1/16S471J			
R 5402(B,126,42)		RS1/16S221J	R 5544(B,237,77)		RS1/16S471J			
R 5403(B,123,41)		RS1/16S333J	R 5545(B,240,64)		RS1/16S472J			
R 5404(B,138,40)		RS1/16S103J	R 5546(B,238,64)		RS1/16S472J		D	
R 5405(B,134,55)		RS1/16S152J	R 5547(B,238,57)		RS1/16S122J			
R 5406(B,134,52)		RS1/16S821J	R 5548(B,235,68)		RS1/16S154J			
R 5407(B,109,48)		RS1/16S2001F	R 5549(B,235,64)		RS1/16S103J			
R 5408(B,120,52)		RS1/16S682J	R 5550(B,245,45)		RS1/16S103J			
R 5409(A,117,48)	CARBON FILM RESISTOR	RD1/2VM473J	R 5571(B,228,38)		RS1/16S472J			
R 5410(B,114,65)		RS1/16S151J	△ R 5592(B,301,91)	CHIP RESISTOR	ACN7132			
R 5411(B,116,64)		RN1/16SE1201D	R 5622(B,308,96)		RS1/16S101J			
R 5412(B,141,52)		RS1/16S221J	<b>CAPACITORS</b>					
R 5413(B,115,97)	CHIP RESISTOR	RS1/16S62R0F	C 5301(A,194,43)		CEAT4R7M50			
R 5421(B,128,93)		RS1/16S101J	C 5302(B,187,43)		CCSRCH221J50		E	
R 5422(B,108,93)		RS1/16S101J	C 5304(B,198,55)		CKSRYB102K50			
△ R 5423(A,111,75)	CARBON FILM RESISTOR	RD1/4MUF4R7J	C 5307(A,164,52)		CEAT101M10			
△ R 5424(A,142,83)	CARBON FILM RESISTOR	RD1/4MUF4R7J	C 5308(B,198,52)	CAPACITOR(CERAMIC)	ACG7057			
△ R 5425(B,135,91)	CHIP RESISTOR	ACN7132	C 5309(A,181,58)	ELECT. CAPACITOR	CEAT100M2A			
△ R 5426(B,96,91)	CHIP RESISTOR	ACN7132	C 5311(B,197,104)	CAPACITOR(CERAMIC)	ACG7056			
△ R 5427(A,118,80)	RESISTOR (0.18, 5W)	ACN7121	C 5312(B,170,104)	CAPACITOR(CERAMIC)	ACG7056			
R 5429(B,114,44)		RN1/10SE3302D	C 5315(B,179,43)		CCSRCH220J50			
R 5430(B,118,45)		RN1/16SE1001D	C 5316(B,174,43)		CCSRCH220J50			
R 5431(B,118,43)		RN1/16SE1500D	C 5317(A,179,39)		CEAT331M10			
R 5432(B,143,49)		RS1/16S151J	C 5323(A,160,63)		CEAT100M63			
R 5441(B,99,85)		RS1/16S473J	C 5324(A,191,61)		CEAT100M63		F	
R 5442(B,97,85)		RS1/16S223J	C 5332(B,204,52)		CKSRYB224K16			
R 5443(B,101,85)		RS1/16S471J	C 5341(A,147,62)		CEANP2R2M50			
R 5444(B,95,85)		RS1/16S471J						

Mark No.	Description	Part No.
C	5351(A,228 ,68 ) ELECT. CAPACITOR	CEAT100M2A
C	5352(A,224 ,62 ) ELECT. CAPACITOR	CEAT100M2A
C	5401(A,129 ,43 )	CEAT4R7M50
C	5402(B,123 ,43 )	CCSRCH221J50
C	5404(B,138 ,55 )	CKSRYP102K50
C	5407(A,105 ,52 )	CEAT101M10
C	5408(B,138 ,52 ) CAPACITOR(CERAMIC)	ACG7057
C	5409(A,125 ,59 ) ELECT. CAPACITOR	CEAT100M2A
C	5411(B,130 ,104 ) CAPACITOR(CERAMIC)	ACG7056
C	5412(B,101 ,104 ) CAPACITOR(CERAMIC)	ACG7056
C	5415(B,114 ,42 )	CCSRCH220J50
C	5416(B,109 ,43 )	CCSRCH220J50
C	5417(A,114 ,39 )	CEAT331M10
C	5423(A,107 ,61 )	CEAT100M63
C	5424(A,135 ,61 )	CEAT100M63
C	5432(B,143 ,52 )	CKSRYP224K16
C	5441(A,87 ,45 )	CEANP2R2M50
C	5501(A,283 ,43 )	CEAT4R7M50
C	5502(B,276 ,43 )	CCSRCH221J50
C	5504(B,287 ,55 )	CKSRYP102K50
C	5507(A,253 ,52 )	CEAT101M10
C	5508(B,287 ,52 ) CAPACITOR(CERAMIC)	ACG7057
C	5509(A,265 ,58 ) ELECT. CAPACITOR	CEAT100M2A
C	5511(B,272 ,104 ) CAPACITOR(CERAMIC)	ACG7056
C	5512(B,245 ,104 ) CAPACITOR(CERAMIC)	ACG7056
C	5515(B,268 ,43 )	CCSRCH220J50
C	5516(B,263 ,43 )	CCSRCH220J50
C	5517(A,268 ,39 )	CEAT331M10
C	5523(A,244 ,59 )	CEAT100M63
C	5524(A,280 ,61 )	CEAT100M63
C	5532(B,293 ,52 )	CKSRYP224K16
C	5541(A,238 ,54 )	CEANP2R2M50
C	5571(A,231 ,35 )	CEAT331M10
C	5612(B,307 ,104 ) CAPACITOR(CERAMIC)	ACG7056
<b>S LOCAL SUPPLY ASSY</b>		
<b>MISCELLANEOUS</b>		
△IC	6101(A,149 ,69 ) IC	NJM78M05FA
△IC	6102(A,149 ,19 ) REGULATOR IC	NJM78M56FA
△IC	6103(A,11 ,64 ) REGULATOR IC	NJM78M12FA
△IC	6104(A,11 ,39 ) REGULATOR IC	NJM78M12FA
△IC	6105(A,149 ,44 ) IC	NJM79M05FA
△IC	6106(A,11 ,14 ) REGULATOR IC	NJM79M12FA
△D	6101(A,111 ,50 ) DIODE	D3SBA20(B)
△D	6102(B,65 ,61 ) DIODE	1SR154-400
△D	6103(B,56 ,61 ) DIODE	1SR154-400
△D	6104(B,61 ,61 ) DIODE	1SR154-400
D	6105(B,86 ,72 ) DIODE	UDZS6R2(B)
D	6106(B,88 ,77 ) DIODE	UDZS6R2(B)
D	6107(B,85 ,77 ) DIODE	UDZS6R2(B)
D	6108(B,94 ,80 ) DIODE	UDZS6R2(B)
D	6109(B,88 ,90 ) DIODE	UDZS6R2(B)
D	6111(B,140 ,68 ) CHIP DIODE	RB501V-40
D	6115(B,26 ,71 ) CHIP DIODE	RB501V-40
D	6121(B,141 ,10 ) CHIP DIODE	RB501V-40
△D	6122(B,59 ,39 ) DIODE	1SR154-400
△D	6123(B,63 ,39 ) DIODE	1SR154-400
D	6124(B,142 ,39 ) CHIP DIODE	RB501V-40
D	6125(B,149 ,50 ) DIODE	1SS355

Mark No.	Description	Part No.
D	6126(B,18 ,43 ) CHIP DIODE	RB501V-40
△D	6127(B,63 ,26 ) DIODE	1SR154-400
△D	6128(B,59 ,26 ) DIODE	1SR154-400
D	6129(B,18 ,16 ) CHIP DIODE	RB501V-40
J	6104(A,70 ,95 ) CONNECTOR ASSY	PF05PG-Q20
CN	6101(A,112 ,73 ) CONNECTOR	B12B-PH
CN	6103(A,91 ,93 ) 6P JUMPER CONNECTOR	52147-0610
CN	6105(A,60 ,8 ) CONNECTOR	B8B-PH
CN	6106(A,87 ,8 ) CONNECTOR	B11B-PH
	6102(A,121 ,83 ) 4P CABLE HOLDER	51048-0400

**RESISTORS**

R	6101(B,75 ,71 )	RS1/16S473J
△R	6103(A,76 ,77 ) CARBON FILM RESISTOR	RD1/4MUF391J
△R	6107(A,97 ,60 ) CARBON FILM RESISTOR	RD1/4MUF4R7J

**CAPACITORS**

C	6101(A,120 ,76 ) FILM CAPACITOR	CQMB104J50
C	6103(B,95 ,89 )	CKSRYP103K50
C	6105(B,146 ,72 )	CKSRYP103K50
C	6107(A,110 ,61 ) FILM CAPACITOR	CQMB104J50
C	6110(B,145 ,22 )	CKSRYP103K50
C	6111(B,142 ,46 )	CKSRYP103K50
C	6112(B,14 ,63 )	CKSRYP103K50
C	6115(B,15 ,37 )	CKSRYP103K50
C	6116(B,14 ,11 )	CKSRYP103K50
C	6117(A,68 ,52 ) ELECT. CAPACITOR	CEANP101M35
C	6122(A,60 ,70 ) ELECT. CAPACITOR	CEAT101M35
C	6123(A,71 ,70 )	CEAT221M35
C	6124(A,91 ,72 )	CEAT470M50
C	6125(A,84 ,89 )	CEAT101M16
C	6127(A,112 ,37 ) ELECT. CAPACITOR	CEAT682M16
C	6129(A,144 ,58 )	CEAT221M16
C	6130(A,141 ,19 )	CEAT101M16
C	6131(A,94 ,37 ) ELECT. CAPACITOR	CEAT222M16
C	6132(A,48 ,51 ) ELECT. CAPACITOR	CEAT222M25
C	6133(A,144 ,31 )	CEAT101M16

C	6134(A,16 ,68 )	CEAT100M50
C	6135(A,18 ,52 )	CEAT221M25
C	6136(A,48 ,34 ) ELECT. CAPACITOR	CEAT222M25
C	6137(A,18 ,27 )	CEAT221M25

**T DC/DC ASSY****MISCELLANEOUS**

△IC	4271(A,112 ,80 ) REGULATOR IC	PQ1CG3032FZ
△D	4271(A,68 ,85 ) DIODE	D3SBA20(B)
△D	4272(B,124 ,77 ) DIODE	RB051L-40
L	4271(A,133 ,58 ) INDUCTOR	ATH7020
CN	4271(A,60 ,54 ) 4PJUMPER CONNECTOR	52151-0410
CN	4272(A,107 ,50 ) 3PIN CONNECTOR	S3B-EH
	4273(A,62 ,68 ) PCB BINDER	VEF1040

**RESISTORS**

△R	4271(A,67 ,58 ) CARBON FILM RESISTOR	RD1/4MUF4R7J
R	4272(B,110 ,76 )	RN1/16SE1001D
R	4273(B,106 ,76 )	RN1/16SE3001D
R	4274(B,104 ,76 )	RS1/16S101J

**CAPACITORS**

C	4271(A,67 ,53 ) FILM CAPACITOR	CQMB104J50
C	4272(A,92 ,66 ) ELECT. CAPACITOR	CEAT103M16
C	4273(A,118 ,53 ) ELECT. CAPACITOR	CEHAZL102M6R3



5	6	
Mark No.	Description	Part No.
C 4274(A,109,67)	ELECT. CAPACITOR	CEHAZL102M16
C 4274(B,85,85)	ELECT. CAPACITOR	CEHAZL102M16
C 4274(B,62,71)	ELECT. CAPACITOR	CEHAZL102M16

## U TRANS2-1 ASSY

### MISCELLANEOUS

△ IC 4201(A,111,106)	PROTECTOR(7A)	AEK7021
△ IC 4202(A,95,152)	PROTECTOR(7A)	AEK7021
Q 4201(B,90,97)	CHIP TRANSISTOR	RN1901
Q 4202(B,81,97)	TRANSISTOR	UMD2N
Q 4203(B,73,97)	TRANSISTOR	UMD2N
△ D 4201(B,100,140)	BRIDGE DIODE	S1WB(A)60SD
D 4203(B,98,105)	DIODE	UDZS10(B)
D 4204(B,71,105)	DIODE	UDZS9R1(B)
D 4205(B,100,105)	DIODE	UDZS9R1(B)
D 4206(B,71,102)	DIODE	UDZS8R2(B)
D 4207(B,100,99)	DIODE	UDZS9R1(B)
D 4208(B,76,104)	DIODE	UDZS8R2(B)
D 4209(B,96,99)	DIODE	UDZS6R8(B)
D 4210(B,76,101)	DIODE	UDZS6R8(B)
D 4211(B,94,102)	DIODE	UDZS13(B)
D 4212(B,81,101)	DIODE	UDZS15(B)
D 4213(B,96,104)	DIODE	UDZS12(B)
D 4214(B,81,104)	DIODE	UDZS12(B)
D 4215(B,77,95)	DIODE	UDZS13(B)
D 4216(B,68,94)	DIODE	UDZS13(B)
J 4201 JUMPER WIRE		D20PDY0610E
4201(A,73,128)	6P CABLE HOLDER	51048-0600

### RESISTORS

△ R 4201(A,106,118)	CARBON FILM RESISTOR	RD1/4MUF100J
R 4203(A,95,93)	CARBON FILM RESISTOR	RD1/4MUF470J
△ R 4205(A,85,129)	METAL OXIDE RESISTOR	RS1LMF472J
△ R 4206(A,71,109)	METAL OXIDE RESISTOR	RS1LMF472J
△ R 4207(A,88,126)	CARBON FILM RESISTOR	RD1/2LMF332J
△ R 4208(A,75,106)	CARBON FILM RESISTOR	RD1/2LMF332J

### CAPACITORS

C 4201(A,106,112)	FILM CAPACITOR	CFTLA104J2A
C 4202(A,110,156)	FILM CAPACITOR	CFTLA104J2A
C 4203(A,106,100)	PPS CAPACITOR	CQHA102J2A
C 4204(A,106,94)	PPS CAPACITOR	CQHA102J2A
C 4205(A,91,136)	ELECT. CAPACITOR	CEAT471M2A
C 4206(A,81,149)	ELECT. CAPACITOR	CEAT471M2A
C 4207(A,94,119)	ELECT. CAPACITOR	CEAT101M63
C 4208(A,94,108)	ELECT. CAPACITOR	CEAT101M63
C 4209(A,65,132)	ELECT. CAPACITOR	CEAT221M2A
C 4210(A,72,120)	ELECT. CAPACITOR	CEAT221M2A

## V VH TR ASSY

### MISCELLANEOUS

△ IC 4261 IC	PROTECTOR	ICP-N15
△ IC 4262 IC	PROTECTOR	ICP-N15
△ Q 4261(A,36,31)	TRANSISTOR	2SD1763A
△ Q 4262(A,21,31)	TRANSISTOR	2SB1186A
Q 4263(B,30,20)	CHIP TRANSISTOR	2SC3906K
Q 4264(B,15,20)	CHIP TRANSISTOR	2SA1514K
△ D 4261(B,42,16)	DIODE	1SR154-400
△ D 4262(B,26,19)	DIODE	1SR154-400
CN4261(A,23,9)	6P JUMPER CONNECTOR	52147-0610

7	8	
Mark No.	Description	Part No.

### RESISTORS

R 4261(B,29,24)		RS1/16S100J
R 4262(B,14,24)		RS1/16S100J
R 4263(B,30,15)		RS1/16S471J
R 4264(B,14,13)		RS1/16S471J

## W DIODE ASSY

### MISCELLANEOUS

△ D 4251(A,189,128)	DIODE	D5SBA20(B)
△ D 4252(A,154,128)	DIODE	D5SBA20(B)

## X SP/PS ASSY (VSX-74TXVi)

### MISCELLANEOUS

Q 4001(B,150,72)	CHIP TRANSISTOR	DTC114TUA
Q 4002(B,229,97)	CHIP TRANSISTOR	DTC114TUA
Q 4003(B,247,90)	CHIP TRANSISTOR	DTC114TUA
Q 4004(B,290,84)	CHIP TRANSISTOR	DTC114TUA
Q 4005(B,212,99)	CHIP TRANSISTOR	DTC114TUA
D 4001(B,168,80)	DIODE	1SS355
D 4002(B,165,80)	DIODE	1SS355
D 4003(B,216,88)	DIODE	1SS355
D 4004(B,213,88)	DIODE	1SS355
D 4005(B,247,82)	DIODE	1SS355
D 4006(B,244,82)	DIODE	1SS355
D 4007(B,291,79)	DIODE	1SS355
D 4008(B,289,79)	DIODE	1SS355
D 4009(B,217,99)	DIODE	1SS355
D 4010(B,215,99)	DIODE	1SS355

L 4011(A,188,78)	COIL	ATH1053
L 4021(A,149,68)	COIL	ATH1053
L 4031(A,199,83)	COIL	ATH1053
L 4041(A,258,82)	COIL	ATH1053
L 4051(A,236,90)	COIL	ATH1053

L 4061(A,299,81)	COIL	ATH1053
L 4071(A,280,84)	COIL	ATH1053
J 4009(A,147,76)	CONNECTOR ASS'Y	PF13PG-R12
RY4001(A,163,81)	RELAY	XSR3002
RY4002(A,211,89)	RELAY	XSR3002

RY4003(A,242,83)	RELAY	XSR3002
RY4004(A,286,82)	RELAY	XSR3002
RY4005(A,219,103)	RELAY	XSR3002
CN4001(A,185,33)	SPEAKER TERMINAL 6-P	AKE7075
CN4002(A,248,33)	SPEAKER TERMINAL 8-P	AKE7074

CN4007(A,313,90)	5P PLUG	KM200TA5
CN4008(A,313,152)	9P PLUG	KM200TA9
Y 13	AWG14 BOARD IN	ADX7461

### RESISTORS

△ R 4011(A,187,68)	METAL OXIDE RESISTOR	RS1/2LMF4R7J
△ R 4012(A,175,64)	METAL OXIDE RESISTOR	RS1LMF100J
△ R 4013(A,193,94)	METAL OXIDE RESISTOR	RS2LMF331J
△ R 4021(A,158,70)	METAL OXIDE RESISTOR	RS1/2LMF4R7J
△ R 4022(A,145,58)	METAL OXIDE RESISTOR	RS1LMF100J

△ R 4023(A,188,97)	METAL OXIDE RESISTOR	RS2LMF331J
△ R 4031(A,196,87)	METAL OXIDE RESISTOR	RS1/2LMF4R7J
△ R 4032(A,194,67)	METAL OXIDE RESISTOR	RS1LMF100J
△ R 4041(A,254,82)	METAL OXIDE RESISTOR	RS1/2LMF4R7J
△ R 4042(A,267,67)	METAL OXIDE RESISTOR	RS1LMF100J

Mark No.	Description	Part No.
△ R 4051(A,240 ,93)	METAL OXIDE RESISTOR	RS1/2LMF4R7J
△ R 4052(A,228 ,67)	METAL OXIDE RESISTOR	RS1LMF100J
△ R 4061(A,309 ,79)	METAL OXIDE RESISTOR	RS1/2LMF4R7J
△ R 4062(A,313 ,73)	METAL OXIDE RESISTOR	RS1LMF100J
△ R 4071(A,280 ,88)	METAL OXIDE RESISTOR	RS1/2LMF4R7J
△ R 4072(A,268 ,94)	METAL OXIDE RESISTOR	RS1LMF100J
R 4101(A,222 ,115)	CARBON FILM RESISTOR	RD1/4MUF473J
R 4102(A,252 ,115)	CARBON FILM RESISTOR	RD1/4MUF473J

## CAPACITORS

C 4001(A,162 ,88)	CEAT101M50
C 4011(A,182 ,60)	CFTLA104J50
C 4012(A,178 ,57)	CFTLA104J50
C 4021(A,145 ,48)	CFTLA104J50
C 4022(A,145 ,39)	CFTLA104J50

C 4031(A,197 ,63)	CFTLA104J50
C 4032(A,192 ,57)	CFTLA104J50
C 4041(A,257 ,63)	CFTLA104J50
C 4042(A,257 ,54)	CFTLA104J50
C 4051(A,224 ,61)	CFTLA104J50

C 4052(A,228 ,55)	CFTLA104J50
C 4061(A,304 ,61)	CFTLA104J50
C 4062(A,304 ,54)	CFTLA104J50
C 4071(A,270 ,65)	CFTLA104J50
C 4072(A,272 ,59)	CFTLA104J50

C 4101(A,212 ,137)	ELECTR.CAPACITOR	ACH7218
C 4102(A,258 ,137)	ELECTR.CAPACITOR	ACH7218

## Y TRANS2-2 ASSY

### MISCELLANEOUS

H 3151(A,173 ,78)	FUSE CLIP	AKR7001
H 3152(A,151 ,78)	FUSE CLIP	AKR7001
H 3153(A,174 ,67)	FUSE CLIP	AKR7001
H 3154(A,152 ,67)	FUSE CLIP	AKR7001
H 3155(A,173 ,56)	FUSE CLIP	AKR7001

H 3156(A,151 ,56)	FUSE CLIP	AKR7001
H 3157(A,173 ,43)	FUSE CLIP	AKR7001
H 3158(A,151 ,43)	FUSE CLIP	AKR7001
H 3159(A,173 ,32)	FUSE CLIP	AKR7001
H 3160(A,151 ,32)	FUSE CLIP	AKR7001

J 3001(A,138 ,39)	CONNECTOR ASS'Y	PF12PG-R40
-------------------	-----------------	------------

## Z TRANS1 ASSY

TRANS1 ASSY has no service parts.

## AA PRIMARY ASSY

### MISCELLANEOUS

△ IC 3061(A,299 ,119)	REGULATOR IC	NJM78M56FA
Q 3061(B,281 ,82)	DIGITAL TR(SC-70)	RT1N431M
△ D 3061(B,296 ,103)	BRIDGE DIODE	S1WB(A)60SD
D 3062(B,299 ,89)	DIODE	1SS355
D 3063(B,308 ,89)	DIODE	UDZS5R1(B)

D 3064(B,275 ,89)	DIODE	1SS355
D 3065(B,275 ,82)	DIODE	1SS355

△ L 3063(A,244 ,46)	LINE FILTER	XTF3004
H 3061(A,223 ,68)	FUSE CLIP	AKR7001
H 3062(A,243 ,68)	FUSE CLIP	AKR7001

Mark No.	Description	Part No.
KN3061(A,313 ,32)	WRAPPING TERMINAL	VNF1084
△ RY3061(A,271 ,80)	POWER RELAY	ASR7022
△ T 3061(A,273 ,106)	STANDBY TRANSFORMER	ATT7043
△ CN3061(A,228 ,44)	AC CODE SOCKET	RKP1751
CN3062(A,308 ,137)	9P SOCKET	KP200TA9L
CN3063(A,246 ,137)	5P SOCKET	KP200TA5L
△ 3064(A,189 ,77)	AC SOCKET 1-P	AKP1033

## RESISTORS

△ R 3061(A,302 ,29)	RESISTOR(2.2M, 1/2W)	RCN1080
R 3062(B,303 ,89)		RS1/16S332J
R 3063(A,279 ,95)	CARBON FILM RESISTOR	RD1/4MUF220J
R 3064(B,305 ,89)		RS1/16S103J

## CAPACITORS

△ C 3061(A,266 ,47)	FILM CAPACITOR	ACE7013
△ C 3062(A,251 ,74)		ACG7039
C 3063(A,286 ,132)	FILM CAPACITOR	CQMB A103J50
C 3064(B,291 ,115)		CKSRYB102K50
C 3065(B,289 ,115)		CKSRYB102K50

C 3066(B,294 ,110)		CKSRYB102K50
C 3067(B,308 ,96)		CKSRYB102K50
C 3068(A,305 ,105)	ELECT. CAPACITOR	CEAT332M25
C 3069(A,317 ,134)		CEAT221M25
C 3071(B,311 ,99)		CKSRYB103K50

## AB VOLUME ASSY

### MISCELLANEOUS

S 3571(A,295 ,167)	ROTARY ENCODER	ASX7005
S 3572(A,273 ,199)	SWITCH	VSG1024
S 3573(A,293 ,199)	SWITCH	VSG1024
S 3574(A,312 ,199)	SWITCH	VSG1024
3571(A,266 ,185)	CABLE HOLDER(6P)	51063-0605

## RESISTORS

R 3574(B,285 ,200)		RS1/16S681J
R 3575(B,302 ,200)		RS1/16S821J

## CAPACITORS

C 3572(B,300 ,172)		CKSRYB103K50
C 3573(B,295 ,172)		CKSRYB103K50

## AC DISPLAY ASSY (VSX-74TXVi)

### MISCELLANEOUS

IC 3201(B,131 ,214)	DISPLAY U-COM	PE5503A
IC 3202(A,17 ,221)	REMOTE RECEIVER UNIT	RPM7140-H9
IC 3203(B,171 ,168)	LOGIC IC	CD4053BNS
Q 3304(B,110 ,190)	DIGITAL TR(SC-70)	RT1N431M
Q 3305(B,219 ,208)	DIGITAL TR(SC-70)	RT1N431M
Q 3307(B,31 ,203)	DIGITAL TR(SC-70)	RT1N431M
Q 3308(B,16 ,201)	DIGITAL TR(SC-70)	RT1N431M
Q 3310(B,204 ,208)	DIGITAL TR(SC-70)	RT1N431M
Q 3351(B,205 ,189)	DIGITAL TR(SC-70)	RT1N431M
Q 3352(B,189 ,159)	DIGITAL TR(SC-70)	RT1N431M

Q 3353(B,200 ,160)	TRANSISTOR	2SA1576A
Q 3354(B,150 ,160)	CHIP TR (PNP X 2)	UMB1N
Q 3355(B,176 ,159)	TRANSISTOR	UMH1N
D 3314(A,121 ,195)	LED(BLUE)	SLR-343BBT(HJKL)
D 3315(A,224 ,208)	LED(BLUE)	SLR-343BBT(HJKL)

D 3317(A,31 ,208)	LED(ORANGE)	SLI-343DCW(STU)
D 3318(A,16 ,206)	LED(RED)	SLI-343URW(RST)



**Mark No. Description****Part No.****Mark No. Description****Part No.**

R 3329(B,144 ,204 )  
R 3330(B,153 ,190 )  
A R 3331(B,151 ,190 )  
R 3332(B,150 ,187 )  
R 3333(B,148 ,187 )

RS1/16S0R0J  
RS1/16S221J  
RS1/16S221J  
RS1/16S221J  
RS1/16S221J

R 3334(B,128 ,193 )  
R 3336(B,109 ,197 )  
R 3337(B,90 ,206 )  
R 3338(B,102 ,202 )  
R 3339(B,96 ,211 )

RS1/16S104J  
RS1/16S473J  
RS1/16S101J  
RS1/16S104J  
RS1/16S104J

R 3341(B,104 ,206 )  
R 3343(B,104 ,202 )  
B R 3344(B,122 ,180 )  
R 3345(B,94 ,211 )  
R 3346(B,117 ,181 )

RS1/16S474J  
RS1/16S0R0J  
RS1/16S221J  
RS1/16S474J  
RS1/16S221J

R 3347(B,93 ,198 )  
R 3350(B,215 ,191 )  
R 3351(B,193 ,211 )  
R 3352(B,179 ,167 )  
R 3353(B,185 ,167 )

RS1/16S221J  
RS1/16S0R0J  
RS1/16S473J  
RS1/16S223J  
RS1/16S103J

R 3354(B,159 ,163 )  
R 3355(B,205 ,184 )  
R 3356(B,203 ,184 )  
R 3357(B,201 ,184 )  
C R 3358(B,199 ,184 )

RS1/16S392J  
RS1/16S0R0J  
RS1/16S0R0J  
RS1/16S0R0J  
RS1/16S0R0J

R 3359(B,203 ,179 )  
R 3360(B,161 ,163 )  
R 3361(B,197 ,160 )  
R 3362(B,161 ,167 )  
R 3363(B,159 ,166 )

RS1/16S221J  
RS1/16S103J  
RS1/16S0R0J  
RS1/16S0R0J  
RS1/16S0R0J

R 3366(B,194 ,161 )  
R 3367(B,202 ,156 )  
R 3368(B,202 ,160 )  
R 3369(B,194 ,165 )  
R 3371(B,200 ,164 )

RS1/16S472J  
RS1/16S104J  
RS1/16S104J  
RS1/16S102J  
RS1/16S103J

R 3372(B,205 ,160 )  
R 3373(B,179 ,163 )  
R 3374(B,179 ,159 )  
R 3376(B,170 ,157 )  
R 3377(B,101 ,213 )

RS1/16S101J  
RS1/16S0R0J  
RS1/16S0R0J  
RS1/16S0R0J  
RS1/16S104J

**CAPACITORS**

C 3201(B,77 ,155 )  
C 3211(B,108 ,154 )  
C 3221(B,119 ,154 )  
C 3231(B,186 ,236 )  
E C 3232(A,194 ,238 ) ELECT. CAPACITOR

CKSRYB102K50  
CKSRYB102K50  
CKSRYB102K50  
CCSRCH471J50  
CEJQ101M35

C 3235(B,178 ,231 )  
C 3236(B,176 ,231 )  
C 3237(B,174 ,231 )  
C 3238(B,172 ,231 )  
C 3239(B,169 ,231 )

CCSRCH471J50  
CCSRCH471J50  
CCSRCH471J50  
CCSRCH471J50  
CCSRCH471J50

C 3240  
CCSRCH471J50

(B,167 ,231 )

C 3241(B,165 ,231 )  
C 3242(B,163 ,231 )  
C 3243(B,159 ,231 )  
C 3244(B,157 ,231 )

CCSRCH471J50  
CCSRCH471J50  
CCSRCH471J50  
CCSRCH471J50

C 3245(B,155 ,231 )  
C 3246(B,153 ,231 )  
C 3247(B,150 ,231 )

CCSRCH471J50  
CCSRCH471J50  
CCSRCH471J50

C 3248(B,148 ,231 )  
C 3249(B,146 ,231 )

CCSRCH471J50  
CCSRCH471J50

C 3250(B,144 ,231 )  
C 3321(B,149 ,215 )  
C 3322(B,67 ,229 )  
C 3323(B,129 ,230 )  
C 3326(B,143 ,200 )

CCSRCH471J50  
CKSRYB103K50  
CKSRYB103K50  
CKSRYB103K50  
CKSRYB104K25

C 3328(B,152 ,205 )  
C 3330(B,125 ,193 )  
C 3334(B,102 ,206 )  
C 3335(A,89 ,194 ) ELECT. CAPACITOR  
C 3353(B,164 ,158 )

CKSRYB104K25  
CKSRYB102K50  
CKSRYB103K50  
CEJQ470M50  
CKSRYB153K50

C 3354(B,197 ,164 )  
C 3355(B,11 ,229 )  
C 3356(B,232 ,216 )  
C 3359(A,8 ,227 )  
C 3360(A,194 ,224 )

CKSRYB103K50  
CKSRYB103K50  
CKSRYB103K50  
CEJQ101M6R3  
CEJQ221M6R3

**AD INPUT SELECT ASSY  
MISCELLANEOUS**

Q 3561(B,78 ,95 ) DIGITAL TR(SC-70) RT1N431M  
D 3562(A,28 ,69 ) LED(BLUE) SLR-343BBT(HJKL)  
S 3561(A,95 ,86 ) ROTARY ENCODER ASX7047  
S 3562(A,64 ,103 ) SWITCH VSG1024  
S 3563(A,64 ,83 ) SWITCH VSG1024

S 3564(A,35 ,65 ) SWITCH VSG1024  
S 3565(A,64 ,63 ) SWITCH VSG1024  
3561(A,79 ,106 ) CABLE HOLDER(8P) 51063-0805

**RESISTORS**

R 3561(B,73 ,95 ) RS1/16S391J  
R 3563(B,59 ,106 ) RS1/16S272J  
R 3564(B,59 ,87 ) RS1/16S512J

**CAPACITORS**

C 3563(B,91 ,86 ) CKSRYB103K50  
C 3564(B,89 ,86 ) CKSRYB103K50

**AE PREOUT & CONTROL ASSY  
MISCELLANEOUS**

IC 2931(A,192 ,118 ) RS-232C TRANSCEIVER MAX3232CPW  
IC 2932(B,167 ,69 ) OP-AMP IC BA4560RF  
Q 2801(A,197 ,14 ) TRANSISTOR IMX25  
Q 2802(A,197 ,21 ) TRANSISTOR IMX25  
Q 2821(A,197 ,27 ) TRANSISTOR IMX25

Q 2822(A,197 ,34 ) TRANSISTOR IMX25  
Q 2841(A,197 ,40 ) TRANSISTOR IMX25  
Q 2842(A,197 ,47 ) TRANSISTOR IMX25  
Q 2861(A,197 ,53 ) TRANSISTOR IMX25  
Q 2862(A,197 ,60 ) TRANSISTOR IMX25

Q 2931(B,193 ,126 ) TRANSISTOR 2SC4081  
Q 2952(A,182 ,96 ) DIGITAL TR(SC-70) RT1N431M  
D 2901(A,199 ,131 ) DIODE 1SS355  
D 2931(B,203 ,121 ) DIODE 1SS355  
D 2951(B,177 ,126 ) DIODE 1SS355

D 2952(A,170 ,98 ) DIODE 1SS355  
D 2957(A,199 ,89 ) DIODE UDZS6R2(B)  
D 2958(A,193 ,84 ) DIODE UDZS6R2(B)  
D 2959(A,197 ,89 ) DIODE UDZS6R2(B)  
D 2960(A,193 ,86 ) DIODE UDZS6R2(B)

Mark No.	Description	Part No.
L 2901(A,203 ,134 )	CHIP SOLID INDUCTOR	QTL1013
L 2902(A,203 ,133 )	CHIP SOLID INDUCTOR	QTL1013
L 2903(A,203 ,137 )	CHIP SOLID INDUCTOR	QTL1013
L 2904(A,203 ,136 )	CHIP SOLID INDUCTOR	QTL1013
L 2931(B,174 ,119 )	CHIP SOLID INDUCTOR	QTL1013
L 2933(B,170 ,119 )	CHIP BEADS	VTL1083
L 2934(A,169 ,129 )	CHIP BEADS	VTL1083
L 2935(B,189 ,130 )	CHIP BEADS	VTL1083
JA2901(A,219 ,142 )	MINI JACK(4P) /W SW	XKN3015
CN2801(A,164 ,23 )	26P CONNECTOR	52045-2645
CN2802(A,165 ,135 )	23P SOCKET	XKP3082
CN2804(A,220 ,93 )	20P SOCKET	AKP7202
CN2805(A,220 ,23 )	PIN JACK(4P)	AKB7172
CN2806(A,220 ,51 )	PIN JACK(4P)	AKB7172
CN2931(A,220 ,119 )	9P D-SUB SOCKET	AKP1213

### RESISTORS

R 2801(B,203 ,14 )	RS1/16S101J
R 2802(B,203 ,21 )	RS1/16S101J
R 2803(B,197 ,14 )	RS1/16S121J
R 2804(B,197 ,21 )	RS1/16S121J
R 2805(B,191 ,14 )	RS1/16S271J
R 2806(B,191 ,21 )	RS1/16S271J
R 2807(A,202 ,16 )	RS1/16S103J
R 2808(A,202 ,22 )	RS1/16S103J
R 2809(A,193 ,16 )	RS1/16S103J
R 2810(A,193 ,22 )	RS1/16S103J
R 2821(B,203 ,27 )	RS1/16S101J
R 2822(B,203 ,34 )	RS1/16S101J
R 2823(B,197 ,27 )	RS1/16S121J
R 2824(B,197 ,34 )	RS1/16S121J
R 2825(B,191 ,27 )	RS1/16S271J
R 2826(B,191 ,34 )	RS1/16S271J
R 2827(A,202 ,29 )	RS1/16S103J
R 2828(A,202 ,35 )	RS1/16S103J
R 2829(A,193 ,29 )	RS1/16S103J
R 2830(A,193 ,35 )	RS1/16S103J
R 2841(B,203 ,40 )	RS1/16S101J
R 2842(B,203 ,47 )	RS1/16S101J
R 2843(B,197 ,40 )	RS1/16S121J
R 2844(B,197 ,47 )	RS1/16S121J
R 2845(B,191 ,40 )	RS1/16S271J
R 2846(B,191 ,47 )	RS1/16S271J
R 2847(A,202 ,42 )	RS1/16S103J
R 2848(A,202 ,48 )	RS1/16S103J
R 2849(A,193 ,42 )	RS1/16S103J
R 2850(A,193 ,48 )	RS1/16S103J
R 2861(B,203 ,53 )	RS1/16S101J
R 2862(B,203 ,60 )	RS1/16S101J
R 2863(B,197 ,53 )	RS1/16S121J
R 2864(B,197 ,60 )	RS1/16S121J
R 2865(B,191 ,53 )	RS1/16S271J
R 2866(B,191 ,60 )	RS1/16S271J
R 2867(A,202 ,55 )	RS1/16S103J
R 2868(A,202 ,61 )	RS1/16S103J
R 2869(A,193 ,55 )	RS1/16S103J
R 2870(A,193 ,61 )	RS1/16S103J
R 2931(A,198 ,121 )	RS1/16S101J
R 2932(B,203 ,115 )	RS1/16S101J
R 2933(B,189 ,118 )	RS1/16S101J

Mark No.	Description	Part No.
R 2934(A,188 ,122 )		RS1/16S101J
R 2935(B,203 ,119 )		RS1/16S224J
R 2936(B,203 ,123 )		RS1/16S474J
R 2937(B,198 ,120 )		RS1/16S103J
R 2938(B,198 ,122 )		RS1/16S224J
R 2939(B,212 ,113 )		RS1/16S0R0J
R 2951(B,187 ,90 )		RS1/16S104J
R 2952(B,187 ,86 )		RS1/16S104J
R 2953(B,184 ,89 )		RS1/16S331J
R 2954(B,184 ,86 )		RS1/16S331J
R 2957(A,185 ,100 )		RS1/16S514J
R 2959(A,182 ,100 )		RS1/16S393J
R 2962(A,175 ,97 )		RS1/16S0R0J
R 2965(B,176 ,75 )		RS1/16S472J
R 2966(B,167 ,60 )		RS1/16S472J
R 2967(B,164 ,94 )		RS1/16S104J
R 2968(B,161 ,92 )		RS1/16S104J

R 2969(B,174 ,71 )	RS1/16S472J
R 2970(B,167 ,58 )	RS1/16S472J
R 2971(A,170 ,70 )	RS1/16S103J
R 2972(A,164 ,68 )	RS1/16S103J
R 2973(A,170 ,67 )	RS1/16S103J
R 2974(A,165 ,64 )	RS1/16S103J
R 2975(B,169 ,77 )	RS1/16S101J
R 2976(B,161 ,71 )	RS1/16S101J
R 2996(B,191 ,130 )	RS1/16S0R0J

### CAPACITORS

C 2891(B,214 ,23 )	CKSRYB103K50
C 2892(B,214 ,51 )	CKSRYB103K50
C 2903(B,204 ,135 )	CKSRYB104K16
C 2931(B,207 ,128 )	CKSRYB103K50
C 2933(A,192 ,112 )	CKSRYB105K10
C 2934(A,192 ,122 )	CKSRYB105K10
C 2935(A,197 ,115 )	CKSRYB473K25
C 2936(A,197 ,118 )	CKSRYB224K16
C 2937(A,186 ,115 )	CKSRYB103K50
C 2938(A,177 ,115 )	CEAT101M16
C 2939(B,203 ,117 )	CKSRYB103K50
C 2940(B,198 ,124 )	CCSRCH331J50
C 2955(A,178 ,91 )	CEAT100M50
C 2956(A,178 ,85 )	CEAT100M50
C 2957(B,178 ,132 )	CKSRYB103K50
C 2958(B,209 ,84 )	CKSRYB103K50
C 2961(A,174 ,77 )	CEAT100M50
C 2962(A,182 ,77 )	CEAT100M50
C 2967(A,167 ,85 )	CEAT100M50
C 2968(A,161 ,78 )	CEAT100M50
C 2969(B,165 ,75 )	CKSRYB103K50
C 2970(B,167 ,73 )	CKSRYB103K50
C 2973(A,206 ,105 )	CKSRYB103K50
C 2974(A,205 ,105 )	CKSRYB474K10
C 2975(B,211 ,86 )	CKSRYB474K10
C 2976(B,211 ,88 )	CKSRYB103K50

### AF 1394 ASSY MISCELLANEOUS

△ IC 1 (A,42 ,38 ) IC	NJM2391DL1-33
IC 101 (A,61 ,43 ) MICROCOMPUTER	PD5787A





1	2	3	4
Mark No.	Description	Part No.	Mark No. Description Part No.
A	C 202 (B,107 ,50)	CKSRYB104K16	C 401 (A,33 ,37) CEVW101M16
	C 203 (B,110 ,52)	CKSRYB104K16	C 402 (A,33 ,43) CCSRCH471J50
	C 204 (B,105 ,54)	CKSRYB104K16	C 404 (A,26 ,48) CKSRYB104K16
	C 205 (B,105 ,53)	CKSRYB104K16	C 405 (A,24 ,61) CKSRYB104K16
	C 206 (B,77 ,56)	CEVW101M16	C 408 (A,18 ,56) CKSRYB104K16
	C 207 (B,81 ,59)	CKSRYB104K16	C 409 (A,29 ,48) CKSRYB104K16
	C 209 (A,106 ,61)	CKSRYB104K16	C 410 (A,29 ,61) CKSRYB104K16
	C 210 (B,105 ,64)	CKSRYB104K16	C 411 (A,18 ,59) CKSRYB104K16
	C 211 (B,105 ,63)	CKSRYB102K50	C 412 (A,21 ,48) CKSRYB104K16
	C 212 (B,100 ,55)	CKSRYB104K16	C 415 (B,51 ,20) CKSRYB104K16
	C 213 (B,99 ,55)	CKSRYB102K50	C 416 (B,21 ,61) CKSRYB104K16
	C 214 (A,101 ,61)	CKSRYB104K16	C 419 (A,78 ,24) CEVW101M16
B	C 215 (B,100 ,64)	CKSRYB102K50	C 420 (A,79 ,19) CKSRYB104K16
	C 216 (A,99 ,64)	CKSRYB102K50	C 424 (B,73 ,24) CKSRYB104K16
	C 217 (B,73 ,45)	CEVW101M16	C 427 (A,30 ,44) CKSRYB104K16
	C 218 (B,77 ,49)	CKSRYB104K16	C 428 (A,19 ,44) CEVW101M16
	C 219 (B,94 ,52)	CKSRYB104K16	
	C 220 (B,94 ,49)	CKSRYB104K16	
	C 221 (B,94 ,51)	CKSRYB104K16	
	C 222 (A,88 ,46)	CKSRYB104K16	
	C 223 (B,99 ,46)	CKSRYB104K16	
	C 224 (B,100 ,46)	CKSRYB104K16	
	C 225 (A,101 ,40)	CKSRYB104K16	
C	C 226 (A,110 ,41)	CKSRYB104K16	
	C 232 (B,133 ,51)	CEVW101M16	
	C 235 (B,131 ,56)	CKSRYB104K16	
	C 241 (B,71 ,63)	CKSRYB104K16	
	C 242 (B,120 ,61)	CCSRCH221J50	
	C 243 (B,120 ,53)	CCSRCH221J50	
	C 244 (B,120 ,63)	CKSRYB105K6R3	
	C 245 (B,120 ,56)	CKSRYB105K6R3	
	C 246 (A,138 ,48)	CKSRYB104K16	
	C 247 (A,138 ,47)	CKSRYB104K16	
	C 248 (A,85 ,64)	CKSRYB104K16	
D	C 249 (B,95 ,56)	CKSRYB104K16	
	C 301 (B,86 ,16)	CKSRYB104K16	
	C 302 (B,85 ,24)	CKSRYB104K16	
	C 303 (B,85 ,30)	CKSRYB104K16	
	C 304 (B,75 ,33)	CEVW101M16	
	C 305 (B,80 ,32)	CKSRYB104K16	
	C 309 (A,87 ,31)	CKSRYB104K16	
	C 310 (A,87 ,32)	CKSRYB102K50	
	C 311 (B,93 ,39)	CKSRYB104K16	
	C 315 (B,103 ,40)	CKSRYB104K16	
	C 316 (B,113 ,37)	CKSRYB104K16	
E	C 317 (B,115 ,26)	CKSRYB104K16	
	C 318 (B,115 ,24)	CKSRYB104K16	
	C 319 (B,114 ,20)	CKSRYB104K16	
	C 320 (A,99 ,15)	CKSRYB104K16	
	C 321 (B,132 ,44)	CEVW101M16	
	C 322 (B,133 ,25)	CKSRYB104K16	
	C 323 (B,133 ,18)	CKSRYB104K16	
	C 324 (B,117 ,21)	CKSRYB102K50	
	C 325 (B,123 ,38)	CKSRYB104K16	
	C 326 (A,120 ,30)	CKSRYB105K6R3	
F	C 327 (A,113 ,28)	CKSRYB104K16	
	C 328 (A,120 ,27)	CKSRYB474K10	
	C 329 (A,120 ,28) ELECT. CAPACITOR	DCH1201	
	C 330 (A,120 ,23)	CKSRYB472K50	
	C 333 (A,122 ,16)	CKSRYB104K16	
			IC 101 (A,56 ,65) HDMI RECEIVER SII9031CTU
			IC 151 (A,25 ,63) EEPROM BR24L02FV-W
			IC 152 (A,32 ,83) LOGIC IC SN74CBT3306CPW
			IC 161 (A,33 ,40) LOGIC(MULTIPLEXER) SN74LV4052APW
			IC 171 (A,34 ,63) EEPROM BR24L02FV-W
			IC 172 (A,24 ,40) LOGIC IC SN74CBT3306CPW
			IC 201 (A,79 ,40) IC SN74LVC541APW
			IC 301 (A,52 ,29) HDMI TRANSMITTER SII9030CTU
			IC 401 (A,139 ,75) VIDEO DECODER IC ADV7400AKSTZ-80
			IC 452 (A,108 ,83) IC SN74LVC541APW
			IC 453 (A,115 ,73) IC SN74LVC541APW
			IC 454 (A,110 ,68) LOGIC IC SN74LVC1G125DCK
			IC 501 (B,91 ,69) CPU PEG118A
			IC 502 (A,91 ,68) FLASH ROM AYW7078
			IC FLASH MEMORY(4M) MBM29LV400TC-70PFTN
			IC 504 (A,96 ,50) LOGIC IC SN74LV125APW
			IC 601 (A,156 ,38) VIDEO FILTER IC FMS6403MTC
			IC 602 (B,159 ,34) VIDEO SW IC MM1503XN
			IC 701 (A,133 ,44) VIDEO ENCODER IC ADV7172KSTZ
			IC 801 (B,144 ,41) DVD VIDEO AMP IC MM1623BF
			⚠ IC 901 (B,103 ,39) REGULATOR IC BD7802FP
			⚠ IC 902 (B,93 ,37) IC NJM2885DL1-18
			⚠ IC 903 (B,113 ,39) REGULATOR IC BD7802FP
			⚠ IC 904 (B,122 ,55) REGULATOR IC MM1561JF
			⚠ IC 911 (B,70 ,38) REGULATOR IC PQ200WNA1ZPH
			Q 101 (A,61 ,84) NMOS FET TRANSISTOR UM6K1N
			Q 151 (A,19 ,87) CHIP TRANSISTOR DTC114YUA
			Q 152 (B,28 ,83) CHIP TRANSISTOR DTC114YUA
			Q 153 (A,29 ,63) NMOS FET TRANSISTOR UM6K1N
			Q 171 (A,19 ,65) CHIP TRANSISTOR DTC114YUA
			Q 172 (B,25 ,42) CHIP TRANSISTOR DTC114YUA
			Q 173 (A,28 ,42) NMOS FET TRANSISTOR UM6K1N
			Q 351 (B,28 ,33) CHIP TR (PNP X 2) UMB1N
			Q 352 (B,31 ,29) CHIP TRANSISTOR DTC114YUA
			Q 353 (A,28 ,15) NMOS FET TRANSISTOR UM6K1N
			Q 911 (A,82 ,50) TRANSISTOR 2SA1576A
			Q 912 (B,78 ,30) TRANSISTOR RT1N241M
			Q 913 (B,83 ,30) CHIP TRANSISTOR DTC114YUA
			D 151 (B,24 ,80) DIODE DAN202U

**AG** HDMI&DVC ASSY  
**MISCELLANEOUS**



5		6		7		8	
Mark No.	Description	Part No.	Mark No.	Description	Part No.		
D 171	(B,24 ,54 ) DIODE	DAN202U	R 134	(A,58 ,83 )	RS1/16S103J		
D 381	(A,37 ,21 ) DIODE	UDZS5R1(B)	R 135	(A,65 ,83 )	RS1/16S103J		
			R 136	(A,58 ,86 )	RS1/16S103J		
D 551	(A,84 ,54 ) CHIP DIODE	RB501V-40	R 137	(A,64 ,86 )	RS1/16S104J		A
L 101	(A,70 ,88 ) CHIP BEADS	ATL7010					
L 103	(A,85 ,83 ) CHIP BEADS	ATL7010	R 138	(A,57 ,83 )	RS1/16S104J		
L 104	(A,39 ,90 ) CHIP BEADS	ATL7010	R 151	(B,28 ,64 )	RS1/16S100J		
L 302	(B,53 ,25 ) CHIP BEADS	ATL7010	R 152	(B,26 ,64 )	RS1/16S100J		
			R 153	(B,24 ,64 )	RS1/16S101J		
L 304	(A,67 ,46 ) CHIP BEADS	ATL7010	R 154	(B,28 ,60 )	RS1/16S103J		
L 305	(A,44 ,42 ) CHIP BEADS	ATL7010					
△L 351	(A,26 ,24 ) COIL	ATH7022	R 155	(B,26 ,60 )	RS1/16S103J		
△L 352	(A,26 ,27 ) COIL	ATH7022	R 156	(B,24 ,60 )	RS1/16S103J		
△L 353	(A,26 ,30 ) COIL	ATH7022	R 157	(B,21 ,80 )	RS1/16S473J		
			R 158	(A,29 ,66 )	RS1/16S472J		
			R 159	(A,29 ,61 )	RS1/16S472J		
△L 354	(A,26 ,33 ) COIL	ATH7022					B
L 401	(A,118 ,81 ) CHIP BEADS	ATL7010	R 160	(B,33 ,84 )	RS1/16S103J		
L 402	(A,159 ,63 ) CHIP BEADS	ATL7010	R 161	(B,19 ,80 )	RS1/16S102J		
L 501	(A,82 ,86 ) CHIP BEADS	ATL7010	R 163	(B,48 ,81 )	RS1/16S473J		
L 701	(A,117 ,57 ) CHIP BEADS	ATL7010	R 164	(B,54 ,77 )	RS1/16S473J		
			R 165	(B,36 ,41 )	RS1/16S102J		
L 702	(A,149 ,41 ) CHIP BEADS	ATL7010					
X 101	(A,60 ,48 ) CRYSTAL RESONATOR	ASS7066	R 166	(B,37 ,46 )	RS1/16S102J		
X 401	(A,135 ,61 ) CRYSTAL RESONATOR	ASS7067	R 171	(B,38 ,64 )	RS1/16S100J		
X 501	(A,101 ,59 ) CERAMIC RESONATOR	XSS3004	R 172	(B,35 ,64 )	RS1/16S100J		
CN101	(A,16 ,77 ) HDMI CONNECTOR	AKN7040	R 173	(B,33 ,64 )	RS1/16S101J		
			R 174	(B,38 ,60 )	RS1/16S103J		
CN102	(A,16 ,54 ) HDMI CONNECTOR	AKN7040					
CN301	(A,16 ,31 ) HDMI CONNECTOR	AKN7040	R 175	(B,35 ,60 )	RS1/16S103J		C
CN501	(A,17 ,13 ) 07P CONNECTOR	RKN1048	R 176	(B,33 ,60 )	RS1/16S103J		
CN1001	(A,71 ,21 ) CONNECTOR	CKS4668	R 177	(B,18 ,43 )	RS1/16S473J		
CN1002	(A,103 ,21 ) CONNECTOR	CKS4668	R 178	(A,28 ,45 )	RS1/16S472J		
			R 179	(A,28 ,39 )	RS1/16S472J		
<b>RESISTORS</b>							
R 101	(A,52 ,83 ) RESISTOR ARRAY	RAB4CQ100J	R 181	(B,20 ,56 )	RS1/16S102J		
R 102	(A,67 ,80 ) RESISTOR ARRAY	RAB4CQ470J	R 201	(A,86 ,42 )	RS1/16S470J		
R 103	(A,50 ,79 )	RS1/16S100J	R 202	(A,86 ,40 )	RS1/16S470J		
R 104	(B,52 ,77 )	RS1/16S100J	R 203	(A,86 ,39 )	RS1/16S470J		
R 105	(A,47 ,79 )	RS1/16S103J	R 204	(A,84 ,35 ) RESISTOR ARRAY	RAB4CQ470J		
R 106	(A,49 ,79 )	RS1/16S103J					
R 107	(B,53 ,69 )	RS1/16S750J	R 205	(A,79 ,35 )	RS1/16S470J		
R 108	(B,56 ,69 )	RS1/16S750J	R 303	(B,57 ,39 )	RS1/16S100J		D
R 109	(B,58 ,69 )	RS1/16S750J	R 306	(B,47 ,39 )	RS1/16S101J		
R 111	(B,49 ,49 )	RS1/16S101J	R 312	(B,51 ,30 ) CHIP RESISTOR	RS1/16S4750F		
			R 313	(A,43 ,36 )	RS1/16S472J		
R 112	(B,51 ,53 )	RS1/16S470J					
R 113	(B,52 ,61 )	RS1/16S680J	R 314	(B,49 ,22 )	RS1/16S100J		
R 114	(B,62 ,53 )	RS1/16S472J	R 315	(B,45 ,22 )	RS1/16S100J		
R 115	(A,71 ,49 )	RS1/16S472J	R 316	(B,42 ,20 )	RS1/16S471J		
R 117	(B,53 ,53 )	RS1/16S330J	R 318	(B,56 ,21 )	RS1/16S472J		
			R 325	(B,59 ,26 )	RS1/16S330J		
R 118	(A,61 ,51 )	RS1/16S105J					
R 119	(A,67 ,49 )	RS1/16S471J	R 326	(A,48 ,39 )	RS1/16S100J		
R 120	(B,63 ,59 )	RS1/16S221J	R 327	(A,46 ,39 )	RS1/16S100J		
R 121	(A,67 ,50 )	RS1/16S221J	R 331	(A,60 ,42 ) RESISTOR ARRAY	RAB4CQ473J		E
R 122	(B,54 ,61 )	RS1/16S470J	R 332	(A,75 ,61 )	RS1/16S473J		
			R 333	(A,75 ,74 ) RESISTOR ARRAY	RAB4CQ473J		
R 123	(B,55 ,53 )	RS1/16S100J					
R 124	(A,58 ,51 )	RS1/16S152J	R 334	(A,75 ,71 ) RESISTOR ARRAY	RAB4CQ473J		
R 125	(A,52 ,46 ) RESISTOR ARRAY	RAB4CQ680J	R 335	(A,75 ,67 ) RESISTOR ARRAY	RAB4CQ473J		
R 126	(A,71 ,74 ) RESISTOR ARRAY	RAB4CQ680J	R 336	(A,75 ,64 ) RESISTOR ARRAY	RAB4CQ473J		
R 127	(A,71 ,71 ) RESISTOR ARRAY	RAB4CQ680J	R 337	(A,75 ,58 ) RESISTOR ARRAY	RAB4CQ473J		
			R 338	(A,75 ,55 ) RESISTOR ARRAY	RAB4CQ473J		
R 128	(A,71 ,67 ) RESISTOR ARRAY	RAB4CQ470J					
R 129	(A,71 ,64 ) RESISTOR ARRAY	RAB4CQ470J	R 351	(B,29 ,18 )	RS1/16S472J		
R 130	(A,71 ,58 ) RESISTOR ARRAY	RAB4CQ470J	R 352	(B,31 ,34 )	RS1/16S472J		
R 131	(A,71 ,55 ) RESISTOR ARRAY	RAB4CQ470J	R 353	(B,29 ,22 )	RS1/16S272J		F
R 132	(A,71 ,61 )	RS1/16S330J	R 354	(B,33 ,34 )	RS1/16S272J		
			R 355	(A,25 ,15 )	RS1/16S472J		
R 133	(A,65 ,86 )	RS1/16S103J					
			R 356	(A,31 ,15 )	RS1/16S472J		

	<b>Mark No.</b>	<b>Description</b>	<b>Part No.</b>	<b>Mark No.</b>	<b>Description</b>	<b>Part No.</b>
	R 386	(A,20 ,19 )	RS1/16S473J	R 546	(B,79 ,50 )	RS1/16S101J
	R 389	(B,21 ,11 )	RS1/16S102J	R 549	(B,80 ,57 )	RS1/16S473J
	R 403	(B,131 ,73 )	RS1/16S330J	R 551	(A,84 ,75 )	RS1/16S473J
A	R 404	(B,128 ,73 )	RS1/16S330J	R 561	(B,104 ,59 )	RS1/16S103J
	R 405	(A,125 ,71 )	RS1/16S330J	R 562	(B,111 ,59 )	RS1/16S103J
	R 406	(A,127 ,77 ) RESISTOR ARRAY	RAB4CQ470J	R 564	(B,104 ,55 )	RS1/16S103J
	R 407	(A,127 ,68 ) RESISTOR ARRAY	RAB4CQ560J	R 565	(B,111 ,50 )	RS1/16S103J
	R 408	(A,130 ,64 )	RS1/16S560J	R 566	(B,109 ,50 )	RS1/16S103J
	R 409	(A,130 ,63 )	RS1/16S560J	R 567	(B,104 ,50 )	RS1/16S103J
	R 410	(B,134 ,64 )	RS1/16S103J	R 568	(A,97 ,91 )	RS1/16S103J
	R 411	(B,137 ,64 )	RS1/16S100J	R 569	(A,79 ,60 )	RS1/16S103J
	R 412	(A,141 ,63 )	RS1/16S560J	R 571	(B,18 ,15 )	RS1/16S103J
	R 413	(A,143 ,63 )	RS1/16S560J	R 586	(B,113 ,73 )	RS1/16S103J
	R 414	(B,144 ,65 )	RS1/16S132J	R 588	(B,94 ,45 )	RS1/16S103J
B	R 415	(B,142 ,65 )	RS1/16S391J	R 594	(A,90 ,43 )	RS1/16S0R0J
	R 416	(A,137 ,64 )	RS1/16S105J	R 703	(A,128 ,38 )	RS1/16S103J
	R 417	(A,134 ,64 )	RS1/16S101J	R 704	(A,128 ,35 )	RS1/16S103J
	R 418	(B,142 ,72 )	RS1/16S272J	R 705	(A,130 ,36 )	RS1/16S103J
	R 419	(B,140 ,72 )	RS1/16S272J	R 706	(A,132 ,36 )	RS1/16S103J
	R 420	(A,148 ,66 )	RS1/16S103J	R 707	(A,138 ,36 )	RS1/16S1201F
	R 423	(A,140 ,87 )	RS1/16S330J	R 708	(A,138 ,34 )	RS1/16S1201F
	R 424	(A,141 ,87 )	RS1/16S330J	R 709	(A,135 ,36 )	RS1/16S470J
	R 425	(B,137 ,83 )	RS1/16S103J	R 710	(A,136 ,36 )	RS1/16S470J
	R 426	(B,145 ,85 )	RS1/16S471J	R 714	(A,138 ,53 )	RS1/16S470J
C	R 428	(A,136 ,87 ) RESISTOR ARRAY	RAB4CQ470J	R 715	(A,127 ,52 )	RS1/16S470J
	R 451	(A,104 ,65 )	RS1/16S330J	R 716	(A,131 ,54 )	RS1/16S471J
	R 452	(A,102 ,81 ) RESISTOR ARRAY	RAB4CQ680J	R 717	(A,137 ,53 )	RS1/16S103J
	R 453	(A,102 ,84 ) RESISTOR ARRAY	RAB4CQ680J	R 718	(A,143 ,56 )	RS1/16S1201F
	R 454	(A,109 ,73 ) RESISTOR ARRAY	RAB4CQ680J	R 719	(A,143 ,57 )	RS1/16S1201F
	R 455	(A,109 ,76 ) RESISTOR ARRAY	RAB4CQ680J	R 720	(A,130 ,55 )	RS1/16S103J
	R 456	(A,122 ,75 ) RESISTOR ARRAY	RAB4CQ473J	R 722	(A,130 ,57 )	RS1/16S103J
	R 457	(A,122 ,71 ) RESISTOR ARRAY	RAB4CQ473J	R 733	(A,142 ,52 )	RS1/16S1500F
	R 458	(A,115 ,84 ) RESISTOR ARRAY	RAB4CQ473J	R 734	(A,145 ,52 )	RS1/16S0R0J
	R 459	(A,115 ,81 ) RESISTOR ARRAY	RAB4CQ473J	R 737	(A,142 ,48 )	RS1/16S1500F
	R 460	(A,117 ,61 ) RESISTOR ARRAY	RAB4CQ473J	R 738	(A,145 ,48 )	RS1/16S0R0J
D	R 491	(B,154 ,61 )	RS1/10S0R0J	R 741	(A,142 ,45 )	RS1/16S1500F
	R 492	(B,151 ,61 )	RS1/10S0R0J	R 742	(A,145 ,45 )	RS1/16S0R0J
	R 506	(A,104 ,57 )	RS1/16S221J	R 745	(A,142 ,43 )	RS1/16S1500F
	R 508	(B,102 ,59 )	RS1/16S472J	R 746	(A,145 ,43 )	RS1/16S0R0J
	R 511	(B,111 ,55 )	RS1/16S101J	R 749	(A,143 ,38 )	RS1/16S1500F
	R 517	(B,99 ,50 )	RS1/16S101J	R 750	(A,143 ,35 )	RS1/16S0R0J
	R 520	(A,103 ,54 )	RS1/16S103J	R 753	(A,141 ,38 )	RS1/16S1500F
	R 524	(B,91 ,50 )	RS1/16S100J	R 754	(A,141 ,35 )	RS1/16S0R0J
	R 525	(B,89 ,50 )	RS1/16S100J	R 802	(B,145 ,57 )	RS1/16S103J
	R 526	(B,86 ,50 )	RS1/16S100J	R 811	(B,138 ,28 )	RS1/10S75R0F
E	R 527	(B,84 ,50 )	RS1/16S100J	R 812	(B,141 ,28 )	RS1/10S75R0F
	R 528	(B,70 ,50 )	RS1/16S470J	R 813	(B,135 ,28 )	RS1/10S75R0F
	R 529	(B,77 ,57 )	RS1/16S473J	R 814	(B,144 ,28 )	RS1/10S75R0F
	R 530	(B,91 ,45 )	RS1/16S222J	R 815	(B,147 ,28 )	RS1/10S75R0F
	R 531	(B,89 ,45 )	RS1/16S222J	R 816	(B,150 ,28 )	RS1/10S75R0F
	R 533	(B,87 ,45 )	RS1/16S472J	R 911	(A,78 ,48 )	RS1/10S6R8J
	R 534	(B,81 ,50 )	RS1/16S472J	R 912	(A,78 ,50 )	RS1/10S6R8J
	R 537	(B,110 ,71 )	RS1/16S101J	R 914	(B,80 ,33 )	RS1/16S103J
	R 538	(B,111 ,75 )	RS1/16S101J	R 915	(B,68 ,28 )	RS1/16S2001F
	R 539	(B,107 ,79 )	RS1/16S101J	R 916	(B,70 ,28 )	RS1/16S1801F
	R 540	(A,101 ,49 )	RS1/16S470J	R 918	(A,80 ,48 )	RS1/16S102J
F	R 541	(A,90 ,49 )	RS1/16S103J	R 919	(B,80 ,29 )	RS1/16S103J
	R 542	(A,90 ,50 )	RS1/16S470J	R 1001	(A,107 ,32 )	RS1/10S0R0J
	R 543	(A,90 ,53 )	RS1/16S472J	R 1002	(A,95 ,33 )	RS1/10S100J
	R 544	(A,90 ,52 )	RS1/16S470J	R 1003	(A,149 ,26 )	RS1/10S0R0J

5		6		7		8	
Mark No.	Description	Part No.	Mark No.	Description	Part No.		
R 1004(A,149 ,28)		RS1/10S0R0J	C 302 (A,51 ,39)		CKSRYP104K16		
R 1102(A,68 ,84)		RS1/10S0R0J	C 303 (A,49 ,39)		CKSRYP104K16		
R 1105(A,43 ,79)		RS1/10S0R0J	C 304 (B,49 ,26)		CKSRYP104K16		
R 1107(B,60 ,53)		RS1/16S0R0J	C 305 (B,53 ,30)		CKSRYP105K10		A
			C 308 (B,49 ,30)		CKSRYP104K16		
R 1108(B,61 ,59)		RS1/16S0R0J	C 311 (B,45 ,35)		CKSRYP104K16		
R 1301(B,43 ,35)		RS1/10S0R0J	C 312 (A,58 ,20)		CKSRYP105K10		
R 1403(A,142 ,91)		RS1/10S0R0J	C 313 (B,51 ,22)		CKSRYP104K16		
R 1404(A,146 ,63)		RS1/10S0R0J	C 314 (A,50 ,20)		CKSRYP104K16		
			C 315 (B,40 ,20)		CKSRYP103K50		
<b>CAPACITORS</b>							
C 101 (A,46 ,79)		CKSRYP105K10	C 316 (A,67 ,41)		CEVW101M16		
C 102 (A,52 ,79)		CKSRYP104K16	C 317 (A,39 ,42)		CEVW101M16		
C 103 (A,54 ,79)		CKSRYP104K16	C 318 (B,56 ,30)		CKSRYP105K10		
C 104 (A,55 ,79)		CKSRYP104K16	C 319 (B,59 ,32)		CKSRYP104K16		
C 105 (A,57 ,80)		CKSRYP104K16	C 351 (B,20 ,33)		CKSRYP104K16		B
C 106 (A,58 ,80)		CKSRYP104K16	C 391 (A,39 ,37)		CKSRYP104K16		
C 107 (A,60 ,80)		CKSRYP104K16	C 392 (A,42 ,49)		CKSRYP103K50		
C 109 (A,63 ,80)		CKSRYP104K16	C 401 (A,122 ,82)		CEVW101M16		
C 110 (A,64 ,80)		CKSRYP104K16	C 402 (A,127 ,80)		CKSRYP104K16		
C 112 (A,76 ,89)		CEVW101M16	C 403 (A,127 ,75)		CKSRYP104K16		
C 115 (A,80 ,81)		CEVW101M16	C 404 (A,127 ,72)		CKSRYP104K16		
C 116 (B,46 ,74)		CKSRYP105K10	C 405 (A,139 ,63)		CKSRYP104K16		
C 117 (A,43 ,77)		CKSRYP105K10	C 406 (A,145 ,64)		CKSRYP104K16		
C 118 (B,49 ,70)		CKSRYP104K16	C 407 (B,146 ,65)	CHIP CAPACITOR	CKSRYP8823K25		
C 119 (B,46 ,70)		CKSRYP104K16	C 408 (B,139 ,65)		CKSRYP103K50		C
C 120 (B,49 ,66)		CKSRYP104K16	C 409 (A,133 ,58)		CCSRCH100D50		
C 121 (B,46 ,66)		CKSRYP105K10	C 410 (A,137 ,58)		CCSRCH8R0D50		
C 122 (B,49 ,60)		CKSRYP104K16	C 411 (A,144 ,87)		CKSRYP104K16		
C 123 (B,45 ,60)		CKSRYP104K16	C 412 (A,143 ,87)		CKSRYP102K50		
C 124 (B,45 ,56)		CKSRYP104K16	C 413 (B,141 ,81)		CKSRYP104K16		
C 125 (A,39 ,84)		CEVW101M16	C 415 (B,141 ,77)		CKSRYP104K16		
C 126 (A,46 ,50)		CKSRYP104K16	C 417 (B,147 ,77)		CKSRYP103K50		
C 127 (A,47 ,50)		CKSRYP104K16	C 418 (B,149 ,77)		CKSRYP104K16		
C 128 (A,49 ,50)		CKSRYP104K16	C 419 (B,152 ,76)	ELECT. CAPACITOR	DCH1201		
C 129 (A,68 ,53)		CKSRYP104K16	C 420 (B,154 ,74)		CKSRYP104K16		
C 130 (A,52 ,50)		CKSRYP104K16	C 421 (A,150 ,75)		CKSRYP104K16		D
C 131 (A,54 ,50)		CKSRYP104K16	C 422 (A,154 ,74)		CKSRYP104K16		
C 132 (A,56 ,50)		CKSRYP104K16	C 423 (A,150 ,73)		CKSRYP104K16		
C 133 (B,58 ,53)		CKSRYP104K16	C 424 (B,147 ,73)		CKSRYP103K50		
C 134 (B,58 ,59)		CKSRYP104K16	C 425 (B,149 ,73)		CKSRYP104K16		
C 135 (A,67 ,47)		CKSRYP103K50	C 426 (B,152 ,71)	ELECT. CAPACITOR	DCH1201		
C 136 (A,65 ,51)		CKSRYP103K50	C 427 (B,154 ,70)		CKSRYP104K16		
C 137 (A,58 ,45)		CCSRCH120J50	C 434 (A,150 ,80)		CEVW100M16		
C 138 (A,61 ,45)		CCSRCH100D50	C 435 (A,158 ,74)		CEVW100M16		
C 139 (B,67 ,72)		CKSRYP104K16	C 436 (A,154 ,68)		CEVW101M16		
C 140 (B,67 ,68)		CKSRYP104K16	C 437 (B,147 ,85)		CKSRYP103K50		E
C 141 (B,69 ,68)		CKSRYP104K16	C 438 (A,138 ,87)		CKSRYP104K16		
C 142 (B,67 ,63)		CKSRYP104K16	C 439 (A,149 ,88)		CEVW101M16		
C 143 (B,66 ,59)		CKSRYP104K16	C 452 (A,107 ,78)		CKSRYP104K16		
C 144 (A,64 ,83)		CKSRYP103K50	C 453 (A,115 ,69)		CKSRYP104K16		
C 145 (A,57 ,86)		CKSRYP103K50	C 454 (A,112 ,67)		CKSRYP104K16		
C 151 (A,22 ,65)		CKSRYP104K16	C 501 (A,104 ,59)		CKSRYP103K50		
C 153 (A,33 ,86)		CKSRYP104K16	C 502 (A,99 ,63)		CKSRYP104K16		
C 161 (A,31 ,45)		CKSRYP104K16	C 503 (A,89 ,89)		CEVW101M16		
C 171 (A,32 ,64)		CKSRYP104K16	C 505 (B,105 ,79)		CKSRYP104K16		
C 173 (A,23 ,45)		CKSRYP104K16	C 506 (B,80 ,78)		CKSRYP104K16		
C 191 (A,49 ,47)		CKSRYP104K16	C 507 (A,95 ,47)		CKSRYP104K16		
C 192 (A,44 ,82)		CKSRYP103K50	C 551 (A,91 ,80)		CKSRYP104K16		F
C 201 (A,80 ,44)		CKSRYP104K16	C 552 (A,92 ,55)		CKSRYP104K16		
C 301 (A,57 ,39)		CKSRYP104K16	C 571 (A,22 ,11)		CKSRYP104K16		

**Mark No. Description****Part No.****6. ADJUSTMENT**

There is no information to be shown in this chapter.

A	C 601 (A,151 ,41 )	CKSRYB104K16
	C 602 (A,152 ,46)	CEVW101M16
	C 603 (A,152 ,30)	CKSRYB104K16
	C 604 (A,154 ,30)	CKSRYB104K16
	C 605 (A,155 ,30)	CKSRYB104K16
	C 606 (A,158 ,30)	CKSRYB104K16
	C 607 (A,160 ,30)	CKSRYB104K16
	C 608 (B,160 ,39)	CKSRYB104K16
	C 609 (B,160 ,28)	CKSRYB105K10
	C 610 (B,158 ,28)	CKSRYB105K10
B	C 611 (A,160 ,37)	CKSRYB104K16
	C 701 (A,126 ,49)	CKSRYB104K16
	C 702 (A,126 ,40)	CKSRYB104K16
	C 703 (A,123 ,58)	CEVW101M16
	C 704 (A,138 ,37)	CKSRYB104K16
	C 705 (A,133 ,36)	CKSRYB104K16
	C 706 (A,142 ,53)	CKSRYB104K16
	C 707 (A,142 ,50)	CKSRYB104K16
	C 708 (A,142 ,46)	CKSRYB104K16
	C 709 (A,142 ,41)	CKSRYB104K16
C	C 710 (A,147 ,34)	CEVW101M16
	C 711 (A,132 ,52)	CKSRYB103K50
	C 712 (A,142 ,54)	CKSRYB104K16
	C 713 (A,128 ,52)	CKSRYB104K16
	C 714 (A,148 ,39)	CKSRYB105K10
	C 801 (A,152 ,53)	CEVW101M16
	C 802 (B,133 ,39)	CKSRYB104K16
	C 804 (B,135 ,53)	CKSRYB104K16
	C 805 (B,138 ,53)	CKSRYB105K10
	C 806 (B,140 ,53)	CKSRYB105K10
	C 807 (B,143 ,53)	CKSRYB104K16
	C 808 (B,147 ,53)	CKSRYB105K10
	C 809 (B,150 ,53)	CKSRYB104K16
	C 810 (B,152 ,53)	CKSRYB104K16
	C 811 (A,152 ,60)	CEVW101M16
D	C 901 (B,105 ,30)	CKSRYB105K10
	C 902 (B,101 ,30)	CKSQYB225K10
	C 904 (B,97 ,30)	CKSRYB105K10
	C 905 (B,88 ,33) CHIP CERAMIC C.	DCG1028
	C 907 (B,118 ,34)	CKSRYB105K10
	C 908 (B,109 ,30)	CKSQYB225K10
	C 910 (B,117 ,57)	CKSRYB105K10
	C 911 (B,117 ,52)	CCSRCH471J50
	C 912 (B,122 ,48)	CKSQYB225K10
	C 915 (B,75 ,29)	CKSRYB224K16
E	C 916 (B,75 ,33)	CKSQYB105K16
	C 917 (B,65 ,39)	CKSRYB104K16
	C 918 (A,72 ,33)	CEVW101M16
	C 1001(A,100 ,27)	CKSRYB104K16
	C 1002(A,101 ,31)	CEVW101M16

**• FM/AM TUNER MODULE**

FM/AM TUNER MODULE has no service parts.

F

# 7. GENERAL INFORMATION

## 7.1 DIAGNOSIS

### 7.1.1 TEST MODE

#### Specifications of Test Mode Functions

The following codes for the remote control unit are accepted only in Test mode.

No.	Item	Remote Control Unit Code	Description (External Specification)	FL Display	Internal specification
1	Test mode ON	Simultaneously press and hold the STANDARD SURROUND and ENTER keys on the front panel of the main unit for 5 sec.	<p>To enter Test mode</p> <p><b>Note:</b> When Test mode is entered, all the user settings will return to default (settings at shipment).</p> <p><b>Settings of the product when Test mode is entered:</b>                      Input Function: CD                      Signal Select: AUTO                      Listening mode: 7CHSTEREO                      SPEAKER SYSTEM: ALL LARGE &amp; SW YES                      TUNER: Designated preset setting: 9k step model                      BASS/TREBLE: Each to MAX (+6 dB)                      OPTICAL 1 → DVD/LD                      OPTICAL 2 → TV                      OPTICAL 3 → SAT                      OPTICAL 4 → VCR/DVR 1                      COAX 1 → CD                      COAX 2 → CD-R/TAPE                      COMPONENT 1 → DVD/LD                      COMPONENT 2 → TV                      COMPONENT 3 → SAT                      D-Terminal 1 → DVR/VCR 1                      D-Terminal 2 → DVR/VCR 2                      12V Trigger 1 of DVD: ON                      12V Trigger 2 of TV: ON                      12V Trigger 1 and 2 of SAT: ON                      12V Trigger of other inputs: OFF                      ROOM 2 and ROOM 3: ON                      Other settings: Those at shipment</p>	"M0.501 F0.501" (Version)	Display duration: 5 sec
2	Test mode OFF	STANDBY/ON key: OFF	Settings: The settings will return to those at shipment. Be sure to exit Test mode by setting the STANDBY/ON key to OFF, because exiting Test mode by disconnecting the AC cord does not assure resetting to those default settings. Disconnect the AC cord only after the power ON LED goes dark.		
3	Confirmation of FL and LED indications	A55F+A500	Each time this code for the remote control unit is accepted, the following actions are repeated: All LEDs and segments on the FL display lit -> all LEDs and segments on the FL display unlit -> LEDs for Pattern 1, ISOPHASE, DPP, iLINK (DVC) lit -> LEDs for Pattern 2, MCACC, and HDMI lit -> "TEST MODE" indicated on the FL display lit -> all LEDs and segments on the FL display lit -> ...	All segments lit All segments unlit "ABCDEFGHJKLMN" "NOPQRSTUVWXYZ" "TEST MODE"	Display duration: KEEP
4	FAN ON/OFF	A55F+A507	Each time this code for the remote control unit is accepted, the fan is turned on or off, repeatedly.	"TEST FAN ON" "TEST FAN OFF"	Display duration: KEEP
5	Microphone input check	A55F+A508	Outputting the microphone input signal from PREOUT. Set the Signal Select to ANALOG. When the keys are pressed again, the previous status will be restored.	"TEST MIC ON" "TEST MIC OFF"	Display duration: KEEP
6	Version indication (SBchPROCESSING key)	A59F+A5D4	The version indication will be displayed each time the keys are pressed.	(Version indication)	

## Version indication

### [Purpose]

The versions for various microcomputers are displayed.

### [How to enter/exit]

During Standby mode, simultaneously press and hold the STANDBY/ON and STANDARD SURROUND keys for 5 seconds to enter this mode. This mode is automatically exited when the indications of all versions have finished.

### [Basic operations]

FL Display	Description of Version Indications	Duration (sec.)	Devices that can be considered generally normal, with the corresponding indications
POWER OFF ↓ M1.000 F1.000 ↓ D1.000 H1.000 ↓ HOST 00 ↓ f1.000 s1.000 ↓ Normal display	Mx.xxx : Main microcomputer Fx.xxx : Display microcomputer	5	Main microcomputer and display microcomputer
	Dx.xxx : DSP microcomputer Hx.xxx : HDMI microcomputer	5	DSP microcomputer and HDMI microcomputer
	HOST microcomputer	5	HOST microcomputer for iLINK connection
	fx.xxx : 1st DSP firmware sx.xxx : 2nd DSP firmware	5	1st DSP: Flash ROM (IC105) near the DSP IC 2nd DSP: Flash ROM (IC201) within the DSP IC

### [Notes]

1. If the version indication becomes "\*\*\*," a failure in communications between the corresponding microcomputers or a failure in the corresponding microcomputers is likely.
2. In this submode, the user settings will not be cleared.

## ■ Indication of the number of detected protection processes

### [Purpose]

The numbers of detections of various protection processes are displayed.

### [How to enter/exit]

During Standby mode, simultaneously press and hold the ADVANCED SURROUND and "↑" (TUNE +) keys for 5 seconds to enter this mode. This mode is automatically exited when all the indications have finished.

### [Basic operations]

FL Display	Description of Indications	Duration (sec.)
POWER OFF ↓ DC : 000	Number of DC detections	3
↓ OVER: 010	Number of overload detections	3
↓ CON : 002	Number of detections of cord disconnection (DC and OL DET line) (simultaneous detections of DC and OVERLOAD)	3
↓ FAN : 002	Number of detections of fan abnormalities	3
↓ TEMP: 255	Number of detections of abnormal temperature	3
↓ Normal display		

### [Description]

When the keys are pressed, the numbers of DC detections, overload detections, detections of cord disconnection (simultaneous detection of DC and OVERLOAD), detections of fan abnormalities, and detections of abnormal temperature are displayed for 3 seconds each, in that order.  
The maximum value of detections is 255.

## ■ Error indications when an abnormality in the amplifier system is detected

### [Purpose]

An error message is displayed when an abnormality in the amplifier system is detected.

### [Basic operations]

FL Display	Status	Duration (sec.)
AMP ERROR	When AMP DC is detected	Flashes 3 times.
FAN STOP	When stopping of the fan is detected	Flashes 3 times.
OVERHEAT	When a thermal shutdown (abnormal temperature), etc. is detected	Flashes 3 times.
12V TRG ERR	When the 12-V trigger circuit is short-circuited	Flashes

### [Description]

**AMP ERROR** : After a failure in the amplifier or high DC output is detected, the shutdown process starts, then the power will be shut off. Then the MCACC LED will flash. The power cannot be turned on again. If you wish to turn on the unit after a shutdown activated by DC detection, enter Test mode, by proceeding with the steps described in "How to enter Test mode" below.

**FAN STOP** : The fan does not function.

**OVERHEAT** : The temperature of the amplifier is abnormally high.

**12V TRG ERR** : The 12-V trigger output is short-circuited.

After a failure is detected, the shutdown process starts, then the power will be off. The power can be turned on again in Normal mode.

### [How to enter Test mode]

未定（初校時に入れる）



● Protection Circuit Process List

Item	Purpose	Detection Method	Process	Warning Indication	Remarks
DC detection	To detect amplifier damage (defect status) A process to protect speakers (for protection of connected external devices)	Detects when the DC_PROTECT port becomes "L". (Pin 120 of IC101)	Turns muting on and speaker relay off, then turns off the power after 3 seconds. Then flashes MCACC indicator.	Flashing "AMP ERR" for 3 seconds.	Once detected and turned the power off, input a key never again. If the DC_DET port becomes "L" within 3 seconds, the unit resets automatically.
AMP overload	To detect overloading (abnormal status) With low-load driving or a short circuit of the speaker terminals (for protection of the amplifier)	Detects when the OL_DET port becomes "L" (checks by interrupt). (Pin 28 of IC101)	Turns muting on and speaker relay off, and immediately turns off the power. Then flashes PHASE CONTROL indicator.	None	
Overheat detection	Self reset type protection feature by temperature-rise of heat sink	Detects when the TEMP2 port becomes "H". (Pin 44 of IC3201)	Turns muting on and speaker relay off, then turns off the power after 3 seconds.	Flashing "OVERHEAT" for 3 seconds.	If the TEMP2 port becomes "L" within 3 seconds, the unit resets automatically.
12V trigger failure detection	To detect the shortcircuit of 12V trigger output (load more than 50mA) (for protection of the amplifier)	Detects when the 12VDET port becomes "H". (Pin 41 of IC3201)	Turns 12V trigger output to off.	Flashing "12V TRG ERR" for 3 seconds.	Continue showing warning. Release the FL indication by switching the INPUT SEL or the turns the power off.

● DC Detection Circuit

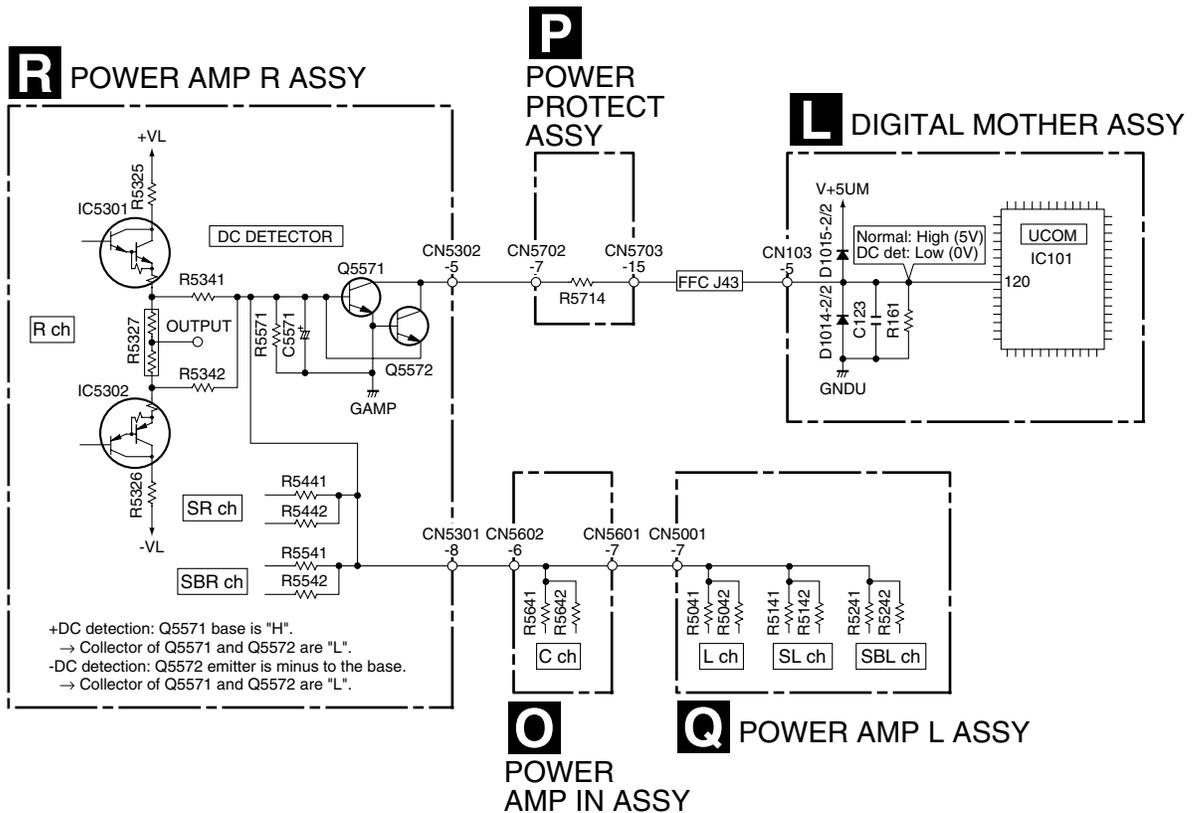

# ● OL (Over Load) Detection Circuit

A

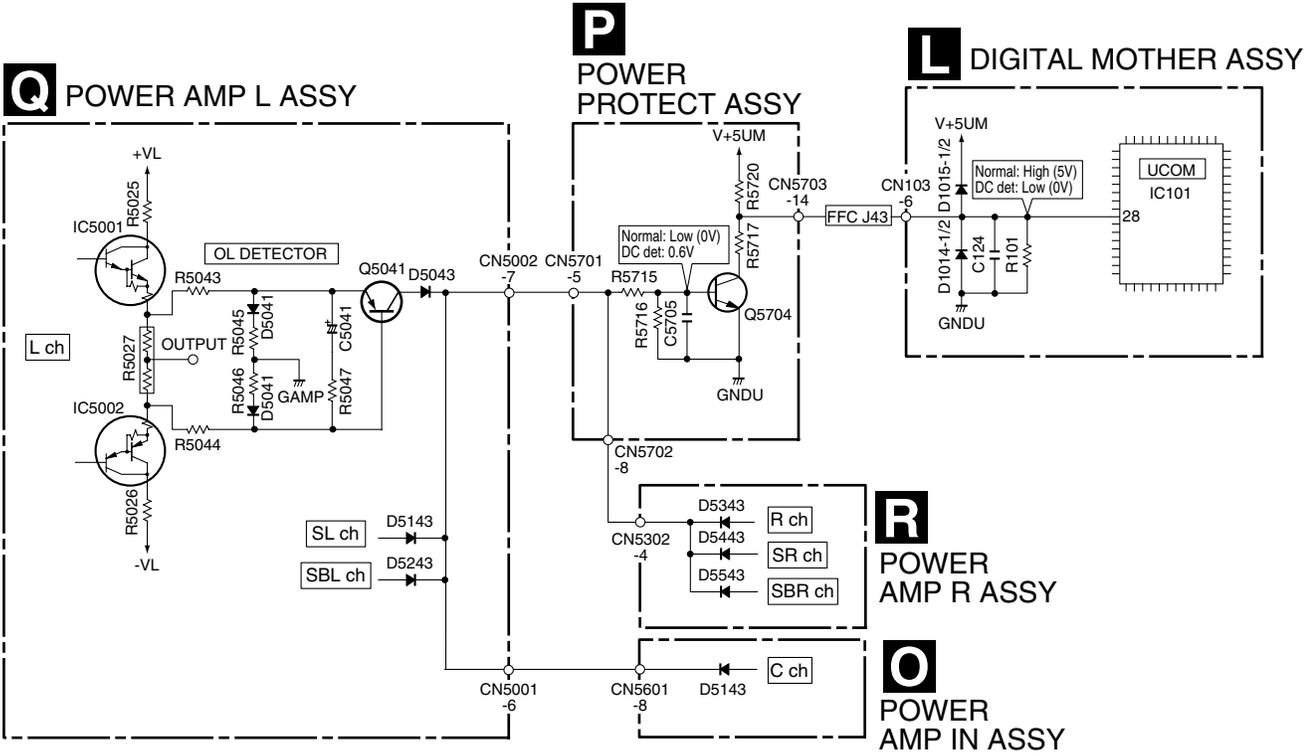

B

C

D

E

F

## 7.1.3 TROUBLESHOOTING THE DSP BLOCK

### ■ Simplified diagnosis

Herein is described how to easily diagnose a defective part in the DSP Assy, only with operations of the main unit.

- Is the DSP Assy a cause of the problem?  
Input a digital PCM signal (CD, etc.) and check if the sound is output, by switching AUTO SURR/STREAM DIRECT.  
If the sound is output in PURE DIRECT (PCM DIRECT) mode but not in AUTO SURR or DIRECT mode, the DSP Assy may be defective.
- If the sound is not output when Sound Delay is ON  
If the sound is output without a problem when Sound Delay is OFF (0.0 fr) but an abnormality in the sound is detected when Sound Delay is ON (0.1 - 6.0 fr), it is most likely that SRAM (IC106) or DECODER IC (IC104) in the 1st DSP block is in failure.

### ■ Troubleshooting

- It is assumed that there is no loose connection or damage in the LCRs.
- Refer to "DSP Block Diagram."

#### Step 1: Connections

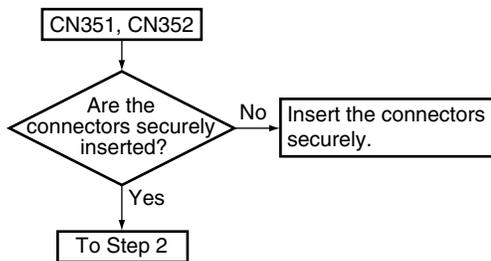

#### Step 2: Power supply

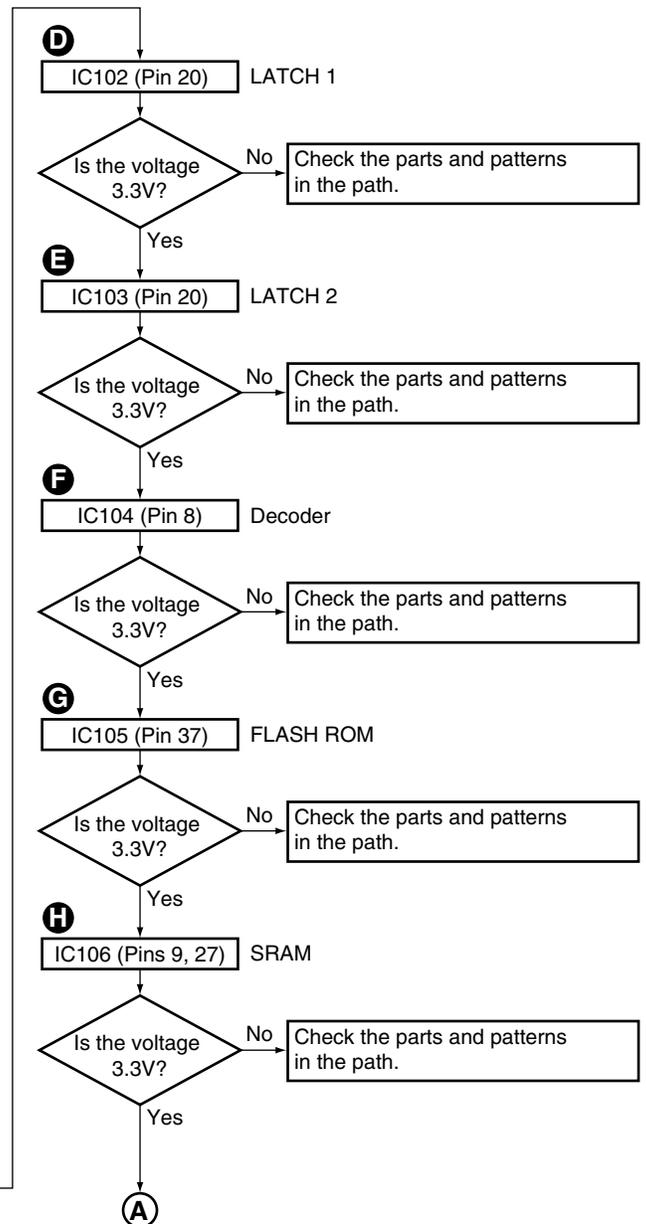
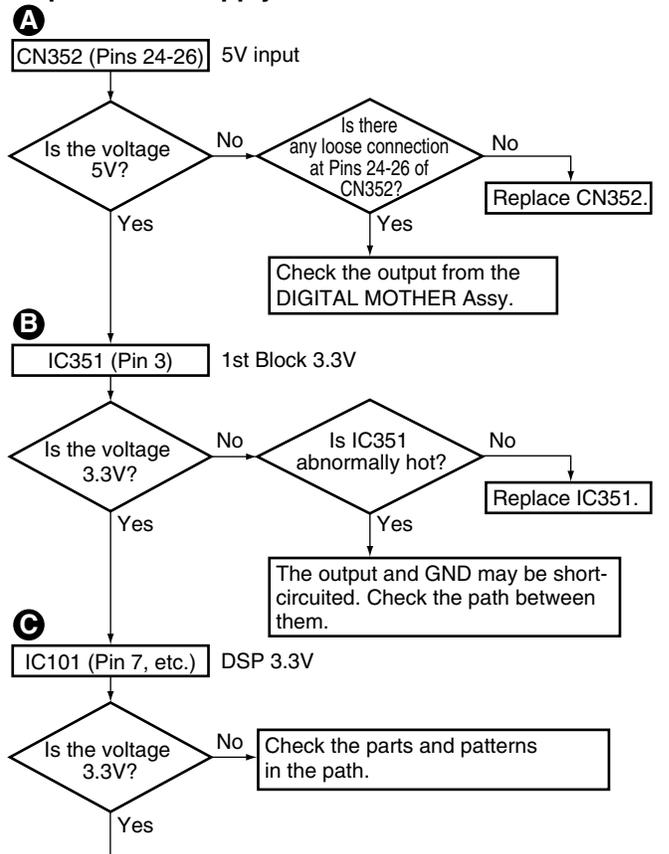

A  
B  
C  
D  
E  
F

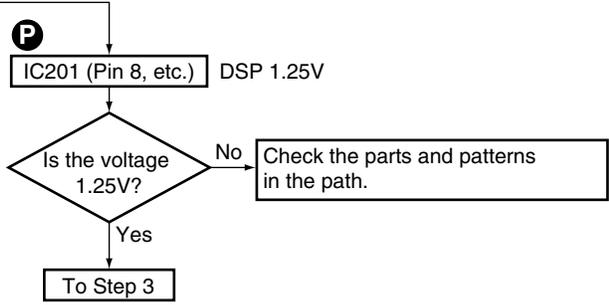
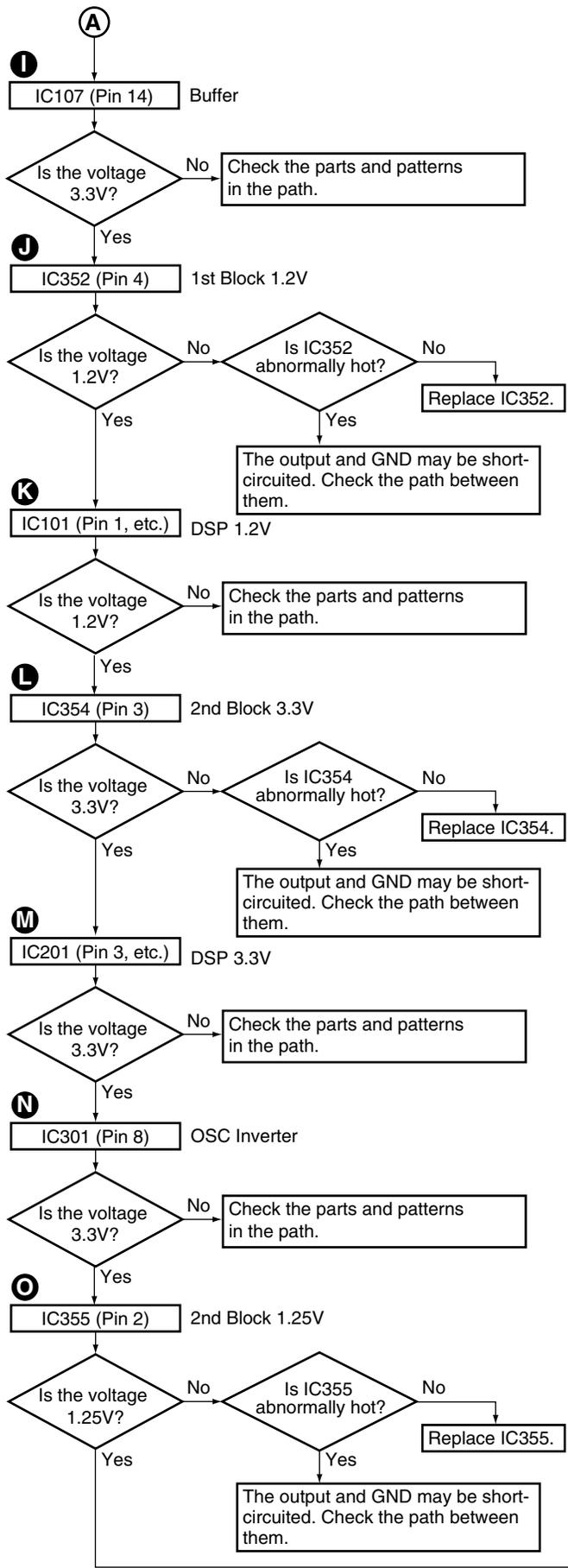

### Step 3: Operation of the Master Clock

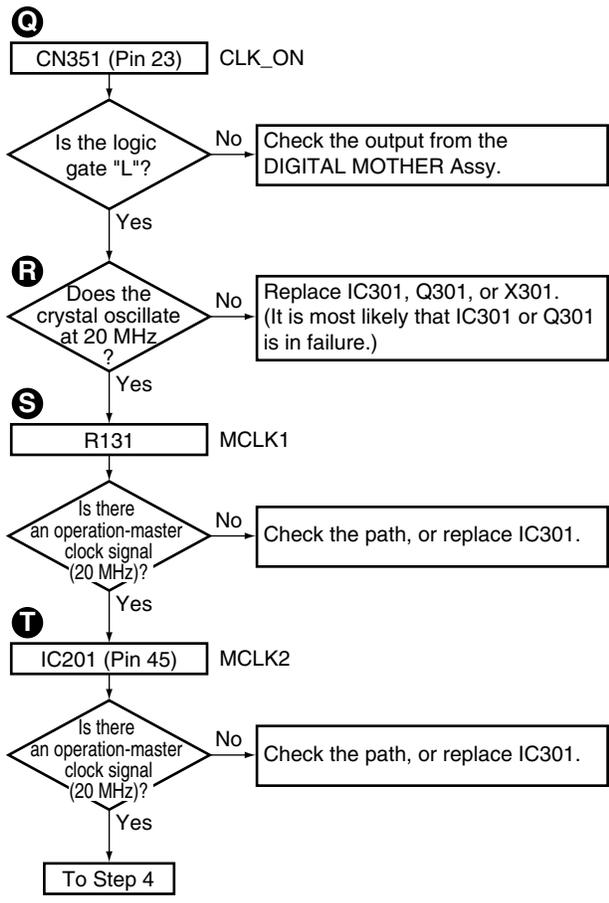

### Step 4: Audio Clock

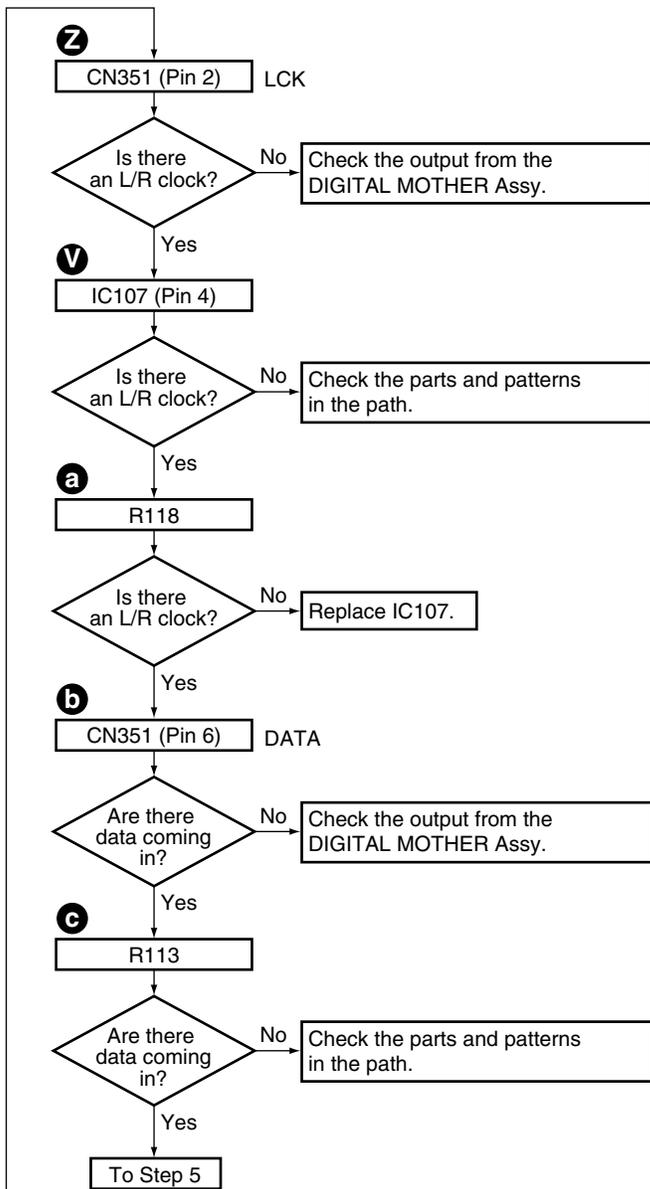
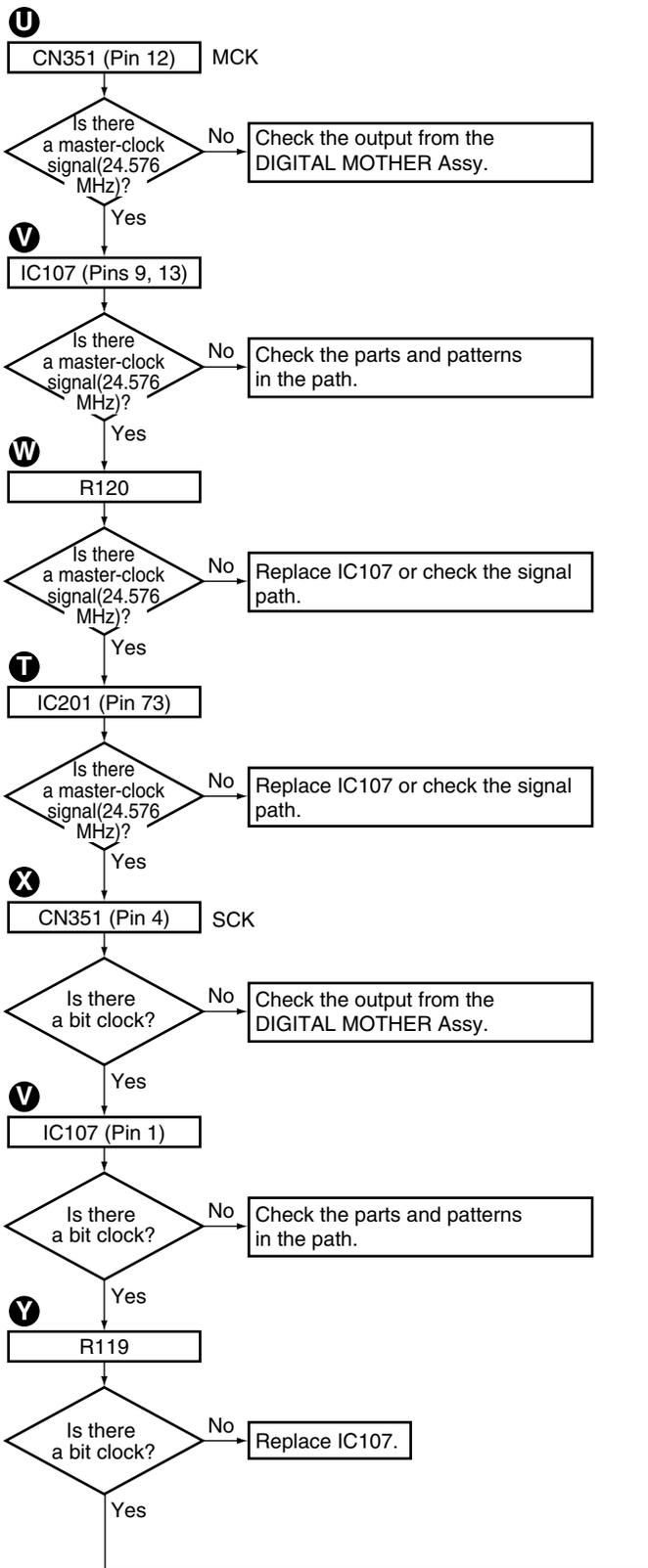

A  
B  
C  
D  
E  
F

### Step 5

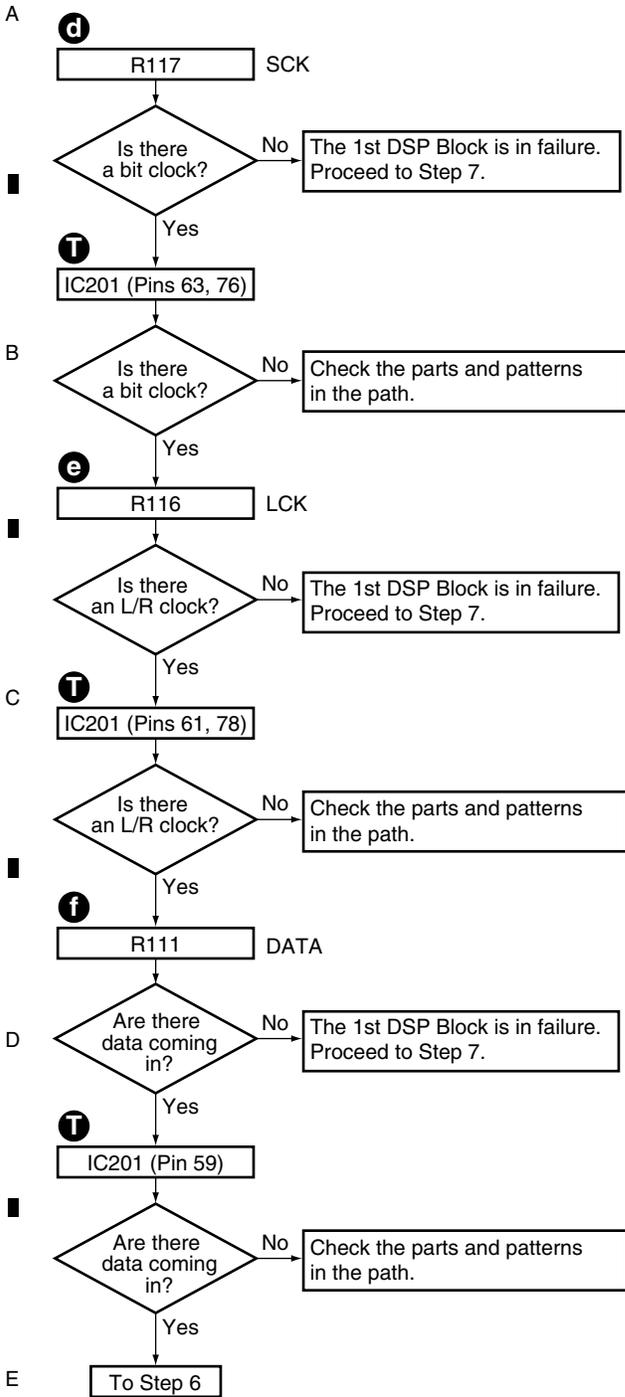

### Step 6

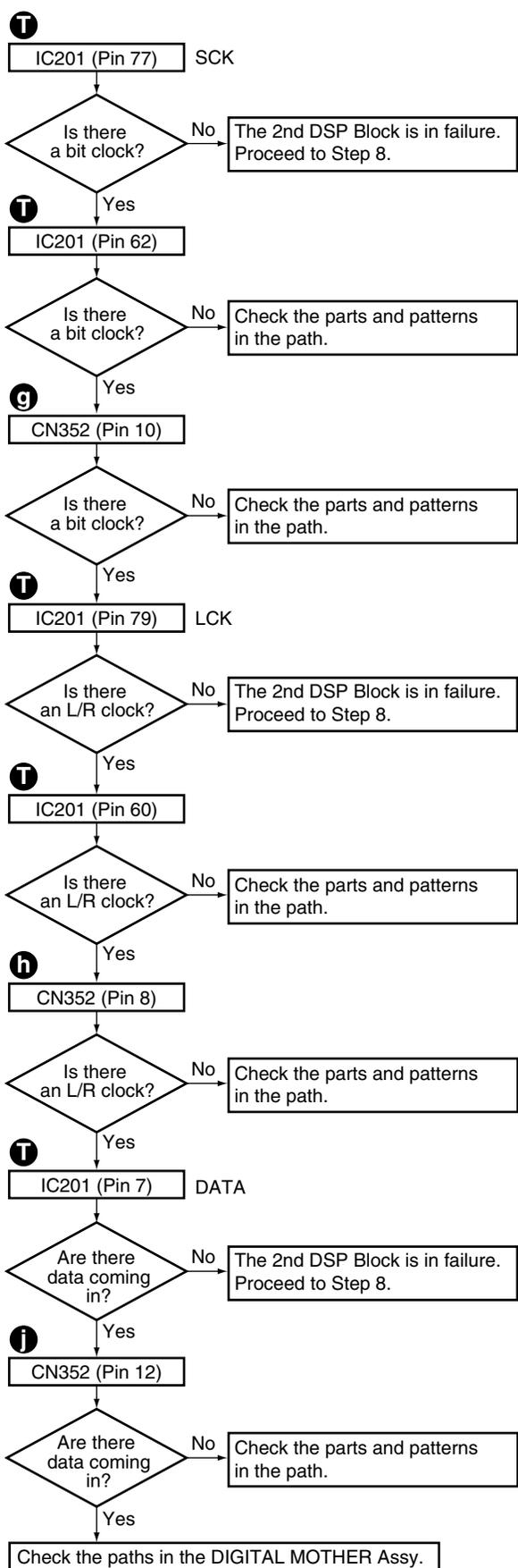

### Step 7: 1st DSP

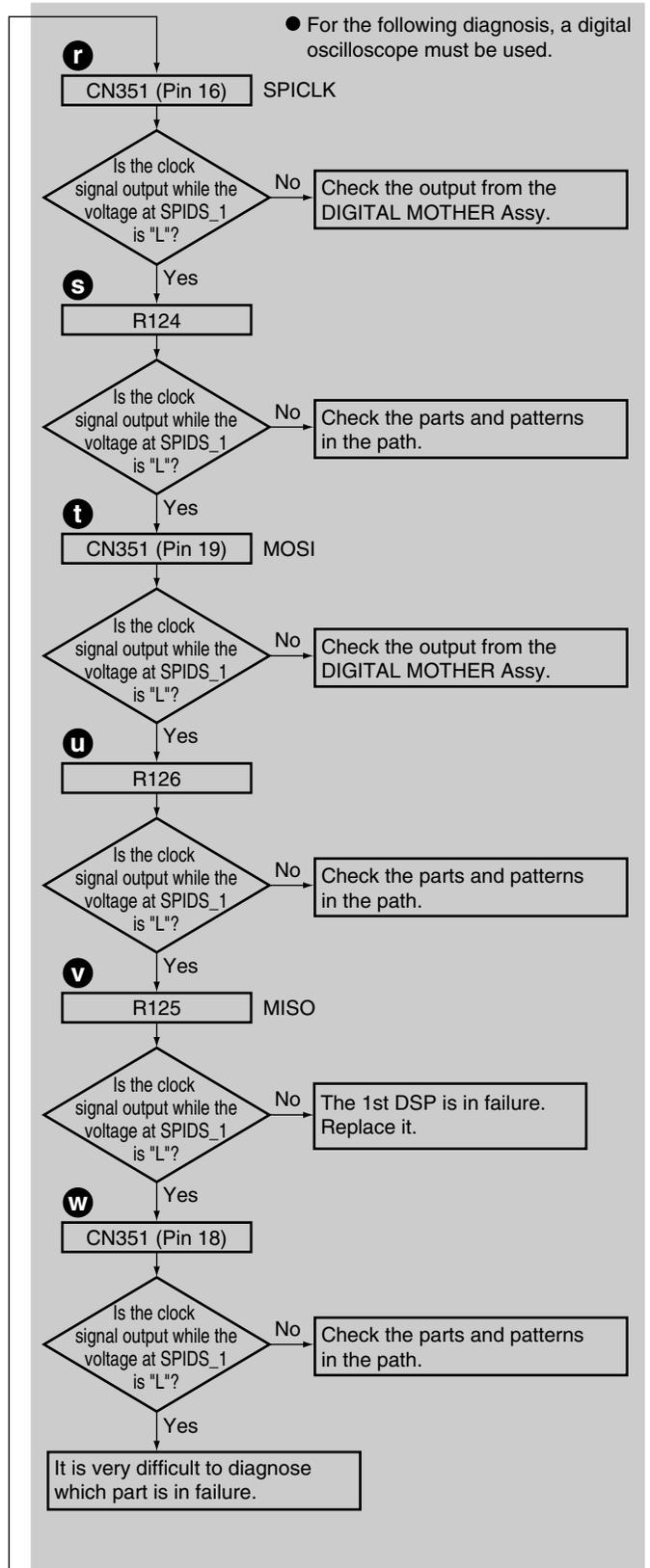
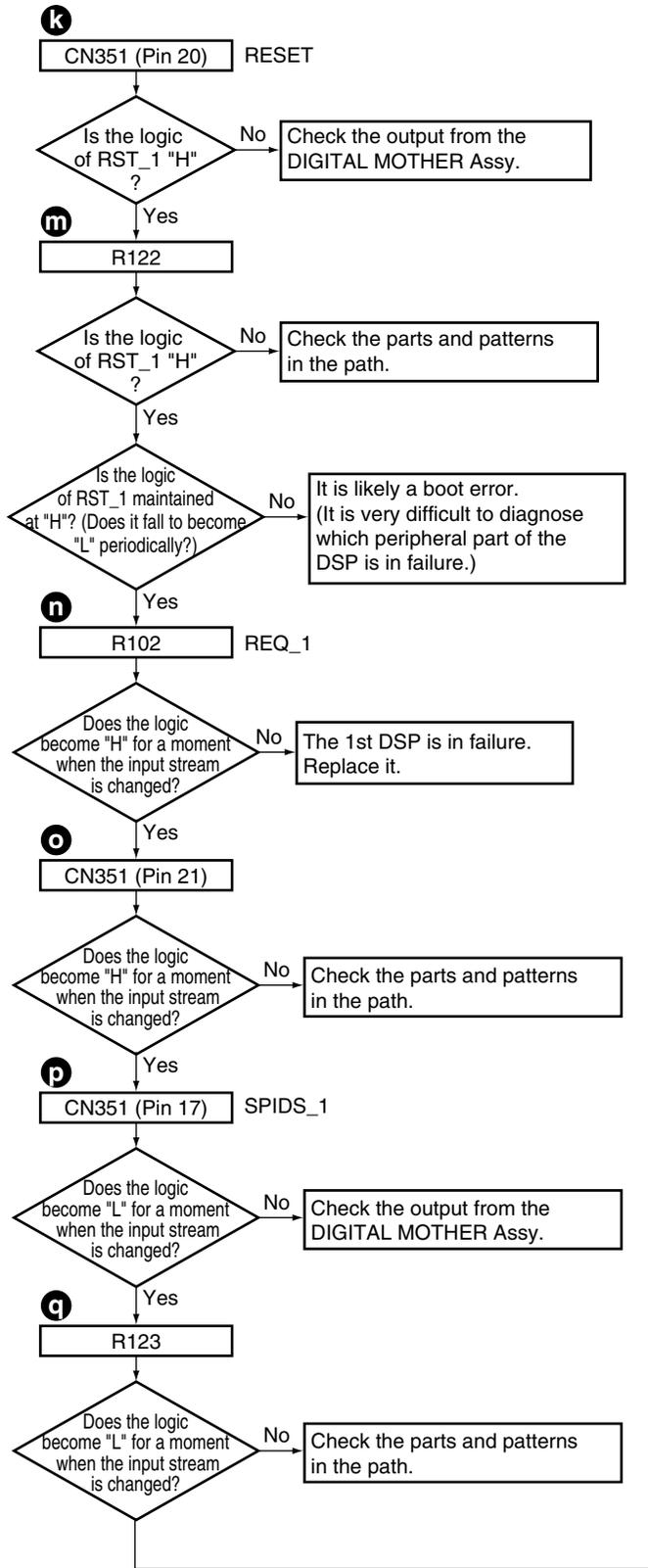

A  
B  
C  
D  
E  
F

### Step 8: 2nd DSP

A

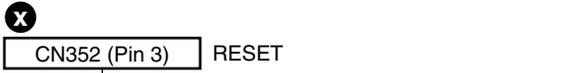

B

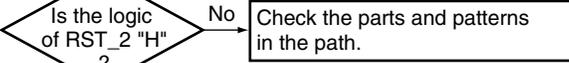

C



D

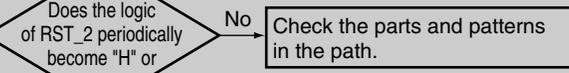

E

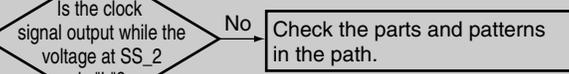

F

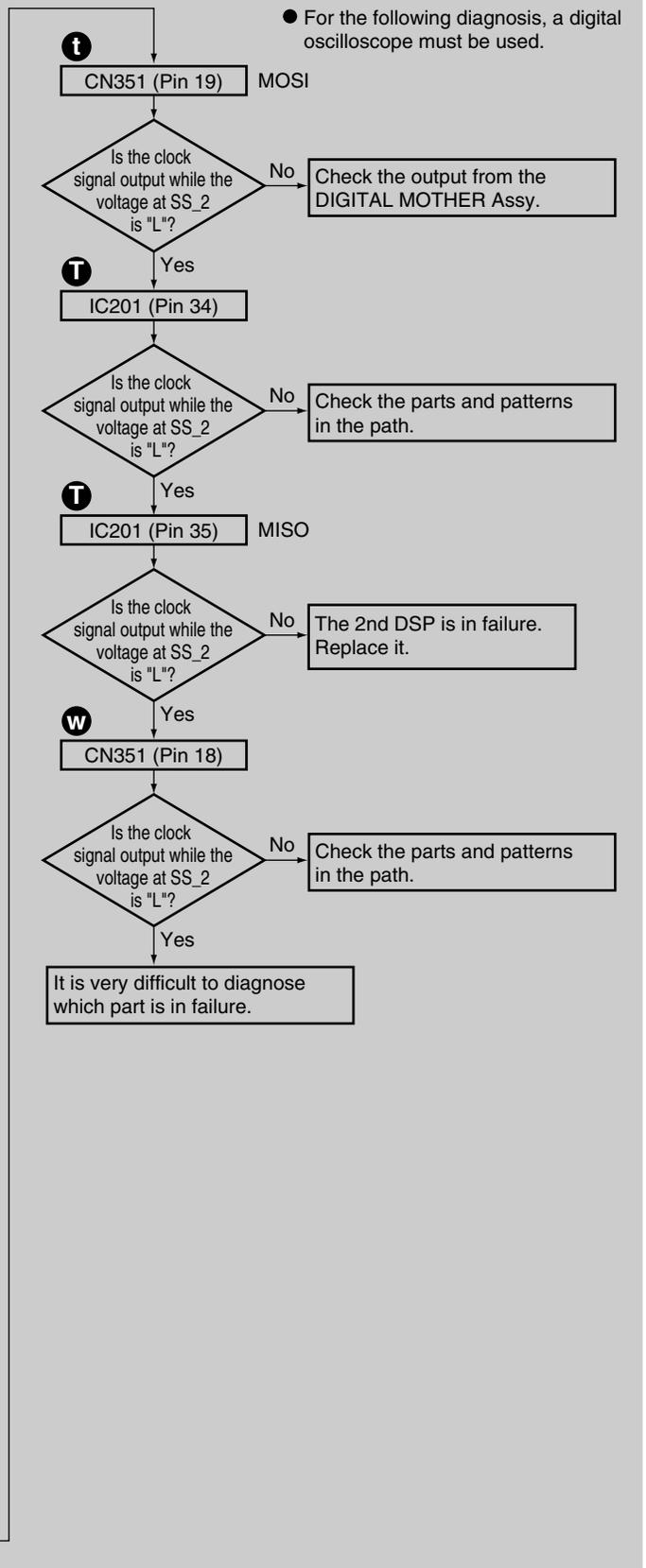



■ **DSP Block Diagram**  
 • **CORE Block**

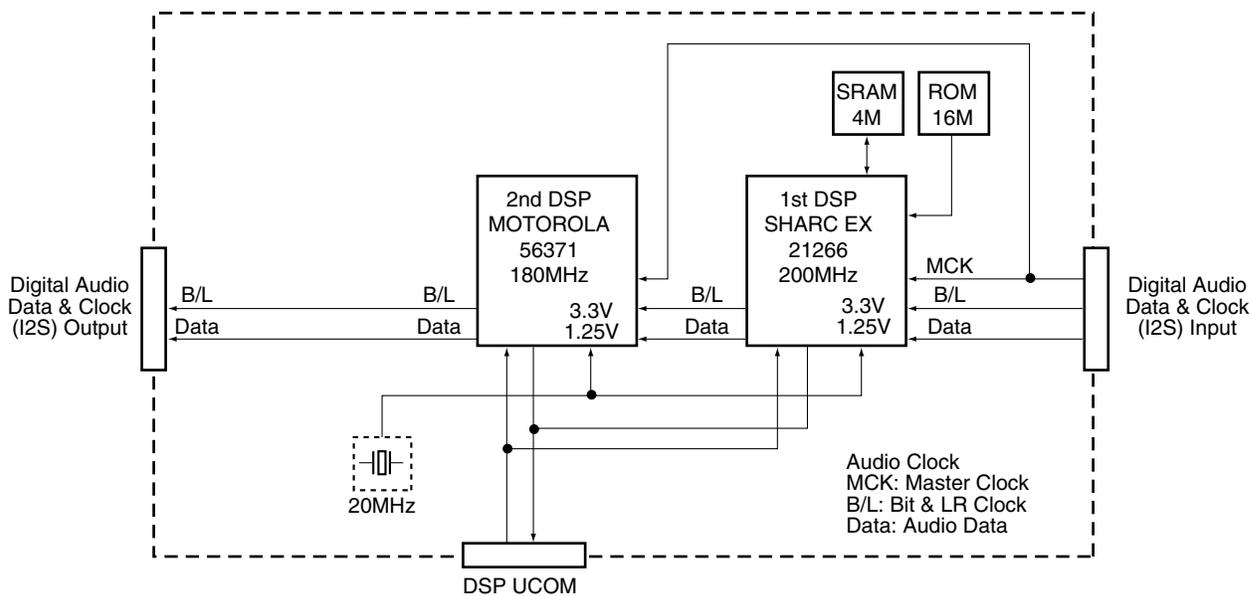

• **Power Block and GND Map**

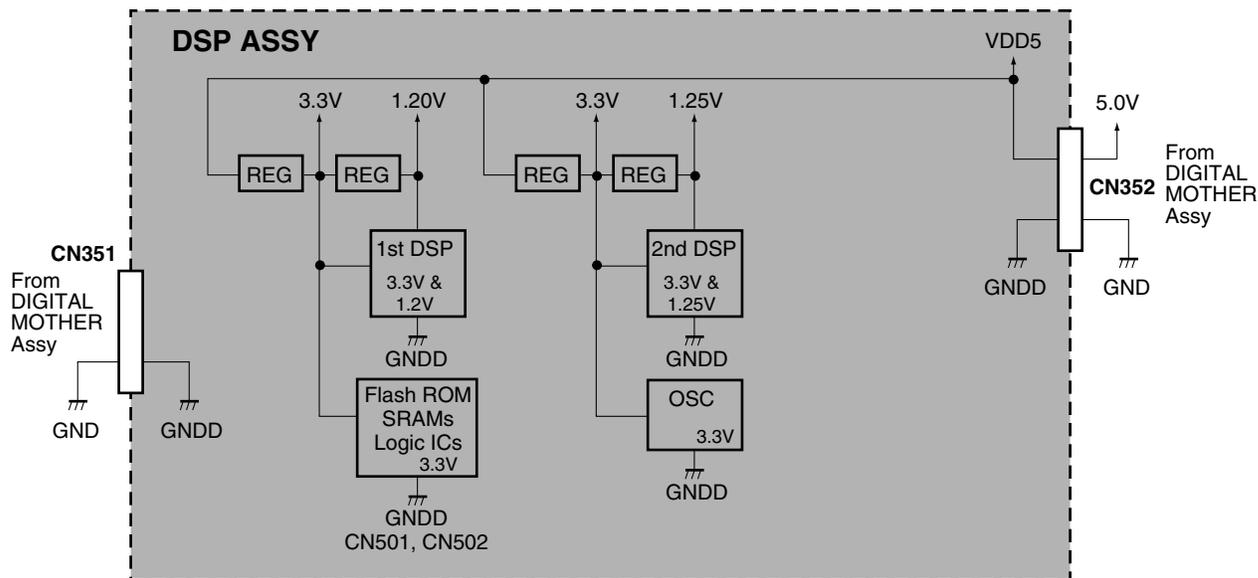

■ : Shows internal ground (GNDD)

# DSP Assy Check Points

A

B

C

D

E

F

**M** DSP ASSY **SIDE B**

**T f c e d J Y K**



### HDMI Simple Diagnosis

Please refer to the one point trouble shooting first before checking the flow chart below.

#### HDMI

Symptom	Remedy
The HDMI indicator blinks continuously.	Check all the points below.
No picture or sound.	<ul style="list-style-type: none"> <li>This receiver is HDCP-compatible. Check that the components you are connecting are also HDCP-compatible. If they are not, please connect them using the component, S-video or composite video jacks.</li> <li>Depending on the connected source component, it is possible that it will not work with this receiver (even if it is HDCP-compatible).</li> <li>If the problem still persists when connecting your HDMI component directly to your monitor, please consult the component or monitor manual or contact the manufacturer for support.</li> </ul>
No picture.	<ul style="list-style-type: none"> <li>If your display device is not SD (480i) compatible then neither the setup screens or the 480i to HDMI converted video will be displayed. In this case, connect using the component, S-video or composite video jacks.</li> <li>Depending in the output settings of the source component, it may be outputting a video format that can't be displayed. Change the output settings of the source, or connect using the component, S-video or composite jacks.</li> </ul>
No sound, or sound suddenly ceases.	<ul style="list-style-type: none"> <li>Check that the HDMI AV setting is set to <b>AMP/THROUGH</b>.</li> <li>If the component is a DVI device, use a separate connection for the audio.</li> <li>If analog video is being output over HDMI then there will be no HDMI audio output. Please use a separate connection for the audio.</li> <li>Check the audio output settings of the source component.</li> </ul>

#### Note:

- An HDMI connection can only be made with DVI-equipped components compatible with both DVI and High Bandwidth Digital Content Protection (HDCP). If you choose to connect to a DVI connector, you will need a separate adaptor (DVI → HDMI) to do so. A DVI connection, however, does not support audio signals. Consult your local audio dealer for more information.
  - This unit has been designed to be compliant with HDMI (High Definition Multimedia Interface) Version 1.1. Depending on the component you have connected, using a DVI connection may result in unreliable signal transfers. Also, when using a component with HDMI version 1.0, it is not possible to output copy-controlled DVD-Audio CPPM sources from the HDMI connection.
  - SACD playback is not possible when using the HDMI connection.
- To see this receiver's on-screen display, monitors (or projectors) must be compatible with 480i resolution digital video.

#### Digital Video Converting System

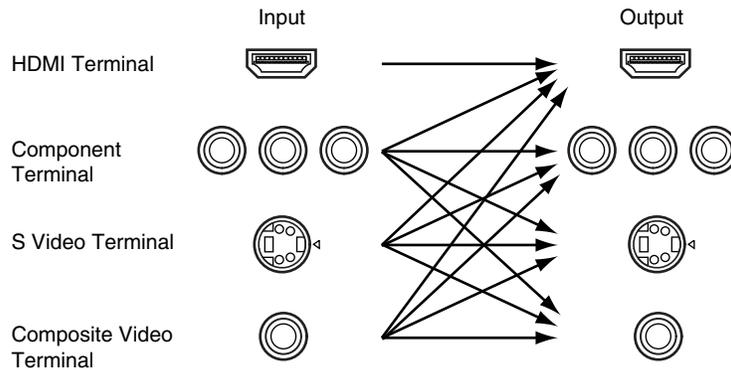

Note: Down converting for component signal is limited with contents with macro vision.

#### HDMI Audio Pass

Input		Output
HDMI	→	HDMI
		Pre out
		SP Out

# Flowchart of troubleshooting the HDMI block

A

No video or audio output from the equipment supporting HDMI (in a case of HDMI input/output)

When a player supporting HDMI is directly connected to a monitor supporting HDMI (with an HDMI cable) is there any abnormality?

No (no abnormality)

The player or monitor supporting HDMI (or the HDMI cable) may be defective. Or there may be wrong settings of some equipment.

B

Yes (abnormality exists)

Check whether HDMI authentication has been completed between the player supporting HDMI and this unit according to the HDMI indicator on the front panel:  
Lit: Authentication OK  
Flashing: Authentication in progress  
Unlit: Authentication failed

NG (unlit or flashing continuously)

C

OK

Check with other input sources:  
Video input (composite, component)  
Audio input (analog, digital)

NG

D

In a case of a failure in the audio system, input a signal from the HDMI input then check it at the SP output.

OK

Not the HDMI block, but either the DSP block or the analog line is defective, and which is defective must be judged:  
• See "7.1.4 Troubleshooting the DSP Block."  
• Check the analog line.  
See "3. How to diagnose the product with the Power Amp Block removed" in "7.1.11 DISASSEMBLY."

Diagnose the unit by referring to the sections on how to diagnose and troubleshoot the HDMI block, described on the subsequent pages.

E

F

## ■ Preparations for diagnosis of the HDMI block and related systems

How to diagnose the HDMI audio/video input/output of this unit is explained here.

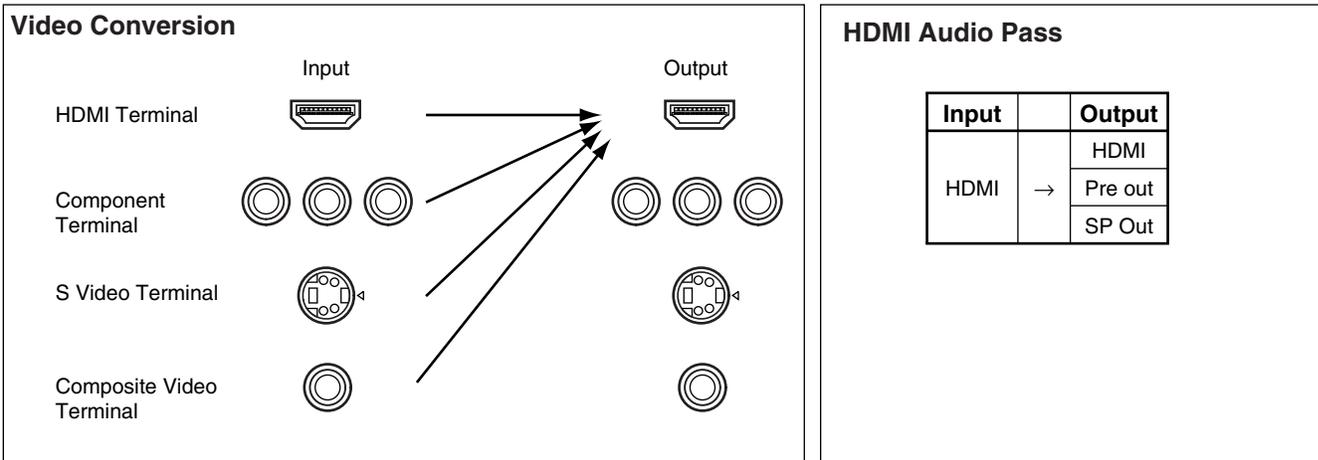

### [Procedures]

Remove the following parts and the PCB Assy, referring to "7.1.11 DISASSEMBLY."

- Power Amp Block (\*1)
- Rear Panel
- Shield Case
- COMPONENT & VOL Assy
- V-AUDIO Assy
- AUDIO & MULTI CH IN Assy
- PREOUT & CONTROL Assy

(\*1) Follow the steps described in "3. How to diagnose the product with the Power Amp Block removed" in "7.1.11 Removal of Each Block." After diagnosis, be sure to remove the solder used for short-circuiting.

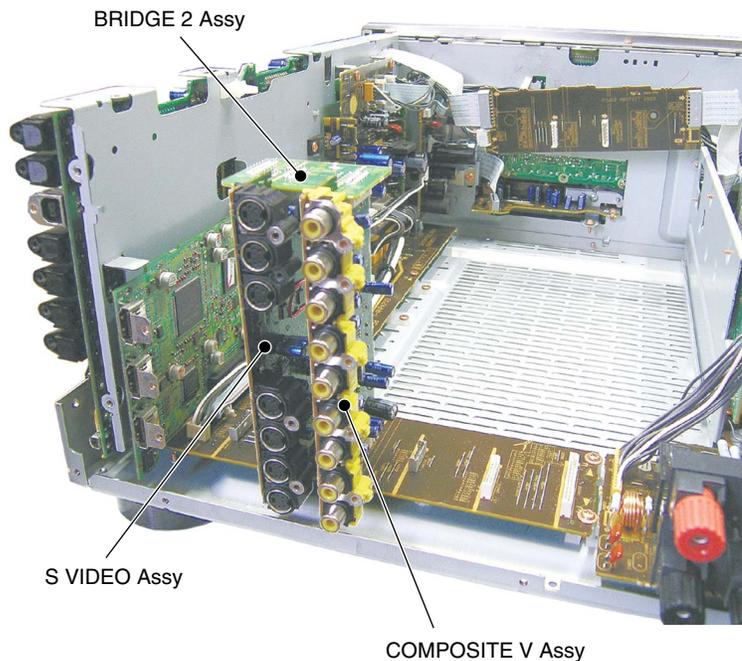

State after all the above-mentioned assys have been removed

## ■ Diagnosis of the video and audio lines between HDMI input and HDMI output

How to diagnose the video and audio lines between HDMI input and HDMI output is explained here.

### [Procedures]

1. Make the preparations described in "Preparations for diagnosis of the HDMI block and related systems" on the previous page.
2. Remove the COMPOSITE V Assy and S VIDEO Assy.
3. Connect between the HDMI connector and the chassis, as indicated in the photo below. \*1
4. Connect the signal from the source equipment (DVD player, etc.) to HDMI IN 1 or HDMI IN 2.
5. Connect between HDMI OUT and a TV monitor.
6. Set the INPUT SEL switch to HDMI function (for the connected HDMI).

\*1: Be sure to connect between the HDMI connector and the chassis. Otherwise, operations will be unstable.

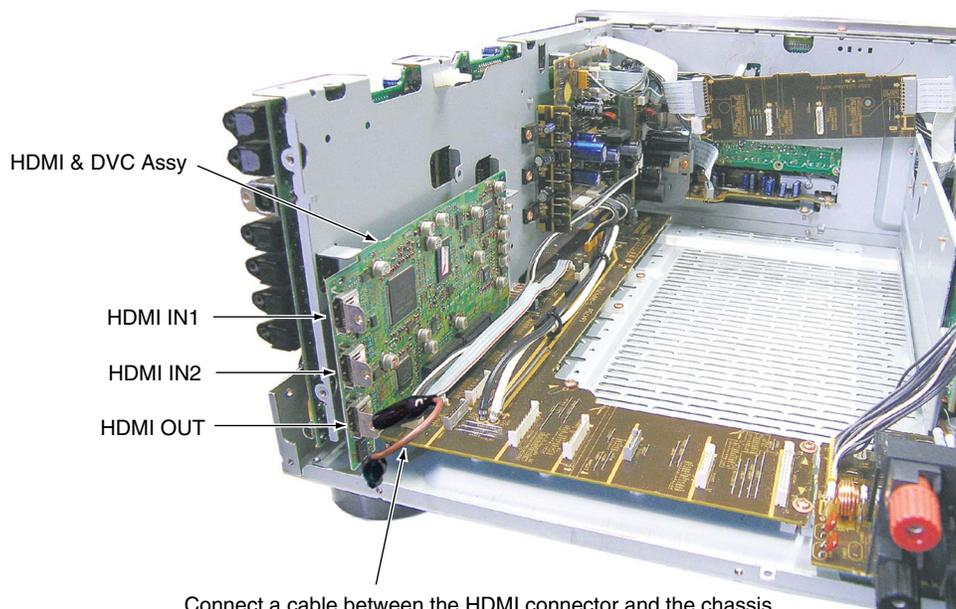

### [Tips]

- Some of the DVD players that can transmit LPCM (DVD-AUDIO) through HDMI are as follows:  
 Panasonic: DVD-S97 (Domestic model)  
 DENON: DVD-3910 (Domestic model)
- Use an HDMI cable with the HDMI logo.

## ■ Diagnosis of the line from the composite video input to the HDMI video output

How to diagnose the line from the composite video input to the HDMI video output is explained here.

### [Procedures]

1. To forcibly input the composite signal to the video converter circuit, bypassing the signal-path switching IC, short-circuit the following points with a jumper: \*1

SERVICE A-1 on the COMPOSITE V Assy <-> SERVICE A-2 (See the photo below.)

2. If the video output from the COMPOSITE V Assy is to be monitored, connect a jumper between SERVICE B-1 and SERVICE B-2 on the COMPOSITE V Assy. (See the photo below.)

3. Make the preparations described in "Preparations for diagnosis of the HDMI block and related systems."

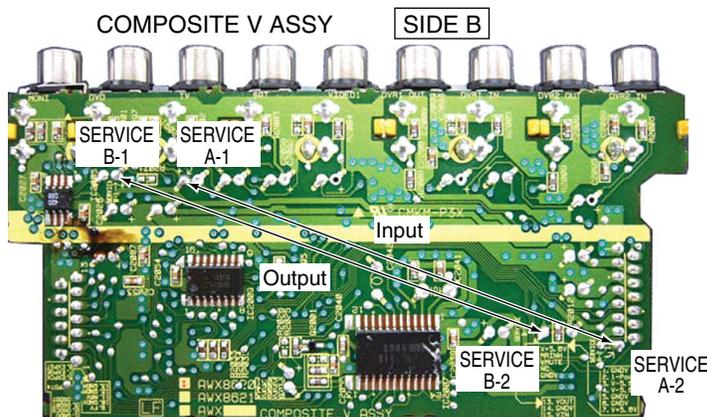

4. Remove the S VIDEO Assy.
5. Connect between the HDMI connector fitting and the chassis, and between the composite connector fitting and the chassis, separately. \*2
6. Connect the output from the source equipment (DVD player, etc.) to the DVD INPUT (COMPOSITE) connector.
7. Connect between the HDMI OUT connector and a TV monitor. (When Step 2 above is performed, the monitor output signal from the COMPOSITE OUT connector can be monitored.)
8. Set the INPUT SEL switch to DVD function.  
Check that neither S-VIDEO nor COMPONENT is assigned to DVD function.

\*1: Remove the wire used for short-circuiting after the diagnosis is finished.

\*2: Be sure to connect between the HDMI connector fitting and the chassis, and the composite connector fitting and the chassis, separately. Otherwise, operations will be unstable.

### [Appearance of diagnosing the composite video]

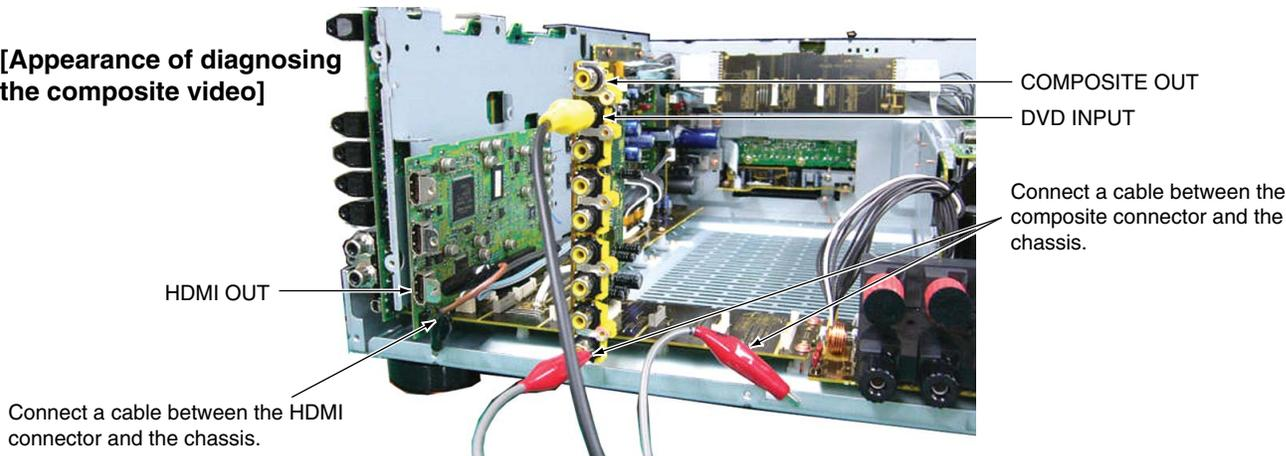

### [Tips]

In this diagnosis, the DIGITAL VIDEO CONVERSION setting (ON/OFF) in the AV PARAMETER settings is invalid.

## ■ Diagnosis of the line from the S video input to the HDMI video output

A How to diagnose the line from the S video input to the HDMI video output is explained here.

### [Procedures]

1. To forcibly input the signal to the video converter circuit, short-circuit between the pads to R2231 (C input) and R2232 (Y input) on the S VIDEO Assy. \*1
2. If the video output from the S VIDEO Assy is to be monitored, short-circuit between R2294 (C output) and R2295 (Y output) on the S VIDEO Assy.
3. Make the preparations described in "Preparations for diagnosis of the HDMI block and related systems."

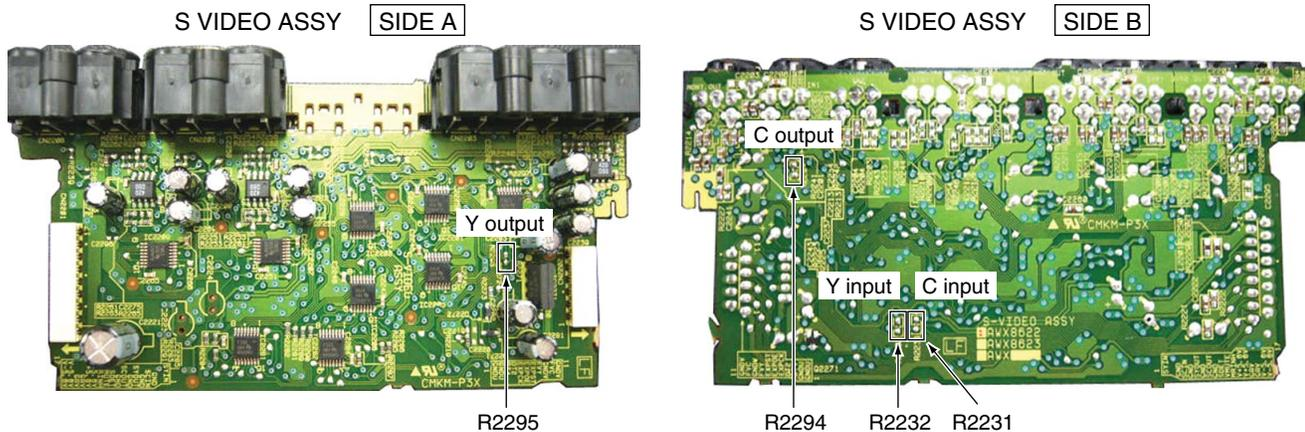

4. Connect between the HDMI connector and the chassis, and between the composite connector and the chassis, separately.\*2
5. Connect the output from the source equipment (DVD player, etc.) to the S-VIDEO INPUT 1 connector.
6. Connect between the HDMI OUT connector and a TV monitor. (When Step 2 above is performed, the signal from the S-VIDEO OUT connector can be monitored. When Step 2 in "Diagnosis of the line from the composite video input to the HDMI video output" is performed, the signal from the COMPOSITE OUT connector can also be monitored.)
7. Assign S-VIDEO INPUT 1 as DVD function. Set the INPUT SEL switch to DVD function.

\*1: Remove the solder used for short-circuiting after the diagnosis is finished.

\*2: Be sure to connect between the HDMI connector fitting and the chassis, and between the composite connector fitting and the chassis, separately. Otherwise, operations will be unstable.

### [Appearance of diagnosing the S video]

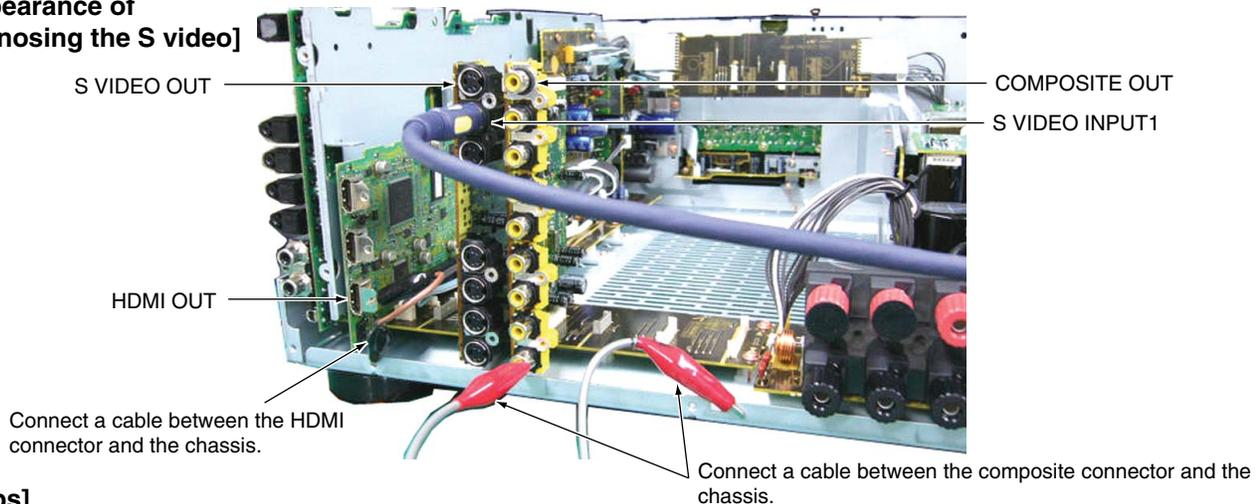

### [Tips]

In this diagnosis, the DIGITAL VIDEO CONVERSION setting (ON/OFF) in the AV PARAMETER settings is invalid.



## ■ Diagnosis of the line from the component video input to the HDMI video output

How to diagnose the line from the component video input to the HDMI video output is explained here.

### [Procedures]

1. Make the preparations described in "Preparations for diagnosis of the HDMI block and related systems" on the previous page.
2. Remove the COMPOSITE V Assy and S VIDEO Assy.
3. Connect between the HDMI connector and the chassis. \*1
4. Insert 75-ohm resistors separately between W4318 and W4316, between W4319 and W4316, and between W4320 and W4316 on the INTERFACE Assy to create impedance that matches the actual input impedance.\*2
5. Connect the signals from the source equipment (DVD player, etc.) to W4318: Y IN, W4319: Pb IN, and W4320:Pr IN, separately. \*2
6. Connect between the HDMI OUT connector and a TV monitor.
7. Referring to the instruction manual for this unit, assign COMPONENT INPUT 1 as DVD function. Set the INPUT SEL switch to DVD function.

\*1: Be sure to connect between the HDMI connector and the chassis. Otherwise, operations will be unstable.

\*2: Be sure to remove the resistors or jumpers after the diagnosis is finished.

### [Appearance of diagnosing the component video]

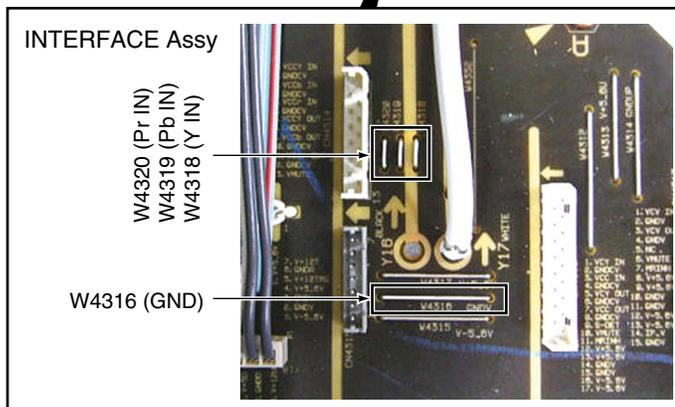
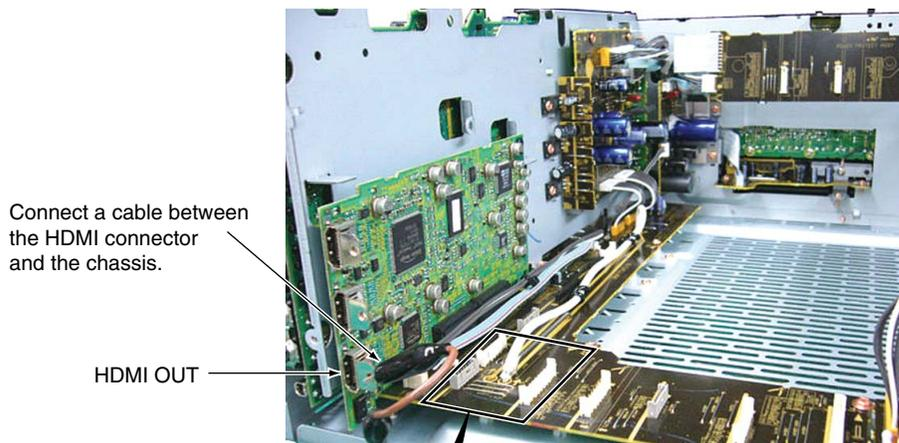

### [Tips]

In this diagnosis, the DIGITAL VIDEO CONVERSION setting (ON/OFF) in the AV PARAMETER settings is invalid.

## HDMI Troubleshooting

- A
- It is assumed that there is no loose connection or damage in the LCRs.
  - There must not be an abnormality in pattern.

### Step 1: Connections

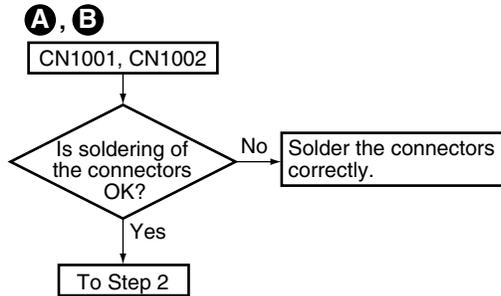

### Step 2: Power supply and clock

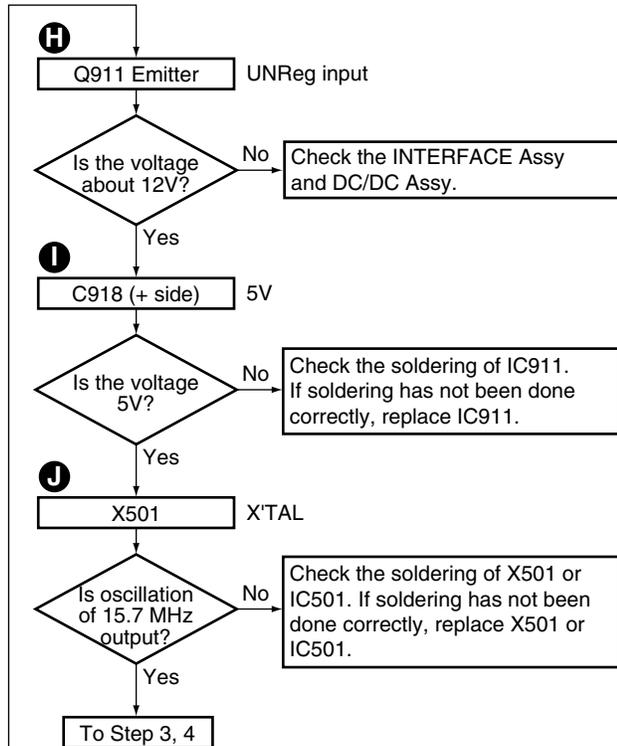
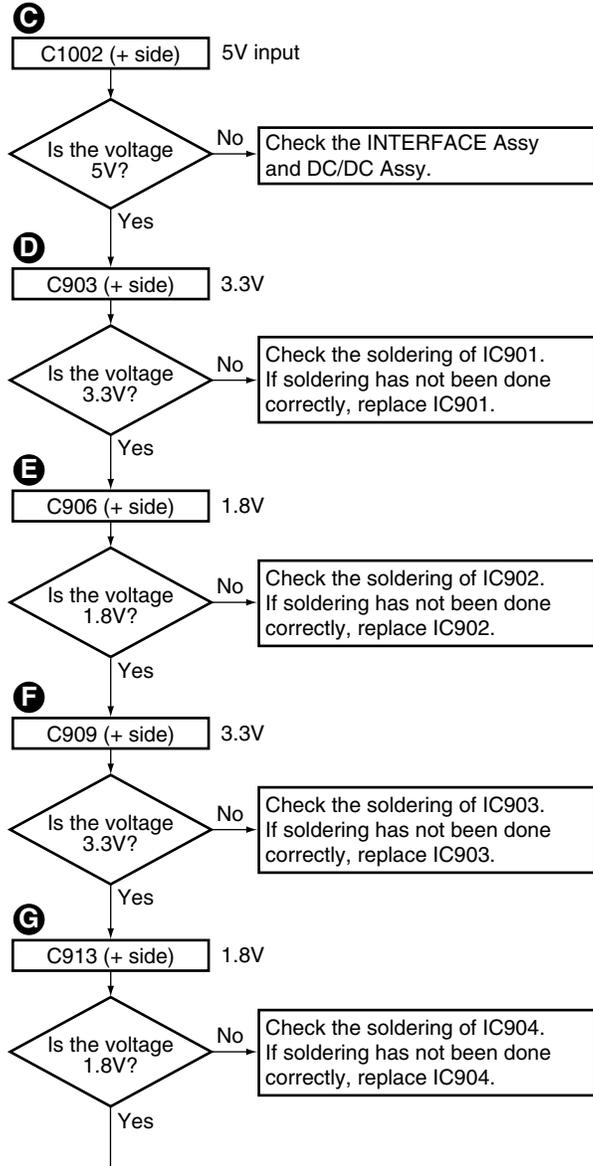

### Step 3: HDMI

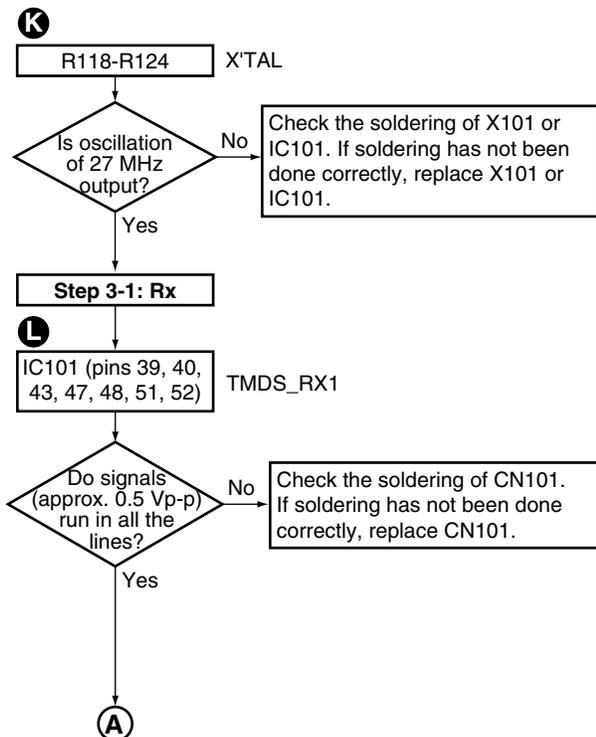

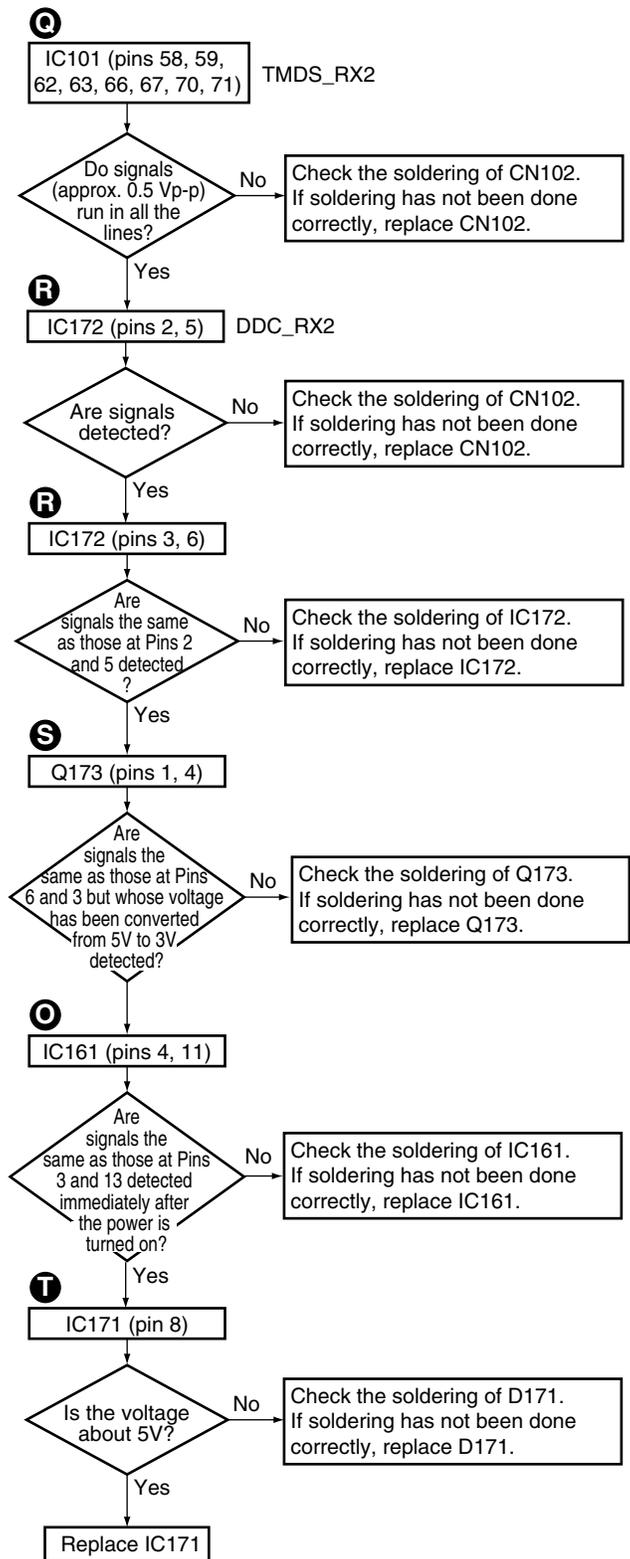
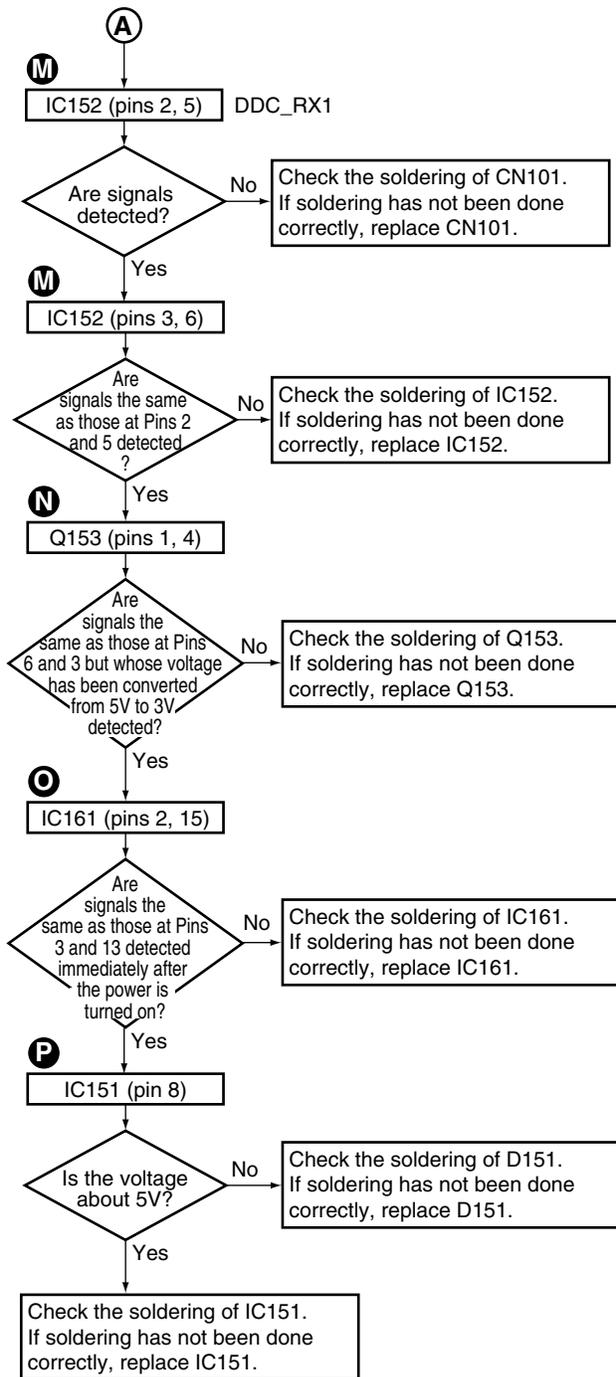

### Step 3: HDMI

A

#### Step 3-2: CLK, DATA

**U**  
IC101 (pins 1-3, 121) VIDEO

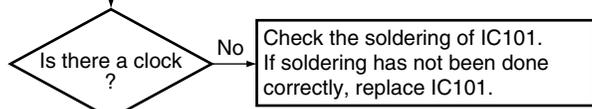

B

**U**  
IC101 (pins D0-D23)

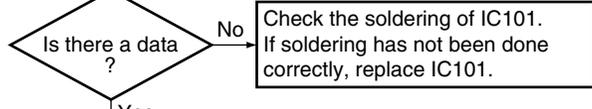

C

**U**  
IC101 (pins 78, 88) AUDIO (DVD)

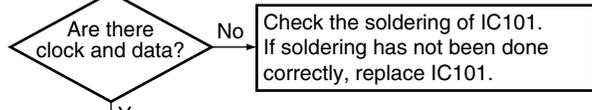

D

**V**  
IC201 (pin 11)

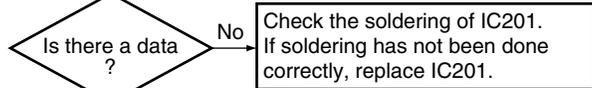

E

**U**  
IC101 (pins 81-88) AUDIO (DVD-AUDIO/Multi ch)

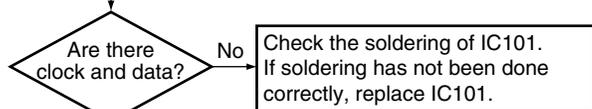

F

**V**  
IC201 (pins 12-18)

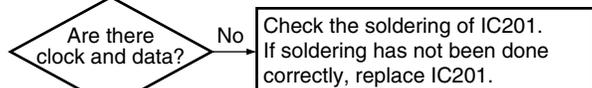

#### Step 3-3: Tx

**W**  
D381 (Cathode) HPD

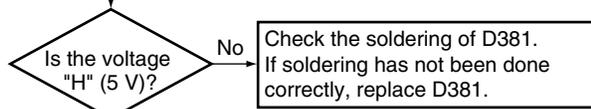

**X**  
IC301 (pins 19, 20) DDC\_TX

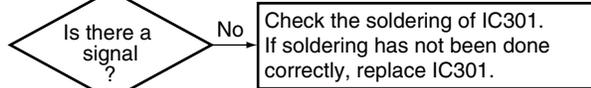

**Y**  
Q353 (pins 3, 6)

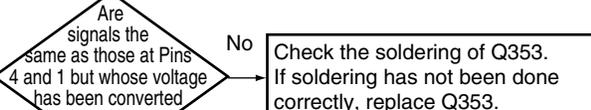

**Z**  
IC301 (pins 26, 27, 29, 30, 32, 33, 35, 36) TMDS\_TX

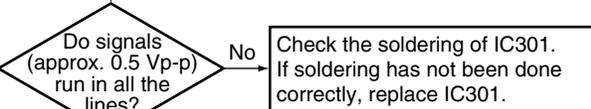

CN301

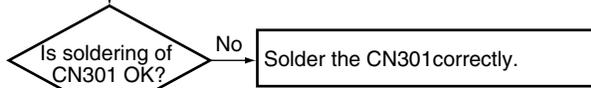

Replace CN301

### Step 4: DVC

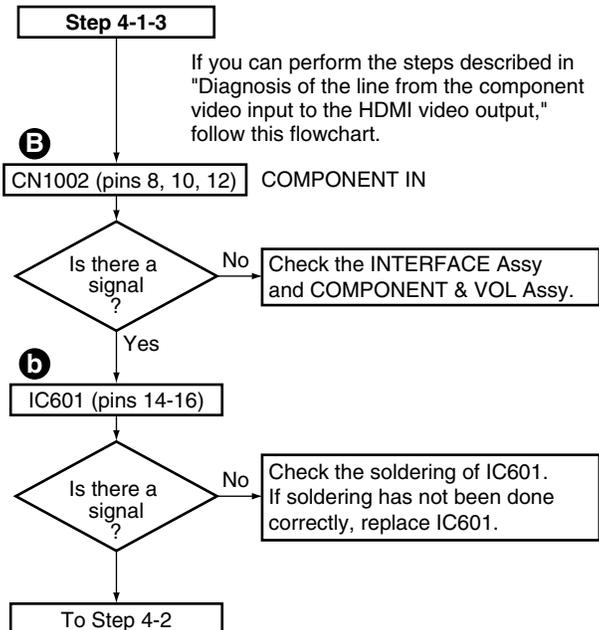
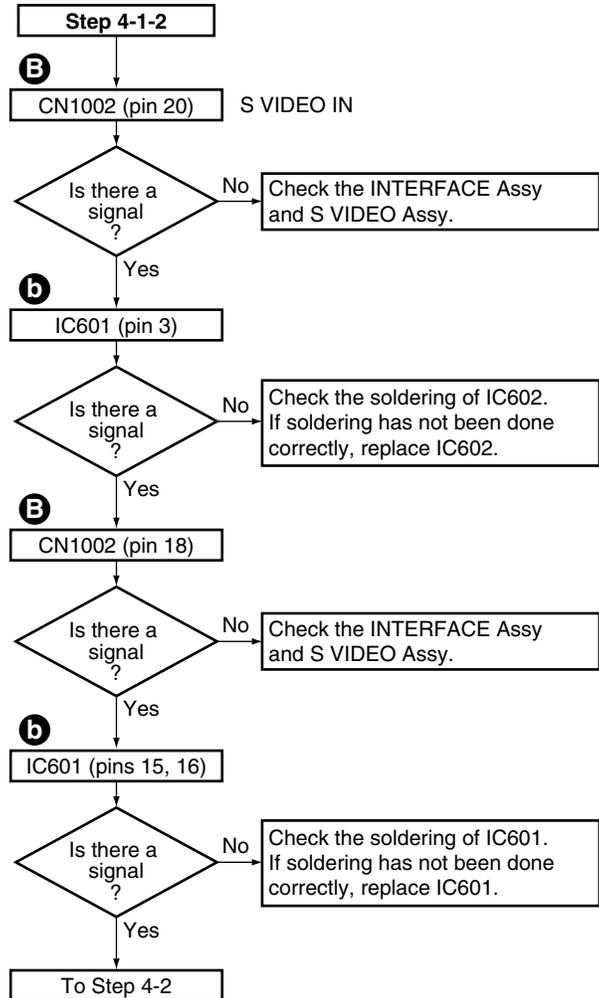
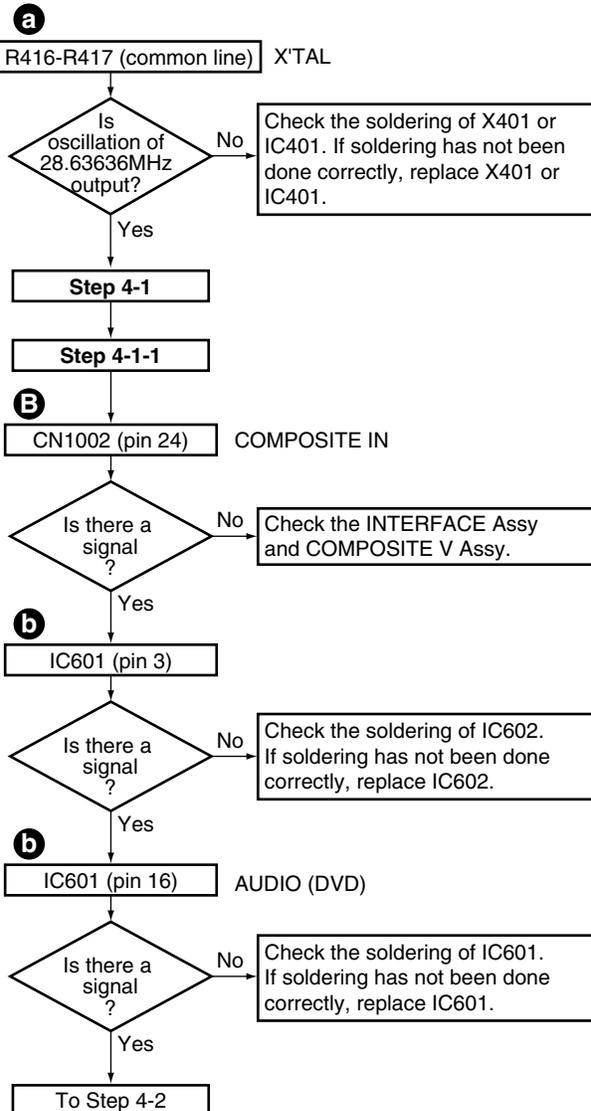

A  
B  
C  
D  
E  
F

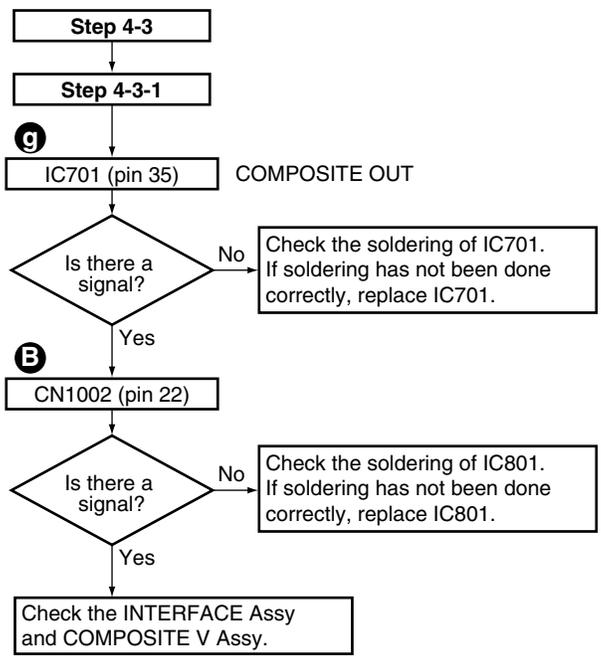
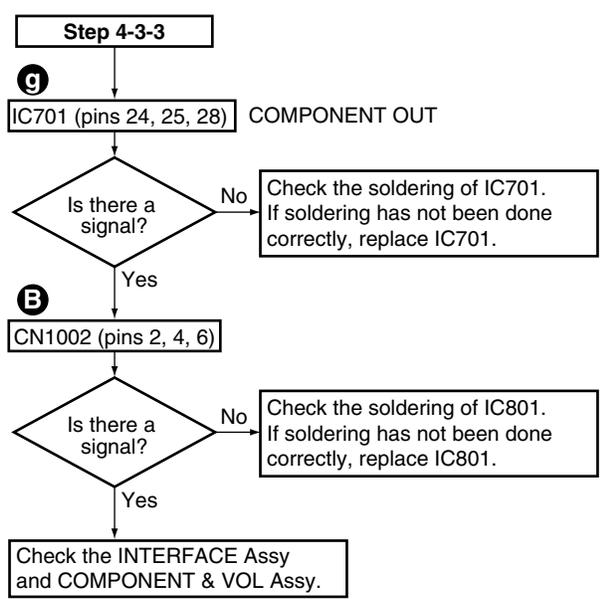
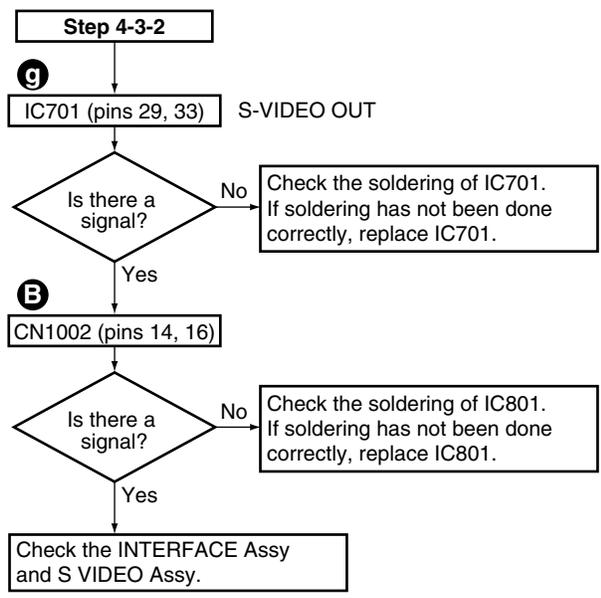
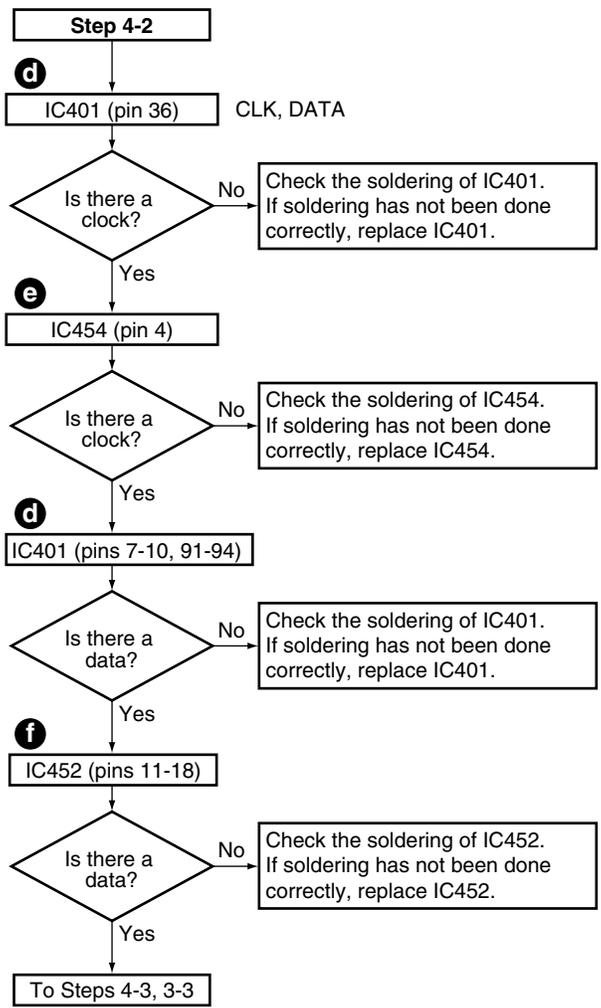

### ■ HDMI & DVC Assy Check Points

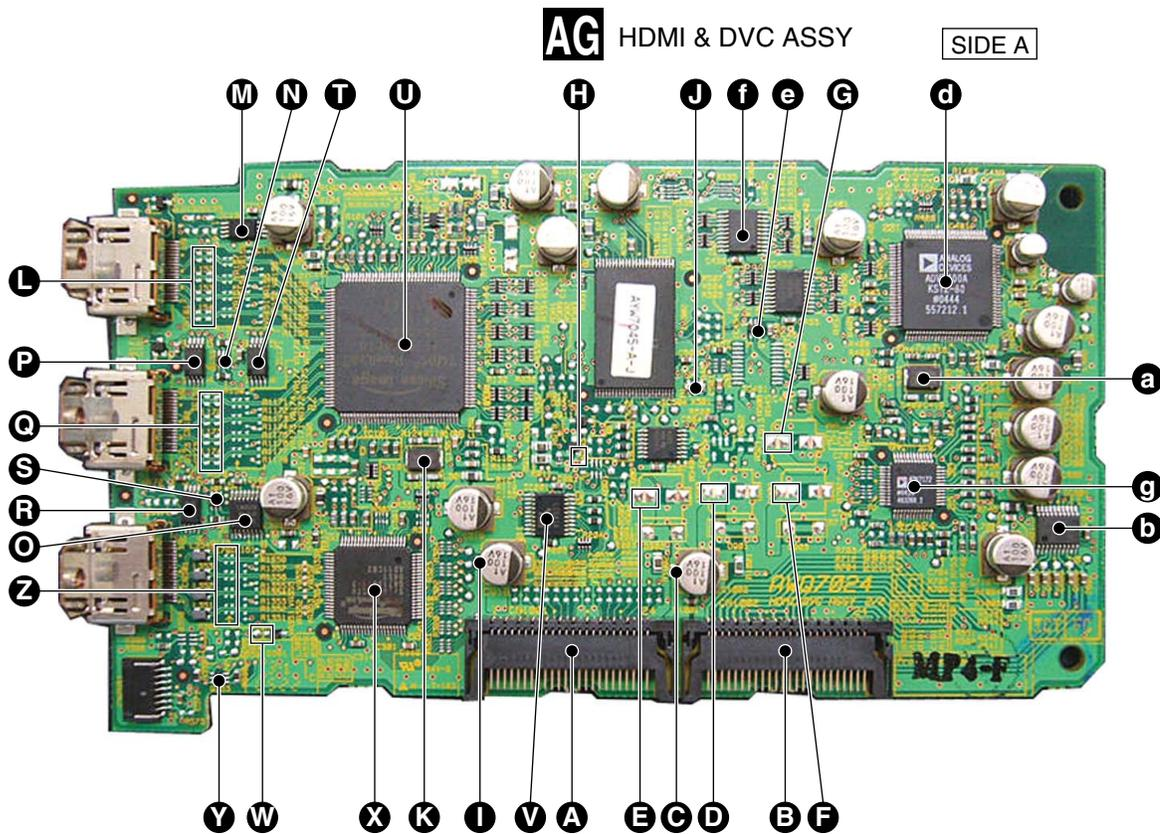

A  
B  
C  
D  
E  
F

## 7.1.5 FLOWCHART OF CONNECTION DIAGNOSIS OF THE HDMI BLOCK

### ■ Status confirmation

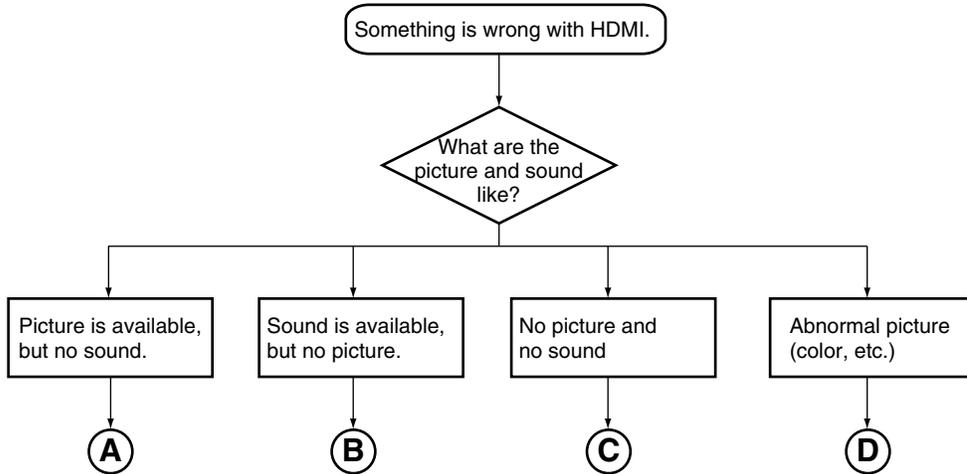

- B
- In either case, check the connection cables, input selection, and initial settings of the receiver first.
  - "Analog video" hereinafter means composite, S, or component video.
  - "Audio cable" hereinafter means either analog or digital audio connection cables.

### ■ In a case where picture is available, but no sound

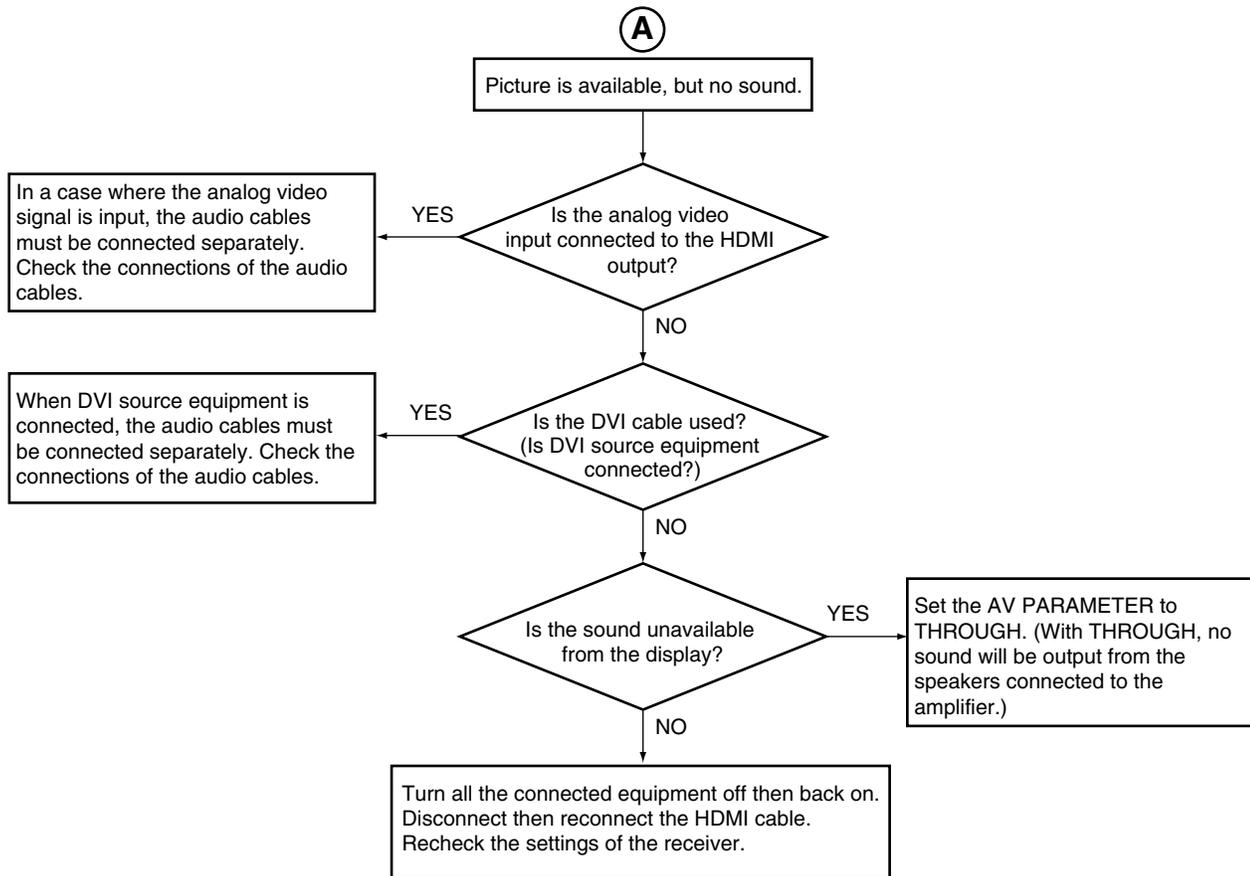



### ■ In a case where the sound is available, but no picture

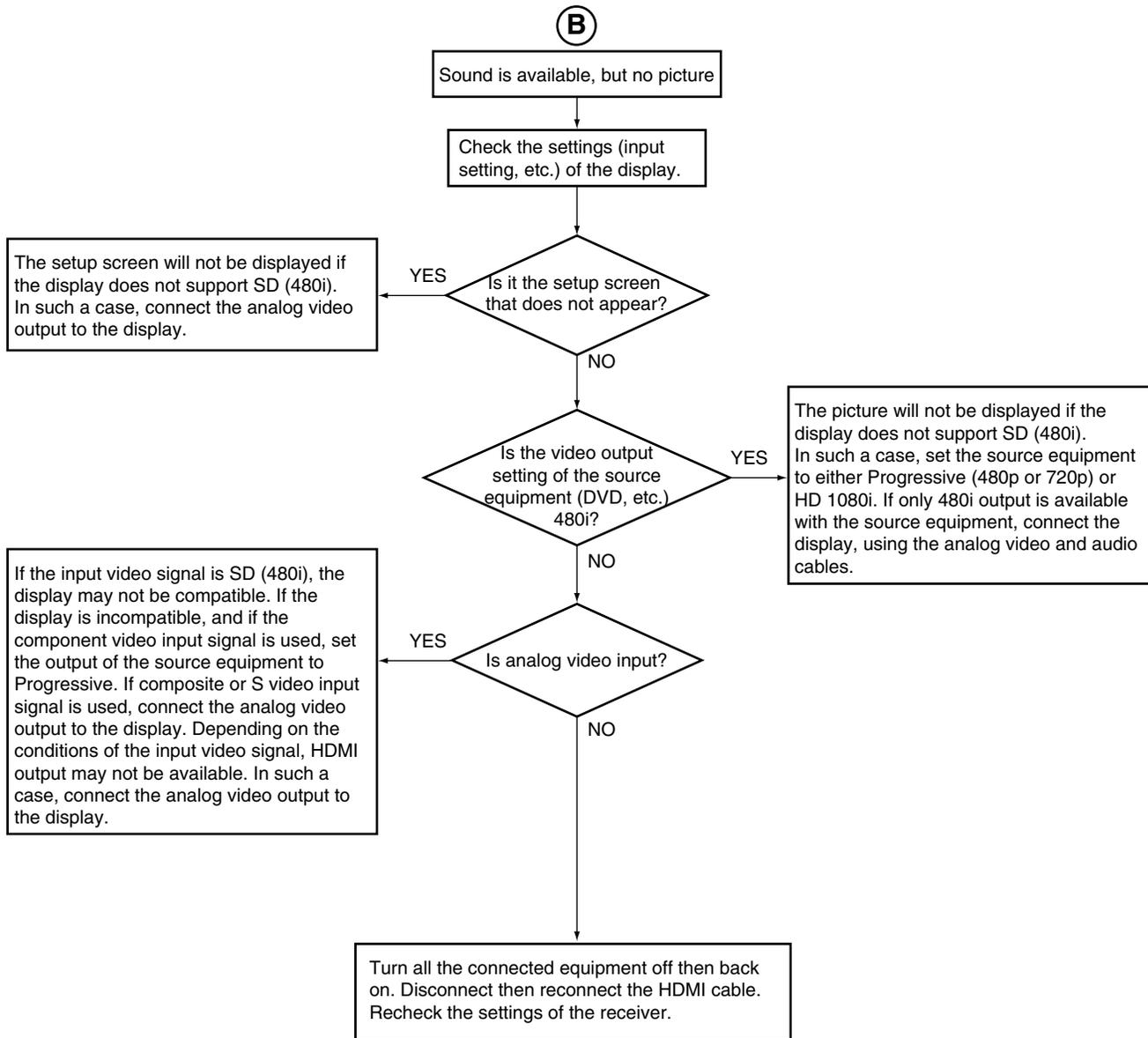

## ■ In a case of no picture and no sound

A

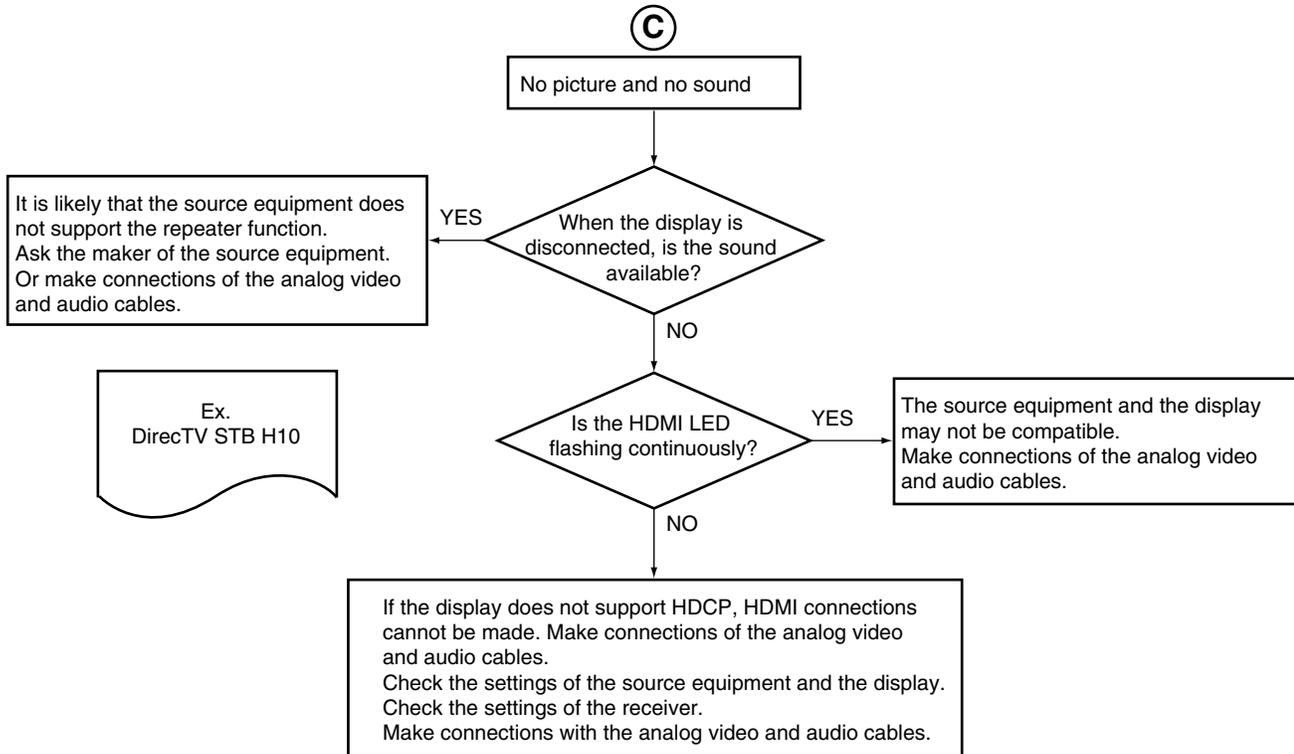

B

C

## ■ In a case of abnormal picture

D

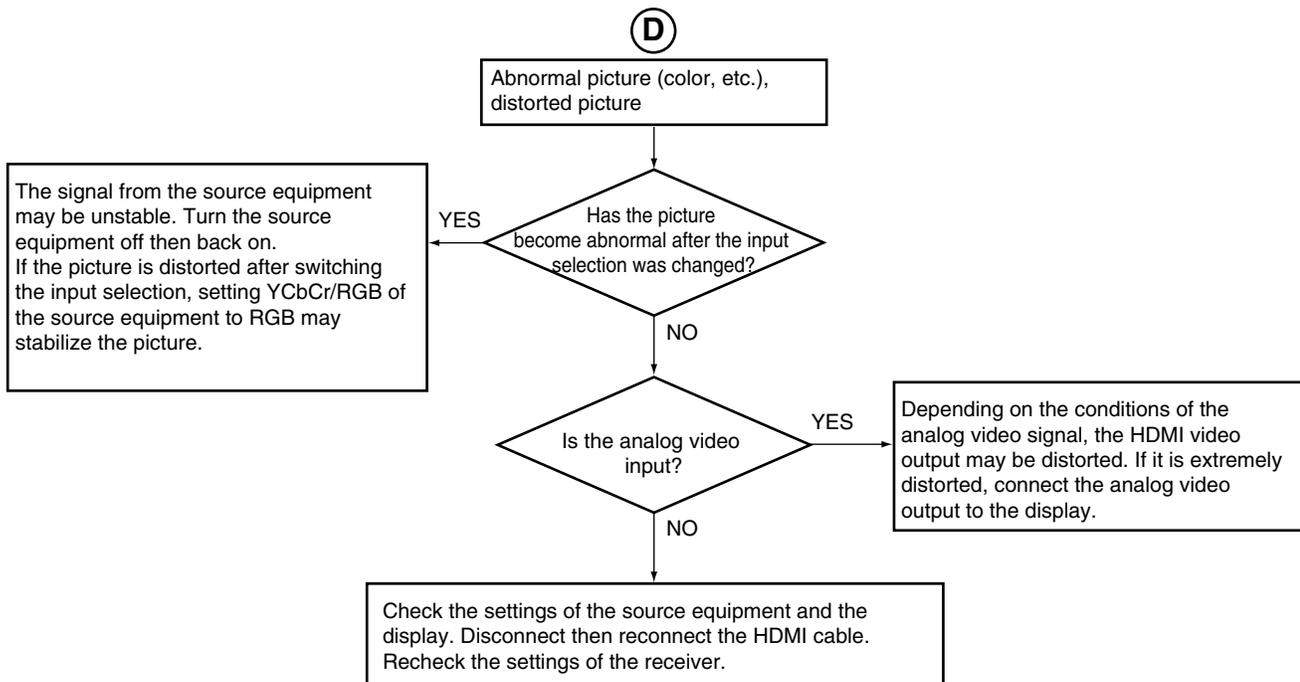

E

F

### Before Making a Diagnosis

Please check the following Trouble shooting prior to repairing the unit.

#### i.LINK interface

Symptom	Remedy
No sound is output.	<ul style="list-style-type: none"> <li>• Check that the source player is compatible with i.LINK audio.</li> <li>• Check the output settings of the source player.</li> <li>• Make sure that <b>i.LINK</b> or <b>AUTO</b> is selected using the <b>SIGNAL SELECT</b> button.</li> </ul>
The i.LINK indicator does not light up even when an i.LINK-equipped component is selected.	<ul style="list-style-type: none"> <li>• Make sure that <b>i.LINK</b> or <b>AUTO</b> is selected using the <b>SIGNAL SELECT</b> button.</li> <li>• Check the i.LINK connections; use an i.LINK cable of less than 11 feet (3.5 m).</li> <li>• Check that the source components conforms to the i.LINK Audio format.</li> <li>• Make sure that all components connected between the receiver and the source are switched on.</li> </ul>
<b>PQLS OFF</b> or <b>PQLS ON</b> is displayed temporarily on your player and the sound output is discontinued.	<ul style="list-style-type: none"> <li>• During playback through an i.LINK connection, if you change the settings for other i.LINK components, the sound will be discontinued momentarily. This is not a malfunction.</li> </ul>
The program format indicators don't disappear when SACD playback stops.	<ul style="list-style-type: none"> <li>• The program format indicators remain lit until another format source is input. This is not a malfunction.</li> </ul>
You can't get i.LINK to display when using the <b>SIGNAL SELECT</b> button.	<ul style="list-style-type: none"> <li>• Make sure your i.LINK source components are switched on.</li> <li>• Check that i.LINK is assigned correctly.</li> </ul>
After upgrading a component, it is not recognized and cannot be selected using the i.LINK connection.	<ul style="list-style-type: none"> <li>• You may need to reset the i.LINK database memory in the receiver (use the front panel): With the receiver in standby, press <b>STANDBY/ON</b> while holding down <b>RETURN</b>. When you see <b>DB CLEAR?</b> appear in the display, press <b>ENTER</b>, then <b>SETUP</b> again to confirm. When you've reset the i.LINK database memory, <b>DB CLEAR SET</b> shows in the display. If <b>DB ERROR</b> is displayed, step through the procedure again.</li> </ul>

#### i.LINK messages

You may see the following messages displayed in the front panel display when using the i.LINK interface.

Message	Explanation
<b>BUS FULL</b>	The i.LINK bus has reached its capacity and cannot transmit any more data.
<b>CANNOT LINK 1</b>	The connection between the receiver and the selected i.LINK-equipped component is unstable. If the i.LINK cables appear to be connected properly and both the receiver and i.LINK-equipped component are on, switch both units off, then on again to re-establish the connection between them.
<b>CANNOT LINK 2</b>	The receiver can't identify the selected i.LINK-equipped component. For example, the receiver may not be able to identify an i.LINK-equipped personal computer.
<b>LINK CHECK</b>	The receiver is checking the i.LINK network. It does this when components are added to, or removed from the network. The sound may be interrupted if this happens during playback.
<b>LOOP CONNECT</b>	The i.LINK network cannot function because the connected components form a loop.
<b>NO NAME</b>	When an i.LINK-equipped component has no name, this message is displayed instead of the proper component name.
<b>NO SIGNAL</b>	A component is outputting an i.LINK signal that the receiver cannot reproduce. This receiver can only reproduce signals from i.LINK-Audio-equipped components.
<b>PQLS OFF</b>	This is displayed on a playback component when PQLS turns off during playback. The sound may be interrupted momentarily when this happens.
<b>PQLS ON</b>	This is displayed on a playback component when PQLS turns on during playback. The sound may be interrupted momentarily when this happens.
<b>UNKNOWN</b>	When an i.LINK-equipped component name cannot be recognized, this message is displayed instead of the proper component name.

### ■ Preparations for diagnosis

A Detach the 1394 Assy with the flexible cables (FFCs) connected, as shown in the photos below, then make a diagnosis.

#### [Procedures]

- ① Remove the bonnet, referring to "7.1.11 Removal of Each Block."
- ② Remove the HDMI shield, first removing the three screws.
- ③ Remove the two screws that secure the 1394 connector to the rear panel.
- ④ Remove the rivet that secures the 1394 Assy.
- ⑤ Remove the 1394 Assy.

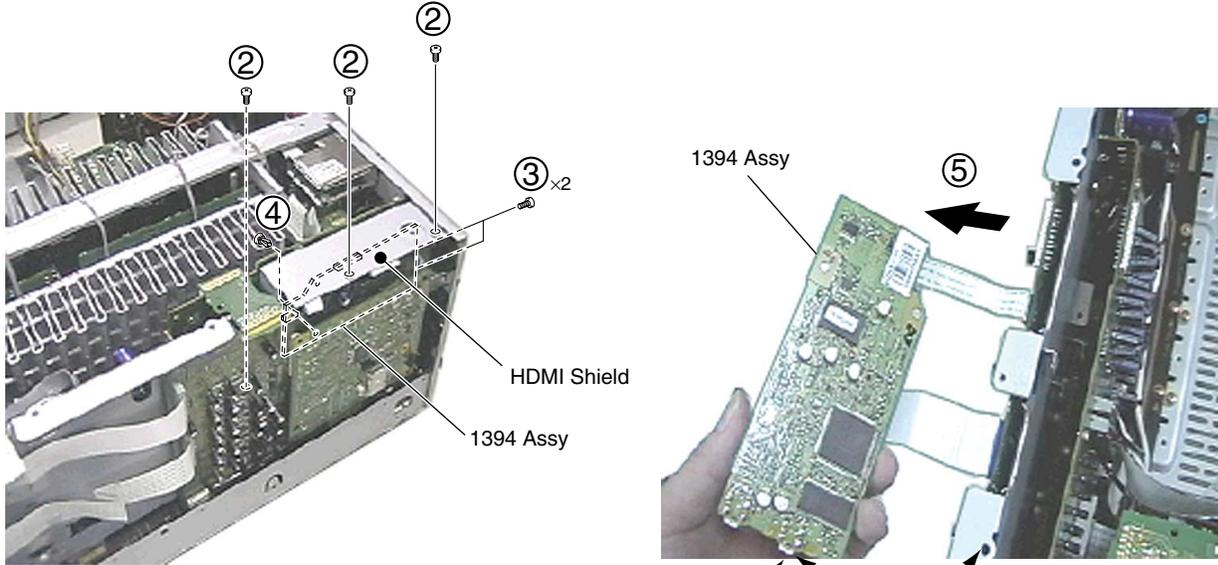

- ⑥ Connect a cable between the 1394 connector and the chassis.
- ⑦ Connect the source equipment (DVD player), using an iLink cable.

iLink cable



## ■ 1394 Assy Troubleshooting

- It is assumed that there is no loose connection or damage in the LCRs.
- There must not be an abnormality in pattern.

### Step 1: Connections

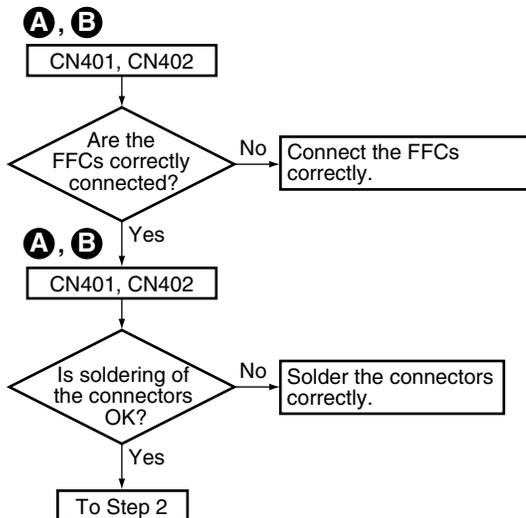

### Step 2: Power supply

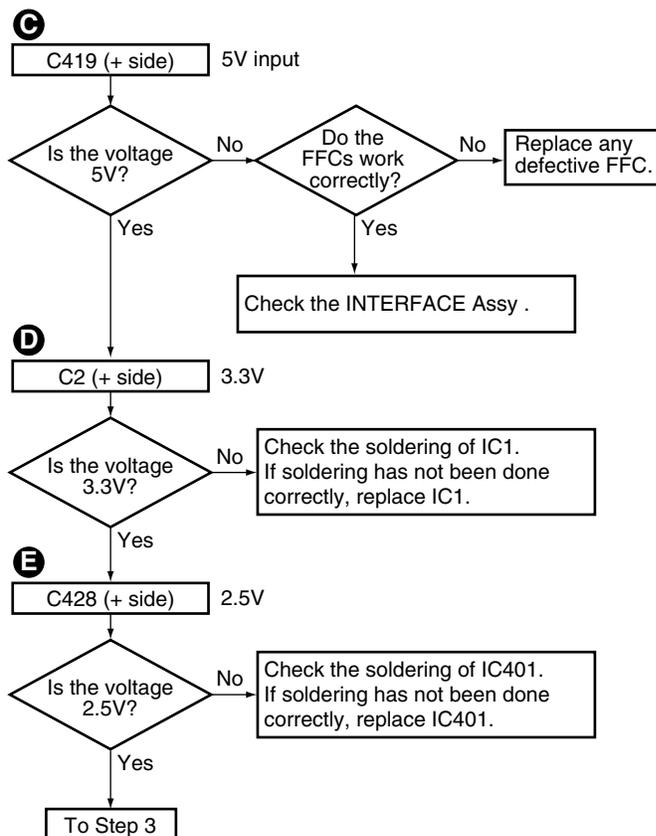

### Step 3: Operation of the Master Clock

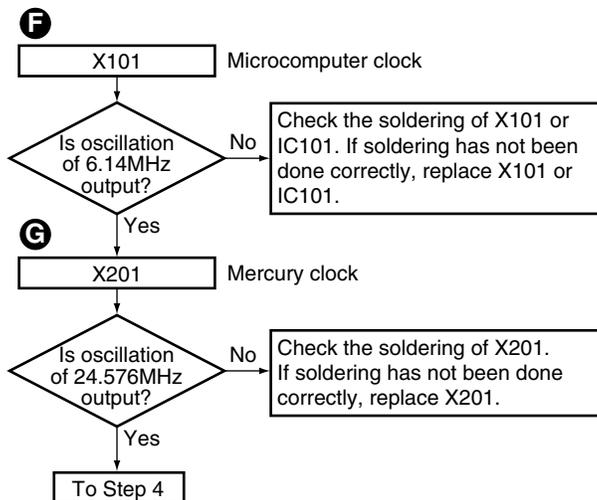

### Step 4: Operation of the Master External I/F

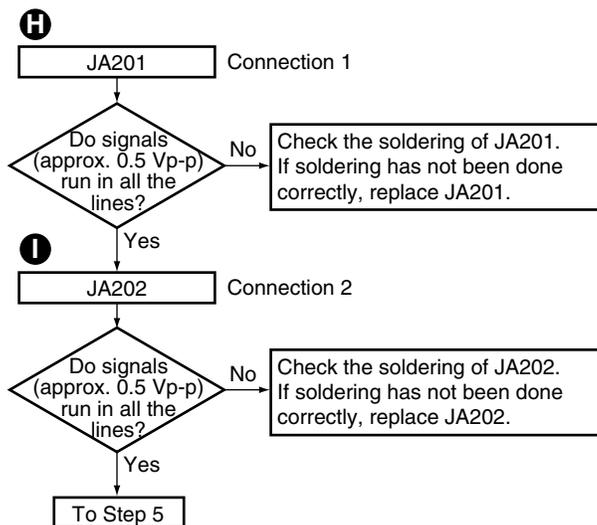

**Step 5:**

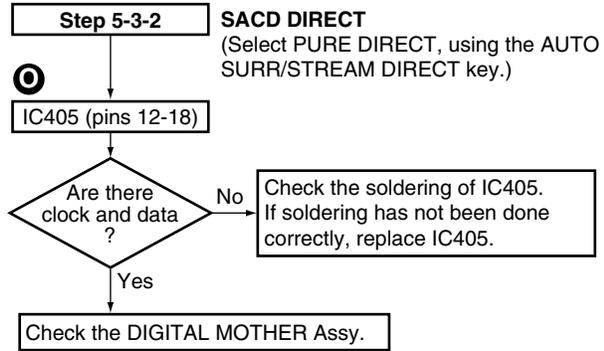
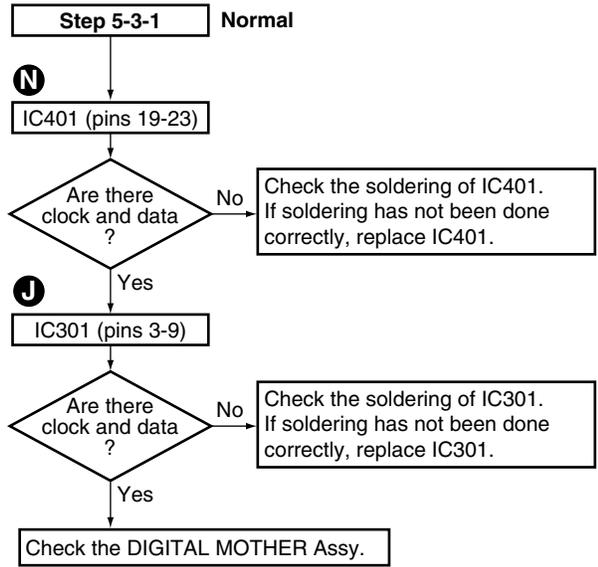
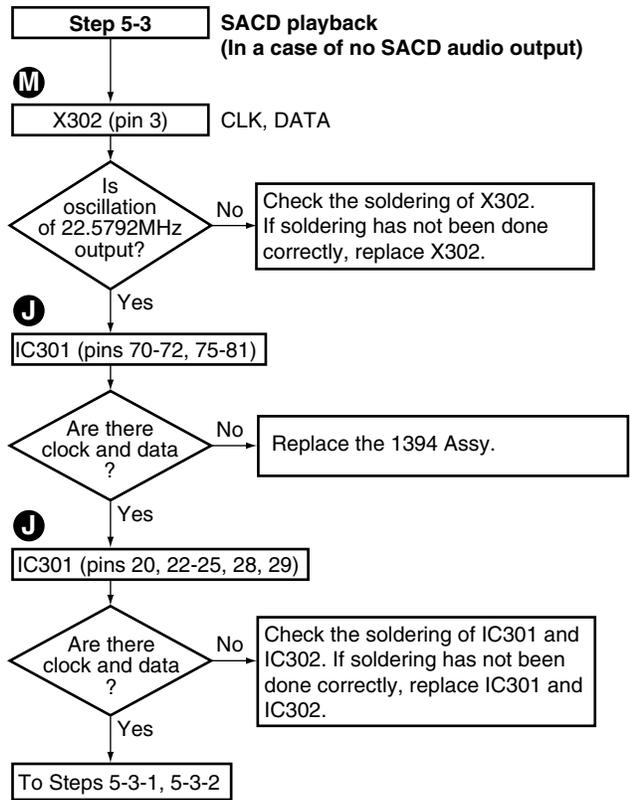
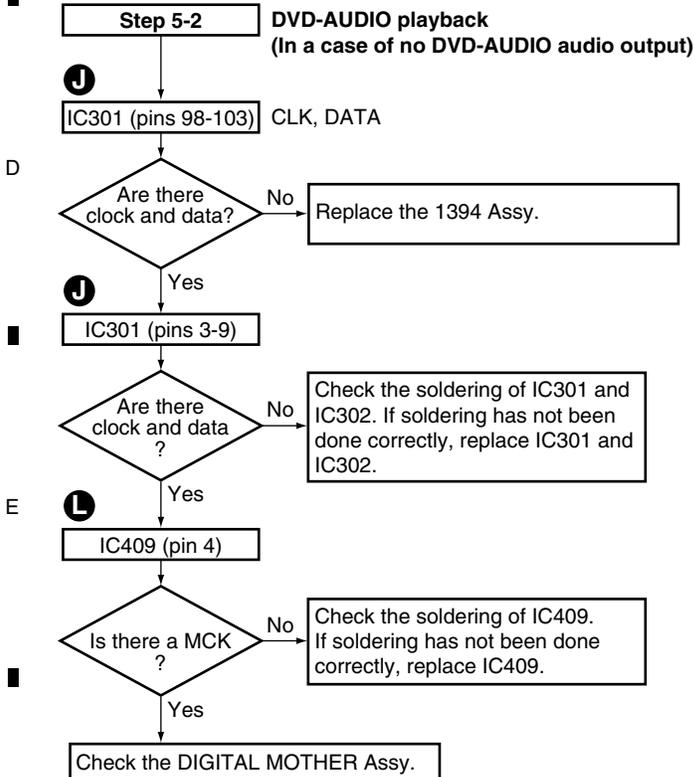
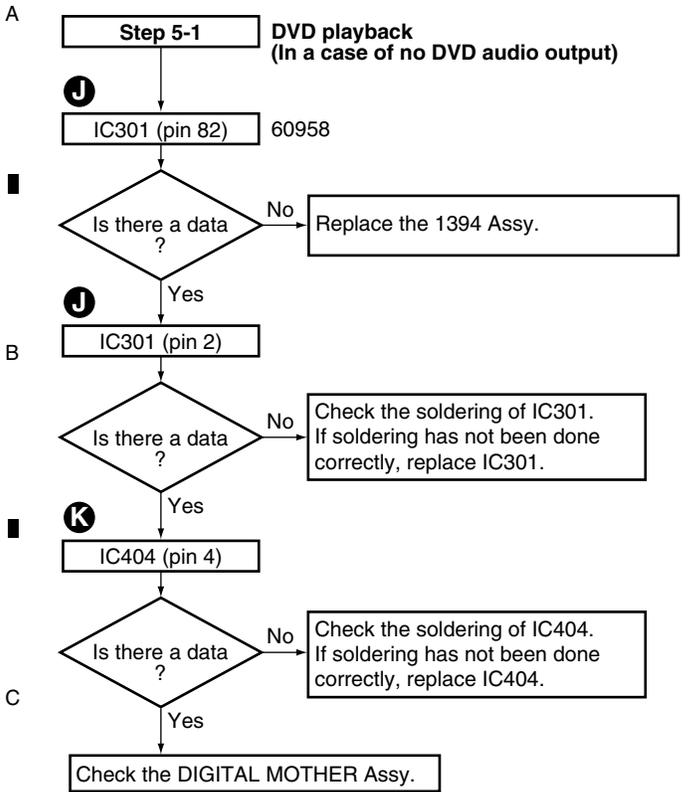

### 1394 Assy Check Points

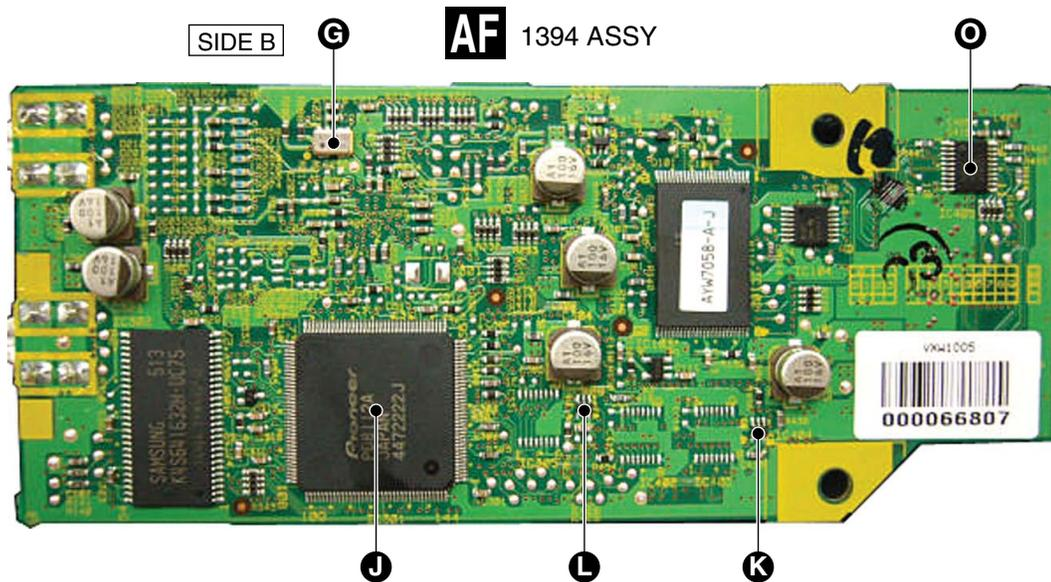
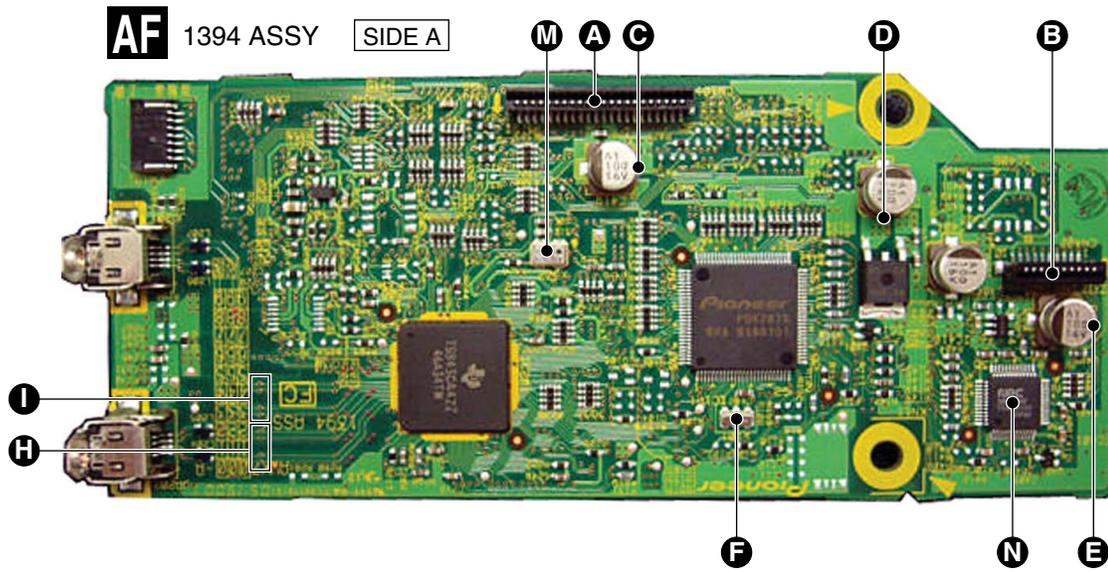

## 7.1.7 iPod INFORMATION

### ■ iPod players supported by this unit

- A This unit supports iPod, iPod mini, and iPod Photo players of the third or subsequent generation that have adopted the iPod Dock connector.  
The iPod cable is available as an optional accessory (Part No.: ADE7119).

### ■ About error codes

MONITOR OUT screen



FL display



#### [Cause]

Normal communication could not be established.

#### [Measures]

Disconnect the iPod cable. After the iPod main menu is displayed, securely connect the iPod cable again.  
If the same error code appears again, reset the iPod player.  
Diagnose the unit by following the procedures in "Operation check of iPod functions."

MONITOR OUT screen



FL display

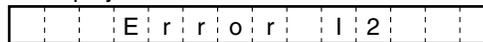

#### [Cause]

The version of the software for iPod is old.

#### [Measures]

Update the version of the software for iPod.

MONITOR OUT screen



FL display

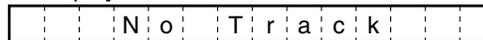

#### [Cause]

No music is recorded in the iPod player.

#### [Measures]

Transfer music data to the iPod player.



### ■ Operation check of iPod functions

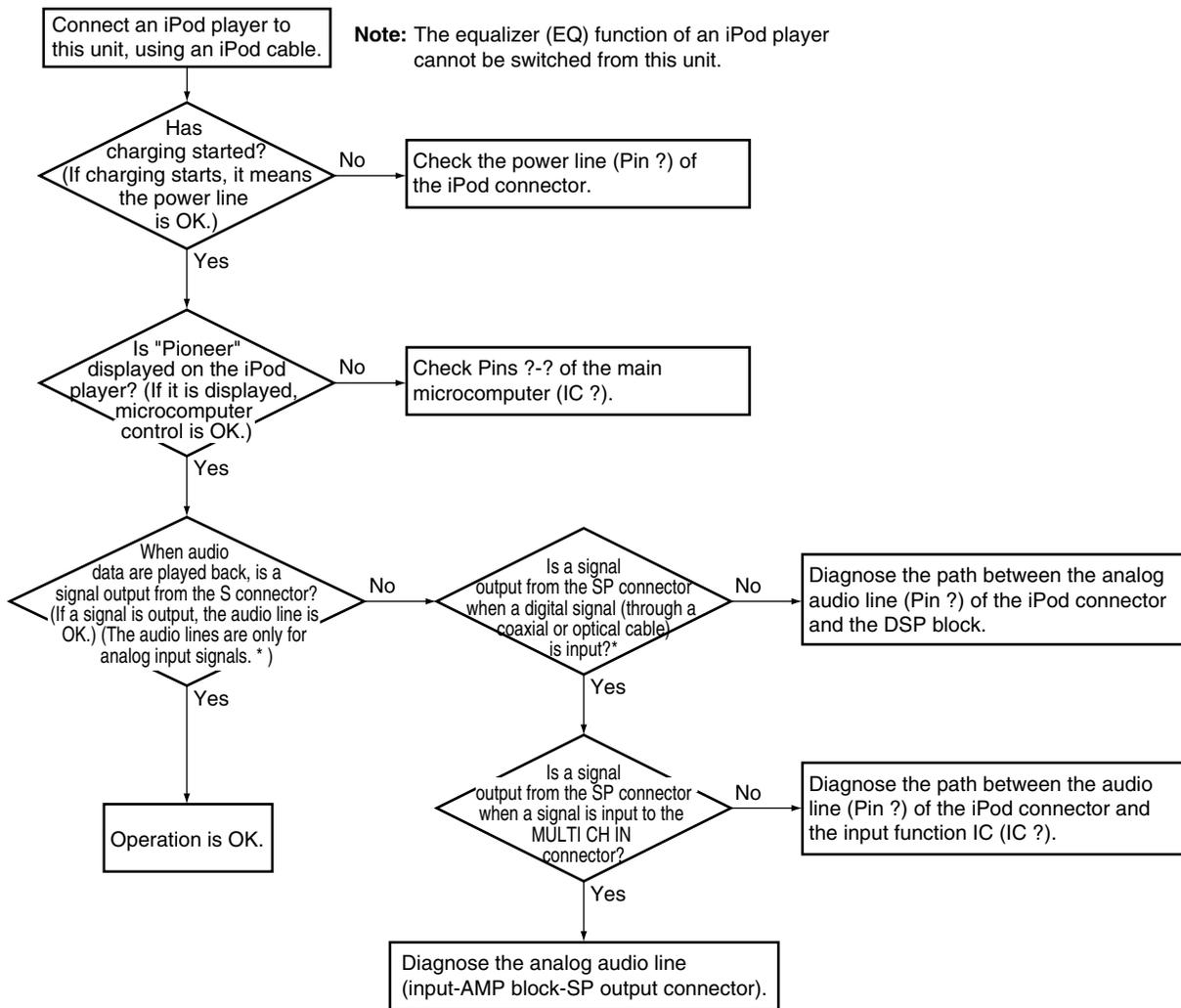

\* This unit supports iPod, iPod mini, and iPod Photo players of the third or subsequent generation that have adopted the iPod Dock connector.

## 7.1.8 XM RADIO INFORMATION

### Products used for receiving XM Satellite Radio service

A A commercially available "Connect and Play Antenna" can be used with this unit. To activate the XM RADIO service, it is necessary to receive a broadcast using your "Connect and Play Antenna."

### About XM messages

Symptom	Cause	Measures
Check Antenna	An XM antenna is not connected.	Check whether the XM antenna cable is securely connected.
XM ANT ERR	A short-circuit is occurring in the XM antenna or the surrounding antenna cable.	Make sure that there is nothing unusual with the XM antenna or XM antenna cable. Turn the power off then back on.
Updating	The radio is being updated with the latest encryption code.	Wait until the encryption code is updated. Channels 00 and 01 should function normally.
No Signal	The XM signal is too weak at the current location.	
Loading	The unit is acquiring audio or program information.	Wait until the unit has received the information.
Off Air	The channel currently selected has stopped broadcasting.	Select another channel.
CH - - -	The user has selected a channel number that does not exist or is not subscribed to.	The receiver automatically switches to Channel 001 or a last-selected channel.
- - - - -	There is no artist name/feature (song/program title), or channel category is associated with the channel.	No action needed.

### Operation check of XM RADIO function

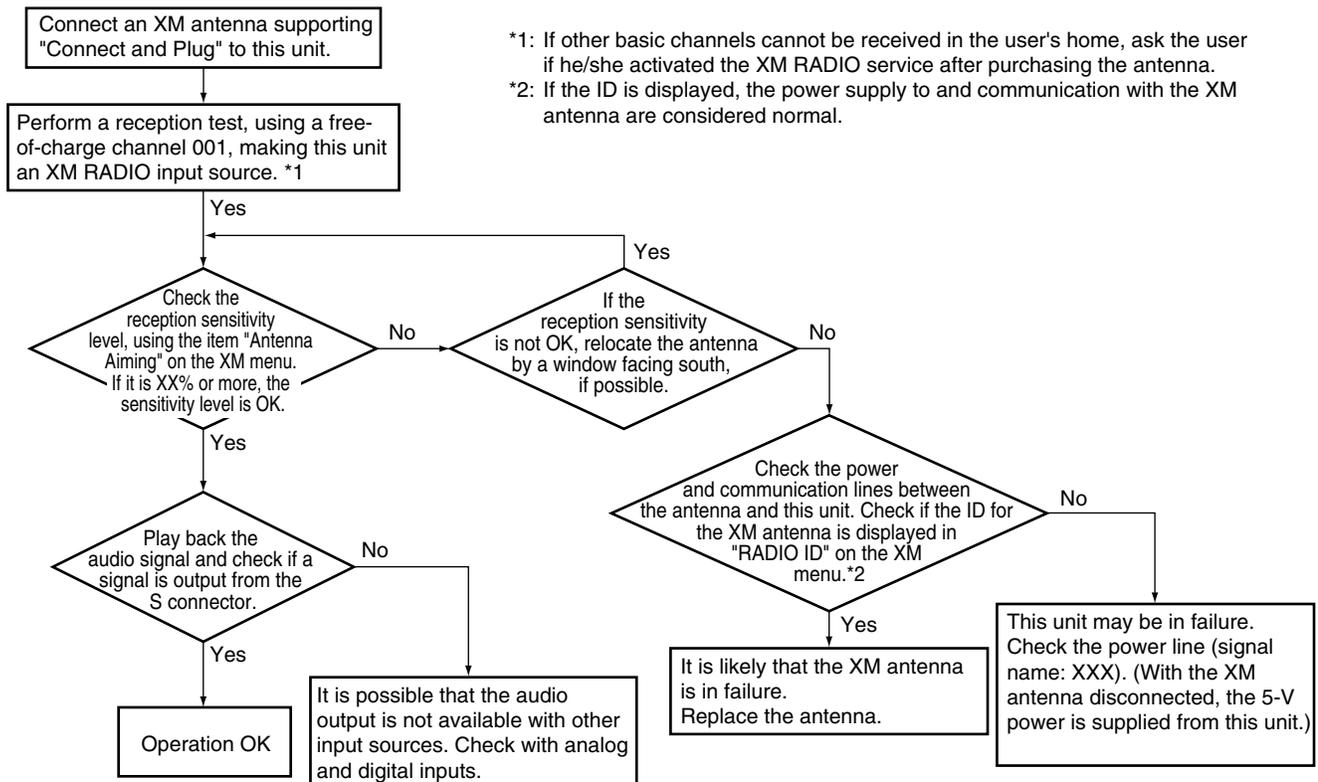

**[Purpose]**

By referring to this section, rewrite the DSP Flash ROM when required. Rewriting is instructed through service information, etc. By playing back a CD-R on which a DSP program is recorded, using a normal CD player, rewriting is possible.

**[Tools to be used]**

- CD or DVD player that can recognize a CD-R
- Note:** List of players that cannot recognize a CD-R
  - DV-U7 (Pioneer)
  - DV-S9 (Pioneer)
  - DVD-S97 (Panasonic)
- Digital coaxial cable or optical cable
- CD-R disc on which a DSP program has been recorded

**[Connections]**

Connect this unit and a player, as shown in the figure below.

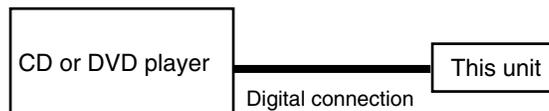

**[Preparations]**

Write the provided DSP program to a CD-R, using commercially available software for writing.

**Note:**

Depending on the writing format of the commercially available software to be used, data on a CD-R may not be used for DSP program rewriting. If the HDMI indicator does not flash when the disc is played back in the way indicated in Step 5 below, data written on the CD-R are not appropriate. To know whether the writing software is OK or not, play back the WMA9Pro stream stored on the last track of the disc. (Refer to "Troubleshooting" on next section.)

If audio data are normally played back, the disc and the player can be used for rewriting. If audio data are not correctly played back (with noise, etc.), that writing software is not appropriate. Write the DSP program, using other writing software.

**[Note]**

**Do NOT disconnect the AC cords of this unit nor the CD/DVD player while rewriting is in progress.**

The "OK" indication displayed after rewriting means the checksum on the flash ROM is OK. If the "OK" indication is not displayed, rewriting has not been completed.

Note that confirmation with audio check or version check is insufficient for checking if rewriting has been completed.

If you set the unit to STANDBY OFF without confirming if rewriting has been completed correctly, be sure to perform the rewriting procedures again.

**[Procedures]**

1. Reset the receiver.
  - Note:** Note that all the data the receiver retains will be cleared.
  - (1) Check the versions of the DSP and microcomputer.
    - Check the versions by referring to "Version indication" in "7.1.1 TEST MODE."
2. Connect a CD or DVD player.
  - (1) Connect the CD or DVD player to be used for writing to any digital input connector of this unit.
  - (2) With the INPUT SELECTOR, select the input being used.
3. Check if the digital signal is locked (received).
  - (1) Play back a stream for writing with the player.
  - (2) Set the receiver to normal playback, "Signal Select" to Auto, then check on the Signal Select indicator whether the input is set to Auto and Digital.

**[Procedures]**

## 4. Start up this unit in Rewriting mode.

- (1) Relocate the CD playback starting point to the beginning (time: 0:00) of the song No. (track) where a rewriting stream is stored, and pause playback.
- (2) Set the volume of the receiver to  $-\infty$  dB and set the receiver to STANDBY OFF.
- (3) Simultaneously press and hold the  $\uparrow$  and VIDEO SELECT keys until "DSPF DOWNLOAD" is displayed on the FL display. The unit enters Rewriting mode.

## 5. Play back a rewriting stream.

- (1) Release Pause mode of the player and play back the track where the DSP program stream to be written is stored.
- (2) After 5-10 seconds, the HDMI indicator starts flashing. Be sure to check that it is flashing.
- (3) Flashing indicates that a correct stream is being received and that rewriting is in progress.

**Note:** Do NOT turn off the unit while the HDMI indicator is flashing. If the unit is turned off, be sure to go back to Step 4. (As the Flash ROM goes into unusual status if the power is off during rewriting, the unit may not start properly.) Even in such a case, you can restore the unit by performing Steps 4-7.

## 6. Wait until rewriting is completed.

- (1) Basically, wait until "OK" is displayed on the FL display. It takes about 2 minutes for rewriting.
- (2) After confirming that "OK" is displayed, stop or pause the player then after 5 seconds set the player to STANDBY OFF.

## 7. Check the version of the program after rewriting.

- (1) Check the version by simultaneously pressing and holding the STANDARD SURROUND and STANDBY keys.
- (2) For confirmation, check basic operations.

## ■ Troubleshooting

Symptoms	Items to be checked
The HDMI indicator does not start flashing, and 10 seconds or more has elapsed after a rewriting stream is input.	Is DSP Rewriting mode entered? (Simultaneously press and hold the ↑ and VIDEO SELECT keys.)
	Is DIR locked? → You can check this on the Signal Select indicator that is displayed when the volume control is turned, by confirming if the input is set to Auto and Digital. If DIR is not locked, check the input selection and/or digital connections between the player and this unit.
	Is the stream (Track No., etc.) being played back correct?
	Are compressed audio signals, such as WMA, being input when or after Rewriting mode is entered (when the keys are simultaneously pressed)? → As soon as the compressed audio signals are input, Rewriting mode is exited. It is recommended that playback be paused at the beginning of the track of a rewriting stream then Rewriting mode is entered by simultaneous pressing of the keys. Release Pause mode after entering of Rewriting mode is confirmed.
Rewriting mode is not entered upon simultaneous pressing of the ↑ and VIDEO SELECT keys.	Make sure that the player being used is appropriate for rewriting, in the following way: <ul style="list-style-type: none"> <li>• Turn the receiver off.</li> <li>• Connect a speaker to the front channel of the receiver.</li> <li>• Turn the receiver back on normally. (Normal power on, not by simultaneous pressing of the keys)</li> <li>• Increase the volume of the receiver to some extent.</li> <li>• Play back the WMA9Pro stream stored on the last track of the disc.</li> </ul> <p><b>Note:</b> Set the volume of the player lower, as a large noise may be generated when this test stream is played back on some players.</p> <p>→ If music is played back normally, that player can be used for rewriting. ("WMA" indication on the FL display) → If noise is output, rewriting cannot be done with that player. Use another player.</p> <p><b>Tips:</b> The fact that PCM data can be played back or that a dts-CD can be played back does not mean that the player can be used for rewriting.</p>
	Is the volume control of the receiver set to -∞ dB? If not, set it to -∞ dB (- - -).
"OK" is not displayed.	Reset the receiver then enter Rewriting mode. <b>Note:</b> All the user data stored in the receiver are cleared when the receiver is reset.
	Is the track played back from the beginning to the end? → With the receiver in Rewriting mode, be sure to play back the stream track twice.
	If an error is generated because of a flaw on the disc, "OK" is not displayed. → In such a case, play back the same stream stored on another track as backup.

## 7.1.10 HOW TO REWRITE THE FLASH ROMS FOR VARIOUS MICROCOMPUTERS

### ■ HDMI microcomputer

#### [Purpose]

Refer to this section when rewriting of a Flash ROM is required by the instruction of service information, etc.

#### [Tools to be used]

- PC with a serial port
- RS-232C cable (9-pin to 9- or 25-pin, cross)
- Program for downloading (ufu.exe)
- Special device for downloading
- Firmware (.mot file)

#### [Connections]

Connect as indicated in the figure below:

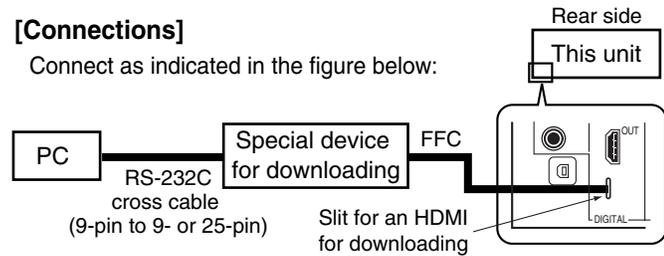

#### [Note]

**Do NOT disconnect the AC power cords of this unit nor the PC.**

#### [Procedures]

1. Prepare a PC that has the "ufu.exe" file, an RS-232C cable (9-pin to 9- or 25-pin, cross), and the special device for downloading.
2. Turn off the power to this unit by setting the main volume level to "---dB."
3. Connect the special device for downloading and the PC, as indicated in "Connections."
4. Simultaneously press and hold the VSEL and ← keys for about 5 seconds.
5. The unit is turned on, and "HDMI DOWNLOAD" is displayed.
6. Double-click on "ufu.exe".

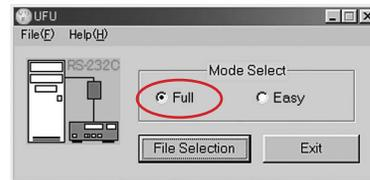

Check that "Details" is selected in MODE SELECT.

7. Check that "Details" is selected in MODE SELECT.
8. Select the required .mot file.
9. Select the baud rate.
  - Basic speed: 19200
  - Data transfer speed: 57600
10. Click on Start.
11. "Completed" is displayed for about 5 minutes in the "ufu.exe" window.
12. Disconnect then reconnect the AC power cord of the unit. If the unit is not reset, retry from Step 3.
13. Check the version.

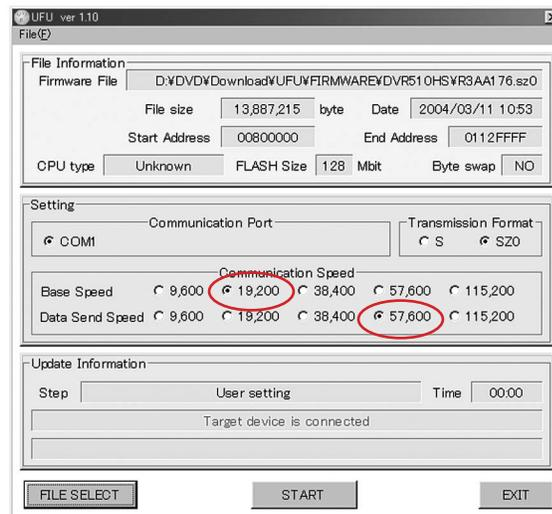

Select the baud rate.

- Basic speed: 19200
- Data transfer speed: 57600

## ■ MAIN microcomputer

### [Purpose]

Refer to this section when rewriting of a Flash ROM is required by the instruction of service information, etc.

### [Tools to be used]

- PC with a serial port
- RS-232C cable (9-pin to 9- or 25-pin, cross)
- Program for downloading (ufu.exe)
- Firmware (.mot file)

### [Connections]

Connect as indicated in the figure below:

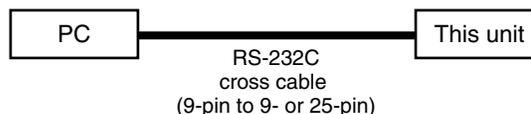

### [Note]

**Do NOT disconnect the AC power cords of this unit nor the PC.**

### [Procedures]

1. Prepare a PC that has the "ufu.exe" file, an RS-232C cable (9-pin to 9- or 25-pin, cross).
2. Turn off the power to this unit by setting the main volume level to "---dB."
3. Connect the RS-232C terminal on the rear panel and the PC, as indicated in "Connections."
4. Simultaneously press and hold the VSEL and ↓ keys for about 5 seconds.
5. The unit is turned on, and "MAIN DOWNLOAD" is displayed.
6. Double-click on "ufu.exe".
7. Check that "Details" is selected in MODE SELECT.
8. Select the required .mot file.
9. Select the baud rate.
  - Basic speed: 19200
  - Data transfer speed: 57600
10. Click on Start.
11. "Completed" is displayed for about 3 minutes in the "ufu.exe" window.
12. Disconnect then reconnect the AC power cord of the unit. If the unit is not reset, retry from Step 3.
13. Check the version. Following the procedures described in "Version indication" in "7.1.1 TEST MODE," check that the version has been changed to a new one.

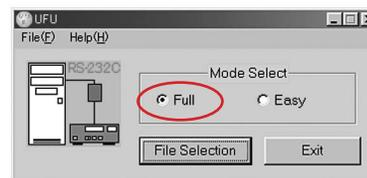

Check that "Details" is selected in MODE SELECT.

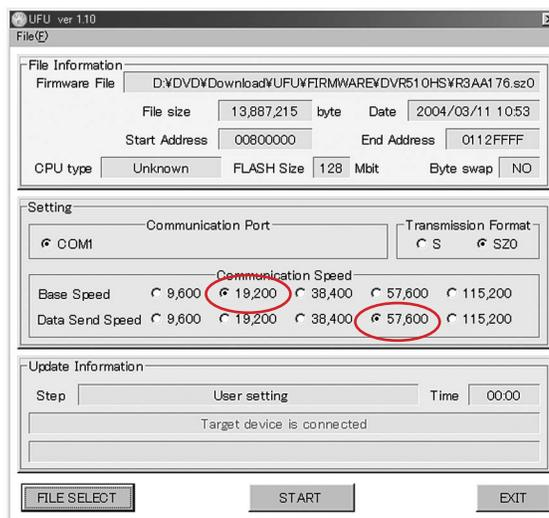

Select the baud rate.

- Basic speed: 19200
- Data transfer speed: 57600

## ■ DSP microcomputer

### [Purpose]

Refer to this section when rewriting of a Flash ROM is required by the instruction of service information, etc.

### [Tools to be used]

- PC with a serial port
- RS-232C cable (9-pin to 9- or 25-pin, cross)
- Program for downloading (ufu.exe)
- Firmware (.mot file)

### [Connections]

Connect as indicated in the figure below:

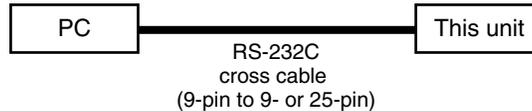

### [Note]

**Do NOT disconnect the AC power cords of this unit nor the PC.**

### [Procedures]

1. Prepare a PC that has the "ufu.exe" file, an RS-232C cable (9-pin to 9- or 25-pin, cross).
2. Turn off the power to this unit by setting the main volume level to "---dB."
3. Connect the RS-232C terminal on the rear panel and the PC, as indicated in "Connections."
4. Simultaneously press and hold the VSEL and → keys for about 5 seconds.
5. The unit is turned on, and "DSPM DOWNLOAD" is displayed.
6. Double-click on "ufu.exe".
7. Check that "Details" is selected in MODE SELECT.
8. Select the required .mot file.
9. Select the baud rate.
  - Basic speed: 19200
  - Data transfer speed: 57600
10. Click on Start.
11. "Completed" is displayed for about 3 minutes in the "ufu.exe" window.
12. Disconnect then reconnect the AC power cord of the unit. If the unit is not reset, retry from Step 3.
13. Check the version.
 

Following the procedures described in "Version indication" in "7.1.1 TEST MODE," check that the version has been changed to a new one.

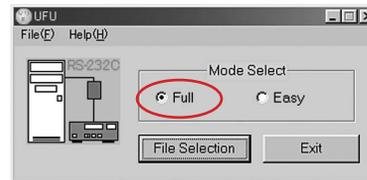

Check that "Details" is selected in MODE SELECT.

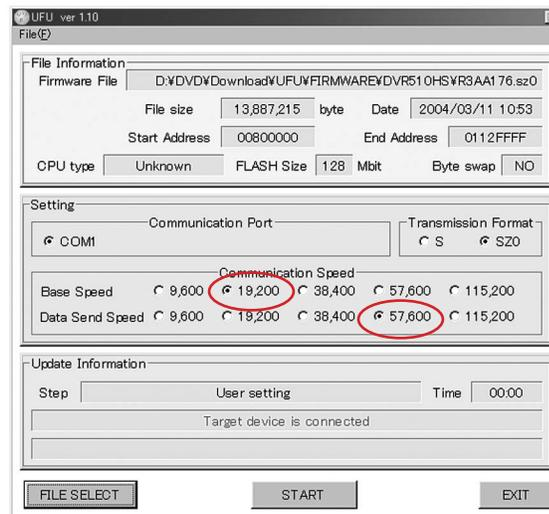

Select the baud rate.

- Basic speed: 19200
- Data transfer speed: 57600



**Note :** Even if the unit shown in the photos and illustrations in this manual may differ from your product, the procedures described here are common.

### 1. How to discharge when the Power Amp Block is removed

When the Power Amp Block is removed, discharge C4209 and C4210 on the TRANS 2-1 Assy, as indicated below. If you don't, the IC protectors (IC4261 and IC4262) on the VH TR Assy may be open, and DC voltage may be generated at the power amplifier output, which will result in "AMP ERR."

**[Procedure]**

- ① Discharge C4209 and C4210 on the TRANS 2-1 Assy.  
**Note:** For discharging, use a load of 100Ω, 3W or more, to protect the IC protectors. Do NOT discharge instantly by short-circuiting.
- ② Check that the voltage between the electrodes of each C4209 and C4210 is 1V or less.
- ③ Mount the Power Amp Block.

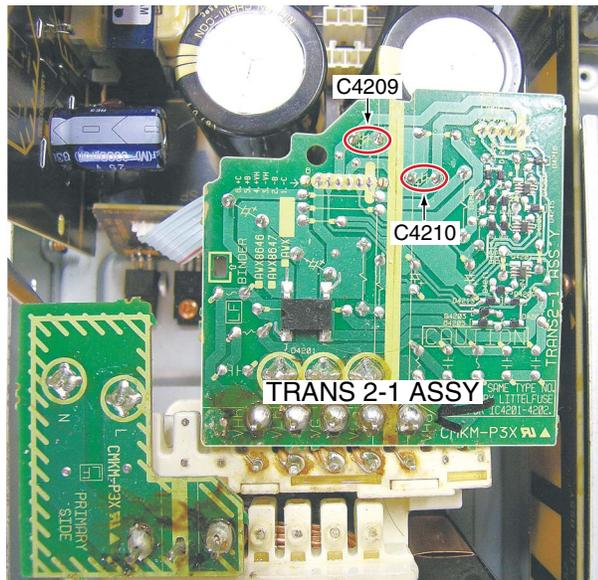
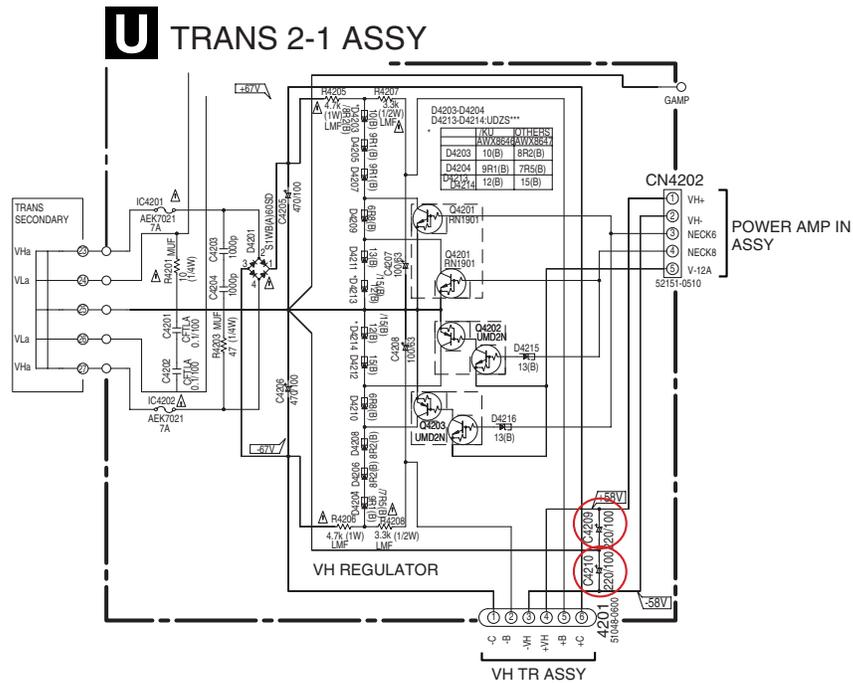

## 2. Disassembly

### 1 Bonnet

- ① Remove the four screws.
- ② Remove the four screws.

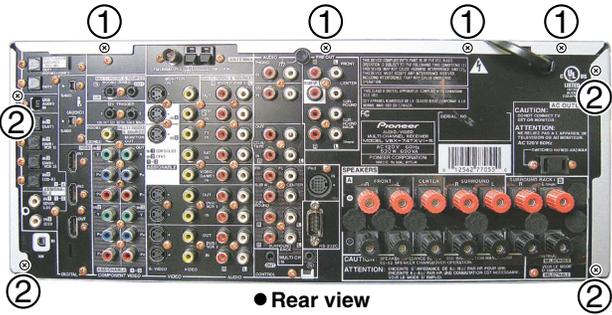

- ③ Remove the fourteen screws.
- ④ Remove the bonnet.

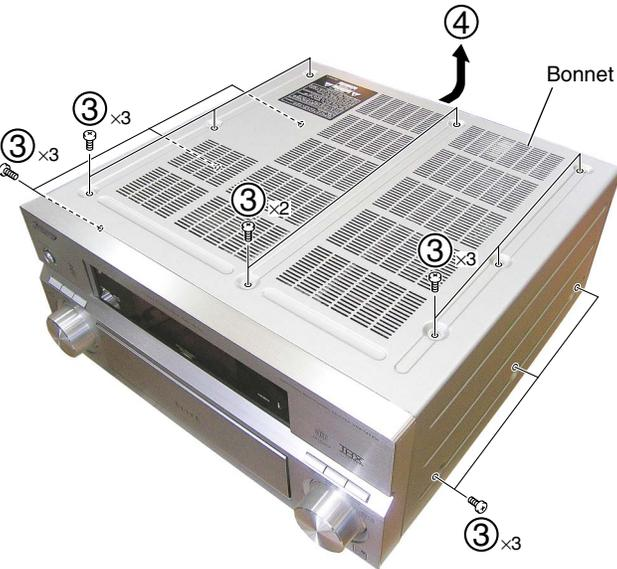

### 2 Power Amp Block

- ① Remove the two screws.
- ② Remove the four screws.

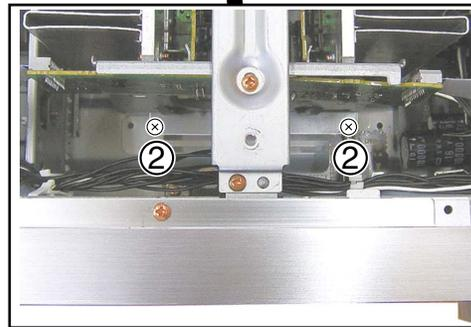
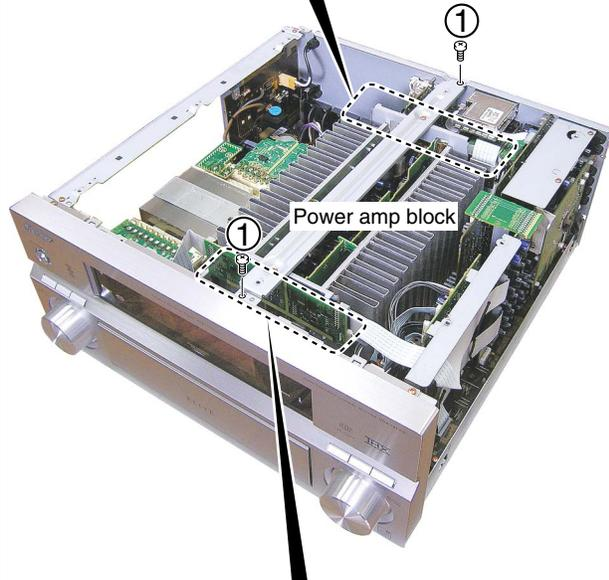
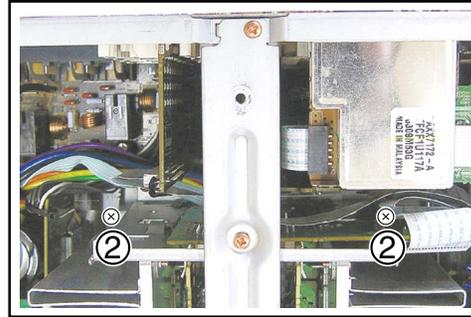

③ Disconnect the three flexible cables and one connector.  
 ④ Disconnect the six connectors and one jumper.  
 ⑤ Remove the power amp block.

Power amp block  
 POWER AMP IN Assy  
 POWER PROTECT Assy

**Q** POWER AMP-L Assy      **O** POWER AMP IN Assy  
**R** POWER ANP-R Assy  
**P** POWER PROTECT Assy

### 3 Replacing the Power Transistor

• **Center Beam V1**  
 ① Remove the two screws.  
 ② Remove the center beam V1.

Center beam V1

• **POWER PROTECT Assy**  
 ① Remove the two nylon rivets.  
 ② Remove the POWER PROTECT Assy by removing the two connectors.

POWER PROTECT Assy

A  
B  
C  
D  
E  
F

A

• **HS Angle 74**

- ① Remove the four screws.
- ② Remove the HS angle 74.

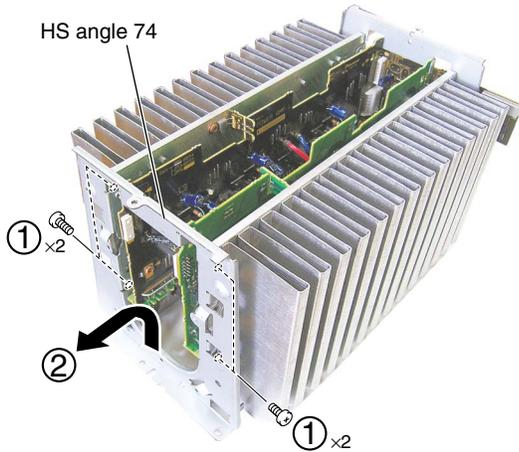

• **POWER AMP IN Assy**

- ① Remove the POWER AMP IN Assy by removing the four connectors.

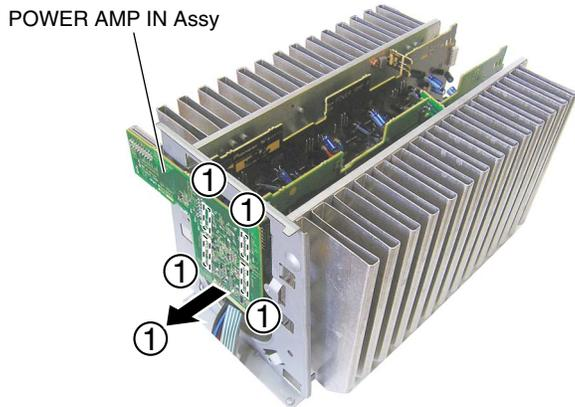

• **HS Angle 74**

- ① Remove the four screws.
- ② Remove the HS angle 74.

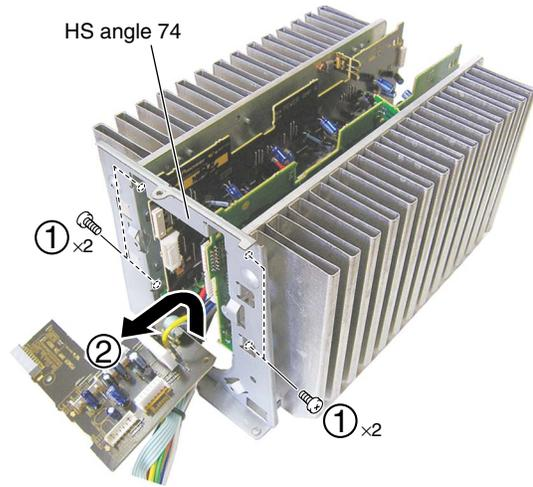

• **Replacing the Power Transistor**

- ① Remove the screw.

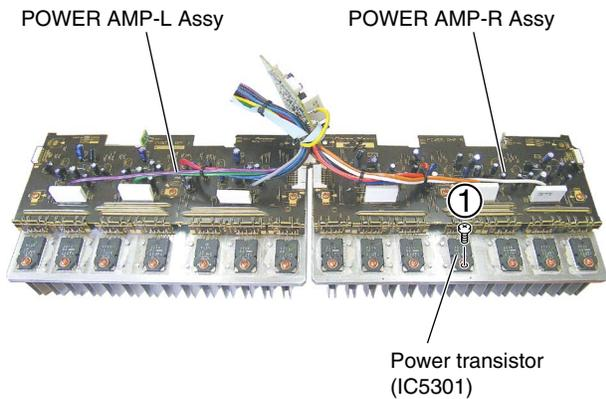

**Replace**

F

### 4 Replacing the Regulator IC

#### • Rear Panel

- ① Remove the four cushion circle 16Bs.
- ② Disconnect the one connector.
- ③ Remove the screw.
- ④ Remove the three screws.
- ⑤ Remove the two screws.
- ⑥ Remove the four screws.

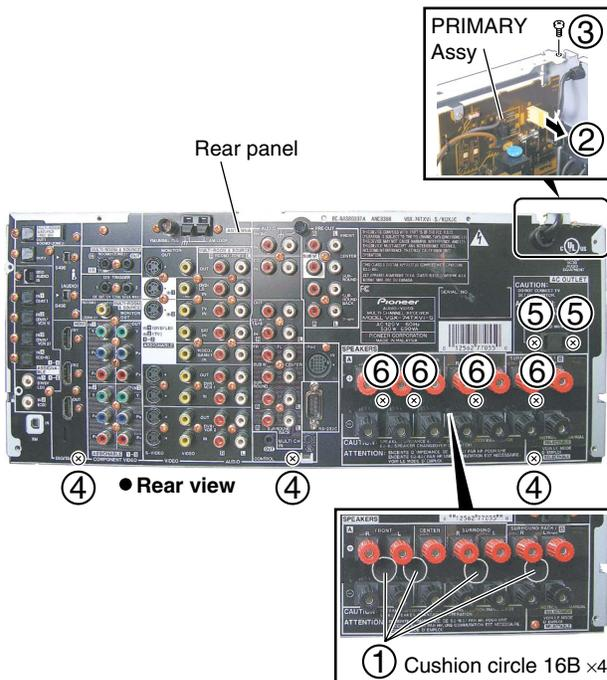

- ⑦ Remove the two screws.
- ⑧ Remove the four screws. (VSX-74TXVi and VSX-74TXVi-S only)
- ⑨ Remove the 45 screws.
- ⑩ Remove the rear panel.

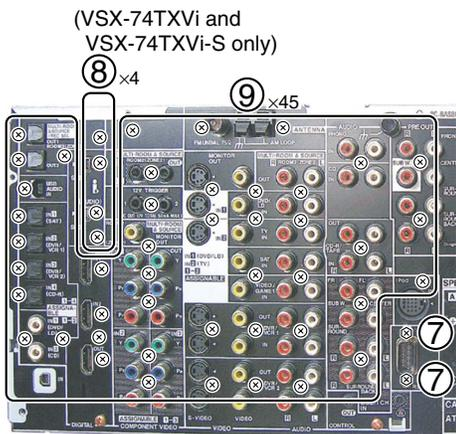

• Rear view

#### • HDMI Shield

- ① Remove the BRIDGE 1 Assy by removing the two connectors.
- ② Remove the three screws.
- ③ Remove the HDMI shield.

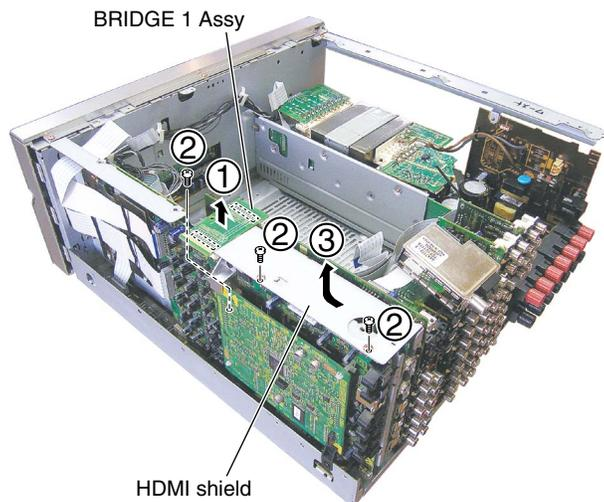

#### • FM/AM TUNER Unit

- ① Remove the FM/AM TUNER Unit by removing the one flexible cable.

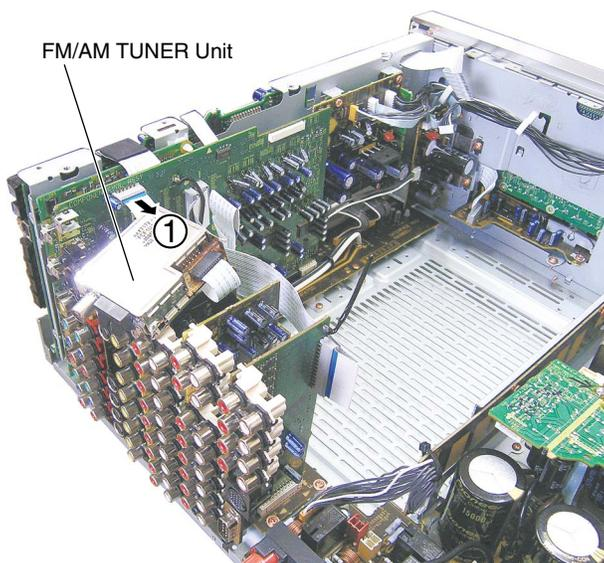

A  
B  
C  
D  
E  
F

**• PCB Assys**

- ① Remove the PREOUT & CONTROL, AUDIO & MULTI CH IN, V-AUDIO, COMPOSITE V, S VIDEO, BRIDGE 2 and BRIDGE 3 Assys from the INTERFACE Assy.

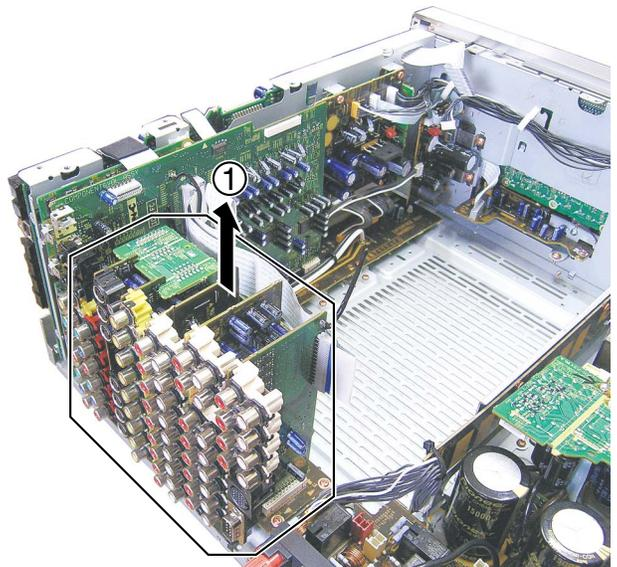

**• COMPONENT & VOL Assy**

- ① Remove the COMPONENT & VOL Assy from the INTERFACE Assy.

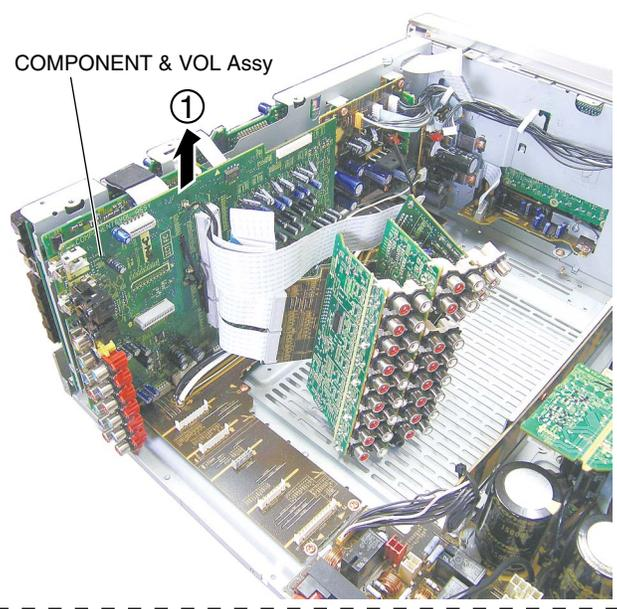

**• HDMI & DVC Assy**

- ① Remove the nylon rivet.
- ② Remove the HDMI & DVC Assy from the INTERFACE Assy.

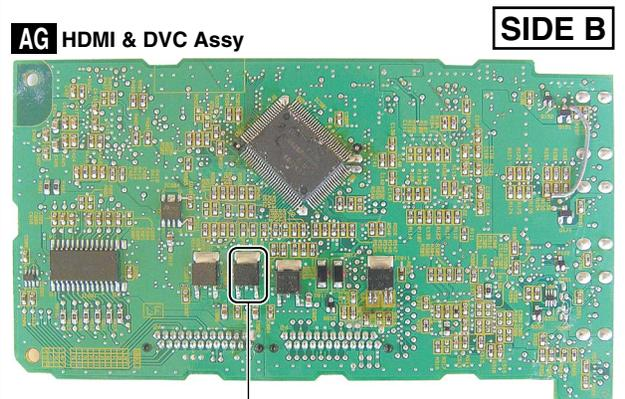
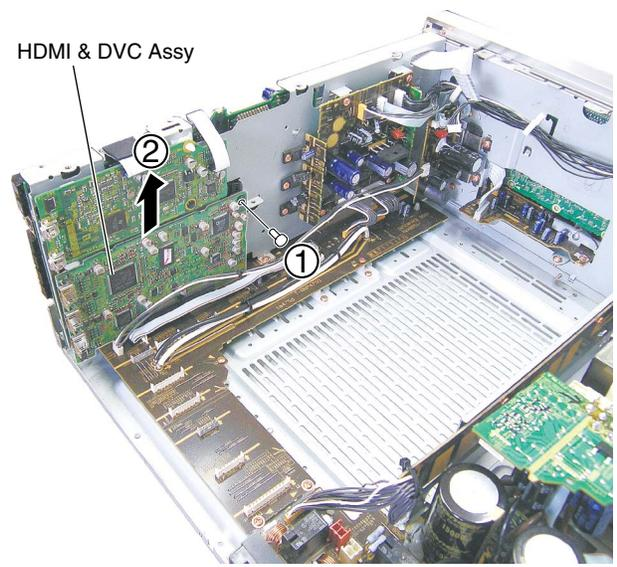

**Replace**



### 5 Replacing the Transistor

#### • DIGITAL MOTHER Assy

- ① Remove the nylon rivet.
- ② Disconnect the two flexible cables. (VSX-74TXVi and VSX-74TXVi-S only)
- ③ Disconnect the two flexible cables.
- ④ Remove the DIGITAL MOTHER Assy with DSP Assy from the INTERFACE Assy.

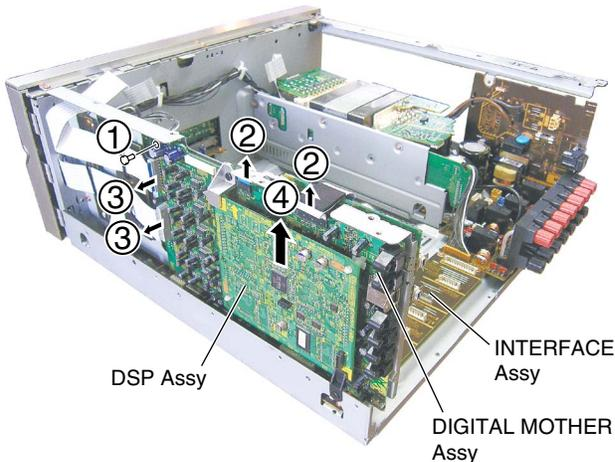

#### • DSP Shield 74

- ① Remove the three screws.
- ② Disconnect the two connectors.
- ③ Remove the DSP shield 74.

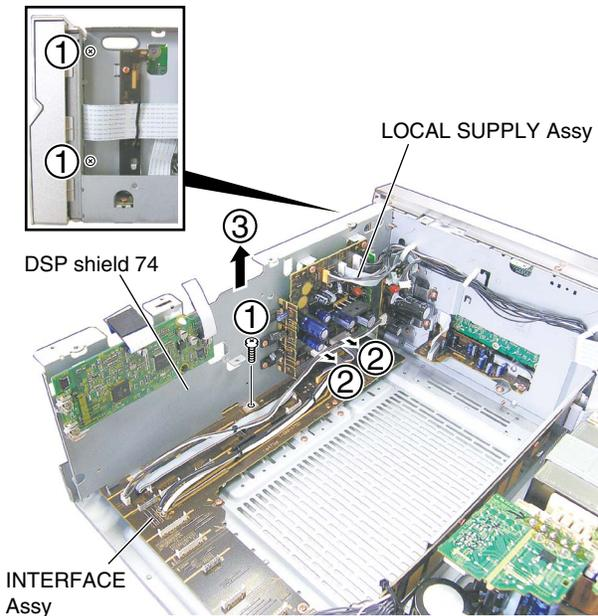

#### • INTERFACE Assy

- ① Remove the two screws.
- ② Remove the four screws.
- ③ Release the locking card spacer.

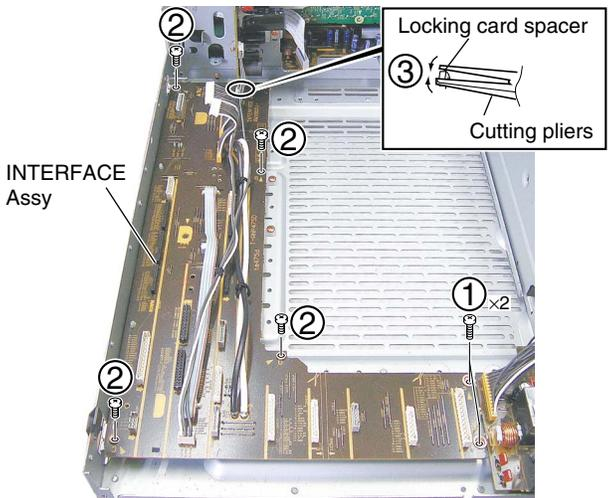

- ④ Remove the INTERFACE Assy.

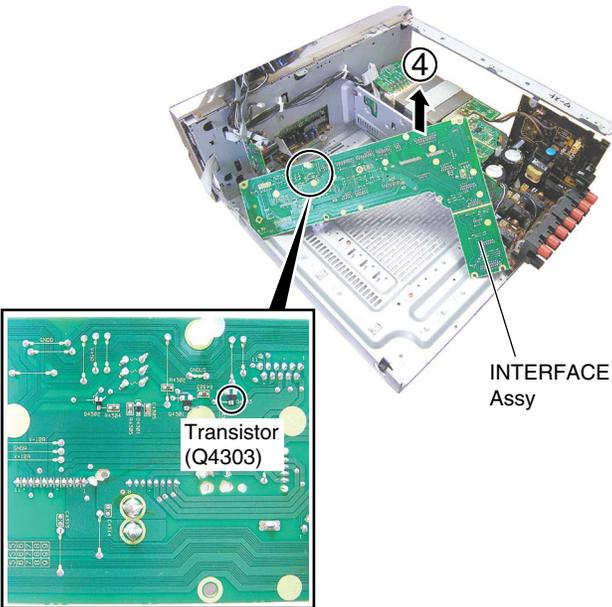

Replace

A  
B  
C  
D  
E  
F

### 3. How to diagnose the product with the Power Amp Block removed

The failure in the Power Amp Block is suspected as shown in the table below.

Symptom that is highly suspected to be caused by a failure in the Power Amp Block	Possible cause
① The power cannot be turned on, and the MCACC LED is flashing.	The DC detection circuit is activated in order to prevent extension of the failure.
② The unit is shut down after "AMP ERR" is displayed on the FL display. Then the unit goes into the state described in ① above.	<b>Note:</b> See "7.1.12 Failure Diagnosis of the Power Amp Block."
③ "OVER HEAT" is displayed on the FL display.	The posistors (TH5001 and TH5301) in the Power Amp Block are open. <b>Note:</b> The resistance of the thermistor at normal temperature is about 330 ohms.
④ The unit is shut down without an error message on the FL display. Then the PHASE CONTROL LED flashes.	Power Amp overloaded, defective overload-detection circuit in the Power Amp Block, etc.

Failure diagnosis with the power on is not possible for some board assys, because the large Power Amp Block lies in the way. However, if the Power Amp Block is removed, the thermistor connected to the Power Amp Block is disconnected, which will activate the protection circuits.

To enable failure diagnosis of those board assys, after the Power Amp Block is removed in the manner described below.

#### [Procedures]

- ① Remove the bonnet by removing the 22 screws.
- ② Remove the two screws.
- ③ Remove the four screws.
- ④ Disconnect the six connectors and one jumper.
- ⑤ Disconnect the flexible cable.

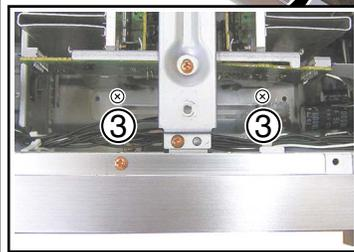
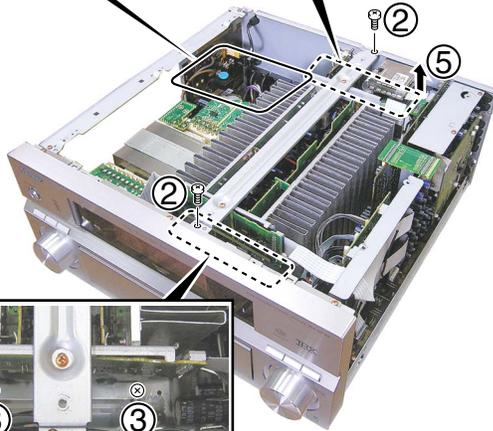
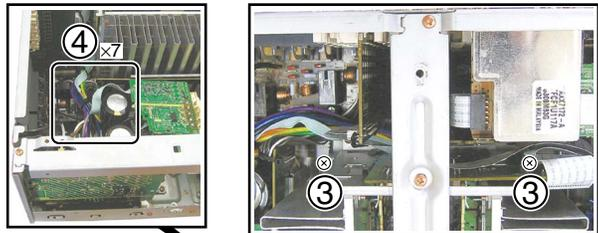

- ⑥ Remove the two nylon rivets.
- ⑦ Remove the POWER PROTECT Assy from the Power Amp Block.
- ⑧ Remove the Power Amp Block.

POWER PROTECT Assy

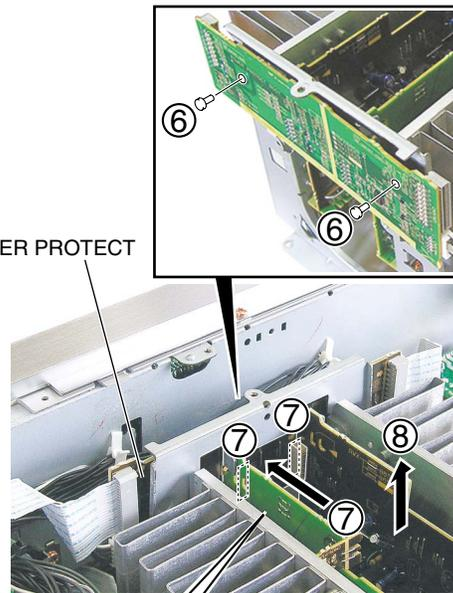

The POWER PROTECT Assy can be easily removed with no load applied to the connectors if you pull out the board by pushing on it at its center from the rear.

#### Note:

To prevent an electric shock hazard, after removing the Heat Sink Block, discharge the condenser of the  $\pm$ VL line, by discharging CN4101 or CN4102 on the SP/PS Assy, using a discharging resistor. (It is recommended to make a resistance of 100 ohms or more in the series-parallel connection, using four or more discharging resistors of 100 ohms, 3 W.)



- ⑨ Short circuit between pin8 (POSI\_1) and pin 9 (GND) of CN5701 of the POWER PROTECT Assy, and Pin 3 (POSI\_1) and pin 4 (GND) of CN5702 .

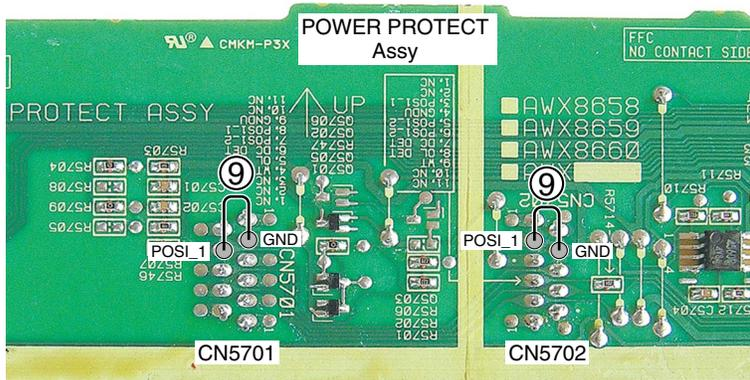

- ⑩ Turn the power on. (The power is on without the protection circuits activated.)



POWER PROTECT Assy



**Diagnose**

**⚠ Warning: Before putting the Power Amp Block back**

After performing a diagnosis, be sure to remove the inserted resistors. Also, be sure to discharge the electric charges of the VH line (charges of the electrolytic condenser) before putting the Power Amp Block back. (See "1. How to discharge when the Power Amp Block is removed.")

**Note:** If you connect the connectors without discharging, some parts, such as a resistor, may be damaged by the inrushing current.

## 7.1.12 FAILURE DIAGNOSIS OF THE POWER AMP BLOCK

If "AMP ERR" flashes on the FL display immediately after the power is turned on, then the unit is shut down, the power amplifier block is damaged, and DC voltage is output. In this case, either or both of the current and voltage amplifier block(s) is(are) damaged. Herein is described how to diagnose which block is in failure.

Most cases of damage in the power amplifier block are damage on the power transistor caused by excess power consumption, such as short-circuiting of the speaker terminals and use of low-impedance speakers that are not guaranteed. The failure diagnosis is therefore conducted on the current amplifier block first, then on the voltage amplifier block.

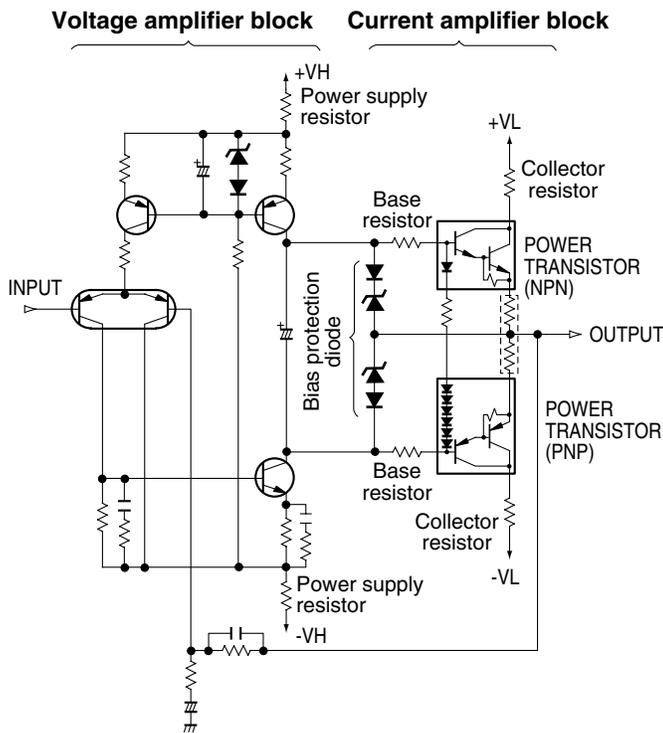

### Notes:

- During diagnosis of the amplifier block with the power on, if you touch a high-impedance circuit (in particular, both ends of 100-ohm base resistance of the power transistor) with the probe of an oscilloscope or a tester, the circuit may be damaged by oscillation of an oscilloscope or a tester.
- While a failure diagnosis is being conducted with the power on, do NOT touch parts other than the power, input, and output blocks.
- Only the points with CP (check point) marks in the schematic diagram can be diagnosed while the power is on.

### 1. Damage on the current amplifier block

#### Check of the power transistor and collector resistance of each channel, using a tester

##### Tips:

In most cases where the current amplifier block is damaged by an excess power consumption of the power transistor, damage is caused by short-circuiting between the collector and emitter. The collector resistor is open because of large collector current. In this case, the channel in failure can be identified by checking on which channel the resistance between C and E of the power transistor is  $0\ \Omega$  (some hundreds of ohms or less) and the collector resistance is  $\infty\ \Omega$ . As a damage scar appears on the surface of the part when the collector resistance is open, you can also check it by visual inspection.

##### Note:

Even if the result of the measurement of resistance with the tester shows that the power transistor is not short-circuited, that power transistor may be damaged if the paired push-pull power transistor has been damaged. Therefore, it is recommended to replace both parts when either needs to be replaced.

### 2. Damage on the voltage amplifier block

#### Check of the base resistance ( $100\ \Omega$ ) and voltage ( $\pm V_H$ ) resistance ( $4.7\ \Omega$ ) of each channel, using a tester

##### Tips:

In most cases, the voltage amplifier block is damaged by oscillation generated by a special load connection, a large-amplitude output at higher frequencies out of the audible range, or an influence of damage on the current amplifier block (power transistors). In many cases, the base resistance ( $100\ \Omega$ ) is damaged. It is necessary to check each part of the voltage amplifier block, as damage may have been extended to other parts.

In most cases, the resistors are open/damaged, or the transistors or diodes are short-circuited/damaged.

- The resistors must not be open (the resistance must not be higher than the indicated value).
- The terminals of transistors or diodes must not be short-circuited (the resistance must not be extremely low). (If the resistance is low but you are not sure if it is extremely low, compare the value with that of the normal channel.)

If the voltage amplifier block is damaged, the voltage ( $\pm V_H$ ) resistor ( $4.7\ \Omega$ ) may also be damaged.

### 3. Other damage

#### Check of the bias protection diodes

##### Tips:

If the power amplifier is damaged, the bias protection diodes may be deteriorated or open.

For a channel that has been diagnosed to be in failure, the  $V_f$  (forward descending voltage) of the four diodes must be checked to confirm that they are not deteriorated or open, using a tester, after repair of the amplifier. If these diodes are deteriorated, its distortion/frequency characteristics may be affected. If these diodes are open, the scale of damage on the power transistors may be extended if any abnormality is generated in the amplifier next time.

## 7.2 PARTS

### 7.2.1 IC

• The information shown in the list is basic information and may not correspond exactly to that shown in the schematic diagrams.

#### • List of IC

ADSP-21266SKSTZ-2D, TC7W139FU, CY7C1049CV33-12VXC, PEG116A, CD4094BPW, CD4094BNS, PEG117A, F2602E-01, AAT4618IGV-0.5-1, SN74LVC1G97DCK, Sii9031CTU, Sii9030CTU, ADV7400AKSTZ-80, PEG118A, PE5503A, PDC131A

#### ■ ADSP-21266SKSTZ-2D (DSP ASSY: IC101)

• DSP IC

#### • Pin Function

No.	Pin Name	I/O	Pin Function
1	VDDINT	–	Core power supply (+1.2V)
2	CLKCFG0	I	Core/CLKIN ratio control
3	CLKCFG1	I	Core/CLKIN ratio control
4	BOOTCFG0	I	Boot configuration select
5	BOOTCFG1	I	Boot configuration select
6	GND	–	Power supply return
7	VDDEXT	–	I/O power supply (+3.3V)
8	GND	–	Power supply return
9	VDDINT	–	Core power supply (+1.2V)
10	GND	–	Power supply return
11	VDDINT	–	Core power supply (+1.2V)
12	GND	–	Power supply return
13	VDDINT	–	Core power supply (+1.2V)
14	GND	–	Power supply return
15	FLAG0	I/O	Flag pin
16	FLAG1	I/O	Flag pin
17	AD7	I/O	Parrallel port address/Data
18	GND	–	Power supply return
19	VDDINT	–	Core power supply (+1.2V)
20	GND	–	Power supply return
21	VDDEXT	–	I/O power supply (+3.3V)
22	GND	–	Power supply return
23	VDDINT	–	Core power supply (+1.2V)
24	AD6	I/O	Parrallel port address/Data
25	AD5	I/O	Parrallel port address/Data
26	AD4	I/O	Parrallel port address/Data
27	VDDINT	–	Core power supply (+1.2V)
28	GND	–	Power supply return
29	AD3	I/O	Parrallel port address/Data
30	AD2	I/O	Parrallel port address/Data
31	VDDEXT	–	I/O power supply (+3.3V)
32	GND	–	Power supply return
33	AD1	I/O	Parrallel port address/Data
34	AD0	I/O	Parrallel port address/Data
35	WR	I	Parallel port write enable
36	VDDINT	–	Core power supply (+1.2V)
37	VDDINT	–	Core power supply (+1.2V)
38	GND	–	Power supply return
39	RD	O	Parallel port read enable
40	ALE	I	Parallel port address latch enable
41	AD15	I/O	Parrallel port address/Data
42	AD14	I/O	Parrallel port address/Data
43	AD13	I/O	Parrallel port address/Data
44	GND	–	Power supply return
45	VDDEXT	–	I/O power supply (+3.3V)
46	AD12	I/O	Parrallel port address/Data

A

No.	Pin Name	I/O	Function
47	VDDINT	–	Core power supply (+1.2V)
48	GND	–	Power supply return
49	AD11	I/O	Parrallel port address/Data
50	AD10	I/O	Parrallel port address/Data
51	AD9	I/O	Parrallel port address/Data
52	AD8	I/O	Parrallel port address/Data
53	DAI_P1 (SD0A)	I/O	Digital audio interface
54	VDDINT	–	Core power supply (+1.2V)
55	GND	–	Power supply return
56	DAI_P2 (SD0B)	I/O	Digital audio interface
57	DAI_P3 (SCLK0)	I/O	Digital audio interface
58	GND	–	Power supply return
59	VDDEXT	–	I/O power supply (+3.3V)
60	VDDINT	–	Core power supply (+1.2V)
61	GND	–	Power supply return
62	DAI_P4 (SFS0)	I/O	Digital audio interface
63	DAI_P5 (SD1A)	I/O	Digital audio interface
64	DAI_P6 (SD1B)	I/O	Digital audio interface
65	DAI_P7 (SCLK1)	I/O	Digital audio interface
66	VDDINT	–	Core power supply (+1.2V)
67	GND	–	Power supply return
68	VDDINT	–	Core power supply (+1.2V)
69	GND	–	Power supply return
70	DAI_P8 (SFS1)	I/O	Digital audio interface
71	DAI_P9 (SD2A)	I/O	Digital audio interface
72	VDDINT	–	Core power supply (+1.2V)
73	VDDEXT	–	I/O power supply (+3.3V)
74	GND	–	Power supply return
75	VDDINT	–	Core power supply (+1.2V)
76	GND	–	Power supply return
77	DAI_P10 (SD2B)	I/O	Digital audio interface
78	DAI_P11 (SD3A)	I/O	Digital audio interface
79	DAI_P12 (SD3B)	I/O	Digital audio interface
80	DAI_P13 (SCLK23)	I/O	Digital audio interface
81	DAI_P14 (SFS23)	I/O	Digital audio interface
82	DAI_P15 (SD4A)	I/O	Digital audio interface
83	VDDINT	–	Core power supply (+1.2V)
84	GND	–	Power supply return
85	GND	–	Power supply return
86	DAI_P16 (SD4B)	I/O	Digital audio interface
87	DAI_P17 (SD5A)	I/O	Digital audio interface
88	DAI_P18 (SD5B)	I/O	Digital audio interface
89	DAI_P19 (SCLK45)	I/O	Digital audio interface
90	VDDINT	–	Core power supply (+1.2V)
91	GND	–	Power supply return
92	GND	–	Power supply return
93	VDDEXT	–	I/O power supply (+3.3V)
94	DAI_P20 (SFS45)	I/O	Digital audio interface
95	GND	–	Power supply return

F

No.	Pin Name	I/O	Function
96	VDDINT	–	Core power supply (+1.2V)
97	FLAG2	I/O	Flag pin
98	FLAG3	I/O	Flag pin
99	VDDINT	–	Core power supply (+1.2V)
100	GND	–	Power supply return
101	VDDINT	–	Core power supply (+1.2V)
102	GND	–	Power supply return
103	VDDINT	–	Core power supply (+1.2V)
104	GND	–	Power supply return
105	VDDINT	–	Core power supply (+1.2V)
106	GND	–	Power supply return
107	VDDINT	–	Core power supply (+1.2V)
108	VDDINT	–	Core power supply (+1.2V)
109	GND	–	Power supply return
110	VDDINT	–	Core power supply (+1.2V)
111	GND	–	Power supply return
112	VDDINT	–	Core power supply (+1.2V)
113	GND	–	Power supply return
114	VDDINT	–	Core power supply (+1.2V)
115	GND	–	Power supply return
116	VDDEXT	–	I/O power supply (+3.3V)
117	GND	–	Power supply return
118	VDDINT	–	Core power supply (+1.2V)
119	GND	–	Power supply return
120	VDDINT	–	Core power supply (+1.2V)
121	$\overline{\text{RESET}}$	I	Processor reset
122	$\overline{\text{SPIDS}}$	I	Serial peripheral interface slave device select
123	GND	–	Power supply return
124	VDDINT	–	Core power supply (+1.2V)
125	SPICLK	I/O	Serial peripheral interface clock signal
126	MISO	I/O	SPI master in slave out
127	MOSI	I/O	SPI master out slave in
128	GND	–	Power supply return
129	VDDINT	–	Core power supply (+1.2V)
130	VDDEXT	–	I/O power supply (+3.3V)
131	AVDD	–	Analog power supply (+1.2V)
132	AVSS	–	Analog power supply return
133	GND	–	Power supply return
134	$\overline{\text{RSTOUT}}/\text{CLKOUT}$	O	Reset out/Local clock out
135	$\overline{\text{EMU}}$	O	Emulation status
136	TDO	O	Test data output (JTAG)
137	TDI	I	Test data input (JTAG)
138	$\overline{\text{TRST}}$	I	Test reset (JTAG)
139	TCK	I	Test clock (JTAG)
140	TMS	I	Test mode select (JTAG)
141	GND	–	Power supply return
142	CLKIN	I	Local clock in
143	XTAL	O	Crystal oscillator pin
144	VDDEXT	–	I/O power supply (+3.3V)

### TC7W139FU (DSP ASSY : IC104)

• 2-to-4 Line Decoder

#### ● Pin Arrangement (Top view)

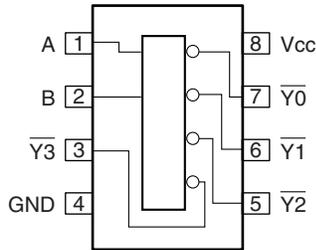

#### ● Truth Table

Inputs		Outputs				Selected Output
Select		$\overline{Y0}$	$\overline{Y1}$	$\overline{Y2}$	$\overline{Y3}$	
B	A					
L	L	L	H	H	H	$\overline{Y0}$
L	H	H	L	H	H	$\overline{Y1}$
H	L	H	H	L	H	$\overline{Y2}$
H	H	H	H	H	L	$\overline{Y3}$

### CY7C1049CV33-12VXC (DSP ASSY : IC106)

• 512k X 8 Static RAM

#### ● Pin Arrangement (Top view)

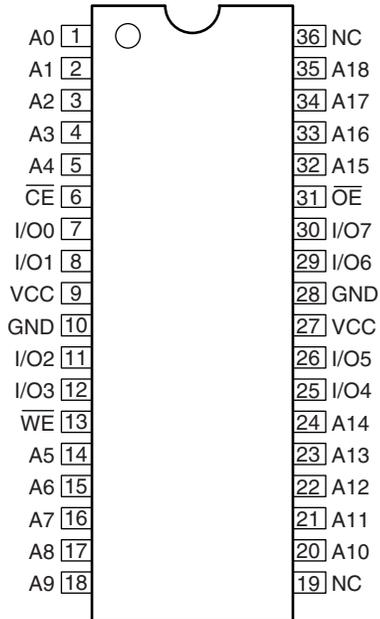

#### ● Block Diagram

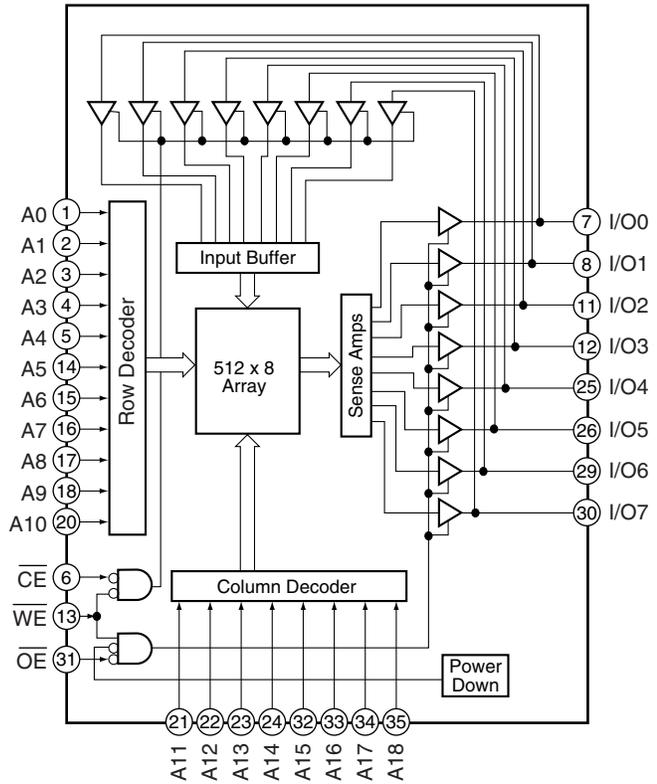

# PEG116A (DIGITAL MOTHER ASSY : IC101)

• Main Microcomputer

## • Pin Arrangement (Top view)

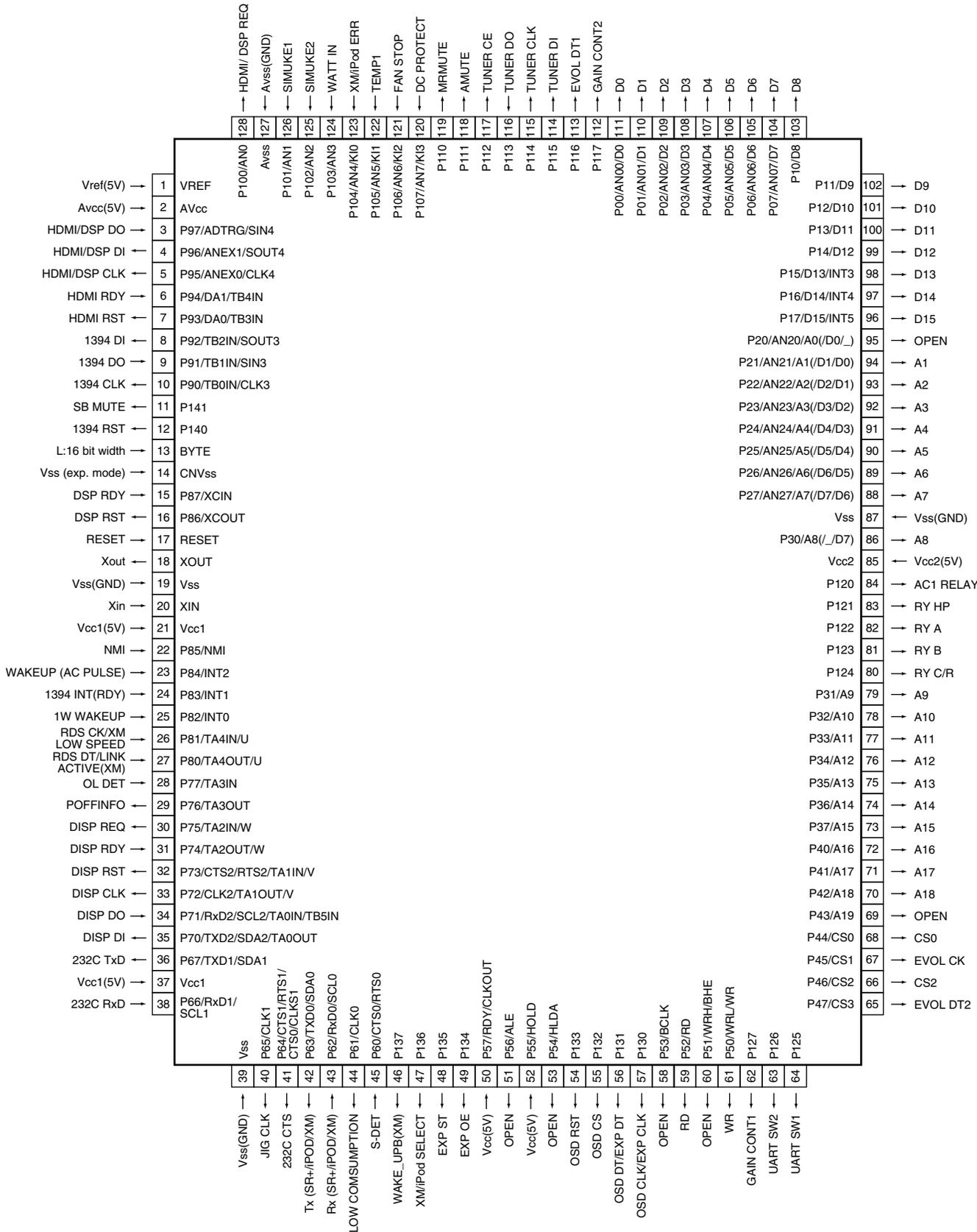

## ● Pin Function

No.	Mark	Pin Name	I/O	Pin Function
1	VREF	Vref(5V)	-	Reference voltage
2	AVcc	Avcc(5V)	-	Power supply (5V)
3	P97/ADTRG/SIN4	HDMI/DSP DO	I	Data input for HDMI/DSP microcomputer
4	P96/ANEX1/SOUT4	HDMI/DSP DI	O/L	Data output for HDMI/DSP microcomputer
5	P95/ANEX0/CLK4	HDMI/DSP CLK	O/L	Clock output for HDMI/DSP microcomputer
6	P94/DA1/TB4IN	HDMI RDY	I	Ready input for HDMI microcomputer
7	P93/DA0/TB3IN	HDMI RST	O/L	Reset output for HDMI microcomputer
8	P92/TB2IN/SOUT3	1394 DI	O/L	Communication with 1394 HOST controller
9	P91/TB1IN/SIN3	1394 DO	I	Communication with 1395 HOST controller
10	P90/TB0IN/CLK3	1394 CLK	O/L	Communication with 1396 HOST controller
11	P141	SB MUTE	O/L	Mute for SB ch (L:MUTE)
12	P140	1394 RST	O/L	Communication with 1396 HOST controller
13	BYTE	L:16 bit width		External flash bus width setting L= 16 bit, H= 8 bit.
14	CNVss	Vss(exp. mode)		Shift from single-chip mode to memory expanded mode.
15	P87/XCIN	DSP RDY	I	Communication with microcomputer Request input to the main
16	P86/XCOUT	DSP RST	O/L	Communication with DSP controller
17	RESET	RESET	I	Reset input from the main microcomputer
18	XOUT	Xout	O	Connect a ceramic resonator (15.7MHz).
19	Vss	Vss(GND)	-	Ground
20	XIN	Xin	I	Connect a ceramic resonator
21	Vcc1	Vcc1(5V)	-	Power supply(5V)
22	P85/NMI	NMI	I	-
23	P84/INT2	WAKEUP (AC PULSE)	( I )	AC pulse input
24	P83/INT1	1394 INT(RDY)	I	Communication with 1394 HOST controller
25	P82/INT0	1W WAKEUP	I	Communication with display microcomputer
26	P81/TA4IN/U	RDS CK/XM LOW SPEED	I	(RDS model) CLOCK IN/(XM) DATA IN
27	P80/TA4OUT/U	RDS DT/LINK ACTIVE(XM)	I	(RDS model) DATA IN/(XM) LINK signal
28	P77/TA3IN	OL DET	I	OVERLOAD detection (L: abnormality)
29	P76/TA3OUT	POFFINFO	O/L	Notice of power off to the DSP controller (Pull off an outlet)
30	P75/TA2IN/W	DISP REQ	O/L	Communication with display microcomputer
31	P74/TA2OUT/W	DISP RDY	I	Communication with display microcomputer
32	P73/CTS2/RTS2/TA1IN/V	DISP RST	O/H	Communication with display microcomputer
33	P72/CLK2/TA1OUT/V	DISP CLK	O/L	Communication with display microcomputer
34	P71/RxD2/SCL2/TA0IN/TB5IN	DISP DO	I	Communication with display microcomputer
35	P70/TXD2/SDA2/TA0OUT	DISP DI	O/L	Communication with display microcomputer
36	P67/TXD1/SDA1	232C TxD	O/L	RS-232C
37	Vcc1	Vcc1(5V)	-	Power supply (5V)
38	P66/RxD1/SCL1	232C RxD	I	RS-232C
39	Vss	Vss(GND)	-	Ground
40	P65/CLK1	JIG CLK		RS-232C
41	P64/CTS1/RTS1/CTS0/CLKS1	232C CTS	O/L	RS-232C
42	P63/TXD0/SDA0	Tx (SR+/iPOD/XM)	O/L	Communication with SR+/iPod/XM
43	P62/RxD0/SCL0	Rx (SR+/iPOD/XM)	I	Communication with SR+/iPod/XM
44	P61/CLK0	LOW CONSUMPTION	O/L	AMUTE power ON/OFF(ON: H)
45	P60/CTS0/RTS0	S-DET	I	S-VIDEO detection (H)
46	P137	WAKE_UPB(XM)	I	For XMDTcommunication
47	P136	XM/iPod SELECT	O/L	POD/XM path switch (iPod: L, XM: H)
48	P135	EXP ST	O/L	Communication with expansion IC
49	P134	EXP OE	O/L	Communication with expansion IC
50	P57/RDY/CLKOUT	Vcc(5V)	I	Vcc(5V)



No.	Mark	Pin Name	I/O	Pin Function
51	P56/ALE	OPEN	O/L	NC (Open at memory expanded mode)
52	P55/HOLD	Vcc(5V)	I	Vcc (5V)
53	P54/HLDA	OPEN	O/L	NC (Open at memory expanded mode )
54	P133	OSD RST	O/L	OSD communication
55	P132	OSD CS	O/L	OSD communication
56	P131	OSD DT/EXP DT	O/L	OSD communication & expansion IC communication
57	P130	OSD CLK/EXP CLK	O/L	OSD communication & expansion IC communication
58	P53/BCLK	OPEN	O/L	NC (Open at memory expanded mode)
59	P52/RD	RD	O/L	FLASH MEMORY I/F READ
60	P51/WRH/BHE	OPEN	O/L	FLASH MEMORY I/F WRITE
61	P50/WRL/WR	WR	O/L	FLASH MEMORY I/F WRITE
62	P127	GAIN CONT1	O/L	ANALOG GAIN CONTROL
63	P126	UART SW2	O/L	L: SR+ path, H: Select iPod or XM path
64	P125	UART SW1	O/L	L: DSP microcomputer path, H: Select HDMI microcomputer path
65	P47/CS3	EVOL DT2	O/L	Electronic VOL & function IC communication
66	P46/CS2	CS2	O/L	Electronic VOL & function IC communication
67	P45/CS1	EVOL CK	O/L	Electronic VOL & function IC communication
68	P44/CS0	CS0	O/L	FLASH MEMORY CE control
69	P43/A19	OPEN	O/L	Address output of FLASH MEMORY communication
70	P42/A18	A18	O/L	Address output of FLASH MEMORY communication
71	P41/A17	A17	O/L	Address output of FLASH MEMORY communication
72	P40/A16	A16	O/L	Address output of FLASH MEMORY communication
73	P37/A15	A15	O/L	Address output of FLASH MEMORY communication
74	P36/A14	A14	O/L	Address output of FLASH MEMORY communication
75	P35/A13	A13	O/L	Address output of FLASH MEMORY communication
76	P34/A12	A12	O/L	Address output of FLASH MEMORY communication
77	P33/A11	A11	O/L	Address output of FLASH MEMORY communication
78	P32/A10	A10	O/L	Address output of FLASH MEMORY communication
79	P31/A9	A9	O/L	Address output of FLASH MEMORY communication
80	P124	RY C/R	O/L	Center and surround SP relay (ON: H)
81	P123	RY B	O/L	SP-B relay (ON: H)
82	P122	RY A	O/L	SP-A relay (ON: H)
83	P121	RY HP	O/L	HP relay (ON: H)
84	P120	AC1 RELAY	O/L	AC relay (ON: H)
85	Vcc2	Vcc2(5V)	-	Power supply (5V)
86	P30/A8(/_/D7)	A8	O/L	Address output of FLASH MEMORY communication
87	Vss	Vss(GND)	-	Ground
88	P27/AN27/A7(/D7/D6)	A7	O/L	Address output of FLASH MEMORY communication
89	P26/AN26/A6(/D6/D5)	A6	O/L	Address output of FLASH MEMORY communication
90	P25/AN25/A5(/D5/D4)	A5	O/L	Address output of FLASH MEMORY communication
91	P24/AN24/A4(/D4/D3)	A4	O/L	Address output of FLASH MEMORY communication
92	P23/AN23/A3(/D3/D2)	A3	O/L	Address output of FLASH MEMORY communication
93	P22/AN22/A2(/D2/D1)	A2	O/L	Address output of FLASH MEMORY communication
94	P21/AN21/A1(/D1/D0)	A1	O/L	Address output of FLASH MEMORY communication
95	P20/AN20/A0(/D0/_)	OPEN	O/L	Address output of FLASH MEMORY communication
96	P17/D15/INT5	D15	O/L	Data input/output of FLASH MEMORY communication
97	P16/D14/INT4	D14	O/L	Data input/output of FLASH MEMORY communication
98	P15/D13/INT3	D13	O/L	Data input/output of FLASH MEMORY communication
99	P14/D12	D12	O/L	Data input/output of FLASH MEMORY communication
100	P13/D11	D11	O/L	Data input/output of FLASH MEMORY communication

A

No.	Mark	Pin Name	I/O	Pin Function
101	P12/D10	D10	O/L	Data input/output of FLASH MEMORY communication
102	P11/D9	D9	O/L	Data input/output of FLASH MEMORY communication
103	P10/D8	D8	O/L	Data input/output of FLASH MEMORY communication
104	P07/AN07/D7	D7	O/L	Data input/output of FLASH MEMORY communication
105	P06/AN06/D6	D6	O/L	Data input/output of FLASH MEMORY communication
106	P05/AN05/D5	D5	O/L	Data input/output of FLASH MEMORY communication
107	P04/AN04/D4	D4	O/L	Data input/output of FLASH MEMORY communication
108	P03/AN03/D3	D3	O/L	Data input/output of FLASH MEMORY communication
109	P02/AN02/D2	D2	O/L	Data input/output of FLASH MEMORY communication
110	P01/AN01/D1	D1	O/L	Data input/output of FLASH MEMORY communication
111	P00/AN00/D0	D0	O/L	Data input/output of FLASH MEMORY communication
112	P117	GAIN CONT2	O/L	ANALOG GAIN CONTROL
113	P116	EVOL DT1	O/L	Electronic VOL & function IC communication
114	P115	TUNER DI	O/L	TUNER module communication
115	P114	TUNER CLK	O/L	TUNER module communication
116	P113	TUNER DO	I	TUNER module communication
117	P112	TUNER CE	O/L	TUNER module communication
118	P111	AMUTE	O/L	AMUTE (L: MUTE, H: MUTE OFF)
119	P110	MRMUTE	O/L	MR MUTE (L: MUTE, H: MUTE OFF)
120	P107/AN7/KI3	DC PROTECT	I	DC abnormality detection (L detection)
121	P106/AN6/KI2	FAN STOP	I	FAN STOP detection (L at FAN turn: abnormal)
122	P105/AN5/KI1	TEMP1	I	Temperature detection (H: high temperature)
123	P104/AN4/KI0	XM/iPod ERR	I	(A/D) 0-2.0V: Normal, 2.0-3.5V: XM abnormality, 3.5-5.0V: iPod abnormality
124	P103/AN3	WATT IN	I	(A/D) Voltage detection for limiter control
125	P102/AN2	SIMUKE2	I	(A/D) Destination distinction
126	P101/AN1	SIMUKE1	I	(A/D) Destination distinction
127	Avss	Avss(GND)	-	Ground
128	P100/AN0	HDMI/ DSP REQ	O/L	REQ output for HDMI/DSP microcomputer

D

## ■ CD4094BPW (DIGITAL MOTHER ASSY: IC103)

- Expansion 2 IC

### ● Pin Function

No.	Pin Name	Pin Function	Active
1	232SW	Switch the RS232C path. L: MAIN controller, H: DSP controller	H
2	MRSP2	When SBCh outputs MR&S: H (Movement the same as MRSP)	H
3	FAN DRIVE	When FAN turns: H	H
4	INPUT ATT	H at ATT ON	H
5	12VON/OFF	Set to H when rewriting MAIN and DSP controllers.	H
6	XMPOW	XM antenna power supply. Always H. Set to L when detecting the abnormal.	H
7	iPodPOW	iPod supply power supply. Always H. Set to L when detecting the abnormal.	H
8	RDS FM+/XM RESET	Power supply ON/OFF of RDS decoder. H at ON. XM RESET. H at RESET. Notes: RESET of XMDTIC is L, but output with the reverse logic so that inverting circuit exists.	H/H

F

## ■ CD4094BNS (COMPONENT & VOL ASSY: IC2640)

- Expansion 1 IC

### ● Pin Function

No.	Pin Name	Pin Function	Active
1	NECK6	Outputs for limiter control	H
2	NECK8	Outputs for limiter control	H
3	BIAMP	At BIAMP: H	H
4	MRSP	When SBch is MR&S output: H	H
5	12TRG1	12V trigger 1 output	H
6	12TRG2	12V trigger 2 output	H
7	CDMIX	Cch setting: None LISTENING MODE : PURE DIRECT Playback stream: DVD-AUDIO (fs 44.1, 48, 88.2, 96kHz ch MULTI) or DSD (MULTI) or PCM (fs 44.1, 48, 88.2, 96kHz ch MULTI) • Do not turn on in 2 ch source. • When a device name of "PCM MULTI" is 1394 PC with i.LINK, converted DVD-AUDIO information into PCM from a DSP microcomputer. Cch setting: None Function: MULTI CH IN Turn the CENTER DOWN MIX off except the above-mentioned state.	H
8	DSPIN	At DSP root: H At analog direct root: L Condition 1: At Multi-ch-In selection Condition 2: At analog input with PURE DIRECT mode	H

## ■ CD4094BNS (COMPONENT & VOL ASSY: IC2407)

- Expansion IC

### ● Pin Function

No.	Pin Name	Pin Function	Active
1	CSW1	Component Func. SW	H
2	CSW2	Component Func. SW	H
3	CINH	IC2401,2402,2403 inhibit	H
4	XMSB	MR(ROOM2) / Selector of XM	H
5	C53B	Thr./VC Select	H
6	DSW1	D Func. SW	H
7	D53A	Thr.(D)/Component Select	H
8	DINH	IC1001,1002,1003,1004 inhibit	H

## ■ CD4094BPW (S VIDEO ASSY: IC2281)

- Expansion IC

### ● Pin Function

No.	Pin Name	Pin Function	Active
1	SSW1	S-Video Main Function	H
2	SSW2	S-Video Main Function	H
3	SSW3	S-Video Main Function	H
4	S52A	S-Video Through / VC / OSD / Mute select	H
5	S52B	S-Video Through / VC / OSD / Mute select	H
6	Vacant		H
7	Vacant		H
8	SINH	IC2201,2202 inhibit	H

## ■ CD4094BPW (S VIDEO ASSY: IC2282)

- Expansion IC

### ● Pin Function

No.	Pin Name	Pin Function	Active
1	SMRA	S-Video Room2 Function	H
2	SMRB	S-Video Room2 Function	H
3	SMRC	S-Video Room2 Function	H
4	SRC1	S-Video Recout Select	H
5	SRC2	S-Video Recout Select	H
6	Vacant		H
7	Vacant		H
8	Vacant		H

## ■ CD4094BNS (COMPOSITE V ASSY: IC2008)

- Expansion IC

### ● Pin Function

No.	Pin Name	Pin Function	Active
1	VSW1	CVBS Main Function	H
2	VSW2	CVBS Main Function	H
3	VSW3	CVBS Main Function	H
4	MRA	CVBS Room2 Function	H
5	MRB	CVBS Room2 Function	H
6	MRC	CVBS Room2 Function	H
7	V52A	CVBS Room2 CVBS/OSD select	H
8	V52B	CVBS Room2 CVBS/OSD select	H

## ■ CD4094BNS (COMPOSITE V ASSY: IC2009)

- Expansion IC

### ● Pin Function

No.	Pin Name	Pin Function	Active
1	V1M	CVBS Recout Selector	H
2	V2M	CVBS Recout Selector	H
3	VINH	IC2001 inhibit	H
4	MUTE	Video Mute	H
5	MRINH	IC2002,2205,2206 inhibit	H
6	SWA	CVBS Main Through/OSD/VC/Mute select	H
7	SWB	CVBS Main Through/OSD/VC/Mute select	H
8	SWC	CVBS Main Through/OSD/VC/Mute select	H



## ● Pin Function

No.	Mark	Pin Name	I/O	Pin Function
1	P94/DA1/TB4IN	DSP2SSI	I	Motorola DSP communication strobe
2	P93/DA0/TB3IN	DSP2BUSY	I	Motorola DSP busy input (at MCACC function)
3	P92/TB2IN/SOUT3	HDO	I	Data output of microcomputer communication to the main microcomputer
4	P91/TB1IN/SIN3	HDI	I	Data input of microcomputer communication from the main microcomputer
5	P90/TB0IN/CLK3	HCLK	I	Clock input of microcomputer communication from the main microcomputer
6	BYTE	BYTE	O	16 bit setting of the external FLASH bus-width
7	CNV <sub>ss</sub>	CNV <sub>ss</sub>	–	Shift from single-chip mode to memory expanded mode.
8	P87/XCIN	HRDY	I	Request output of microcomputer communication to the main microcomputer
9	P86/XCOUT	IRQ2	I	Motorola DSP busy input (at decoder function)
10	RESET	RESET	I	RESET input from the main microcomputer
11	XOUT	Xout	O	Connect a ceramic resonator (15.4MHz)
12	VSS	V <sub>ss</sub>	–	Ground
13	XIN	Xin	I	Connect a ceramic resonator
14	VCC	V <sub>cc</sub>	–	Power supply
15	P85/NMI	NMI	I	
16	P84/INT2	(USB UNLOCK)	I	(USB communication request: Plan)
17	P83/INT1	HREQ	I	Request input of microcomputer communication from the main microcomputer
18	P82/INT0	POFF	I	Power OFF signal
19	P81/TA4IN/U	DSP2RST	I	Motorola DSP reset
20	P80/TA4OUT/U	DSP1RST	I	1st DSP reset
21	P77/TA3IN	EXOE	I	OE output of the expansion IC
22	P76/TA3OUT	S DATA	I	Data output of the expansion IC
23	P75/TA2IN/W	S CLOCK	I	Clock output of the expansion IC
24	P74/TA2OUT/W	STB	I	Strobe output of the expansion IC
25	P73/CTS2/RTS2/TA1IN/V	CSN	I	Control CS output of DIR IC
26	P72/CLK2/TA1OUT/V	XPDN	I	DIR reset
27	P71/RxD2/SCL2/TA0IN/TB5IN	UNLK/(USB ERROR)	I	UNLOCK signal input/(USB error information input)
28	P70/TXD2/SDA2/TA0OUT	XMFS	I	XM FS information
29	P67/TXD1/SDA1	232C Tx	I	RS232C communication TxD(rewriting / control)
30	P66/RxD1/SCL1	232C Rx	I	RS232C communication RxD(rewriting / control)
31	P65/CLK1	JIGCLK	I	Rewriting
32	P64/CTS1/RTS1/CTS0/CLKS1	232C RTS	I	RS232C communication RTS(rewriting / control)
33	P63/TXD0/SDA0	CDTO/DA CDTO/(USB DTO)	I	DIR/DA/(USB) serial communication data output
34	P62/RxD0/SCL0	CDTI/(USB DTI)	I	DIR/(USB) serial communication data input
35	P61/CLK0	CCLK/DA CCLK/(USB CLK)	I	DIR/DA/(USB) serial communication clock output
36	P60/CTS0/RTS0	DACS1	I	Control CS output of DAC IC for F/R
37	P57/RDY/CLKOUT	XRDY	I	V <sub>cc</sub> (3.3V)
38	P56/ALE	ALE	O	NC (open at memory expanded mode)
39	P55/HOLD	XHOLD	I	V <sub>cc</sub> (3.3V)
40	P54/HLDA	XHLDA	O	NC (open at memory expanded mode)
41	P53/BCLK	BCLK	O	NC (open at memory expanded mode)
42	P52/RD	XOE	O	FLASH MEMORY I/F READ
43	P51/WRH/BHE	XWRH	O	FLASH MEMORY I/F WRITE
44	P50/WRL/WR	XWRL	O	FLASH MEMORY I/F WRITE
45	P47/CS3	XSMUTE	I	For last stage mute control
46	P46/CS2	XHDMI(RF UNLOCK)	I	For mute control of HDMI input (for RF UNLOCK detection)
47	P45/CS1	XSPDIF	I	For mute control of DIR input
48	P44/CS0	XCE	O	FLASH MEMORY CE control
49	P43/A19	A19	O	Address output of FLASH MEMORY communication
50	P42/A18	A18	O	Address output of FLASH MEMORY communication

No.	Mark	Pin Name	I/O	Pin Function
51	P41/A17	A17	O	Address output of FLASH MEMORY communication
52	P40/A16	A16	O	Address output of FLASH MEMORY communication
53	P37/A15	A15	O	Address output of FLASH MEMORY communication
54	P36/A14	A14	O	Address output of FLASH MEMORY communication
55	P35/A13	A13	O	Address output of FLASH MEMORY communication
56	P34/A12	A12	O	Address output of FLASH MEMORY communication
57	P33/A11	A11	O	Address output of FLASH MEMORY communication
58	P32/A10	A10	O	Address output of FLASH MEMORY communication
59	P31/A9	A9	O	Address output of FLASH MEMORY communication
60	Vcc2	Vcc	–	Power supply
61	P30/A8(/_/D7)	A8	O	Address output of FLASH MEMORY communication
62	Vss	Vss	–	Ground
63	P27/AN27/A7(/D7/D6)	A7	O	Address output of FLASH MEMORY communication
64	P26/AN26/A6(/D6/D5)	A6	O	Address output of FLASH MEMORY communication
65	P25/AN25/A5(/D5/D4)	A5	O	Address output of FLASH MEMORY communication
66	P24/AN24/A4(/D4/D3)	A4	O	Address output of FLASH MEMORY communication
67	P23/AN23/A3(/D3/D2)	A3	O	Address output of FLASH MEMORY communication
68	P22/AN22/A2(/D2/D1)	A2	O	Address output of FLASH MEMORY communication
69	P21/AN21/A1(/D1/D0)	A1	O	Address output of FLASH MEMORY communication
70	P20/AN20/A0(/D0/_)	A0	I	Do not connect at 16bit data access
71	P17/D15/INT5	D15	I	Data input/output of FLASH MEMORY communication
72	P16/D14/INT4	D14	I	Data input/output of FLASH MEMORY communication
73	P15/D13/INT3	D13	I	Data input/output of FLASH MEMORY communication
74	P14/D12	D12	I	Data input/output of FLASH MEMORY communication
75	P13/D11	D11	I	Data input/output of FLASH MEMORY communication
76	P12/D10	D10	I	Data input/output of FLASH MEMORY communication
77	P11/D9	D9	I	Data input/output of FLASH MEMORY communication
78	P10/D8	D8	I	Data input/output of FLASH MEMORY communication
79	P07/AN07/D7	D7	I	Data input/output of FLASH MEMORY communication
80	P06/AN06/D6	D6	I	Data input/output of FLASH MEMORY communication
81	P05/AN05/D5	D5	I	Data input/output of FLASH MEMORY communication
82	P04/AN04/D4	D4	I	Data input/output of FLASH MEMORY communication
83	P03/AN03/D3	D3	I	Data input/output of FLASH MEMORY communication
84	P02/AN02/D2	D2	I	Data input/output of FLASH MEMORY communication
85	P01/AN01/D1	D1	I	Data input/output of FLASH MEMORY communication
86	P00/AN00/D0	D0	I	Data input/output of FLASH MEMORY communication
87	P107/AN7/KI3	XDARST	I	DAC reset
88	P106/AN6/KI2	XM CSEL(IREQ3)	I	XM information (Control with the main microcomputer information)(3rd DSP FLAG0 input)
89	P105/AN5/KI1	IRQ1	I	1st DSP FLAG0 input
90	P104/AN4/KI0	DSP1 CS	I	1st DSP chip select
91	P103/AN3	ROWE	I	For DSP rewriting control
92	P102/AN2	MOT_MODE	I	For the Motorola operating state control
93	P101/AN1	MODEL	I	For model distinction (A/D input use)
94	AVSS	Avss	–	Ground
95	P100/AN0	DSPMUTE	I	DSP MUTE control output
96	VREF	Vref	–	Reference voltage
97	AVcc	Avcc	–	Power supply
98	P97/ADTRG/SIN4	DSP2MISO/DSP CDIN	I	DSP communication data input of Motorola/SHARC
99	P96/ANEX1/SOUT4	DSP2MOSI/DSP CDOUT	I	DSP communication data output of Motorola/SHARC
100	P95/ANEX0/CLK4	DSP2SCK/DSP CCLK	I	DSP communication clock output of Motorola/SHARC

## ■ CD4094BPW (DIGITAL MOTHER ASSY: IC203)

- Expansion 1 IC

### ● Pin Function

No.	Pin Name	Pin Function	Active
4	XPDNAD	AD IC reset H: Release the A/D reset, L: A/D reset	L
5	ADOSR	AD Over sampling setting Over-sampling at analog L: 88.2/96kHz, H: Others	H
6	DDIRECT	Digital Direct setting	H
7	XLSSN	LSSN setting H: When add a SW signal to the front in analog stage, L: Don't add	H
11	XTL0	DIR XTLO control	H
12	DACS2	DA chip select (for C,SW,S,SB ch )	L
13	MPCM	Multi PCM input selection	H
14	XM	XM input selection	H

## ■ CD4094BPW (DIGITAL MOTHER ASSY: IC211)

- Expansion 2 IC

### ● Pin Function

No.	Pin Name	Pin Function	Active
4	DS_2_32	32 bit transmission setting (Not used, "L" fixing)	H
5	MRXM	XM input setting to DA	H
6	DACS3	DA chip select (For +2 ch)	L
7	USB(RST3)	USB select (3rd DSP reset: plan)	H
11	DAX(SP3)	DSP3 CS output	H
12	DSD DIRECT	DSD Direct setting	H
13	XON	DSP X'tal ON/OFF control Crystal clock control of DSP H: 06 High model, L: 05 middle model	H
14	XIEEE	1394 input select	L



**F2602E-01 (DIGITAL MOTHER ASSY : IC281)**

• XM/DT IC

**Pin Arrangement (Top view)**

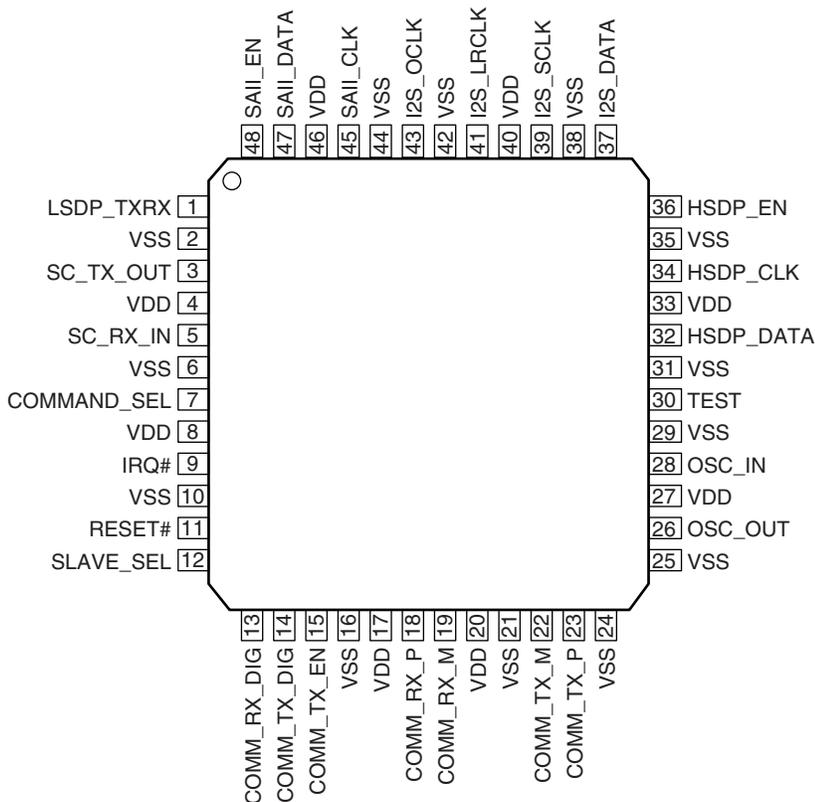

**Block Diagram**

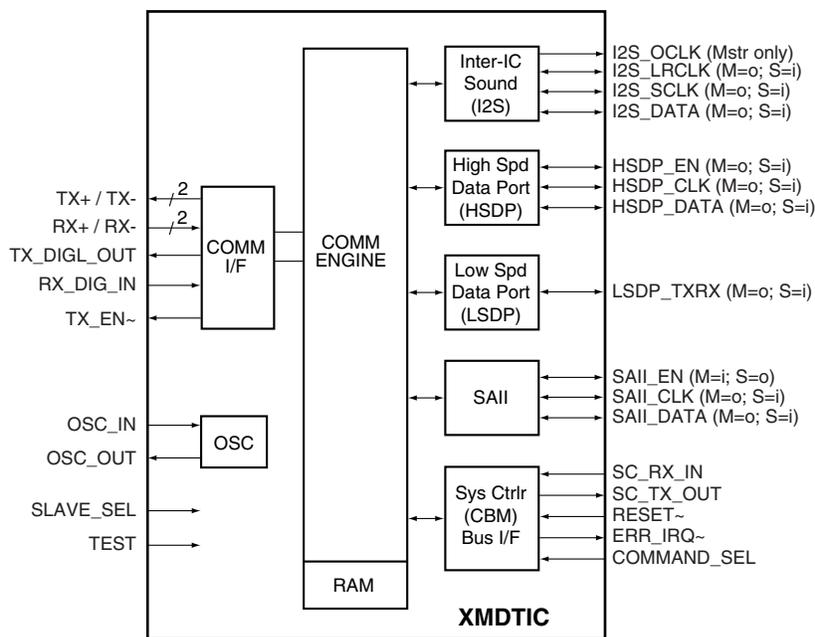

## ● Pin Function

No.	Pin Name	I/O	Function in Slave Mode	Function in MasterMode
1	LSDP_TXRX	S=I, M=O	Low speed data port output	Low speed data port input
2	VSS	–	Digital ground	Digital ground
3	SC_TX_OUT	S=O, M=O	System controller bus (CBM) transmit data out	System controller bus (CBM) transmit data out
4	VDD	–	+3.3V supply voltage	+3.3V supply voltage
5	SC_RX_IN	S=I, M=I	System controller bus (CBM) receive data in	System controller bus (CBM) receive data in
6	VSS	–	Digital ground	Digital ground
7	COMMAND_SEL	S=I, M=I	Command mode select in (1= Command mode, 0= Normal mode)	Command mode select in (1= Command mode, 0= Normal mode)
8	VDD	–	+3.3V supply voltage	+3.3V supply voltage
9	IRQ#	S=O, M=O	Interrupt request out (Active Low)	Interrupt request out (Active Low)
10	VSS	–	Digital ground	Digital ground
11	RESET#	S=I, M=I	Asynchronous reset in (Active Low)	Asynchronous reset in (Active Low)
12	SLAVE_SEL	S=I, M=I	M/S mode select in (High= Slave mode)	M/S mode select in (Low= Master mode)
13	COMM_RX_DIG	S=I, M=I	DT comm bus external transceiver receive data in	DT comm bus external transceiver receive data in
14	COMM_TX_DIG	O	DT comm bus external transceiver transmit data out	DT comm bus external transceiver transmit data out
15	COMM_TX_EN	O	DT comm bus external transceiver direction out (1= Transmit, 0= Receive)	DT comm bus external transceiver direction out (1= Transmit, 0= Receive)
16	VSS	–	Digital ground	Digital ground
17	VDD	–	+3.3V supply voltage	+3.3V supply voltage
18	COMM_RX_P	S=I, M=I	DT comm bus internal receiver differential positive in	DT comm bus internal receiver differential positive in
19	COMM_RX_M	S=I, M=I	DT comm bus internal receiver differential negative in	DT comm bus internal receiver differential negative in
20	VDD	–	+3.3V supply voltage	+3.3V supply voltage
21	VSS	–	Digital ground	Digital ground
22	COMM_TX_M	O	DT comm bus internal transmitter differential negative out	DT comm bus internal transmitter differential negative out
23	COMM_TX_P	O	DT comm bus internal transmitter differential positive out	DT comm bus internal transmitter differential positive out
24	VSS	–	Digital ground	Digital ground
25	VSS	–	Digital ground	Digital ground
26	OSC_OUT	O	Crystal output	Crystal output
27	VDD	–	+3.3V supply voltage	+3.3V supply voltage
28	OSC_IN	S=I, M=I	Crystal input	Crystal input
29	VSS	–	Digital ground	Digital ground
30	TEST	S=I, M=I	Factory test mode select (1= Test, 0= Normal oper.)	Factory test mode select (1= Test, 0= Normal oper.)
31	VSS	–	Digital ground	Digital ground
32	HSDP_DATA	S=I, M=O	High speed data port data input	High speed data port data output
33	VDD	–	+3.3V supply voltage	+3.3V supply voltage
34	HSDP_CLK	S=I, M=O	High speed data port clock input	High speed data port clock output
35	VSS	–	Digital ground	Digital ground
36	HSDP_EN	S=O, M=I	High speed data port enable output	High speed data port enable input
37	I2S_DATA	S=I, M=O	I2S digital port data in	I2S digital audio port data out
38	VSS	–	Digital ground	Digital ground
39	I2S_SCLK	S=I, M=O	I2S digital audio port bit clock in	I2S digital audio port bit clock out
40	VDD	–	+3.3V supply voltage	+3.3V supply voltage
41	I2S_LRCLK	S=I, M=O	I2S digital audio port L/R clock in	I2S digital audio port L/R clock out
42	VSS	–	Digital ground	Digital ground
43	I2S_OCLK	S=I, M=O	I2S digital audio port oversample clock (Not used.)	I2S digital audio port oversample clock out
44	VSS	–	Digital ground	Digital ground
45	SAII_CLK	S=O, M=I	SAII port clock output	SAII port clock input
46	VDD	–	+3.3V supply voltage	+3.3V supply voltage
47	SAII_DATA	S=O, M=I	SAII port data output	SAII port data input
48	SAII_REQ	S=I, M=O	SAII port request input	SAII port request output

## ■ AAT4618IGV-0.5-1 (DIGITAL MOTHER ASSY : IC282)

- Load Switching

### ● Pin Arrangement (Top view)

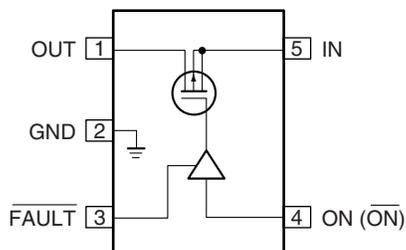

### ● Pin Function

No.	Pin Name	I/O	Pin Function
1	OUT	O	P-channel MOS FET drain
2	GND	-	Ground
3	FAULT	O	Open-drain FAULT output
4	ON (ON)	I	Enable input: 4618 active low, 4618- active high
5	IN	I	P-channel MOS FET source

## ■ SN74LVC1G97DCK (DIGITAL MOTHER ASSY : IC304, IC305, IC318)

- Configurable Multiple-function Gate

### ● Pin Arrangement (Top view)

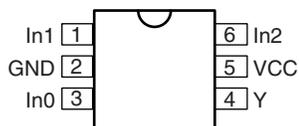

### ● Truth Table

INPUTS			OUTPUTS
In2	In1	In0	Y
L	L	L	L
L	L	H	L
L	H	L	H
L	H	H	H
H	L	L	L
H	L	H	H
H	H	L	L
H	H	H	H

H: High level  
L: Low level

### ● Logic Diagram (positive logic)

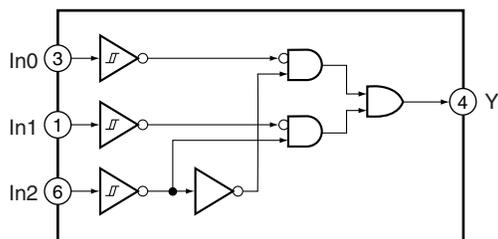

# SiI9031CTU (HDMI & DVC ASSY : IC101)

• HDMI PanelLink Cinema Receiver

## • Pin Arrangement (Top view)

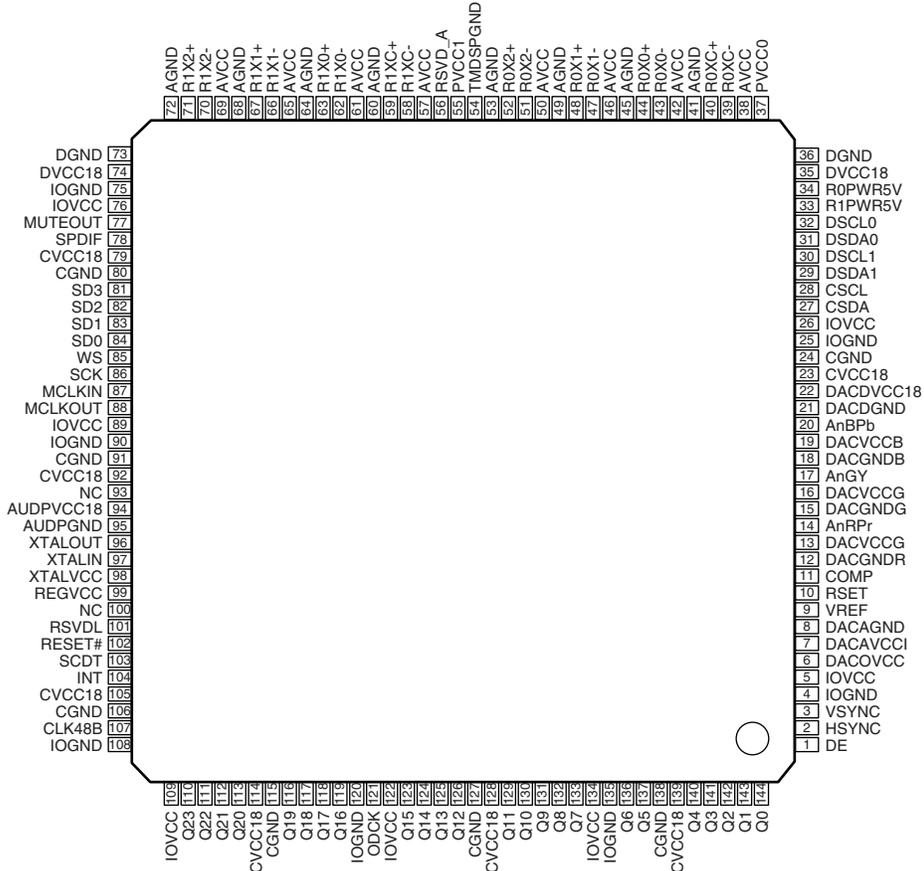

● Block Diagram

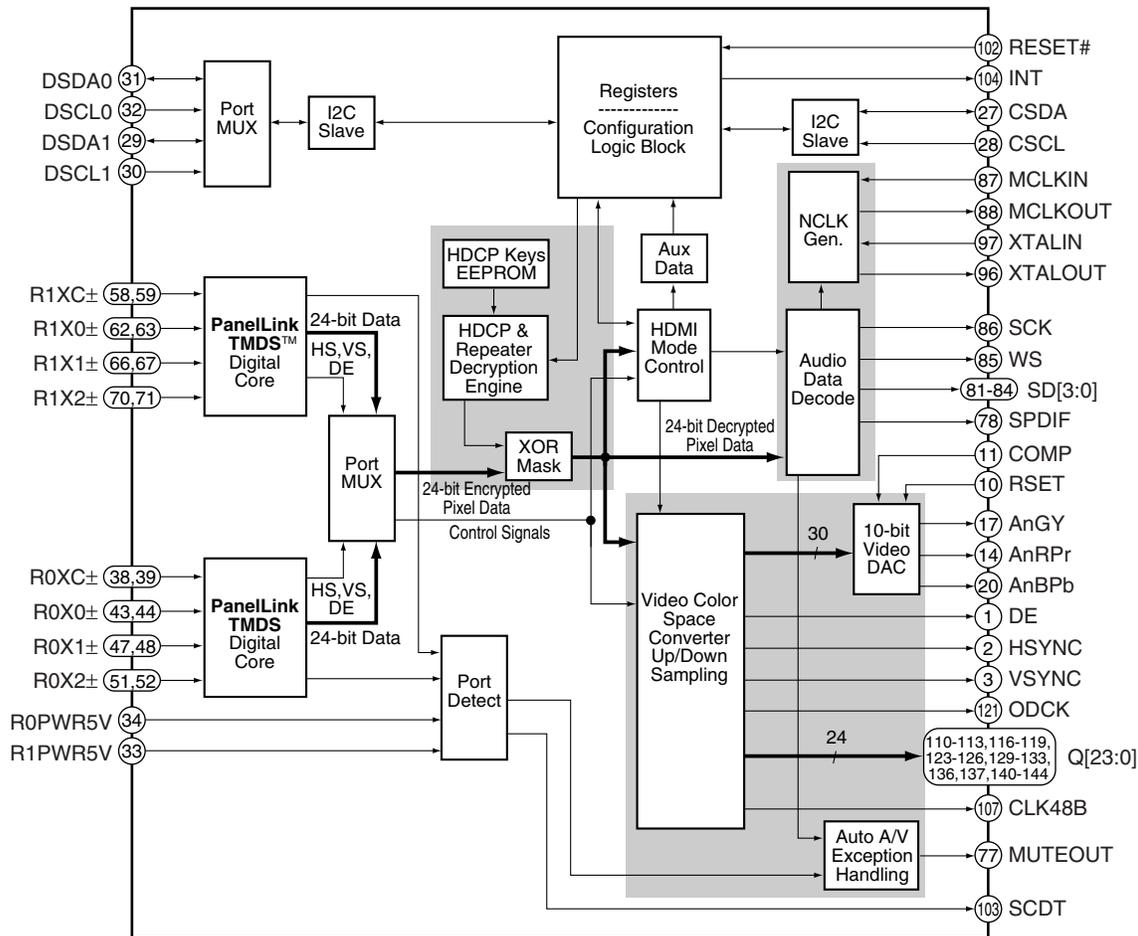

## ● Pin Function

No.	Pin Name	I/O	Function	No.	Pin Name	I/O	Function
1	DE	O	Data enable	41	AGND	–	TMDS analog GND
2	HSYNC	O	Horizontal sync output control signal	42	AVCC	–	TMDS analog VCC (3.3V)
3	VSYNC	O	Vertical sync output control signal	43	R0X0-	I	TMDS input data pair of HDMI port 0
4	IOGND	–	Input/Output pin GND	44	R0X0+	I	TMDS input data pair of HDMI port 0
5	IOVCC	–	Input/Output pin VCC (3.3V)	45	AGND	–	TMDS analog GND
6	DACOVCC	–	DAC output VCC (3.3V)	46	AVCC	–	TMDS analog VCC (3.3V)
7	DACAVCC	–	DAC Analog VCC (3.3V)	47	R0X1-	I	TMDS input data pair of HDMI port 0
8	DACAGND	–	DAC Analog GND	48	R0X1+	I	TMDS input data pair of HDMI port 0
9	VREF	–	Reference voltage	49	AGND	–	TMDS analog GND
10	RSET	I	Full scale adjust resistor	50	AVCC	–	TMDS analog VCC (3.3V)
11	COMP	I	Compensation	51	R0X2-	I	TMDS input data pair of HDMI port 0
12	DACGNDR	–	DAC Red GND	52	R0X2+	I	TMDS input data pair of HDMI port 0
13	DACVCCR	–	DAC Red VDD (3.3V)	53	AGND	–	TMDS analog GND
14	AnRPr	O	Analog video Red, Pr output	54	TMDSPGND	–	TMDS PLL GND
15	DACGNDG	–	DAC Green GND	55	PVCC1	–	TMDS port 1 PLL VCC (3.3V)
16	DACVCCG	–	DAC Green VDD (3.3V)	56	RSVD_A	–	Reserved, leave unconnected.
17	AnGY	O	Analog video Green, Y output	57	AVCC	–	TMDS analog VCC (3.3V)
18	DACGNDB	–	DAC Blue GND	58	R1XC-	I	TMDS input clock pair of HDMI port 1
19	DACVCCB	–	DAC Blue VDD (3.3V)	59	R1XC+	I	TMDS input clock pair of HDMI port 1
20	AnBPb	O	Analog video Blue, Pb output	60	AGND	–	TMDS analog GND
21	DACDGND	–	DAC Digital GND	61	AVCC	–	TMDS analog VCC (3.3V)
22	DACDVCC18	–	DAC Digital VCC (1.8V)	62	R1X0-	I	TMDS input data pair of HDMI port 1
23	CVCC18	–	Digital logic VCC (1.8V)	63	R1X0+	I	TMDS input data pair of HDMI port 1
24	CGND	–	Digital logic GND	64	AGND	–	TMDS analog GND
25	IOGND	–	Input/Output pin GND	65	AVCC	–	TMDS analog VCC (3.3V)
26	IOVCC	–	Input/Output pin VCC (3.3V)	66	R1X1-	I	TMDS input data pair of HDMI port 1
27	CSDA	Bi-Di	Configuration I2C data	67	R1X1+	I	TMDS input data pair of HDMI port 1
28	CSCL	I	Configuration I2C clock	68	AGND	–	TMDS analog GND
29	DSDA1	Bi-Di	DDC I2C data for port 1	69	AVCC	–	TMDS analog VCC (3.3V)
30	DSCL1	I	DDC I2C clock for port 1	70	R1X2-	I	TMDS input data pair of HDMI port 1
31	DSDA0	Bi-Di	DDC I2C clock for port 0	71	R1X2+	I	TMDS input data pair of HDMI port 1
32	DSCL0	I	DDC I2C data for port 0	72	AGND	–	TMDS analog GND
33	R1PWR5V	I	Port 1 transmitter detect	73	DGND	–	ACR PLL GND
34	R0PWR5V	I	Port 0 transmitter detect	74	DVCC18	–	ACR PLL Digital VCC (1.8V)
35	DVCC18	–	ACR PLL Digital VCC (1.8V)	75	IOGND	–	Input/Output pin GND
36	DGND	–	ACR PLL GND	76	IOVCC	–	Input/Output pin VCC (3.3V)
37	PVCC0	–	TMDS port 0 PLL VCC (3.3V)	77	MUTEOUT	O	Mute audio output
38	AVCC	–	TMDS analog VCC (3.3V)	78	SPDIF	O	S/PDIF audio output
39	R0XC-	I	TMDS input clock pair of HDMI port 0	79	CVCC18	–	Digital logic VCC (1.8V)
40	R0XC+	I	TMDS input clock pair of HDMI port 0	80	CGND	–	Digital logic GND

No.	Pin Name	I/O	Function	No.	Pin Name	I/O	Function
81	SD3	O	I2S serial data output	113	Q20	O	24-bit output pixel data bus
82	SD2	O	I2S serial data output	114	CVCC18	–	Digital logic VCC (1.8V)
83	SD1	O	I2S serial data output	115	CGND	–	Digital logic GND
84	SD0	O	I2S serial data output	116	Q19	O	24-bit output pixel data bus
85	WS	O	I2S word select output	117	Q18	O	24-bit output pixel data bus
86	SCK	O	I2S serial clock output	118	Q17	O	24-bit output pixel data bus
87	MCLKIN	I	Audio master clock input reference	119	Q16	O	24-bit output pixel data bus
88	MCLKOUT	O	Audio master clock output	120	IOGND	–	Input/Output pin GND
89	IOVCC	–	Input/Output pin VCC (3.3V)	121	ODCK	O	Output data clock
90	IOGND	–	Input/Output pin GND	122	IOVCC	–	Input/Output pin VCC (3.3V)
91	CGND	–	Digital logic GND	123	Q15	O	24-bit output pixel data bus
92	CVCC18	–	Digital logic VCC (1.8V)	124	Q14	O	24-bit output pixel data bus
93	NC	–	No connect	125	Q13	O	24-bit output pixel data bus
94	AUDPVCC18	–	ACR PLL VCC (1.8V)	126	Q12	O	24-bit output pixel data bus
95	AUDPGND	–	ACR PLL GND	127	CGND	–	Digital logic GND
96	XTALOUT	O	Crystal clock output	128	CVCC18	–	Digital logic VCC (1.8V)
97	XTALIN	I	Crystal clock input	129	Q11	O	24-bit output pixel data bus
98	XTALVCC	–	ACR PLL crystal input VCC (3.3V)	130	Q10	O	24-bit output pixel data bus
99	REGVCC	–	ACR PLL regulator VCC (3.3V)	131	Q9	O	24-bit output pixel data bus
100	NC	–	No connect	132	Q8	O	24-bit output pixel data bus
101	RSVDL	I	Reserved, must be tied Low.	133	Q7	O	24-bit output pixel data bus
102	RESET#	I	Reset pin Active Low.	134	IOVCC	–	Input/Output pin VCC (3.3V)
103	SCDT	O	Indicates active video at HDMI input port	135	IOGND	–	Input/Output pin GND
104	INT	O	Interrupt output	136	Q6	O	24-bit output pixel data bus
105	CVCC18	–	Digital logic VCC (1.8V)	137	Q5	O	24-bit output pixel data bus
106	CGND	–	Digital logic GND	138	CGND	–	Digital logic GND
107	CLK48B	Bi-Di	Data bus latch enable	139	CVCC18	–	Digital logic VCC (1.8V)
108	IOGND	–	Input/Output pin GND	140	Q4	O	24-bit output pixel data bus
109	IOVCC	–	Input/Output pin VCC (3.3V)	141	Q3	O	24-bit output pixel data bus
110	Q23	O	24-bit output pixel data bus	142	Q2	O	24-bit output pixel data bus
111	Q22	O	24-bit output pixel data bus	143	Q1	O	24-bit output pixel data bus
112	Q21	O	24-bit output pixel data bus	144	Q0	O	24-bit output pixel data bus

# ■ SiI9030CTU (HDMI & DVC ASSY : IC301)

● HDMI PanelLink Transmitter

## ● Pin Arrangement (Top view)

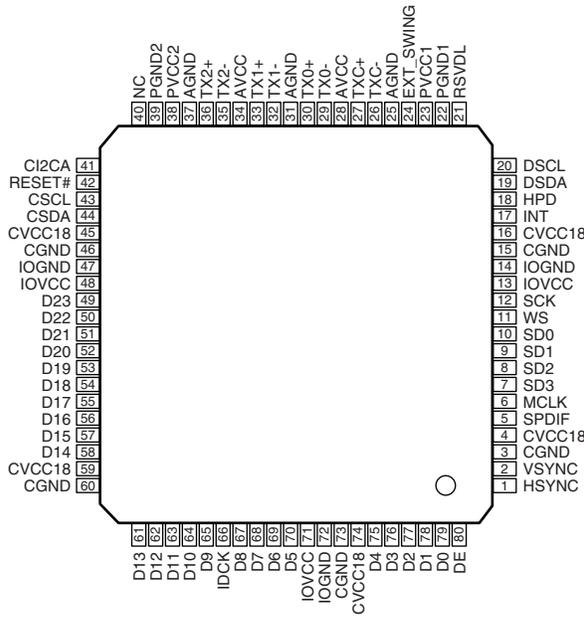

## ● Block Diagram

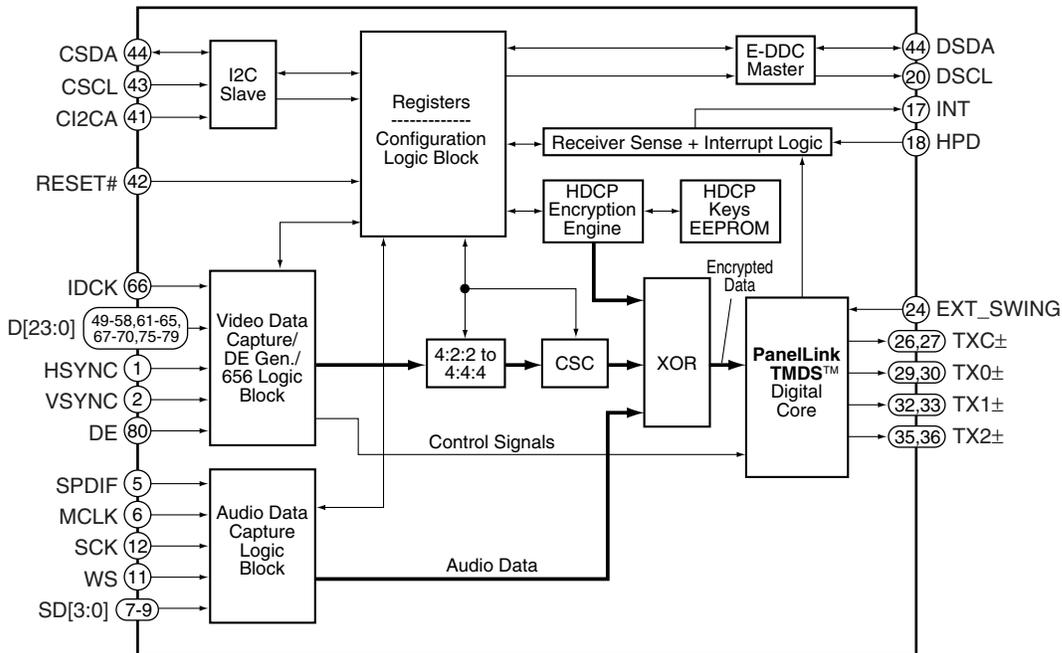



## ● Pin Function

No.	Pin Name	I/O	Function	No.	Pin Name	I/O	Function
1	HSYNC	I	Horizontal sync input control signal	41	CI2CA	I	I2C device address select
2	VSYNC	I	Vertical sync input control signal	42	RESET#	I	Reset pin (Active Low.)
3	CGND	–	Digital core GND	43	CSCL	I	I2C clock
4	CVCC18	–	Digital core VCC (1.8V)	44	CSDA	Bi-Di	I2C data (Open drain output)
5	SPDIF	I	S/PDIF audio input	45	CVCC18	–	Digital core VCC (1.8V)
6	MCLK	I	Audio input master clock	46	CGND	–	Digital core GND
7	SD3	I	I2S serial data	47	IOGND	–	IO pin GND
8	SD2	I	I2S serial data	48	IOVCC	–	IO pin VCC (3.3V)
9	SD1	I	I2S serial data	49	D23	I	12-bit input pixel data bus
10	SD0	I	I2S serial data	50	D22	I	12-bit input pixel data bus
11	WS	I	I2S word select	51	D21	I	12-bit input pixel data bus
12	SCK	I	I2S serial clock	52	D20	I	12-bit input pixel data bus
13	IOVCC	–	IO pin VCC (3.3V)	53	D19	I	12-bit input pixel data bus
14	IOGND	–	IO pin GND	54	D18	I	12-bit input pixel data bus
15	CGND	–	Digital core GND	55	D17	I	12-bit input pixel data bus
16	CVCC18	–	Digital core VCC (1.8V)	56	D16	I	12-bit input pixel data bus
17	INT	O	Interrupt output	57	D15	I	12-bit input pixel data bus
18	HPD	I	Hot plug detect input	58	D14	I	12-bit input pixel data bus
19	DSDA	Bi-Di	DDC data (Open drain output)	59	CVCC18	–	Digital core VCC (1.8V)
20	DSCL	Bi-Di	DDC clock	60	CGND	–	Digital core GND
21	RSVDL	I	Reserved for use by silicon image, and must be tied Low.	61	D13	I	12-bit input pixel data bus
22	PGND1	–	TMDS core PLL ground	62	D12	I	12-bit input pixel data bus
23	PVCC1	–	TMDS core PLL power (3.3V)	63	D11	I	12-bit input pixel data bus
24	EXT_SWING	I	Voltage swing adjust	64	D10	I	12-bit input pixel data bus
25	AGND	–	Analog GND	65	D9	I	12-bit input pixel data bus
26	TXC-	O	TMDS output clock pairs	66	IDCK	I	Input data clock
27	TXC+	O	TMDS output clock pairs	67	D8	I	12-bit input pixel data bus
28	AVCC	–	Analog VCC (3.3V)	68	D7	I	12-bit input pixel data bus
29	TX0-	O	TMDS output data pairs	69	D6	I	12-bit input pixel data bus
30	TX0+	O	TMDS output data pairs	70	D5	I	12-bit input pixel data bus
31	AGND	–	Analog GND	71	IOVCC	–	IO pin VCC (3.3V)
32	TX1-	O	TMDS output data pairs	72	IOGND	–	IO pin GND
33	TX1+	O	TMDS output data pairs	73	CGND	–	Digital core GND
34	AVCC	–	Analog VCC (3.3V)	74	CVCC18	–	Digital core VCC (1.8V)
35	TX2-	O	TMDS output data pairs	75	D4	I	12-bit input pixel data bus
36	TX2+	O	TMDS output data pairs	76	D3	I	12-bit input pixel data bus
37	AGND	–	Analog GND	77	D2	I	12-bit input pixel data bus
38	PVCC2	–	Filter PLL power (3.3V)	78	D1	I	12-bit input pixel data bus
39	PGND2	–	Filter PLL ground	79	D0	I	12-bit input pixel data bus
40	NC	–	Not connected	80	DE	I	Data enable

## ADV7400AKSTZ-80 (HDMI & DVC ASSY : IC401)

• Video Decoder IC

### • Pin Arrangement (Top view)

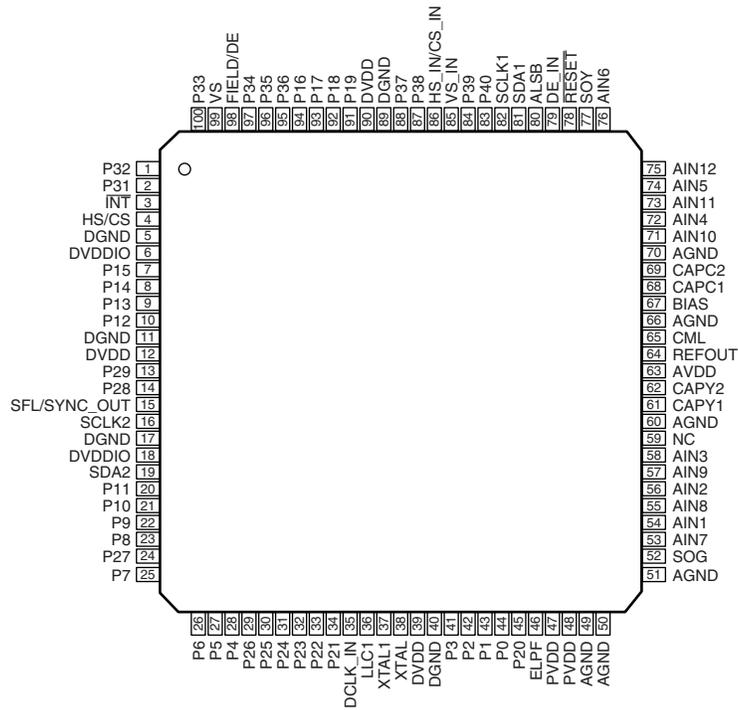

### • Pin Function

No.	Pin Name	I/O	Function	No.	Pin Name	I/O	Function
1	P32	I	Video pixel input port	11	DGND	–	Digital ground
2	P31	I	Video pixel input port	12	DVDD	–	Digital core supply voltage (1.8V)
3	INT	O	Interrupt pin	13	P29	I/O	Video pixel input/output port
4	HS/CS	O	H. Sync. output/digital composite sync. signal	14	P28	I/O	Video pixel input/output port
5	DGND	–	Digital ground	15	SFL/SYNC_OUT	O	Subcarrier frequency lock/SYNC_OUT is the sliced sync output signal only available in CP mode.
6	DVDDIO	–	Digital I/O supply voltage (3.3V)	16	SCLK2	I	I2C port serial clock input (max 400kHz)
7	P15	O	Video pixel output port	17	DGND	–	Digital ground
8	P14	O	Video pixel output port	18	DVDDIO	–	Digital I/O supply voltage (3.3V)
9	P13	O	Video pixel output port	19	SDA2	I/O	I2C port serial data input/output
10	P12	O	Video pixel output port	20	P11	I	Video pixel input port

No.	Pin Name	I/O	Function	No.	Pin Name	I/O	Function
21	P10	I	Video pixel input port	61	CAPY1	I	ADC capacitor network
22	P9	O	Video pixel output port	62	CAPY2	I	ADC capacitor network
23	P8	O	Video pixel output port	63	AVDD	–	Analog supply voltage (3.3V)
24	P27	I/O	Video pixel input/output port	64	REFOUT	O	Internal voltage reference output
25	P7	O	Video pixel output port	65	CML	O	Common-mode level pin for the internal ADCs
26	P6	O	Video pixel output port	66	AGND	–	Analog ground
27	P5	O	Video pixel output port	67	BIAS	O	External bias setting
28	P4	O	Video pixel output port	68	CAPC1	I	ADC capacitor network
29	P26	I/O	Video pixel input/output port	69	CAPC2	I	ADC capacitor network
30	P25	I/O	Video pixel input/output port	70	AGND	–	Analog ground
31	P24	I/O	Video pixel input/output port	71	AIN10	I	Analog video input channel
32	P23	I/O	Video pixel input/output port	72	AIN4	I	Analog video input channel
33	P22	I/O	Video pixel input/output port	73	AIN11	I	Analog video input channel
34	P21	I	Video pixel input port	74	AIN5	I	Analog video input channel
35	DCLK_IN	I	Clock input signal	75	AIN12	I	Analog video input channel
36	LLC1	O	Line-locked output clock for the pixel data output	76	AIN6	I	Analog video input channel
37	XTAL1	O	27MHz crystal connect pin	77	SOY	I	Sync on luma input
38	XTAL	I	Input pin for 27MHz crystal	78	RESET	I	System reset input
39	DVDD	–	Digital core supply voltage (1.8V)	79	DE_IN	I	Data enable input signal
40	DGND	–	Digital ground	80	ALSB	I	Selects the I2C address for the ADV7400A control and VBI readback port
41	P3	O	Video pixel output port	81	SDA1	I/O	I2C port serial data input/output
42	P2	O	Video pixel output port	82	SCLK1	I	I2C port serial clock input (max 400kHz)
43	P1	I	Video pixel input port	83	P40	I	Video pixel input port
44	P0	I	Video pixel input port	84	P39	I	Video pixel input port
45	P20	I	Video pixel input port	85	VS_IN	I	VS input signal
46	ELPF	O	The recommend external loop filter must be connected to this pin	86	HS_IN/CS_IN	I	Can be configured in CP mode to be either a digital HS input signal or a digital CS input signal used to extract timing in 5-wire or 4-wire RGB mode.
47	PVDD	–	PLL supply voltage (1.8V)	87	P38	I	Video pixel input port
48	PVDD	–	PLL supply voltage (1.8V)	88	P37	I	Video pixel input port
49	AGND	–	Analog ground	89	DGND	–	Digital ground
50	AGND	–	Analog ground	90	DVDD	–	Digital core supply voltage (1.8V)
51	AGND	–	Analog ground	91	P19	O	Video pixel output port
52	SOG	I	Sync on green input	92	P18	O	Video pixel output port
53	AIN7	I	Analog video input channel	93	P17	O	Video pixel output port
54	AIN1	I	Analog video input channel	94	P16	O	Video pixel output port
55	AIN8	I	Analog video input channel	95	P36	I	Video pixel input port
56	AIN2	I	Analog video input channel	96	P35	I	Video pixel input port
57	AIN9	I	Analog video input channel	97	P34	I	Video pixel input port
58	AIN3	I	Analog video input channel	98	FIELD/DE	O	Field sync signal output/data enable
59	NC	–	No connect pin	99	VS	O	Vertical sync output signal
60	AGND	–	Analog ground	100	P33	I	Video pixel input port



## ● Pin Function

No.	Mark	Pin Name	I/O	Pin Function
1	P96/ANEX1/SOUT4	HD_DO	O	Main controller communication
2	P95/ANEX0/CLK4	HD_SCK	I	Main controller communication
3	P94/DA1/TB4IN	VCRST	O	ADV7400A, ADV7172K
4	P93/DA0/TB3IN	I2CSELA	O	Access selection of EDID 1or 0 or Sil
5	P92/TB2IN/SOUT3	F/DE(NC)	O	
6	P91/TB1IN/SIN3	NC	O	Not connected
7	P90/TB0IN/CLK3	BOOT	O	
8	BYTE	GND		Ground
9	CNVss	CNVSS	-	CNVSS
10	P87/XCIN	FSEL0	O	IC601 FilterSelect
11	P86/XCOUT	FSEL1	O	IC601 FilterSelect
12	RESET	XRESET	O	Reset circuit of main controller communication
13	XOUT	XOUT	O	XTAL output
14	VSS	VSS	-	Ground
15	XIN	XIN	I	XTA input
16	VCC	VCC	-	3.3V power supply
17	P85/NMI	NMI	I	
18	P84/INT2	TXINT	I	Sil9030
19	P83/INT1	RXINT	I	Sil9031
20	P82/INT0	HD_REQI	I	REQ IN of main controller communication
21	P81/TA4IN/U	VSYNC	I	Not used
22	P80/TA4OUT/U	RXRST	O	Sil9031 RESET
23	P77/TA3IN	RXMUTE	I	Not used
24	P76/TA3OUT	ACLKOFF	O	For radio wave measures
25	P75/TA2IN/W	TXRST	O	Sil9030 reset
26	P74/TA2OUT/W	HD_REQO	O	REQ OUT of main controller communication
27	P73/CTS2/RTS2/TA1IN/V	VCINT(NC)	O	RDY_FP(INT) VIDEO DECODER
28	P72/CLK2/TA1OUT/V	MUTE	O	MUTE control
29	P71/RxD2/SCL/TA0IN/TB5IN	VC_SCL	O	Each IC (video converter)
30	P70/TXD2/SDA/TA0OUT	VC_SDA	O	Each IC
31	P67/TXD1/SDA1	USDA	O	Microcomputer rewriting connector / TX,RX
32	P66/RxD1/SCL1	USCL	O	Microcomputer rewriting connector / TX,RX
33	P65/CLK1	CLK1	O	Microcomputer rewriting connector / selector
34	P64/CTS1/RTS1/CTS0/CLKS1	CTS1	I	Microcomputer rewriting connector / 232C
35	P63/TXD0/SDA0	TXD0	O	232c
36	P62/RxD0/SCL0	RXD0	I	232c
37	P61/CLK0	I2CSELB	O	Access selection of EDID 1or 0 or Sil
38	P60/CTS0/RTS0	RTS0	O	232c
39	P57/RDY/CLKOUT	RDY	I	Open
40	P56/ALE	ALE	O	Open
41	P55/HOLD	HOLD	I	
42	P54/HLDA	HLDA	O	Open
43	P53/BCLK	BCLK	O	Open
44	P52/RD	GND	O	IC502 (for external Flash)
45	P51/WRH/BHE	WRH	O	IC502 open
46	P50/WRL/WR	WRL	O	IC502 (for external Flash)
47	P47/CS3	PUSEL	O	IC502 DDC communication 2.7k/4.7k resistor switch
48	P46/CS2	DSCL	O	IC502 I2C for DDC
49	P45/CS1	DSDA	O	IC502 I2C for DDC
50	P44/CS0	CS0	O	IC502 (for external Flash)

A

No.	Mark	Pin Name	I/O	Pin Function	
51	P43/A19	A19	O	Address output for IC502 (open)	
52	P42/A18	A18	O	Address output for IC502	
53	P41/A17	A17	O	Address output for IC502	
54	P40/A16	A16	O	Address output for IC502	
55	P37/A15	A15	O	Address output for IC502	
56	P36/A14	A14	O	Address output for IC502	
57	P35/A13	A13	O	Address output for IC502	
58	P34/A12	A12	O	Address output for IC502	
59	P33/A11	A11	O	Address output for IC502	
B	60	P32/A10	A10	O	Address output for IC502
61	P31/A9	A9	O	Address output for IC502	
62	Vcc	VCC	–	3.3V power supply	
63	P30/A8(/_/D7)	A8	O	Address output for IC502	
64	Vss	GND	–	Ground	
65	P27/A7(/D7/D6)	A7	O	Address output for IC502	
66	P26/A6(/D6/D5)	A6	O	Address output for IC502	
67	P25/A5(/D5/D4)	A5	O	Address output for IC502	
68	P24/A4(/D4/D3)	A4	O	Address output for IC502	
69	P23/A3(/D3/D2)	A3	O	Address output for IC502	
70	P22/A2(/D2/D1)	A2	O	Address output for IC502	
C	71	P21/A1(/D1/D0)	A1	O	Address output for IC502
72	P20/A0(/D0/_)	A0	O	Address output for IC502	
73	P17/D15/INT5	D15	I	Data input for IC502	
74	P16/D14/INT4	D14	I	Data input for IC502	
75	P15/D13/INT3	D13	I	Data input for IC502	
76	P14/D12	D12	I	Data input for IC502	
77	P13/D11	D11	I	Data input for IC502	
78	P12/D10	D10	I	Data input for IC502	
79	P11/D9	D9	I	Data input for IC502	
80	P10/D8	D8	I	Data input for IC502	
81	P07/D7	D7	I	Data input for IC502	
D	82	P06/D6	D6	I	Data input for IC502
83	P05/D5	D5	I	Data input for IC502	
84	P04/D4	D4	I	Data input for IC502	
85	P03/D3	D3	I	Data input for IC502	
86	P02/D2	D2	I	Data input for IC502	
87	P01/D1	D1	I	Data input for IC502	
88	P00/D0	D0	I	Data input for IC502	
89	P107/AN7/KI3	VINSEL1	O	IC602-pin 1 (MM1503XN)	
90	P106/AN6/KI2	SCDT	I	SiI9031	
91	P105/AN5/KI1	VCOE	O	Select RX or DVC L: Si9030, DVC output ON ,H: Si9030 Hz	
E	92	P104/AN4/KI0	HPDET0	O	Plug
93	P103/AN3	HPDET1	O	Plug	
94	P102/AN2	WP0	O	EDID	
95	P101/AN1	WP1	O	EDID	
96	AVSS	AVSS	–	Ground Connect to VSS.	
97	P100/AN0	VINSEL2	O		
98	VREF	VREF	–	3.3V Connect to VCC.	
99	AVcc	AVCC	–	3.3V Connect to VCC.	
100	P97/ADTRG/SIN4	HD_DI	I	Main controller communication	

F

# PE5503A (DISPLAY ASSY : IC3201)

• Display Microcomputer

## • Pin Arrangement (Top view)

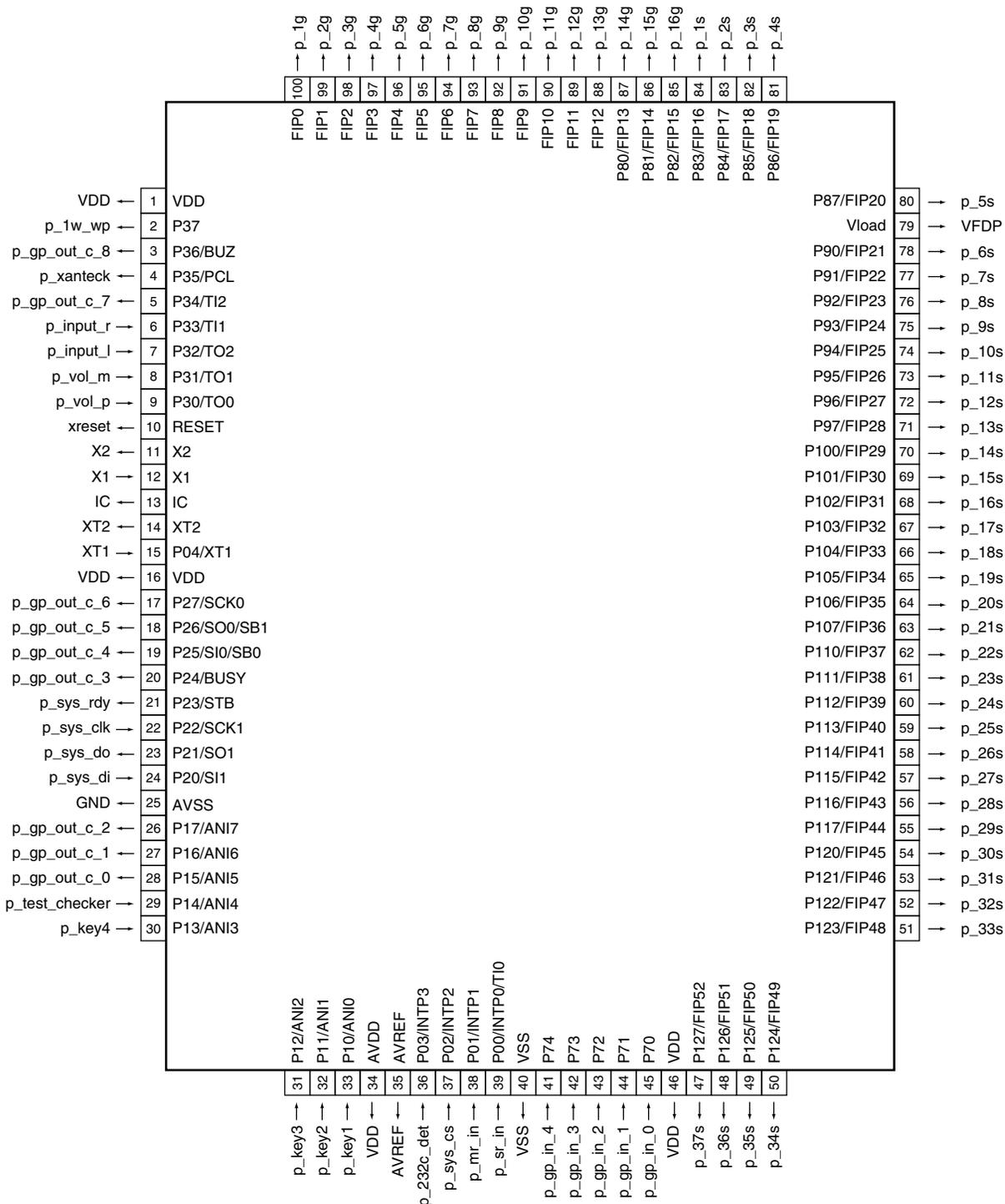

## ● Pin Function

No.	Mark	Pin Name	I/O	Pin Function
1	VDD	VDD	–	Positive power supply
2	P37	p_1w_wp	O	Main microcomputer start-up output corresponding to 1W
3	P36/BUZ	p_gp_out_c_8	O	General-purpose output (CMOS_8) for IR2SW (must be tied L)
4	P35/PCL	p_xantec	O	xantec correspondence L: set2 (PIONEER), H: set1 (others)
5	P34/TI2	p_gp_out_c_7	O	General-purpose output (CMOS_7)
6	P33/TI1	p_input_r	I	MULTIJOG
7	P32/TO2	p_input_l	I	MULTIJOG
8	P31/TO1	p_vol_m	I	vol(-)
9	P30/TO0	p_vol_p	I	vol(+)
10	RESET	xreset	–	Reset input
11	X2	X2	–	Connect a 5MHz crystal for X1 input clock oscillation
12	X1	X1	I	
13	IC	IC	–	
14	XT2	XT2	–	
15	P04/XT1	XT1	I	Pull-down (100k)
16	VDD	VDD	–	Positive power supply
17	P27/SCK0	p_gp_out_c_6	O	General-purpose output (CMOS_6)
18	P26/SO0/SB1	p_gp_out_c_5	O	General-purpose output (CMOS_5) ISO PHASE LED
19	P25/SI0/SB0	p_gp_out_c_4	O	General-purpose output (CMOS_4) MCACC LED
20	P24/BUSY	p_gp_out_c_3	O	General-purpose output (CMOS_3)
21	P23/STB	p_sys_rdy	O	RDY of Main microcomputer communication
22	P22/SCK1	p_sys_clk	I	CLK of Main microcomputer communication
23	P21/SO1	p_sys_do	O	Data output of Main microcomputer communication
24	P20/SI1	p_sys_di	I	Data input of Main microcomputer communication
25	AVSS	GND	–	A/D converter GND, same electric potential as the EVSS/VSS.
26	P17/ANI7	p_gp_out_c_2	O	General-purpose output (CMOS_2) DIGITAL PROCESSING LED
27	P16/ANI6	p_gp_out_c_1	O	General-purpose output (CMOS_1) HDMI LED
28	P15/ANI5	p_gp_out_c_0	O	General-purpose output (CMOS_0) i.LINK(upper model),DVC (lower model) LED
29	P14/ANI4	p_test_checker	I	Test mode input for checker pull-down by 100K
30	P13/ANI3	p_key4	I	Front key input (A/D)
31	P12/ANI2	p_key3	I	Front key input (A/D)
32	P11/ANI1	p_key2	I	Front key input (A/D)
33	P10/ANI0	p_key1	I	Front key input (A/D)
34	AVDD	VDD	–	Power supply
35	AVREF	AVREF	–	Reference voltage input of A/Dconverter
36	P03/INTP3	p_232c_det	I	232C signal detection A model without RS232C needs pull-up.
37	P02/INTP2	p_sys_cs	I	CS of Main microcomputer communication
38	P01/INTP1	p_mr_in	I	Multi room remote control signal input A model without IR needs pull-up.
39	P00/INTP0/TI0	p_sr_in	I	Main room remote control signal input
40	VSS	VSS	–	Ground
41	P74	p_gp_in_4	I	General-purpose input 4 Pull-down to GND when does not use.
42	P73	p_gp_in_3	I	General-purpose input 3 Pull-down to GND when does not use.
43	P72	p_gp_in_2	I	General-purpose input 2 Pull-down to GND when does not use.
44	P71	p_gp_in_1	I	General-purpose input 1 Pull-down to GND when does not use.
45	P70	p_gp_in_0	I	General-purpose input 0 Pull-down to GND when does not use.
46	VDD	VDD	–	Positive power supply
47	P127/FIP52	p_37s	O	FL drive
48	P126/FIP51	p_36s	O	FL drive
49	P125/FIP50	p_35s	O	FL drive
50	P124/FIP49	p_34s	O	FL drive



No.	Mark	Pin Name	I/O	Pin Function
51	P123/FIP48	p_33s	O	FL drive
52	P122/FIP47	p_32s	O	FL drive
53	P121/FIP46	p_31s	O	FL drive
54	P120/FIP45	p_30s	O	FL drive
55	P117/FIP44	p_29s	O	FL drive
56	P116/FIP43	p_28s	O	FL drive
57	P115/FIP42	p_27s	O	FL drive
58	P114/FIP41	p_26s	O	FL drive
59	P113/FIP40	p_25s	O	FL drive
60	P112/FIP39	p_24s	O	FL drive
61	P111/FIP38	p_23s	O	FL drive
62	P110/FIP37	p_22s	O	FL drive
63	P107/FIP36	p_21s	O	FL drive
64	P106/FIP35	p_20s	O	FL drive
65	P105/FIP34	p_19s	O	FL drive
66	P104/FIP33	p_18s	O	FL drive
67	P103/FIP32	p_17s	O	FL drive
68	P102/FIP31	p_16s	O	FL drive
69	P101/FIP30	p_15s	O	FL drive
70	P100/FIP29	p_14s	O	FL drive
71	P97/FIP28	p_13s	O	FL drive
72	P96/FIP27	p_12s	O	FL drive
73	P95/FIP26	p_11s	O	FL drive
74	P94/FIP25	p_10s	O	FL drive
75	P93/FIP24	p_9s	O	FL drive
76	P92/FIP23	p_8s	O	FL drive
77	P91/FIP22	p_7s	O	FL drive
78	P90/FIP21	p_6s	O	FL drive
79	Vload	VFDP	–	Connect a pull-down resistor of FIP controller/driver
80	P87/FIP20	p_5s	O	FL drive
81	P86/FIP19	p_4s	O	FL drive
82	P85/FIP18	p_3s	O	FL drive
83	P84/FIP17	p_2s	O	FL drive
84	P83/FIP16	p_1s	O	FL drive
85	P82/FIP15	p_16g	O	FL drive
86	P81/FIP14	p_15g	O	FL drive
87	P80/FIP13	p_14g	O	FL drive
88	FIP12	p_13g	O	FL drive
89	FIP11	p_12g	O	FL drive
90	FIP10	p_11g	O	FL drive
91	FIP9	p_10g	O	FL drive
92	FIP8	p_9g	O	FL drive
93	FIP7	p_8g	O	FL drive
94	FIP6	p_7g	O	FL drive
95	FIP5	p_6g	O	FL drive
96	FIP4	p_5g	O	FL drive
97	FIP3	p_4g	O	FL drive
98	FIP2	p_3g	O	FL drive
99	FIP1	p_2g	O	FL drive
100	FIP0	p_1g	O	FL drive

## ■ PDC131A (COMPOSITE V ASSY : IC2007)

• Character Generator IC

### ● Pin Arrangement (Top view)

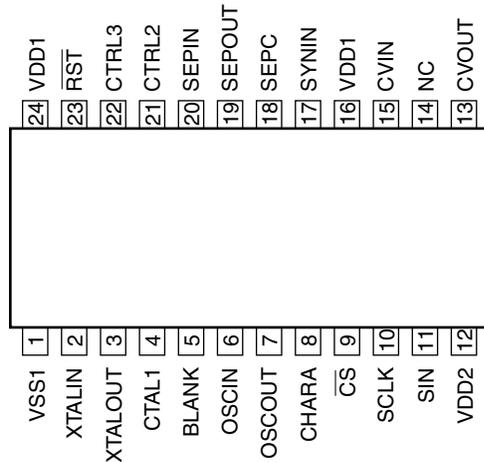

### ● Pin Function

No.	Pin Name	I/O	Pin Function
1	VSS1	–	Ground connection (digital system ground)
2	XtalIN	I	Crystal oscillator connection
3	XtalOUT	O	Crystal oscillator connection
4	CTRL1	I	Crystal oscillator input switching
5	BLANK	O	Outputs the blank signal
6	OSCIN	I	LC oscillator connection
7	OSCOUT	O	LC oscillator connection
8	CHARA	O	Outputs the character signal
9	CS	I	Serial data input enable input
10	SCLK	I	Serial data input clock input
11	SIN	I	Serial data input
12	VDD2	–	Power supply
13	CVOUT	O	Composite video signal output
14	NC	–	Must be either connected to ground or left open.
15	CVIN	I	Composite video signal input
16	VDD1	–	Power supply (+5 V: digital system power supply)
17	SYNIN	I	Video signal input for the built-in sync separator circuit
18	SEPC	I	Built-in sync separator circuit bias voltage monitor pin
19	SEPOUT	O	Built-in sync separator circuit composite sync signal output
20	SEPIN	I	Inputs a vertical synchronization signal created by integrating the SEPOUT pin output signal
21	CTRL2	I	NTSC/PAL-M switching input
22	CTRL3	I	Control whether or not the VSYNC signal is input to the SEPIN input
23	RST	I	System reset input
24	VDD1	–	Power supply (+5 V: digital system power supply)

# 8. PANEL FACILITIES

## Front panel

Illustration shows the VSX-74TXVi front panel

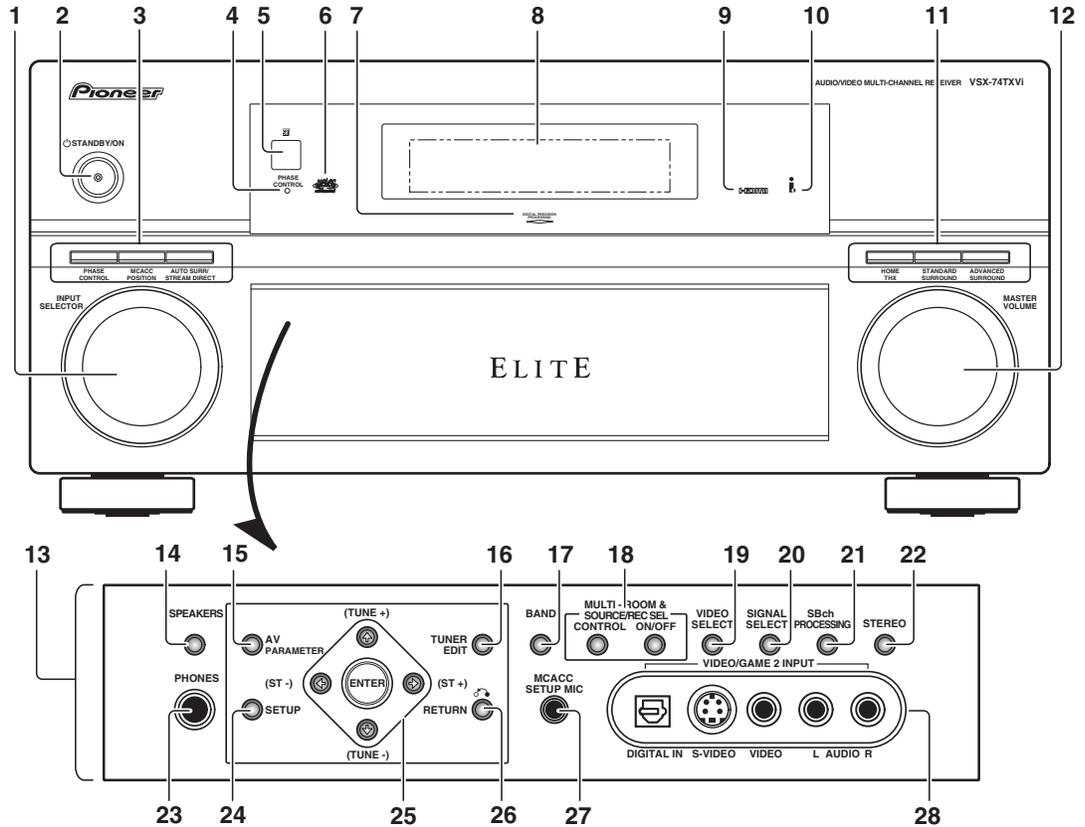

**1 INPUT SELECTOR dial**

Use to select an input source.

**2 STANDBY/ON**

Switches the receiver between on and standby. Power indicator lights when the receiver is on.

**3 PHASE CONTROL** - Press to switch on/off phase correction.

**MCACC POSITION** - Press to switch between MCACC presets.

**AUTO SURR / STREAM DIRECT** - Press to select Auto Surround or Stream Direct listening.

**4 PHASE CONTROL indicator**

Lights when Phase Control is switched.

**5 Remote sensor**

Receives the signals from the remote control (see Operating range of remote control unit ).

**6 MCACC indicator**

Lights when one of the MCACC presets is selected.

**7 Digital Precision Processing indicator**

Lights to indicate digital processing (for example, it disappears when Pure Direct is on, or when listening listening through the multichannel analog inputs).

**8 Character display**

See Display.

**9 HDMI indicator**

Blinks when connecting an HDMI-equipped component; lights when the component is connected.

**10 i.LINK indicator (VSX-74TXVi only)**

Lights when an i.LINK-Audio-equipped component is selected.

**DIGITAL VIDEO CONVERSION indicator (VSX-72TXV only)**

Lights when digital video conversion is enabled.

**11 Listening mode buttons**

**HOME THX** - Press to select a Home THX listening mode.

**STANDARD SURROUND** - Press for Standard decoding and to switch between the various **Pro Logic IIx** and **Neo:6** options.

**ADVANCED SURROUND** - Use to switch between the various surround modes.

**12 MASTER VOLUME dial****13 Front panel controls**

To access the front panel controls, push gently on the lower third portion of the panel with your finger.

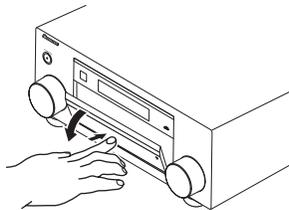
**14 SPEAKERS**

Use to change the speaker system.

**15 AV PARAMETER**

Use to access the AV options.

**16 TUNER EDIT**

Use with **←/→** to memorize and name stations for recall.

**17 BAND**

Switches between AM and FM radio bands.

**18 MULTI ROOM & SOURCE / REC SEL controls**

If you've made multi-room connections (see Multi-room listening) use these controls to control the sub room from the main room (see Using the multi-room controls).

You will also need to use the **REC SEL** controls when recording a source (see Making an audio or a video recording).

**19 VIDEO SELECT**

Press repeatedly to select the video source.

**20 SIGNAL SELECT**

Use to select an input signal.

**21 SBCh PROCESSING**

Selects the surround back channel mode or virtual surround back mode.

**22 STEREO**

Switches to stereo playback.

**23 PHONES jack**

Use to connect headphones. When the headphones are connected, there is no sound output from the speakers.

**24 SETUP**

Press to access the System Setup menu.

**25 ← → ↓ ↑ (TUNE/ST +/-) /ENTER**

Use the arrow buttons when setting up your surround sound system. Use the **TUNE +/-** buttons to find radio frequencies and use **ST +/-** to find preset stations.

**26 RETURN**

Press to confirm and exit the current menu screen.

**27 MCACC SETUP MIC jack**

Use to connect the supplied microphone.

**28 VIDEO/GAME 2 INPUT**

See Connecting a component to the front panel inputs.

**Operating range of remote control unit**

The remote control may not work properly if:

- There are obstacles between the remote control and the receiver's remote sensor.
- Direct sunlight or fluorescent light is shining onto the remote sensor.
- The receiver is located near a device that is emitting infrared rays.
- The receiver is operated simultaneously with another infrared remote control unit.

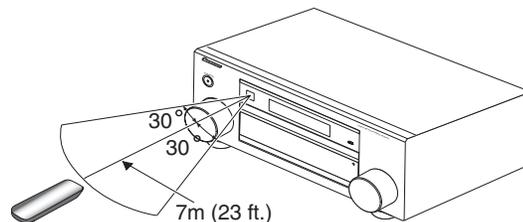

# Display

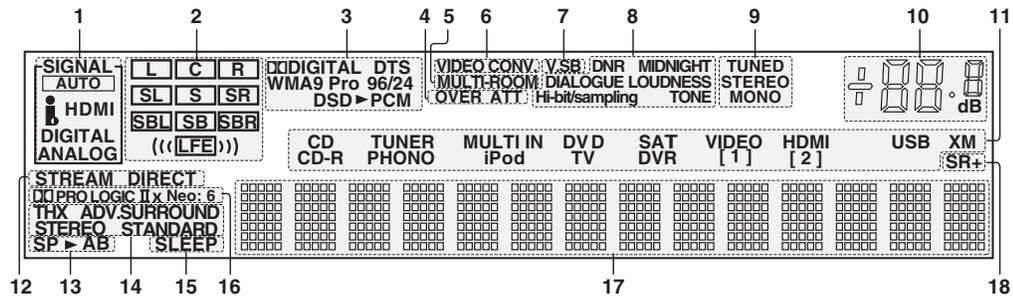

## 1 SIGNAL indicators

Light to indicate the currently selected input signal. **AUTO** lights when the receiver is set to select the input signal automatically.

## 2 Program format indicators

These change according to which channels are active in digital sources.

- L - Left front channel
- C - Center channel
- R - Right front channel
- SL - Left surround channel
- S - Surround channel (mono)
- SR - Right surround channel
- SBL - Left surround back channel
- SB - Surround back channel (mono)
- SBR - Right surround back channel
- LFE - Low frequency effects channel (the (( ( ))) indicators light when an LFE signal is being input)

## 3 Digital format indicators

Light when a signal encoded in the corresponding format is detected (**DSD ► PCM** lights during DSD (Digital Stream Direct) to PCM conversion with SACDs).

## 4 OVER / ATT

**OVER** lights to indicate that the level of an analog source is too high. **ATT** lights when you use the attenuator (**ANALOG ATT**) to reduce it.

## 5 MULTI-ROOM

Lights when the multi-room feature is active.

## 6 VIDEO CONV.

Lights when digital video conversion is enabled.

## 7 V.SB

Lights during Virtual surround back processing

## 8 Sound processing indicators

Light according to the active AV parameter(s)

## 9 TUNER indicators

**TUNED** - Lights when a broadcast is being received.

**STEREO** - Lights when a stereo FM broadcast is being received in auto stereo mode.

**MONO** - Lights when the mono mode is set using the **MPX** button.

## 10 Master volume level

Shows the overall volume level. **-80dB** indicates the minimum level, and **+12dB** indicates the maximum level.

## 11 Input source indicators

Light to indicate the input source you have selected.

## 12 STREAM DIRECT

Lights when Direct / Pure Direct is selected.

## 13 Speaker indicators

Lights to indicate the current speaker system, **A** and/or **B**.

## 14 Listening mode indicators

**THX** - Lights when one of the Home THX modes is selected.

**ADV. SURROUND** - Lights when one of the Advanced Surround modes has been selected.

**STEREO** - Lights when stereo listening is switched on (see Listening in stereo).

**STANDARD** - Lights when one of the Standard Surround modes is switched on (see Listening in surround sound).

## 15 SLEEP

Lights when the receiver is in sleep mode.

## 16 Matrix decoding format indicators

**PRO LOGIC IIx** - This lights to indicate Pro Logic II / Pro Logic IIx decoding

**Neo:6** - When one of the Neo:6 modes of the receiver is on, this lights to indicate Neo:6 processing

## 17 Character display

Displays various system information.

## 18 SR+

Lights when the SR+ mode is switched.

# Remote control

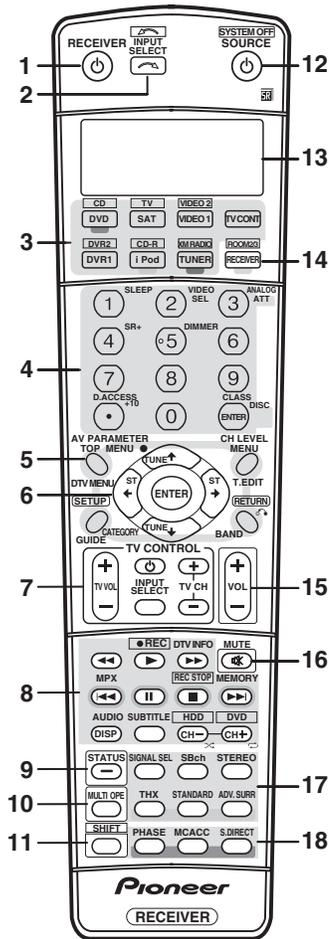

The remote has been conveniently color-coded according to component control using the following system (press the corresponding input source button to access):

- **Green** - Receiver controls (see below)
- **Red** - DVD controls
- **Blue** - Tuner/XM Radio controls
- **Yellow** - iPod controls
- **White** - Other controls

### 1 RECEIVER

This switches between standby and on for this receiver.

### 2 INPUT SELECT

Use to select the input source (use **SHIFT** for **INPUT SELECT**

### 3 Input source buttons

Press to select control of other components (see Controlling the rest of your system).

### 4 Number buttons and other receiver/component component controls

Use the number buttons to directly select a radio frequency or the tracks on a CD, DVD, etc.

**DISC (ENTER)** can be used to enter commands for TV or DTV, and also to select a disc in a multi-CD player.

Press **RECEIVER** first to access:

**SLEEP** - Use to put the receiver in sleep mode and select the amount of time before sleep.

**VIDEO SEL** - Press repeatedly to select the video source.

**ANALOG ATT** - Attenuates (lowers) the level of an analog input signal to prevent distortion.

**SR+** - Switches the SR+ mode on/off.

**DIMMER** - Dims or brightens the display.

Press **TUNER** first to access:

**D.ACCESS** - After pressing, you can access a radio station directly using the number buttons.

**CLASS** - Switches between the three banks (classes) of radio station presets.

### 5 Tuner/component control buttons/SETUP

These button controls can be accessed after you have selected the corresponding input source button (**DVD/LD, TV/SAT**, etc.). The **BAND** and **T.EDIT** tuner controls are explained. Press **RECEIVER** first to access the following controls:

**AV PARAMETER** - Use to access the AV options.

**SETUP** - Use to access the System Setup menu.

**CH LEVEL** - Press repeatedly to select a channel, then use **←/→** to adjust the level.

**RETURN** - Press to confirm and exit the current menu screen (also use to return to the previous menu with DVDs or to select closed captioning with DTV).

### 6 (TUNE / ST) / ENTER

Use the arrow buttons when setting up your surround sound system and the AV options. Also used to control DVD menus/options and for deck 1 of a double cassette deck player. Use the **TUNE** buttons to find radio frequencies and use **ST** to find preset stations.

### 7 TV CONTROL buttons

These buttons are dedicated to control the TV assigned to the **TV CONT** button. Thus if you only have one TV to hook up to this system assign it to the **TV CONT** input source button. If you have two TVs, assign the main TV to the **TV CONT** button.

**TV** - Use to turn on/off the power of the TV.

**TV VOL +/-** - Use to adjust the volume on your TV.

**INPUT SELECT** - Use to select the TV input signal.

**TV CH +/-** - Use to select channels.

## 8 Component control buttons

The main buttons (▶, ■, etc.) are used to control a component after you have selected it using the input source buttons.

The controls above these buttons can be accessed after you have selected the corresponding input source button (for example **DVD/LD**, **DVR/VCR** or **TV/SAT** (when connected to a DTV)). The following controls can be accessed when listening to the built-in tuner:

**MPX** - Switches between stereo and mono reception of FM broadcasts. If the signal is weak then switching to mono will improve the sound quality.

**DISP** - Switches between named station presets and radio frequencies.

## 9 STATUS

Press to check selected receiver settings.

## 10 MULTIOPE

Use this button to perform multi operations.

## 11 SHIFT

Press to access the controls outlined in white boxes (for example, **INPUT SELECT** ) , or to display the currently selected input source in the remote control LCD.

## 12 SOURCE

Press to turn on/off other components connected to the receiver.

## 13 Character display (LCD)

This display shows information when transmitting control signals.

The following commands are shown when you're setting the remote to control other components (see Controlling the rest of your system):

**SETUP** - Indicates the setup mode, from which you choose the options below.

**PRESET** - See Selecting preset codes directly.

**LEARNING** - See Programming signals from other remote controls.

**MULTI OP** - See Multi Operation and System Off.

**SYS OFF** - See Multi Operation and System Off.

**DIRECT F** - See Direct function.

**RENAME** - See Renaming input source names.

**ERASE** - See Erasing one of the remote control button settings.

**RESET** - See Resetting the remote control presets.

**READ ID** - See Confirming preset codes.

## 14 RECEIVER

Switches the remote to control the receiver (used to select the green commands above the number buttons (**ANALOG ATT**, etc). Also use this button to set up surround sound. With **SHIFT**, this selects selects the multi-room control, shown in the display as **RCV/RM2**, **RCV/RM3**.

## 15 VOL +/-

Use to set the listening volume.

## 16 MUTE

Mutes the sound or restores the sound if it has been muted (adjusting the volume also restores the sound).

## 17 Receiver controls

**SIGNAL SEL** - Use to select an input signal.

**SBch** - Use to select the surround/virtual back channel mode.

**STEREO** - Switches between direct and stereo playback. Direct playback bypasses the tone controls and any other signal processing for the most accurate reproduction of a source.

**THX** - Press to select a Home THX listening mode.

**STANDARD** - Press for Standard decoding and to switch between the various Pro Logic IIx and Neo:6 options.

**ADV.SURR** - Use to switch between the various surround modes.

## 18 PHASE - Press to switch on/off phase correction.

**MCACC** - Press to switch between MCACC presets .

**S.DIRECT** - Press to select Auto Surround or Stream Direct listening.

## Rear panel

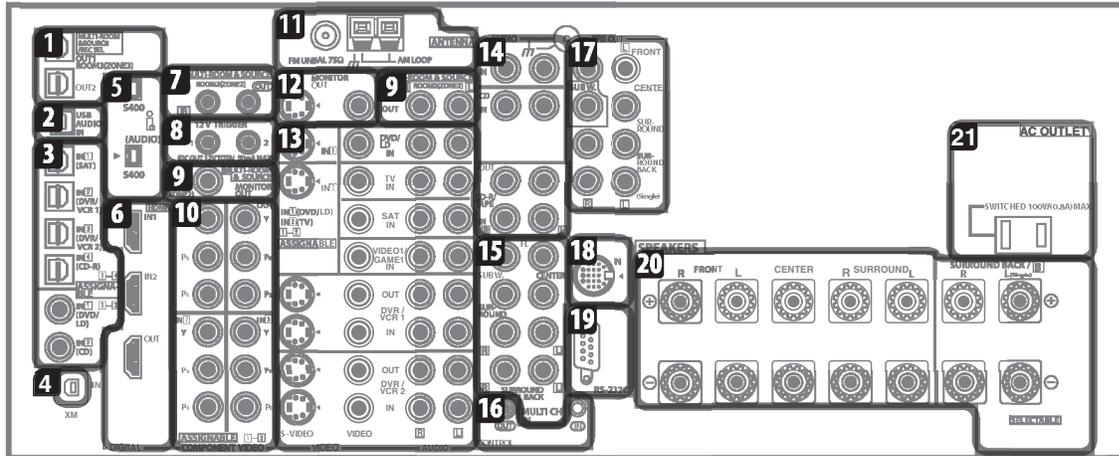

### Caution

- Before making or changing the connections, switch off the power and disconnect the power cord from the power outlet. Plugging in should be the final step.

#### 1 Optical digital audio output(s)

Use the **OUT1** and (VSX-74TXVi only) **OUT2** jack according to a CD or MiniDisc recorder.

- Connecting digital audio sources.

The **OUT1** jack is also used for multi-room connections.

- Multi-room listening.

#### 2 USB audio input (VSX-74TXVi only)

Use to connect your PC as an audio source.

- Using the USB interface.

#### 3 Optical and coaxial digital audio inputs (x6)

Use for digital audio sources, including DVD players/recorders, digital satellite receivers, CD players, etc.

- See also The Input Setup menu to assign the inputs.

#### 4 XM Radio input

- See Using XM Radio.

#### 5 S-400 i.LINK connectors (x2) (VSX-74TXVi only)

Use to connect other i.LINK audio devices for high-resolution, multichannel digital audio input/output.

- Using the i.LINK interface.

#### 6 HDMI connectors (x3)

Two inputs and one output for high-quality audio/video connection to compatible HDMI devices.

- Connecting using HDMI.

#### 7 Remote input (multi-room and source)

Use for connection to an external remote control sensor for use in a multi-room setup, for example.

- Connecting an IR receiver.

#### 8 12V trigger jacks (total 50 mA max.) (x2)

Use to switch components in your system on and off according to the input function of the receiver.

- Switching components on and off using the 12 volt trigger.

#### 9 Multi-room and source outputs

Use to connect a second amplifier in a separate room.

- Multi-room listening.

#### 10 Component video connections (x4)

Use the inputs to connect any video source that has component video output, such as a DVD recorder. Use the output for connection to a monitor TV.

- Using the component video jacks.

#### 11 AM and FM antenna terminals

Use to connect indoor or outdoor antennas for radio broadcasts.

- Connecting antennas.



**12 Composite and S-video monitor outputs**

Use to connect monitors and TVs.

→ Connecting your TV and DVD player.

**13 Audio/video source inputs/(outputs) (x6)**

Use for connection to audio/visual sources, such as DVD players/recorders, VCRs, etc. Each set of inputs has jacks for composite video, S-video<sup>1</sup> and stereo analog audio.

→ Connecting a DVD/HDD recorder, VCR and other video sources.

**14 Stereo analog audio source inputs/(outputs) (x3)**

Use for connection to audio sources such as CD players, tape decks, turntables, etc.

→ Connecting analog audio sources.

**15 Multichannel analog audio inputs**

7.1 channel inputs for connection to a DVD player with multichannel analog outputs.

→ Connecting the multichannel analog inputs.

**16 Control input/output**

Use to connect other Pioneer components so that you can control all your equipment from a single IR remote sensor.

→ Operating other Pioneer components with this unit's sensor.

**17 Multichannel pre-amplifier outputs**

Use to connect separate amplifiers for center, surround, surround back and subwoofer channels.

→ Connecting additional amplifiers(see also Installing your speaker systemfor powered subwoofer connection).

**18 iPod input terminal**

Use to connect your Apple iPod as an audio source.

→ Connecting an iPod.

**19 RS-232C connector**

Use for connection to a PC for graphical output when using Advanced MCACC.

→ Connecting a PC for Advanced MCACC output.

**20 Speaker terminals**

Use for connection to the main front, center, surround and surround back speakers.

→ Installing your speaker system.

**21 Switched AC power outlet (100W/0.8A max.)**

Use to power another component in the system. Power to the outlet switches on and off with the receiver.

→ AC outlet.

# CLEANING



A

Before shipping out the product, be sure to clean the following positions by using the prescribed cleaning tools:

Position to be cleaned	Cleaning tools
Fans	Cleaning paper : GED-008

B

C

D

E

F