

Pioneer

Service Manual

ORDER NO.
RRV4078

AUDIO/VIDEO MULTI-CHANNEL RECEIVER

VSX-420-K

VSX-RS320-K

THIS MANUAL IS APPLICABLE TO THE FOLLOWING MODEL(S) AND TYPE(S).

Model	Type	Power Requirement	The voltage can be converted by the following method.
VSX-420-K	AXCN5	AC 220 V	-----
VSX-420-K	FLXCN	AC 110 V to 127 V/220 V to 240 V	With the voltage selector
VSX-RS320-K	LXCN	AC 110 V to 127 V/220 V to 240 V	With the voltage selector
VSX-RS320-K	DWXCN	AC 220 V to 240 V	-----

This service manual should be used together with the following manual(s).

Model No.	Order No.	Remarks
VSX-519V-K/MYSXCN5	RRV3897	

For SPECIFICATIONS and PANEL FACILITIES, refer to the operating instructions.

PIONEER CORPORATION 1-1, Shin-ogura, Saiwai-ku, Kawasaki-shi, Kanagawa 212-0031, Japan
PIONEER ELECTRONICS (USA) INC. P.O. Box 1760, Long Beach, CA 90801-1760, U.S.A.
PIONEER EUROPE NV Haven 1087, Keetberglaan 1, 9120 Melsele, Belgium
PIONEER ELECTRONICS ASIACENTRE PTE. LTD. 253 Alexandra Road, #04-01, Singapore 159936
©PIONEER CORPORATION 2010

K-ZZZ MAY 2010 Printed in Japan

1. CONTRAST OF MISCELLANEOUS PARTS

NOTES: ● Parts marked by "NSP" are generally unavailable because they are not in our Master Spare Parts List.

- The Δ mark found on some component parts indicates the importance of the safety factor of the part. Therefore, when replacing, be sure to use parts of identical designation.
- Screws adjacent to ∇ mark on product are used for disassembly.
- For the applying amount of lubricants or glue, follow the instructions in this manual. (In the case of no amount instructions, apply as you think it appropriate.)
- Nos. indicate the pages and Nos. in the service manual for the base model.

● When ordering resistors, first convert resistance values into code form as shown in the following examples.
 Ex.1 When there are 2 effective digits (any digit apart from 0), such as 560 ohm and 47k ohm (tolerance is shown by J=5%, and K=10%).

560 Ω \rightarrow 56 x 10¹ \rightarrow 561 RD1/4PU5 6 1 J
 47k Ω \rightarrow 47 x 10³ \rightarrow 473 RD1/4PU4 7 3 J
 0.5 Ω \rightarrow R50 RN2HR 5 0 K
 1 Ω \rightarrow 1R0 RS1P 1 R 0 K

Ex.2 When there are 3 effective digits (such as in high precision metal film resistors).

5.62k Ω \rightarrow 562 x 10¹ \rightarrow 5621 RN1/4PC 5 6 2 1 F

CONTRAST TABLE

VSX-519V-K/MYSXCN5, VSX-420-K/AXCN5 and VSX-420-K/FLXCN are constructed the same except for the following:

Mark	No.	Symbol and Description	VSX-519V-K /MYSXCN5	VSX-420-K /AXCN5	VSX-420-K /FLXCN	Remarks
PCB ASSEMBLIES						
NSP	P50-22	1..P.C.B TOTAL ASSY (AMP) 2..P.C.B SUB ASSY (AMP)	7025HK0811012-IL 7028067521010-IL	7025HK0904012-IL 7028067521040-IL	7025HK0904012-IL 7028067521040-IL	
NSP	P50-61	1..P.C.B TOTAL ASSY (INPUT) 2..P.C.B SUB ASSY (INPUT)	7025HK0812013-IL 7028067531020-IL	7025HK0904013-IL 7028067531060-IL	7025HK0904013-IL 7028067531060-IL	
NSP	P50-62	1..P.C.B TOTAL ASSY (VIDEO) 2..P.C.B SUB ASSY (VIDEO)	7025HK0812014-IL 7028067551010-IL	7025HK0904014-IL 7028067551040-IL	7025HK0904014-IL 7028067551040-IL	
NSP	P50-63	1..P.C.B TOTAL ASSY (DSP) 2..P.C.B SUB ASSY (DSP) 2..P.C.B SUB ASSY (REG)	7025HK0812015-IL 7028067561020-IL Not used	7025HK0904015-IL 7028067561050-IL 7028067562010-IL	7025HK0904015-IL 7028067561050-IL 7028067562010-IL	No. 71
NSP	P50-31	1..P.C.B TOTAL ASSY (HDMI) 2..P.C.B SUB ASSY (HDMI)	7025HK0812024-IL 7028067581060-IL	7025HK0904016-IL 7028067951010-IL	7025HK0904016-IL 7028067951010-IL	
NSP	P50-64	1..P.C.B TOTAL ASSY (SPEAKER) 2..P.C.B SUB ASSY (SPEAKER)	7025HK0812017-IL 7028067601030-IL	7025HK0904017-IL 7028067601060-IL	7025HK0904017-IL 7028067601060-IL	
NSP	P50-27 P50-24 P50-23 P50-49 P50-48 P50-47	1..P.C.B TOTAL ASSY (MAIN) 2..P.C.B SUB ASSY (MAIN) 2..P.C.B SUB ASSY (GUIDE-L) 2..P.C.B SUB ASSY (GUIDE-R) 2..P.C.B SUB ASSY (CNT) 2..P.C.B SUB ASSY (P/T) 2..P.C.B SUB ASSY (H/P GUIDE)	7025HK0812010-IL 7028067501020-IL 7028067502010-IL 7028067503010-IL 7028067504010-IL 7028067505010-IL 7028067506010-IL	7025HK0925040-IL 70280675010G0-IL 70280675020E0-IL 70280675030E0-IL 70280675040E0-IL 70280675050E0-IL 70280675060E0-IL	7025HK0925030-IL 70280675010H0-IL 70280675020D0-IL 70280675030D0-IL 70280675040D0-IL 70280675050D0-IL 70280675060D0-IL	
NSP		1..P.C.B TOTAL ASSY (VOLTSEL) 2..P.C.B SUB ASSY (VOLTSEL)	Not used Not used	Not used Not used	7025HK0904028-IL 7028067621030-IL	No. 72
PACKING SECTION						
	P47-4	Remote Control Remote Control Remote Control (AXD7582)	8300753600010-IL 8300756500011-IL Not used	Not used Not used 8300758200010-IL	Not used Not used 8300758200010-IL	
	P47-6	Box, Gift	6007211340020-IL	60072117000J0-IL	60072117000I0-IL	
	P47-9	Cushion, Snow	6230212404000-IL	6230212824000-IL	6230212824000-IL	
NSP	P47-10	Operating Instructions (En/Fr/Ru)	5707000001920-IL	Not used	Not used	
NSP	P47-11	Warranty Card	ARY7127	ARY7137	Not used	
NSP	P47-14	Label Getter 519	5507000003610-IL	5507000003620-IL	5507000003480-IL	
	Δ P47-16	Power Cord	L068250160020-IL	Not used	L068250160020-IL	
	Δ	Power Cord	Not used	Not used	L068125070060-IL	

Mark	No.	Symbol and Description	VSX-519V-K /MYSXCN5	VSX-420-K /AXCN5	VSX-420-K /FLXCN	Remarks
	P47-20	Operating Instructions (It/De/NI/Es) Operating Instructions (Zhcn) Operating Instructions (En/Zhtw/Es) Sheet Sheet	570700002100-IL Not used Not used 522700001220-IL 522700001250-IL	Not used 570700004010-IL Not used Not used Not used	Not used Not used 570700004000-IL Not used Not used	
		Poly Bag Sheet (AC Cord Caution) Sheet (AC Cord Caution) Sheet (Caution)	Not used Not used Not used Not used	6330210059000-IL Not used Not used Not used	6330210089000-IL 522700000430-IL 522700000440-IL 522700000850-IL	
		EXTERIOR SECTION				
	P50-1	Window	5077212673010-IL	5077212673011-IL	5077212673011-IL	
	P50-6	Panel	3067214161100-IL	3067214161170-IL	3067214161170-IL	
⚠	P50-42	Power Trans	8200960610520-IL	8200960610500-IL	8200960610480-IL	
	P50-43	Chassis	3207212686110-IL	3207212686050-IL	3207212686240-IL	
	P50-44	Socket,Power AC	G430000180010-IL	Not used	G430000180010-IL	
	P50-45	Cabinet	3007211276010-IL	3007211276010-IL	3007211276100-IL	
	P50-46	Cushion	4050211205000-IL	Not used	Not used	
	P50-69	Bushing	2410040353010-IL	Not used	2410040353010-IL	
	P50-70	Cn,Wire	L000211020040-IL	Not used	L000211020040-IL	
	P50-S5	Screw	B028940101B10-IL	B028940101B11-IL	B028940101B11-IL	
⚠	P50-S10	Screw,Tap Tite	B020030083F10-IL	Not used	B020030083F10-IL	
	P50-A1	Power Cord Cover Cover Holder Screw	Not used Not used Not used Not used	L068250101710-IL Not used Not used Not used	Not used 4310212122020-IL 4310213701000-IL B000030103B10-IL	No. 73 No. 74 No. 75
		Stopper	Not used	4380040162010-IL	Not used	No. 76

VSX-519V-K/MYSXCN5, VSX-RS320-K/LXCN and VSX-RS320-K/DWXCEN are constructed the same except for the following:

Mark	No.	Symbol and Description	VSX-519V-K /MYSXCN5	VSX-RS320-K /LXCN	VSX-RS320-K /DWXCEN	Remarks
		PCB ASSEMBLIES				
NSP		1..P.C.B TOTAL ASSY (FRONT)	7025HK0812011-IL	7025HK0904011-IL	7025HK0904011-IL	
	P50-11	2..P.C.B SUB ASSY (FRONT)	7028067511020-IL	7028067511040-IL	7028067511040-IL	
	P50-57	2..P.C.B SUB ASSY (HEADPHONE)	7028067512010-IL	7028067512040-IL	7028067512040-IL	
	P50-58	2..P.C.B SUB ASSY (VOLUME)	7028067513010-IL	7028067513040-IL	7028067513040-IL	
	P50-59	2..P.C.B SUB ASSY (FUNCTION)	7028067514010-IL	7028067514040-IL	7028067514040-IL	
	P50-60	2..P.C.B SUB ASSY (PORTABLE)	7028067518010-IL	7028067518040-IL	7028067518040-IL	
NSP		1..P.C.B TOTAL ASSY (AMP)	7025HK0811012-IL	7025HK0904012-IL	7025HK0904012-IL	
	P50-22	2..P.C.B SUB ASSY (AMP)	7028067521010-IL	7028067521040-IL	7028067521040-IL	
NSP		1..P.C.B TOTAL ASSY (INPUT)	7025HK0812013-IL	7025HK0904013-IL	7025HK0904013-IL	
	P50-61	2..P.C.B SUB ASSY (INPUT)	7028067531020-IL	7028067531060-IL	7028067531060-IL	
NSP		1..P.C.B TOTAL ASSY (VIDEO)	7025HK0812014-IL	7025HK0904014-IL	7025HK0904014-IL	
	P50-62	2..P.C.B SUB ASSY (VIDEO)	7028067551010-IL	7028067551040-IL	7028067551040-IL	
NSP		1..P.C.B TOTAL ASSY (DSP)	7025HK0812015-IL	7025HK0904015-IL	7025HK0904015-IL	
	P50-63	2..P.C.B SUB ASSY (DSP)	7028067561020-IL	7028067561050-IL	7028067561050-IL	
		2..P.C.B SUB ASSY (REG)	Not used	7028067562010-IL	7028067562010-IL	No. 71
NSP		1..P.C.B TOTAL ASSY (HDMI)	7025HK0812024-IL	7025HK0904016-IL	7025HK0904016-IL	
	P50-31	2..P.C.B SUB ASSY (HDMI)	7028067581060-IL	7028067951010-IL	7028067951010-IL	
NSP		1..P.C.B TOTAL ASSY (SPEAKER)	7025HK0812017-IL	7025HK0904017-IL	7025HK0904017-IL	
	P50-64	2..P.C.B SUB ASSY (SPEAKER)	7028067601030-IL	7028067601060-IL	7028067601060-IL	
NSP		1..P.C.B TOTAL ASSY (MAIN)	7025HK0812010-IL	7025HK0926010-IL	7025HK0926020-IL	
	P50-27	2..P.C.B SUB ASSY (MAIN)	7028067501020-IL	70280675010K0-IL	70280675010J0-IL	
	P50-24	2..P.C.B SUB ASSY (GUIDE-L)	7028067502010-IL	70280675020D0-IL	70280675020E0-IL	

Mark	No.	Symbol and Description	VSX-519V-K /MYSXCN5	VSX-RS320-K /LXCN	VSX-RS320-K /DWXCN	Remarks	
A	P50-23	2..P.C.B SUB ASSY (GUIDE-R)	7028067503010-IL	70280675030D0-IL	70280675030E0-IL	No. 72	
	P50-49	2..P.C.B SUB ASSY (CNT)	7028067504010-IL	70280675040D0-IL	70280675040E0-IL		
	P50-48	2..P.C.B SUB ASSY (P/T)	7028067505010-IL	70280675050D0-IL	70280675050E0-IL		
	P50-47	2..P.C.B SUB ASSY (H/P GUIDE)	7028067506010-IL	70280675060D0-IL	70280675060E0-IL		
NSP	1..P.C.B TOTAL ASSY (VOLTSEL)	Not used	7025HK0904028-IL	Not used	No. 72		
	2..P.C.B SUB ASSY (VOLTSEL)	Not used	7028067621030-IL	Not used			
		PACKING SECTION					
B	P47-4	Remote Control	8300753600010-IL	8300756600010-IL	8300756600010-IL		
		Remote Control	8300756500011-IL	Not used	Not used		
	P47-6	Box, Gift	6007211340020-IL	60072117000E0-IL	60072117000F0-IL		
	P47-9	Cushion, Snow	6230212404000-IL	6230212824000-IL	6230212824000-IL		
	P47-10	Operating Instructions (En/Fr/Ru)	5707000001920-IL	Not used	Not used		
NSP	P47-11	Warranty Card	ARY7127	Not used	Not used		
	P47-14	Label Getter	5507000003610-IL	5507000003690-IL	5507000003690-IL		
NSP	P47-20	Operating Instructions (It/De/Nl/Es)	5707000002100-IL	Not used	Not used		
		Operating Instructions (En)	Not used	Not used	5707000003970-IL		
C		Operating Instructions (En/Zhtw/Es)	Not used	5707000003960-IL	Not used		
		Sheet	5227000001220-IL	Not used	Not used		
		Sheet	5227000001250-IL	Not used	Not used		
		Sheet(Caution)	Not used	5227000000850-IL	Not used		
		Cpa Label 320	Not used	5507000006760-IL	Not used		
NSP		Poly Bag	Not used	6330210089000-IL	Not used		
			EXTERIOR SECTION				
D	P50-1	Window	5077212673010-IL	5077212673020-IL	5077212673020-IL	No. 73	
	P50-6	Panel	3067214161100-IL	3067214161140-IL	3067214161140-IL		
	P50-42	Power Trans	8200960610520-IL	8200960610480-IL	8200960610490-IL		
	P50-43	Chassis	3207212686110-IL	3207212686230-IL	3207212686130-IL		
	P50-45	Cabinet	3007211276010-IL	3007211276100-IL	3007211276010-IL		
	P50-46	Cushion	4050211205000-IL	Not used	Not used		
	P50-69	Bushing	2410040353010-IL	2410040353010-IL	Not used		
	P50-S5	Screw	B028940101B10-IL	B028940101B11-IL	B028940101B11-IL		
	P50-S10	Screw, Tap Tite	B020030083F10-IL	B020030083F10-IL	Not used		
		Cover	Not used	4310212122020-IL	Not used		
	Cover Holder	Not used	4310213701000-IL	Not used	No. 74		
	Screw	Not used	B000030103B10-IL	Not used	No. 75		

Notes :The numbers in the remarks column correspond to the numbers on the "EXPLODED VIEWS".

For PCB ASSEMBLIES, Refer to "2. SCHEMATIC DIAGRAM", "3. PCB CONNECTION DIAGRAM" and "4. PCB PARTS LIST".

EXPLODED VIEWS EXTERIOR SECTION

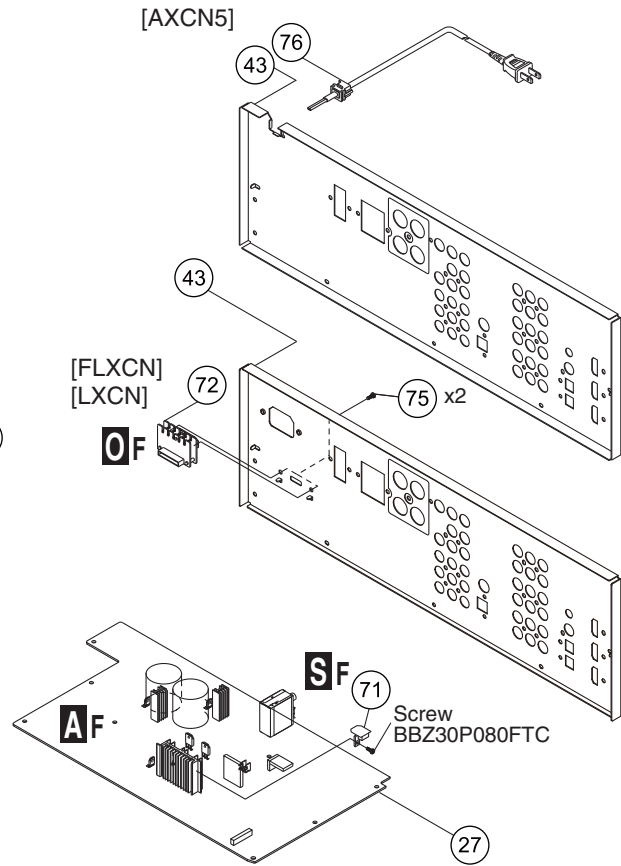
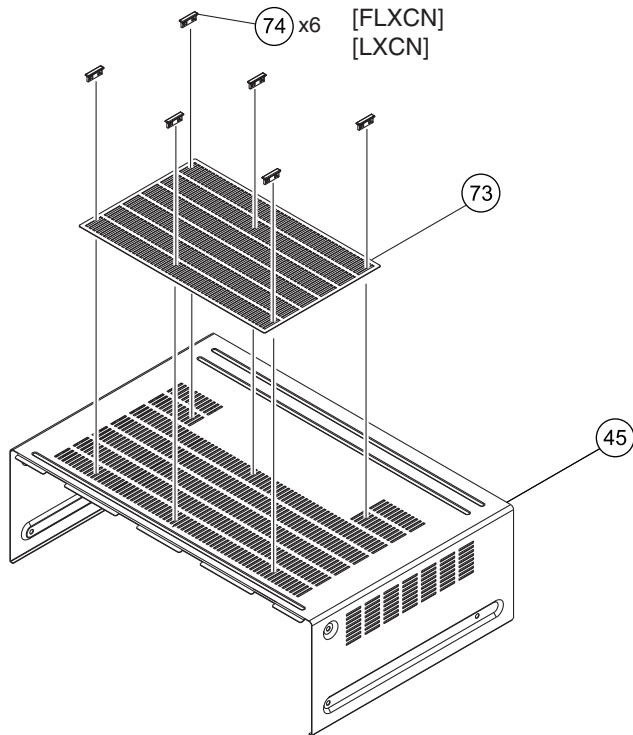

A
B
C
D
E
F

1 2 3 4

2.2 P.C.B SUB ASSY (VOLTSEL) and P.C.B SUB ASSY (REG)

A

B

C

D

E

F

OF P.C.B SUB ASSY (VOLTSEL) (FLXCN, LXCN : 7028067621030-IL)

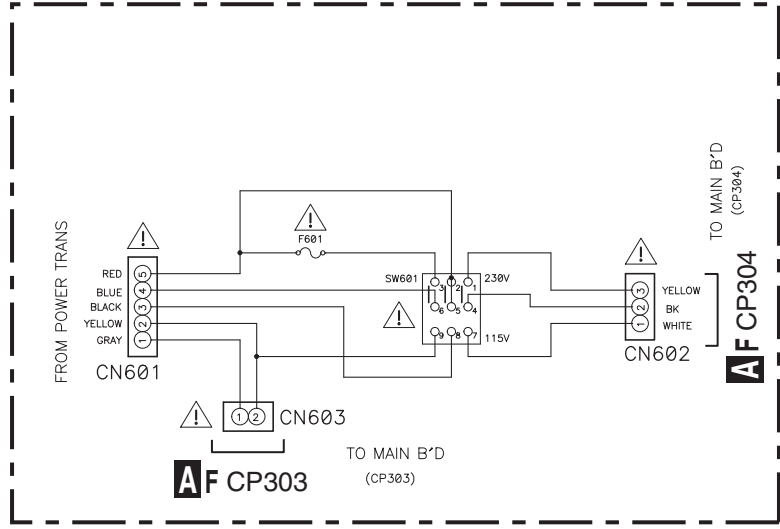

SF P.C.B SUB ASSY (REG) (7028067562010-IL)

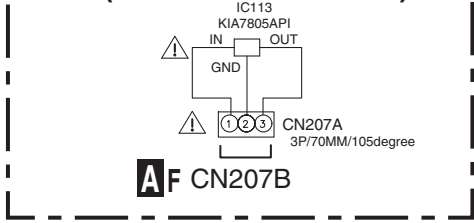

OF SF

OF SF

3. PCB CONNECTION DIAGRAM

3.1 P.C.B SUB ASSY (VOLTSEL) and P.C.B SUB ASSY (REG)

SIDE A

SIDE A

OF P.C.B SUB ASSY (VOLTSEL)

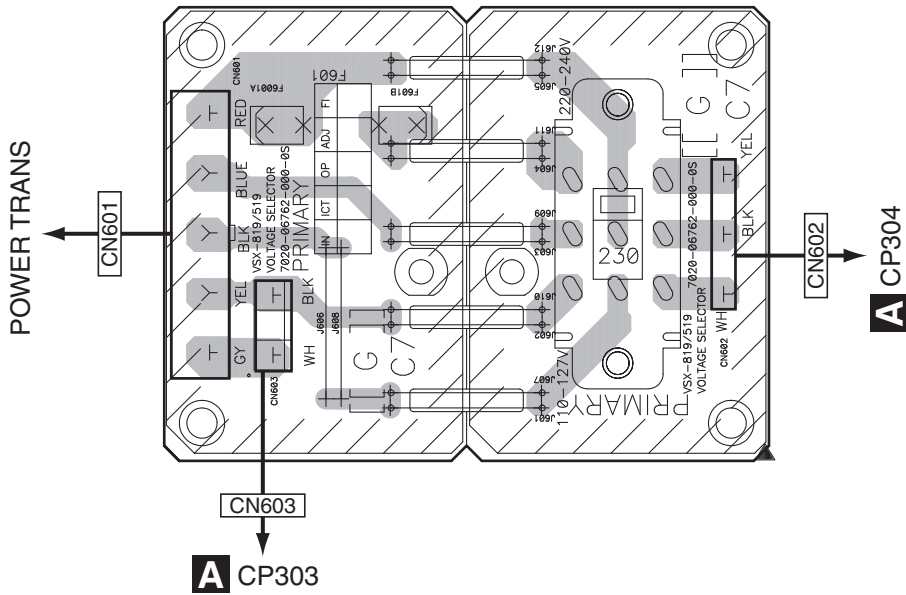

SF P.C.B SUB ASSY (REG)

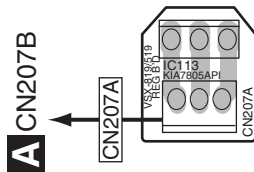

OF SF

OF SF

3.2 P.C.B SUB ASSY (HDMI)

SIDE A

SIDE A

Q F P.C.B SUB ASSY (HDMI)

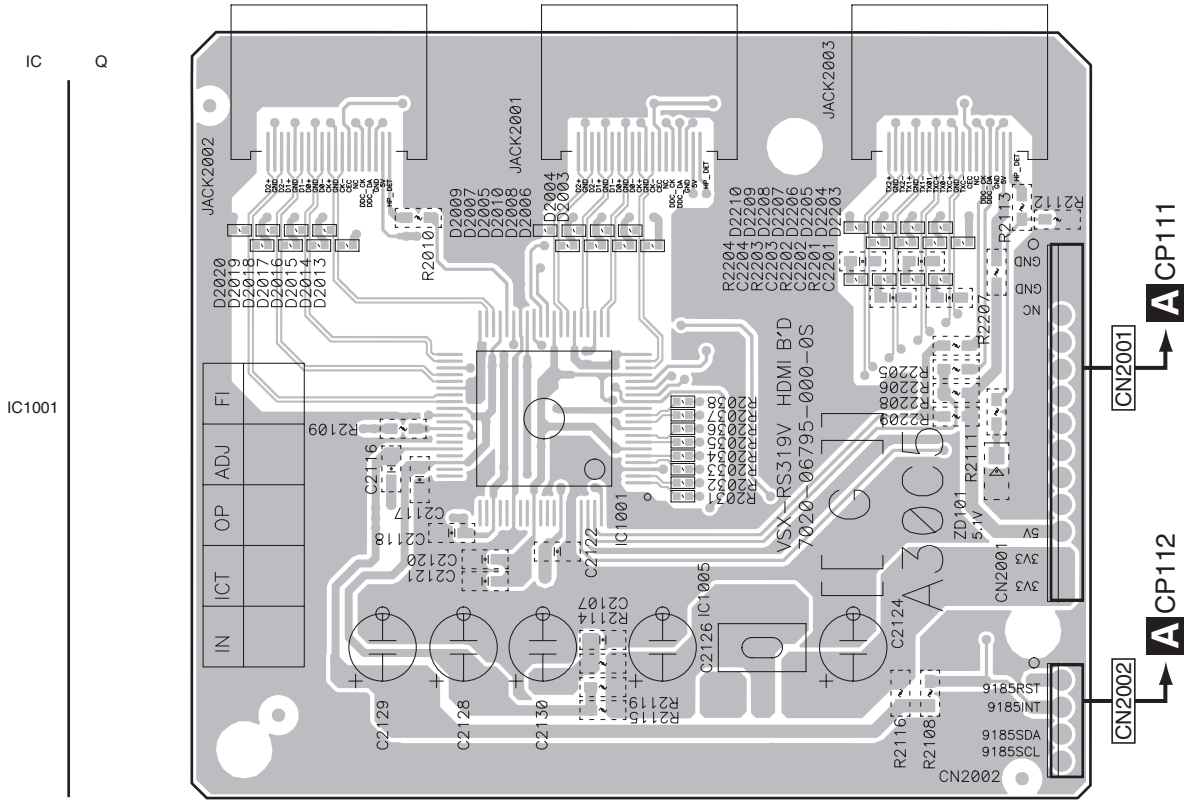

SIDE B

SIDE B

Q F P.C.B SUB ASSY (HDMI)

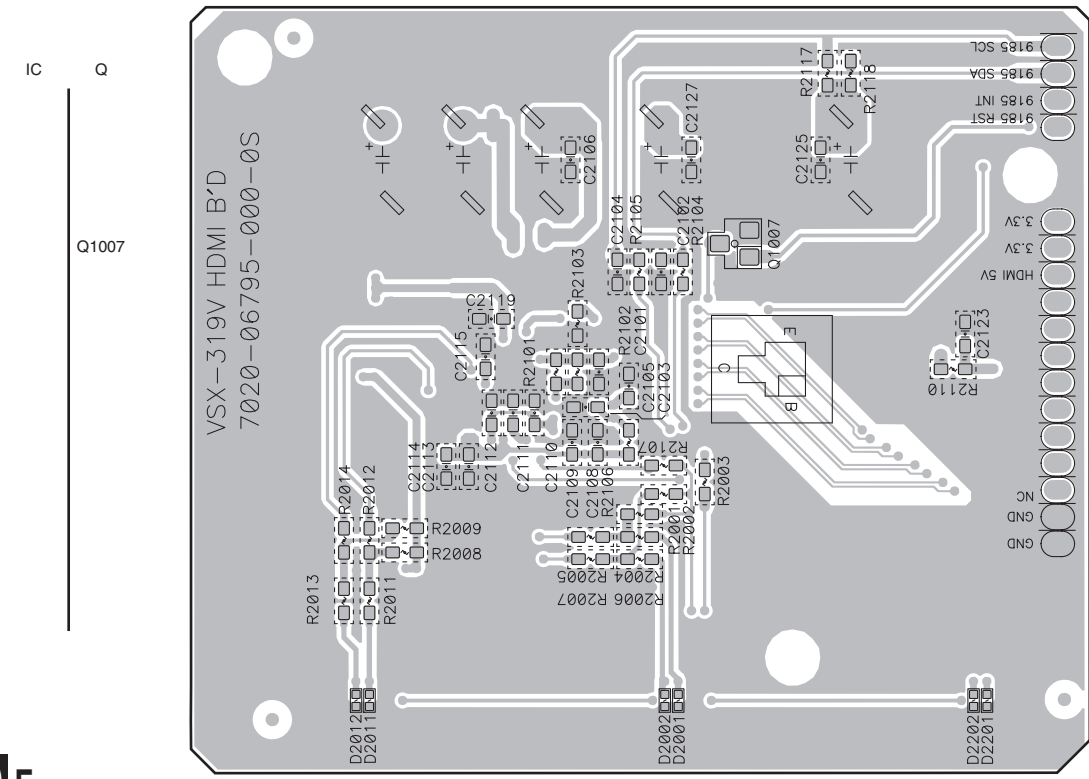

Q F

Q F

4. PCB PARTS LIST

Mark No. Description Part No.

A F P.C.B SUB ASSY (MAIN) (AXCN5)

SEMICONDUCTORS

	IC 101	J020303020030-IL
⚠	IC 103	J126781200040-IL
⚠	IC 104	J126791200060-IL
	IC 106	J000241600020-IL
⚠	IC 111	J12678R330010-IL
⚠	IC 112	J126111733050-IL
⚠	IC 114	J126780500110-IL
	IC 301	J126111700041-IL
	IC 302	J126111750010-IL
	Q 101,102,138,300	J522038750210-IL
	Q 103	J522010500210-IL
⚠	Q 106,107	J501778000010-IL
	Q 121,123,124	J5001268B0050-IL
	Q 122	J5023198Y0000-IL
⚠	Q 125	J5000916Y0050-IL
	Q 201	J522010200210-IL
	Q 301	J522038750210-IL
	D 103-105,125,127	K005041480030-IL
	D 106	K000013300520-IL
	D 110,111	K000400700010-IL
	D 128,135,136,301	K005041480030-IL
⚠	D 131-134,137-140	K000400700010-IL
	D 302	K005041480030-IL
⚠	D 303,304	K005041480030-IL
⚠	D 305-308	K000400700010-IL
⚠	D 7101-7103	K047604000020-IL
	D 9103,9104	K06016R044520-IL
	D 9107	K06003R344520-IL
	D 9109	K06612R04P400-IL
	D 9301	K06605R14P400-IL

MISCELLANEOUS

	L 101,102(BEAD101, 102) BEAD,COIL	7610010030000-IL
	JA 9101 TUNER	E903004100020-IL
⚠	RY 302 RELAY	G680060502010-IL
⚠	T 301 POWER TRANS	8200280150420-IL
	X 101 RESONATOR,CERAMIC	E830160000060-IL
	0 SCREW	B020030081B10-IL
	101 HEAT SINK	2120210958050-IL
	104,114 HEAT SINK	2120000818020-IL
⚠	FU 301 FUSE GLASS TUBE 20MM	N751223151110-IL

RESISTORS

	R 101-104,201,202	C060R22065050-IL
	R 105,106	C060033065050-IL
	R 159	C060015165050-IL
	R 174-176	C060022265050-IL
	R 178,179	C141R10069010-IL
	R 184	C0604R7065050-IL
⚠	R 186	C060022065050-IL
	R 304	C060010063050-IL

CAPACITORS

	C 179,180	D040682088010-IL
	C 182-186	D02010407H080-IL
	C 189	D040331088230-IL
	C 200	D040682083000-IL
	C 201-203,208-210	D02047306C060-IL

Mark No. Description Part No.

	C 206	D040472084020-IL
	C 207	D040102084060-IL
	C 222,224	D040471082060-IL
	C 229	D040221082090-IL
	C 236	D040222083080-IL
	C 237-239	D02047306C060-IL
	C 301	D040102083030-IL
	C 304	D00847208H010-IL

A F P.C.B SUB ASSY (MAIN) (FLXCN)

SEMICONDUCTORS

	IC 101	J020303020030-IL
⚠	IC 103	J126781200040-IL
⚠	IC 104	J126791200060-IL
	IC 106	J000241600020-IL
⚠	IC 111	J12678R330010-IL
⚠	IC 112	J126111733050-IL
⚠	IC 114	J126780500110-IL
	IC 301	J126111700041-IL
	IC 302	J126111750010-IL
	Q 101,102,138,300	J522038750210-IL
	Q 103	J522010500210-IL
⚠	Q 106,107	J501778000010-IL
	Q 121,123,124	J5001268B0050-IL
	Q 122	J5023198Y0000-IL
⚠	Q 125	J5000916Y0050-IL
	Q 201	J522010200210-IL
	Q 301	J522038750210-IL
	D 103-105,125,127	K005041480030-IL
	D 106	K000013300520-IL
	D 110,111	K000400700010-IL
	D 128,135,136,301	K005041480030-IL
⚠	D 131-134,137-140	K000400700010-IL
	D 302	K005041480030-IL
⚠	D 303,304	K005041480030-IL
⚠	D 305-308	K000400700010-IL
⚠	D 7101-7103	K047604000020-IL
	D 9103,9104	K06016R044520-IL
	D 9107	K06003R344520-IL
	D 9109	K06612R04P400-IL
	D 9301	K06605R14P400-IL

MISCELLANEOUS

	L 101,102(BEAD101, 102) BEAD,COIL	7610010030000-IL
	JA 9101 TUNER	E903004100020-IL
⚠	RY 302 RELAY	G680060502010-IL
⚠	T 301 POWER TRANS	8200280150610-IL
	X 101 RESONATOR,CERAMIC	E830160000060-IL
	0 SCREW	B020030081B10-IL
	101 HEAT SINK	2120210958050-IL
	104,114 HEAT SINK	2120000818020-IL
⚠	FU 301 FUSE GLASS TUBE 20MM	N751226301110-IL

RESISTORS

	R 101-104,201,202	C060R22065050-IL
	R 105,106	C060033065050-IL
	R 159	C060015165050-IL
	R 174-176	C060022265050-IL
	R 178,179	C141R10069010-IL

Mark	No.	Description	Part No.
	R 184		C0604R7065050-IL
A	⚠ R 186		C060022065050-IL
	R 304		C060010063050-IL

CAPACITORS

	C 179,180		D040682088010-IL
	C 182-186		D02010407H080-IL
	C 189		D040331088230-IL
	C 200		D040682083000-IL
	C 201-203,208-210		D02047306C060-IL
	C 206		D040472084020-IL
	C 207		D040102084060-IL
	C 222,224		D040471082060-IL
B	C 229		D040221082090-IL
	C 236		D040222083080-IL
	C 237-239		D02047306C060-IL
	C 301		D040102083030-IL
	C 304		D00847208H010-IL

**A F P.C.B SUB ASSY (MAIN) (LXCN)
SEMICONDUCTORS**

	IC 101		J020303020030-IL
C	⚠ IC 103		J126781200040-IL
	⚠ IC 104		J126791200060-IL
	IC 106		J000241600020-IL
	⚠ IC 111		J12678R330010-IL
	⚠ IC 112		J126111733050-IL
	⚠ IC 114		J126780500110-IL
	IC 301		J126111700041-IL
	IC 302		J126111750010-IL
	Q 101,102,138,300		J522038750210-IL
	Q 103		J522010500210-IL
D	⚠ Q 106,107		J501778000010-IL
	Q 121,123,124		J5001268B0050-IL
	Q 122		J5023198Y0000-IL
	⚠ Q 125		J5000916Y0050-IL
	Q 201		J522010200210-IL
	Q 301		J522038750210-IL
	D 103-105,125,127		K005041480030-IL
	D 106		K000013300520-IL
	D 110,111		K000400700010-IL
	D 128,135,136,301		K005041480030-IL
E	⚠ D 131-134,137-140		K000400700010-IL
	D 302		K005041480030-IL
	⚠ D 303,304		K005041480030-IL
	⚠ D 305-308		K000400700010-IL
	⚠ D 7101-7103		K047604000020-IL
	D 9103,9104		K06016R044520-IL
	D 9107		K06003R344520-IL
	D 9109		K06612R04P400-IL
	D 9301		K06605R14P400-IL

MISCELLANEOUS

	L 101,102(BEAD101, 102) BEAD,COIL		7610010030000-IL
	JA 9101 TUNER		E903004100020-IL
F	⚠ RY 302 RELAY		G680060502010-IL
	⚠ T 301 POWER TRANS		8200280150610-IL
	X 101 RESONATOR,CERAMIC		E830160000060-IL
	0 SCREW		B020030081B10-IL
	101 HEAT SINK		2120210958050-IL

Mark	No.	Description	Part No.
		104,114 HEAT SINK	2120000818020-IL
	⚠ FU 301	FUSE GLASS TUBE 20MM	N751226301110-IL

RESISTORS

	R 101-104,201,202		C060R22065050-IL
	R 105,106		C060033065050-IL
	R 159		C060015165050-IL
	R 174-176		C060022265050-IL
	R 178,179		C141R10069010-IL
	R 184		C0604R7065050-IL
	⚠ R 186		C060022065050-IL
	R 304		C060010063050-IL

CAPACITORS

	C 179,180		D040682088010-IL
	C 182-186		D02010407H080-IL
	C 189		D040331088230-IL
	C 200		D040682083000-IL
	C 201-203,208-210		D02047306C060-IL
	C 206		D040472084020-IL
	C 207		D040102084060-IL
	C 222,224		D040471082060-IL
	C 229		D040221082090-IL
	C 236		D040222083080-IL
	C 237-239		D02047306C060-IL
	C 301		D040102083030-IL
	C 304		D00847208H010-IL

**A F P.C.B SUB ASSY (MAIN) (DWXCN)
SEMICONDUCTORS**

	IC 101		J020303020030-IL
	⚠ IC 103		J126781200040-IL
	⚠ IC 104		J126791200060-IL
	IC 106		J000241600020-IL
	⚠ IC 111		J12678R330010-IL
	⚠ IC 112		J126111733050-IL
	⚠ IC 114		J126780500110-IL
	IC 301		J126111700041-IL
	IC 302		J126111750010-IL
	Q 101,102,138,300		J522038750210-IL
	Q 103		J522010500210-IL
	⚠ Q 106,107		J501778000010-IL
	Q 121,123,124		J5001268B0050-IL
	Q 122		J5023198Y0000-IL
	⚠ Q 125		J5000916Y0050-IL
	Q 201		J522010200210-IL
	Q 301		J522038750210-IL
	D 103-105,125,127		K005041480030-IL
	D 106		K000013300520-IL
	D 110,111		K000400700010-IL
	D 128,135,136,301		K005041480030-IL
	⚠ D 131-134,137-140		K000400700010-IL
	D 302		K005041480030-IL
	⚠ D 303,304		K005041480030-IL
	⚠ D 305-308		K000400700010-IL
	⚠ D 7101-7103		K047604000020-IL
	D 9103,9104		K06016R044520-IL
	D 9107		K06003R344520-IL
	D 9109		K06612R04P400-IL
	D 9301		K06605R14P400-IL

Mark	No.	Description	Part No.
MISCELLANEOUS			
	L	101,102(BEAD101, 102) BEAD,COIL	7610010030000-IL
	JA	9101 TUNER	E903004100020-IL
⚠	RY	302 RELAY	G680060502010-IL
⚠	T	301 POWER TRANS	8200280150420-IL
	X	101 RESONATOR,CERAMIC	E830160000060-IL
	0	SCREW	B020030081B10-IL
	101	HEAT SINK	2120210958050-IL
		104,114 HEAT SINK	2120000818020-IL
⚠	FU	301 FUSE GLASS TUBE 20MM	N751223151110-IL

RESISTORS

	R	101-104,201,202	C060R22065050-IL
	R	105,106	C060033065050-IL
	R	159	C060015165050-IL
	R	174-176	C060022265050-IL
	R	178,179	C141R10069010-IL
	R	184	C0604R7065050-IL
⚠	R	186	C060022065050-IL
	R	304	C060010063050-IL

CAPACITORS

	C	179,180	D040682088010-IL
	C	182-186	D02010407H080-IL
	C	189	D040331088230-IL
	C	200	D040682083000-IL
	C	201-203,208-210	D02047306C060-IL
	C	206	D040472084020-IL
	C	207	D040102084060-IL
	C	222,224	D040471082060-IL
	C	229	D040221082090-IL
	C	236	D040222083080-IL
	C	237-239	D02047306C060-IL
	C	301	D040102083030-IL
	C	304	D00847208H010-IL

B F P.C.B SUB ASSY (P/T)**SEMICONDUCTORS**

	Q	126,128,131,134	J5001268B0050-IL
	Q	127,129,130,132	J5023198Y0000-IL
	Q	133,135,136	J5023198Y0000-IL
	D	112,113	K005041480030-IL

MISCELLANEOUS

	201	BRACKET	4010210196000-IL
--	-----	---------	------------------

RESISTORS

	R	189	C00004736P520-IL
	R	190	C060047363050-IL

C F P.C.B SUB ASSY (FRONT)(vsx-RS320)**SEMICONDUCTORS**

	IC	701	J127163150010-IL
	IC	7011 (RMC701)	E940343800010-IL
⚠	Q	702	J5000933S0050-IL
	Q	703	J522107S00210-IL

MISCELLANEOUS

	L	701 COIL	D330101001020-IL
	L	702 COIL,FILTER-INDUCTOR	D330100700520-IL

Mark	No.	Description	Part No.
	V	701 DISPLAY,FLT	K530126300010-IL
	S	701-714 SWITCH	G180501000010-IL
	0	HOLDER	432004078301A-IL

RESISTORS

	R	779,780	C0602R2063050-IL
--	---	---------	------------------

CAPACITORS

	C	718,719	D02047306C060-IL
--	---	---------	------------------

D F P.C.B SUB ASSY (VOLUME)(vsx-RS320)**SEMICONDUCTORS**

	D	707,709	K005041480030-IL
--	---	---------	------------------

MISCELLANEOUS

	S	702 SW,ENCODER	G121123040010-IL
--	---	----------------	------------------

E F P.C.B SUB ASSY(FUNCTION)(vsx-RS320)**SEMICONDUCTORS**

	D	711,712	K005041480030-IL
--	---	---------	------------------

MISCELLANEOUS

	S	701 SW,ENCODER	G121123050020-IL
	S	715 SWITCH	G180501000010-IL

F F P.C.B SUB ASSY(HEADPHONE)(vsx-RS320)**SEMICONDUCTORS**

	D	705,706	K005041480030-IL
--	---	---------	------------------

MISCELLANEOUS

	JA	701 JACK,D6.5	G402PJ619AG0Y-IL
--	----	---------------	------------------

I F P.C.B SUB ASSY (PORTABLE)(vsx-RS320)**SEMICONDUCTORS**

	D	713,714	K005041480030-IL
--	---	---------	------------------

MISCELLANEOUS

	JA	703 JACK,D3.5	G401PJ354H70Y-IL
--	----	---------------	------------------

J F P.C.B SUB ASSY (AMP)**SEMICONDUCTORS**

	Q	2021-2025,2061-2065	J5023200B0050-IL
	Q	2031-2035,2041-2045	J5000992F0050-IL

MISCELLANEOUS

	L	2011-2015 COIL,FILTER-INDUCTOR	D330900001330-IL
	VR	2011-2015 VR,SEMI CARBON MOLD	C541102315000-IL

RESISTORS

	R	227,229	C060010065050-IL
	R	2011-2015	C00007526P520-IL
	R	2021-2025,2071-2075	C060056265050-IL
	R	2031-2035	C00002226P520-IL
	R	2041-2045	C00004746P520-IL

	R	2051-2055,2231-2235	C0604R7063050-IL
	R	2061-2065	C00001836P520-IL
	R	2081-2085	C00008216P520-IL
⚠	R	2091-2095,2101-2105	N113136647820-IL
	R	2111-2115	C00002216P520-IL

Mark No. Description Part No.

Mark No. Description Part No.

A	R	2121-2125,2181-2185	C00003336P520-IL
	R	2131-2135	C00003026P520-IL
	R	2141-2145	C060010065520-IL
	⚠	R 2151-2155,2161-2165	N113136647820-IL
	R	2191-2195	C00003346P520-IL
	R	2201-2205	C00005616P520-IL
	R	2211-2215,2251-2255	C00001226P520-IL
	R	2221-2225	C00004736P520-IL
	R	2241-2245	C060047063050-IL
	R	2261-2265	C00004716P520-IL
	R	2281-2285	N113135610020-IL

M F P.C.B SUB ASSY (SPEAKER)

SEMICONDUCTORS

Q	401-404	J522010500210-IL
D	401-408	K005041480030-IL

MISCELLANEOUS

JA 401	TER,BOARD SCREW 4P	G612405E0200Y-IL
JA 402	TER,BOARD PUSH 4P	G594408SA030Y-IL
JA 403	TER,BOARD PUSH 2P	G592212A0300Y-IL
RY 401-403	RELAY	G680120502050-IL
RY 404	RELAY	G680240202030-IL

RESISTORS

R	4016,4017(R401L, R401R)	C060033166520-IL
---	-------------------------	------------------

CAPACITORS

C	4013-4017	D02015306C060-IL
C	4022-4024,4026,4027	D02010406C060-IL

CAPACITORS

B	C	2011-2015,2111-2115	D00410106D050-IL
	C	2031-2035	D00422106D05C-IL
	C	2041-2045	D00033006D050-IL
	C	2091-2095	D004471277050-IL
	C	2101-2105	D004102277050-IL
	C	2131-2135,2141-2145	D02010406C060-IL

K F P.C.B SUB ASSY (INPUT)

SEMICONDUCTORS

C	IC	801	J084152180010-IL
	IC	802	J121458000020-IL
	Q	801,803,805,806	J5222875B0010-IL
	Q	802,804,807,809	J520010200210-IL
	Q	808	J5222875B0010-IL
	D	801-810	K005041480030-IL

MISCELLANEOUS

JA	802-804 TER,RCA 6PIN	G603610A02000-IL
----	----------------------	------------------

RESISTORS

⚠	R	874,875	C060010165060-IL
---	---	---------	------------------

CAPACITORS

D	C	803,830	D02022306C060-IL
	C	804,829	D02047306C060-IL
	C	805,828	D020154078060-IL

L F P.C.B SUB ASSY (VIDEO)

SEMICONDUCTORS

E	IC	1001	J171795600010-IL	
	IC	1003	J171258600010-IL	
	IC	1004	J126790500070-IL	
	⚠	IC	1005	J121458000020-IL
	Q	1001-1006	J5222875B0010-IL	
	Q	1007	J520010200210-IL	
	Q	1008,1010	J5023198Y0000-IL	
	Q	1009,1011	J522107S00210-IL	
	D	1001,1002	K005041480030-IL	

MISCELLANEOUS

L	1001 BEAD,COIL	7610035500030-IL
JA	1001 TER,RCA 3PIN	G6060319D1B1Y-IL
JA	1002 TER,RCA	G608610D0209Y-IL
JA	1003 TER,RCA 9PIN	G607902AD016Y-IL

CAPACITORS

C	1009,1012,1016	D040471081070-IL
---	----------------	------------------

O F P.C.B SUB ASSY (VOLTSEL)

MISCELLANEOUS

⚠	S	601 SW,SLIDE	G060329140000-IL
⚠	CN	601 CN,WAFER 7.92MM	L108353280560-IL
	0	SUPPORTER	4070210192000-IL
	0	SPACER(PLS)	4300210062000-IL
⚠	FU	601 FUSE GLASS TUBE 20MM	N751223151110-IL
	FU	6011,6012 HOLDER,FUSE CLIP	G645000050010-IL

P F P.C.B SUB ASSY (DSP)

SEMICONDUCTORS

IC	100	J001421640040-IL	
IC	101	8952519000031-IL	
IC	102	J080320787010-IL	
IC	106	J040742570030-IL	
IC	109	J080458800010-IL	
IC	110	J040740400290-IL	
IC	806	J030151100010-IL	
⚠	IC	1011,1021(REG101, REG102)	J126111712040-IL
Q	802	J522010500210-IL	
D	101-103	K005041480030-IL	

MISCELLANEOUS

L	115,116 COIL	D3304R7000150-IL
L	117 COIL	D3302R2000150-IL
L	120 BEAD,COIL	7610035500030-IL
JA	102 TER,RCA 1PIN	G600107A0000Y-IL
JA	105,106 OPTICAL RECEIVER	E100116500040-IL
JA	804 JACK,D3.5	G40130802000Y-IL
X	101 CRYSTAL CHIP (24.576 MHz)	E80524R576020-IL

CAPACITORS

C	823,825	D02012306C060-IL
---	---------	------------------

Mark	No.	Description	Part No.
------	-----	-------------	----------

Q F P.C.B SUB ASSY (HDMI)

SEMICONDUCTORS

	IC 1001		J040918500020-IL
⚠	IC 1005		J126111710011-IL
	Q 1007		J522104S00210-IL

MISCELLANEOUS

	JA 2001-2003 CN.WAFER		L109100190050-IL
--	-----------------------	--	------------------

S F P.C.B SUB ASSY (REG)

SEMICONDUCTORS

⚠	IC 113		J126780500110-IL
---	--------	--	------------------

P.C.B SUB ASSY (GUIDE-L)

MISCELLANEOUS

	801 JHMX9800(ON)HAITI)		4330000120000-IL
--	------------------------	--	------------------

P.C.B SUB ASSY (GUIDE-R)

MISCELLANEOUS

	901,902 JHMX9800(ON)HAITI)		4330000120000-IL
--	----------------------------	--	------------------

P.C.B SUB ASSY (H/P GUIDE)

MISCELLANEOUS

	601 BRACKET		4010210196000-IL
--	-------------	--	------------------