

# Pioneer

## Service Manual



VSX-S510-K

ORDER NO.  
**RRV4490**

AV RECEIVER

# VSX-S510-K

## VSX-S510-S

## VSX-S310-K

## VSX-S310-S

THIS MANUAL IS APPLICABLE TO THE FOLLOWING MODEL(S) AND TYPE(S).

Model	Type	Power Requirement	Remarks
VSX-S510-K	SYXE8	AC 220 V to 230 V	
VSX-S510-S	SYXE8	AC 220 V to 230 V	
VSX-S310-K	SYXE8	AC 220 V to 230 V	
VSX-S310-S	SYXE8	AC 220 V to 230 V	



**PIONEER CORPORATION** 1-1, Shin-ogura, Saiwai-ku, Kawasaki-shi, Kanagawa 212-0031, Japan  
**PIONEER ELECTRONICS (USA) INC.** P.O. Box 1760, Long Beach, CA 90801-1760, U.S.A.  
**PIONEER EUROPE NV** Haven 1087, Keetberglaan 1, 9120 Melsele, Belgium  
**PIONEER ELECTRONICS ASIACENTRE PTE. LTD.** 253 Alexandra Road, #04-01, Singapore 159936  
©PIONEER CORPORATION 2013

K-FZV OCT. 2013 Printed in Japan

# SAFETY INFORMATION



A

This service manual is intended for qualified service technicians; it is not meant for the casual do-it-yourselfer. Qualified technicians have the necessary test equipment and tools, and have been trained to properly and safely repair complex products such as those covered by this manual. Improperly performed repairs can adversely affect the safety and reliability of the product and may void the warranty. If you are not qualified to perform the repair of this product properly and safely, you should not risk trying to do so and refer the repair to a qualified service technician.

B

C

D

E

F

# CONTENTS

SAFETY INFORMATION.....	2	
1. SERVICE PRECAUTIONS.....	4	
1.1 NOTES ON SOLDERING.....	4	A
2. SPECIFICATIONS.....	5	
2.1 ACCESSORIES.....	5	
2.2 SPECIFICATIONS.....	5	
3. BASIC ITEMS FOR SERVICE.....	6	
3.1 CHECK POINTS AFTER SERVICING.....	6	
3.2 PCB LOCATIONS.....	7	
3.3 JIGS LIST.....	8	
4. BLOCK DIAGRAM.....	10	
4.1 OVERALL CONNECTION DIAGRAM.....	10	
4.2 BLOCK DIAGRAM FOR AUDIO BLOCK.....	12	
4.3 BLOCK DIAGRAM FOR DMAIN ASSY (1) (VSX-S510).....	14	B
4.4 BLOCK DIAGRAM FOR DMAIN ASSY (2) (VSX-S510).....	16	
4.5 BLOCK DIAGRAM FOR DMAIN ASSY (VSX-S310).....	18	
4.6 BLOCK DIAGRAM FOR POWER BLOCK (1).....	20	
4.7 BLOCK DIAGRAM FOR POWER BLOCK (2).....	22	
4.8 BLOCK DIAGRAM FOR GND BLOCK.....	24	
5. DIAGNOSIS.....	26	
5.1 TROUBLESHOOTING.....	26	
5.2 PROTECTION CIRCUIT DESCRIPTION.....	36	
6. SERVICE MODE.....	38	
6.1 SERVICE MODE.....	38	
7. DISASSEMBLY.....	42	
8. EACH SETTING AND ADJUSTMENT.....	56	
8.1 UPDATING OF THE FIRMWARE (VSX-S510).....	56	C
8.2 UPDATING OF THE FIRMWARE (VSX-S310).....	60	
9. EXPLODED VIEWS AND PARTS LIST.....	66	
9.1 PACKING SECTION.....	66	
9.2 EXTERIOR SECTION.....	68	
9.3 FRONT SECTION.....	70	
10. SCHEMATIC DIAGRAM.....	72	
10.1 MAIN ASSY (1/3).....	72	
10.2 MAIN ASSY (2/3).....	74	
10.3 MAIN ASSY (3/3).....	76	
10.4 DMAIN ASSY (1/6) (VSX-S510).....	78	
10.5 DMAIN ASSY (2/6) (VSX-S510).....	80	D
10.6 DMAIN ASSY (3/6) (VSX-S510).....	82	
10.7 DMAIN ASSY (4/6) (VSX-S510).....	84	
10.8 DMAIN ASSY (5/6) (VSX-S510).....	86	
10.9 DMAIN ASSY (6/6) (VSX-S510).....	88	
10.10 DMAIN ASSY (1/3) (VSX-S310).....	90	
10.11 DMAIN ASSY (2/3) (VSX-S310).....	92	
10.12 DMAIN ASSY (3/3) (VSX-S310).....	94	
10.13 BT ASSY.....	96	
10.14 FHDMI ASSY.....	98	
10.15 USB ASSY and FRONT ASSY.....	100	
10.16 DAMP ASSY.....	102	
10.17 POWER TRANS ASSY.....	104	E
10.18 SIDE CNT ASSY.....	106	
10.19 BRIDGE, AMP GUARD, MAIN GUARD, CABLE and CLAMP ASSYS.....	108	
11. PCB CONNECTION DIAGRAM.....	110	
11.1 MAIN ASSY.....	110	
11.2 DMAIN ASSY (VSX-S510).....	114	
11.3 DMAIN ASSY (VSX-S310) and BT ASSY (VSX-S510).....	118	
11.4 FHDMI ASSY (VSX-S510) and USB ASSY (VSX-S310).....	122	
11.5 FRONT ASSY.....	124	
11.6 DAMP ASSY.....	128	
11.7 POWER TRANS ASSY.....	132	
11.8 SIDE CNT ASSY and BRIDGE ASSY.....	134	
11.9 AMP GUARD, MAIN GUARD, CABLE (VSX-S510) and CLAMP ASSYS.....	136	F
12. PCB PARTS LIST.....	138	

# 1. SERVICE PRECAUTIONS

## 1.1 NOTES ON SOLDERING

A

- For environmental protection, lead-free solder is used on the printed circuit boards mounted in this unit.  
Be sure to use lead-free solder and a soldering iron that can meet specifications for use with lead-free solders for repairs accompanied by reworking of soldering.
- Compared with conventional eutectic solders, lead-free solders have higher melting points, by approximately 40 °C.  
Therefore, for lead-free soldering, the tip temperature of a soldering iron must be set to around 373 °C in general, although the temperature depends on the heat capacity of the PC board on which reworking is required and the weight of the tip of the soldering iron.

Do NOT use a soldering iron whose tip temperature cannot be controlled.

B

Compared with eutectic solders, lead-free solders have higher bond strengths but slower wetting times and higher melting temperatures (hard to melt/easy to harden).

The following lead-free solders are available as service parts:

- Parts numbers of lead-free solder:  
GYP1006 1.0 in dia.  
GYP1007 0.6 in dia.  
GYP1008 0.3 in dia.

C

D

E

F

# 2. SPECIFICATIONS

## 2.1 ACCESSORIES

- Setup microphone : APM7011
- Remote control unit (AXD7719) : 8300771900010-IL
- AM loop antenna : E601019000010-IL
- FM wire antenna : E605010140010-IL
- Power cord : L068250160020-IL
- Quick start guide : 5707000008480-IL
- Speaker caution sheet : 5227000001050-IL
- Operating instructions (CD-ROM) : 6517000001550-IL
- Warranty card : ARY7158
- AAA size IEC R03 dry cell batteries x2

## 2.2 SPECIFICATIONS

### Audio section

- Rated power output  
(Front, Center, Surround and Surround back for VSX-S510)  
..... 110 W per channel (1 kHz, 4 Ω, 1 %)  
65 W per channel (20 Hz to 20 kHz, 8 Ω, 0.5 %)
- Total Harmonic Distortion  
..... 0.08 % (20 Hz to 20 kHz, 8 Ω, Rated Output -3 dB/ch)
- Frequency response (Pure Direct mode)  
..... 10 Hz to 20 kHz ±3 dB
- Guaranteed speaker impedance ..... 4 Ω to 16 Ω
- Input Sensitivity  
CD ..... 200 mV
- Signal-to-Noise Ratio (IHF, short circuited, A network)  
CD ..... 95 dB

### Video Section (VSX-S310 only)

- Signal level  
Composite Output ..... 1 Vp-p (75 Ω)

### Tuner Section

- Frequency Range (FM) ..... 87.5 MHz to 108 MHz
- Antenna Input (FM) ..... 75 Ω unbalanced
- Frequency Range (AM) ..... 531 kHz to 1602 kHz
- Antenna (AM) ..... Loop antenna

### Digital In/Out Section

- HDMI terminal ..... Type A (19-pin)
- HDMI input/MHL terminal (VSX-S510 only) ..... 5 V, 0.9 A
- USB terminal  
..... USB2.0 High Speed (Type A) 5 V, 2.1 A (VSX-S510)  
..... USB2.0 Full Speed (Type A) 5 V, 1 A (VSX-S310)
- iPod terminal ..... USB
- ADAPTER PORT terminal (VSX-S510 only) ..... 5 V, 0.1 A

### Network Section (VSX-S510 only)

- LAN terminal ..... 10 BASE-T/100 BASE-TX

### Miscellaneous

- Power Requirements ..... AC 220 V to 230 V, 50 Hz/60 Hz
- Power Consumption ..... 96 W (VSX-S510)  
70 W (VSX-S310)
- In standby ..... 0.3 W
- Dimensions  
..... 435 mm (W) x 85 mm (H) x 317 mm (D)
- Weight (without package) ..... 4.1 kg (VSX-S510)  
4.0 kg (VSX-S310)

### Note

- The specifications are applicable when the power supply is 230 V.
- Specifications and the design are subject to possible modifications without notice, due to improvements.
- *This product includes FontAvenue® fonts licensed by NEC Corporation. FontAvenue is a registered trademark of NEC Corporation.*
- *Microsoft, Windows, Windows Media and Windows Vista are either registered trademarks or trademarks of Microsoft Corporation in the United States and/or other countries.*

#### VSX-S510

Manufactured under license under U.S. Patent Nos: 5,956,674; 5,974,380; 6,226,616; 6,487,535; 7,212,872; 7,333,929; 7,392,195; 7,272,567 & other U.S. and worldwide patents issued & pending. DTS-HD, the Symbol, & DTS-HD and the Symbol together are registered trademarks & DTS-HD Master Audio is a trademark of DTS, Inc. Product includes software. © DTS, Inc. All Rights Reserved.

#### VSX-S310

Manufactured under license under U.S. Patent Nos: 5,956,674; 5,974,380; 6,226,616; 6,487,535; 7,212,872; 7,333,929; 7,392,195; 7,272,567 & other U.S. and worldwide patents issued & pending. DTS-HD, the Symbol, & DTS-HD and the Symbol together are registered trademarks of DTS, Inc. Product includes software. © DTS, Inc. All Rights Reserved.

Manufactured under license from Dolby Laboratories. Dolby, Pro Logic, and the double-D symbol are trademarks of Dolby Laboratories.

Apple, AirPlay, iPad, iPhone, iPod, iPod nano, iPod touch, iTunes, Safari, Bonjour and Mac are trademarks of Apple Inc., registered in the U.S. and other countries. The Airplay logo is a trademark of Apple Inc.

Windows® and the Windows logo are trademarks of the Microsoft group of companies.

MHL, the MHL Logo, and Mobile High-Definition Link are trademarks or registered trademarks of MHL, LLC in the United States and other countries. This receiver incorporates MHL 2.

HTC, HTC Connect and the HTC Connect logo are trademarks of HTC Corporation.

## 3. BASIC ITEMS FOR SERVICE

### 3.1 CHECK POINTS AFTER SERVICING

#### A Items to be checked after servicing

To keep the product quality after servicing, confirm recommended check points shown below.

No.	Procedures	Check points
1	Confirm whether the customer complain has been solved. If the customer complain occurs with the particular source, such as Dolby Digital, DTS, AAC, DVD-A and HDMI, input it for the operation check.	The customer complain must not be reappeared. Video, Audio and operations must be normal.
2	Check the analog audio playback. (Make the analog connections with a DVD player.)	Each channel audio and operations must be normal.
3	Check the digital audio playback. (Make the digital connections with a DVD player.)	Each channel audio and operations must be normal.
4	Check surround playback. (Select Surround mode and check the multichannel operations via the DSP circuit.)	Each channel audio and operations must be normal.
5	Check the video outputs. (Connect with a DVD player.)	Video and operations must be normal.
6	Check the tuner (AM and FM) operations.	Audio and operations must be normal.
7	Check the sound from headphone output.	Sound must be normal, without noise.
8	Check the appearance of the product.	No scratches or dirt on its appearance after receiving it for service.

See the table below for the items to be checked regarding video and audio.

Item to be checked regarding video	Item to be checked regarding audio
Block noise	Distortion
Horizontal noise	Noise
Flicker	Volume too low
Disturbed image (video jumpiness)	Volume too high
Too dark	Volume fluctuating
Too bright	Sound interrupted
Mottled color	

5 6 7 8

## 3.2 PCB LOCATIONS

### VSX-S510

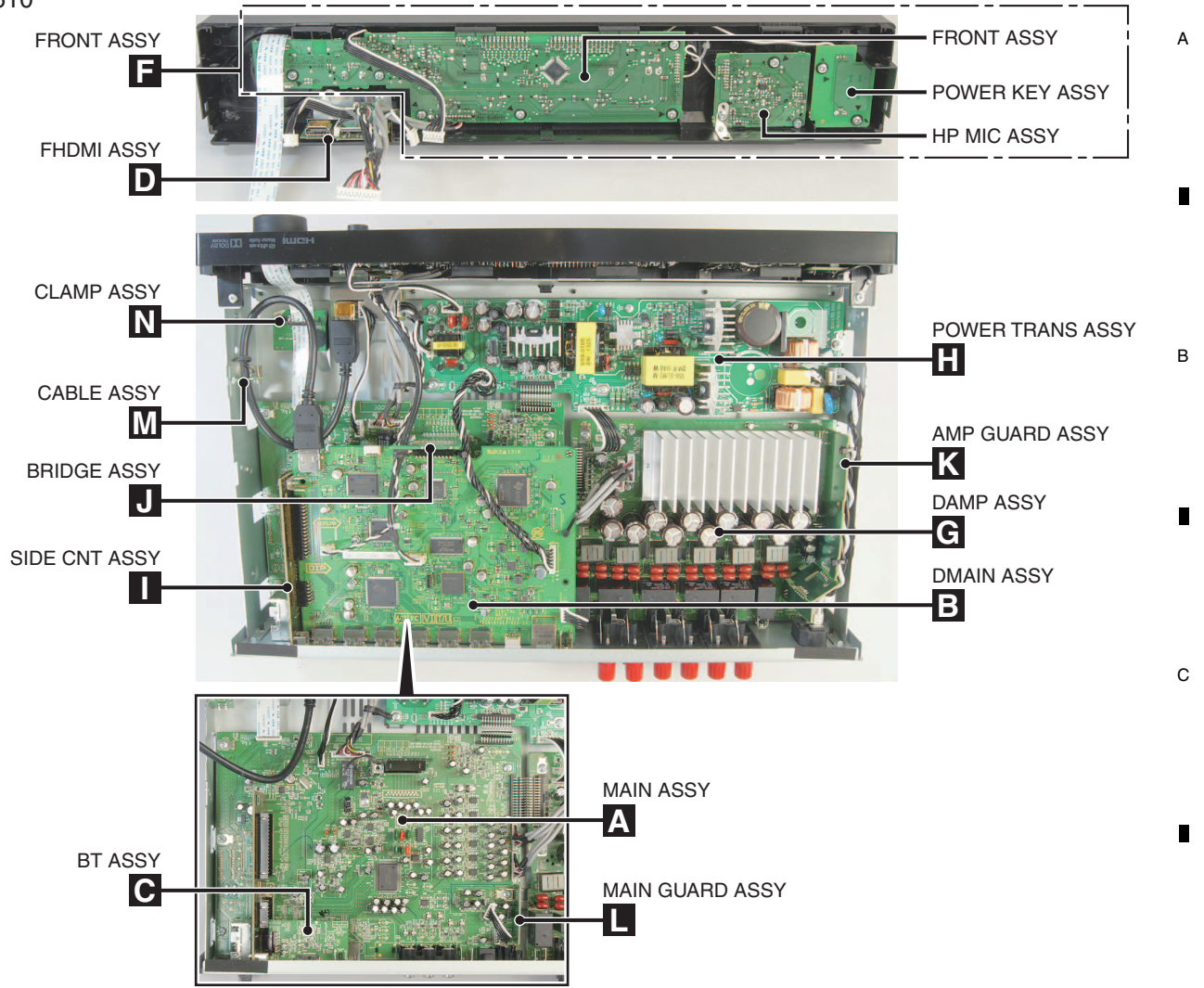

### VSX-S310

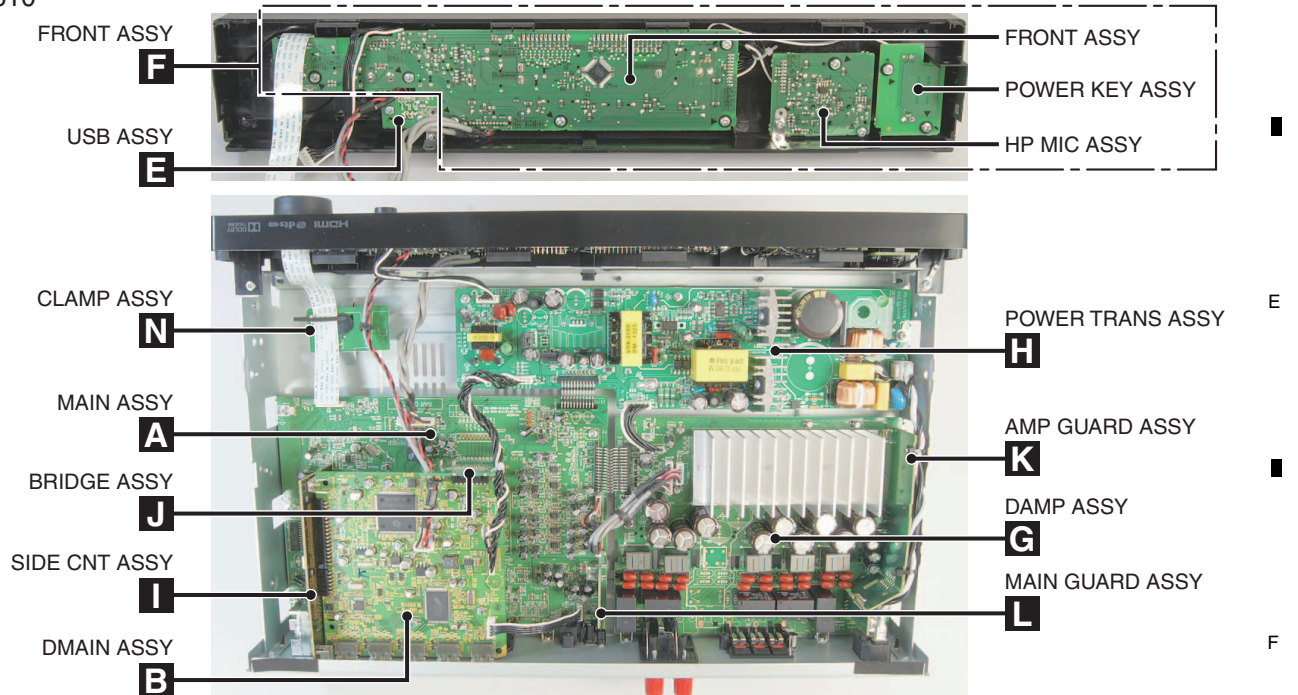

NOTES: ● Parts marked by “NSP” are generally unavailable because they are not in our Master Spare Parts List.

- The  $\triangle$  mark found on some component parts indicates the importance of the safety factor of the part. Therefore, when replacing, be sure to use parts of identical designation.

Mark No.	Description	Part No.	Mark No.	Description	Part No.
<b>LIST OF ASSEMBLIES</b>					
NSP	1..MAIN ASSY (VSX-S510) 2..MAIN ASSY	7025HK1301010-IL 7028074101010-IL	NSP	1.. DAMP ASSY (VSX-S310) 2..DAMP ASSY 2..BRIDGE ASSY	7025HK1302012-IL 7028074111050-IL 7028074114050-IL
NSP	1..MAIN ASSY (VSX-S310) 2..MAIN ASSY	7025HK1302010-IL 7028074101050-IL		2..MAIN GUARD ASSY 2..USB ASSY 2..CLAMP ASSY	7028074115010-IL 7028074116050-IL 7028074117050-IL
NSP	1..FRONT ASSY (VSX-S510) 2..FRONT ASSY 2..AMP GUARD ASSY	7025HK1301011-IL 7028074121010-IL 7028074123010-IL	NSP	1..DMAIN ASSY (VSX-S510) 2..DMAIN ASSY	7025HK1301013-IL 70280732310C0-IL
	2..SIDE CNT ASSY	7028074124010-IL			
NSP	1..FRONT ASSY (VSX-S310) 2..FRONT ASSY 2..AMP GUARD ASSY 2..SIDE CNT ASSY	7025HK1302011-IL 7028074121050-IL 7028074123010-IL 7028074124050-IL	NSP	1..DMAIN ASSY (VSX-S310) 2..DMAIN ASSY	7025HK1302013-IL 7028073351090-IL
NSP	1.. DAMP ASSY (VSX-S510) 2..DAMP ASSY 2..BT ASSY 2..CABLE ASSY 2..BRIDGE ASSY 2..MAIN GUARD ASSY 2..CLAMP ASSY	7025HK1301012-IL 7028074111010-IL 7028074112010-IL 7028074113010-IL 7028074114010-IL 7028074115010-IL 7028074117010-IL	NSP	1..FHDMI ASSY (VSX-S510) 2..FHDMI ASSY	7025HK1301014-IL 7028074131010-IL
				1..POWER TRANS ASSY (VSX-S510) 1..POWER TRANS ASSY (VSX-S310)	8208001050010-IL 8208001050030-IL

### 3.3 JIGS LIST

#### [1] Jigs List

Name	Jig No.	Remarks
RS-232C update jig (Jig + 10P FFC)	GGF1642	MAIN microcomputer firmware update (RS-232C ↔ Back Chassis)
RS-232C cable (9-pin to 9-pin, straight cable)	Marketing product	
RS-232C update jig	GGF1646 (VSX-S310 only)	HDMI & CEC (SUB) microcomputer firmware update (USB ↔ Back Chassis)
USB cable (USB A-Type ↔ USB B-Type)	Marketing product (VSX-S310 only)	
11P board to board extension jig cable	GGD1846	Diagnosis for DMAIN ASSY (side-B), MAIN ASSY (side-A)
33P board to board extension jig cable	GGD1847	
19P board to board extension jig cable	GGD1849	
5P PH Housing ASSY extension jig cable	GGD1594	
11P bridge connector extension jig cable	GGD1758	Diagnosis for MAIN ASSY (side-B), DAMP ASSY (side-B)





5



6



7



8



A



B



C



D



E



F



5



6

VSX-S510-K



7



8

9



# 4. BLOCK DIAGRAM

## 4.1 OVERALL CONNECTION DIAGRAM

- When ordering service parts, be sure to refer to "EXPLODED VIEWS and PARTS LIST" or "PCB PARTS LIST".
- The ⚠ mark found on some component parts indicates the importance of the safety factor of the part. Therefore, when replacing, be sure to use parts of identical designation.

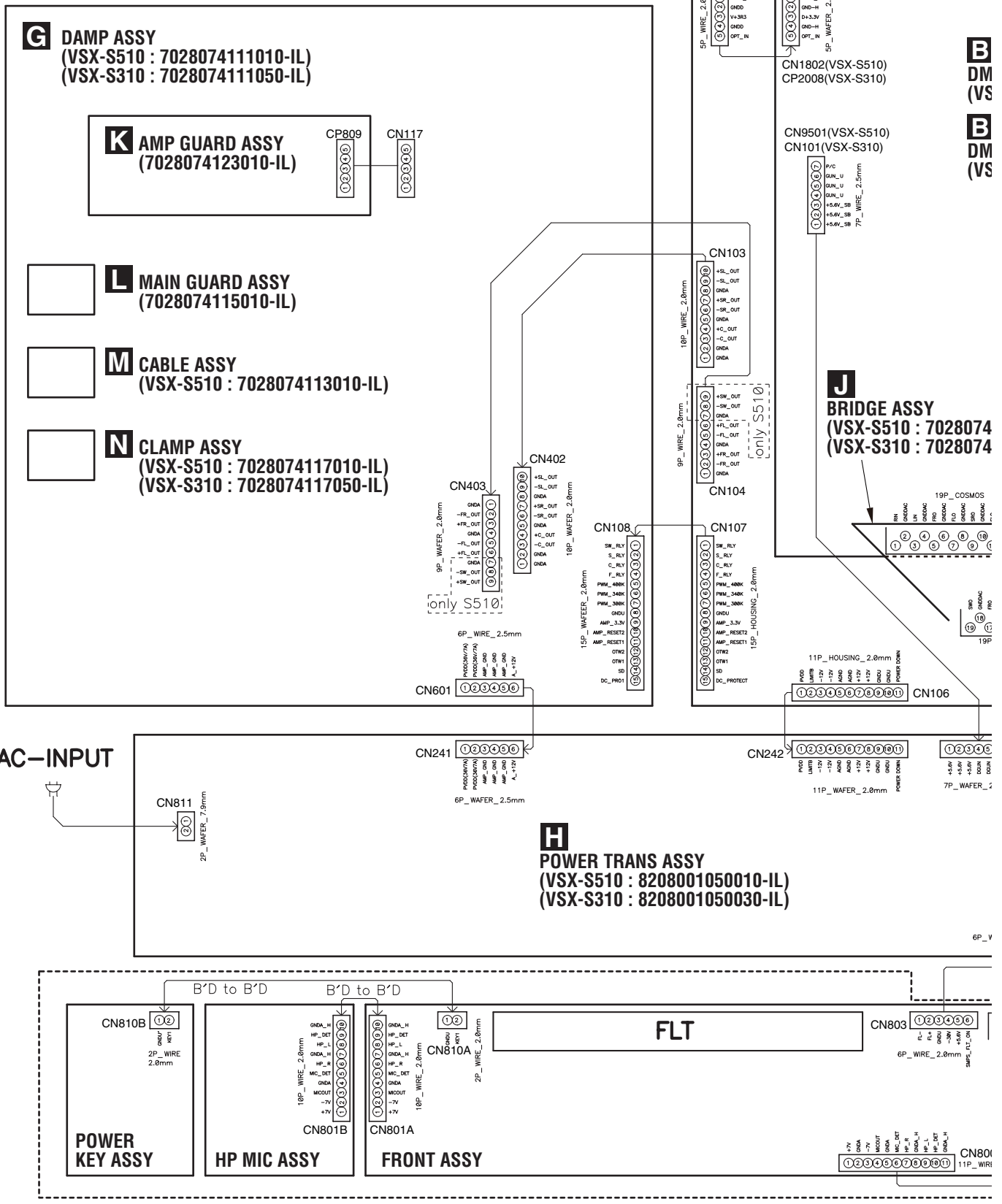

**B**  
DM  
(VS)

**B**  
DM  
(VS)

A

B

C

D

E

F

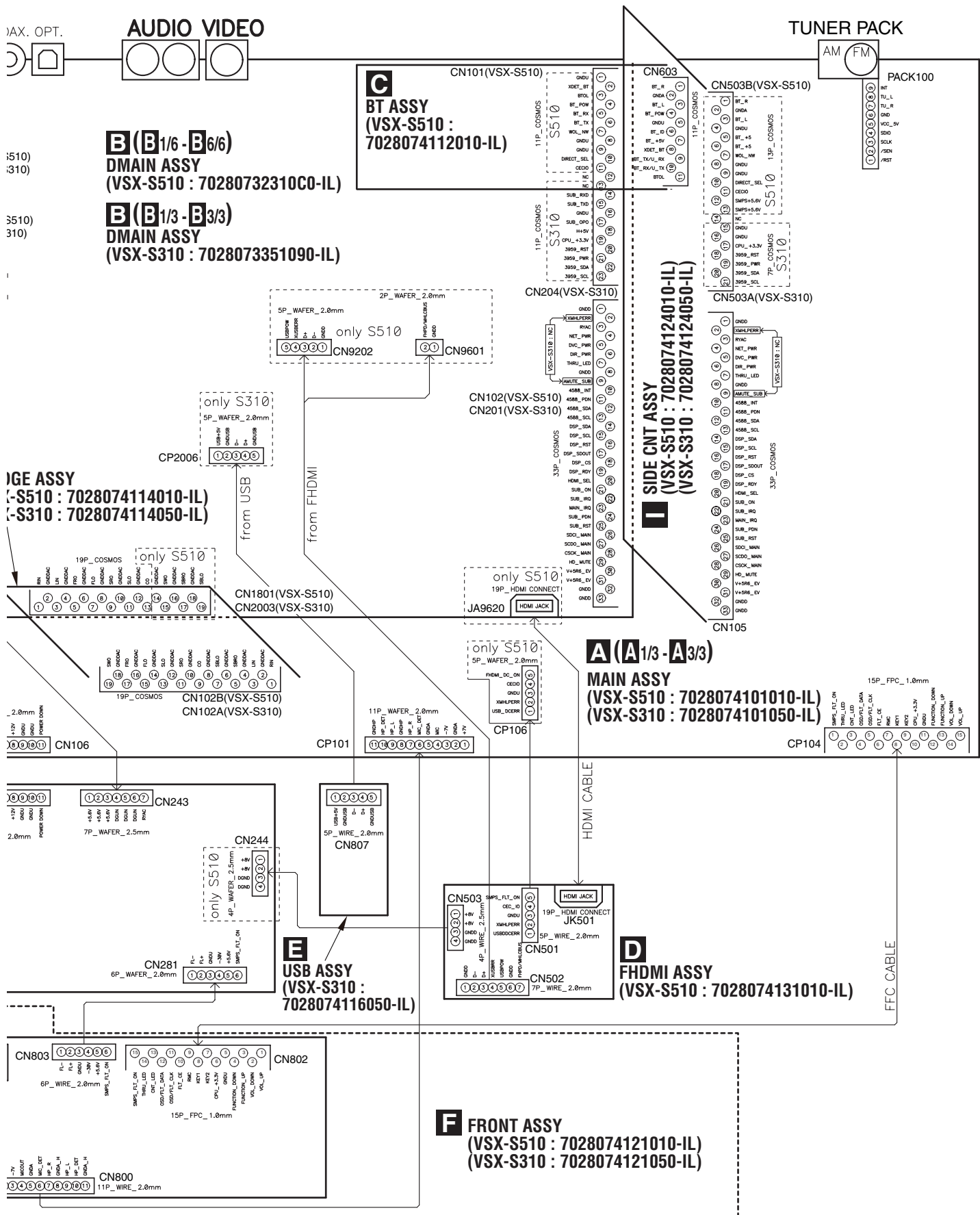

**B (B1/6 - B6/6)**  
**DMAIN ASSY**  
 (VSX-S510 : 70280732310C0-IL)

**B (B1/3 - B3/3)**  
**DMAIN ASSY**  
 (VSX-S310 : 7028073351090-IL)

**C**  
**BT ASSY**  
 (VSX-S510 : 7028074112010-IL)

**I**  
**SIDE CNT ASSY**  
 (VSX-S510 : 7028074124010-IL)  
 (VSX-S310 : 7028074124050-IL)

**A (A1/3 - A3/3)**  
**MAIN ASSY**  
 (VSX-S510 : 7028074101010-IL)  
 (VSX-S310 : 7028074101050-IL)

**E**  
**USB ASSY**  
 (VSX-S310 : 7028074116050-IL)

**D**  
**FHDMI ASSY**  
 (VSX-S510 : 7028074131010-IL)

**F**  
**FRONT ASSY**  
 (VSX-S510 : 7028074121010-IL)  
 (VSX-S310 : 7028074121050-IL)

# 4.2 BLOCK DIAGRAM FOR AUDIO BLOCK

1

2

3

4

A

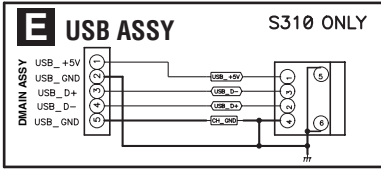

B

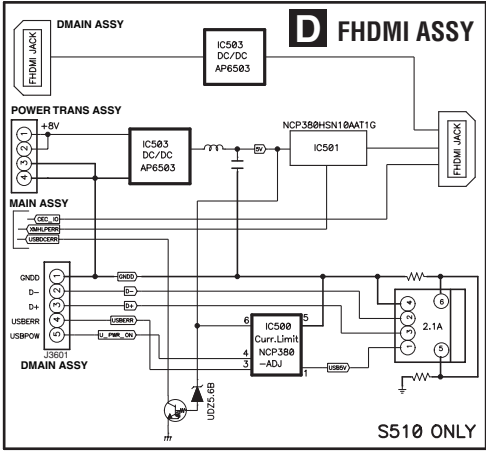

C

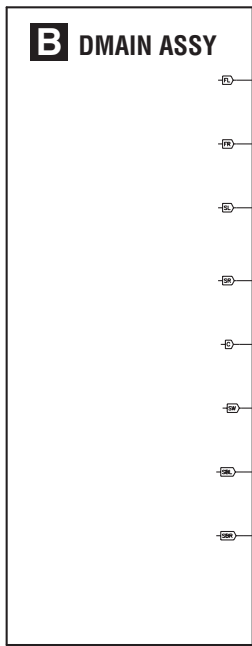

D

E

F

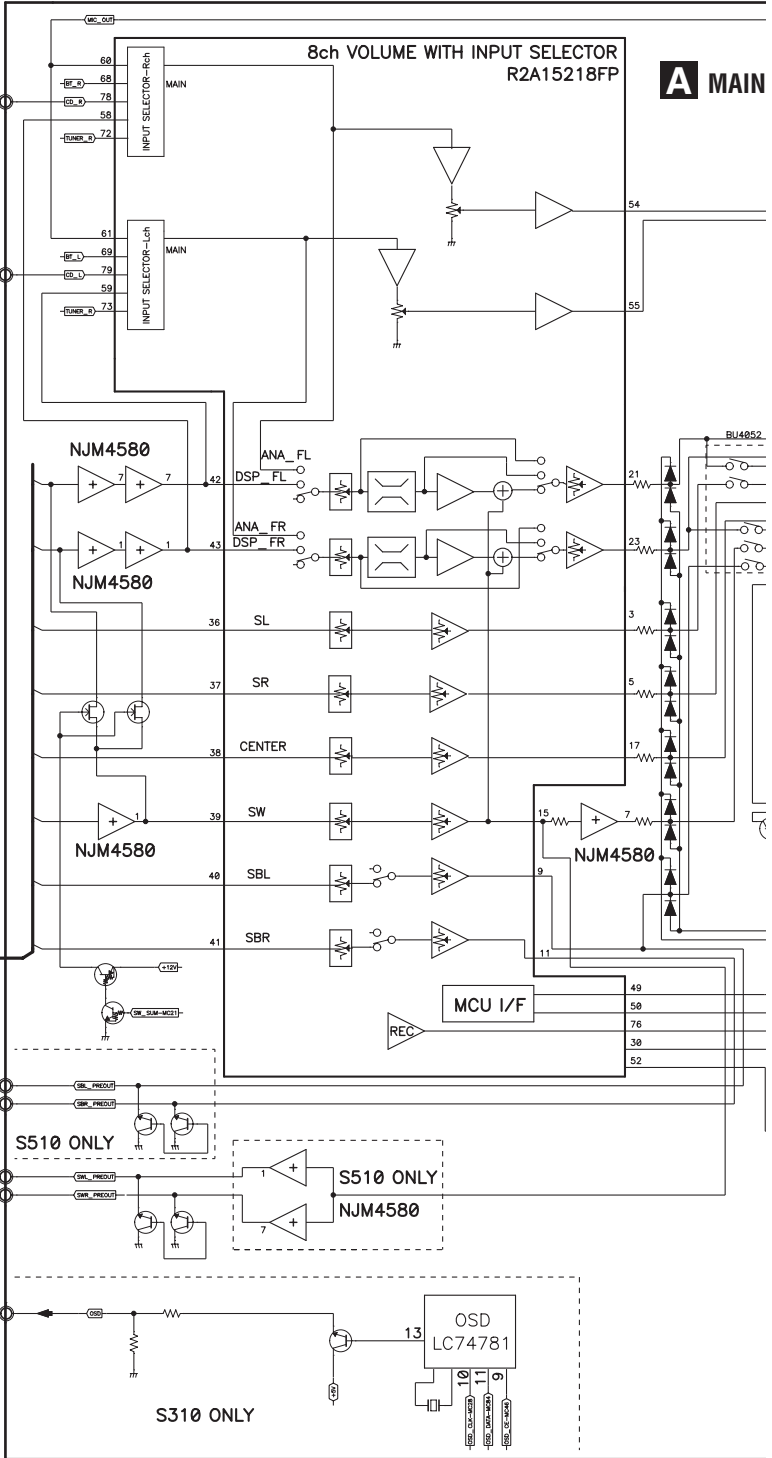
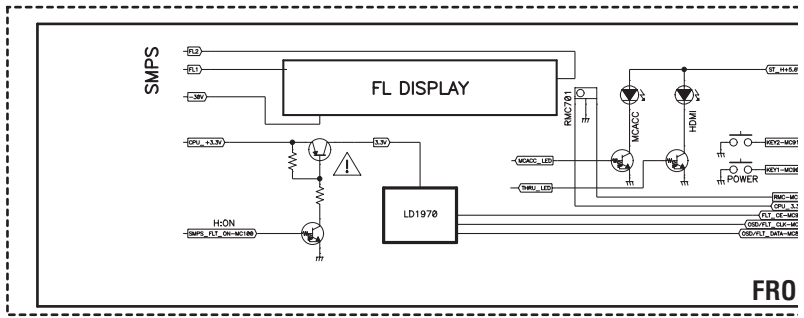
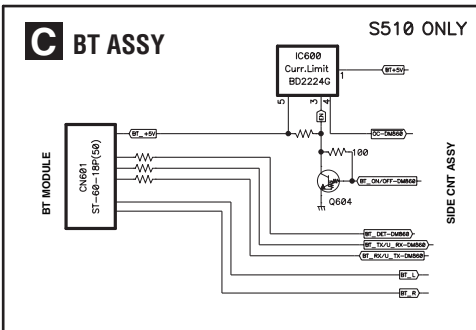

1

2

3

4

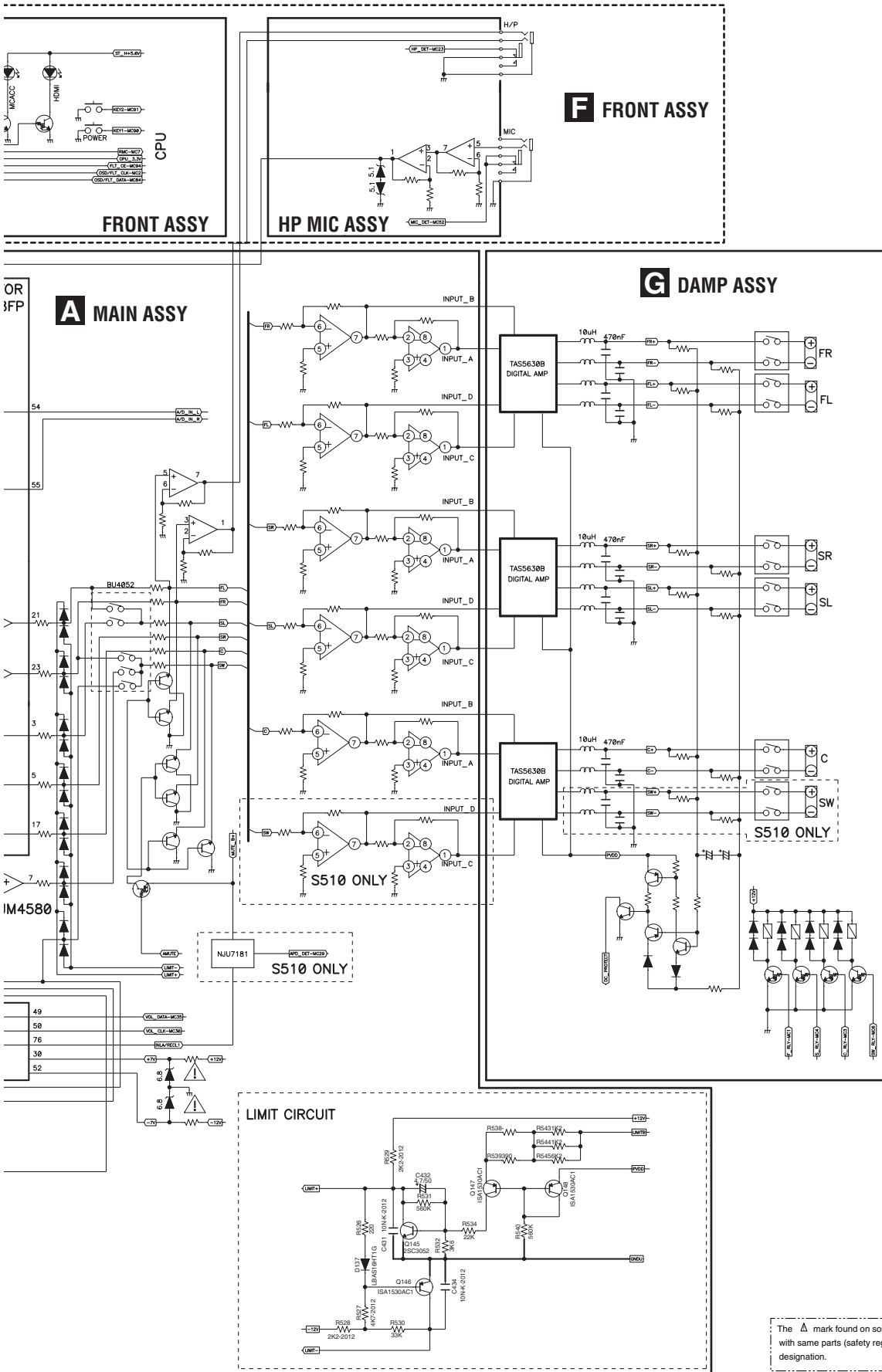

The  $\Delta$  mark found on some component parts should be replaced with same parts (safety regulation authorized) of identical designation.

### 4.3 BLOCK DIAGRAM FOR DMAIN ASSY (1) (VSX-S510)

A  
B  
C  
D  
E  
F

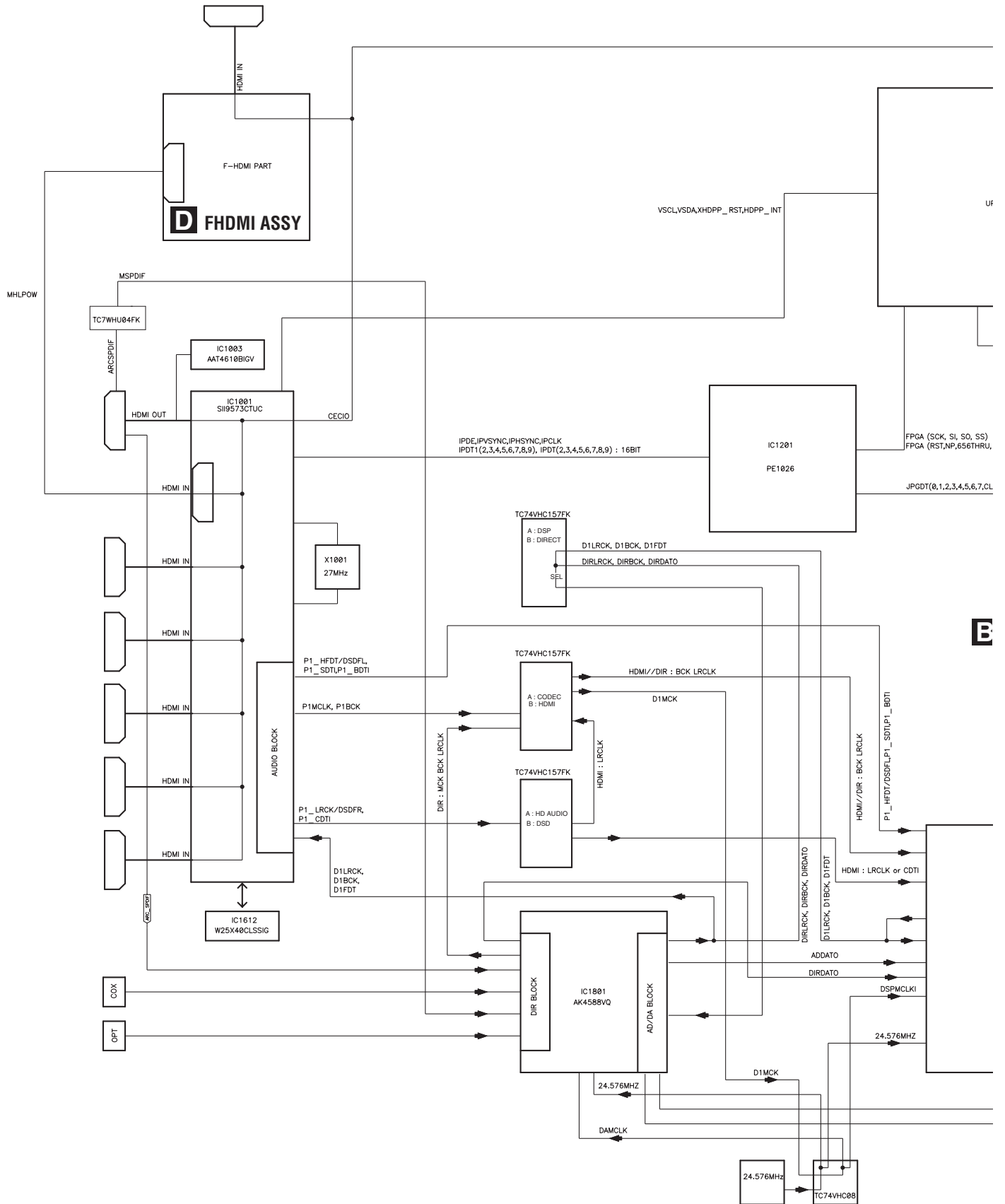

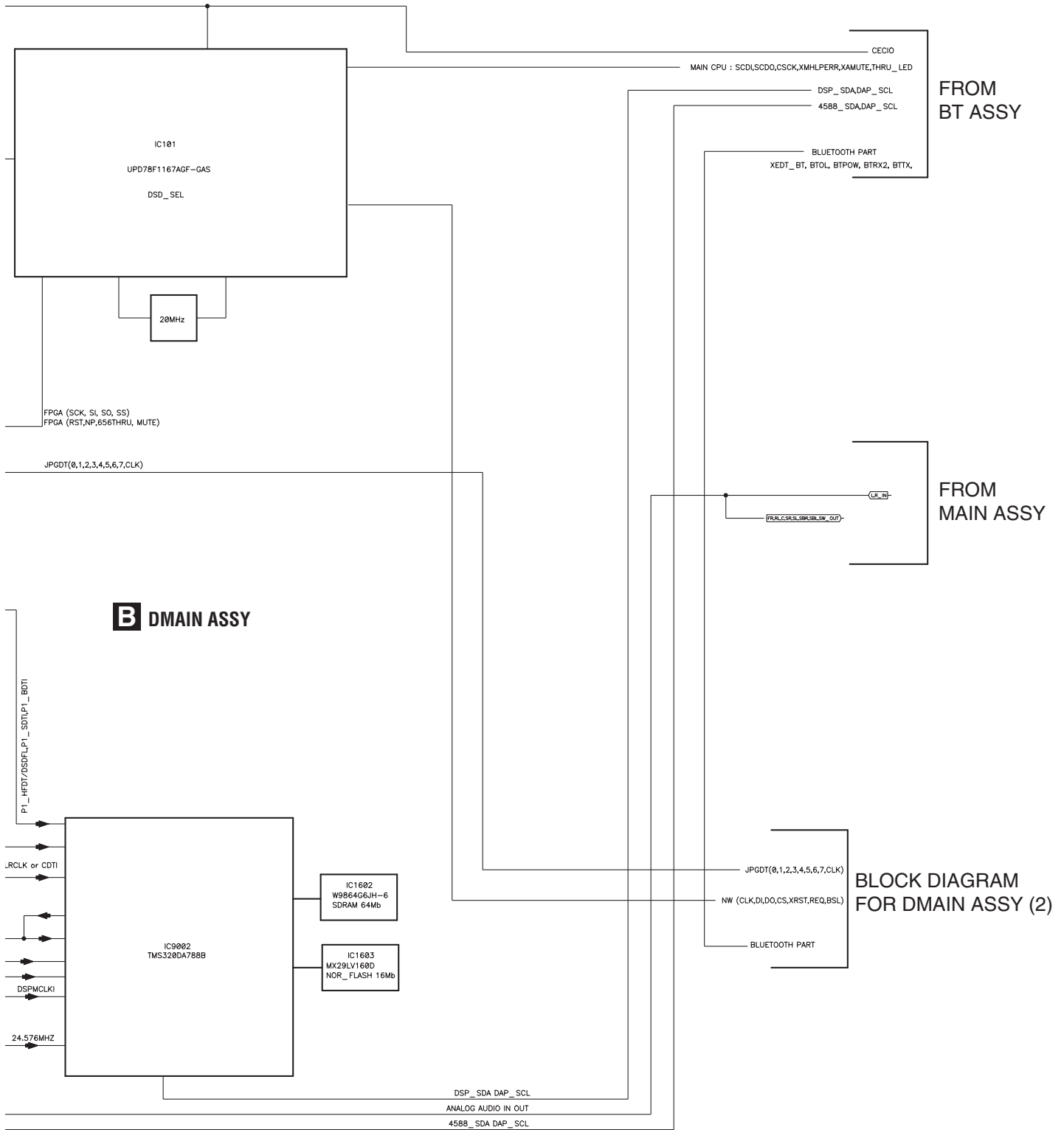

# 4.4 BLOCK DIAGRAM FOR DMAIN ASSY (2) (VSX-S510)

## NETWORK BLOCK DIAGRAM

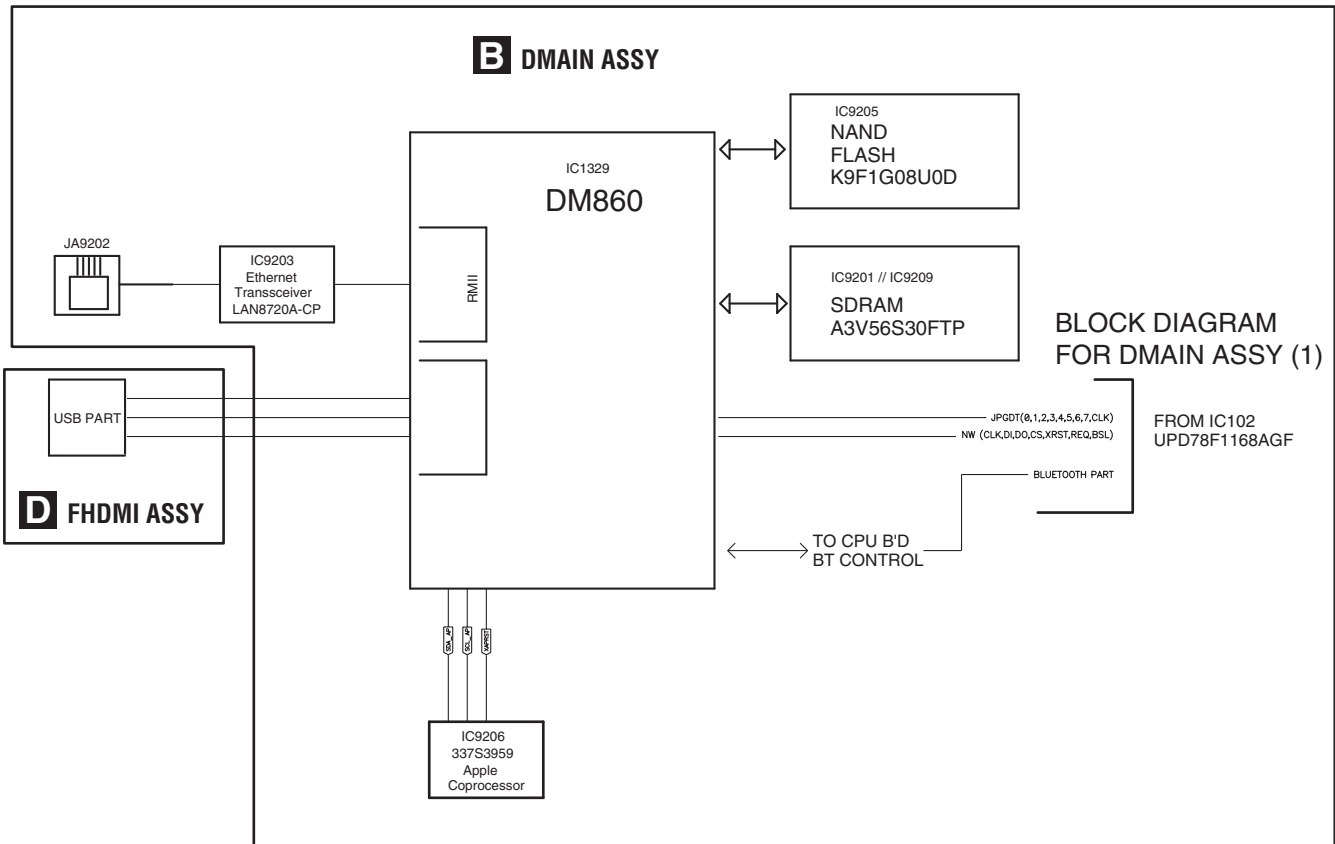





5



6



7



8



A



B



C



D



E



F



5



6

VSX-S510-K



7



8

17



# 4.5 BLOCK DIAGRAM FOR DMAIN ASSY (VSX-S310)

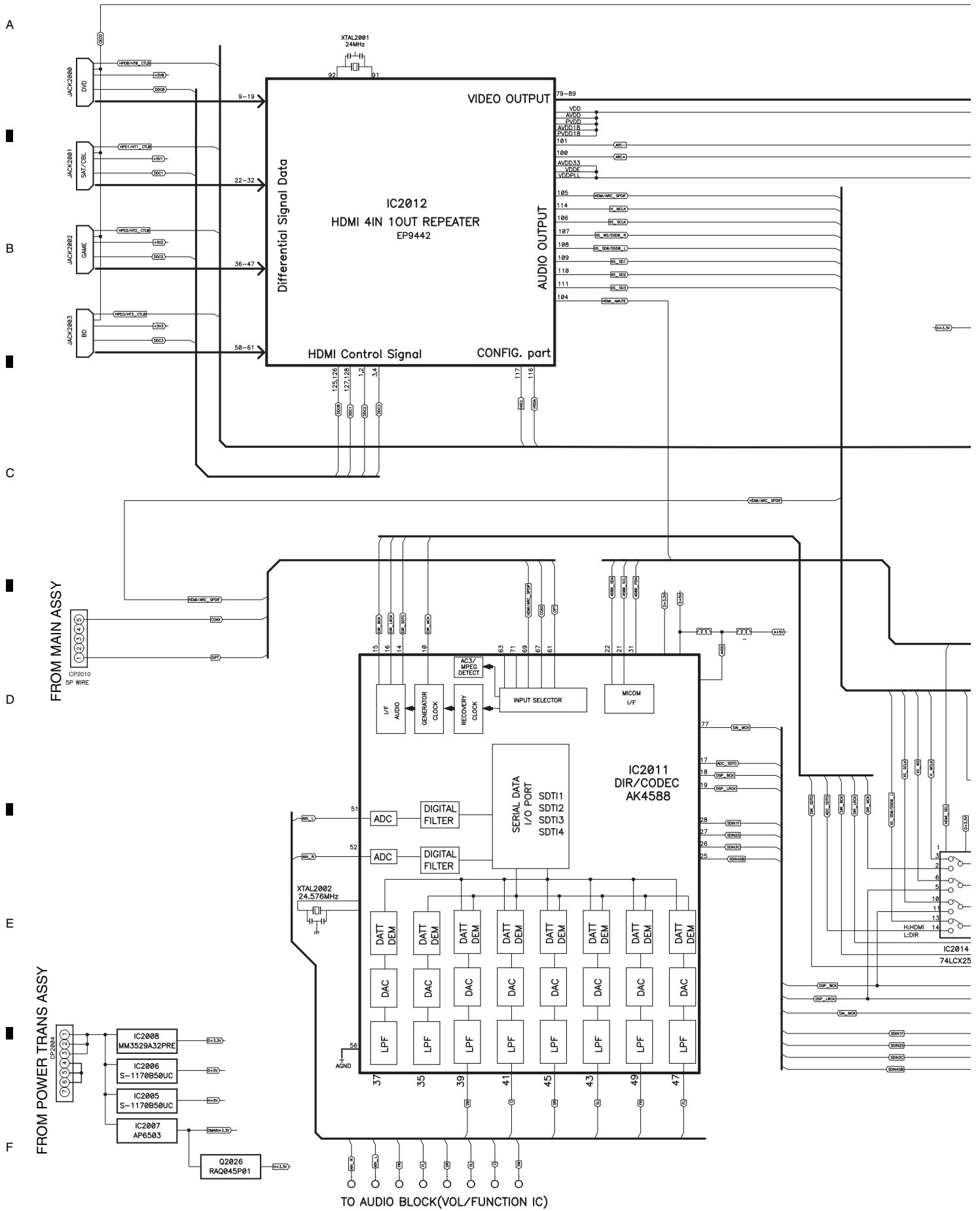

A  
B  
C  
D  
E  
F

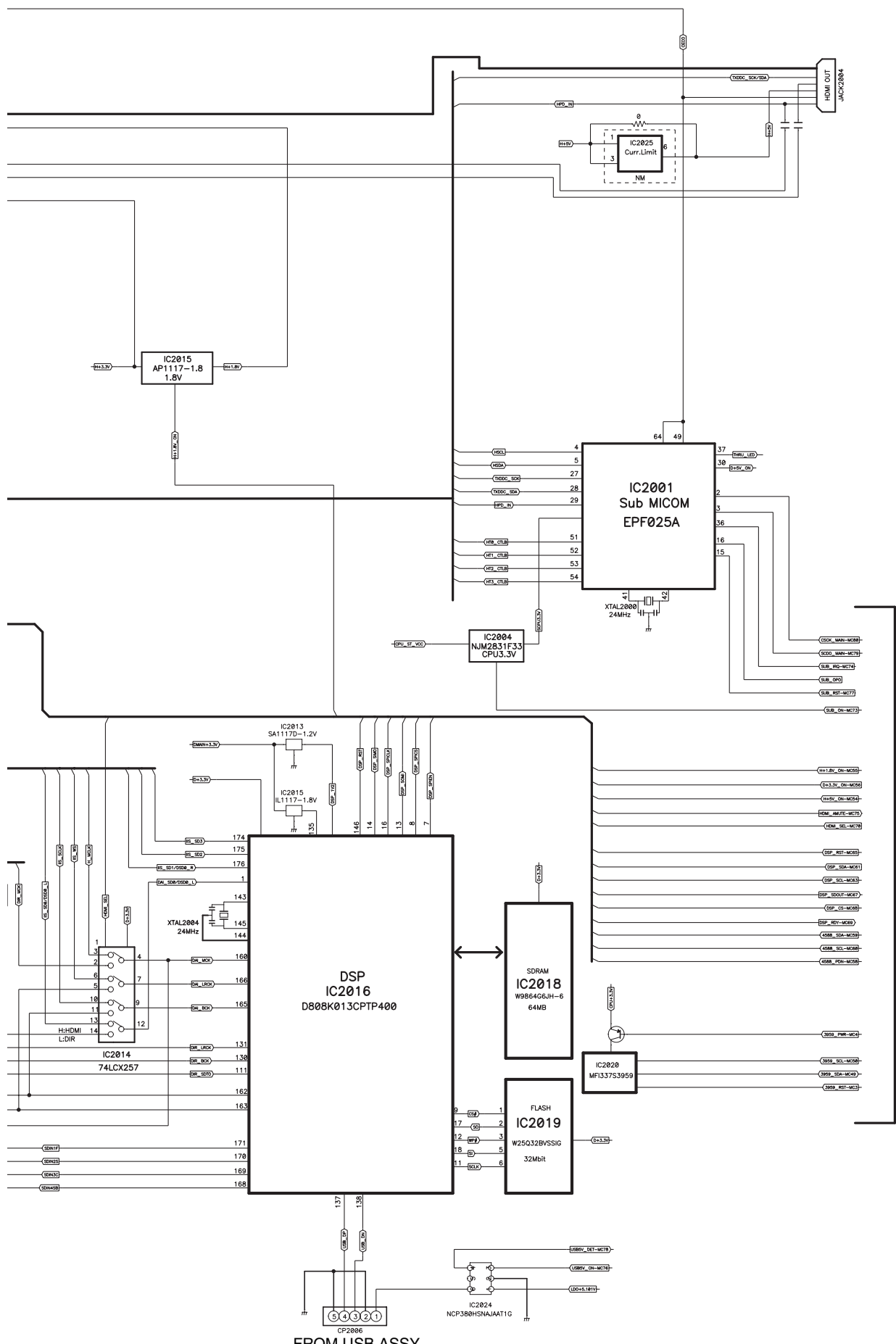

FROM USB ASSY

FROM MAIN ASSY

VSX-S510-K

# 4.6 BLOCK DIAGRAM FOR POWER BLOCK (1)

A  
B  
C  
D  
E  
F

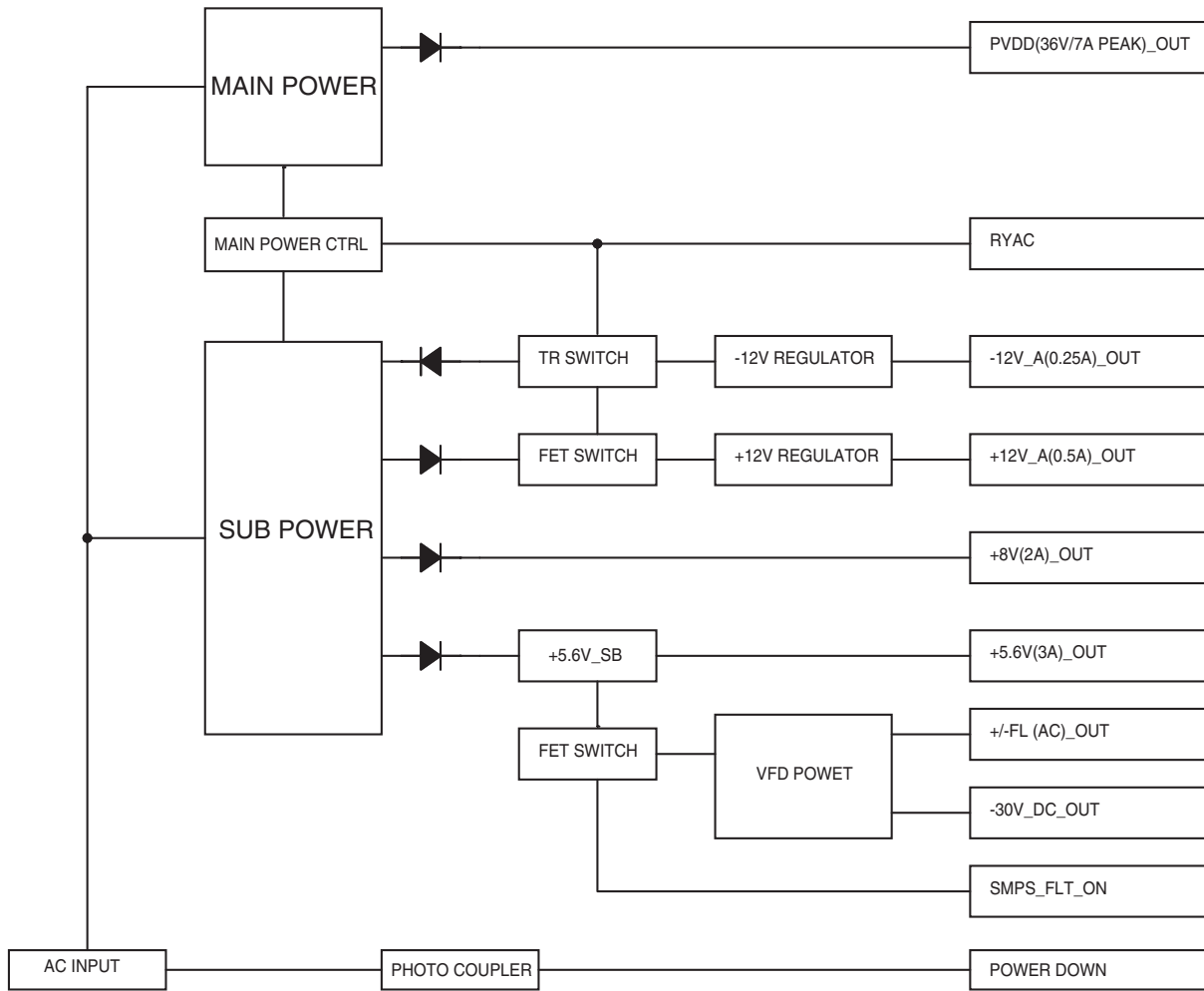



5



6



7



8



A



B



C



D



E



F



5



6

VSX-S510-K



7



8



# 4.7 BLOCK DIAGRAM FOR POWER BLOCK (2)

A  
B  
C  
D  
E  
F

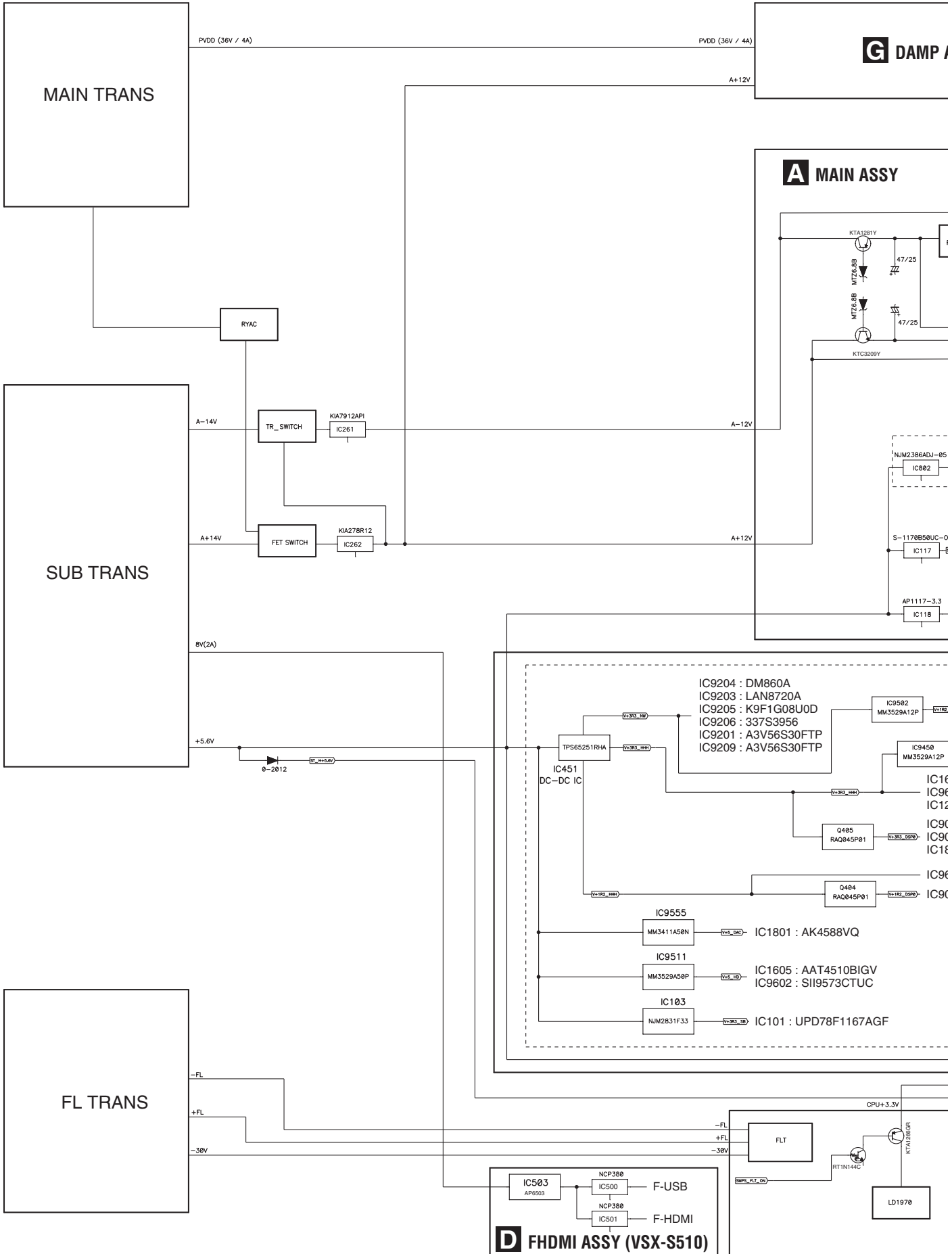

# DAMP ASSY

# IN ASSY

# BT

# TUNER

S510 ONLY

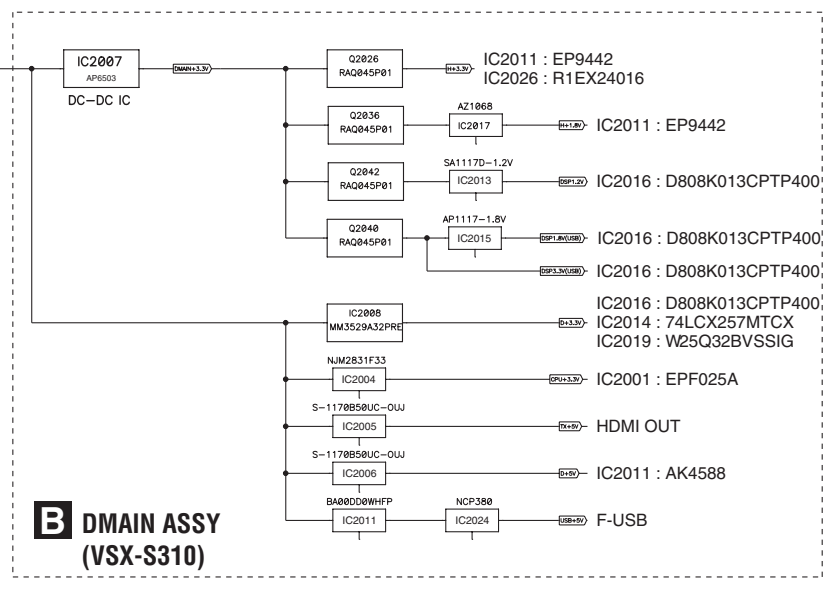
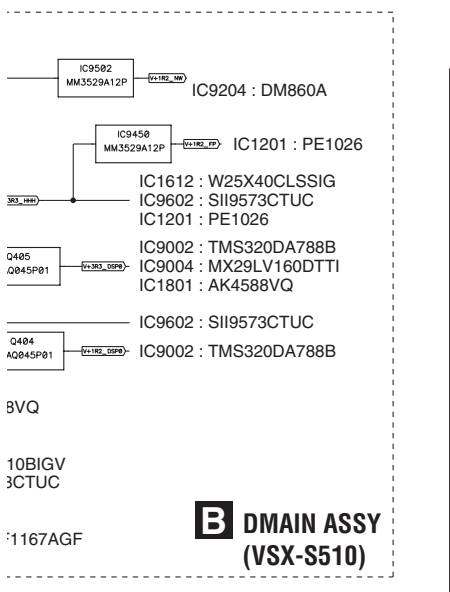
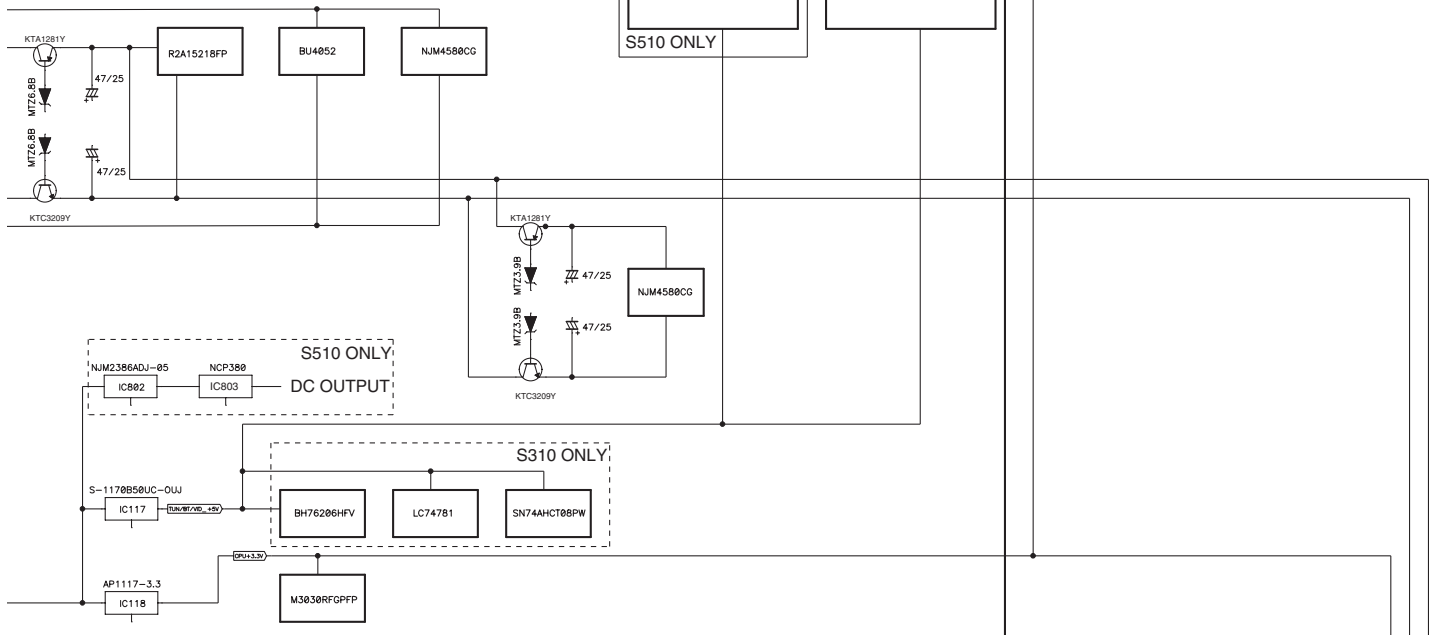

# 4.8 BLOCK DIAGRAM FOR GND BLOCK

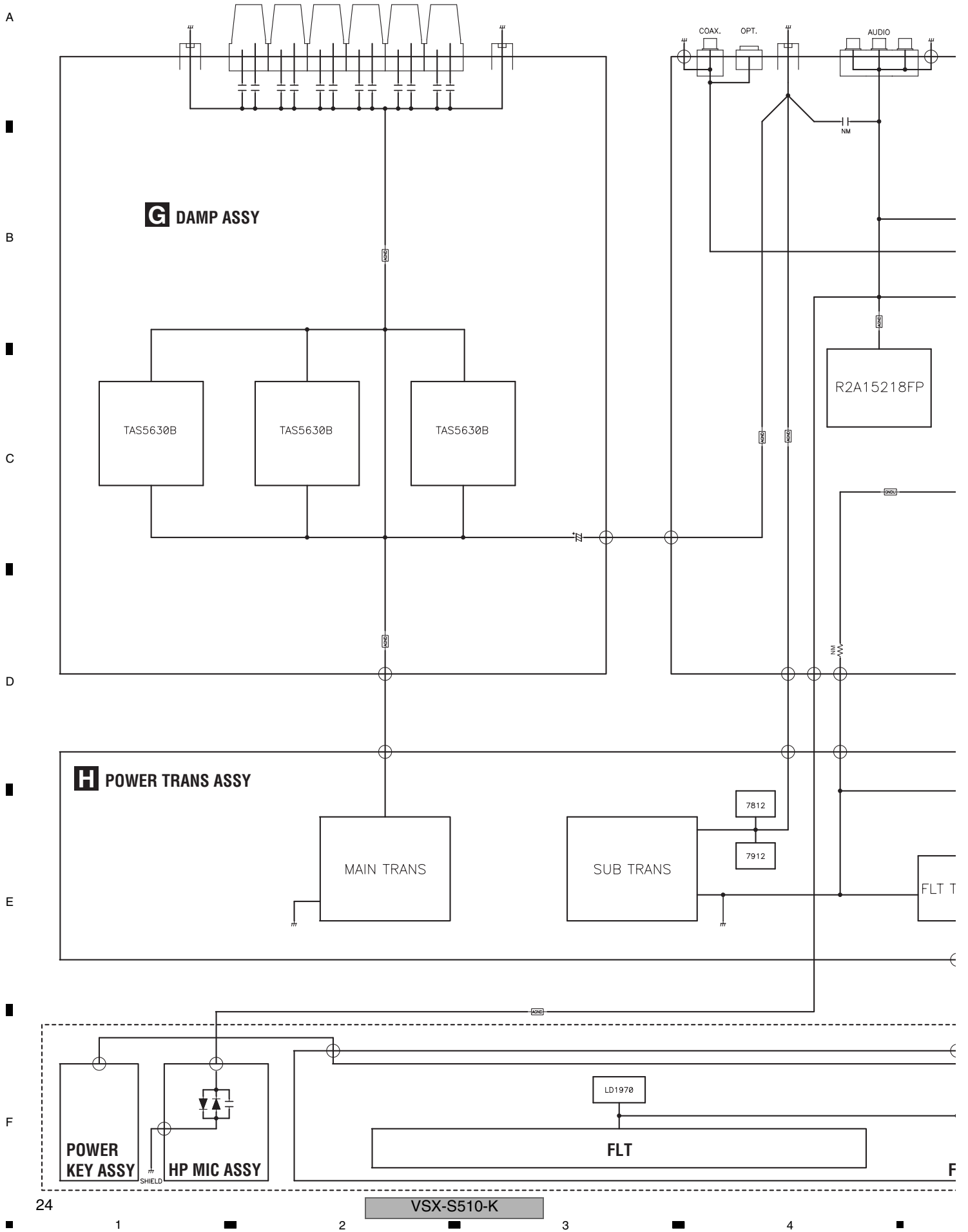



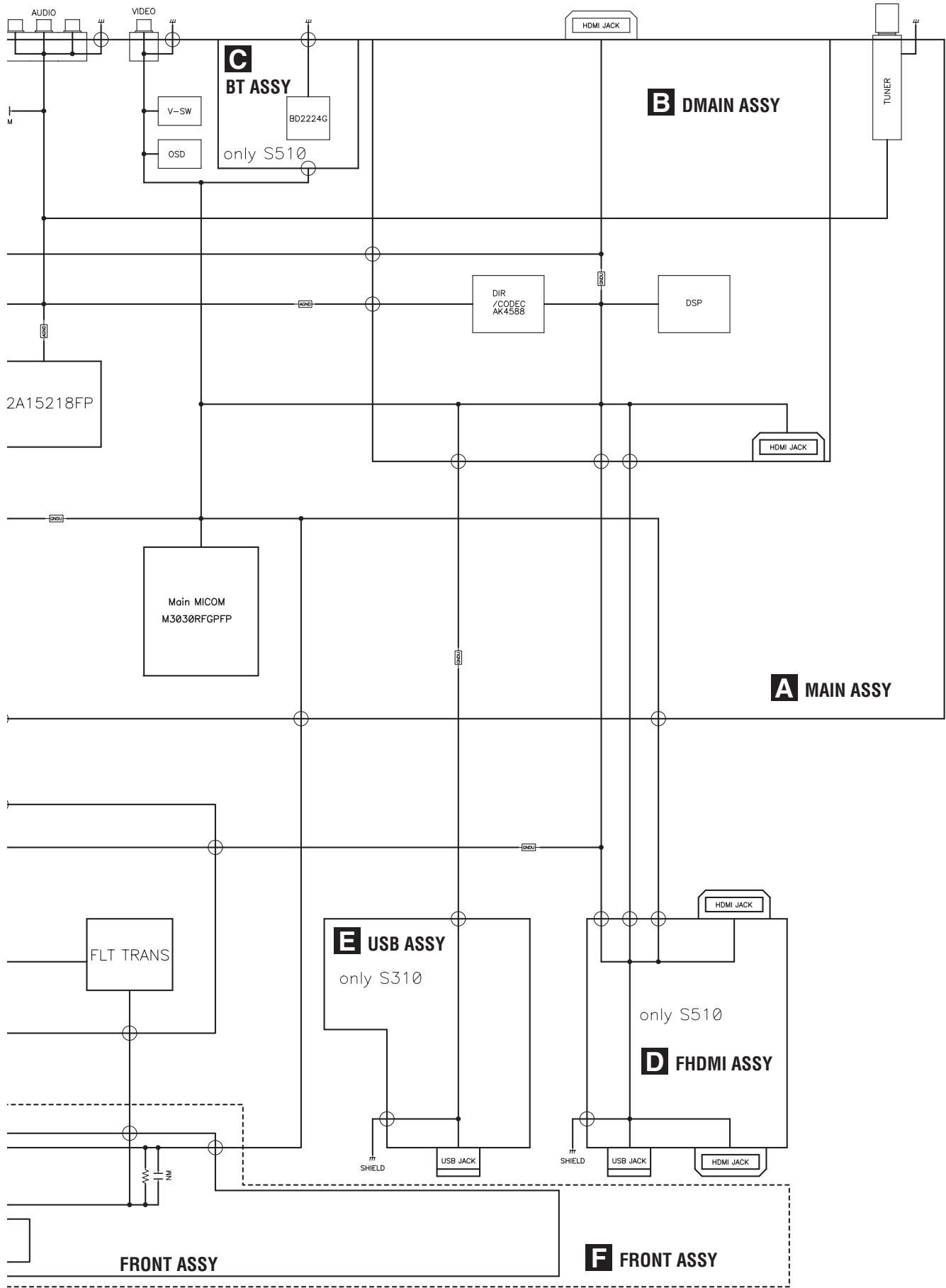

VSX-S510-K

# 5. DIAGNOSIS

## 5.1 TROUBLESHOOTING

### A [1] Initial Check

#### ■ The unit does not operate.

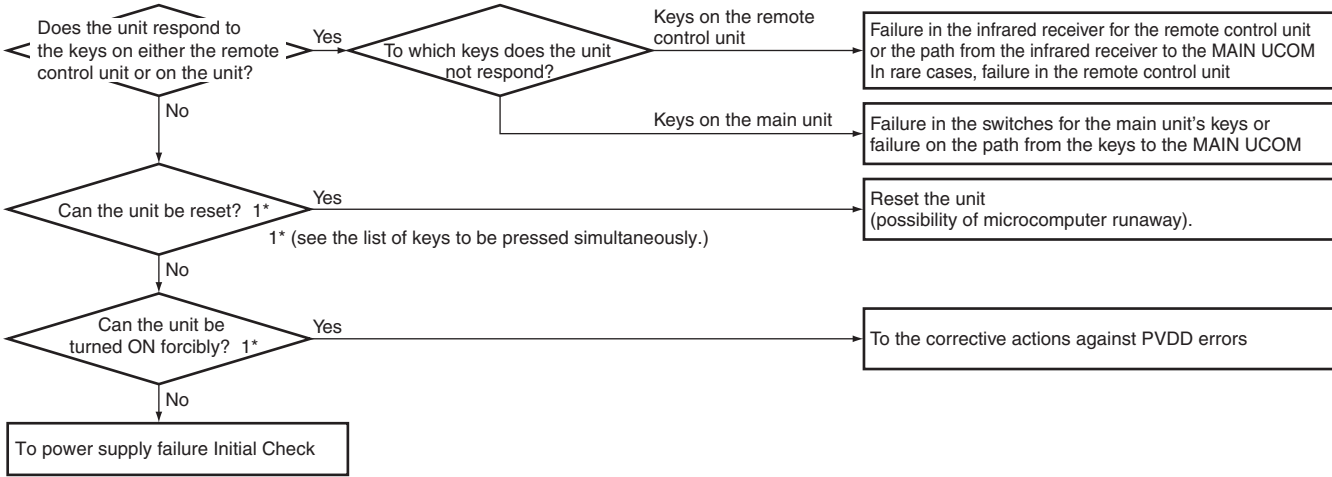

#### ■ No power

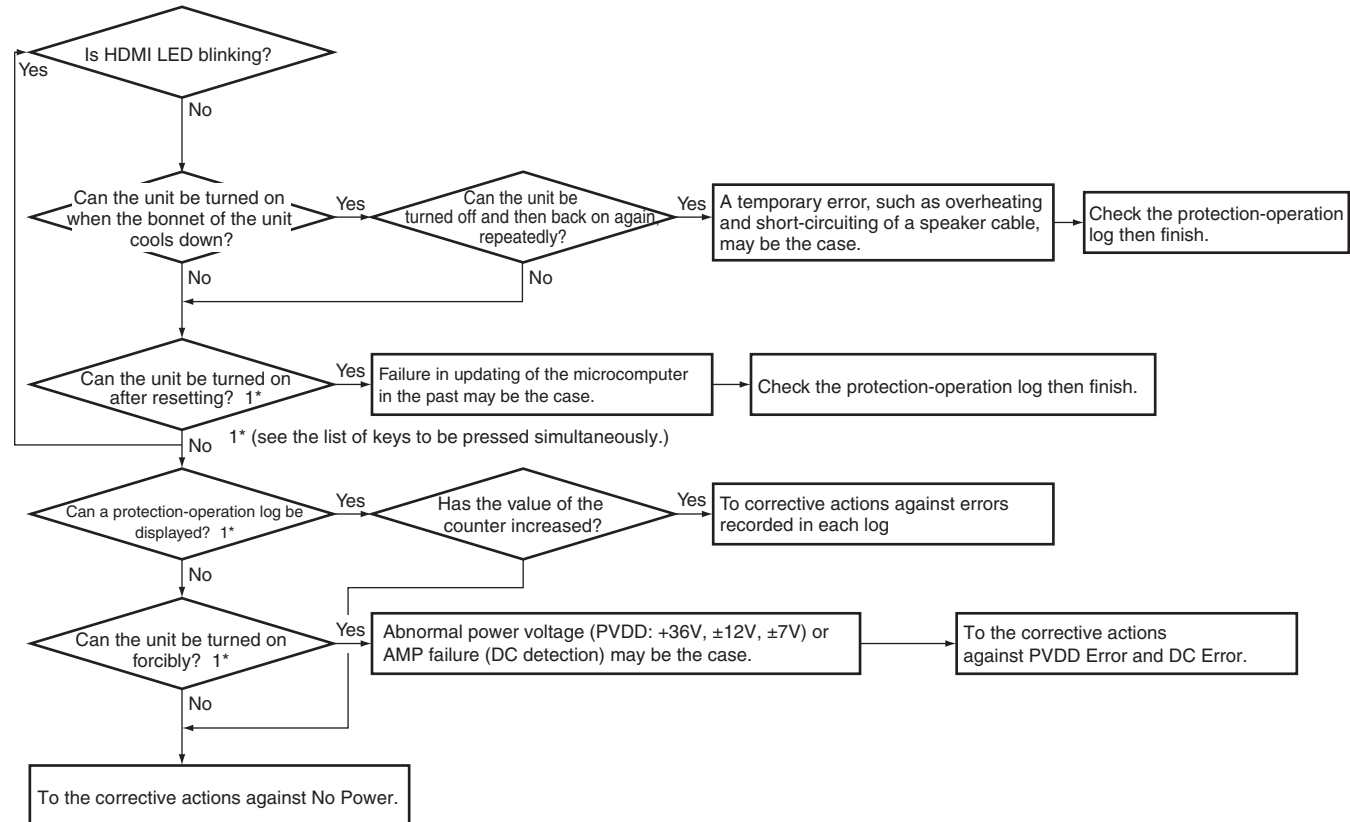

### ■ No audio/video

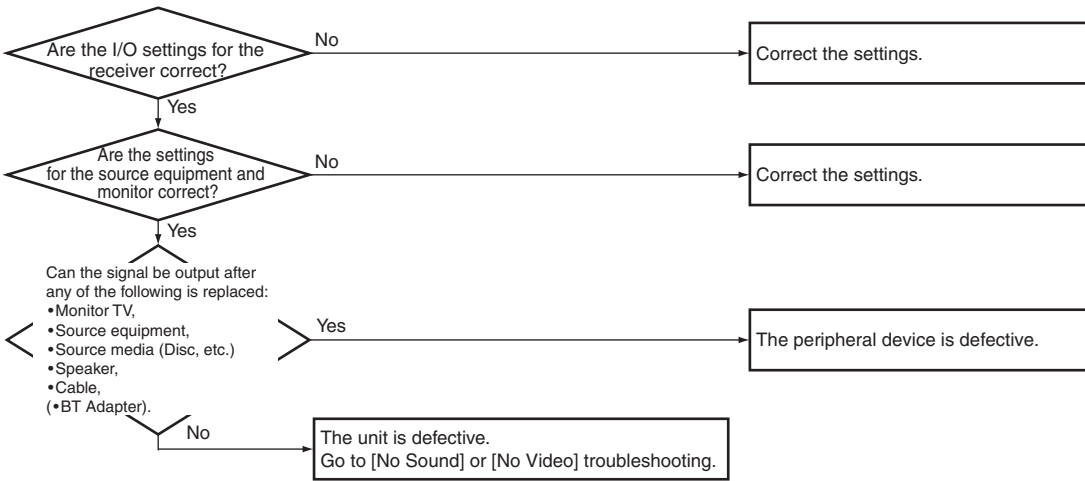

## [2] Solution of Error

### ■ Corrective actions to be taken against each error indication on the protection-operation log

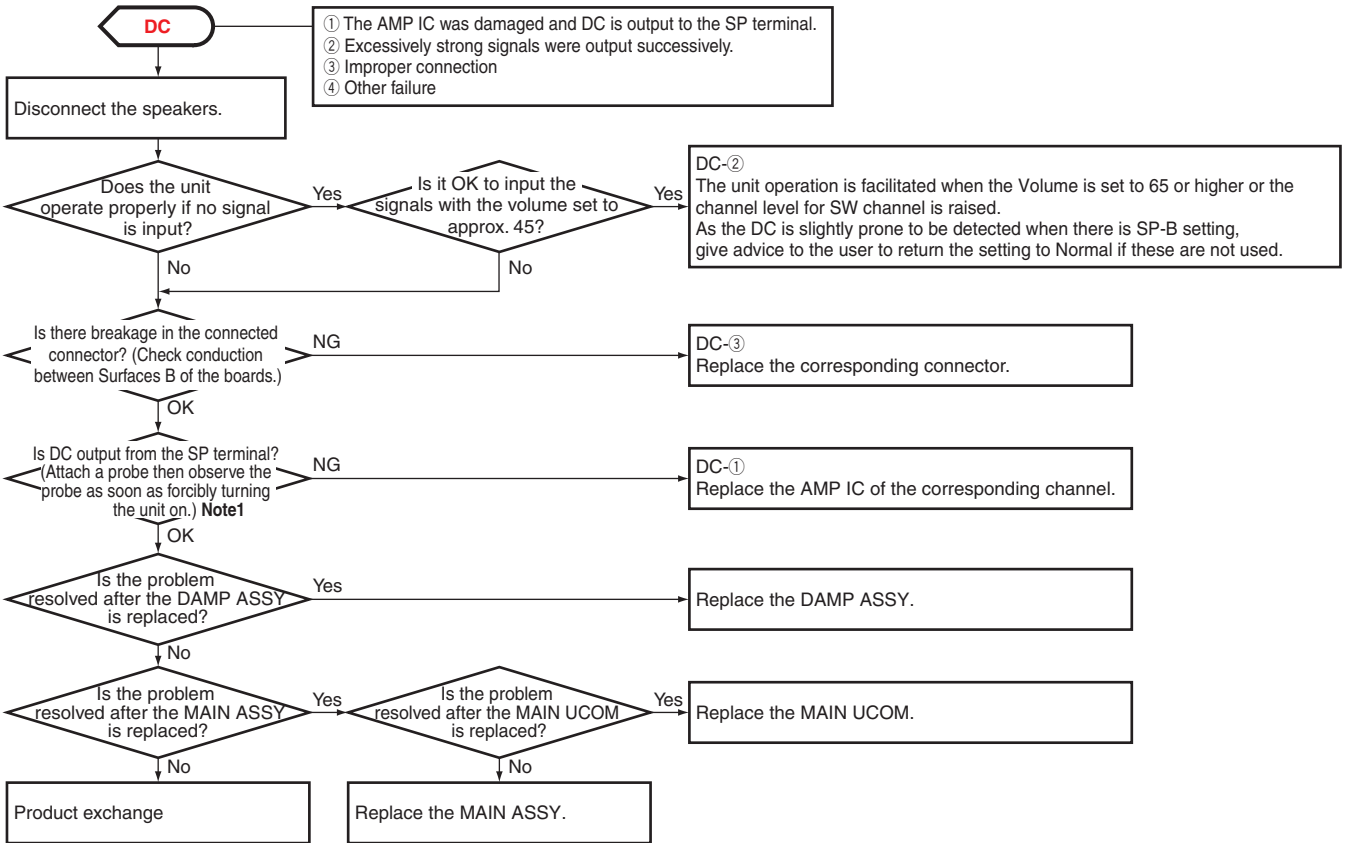

#### Note1 : DC Check Point

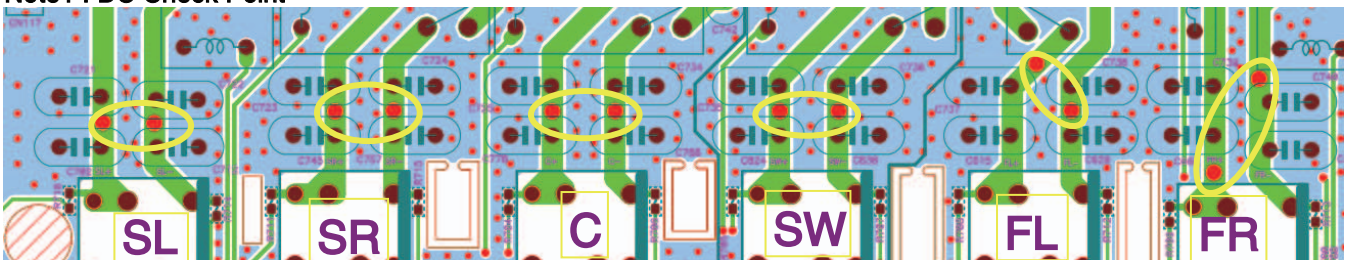

TEMP

① Overheating was detected (increase in the temperature of the IC from 125°C to 155°C).  
 ② Improper connection  
 Note: With the above abnormalities, the unit can be turned on.

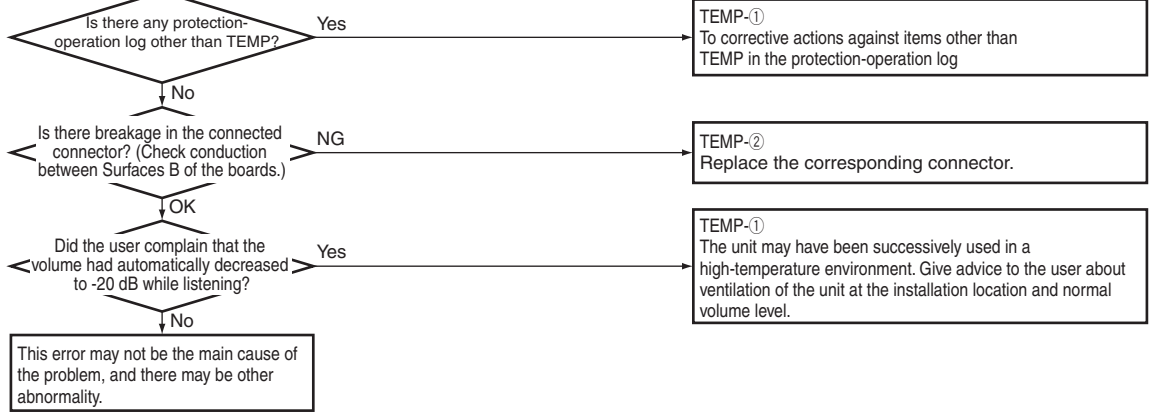

SD

① An abnormally high temperature was detected in AMP IC (temperature of the IC is 155°C or higher).  
 ② Excess current was detected in AMP IC.  
 ③ Improper connection  
 ④ Other failure

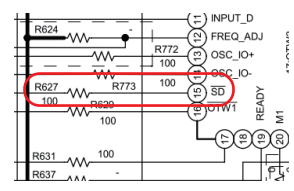
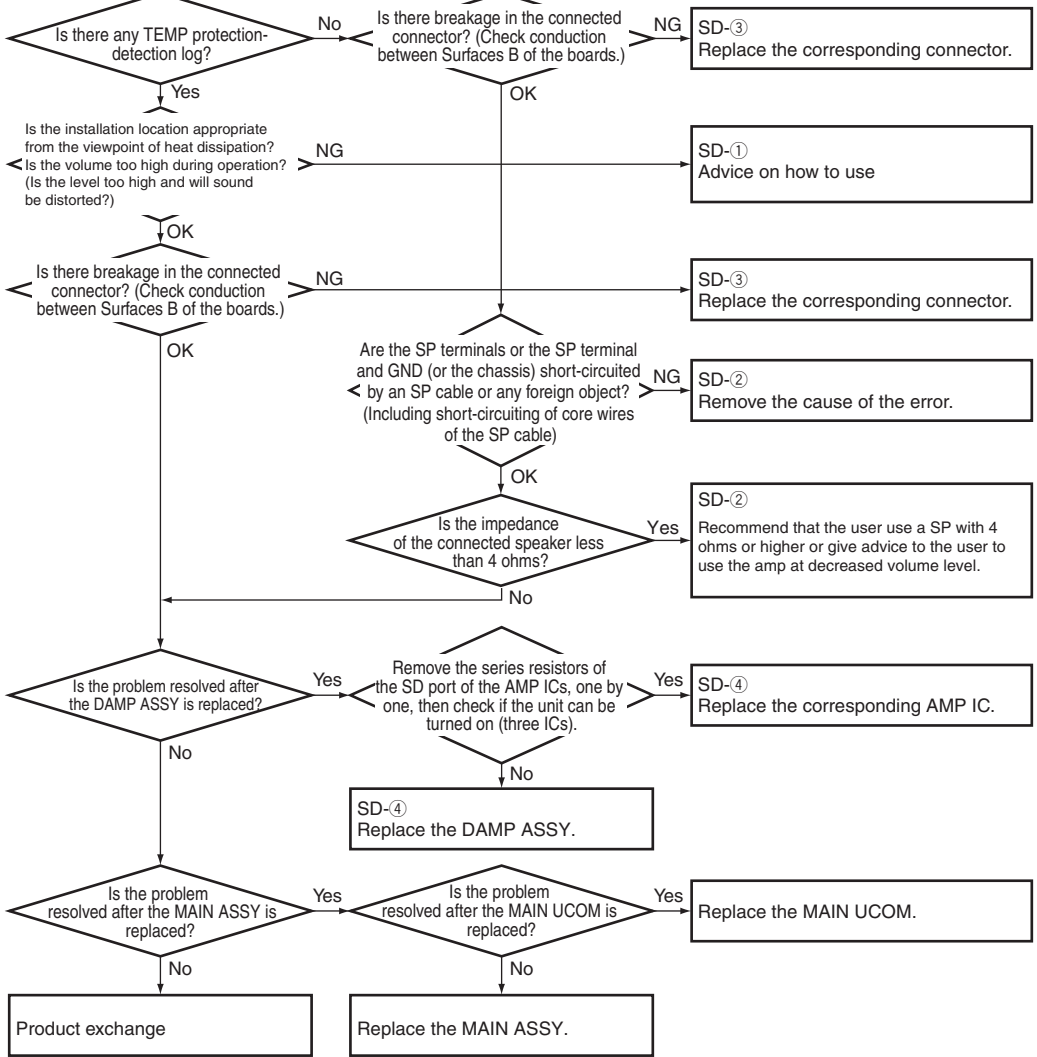

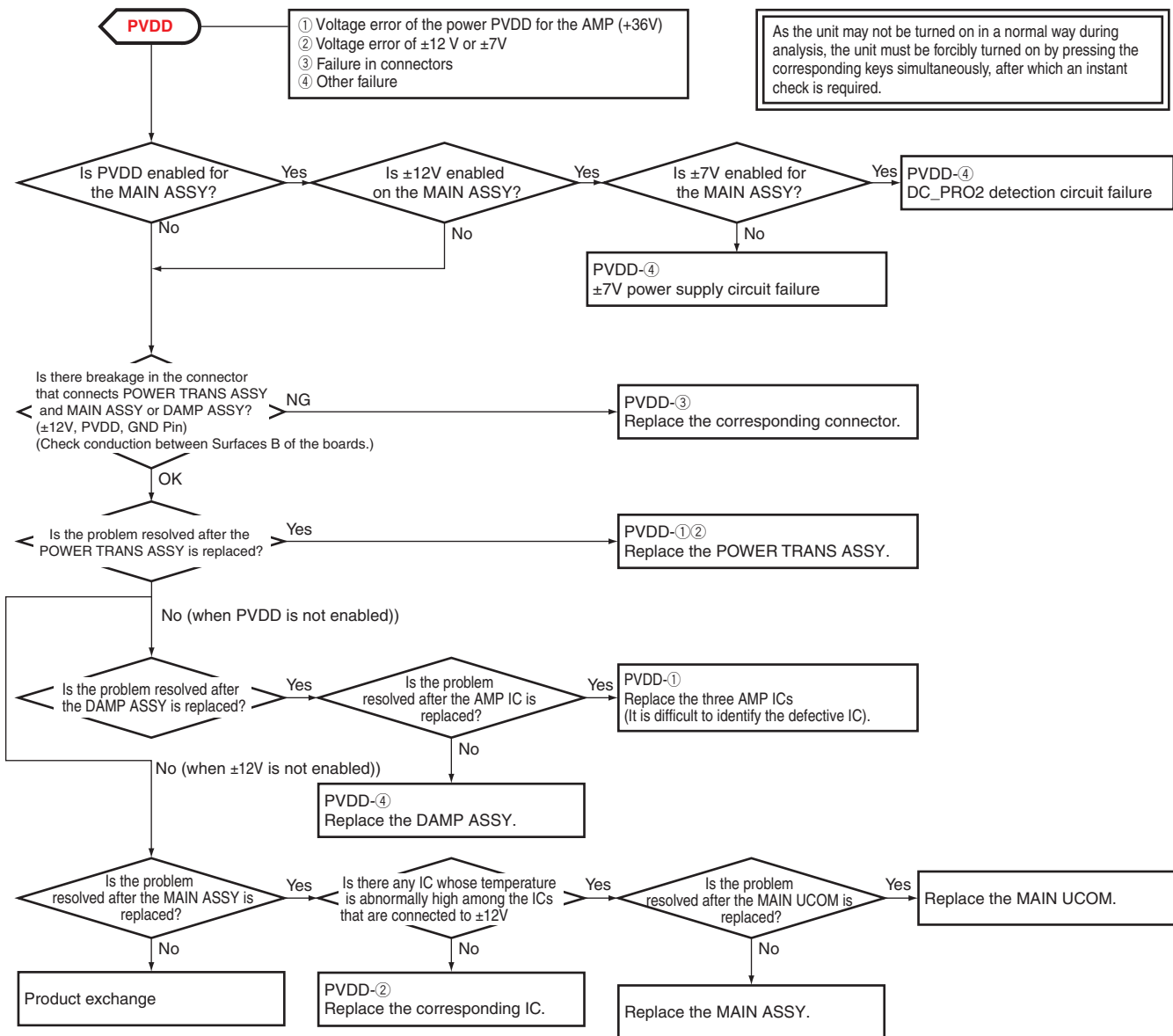

As the unit may not be turned on in a normal way during analysis, the unit must be forcibly turned on by pressing the corresponding keys simultaneously, after which an instant check is required.

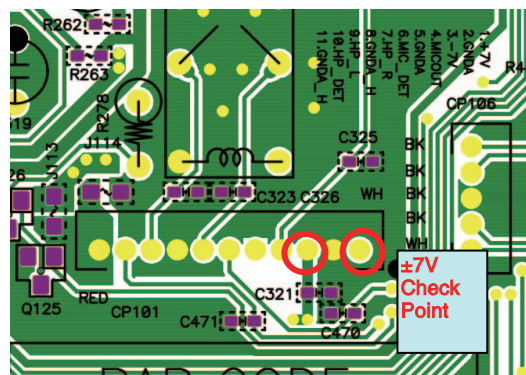
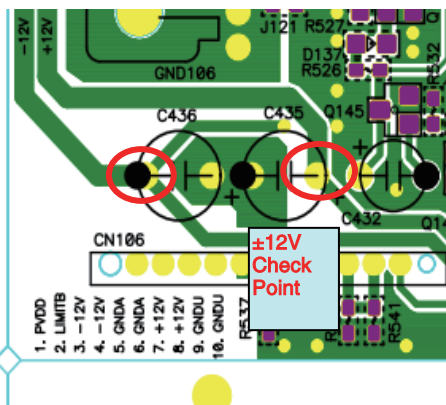

### [3] No Sound

A

No sound (diagnosis from the input side)

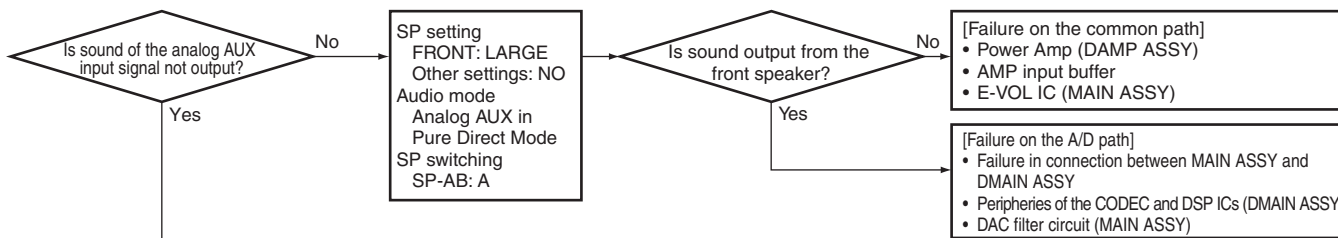

B

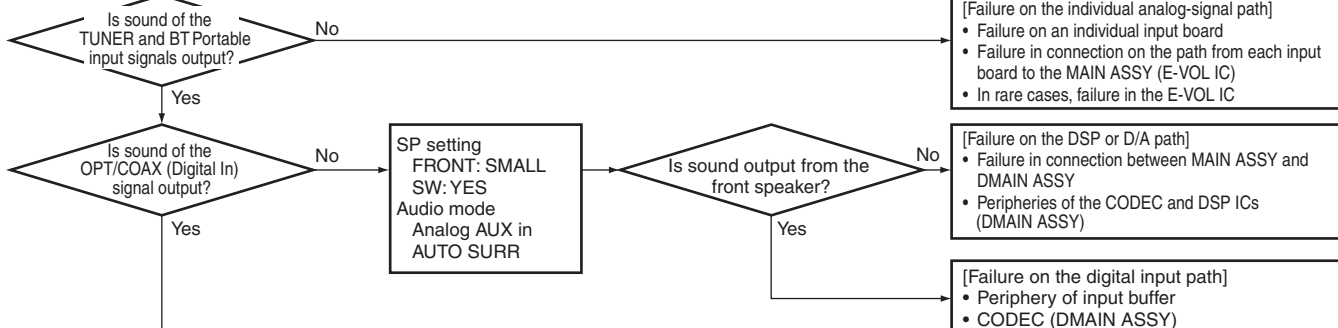

C

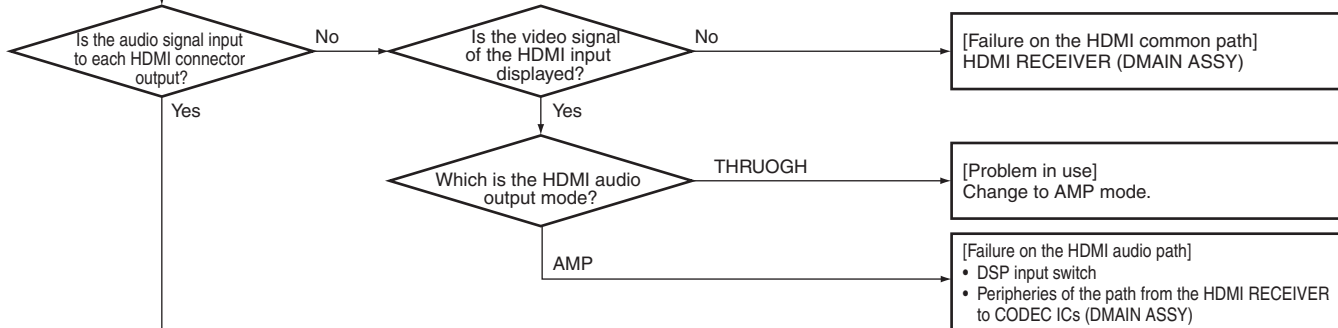

D

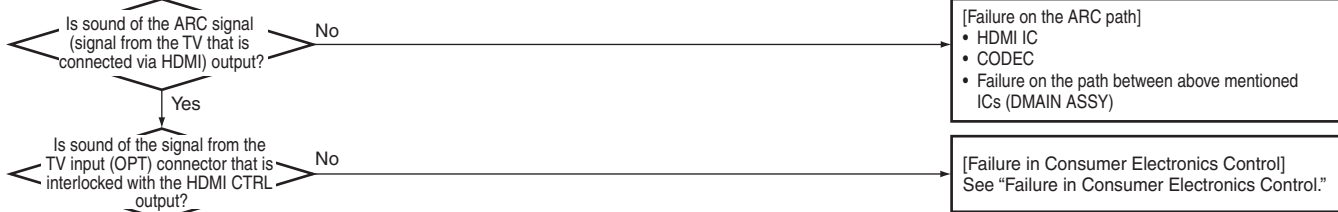

E

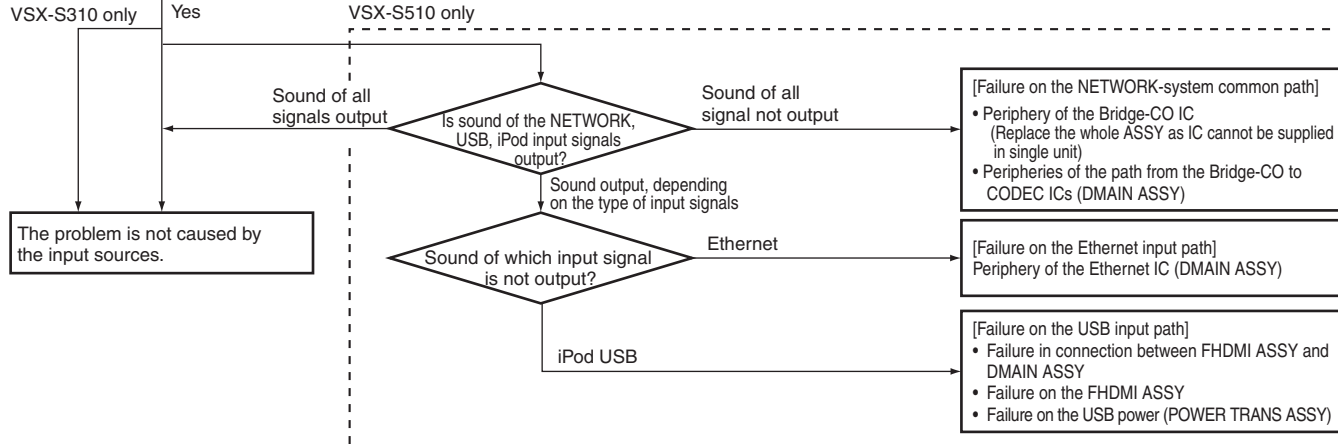

F

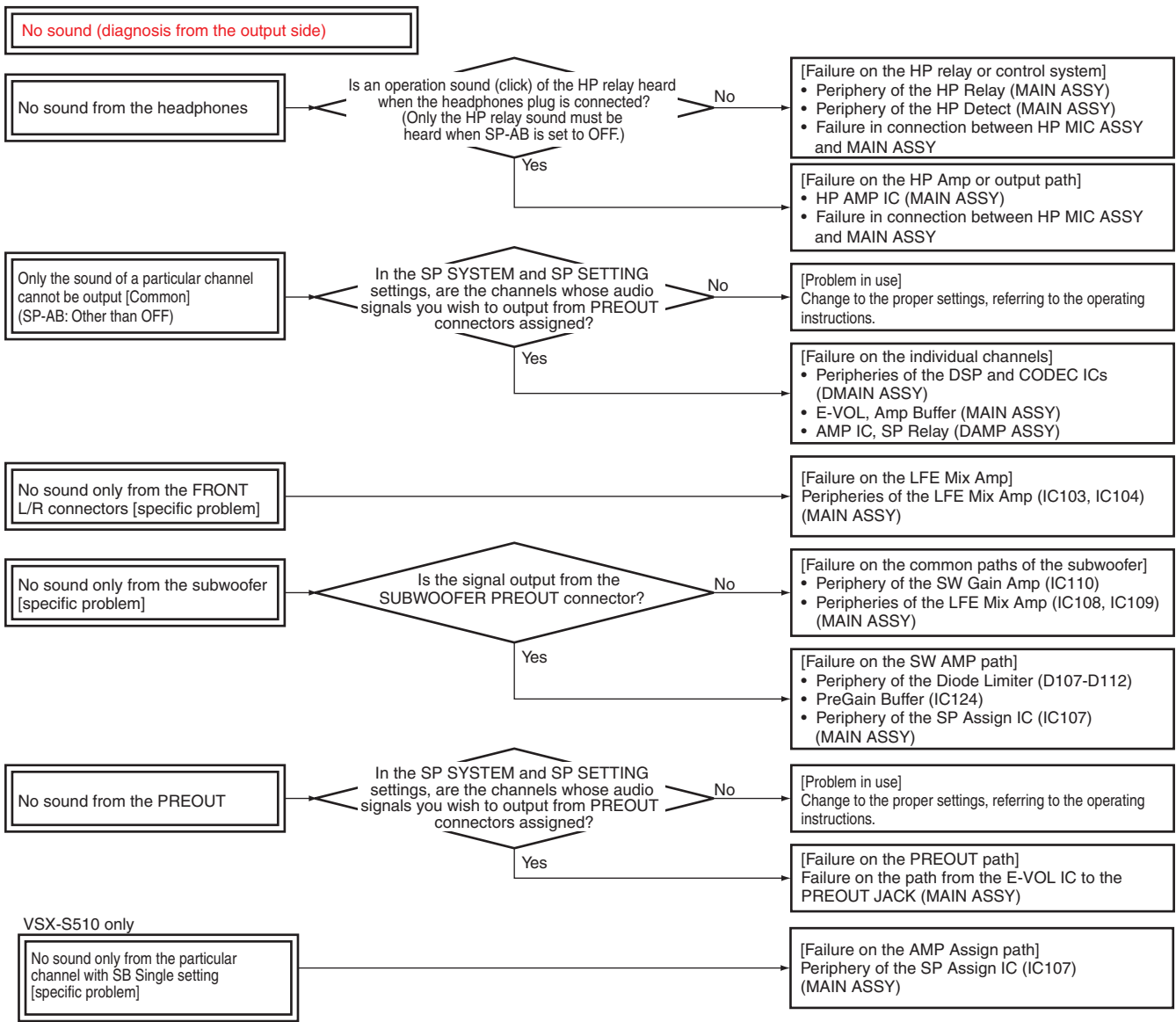

**[4] No Video**

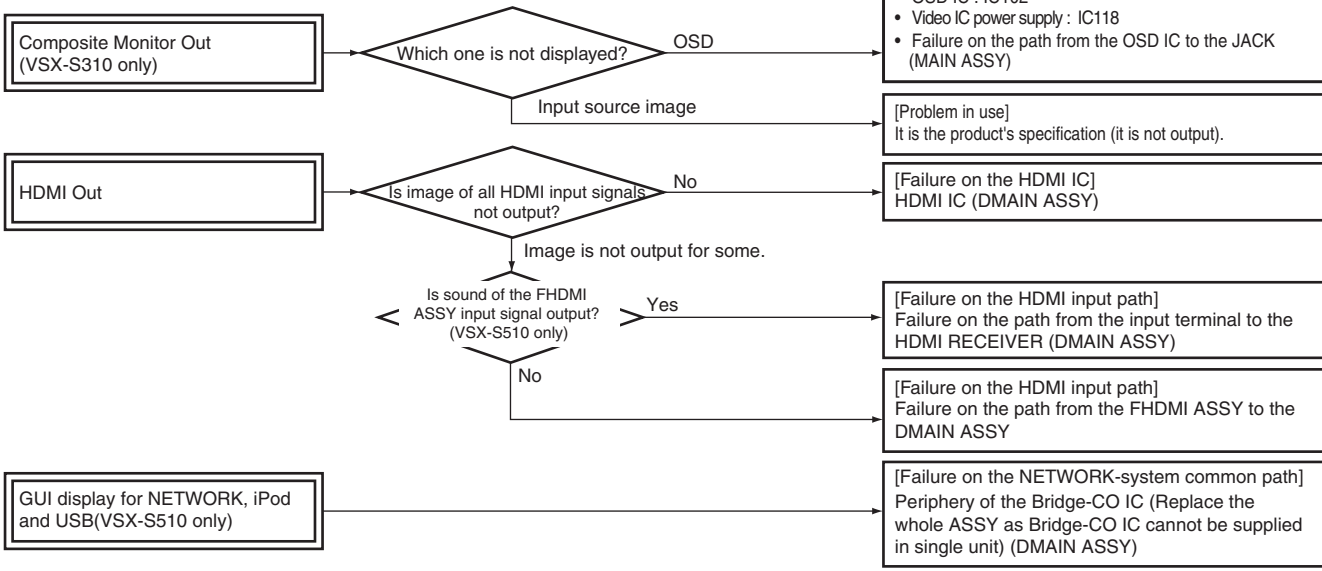

# [5] No Power

A  
B  
C  
D  
E  
F

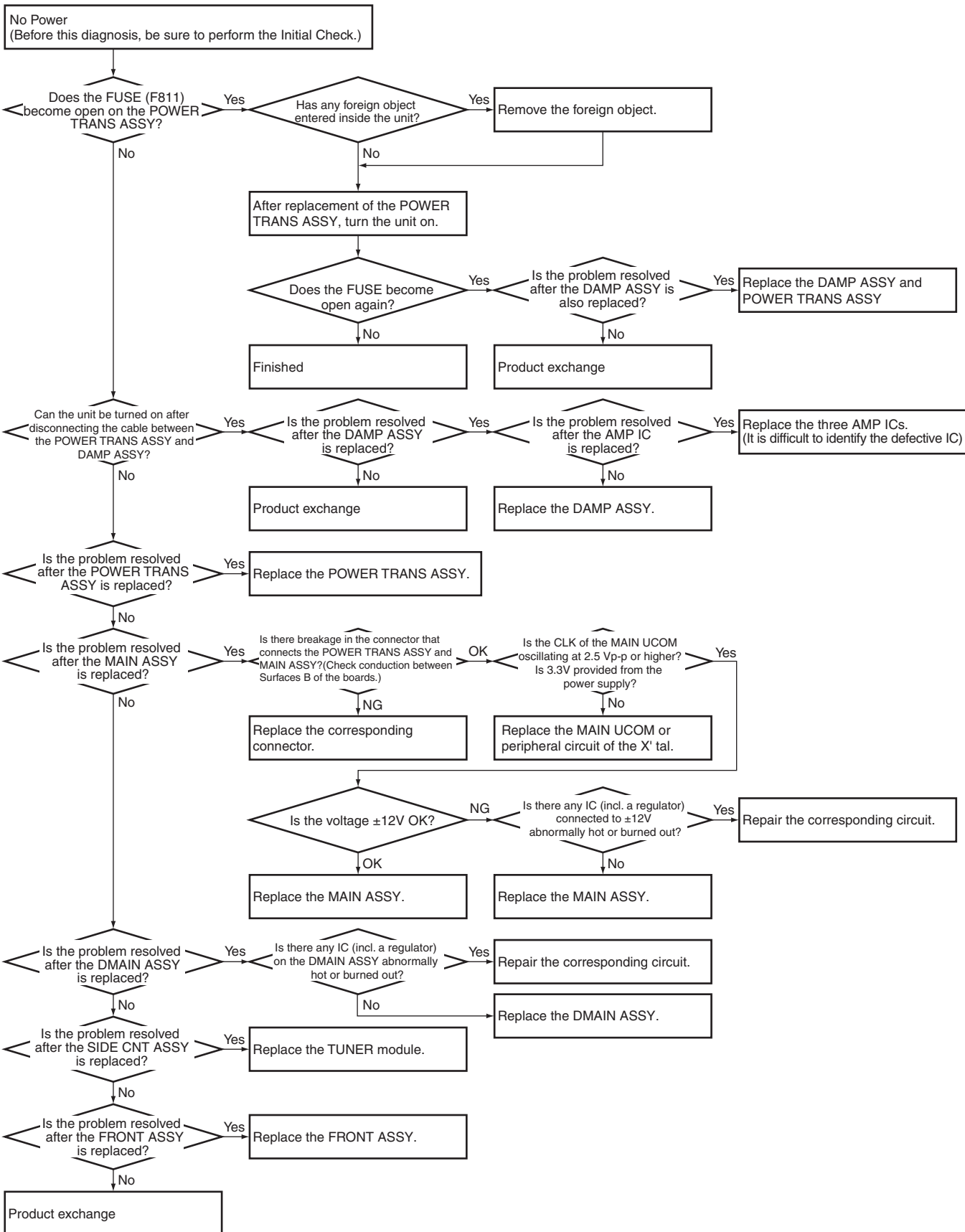



### [6] Others (FL, MCACC etc)

#### FL Display Error

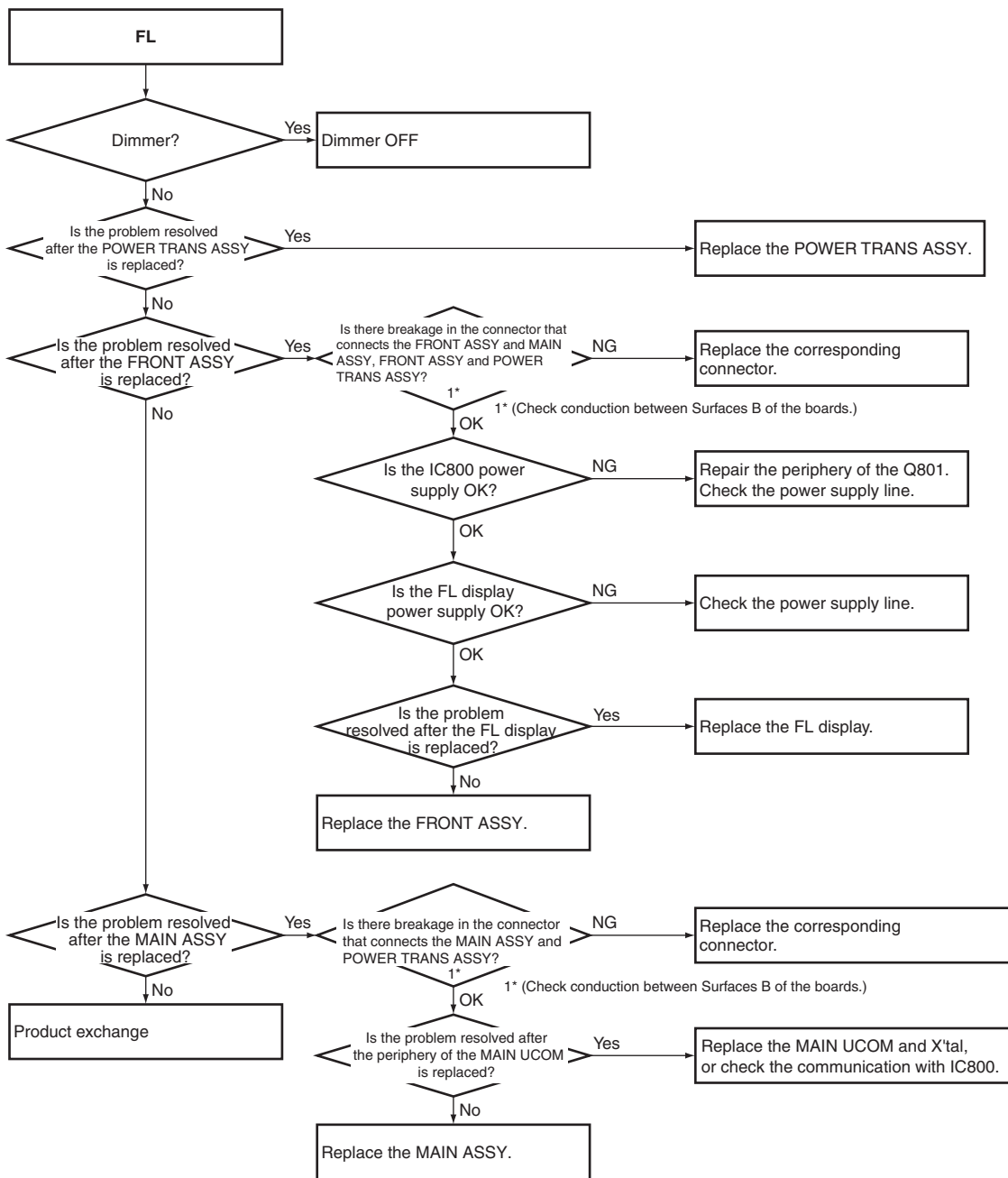

A  
B  
C  
D  
E  
F

### LED Error

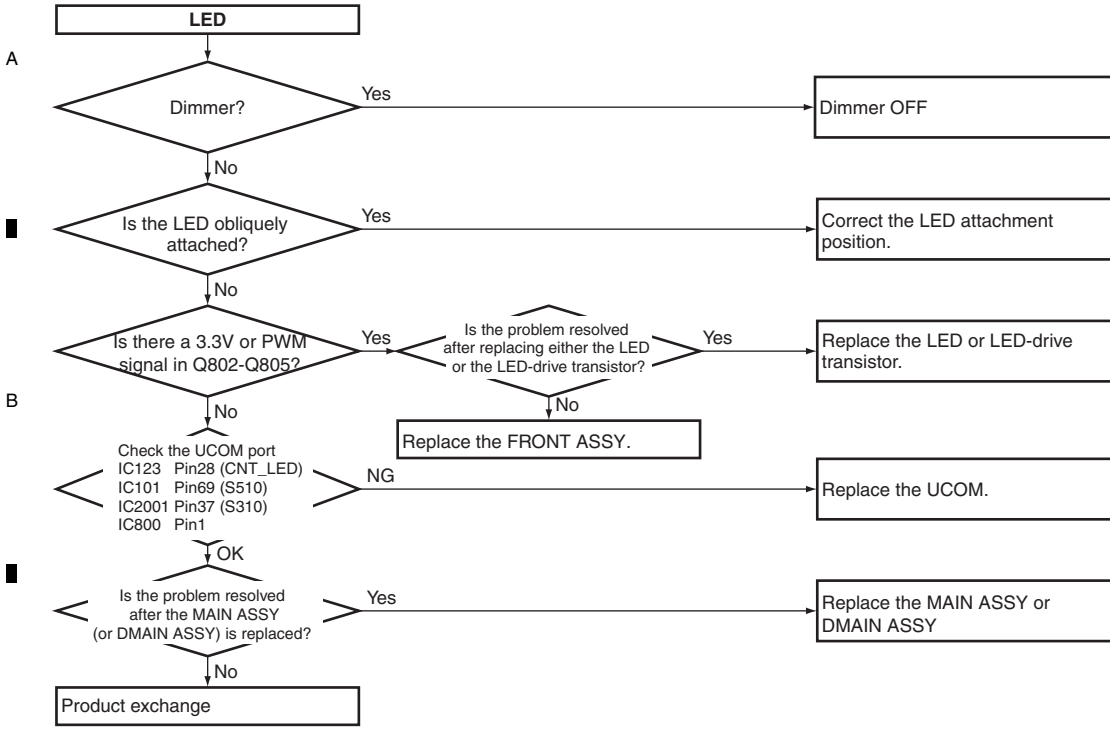

### Multi-channel acoustic calibration function (MCACC) not performed or results in abnormal values

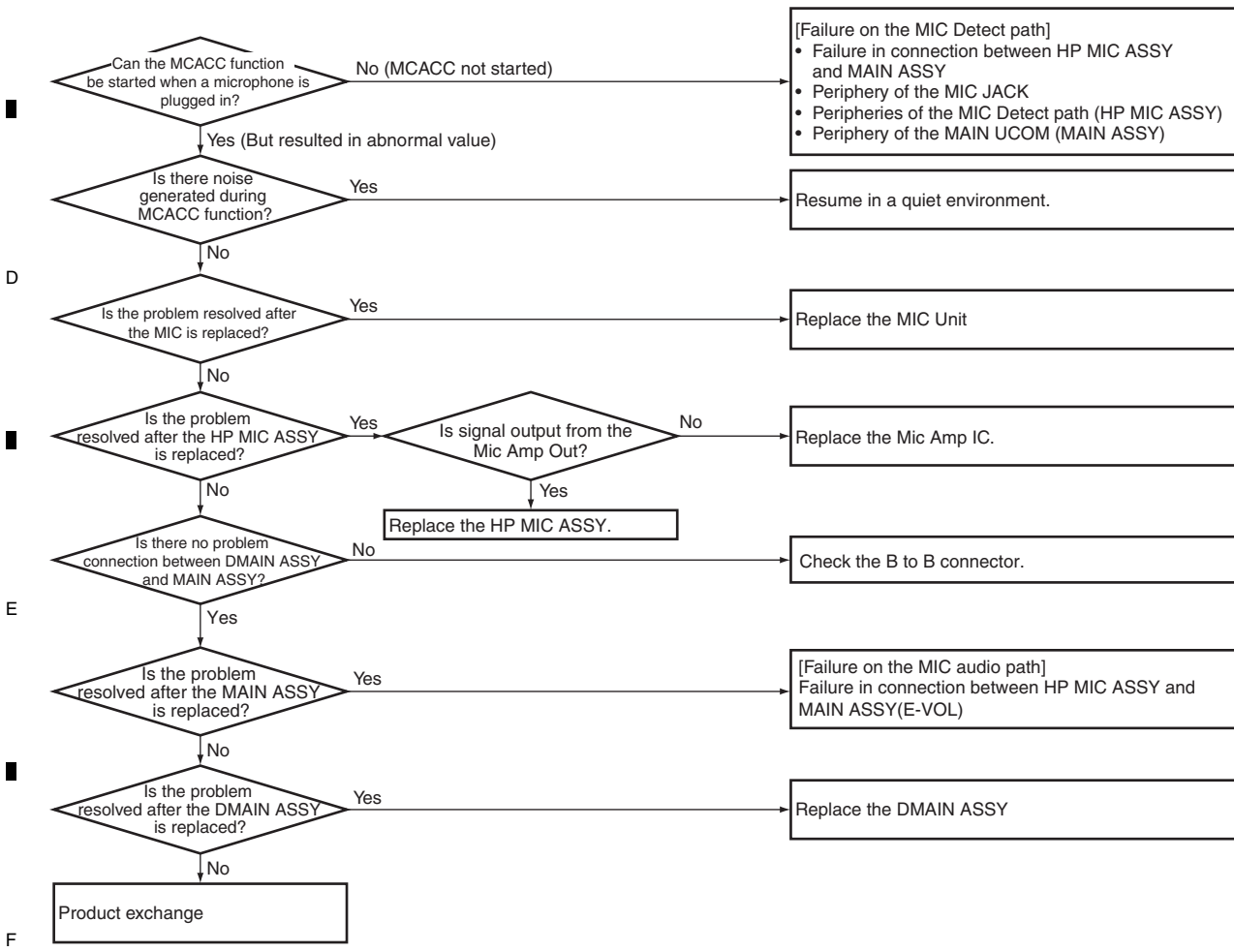

## How to distinguish causes of failure regarding HDMI connection and HDMI control

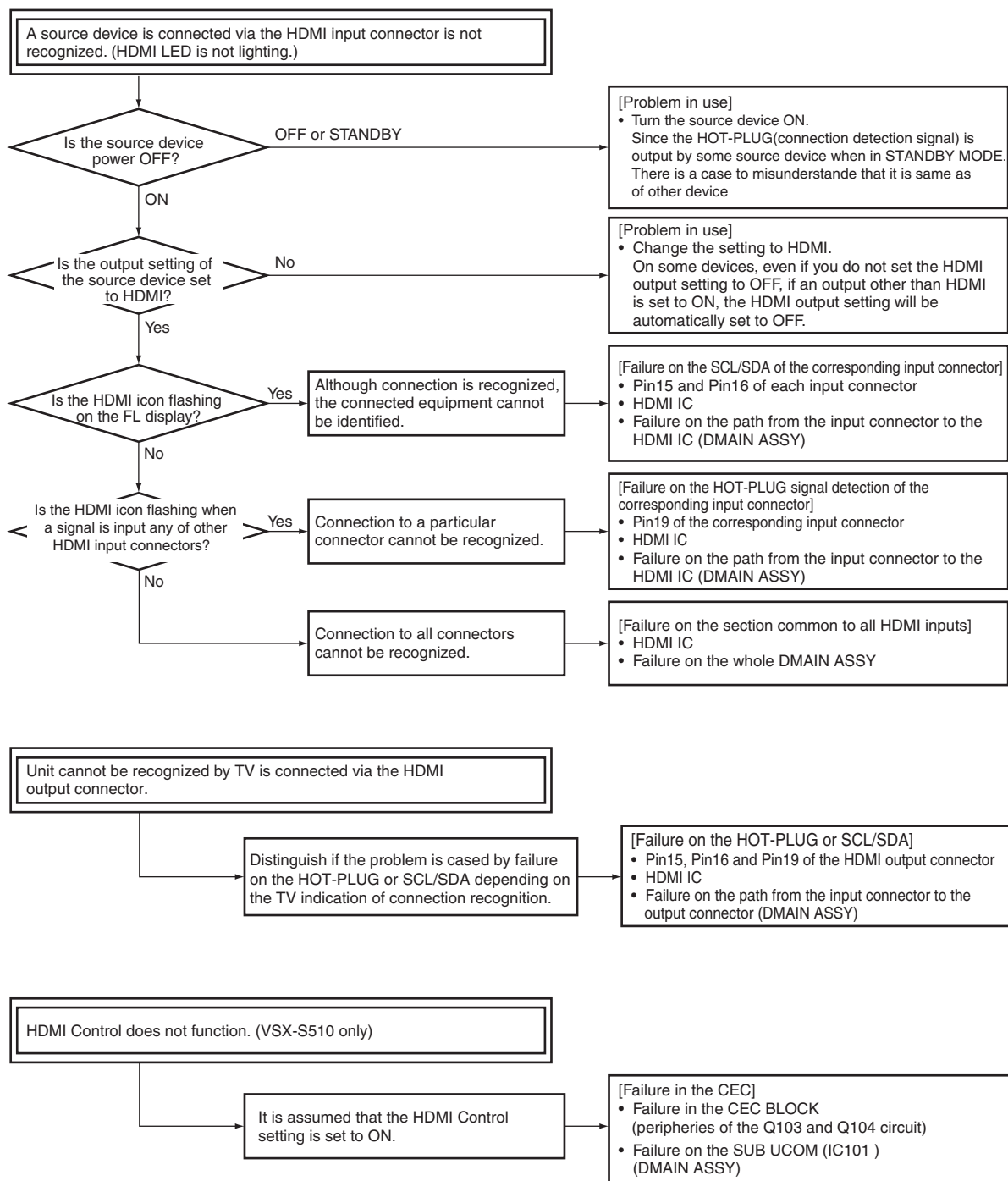

A

B

C

D

E

F

## 5.2 PROTECTION CIRCUIT DESCRIPTION

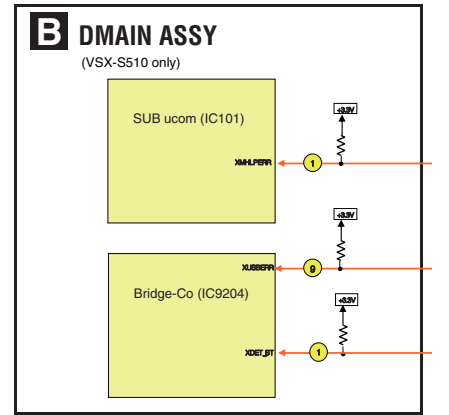
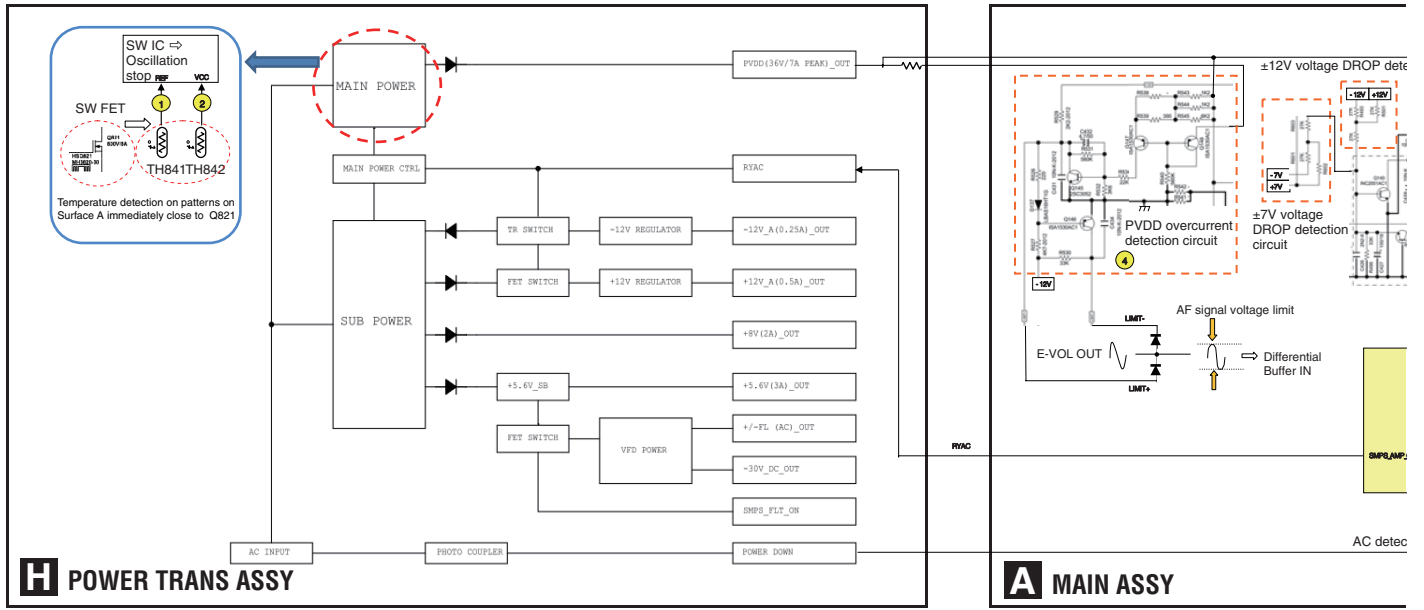

No.	Function	Signal name in the circuit diagram	Destination to be controlled (input destination)	Active	Detection specifications (temperature, level, time, etc.)	
①	Q821 PCB temperature detection	-	VCC terminal of IC821	-	Detection of 115°C at TH841	As vc af
②	Q821 PCB temperature detection	-	VEF terminal of IC821	-	Detection of 115°C at TH842	
③	PVDD voltage error detection	DC_PRO2	IC123 88pin	L	PVDD power voltage: +44 V or higher or 10 V or lower	HI
	±12V voltage drop detection				Difference in the absolute values of electrical potentials between the positive and negative electrodes of ±12 V: 0.6 V or higher	
	±7V voltage drop detection				Difference in the absolute values of electrical potentials between the positive and negative electrodes of ±7 V: 0.6 V or higher	
④	PVDD overcurrent detection	LIMIT+ LIMIT-	D118-D129	±12 V	PVDD current: 4.2 A	Tc pc ci
⑤	AMP overcurrent detection	SD OTW2	IC123 66pin IC123 83pin	L H	Only SD signal is detected.	PC
⑦	DC detection	SD OTW2	IC123 66pin IC123 83pin	L L	Detection of 155°C	Af fo bl is
⑨	FRONT USB overcurrent detection (VSX-S510)	XUSBERR	IC9204 K2pin	L	2.4A	+E
	FRONT USB overcurrent detection (VSX-S310)	USB5V_DET	IC123 78pin	L	1.4A	+E
⑩	MHL overcurrent detection (VSX-S510 only)	XMHLPERR	IC101 12pin	L	1.1A	+E
⑪	BT overcurrent detection (VSX-S510 only)	BTOL	IC9204 R14pin	L	0.78 A	+E

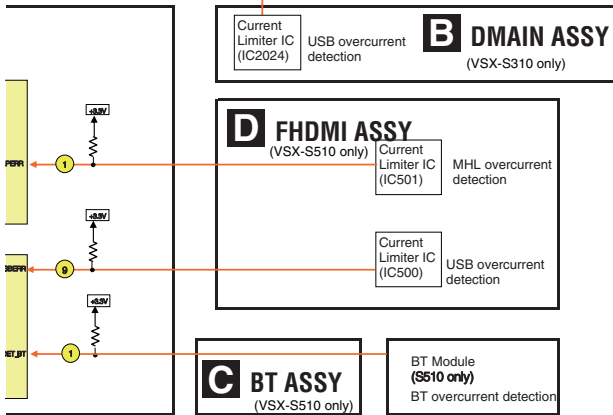
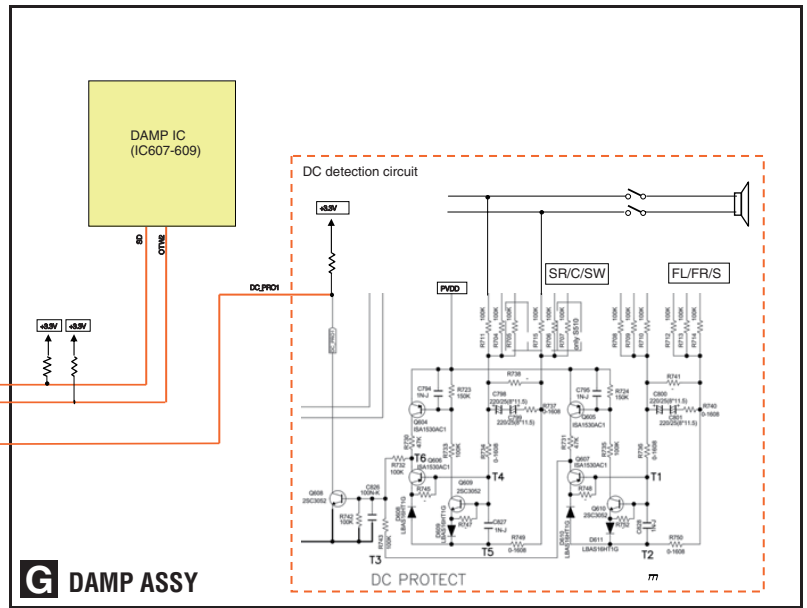
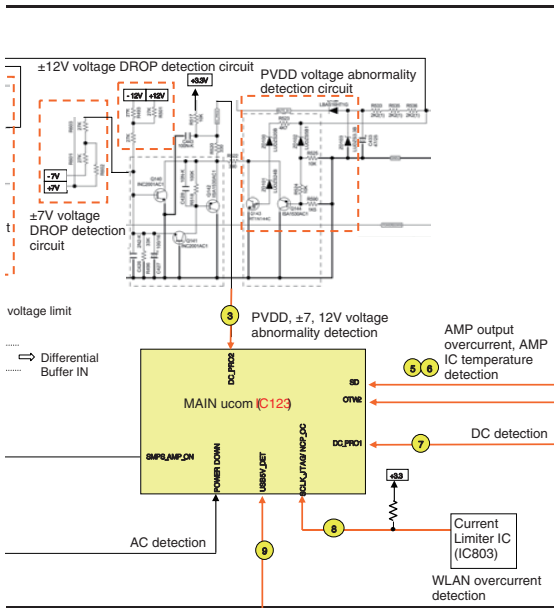

.)	Operation of the unit after detection	Indication on the FL display	Microcomputer error log	Recovery method	Remarks
	As a result of oscillation stop of PVDD power, the PVDD voltage is decreased, DC_PROT2 is activated, after POWER OFF and HDMI indicator blinks.	No particular indication	PVDD	(UNIT) AUTO SURROUND/STREAM DIRECT key is pressed for 5 seconds or longer and then (remote controller) DVD key	In the 1st detection, POWER ON is normally possible after POWER OFF. The restoration procedures on the left is necessary when detection occurs again within 5 seconds after restart.
er	HDMI indicator blinks after POWER OFF.				
als between or higher					
als between r higher					
	To limit the level of the signal to be input to the AMP IC, power of the operational amp on the differential buffer circuit is controlled.	No particular indication	-	-	The speaker output signals may sound distorted somewhat due to auditory senses.
	POWER OFF	"OVERLOAD"	SD	Normal recovery possible	Check on speaker terminal connection again whether it is short-circuiting.
	The volume will be decreased by 3 steps with "TEMP" indication if it is detected again in 2 minutes after initial detection, and the above will be repeated if it is detected in every 2 minutes thereafter. If the volume reaches 45, it is maintained at the level without reducing the volume.	"TEMP"	TEMP	Unit used to lower the volume or improve the equipment installation conditions.	Check equipment installation environment
	After "OVERHEAT" indication, the unit will immediately POWER OFF.	"OVERHEAT"	SD	Normal recovery possible	
an error.	After detection, protection relay is immediately turned OFF, followed by POWER OFF in 3 seconds and HDMI indicator blinks. Protection relay is turned ON again when detection is canceled within 3 seconds.	No particular indication	DC	(UNIT) AUTO SURROUND/STREAM DIRECT key is pressed for 5 seconds or longer, and then (remote controller) DVD key	AMP failure
	+5V power supply for Wifi module is stopped.	"WLAN ERR"	-	POWER OFF/ON	
	+5V power supply for FRONT USB is stopped.	"I/U ERR"	-	POWER OFF/ON	
	+5V power supply for FRONT USB is stopped.	No particular indication	-	POWER OFF/ON	
	+5V power supply for MHL is stopped.	"MHL ERR"	-	POWER OFF/ON	
	+5V power supply for BT Adaptor is stopped.	"ADP ERR"	-	POWER OFF/ON	

# 6. SERVICE MODE

## 6.1 SERVICE MODE

### A [1] Display mode for numbers of protection detections

<b>[Purpose]</b>			
The numbers of detections for various protection processes are displayed.			
<b>[How to enter/exit]</b>			
During Standby mode, simultaneously press and hold the "AUTO SURROUND/STREAM DIRECT" key on the main unit for 5 seconds and press the "NETWORK" key on the remote control simultaneously to enter this mode. The display will return to the normal indication when no key operation is performed for 5 seconds.			
<b>[Basic operations]</b>			
Key Operation	FL Display	Time (sec.)	Description of Indications
(STANDBY state)			
"AUTO SURROUND/ STREAM DIRECT"(main) + "NETWORK" (remote control) (Initial display)	FL lower 	5 (→ normal) *1	Number of DC error detections
"iPod iPhone iPad DIRECT CONTROL" (main/VSX-S510)	FL lower 	5 (→ normal) *1	Number of abnormal PVDD voltage error detection
"iPod iPhone iPad DIRECT CONTROL" (main/VSX-S310)	FL lower 	5 (→ normal) *1	Number of abnormal-temperature error detections
"iPod iPhone iPad DIRECT CONTROL" (main/VSX-S510) "iPod iPhone DIRECT CONTROL" (main/VSX-S310)	FL lower 	5 (→ normal) *1	Number of shut down detections
*1 "5 (→ normal)" denotes that the display will return to the normal indication when no key operation is performed for 5 seconds. *2 Variable range: 0 to 255			

The above-mentioned Display mode is available only when the product operates properly.

If any protection function is activated while the product is in use, the product cannot be turned ON and enter the above Display mode. In such a case, cancel the protection function, referring to "3.4 How to cancel the status after detection of the DC error of 6. SERVICE MODE". If a protection function is activated immediately after the previous protection function is canceled, cancel that protection function again then enter STBY mode immediately. You can then see the error logs, following the above procedures, until a next protection function is activated.

## [2] Reset mode for numbers of protection detections



### [Purpose]

For clearing all the counts of protection detections.  
(This mode resets the counts of protection detections.)

### [How to enter/exit]

During Standby mode, simultaneously press and hold the "AUTO SURROUND/STREAM DIRECT" key on the main unit for 5 seconds and press the "iPod/USB" key on the remote control simultaneously to enter this mode.  
The display will return to the normal indication when no key operation is performed for 5 seconds.

### [Basic operations]

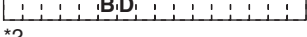
Key Operation	FL Display	Time (sec.)	Description of Indications
(STANDBY state)			
"AUTO SURROUND/ STREAM DIRECT"(main) + "iPod/USB" (remote control)	FL lower 	5 (→ normal) *1	
↓ "iPod iPhone iPad DIRECT CONTROL" (main/VSX-S510) "iPod iPhone DIRECT CONTROL" (main/VSX-S310)	FL lower 	5 (→ normal) *1	
↓ (Normal display)	FL lower  *2	usually	

\*1 "5 (→ normal)" denotes that the display will return to the normal indication when no key operation is performed for 5 seconds.

\*2 Indication when the BD/BDR function is selected

### [Detailed explanations]

- When the procedures for Reset mode for numbers of protection detections are completed, all the counters will be reset to "000."
- Prohibitions:  
The protection detection counts cannot be cleared (reset to 000) with the MEMORY CLEAR process.  
They can only be cleared when the procedures of Reset mode are completed.



### [3] The unit's operation when a error is detected

#### [Purpose]

- Main unit's operations when a DC, voltage, or TEMP error is detected are described in this section.
- Because no key input is accepted after a DC or voltage error is generated, follow the instructions described in "3.4 How to cancel the status after detection of the DC error of 6. SERVICE MODE".

#### [Basic operations]

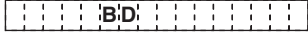
##### 3.1 DC (AMP is abnormality) error detection

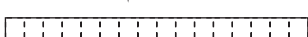
Key Operation	FL Display	Time (sec.)	Description of Indications
(Normal display)	FL lower 	usually	Normal display
↓			
(DC detection)	FL lower 		
↓ (Auto)			
(Protection Relay OFF)	FL lower 		
↓ (Immediately)			
(RECEIVER POWER OFF)	FL lower 		

**Note:** If the unit returns to a normal status within 3 sec after a DC error was detected, it can be turned back on again after the shutdown caused by the detection.

If DC is successively detected for 3 sec or more, the unit cannot be turned on after the shutdown caused by such detection. For turning the unit on, follow the instructions described in "3.4 How to cancel the status after detection of the DC error of 6. SERVICE MODE".

##### 3.2 Detection of Voltage Error

Detection of a PVDD voltage error (PVDD power voltage: +44 V or higher, or +10 V or less)  
 $\pm 12V$  or  $\pm 7V$  voltage drop detection (Difference in the absolute values of electrical potentials between the positive and negative electrodes of  $\pm 12V$  or  $\pm 7V$ : 0.6 V or higher)

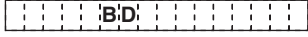
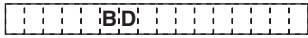
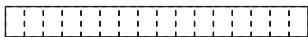
Key Operation	FL Display	Time (sec.)	Description of Indications
(Normal display)	FL lower 	usually	Normal display
↓			
(Voltage abnormality detection)	FL lower 		
↓ (Auto)			
(RECEIVER POWER OFF)	FL lower 		

**Note:**

The unit cannot be turned on after the shutdown caused by such detection.

For turning the unit on, follow the instructions described in "3.4 How to cancel the status after detection of the DC error of 6. SERVICE MODE".



### 3.3 TEMP (AMP overheating) error detection

For detection of a TEMP error, the unit monitors both the OTW2 (125°C) and SD (150°C) signals. If a TEMP error is detected, the processes shown below will be performed. The processes shown below are rough operational specifications and are not the actual commands from the mounted components.

After a TEMP error is detected, the count of protection activation detections will be updated.

#### OTW2 Counter: TEMP

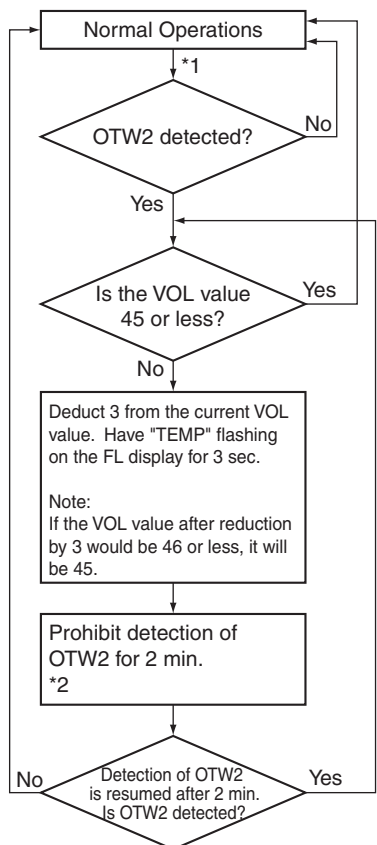

\*1: The detection interval must be 1 sec or less.  
 \*2: If SD is detected while OTW2 detection is prohibited for 2 min, the SD function will be activated.

#### SD Counter: SD

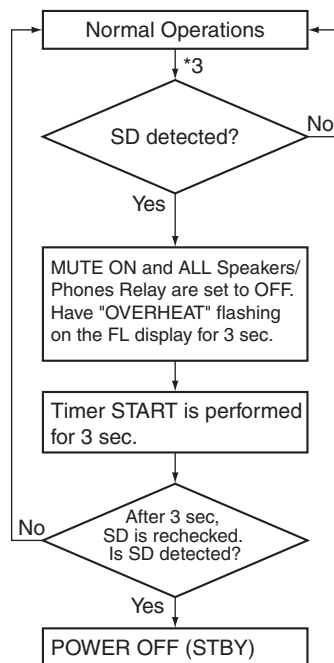

\*3: The detection interval must be 1 sec or less.

### 3.4 How to cancel the status after detection of the DC error

#### [Detailed explanations]

During Standby mode, simultaneously press and hold the "AUTO SURROUND/STREAM DIRECT" key on the main unit for 5 seconds and press the "DVD" key on the remote control simultaneously will cancel Key Input Inhibition mode after a DC error detection and turn the unit ON.

Key Operation	FL Display	Time (sec.)	Description of Indications
(STANDBY state)			
"AUTO SURROUND/STREAM DIRECT"(main) + "DVD" (remote control) ↓		usually	Normal display
(Normal display)			

# 7. DISASSEMBLY

## Note :

- (1) Even if the unit shown in the photos and illustrations in this manual may differ from your product, the procedures described here are common.
- (2) For performing the diagnosis shown below, the following jigs for service is required.
  - 11P board to board extension jig cable (GGD1846)
  - 33P board to board extension jig cable (GGD1847)
  - 19P board to board extension jig cable (GGD1849)
  - 5P PH Housing ASSY extension jig cable (GGD1594)
  - 11P bridge connector extension jig cable (GGD1758)
- (3) Discharge the electricity of the unit, before the diagnosis. (Refer to the “Discharge” )

## Discharge

Unplug the Power Cord.

Remove the Cabinet S510.

(Refer to the “ [1] Cabinet S510” of “Disassembly”.)

### [1] PVDD (CN601)

- (1) Connect the CN601-1, 2pin of the DAMP ASSY to CN601-3, 4, 5pin, with a resistor of 47 to 100Ω , 2W or more.
  - \* If the DAMP ASSY is installed in the Chassis, the connection of CN601-1, 2pin to the Chassis is also acceptable.
  - \* Discharge time: 5 to 10 sec. (according to the resistor.)
- (2) Check by a tester if the voltage of each terminal is 1V or less.
  - \* Connect the tester's GND terminal to the Chassis.
  - \* If the voltage is higher than 1V, repeat the step (1).

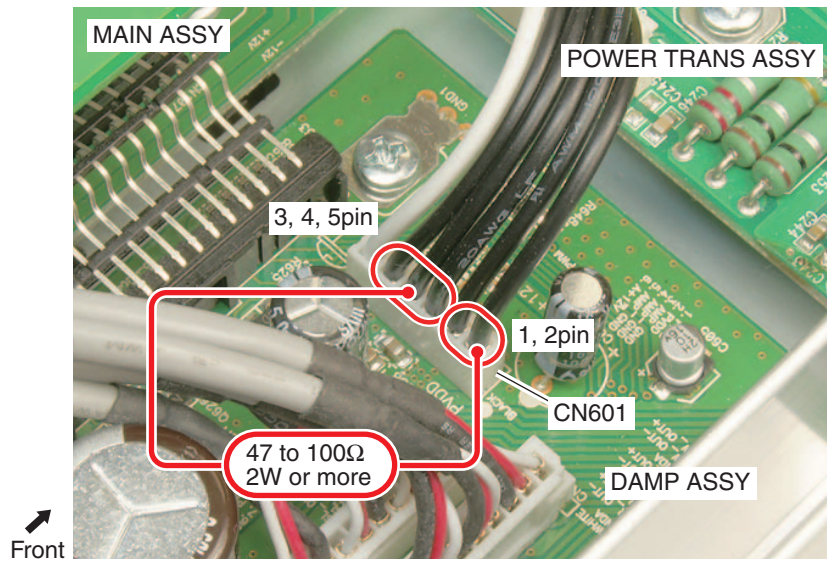

### [2] FL-30V (C424)

- (1) Connect the C424 each terminal of the POWER TRANS ASSY, with a resistor of 47 to 100Ω , 2W or more.
  - \* If the POWER TRANS ASSY is installed in the Chassis, the connection of -30V terminal to the Chassis is also acceptable.
  - \* Discharge time: 5 to 10 sec. (according to the resistor.)
- (2) Check by a tester if the voltage of each terminal is 1V or less.
  - \* Connect the tester's GND terminal to the Chassis.
  - \* If the voltage is higher than 1V, repeat the step (1).

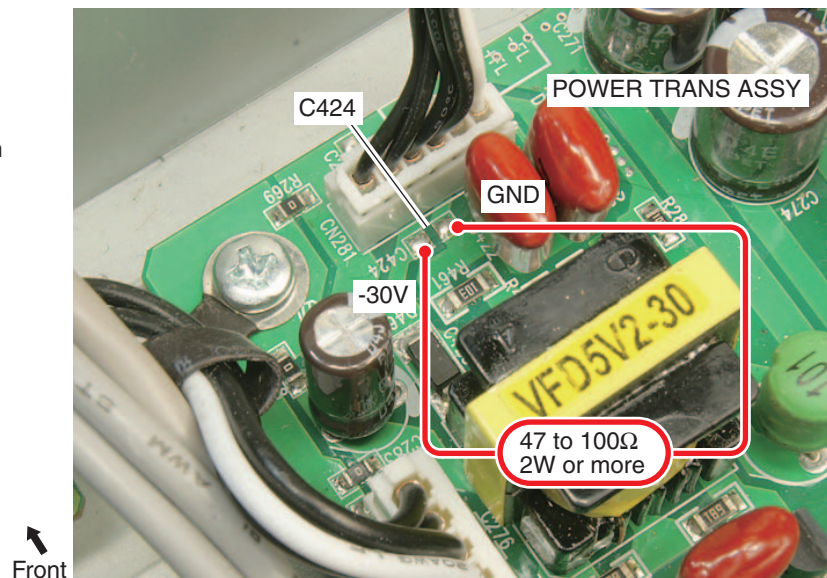

### [3] FHDMI+8V (CN244: VSX-S510 only)

- (1) Connect the CN244-1, 2pin of the POWER TRANS ASSY to CN244-3, 4pin, with a resistor of 47 to 100Ω , 2W or more.
  - \* If the POWER TRANS ASSY is installed in the Chassis, the connection of CN245-3, 4pin to the Chassis is also acceptable.
  - \* Discharge time: 5 to 10 sec. (according to the resistor.)
- (2) Check by a tester if the voltage of each terminal is 1V or less.
  - \* Connect the tester's GND terminal to the Chassis.
  - \* If the voltage is higher than 1V, repeat the step (1).

Front

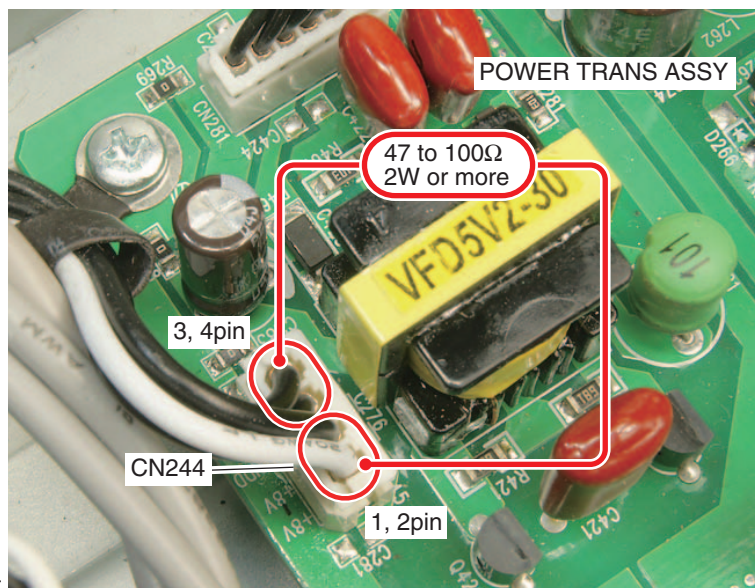

### [4] D-MAIN+5.6V (C275)

- (1) Connect the C275 each terminal of the POWER TRANS ASSY, with a resistor of 47 to 100Ω , 2W or more.
  - \* If the POWER TRANS ASSY is installed in the Chassis, the connection of CN243-1, 2, 3pin to the Chassis is also acceptable.
  - \* Discharge time: 5 to 10 sec. (according to the resistor.)
- (2) Check by a tester if the voltage of each terminal is 1V or less.
  - \* Connect the tester's GND terminal to the Chassis.
  - \* If the voltage is higher than 1V, repeat the step (1).

Front

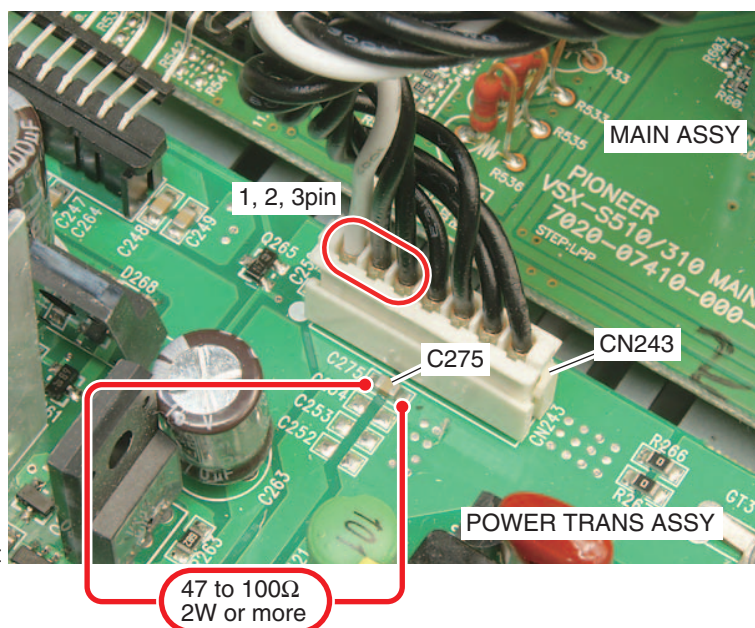

## Disassembly

### [1] Cabinet S510

- (1) Remove the three screws.  
 (VSX-S510-K : BBT30P100FTB)  
 (VSX-S310-K : BBT30P100FTB)  
 (VSX-S510-S : BBZ30P080FTC)  
 (VSX-S310-S : BBZ30P080FTC)
- (2) Remove the four screws.  
 (VSX-S510-K : B020230083B10-IL)  
 (VSX-S310-K : B020230083B10-IL)  
 (VSX-S510-S : BBZ30P080FTC)  
 (VSX-S310-S : BBZ30P080FTC)
- (3) Remove the Cabinet S510 while lifting the rear side of Cabinet S510.

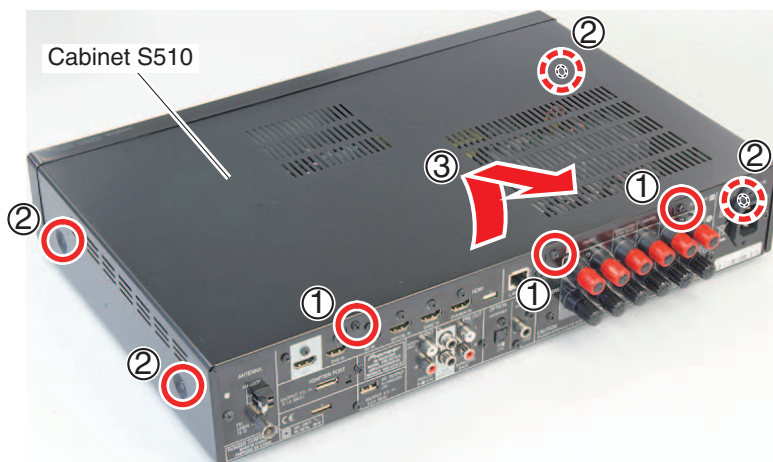

## [2] Front Section

### [2-1] Front Section

A Remove the Cabinet S510.  
(Refer to the "[1] Cabinet S510")

- (1) Remove the five screws.  
 (VSX-S510-K : B020230083B10-IL)  
 (VSX-S310-K : BBZ30P080FTC)  
 (VSX-S510-S : BBZ30P080FTC)  
 (VSX-S310-S : )

- B (2) Release the cable from the acetate tape (15x30mm).  
 (3) Release the cables from the three PCB binders.  
 (4) VSX-S510 only :  
 Release the cables from the two Clamp MTGs.  
 (5) VSX-S510 :  
 Disconnect the eight connectors.  
 VSX-S310 :  
 Disconnect the four connectors.



• Bottom view

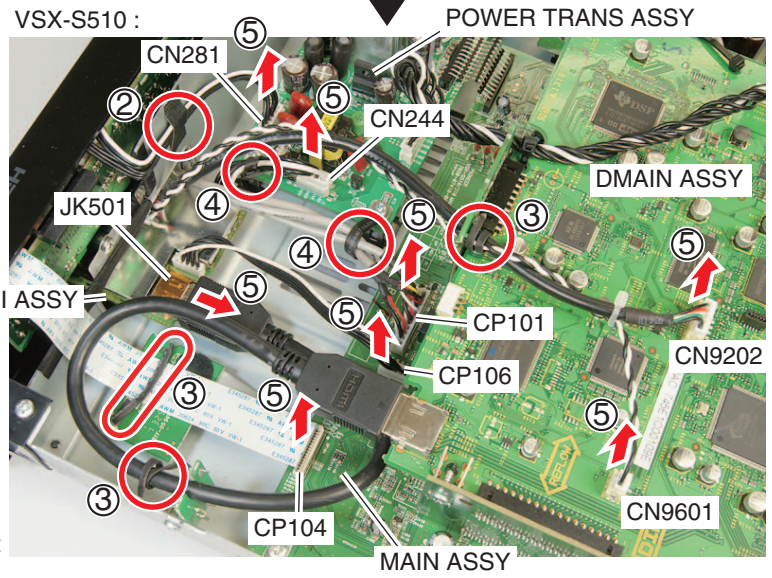

Front

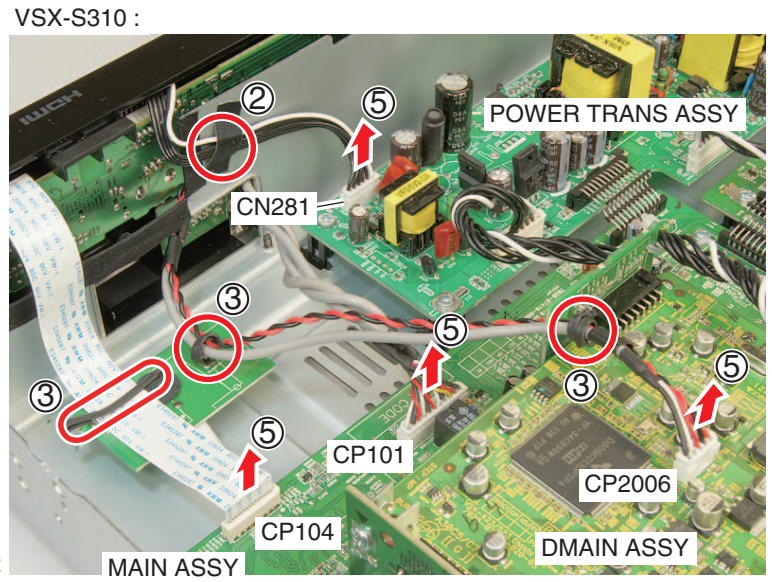

Front

- E (6) Remove the two screws.  
 (BBZ30P080FTC)  
 (7) Unhook the two hooks of the Front Panel and then remove the Front Section.

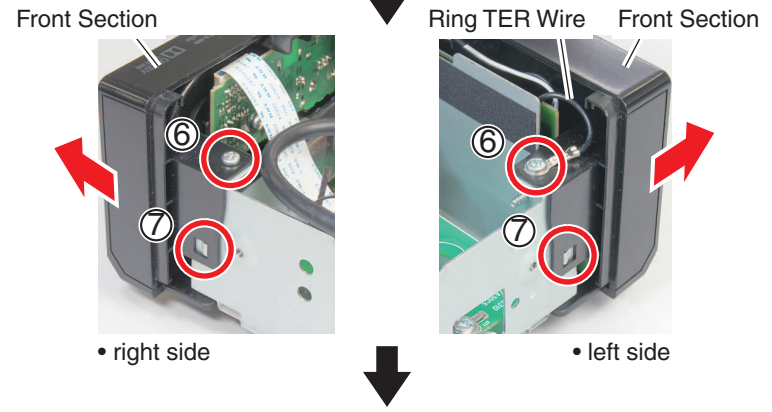

• right side

• left side

[2-2] Diagnosis (VSX-S510)

- (1) Remove the two screws (BBZ30P080FTC), and then remove the FHDMI ASSY (with other parts).

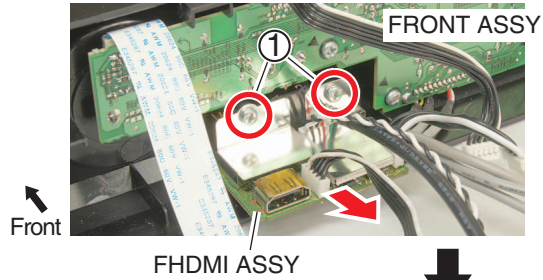

- (2) Connect the five connectors.
- (3) Insert the insulation sheet.

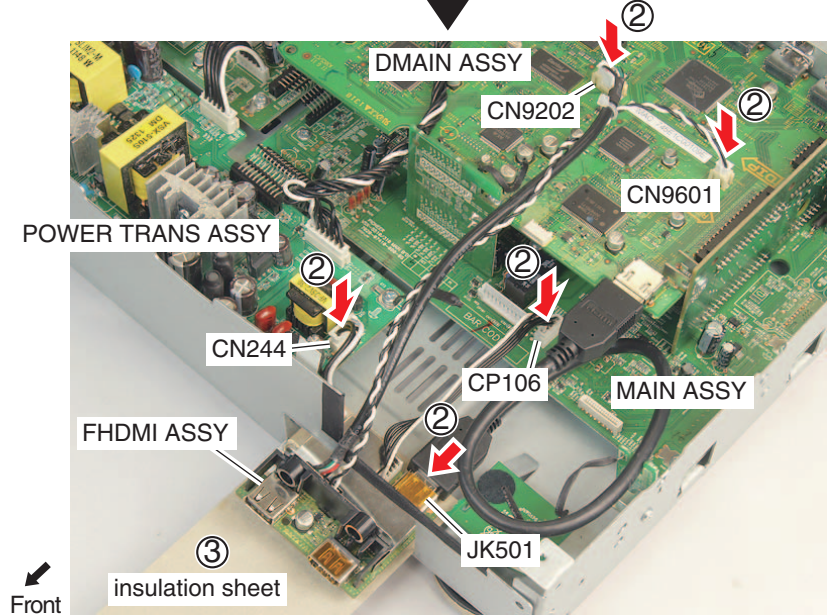

- (4) Set the insulation sheet.
- (5) Arrange the unit as shown in the photo.

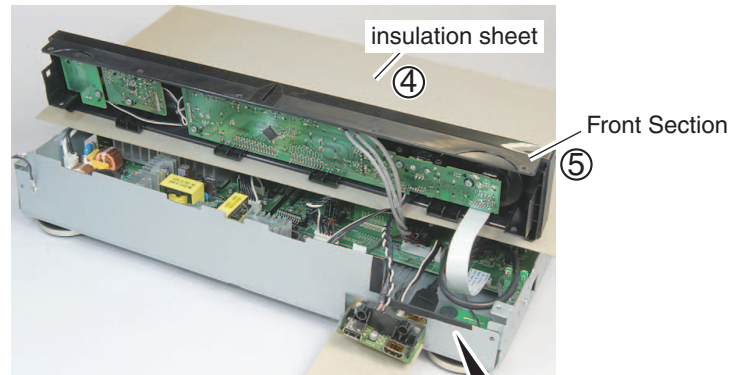

- (6) Connect the three connectors.

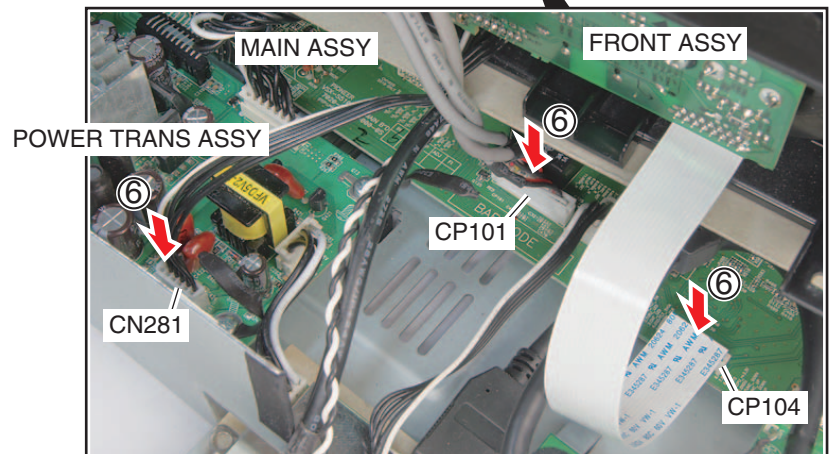

**[2-3] Diagnosis (VSX-S310)**

- (1) Set the insulation sheet.
- (2) Arrange the unit as shown in the photo.
- (3) Connect the four connectors.

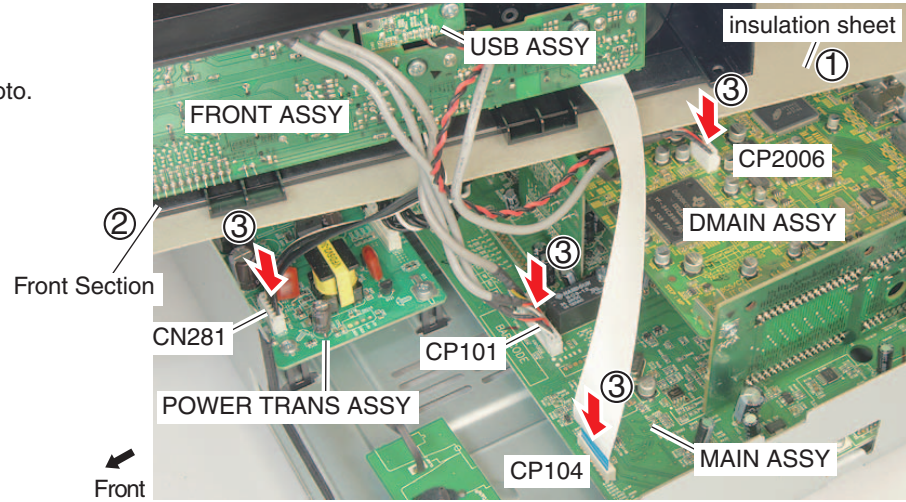

**[3] DMAIN ASSY**

**[3-1] DMAIN ASSY**

Remove the Cabinet S510.  
(Refer to the "[1] Cabinet S510")

**VSX-S510 :**

- (1) Cut the Clamp (Binder).
- (2) Release the cables from the two PCB binders.
- (3) Remove the two screws. (BBZ30P080FTC)
- (4) Remove the two screws. (BBT30P100FTB)
- (5) Disconnect the five connectors.
- (6) Remove the six screws. (BSZ30P040FTB)
- (7) Remove the DMAIN ASSY.

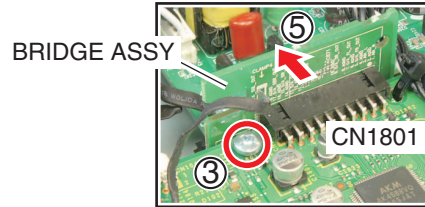

**VSX-S510 :**

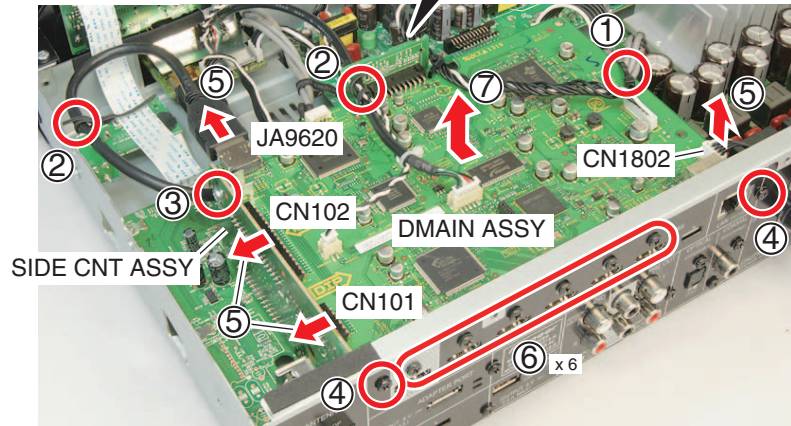

**VSX-S310 :**

- (1) Remove the screws. (BBZ30P080FTC)
- (2) Remove the screws. (BBT30P100FTB)
- (3) Disconnect the three connectors.
- (4) Remove the five screws. (BSZ30P040FTB)
- (5) Disconnect the connector and then remove the DMAIN ASSY (with the BRIDGE ASSY).

**VSX-S310 :**

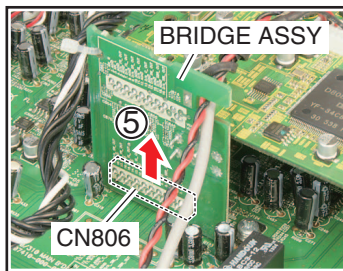
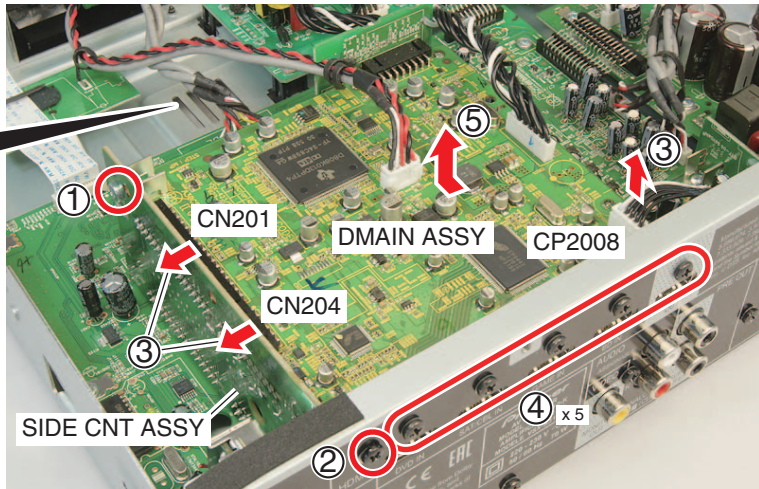

Front



### [3-2] Diagnosis

- (1) Set the insulation sheet.
- (2) Arrange the unit as shown in the photo.

#### VSX-S510 :

- (3) Connect the 5P PH Housing ASSY extension jig cable. (GGD1594)  
(MAIN 5P Cable <-> DMAIN CN1802)
- (4) Connect the 19P board to board extension jig cable. (GGD1849)  
(BRIDGE CN802 <-> DMAIN CN1801)
- (5) Connect the 33P board to board extension jig cable. (GGD1847)  
(SIDE CNT CN805 <-> DMAIN CN102)
- (6) Connect the 11P board to board extension jig cable. (GGD1846)  
(SIDE CNT CN804A <-> DMAIN CN101)
- (7) Connect the connector.

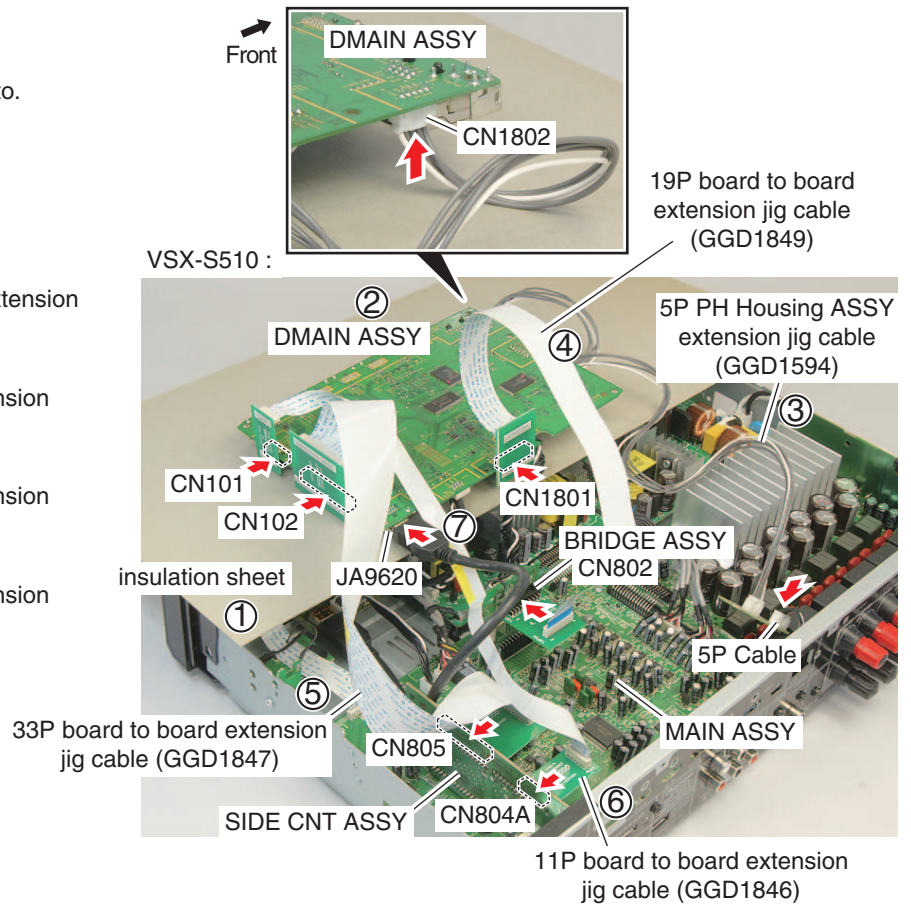

#### VSX-S310 :

- (3) Connect the 5P PH Housing ASSY extension jig cable. (GGD1594)  
(MAIN 5P Cable <-> DMAIN CP2008)
- (4) Connect the 19P board to board extension jig cable. (GGD1849)  
(MAIN CN102A <-> BRIDGE CN806)
- (5) Connect the 33P board to board extension jig cable. (GGD1847)  
(SIDE CNT CN805 <-> DMAIN CN201)
- (6) Connect the 11P board to board extension jig cable. (GGD1846)  
(SIDE CNT CN804B <-> DMAIN CN204)

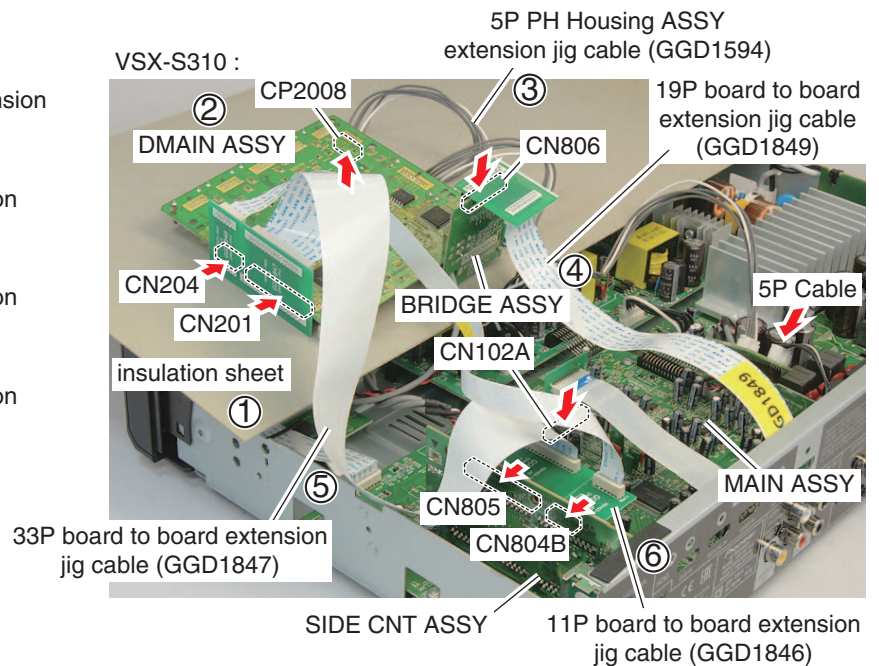

### [4] MAIN ASSY

#### [4-1] MAIN ASSY

- A Remove the Cabinet S510.  
(Refer to the "[1] Cabinet S510")
- Remove the DMAIN ASSY.  
(Refer to the "[3-1] DMAIN ASSY")

- (1) Release the cable from the PCB binder.
- (2) VSX-S510 only :  
Release the cable from the Clamp MTG.
- (3) Disconnect the connector.
- (4) Remove the screw. (BBZ30P180FTC)
- B (5) Remove the five screws.  
(BBZ30P080FTC)
- (6) Remove the MAIN GUARD ASSY.

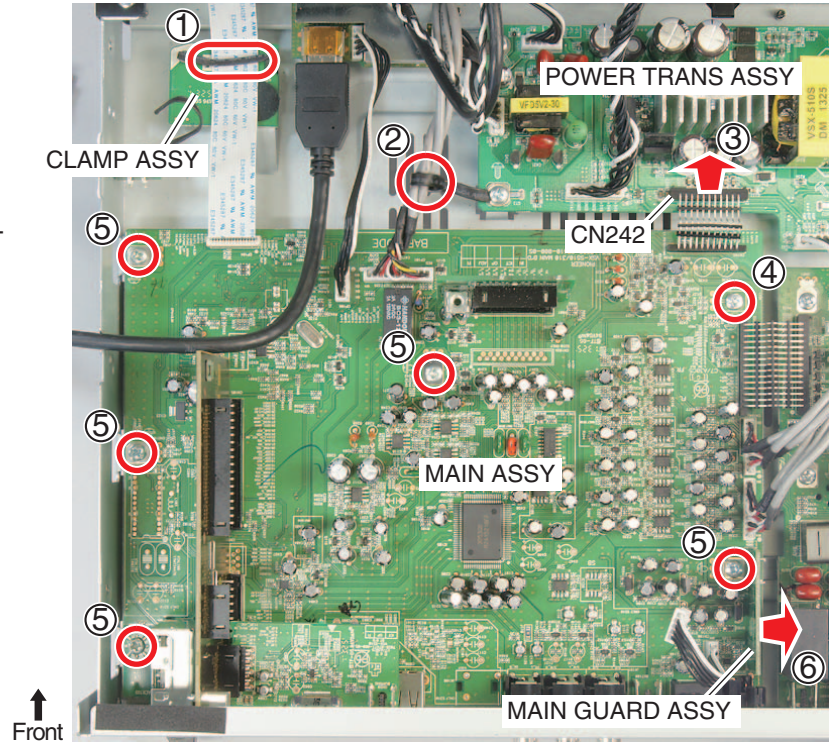

- C [4-2] Diagnosis

- (1) Cut the two Clamp (Binder).
- (2) Remove the two screws. (BBZ30P180FTC)
- (3) Remove the three screws. (BBZ30P080FTC)
- D (4) Disconnect the connector and then remove the AMP GUARD ASSY.

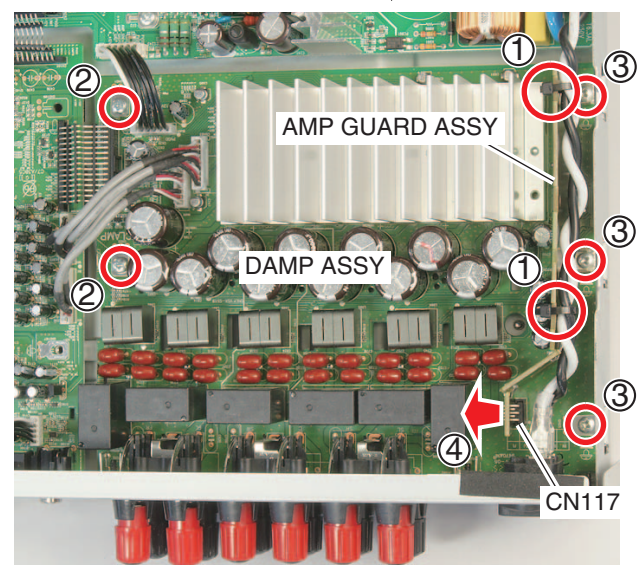

- E (5) VSX-S510 :  
Set the DMAIN ASSY and connect the four connectors.  
VSX-S310 :  
Set the DMAIN ASSY (with the BRIDGE ASSY) and connect the four connectors.
- (6) Attach one piece of screw (BSZ30P040FTB) to any one of the HDMI connectors. (for GND connection)

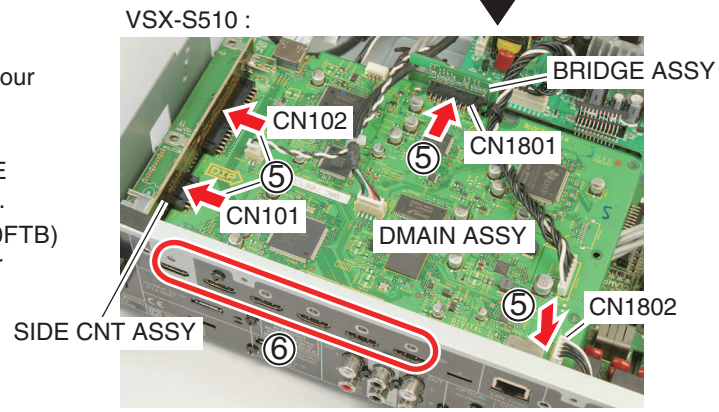



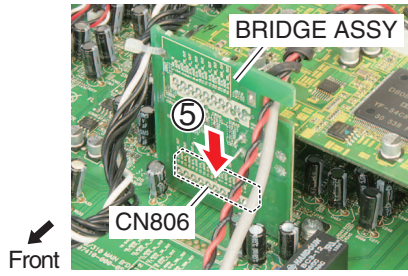

VSX-S310 :

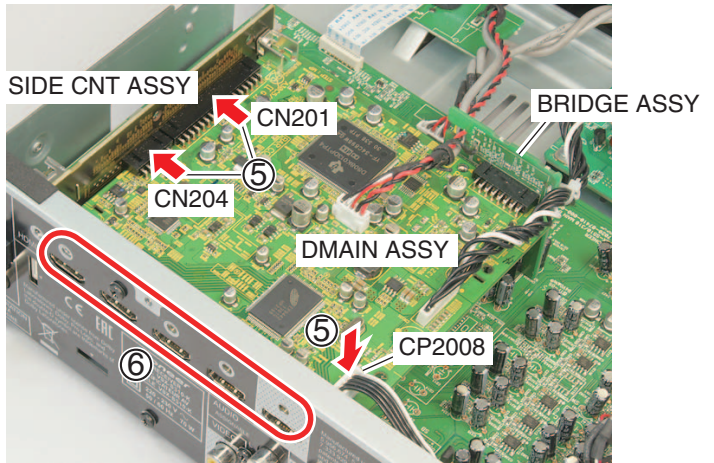

(7) Remove the five screws. (BBT30P100FTB)



(8) Lift up the Back Chassis (with other ASSY) a little bit after pulling out the Back Chassis to rear side. (Refer to the photo)

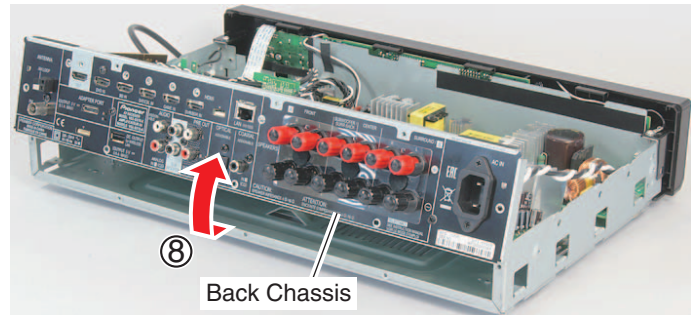

(9) Apply insulating process on the B-side of 11P bridge connector extension jig cable (GGD1758).

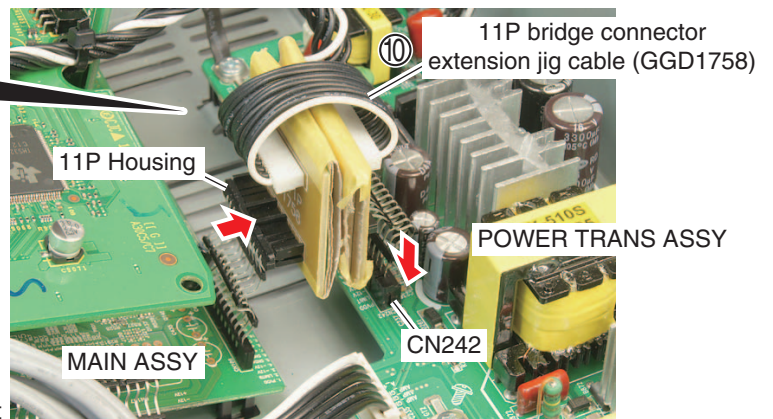
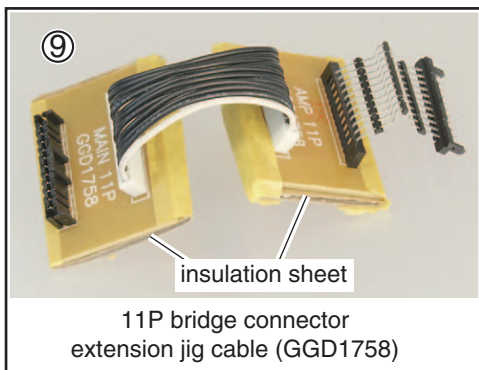

(10) Connect the 11P bridge connector extension jig cable. (GGD1758)  
(MAIN 11P Housing <-> POWER TRANS CN242)

(11) VSX-S510 only :  
 Connect the Cable HDMI 360mm after lifting up the Back Chassis (with other ASSY) to about 45 degrees.

**Note**  
 \*1: Insert the Cable HDMI 360mm between the CLAMP ASSY and the HDMI plug in order to prevent stress applied to the JA9620 of DMAIN ASSY.

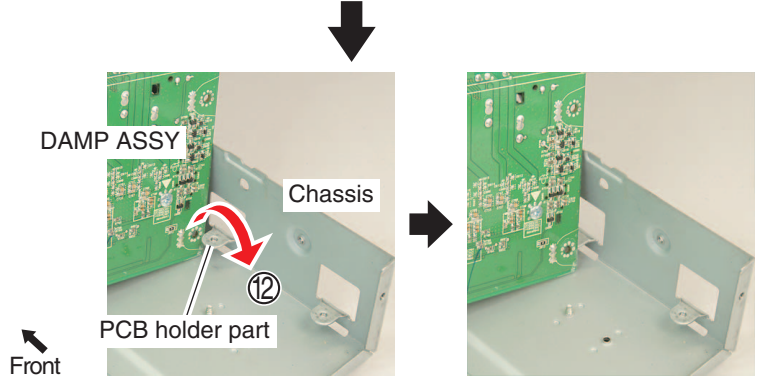
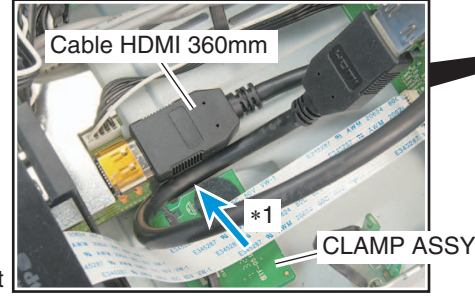
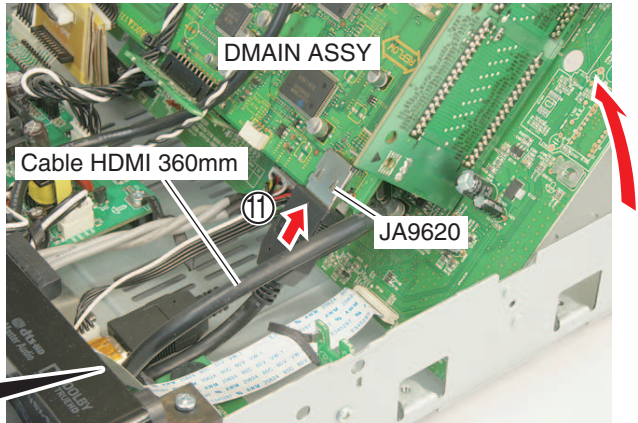

(12) Lift up the DAMP ASSY side a little bit after turning up the Back Chassis (with other ASSY) to vertical position and transpose the DAMP ASSY from the PCB holder part of Chassis to rear side.

(13) When you remove and diagnose PCB, please make GND connection of the Back Chassis and the Chassis with a clip etc.  
 (14) Perform diagnosis while holding the left part of MAIN ASSY.

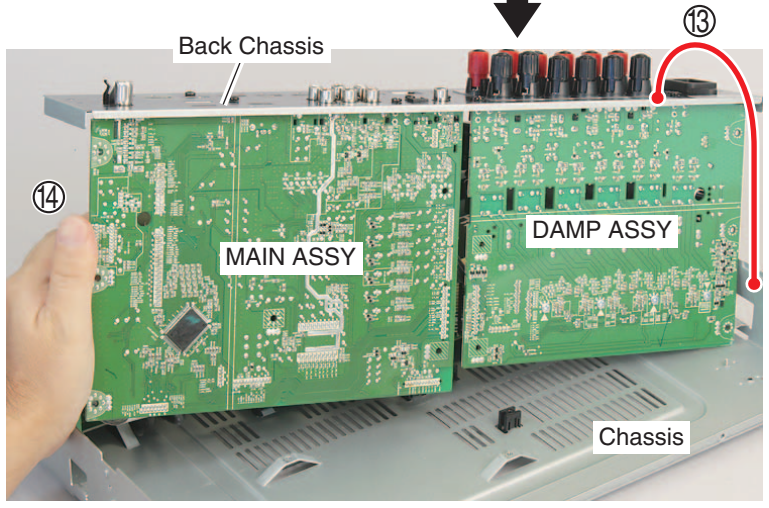

**Note (VSX-S510 only)**  
 \*2: Pay attention not to apply stress on the JA9620 of DMAIN ASSY.

**[5] POWER TRANS ASSY**

Remove the Cabinet S510.  
 (Refer to the "[1] Cabinet S510")

- (1) Disconnect the five connectors.
- (2) VSX-S510 only : Disconnect the connector.
- (3) Remove the screw. (BBZ30P080FTC)
- (4) Remove the four screws. (BBZ30P180FTC)
- (5) Remove the POWER TRANS ASSY.

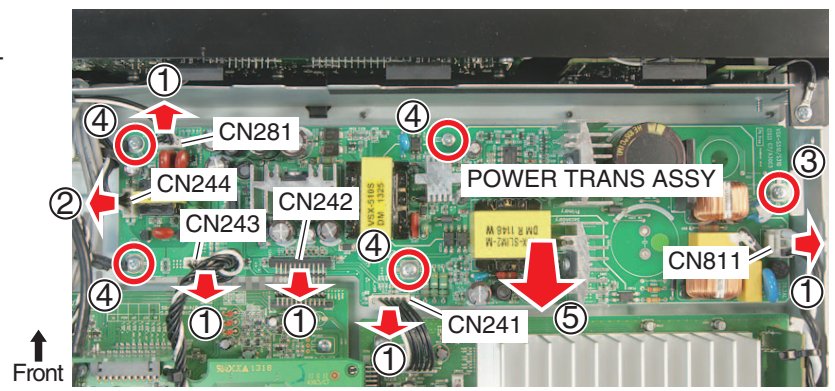

## [6] DAMP ASSY

Remove the Cabinet S510.

(Refer to the "[1] Cabinet S510")

Remove the POWER TRANS ASSY.

(Refer to the "[5] POWER TRANS ASSY")

- (1) Disconnect the three connectors.
- (2) Remove the three screws.  
(BBZ30P080FTC)
- (3) Disconnect the connector and then remove the AMP GUARD ASSY.
- (4) Remove the two screws.  
(BBZ30P180FTC)

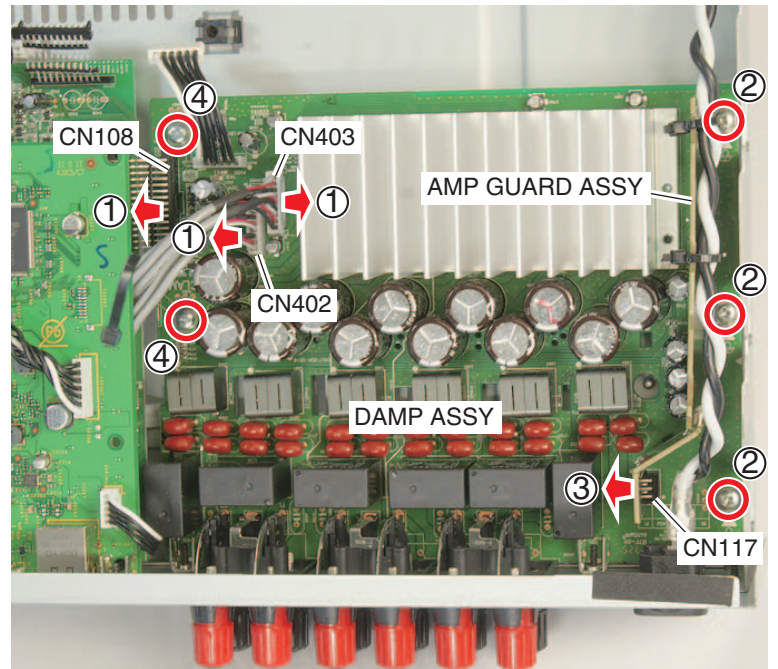

- (5) Remove the three Cushions.

- (6) Remove the five screws.  
(BBT30P100FTB)

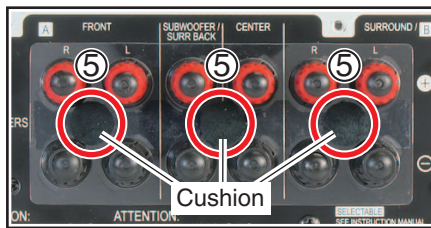

VSX-S510 :  : ⑥ x 5

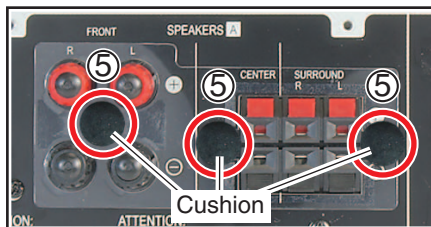
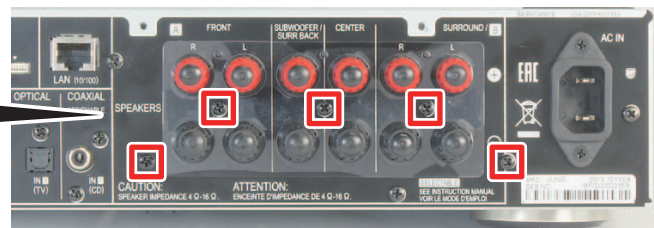

VSX-S310 :  : ⑥ x 5

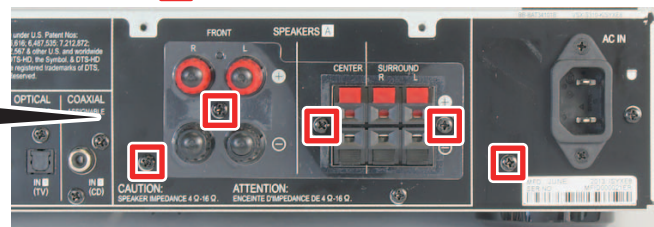

- (7) Remove the DAMP ASSY.

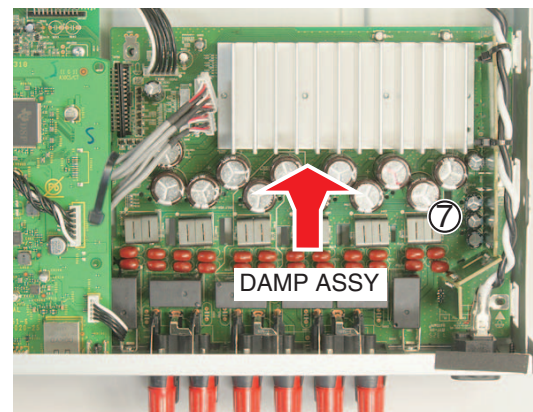

(8) Remove the four screws (BBZ30P080FTC), and then remove the Heat Sink (with three Heat Sink Sheets).

A

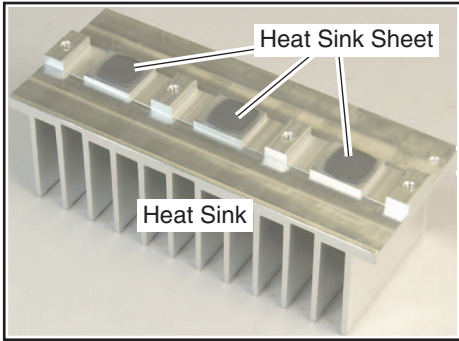

B

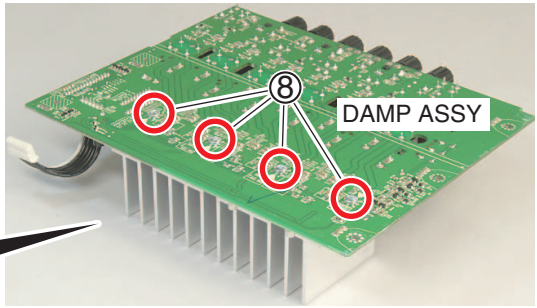

**Direction of Foot**

Align the mark at under surface of the Foot with the direction of photo.

C

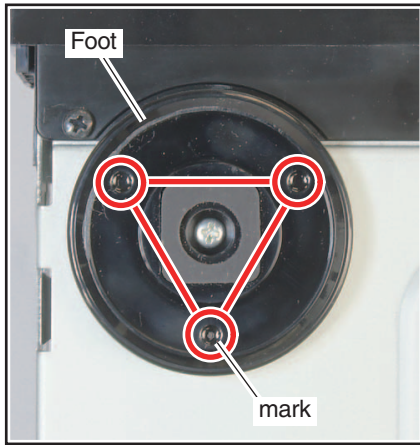

D

VSX-S510 :

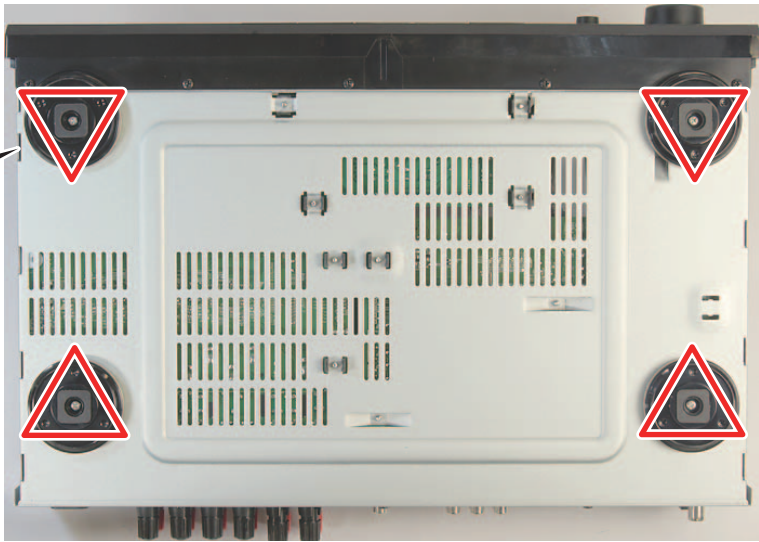

• Bottom view

E

VSX-S310 :



• Bottom view

F

## Styling of cables

When you attach each unit, make a styling and connection of cables as shown in the photo.

### [1] VSX-S510

- (1) Set the 4P cable (from the FHDMI ASSY) near to the POWER TRANS ASSY.
- (2) Set the 11P cable (from the FRONT ASSY) away from the POWER TRANS ASSY.

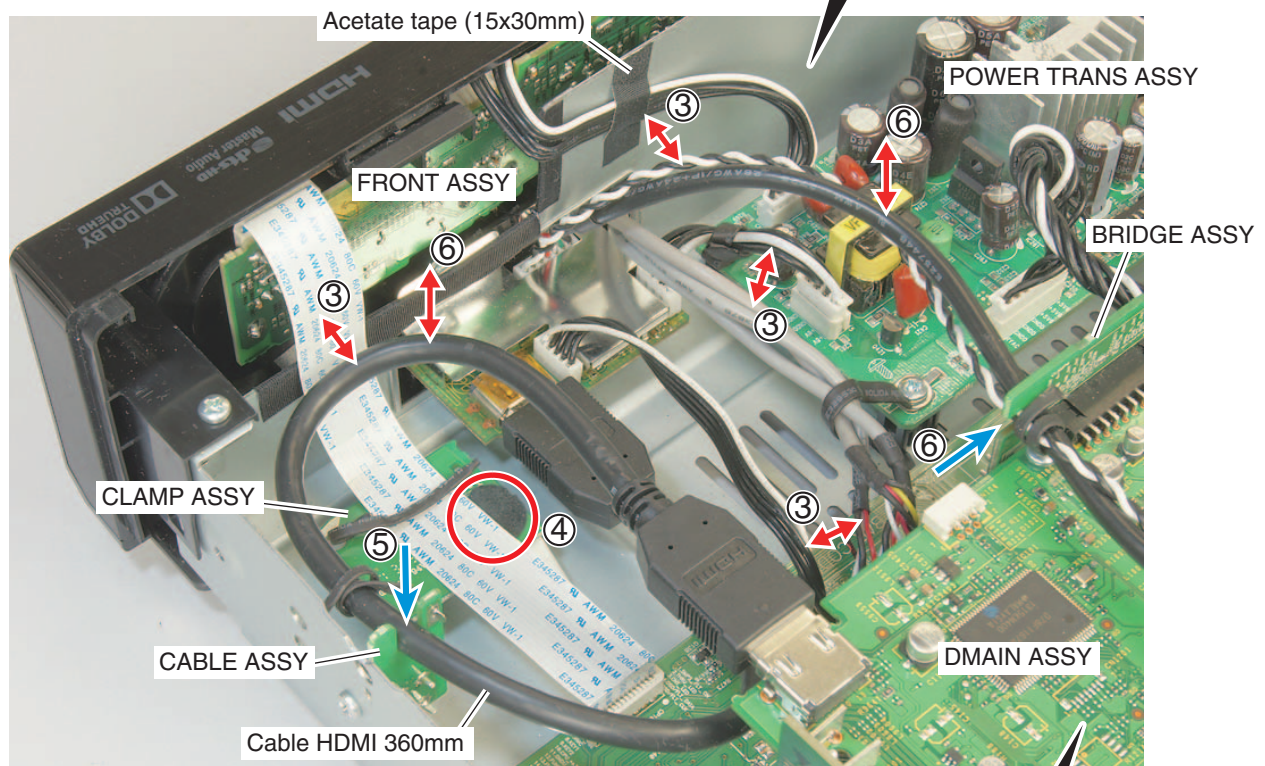
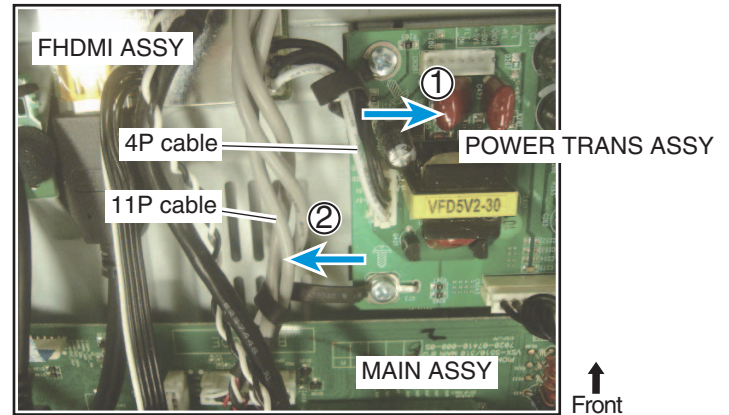

- (3) Doesn't touch the other cables.
- (4) Paste the Cushion on the head of screw.
- (5) Insert the Cable HDMI 360mm into the cutout portion of the CABLE ASSY.
- (6) Insert the cable (from the FHDMI ASSY) into the cutout portion of the BRIDGE ASSY.
- (7) Doesn't touch the cables to the Cabinet S510.

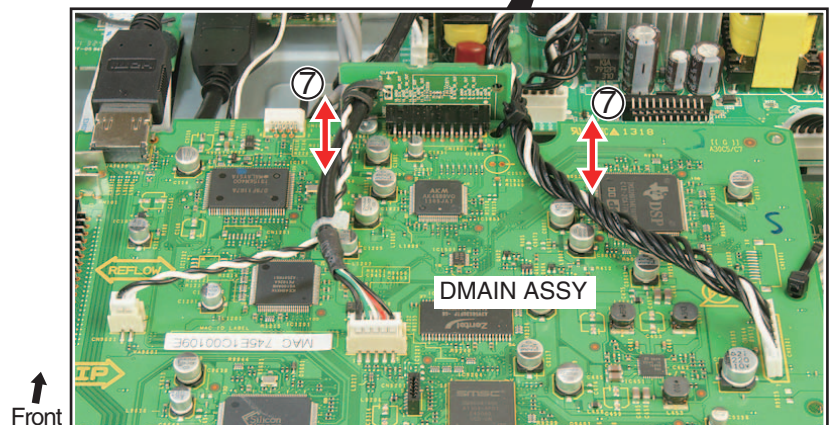

### [2] VSX-S310

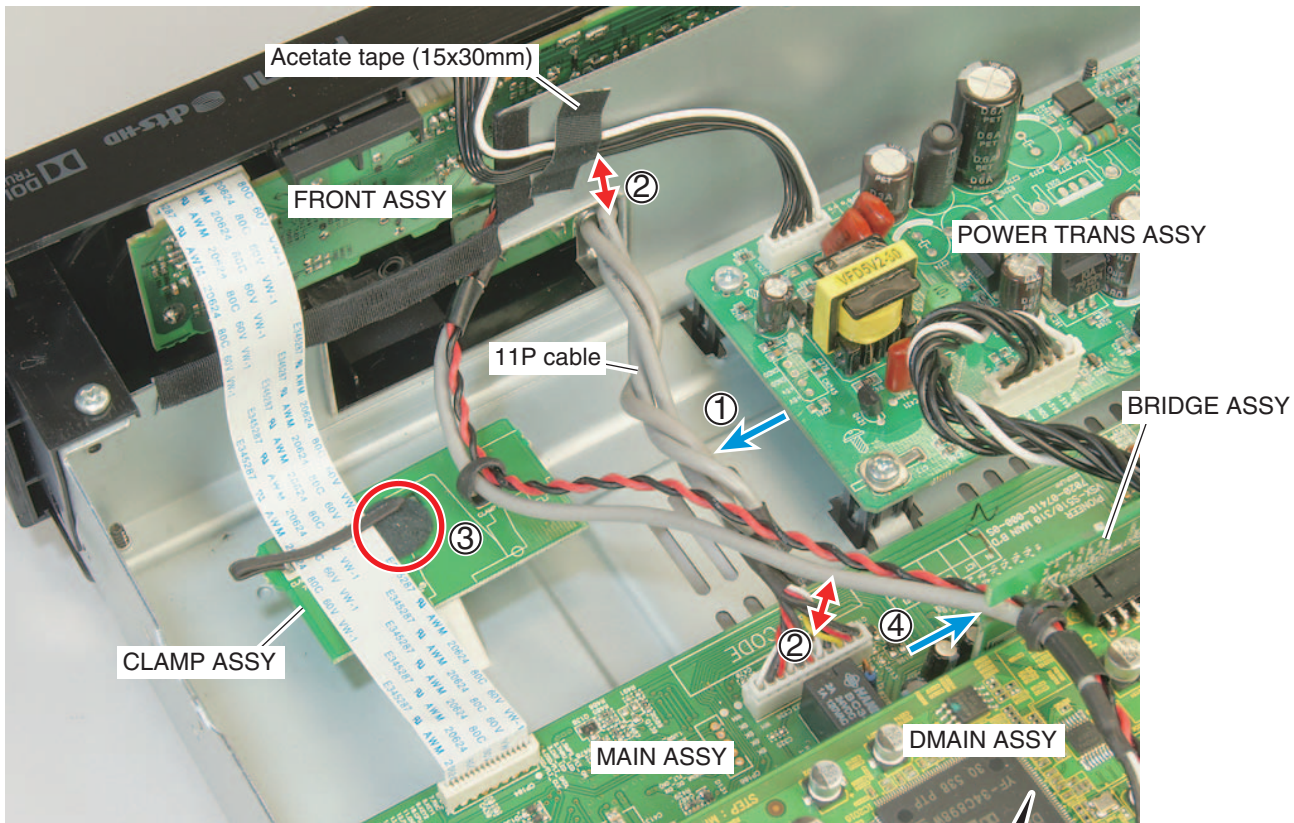

- (1) Set the 11P cable (from the FRONT ASSY) away from the POWER TRANS ASSY.
- (2) Doesn't touch the other cables.
- (3) Paste the Cushion on the head of screw.
- (4) Insert the cable (from the USB ASSY) into the cutout portion of the BRIDGE ASSY.
- (5) Doesn't touch the cables to the Cabinet S510.

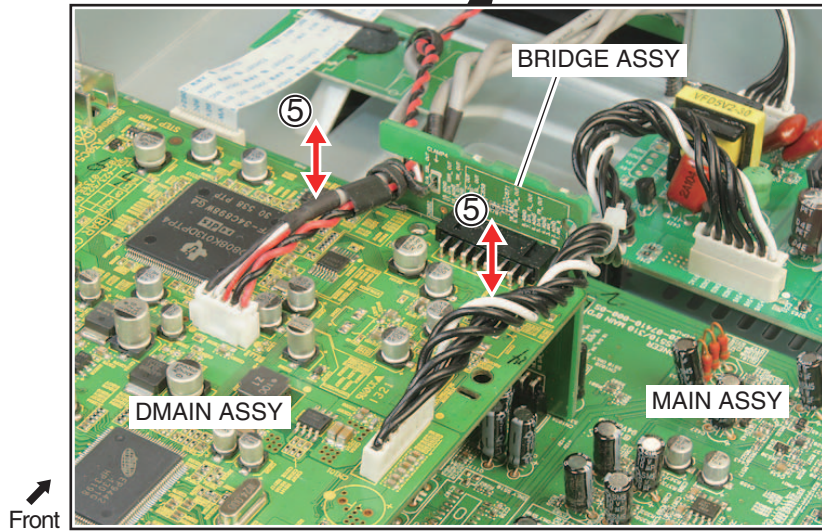

### [3] VSX-S510 and VSX-S310

- (1) Connect the Cable Flat Card 1.0mm to the MAIN ASSY with the side reinforced by wider tape.

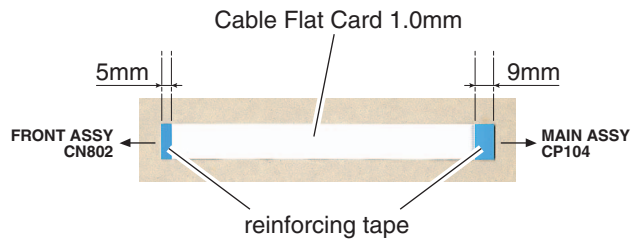

- (2) Don't touch the CN Wire to the Cabinet S510.

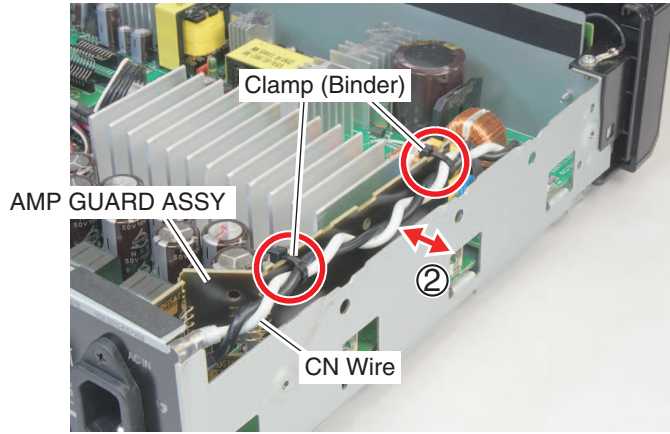

- (3) The 10P cable extra length between the FRONT ASSY and the HP MIC ASSY shall be packed into a bundle using the Clamp (Binder).

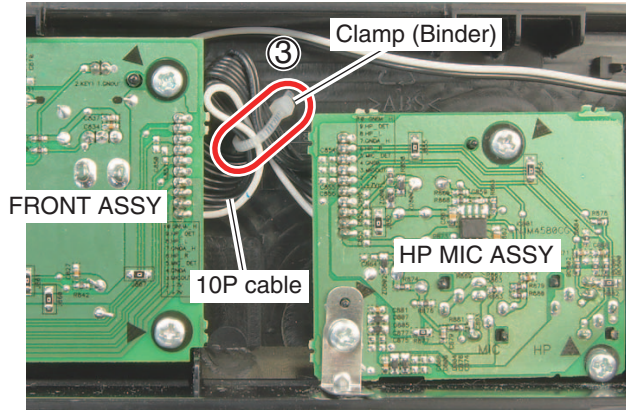

# 8. EACH SETTING AND ADJUSTMENT

## 8.1 UPDATING OF THE FIRMWARE (VSX-S510)

### [Purpose]

Refer to this section when updating the firmware of each microcomputer is required by the service information, etc.

### [Necessary Tools and Connections]

- PC with a serial port
- RS-232C cable (9-pin to 9-pin, straight cable) (Marketing product)
- UPDATE jig: GGF1642 (Use FFC of GGF1642. (10P to 10P FFC))
- Firmware

Connect as shown in the figure below.

Insert the FFC with its contact surface facing the  $\Delta$  mark.

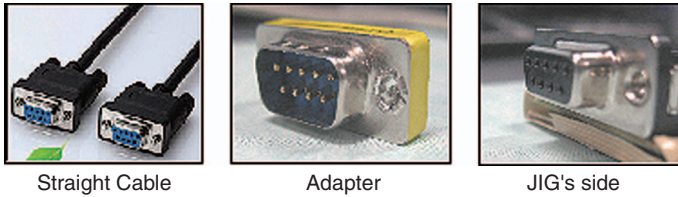
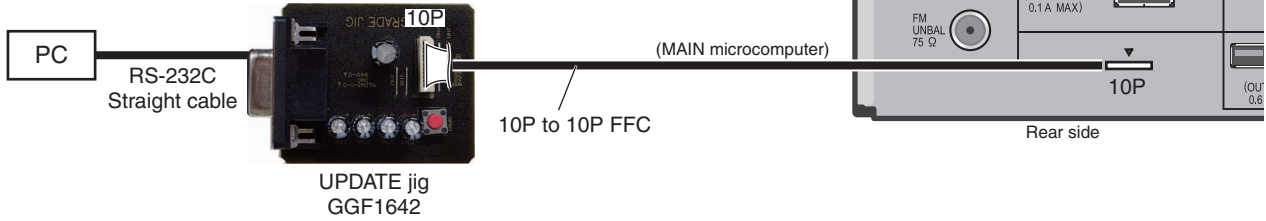

### (1) MAIN microcomputer firmware update

#### [Preestablishment]

- NetworkStandby: OFF
- HDMI Control: OFF
- HDMI StandbyThrough: OFF

#### [Procedures]

\* Store the EPFlash.exe file in the desktop of the PC.

1. Unplug the AC cord.  
Connect the FFC cable. ( MAIN microcomputer )  
Start up application FlashSta on the PC.

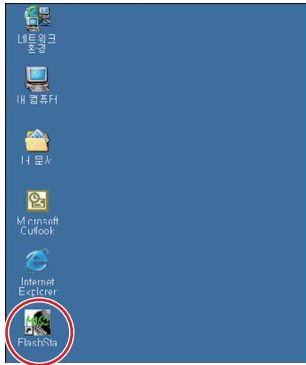

2. Plug the AC cord. (STANDBY mode)  
For updating of the MAIN microcomputer, proceed with the following steps in STANDBY mode.

3. Press the OK button.

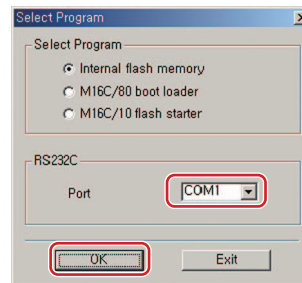

Select for COM port.

[ if the following messages are displayed ]



Please push the cancel button and press the JIG's RESET button.

And confirm a connection of FFC.

Please return to procedure 1.



4. Select the update file and enter ID.

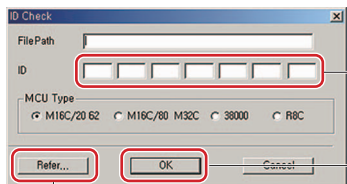

② Enter ID.  
Enter "ff" in all field.  
③ Press OK button to go to next step.

① Selection of upgrade file

① Select the update file

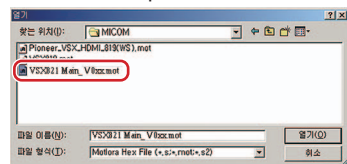

Select "FY14Slim510\_Main Ver\*\*\*.mot" file to update the MCU.



Press the OK button.

② Enter ID.

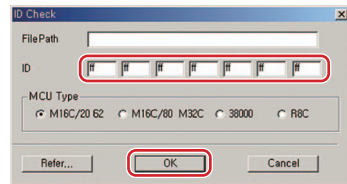

Press the OK button.

5. Set speed update and update the MCU.

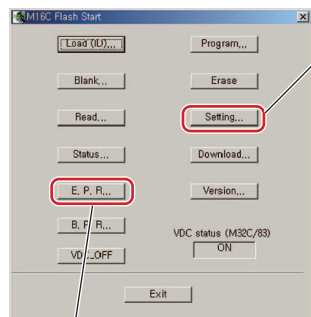

① Set speed of update.

① Set speed of update.  
Set Baud rate to 38400.

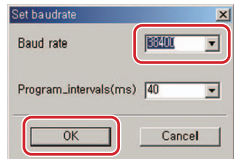

Press the OK button.

② Update the MCU.

E.P.R=>Erase+Program+Read

② Update the MCU

Press the E.P.R ... button

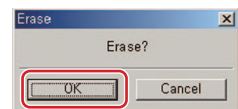

Press OK button.

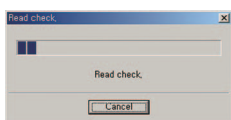
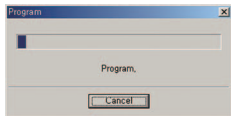

6. Update Finished MAIN microcomputer.



Press the OK button.

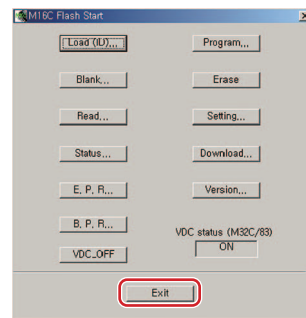

Press the Exit button.  
Please wait for until this window disappears.

If the following messages are displayed, shut the update program down, and start the update again from step 1.



Push the JIG's RESET button during 1 sec.  
Press the OK button.

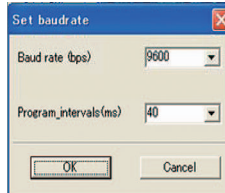

Select the 9600 of the Board rate then press the OK button

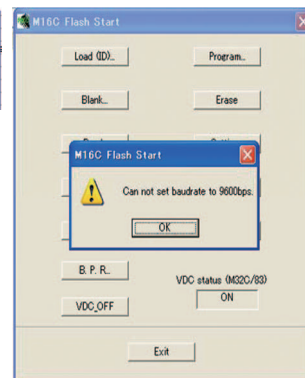

7. Unplug the AC cord.

Disconnect the FFC cable.

## (2) SUB microcomputer firmware update

### [Preparations]

Save the firmware file to the "root" of empty USB memory. The file name of the firmware file is "Slim14Sub\_V\*\*\*.bcd". Don't save other files.

- NetworkStandby: OFF
- HDMI Control: OFF
- HDMI StandbyThrough: OFF
- Connect a unit to TV and HDMI, and the GUI output of the unit performs in a state to appear.

### [Procedures]

1. Turn on the unit.
2. Set a function for a "NETRADIO".

#### Note:

Without a network connection, "Server Error" will be displayed on the TV screen. Under this condition, the Service Menu (menu for updating the SUB microcomputer) is not accessible. Set the remote control unit supplied with the unit to Network Function Operation mode then press the ENTER button so that "Empty" is displayed on the screen. Then proceed to Step 3.



3. Press the "ESC (A85F)" button on the Service remote control unit (GGF1381), then press the "+10 (A81F)" button to enter the service menu (for SUB microcomputer firmware update menu). When you press other buttons between "ESC" button and "+10" buttons, be invalid.

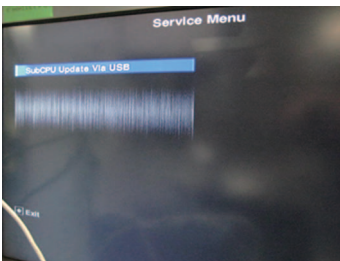

4. Press the "ENTER" button of the remote control unit supplied with Network Function as the state that you can operate.

- (1) When a product can recognize a file, become the following indication. Select "Start", and press the "ENTER" button.

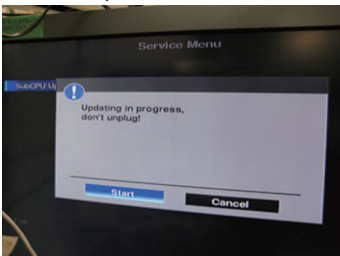

- (2) When a product cannot recognize a file, become the following indication. Check on USB memory with a file.

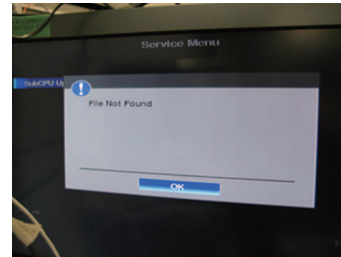

5. Update starts, and "UPDATE" blinks to FL screen and HDMI LED blinks. Be approximately 8 minutes for update at time.

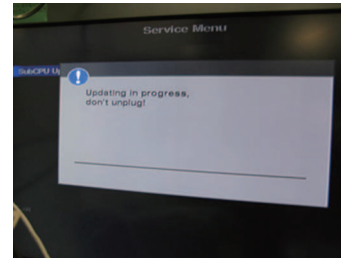

6. When update is completed, "Completed" is displayed by TV screen and HDMI LED lights.
  - \* "UPDATE" blinks to FL display and is displayed. In rare cases, "Completed!" may not be displayed on the TV screen. In such a case, updating is completed if the HDMI LED has become lit. Proceed to Step 7.

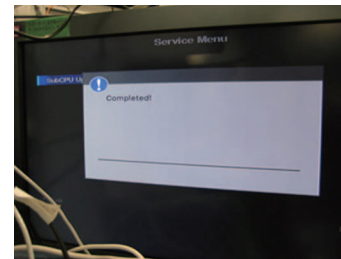

7. Disconnect the AC power cord. (The POWER button does not respond.) Confirm a version of the firm ware of SUB microcomputer.

#### Note:

Because update is not possible again, never unplug the power cord until the updating process is completed.

### (3) USB (BridgeCo) firmware update

#### [Procedures]

1. Select 'Firmware Update' from the Network Setup menu. The receiver checks whether the USB memory device inserted into the USB port on the receiver's front panel contains updatable software.
2. To update, select 'Start'.
3. When 'Updating in progress, don't unplug!' is displayed, select 'OK'.
  - If 'File Not Found' is displayed, try the following:
    - No update file was found on the USB memory device. Store the file in the USB memory device's root directory.
    - Try disconnecting then reconnecting the USB device or storing the update file again. If the error still occurs, try using a different USB memory device.
4. The software update will start. Please wait. The OSD display will turn off during update and the words 'UPDATE' will flash on the front panel.
5. If 'COMPLETE' is displayed, updating is completed. The screen will return automatically to the play screen.
  - If 'FAIL' is displayed on the front panel display, updating has failed. Try the following:
    - Turn the receiver's power off, then turn it back on and try updating the software again.
    - Try disconnecting then reconnecting the USB device or storing the update file again. If the error still occurs, try using a different USB memory device.

### (4) DSP firmware update

#### [Preestablishment]

- NetworkStandby: OFF
- HDMI Control: OFF
- HDMI StandbyThrough: OFF

#### [Procedures]

1. Select an Input Function that allows reception via Optical input 1 then set the unit to STBY\_Off mode.
2. Press and hold the AUTO SURROUND/STREAM DIRECT key on the unit for 5 seconds, then press the BD key on the Remote Control simultaneously to enter DSP UpDate mode. ("DSP UP" is displayed.)
3. When "PLAY" is displayed, playback of the .wav file starts. (Play the file only once. NEVER repeat playback.) ("PLAY" is displayed.)
4. After playback is finished and "ENTER" is displayed, press the iPod iPhone iPad DIRECT CONTROL key on the front panel. ("ENTER" is displayed.)
5. "WRITING" is automatically displayed.
6. After writing is completed, "COMPLETE" is displayed.
7. Turn the unit off then confirm that the version has been updated.

### (5) Check to the firmware version

#### [Preestablishment]

- NetworkStandby: OFF
- HDMI Control: OFF
- HDMI StandbyThrough: OFF

#### [Procedures]

Make sure that the main unit is in STANDBY mode.

Press and hold the AUTO SURROUND/STREAM DIRECT key on the unit for 5 seconds, then press the CD key on the Remote Control simultaneously to display each UCOM version.

Each time the iPod iPhone iPad DIRECT CONTROL key on the unit is pressed, then indications on the FL display change as follows:



Turn the unit off.

\* It may take around 1 minute until the version of the USB microcomputer is displayed. When be not displayed, wait in the state that turned on the power of the product for 1 minute, and please do it from the first procedure again.

## 8.2 UPDATING OF THE FIRMWARE (VSX-S310)

### [Purpose]

Refer to this section when updating the firmware of each microcomputer is required by the service information, etc.

### [Necessary Tools and Connections]

#### ① MAIN microcomputer

- PC with a serial port
- RS-232C cable (9-pin to 9-pin, straight cable) (Marketing product)
- UPDATE jig: GGF1642 (Use FFC of GGF1642. (10P to 10P FFC))
- Firmware

Connect as shown in the figure below.

Insert the FFC with its contact surface facing the  $\Delta$  mark.

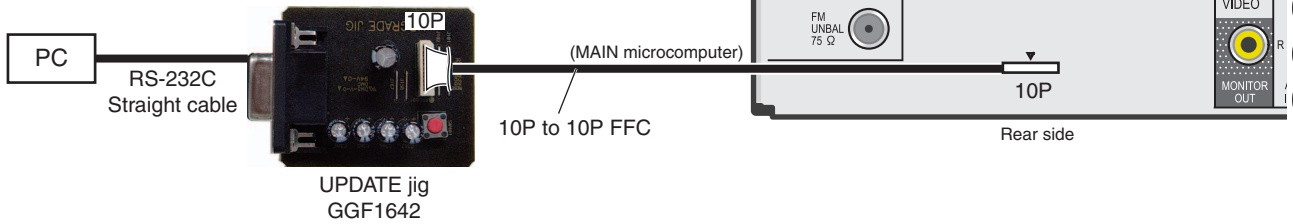

Straight Cable



Adapter



JIG's side

#### ② HDMI & CEC (SUB) microcomputer

- PC with a USB port
- USB cable (Marketing product)
- UPDATE jig: GGF1646 (Use FFC of GGF1642. (10P to 10P FFC))
- Firmware

#### <PC setting>

1. Thaw the upgrade programII.zip. \* Store the EPFlash.exe file in the desktop of the PC.  
Appear the below folderes and files.  
Folder name: CDM20812  
Folder name: EPFlash
2. Install the driver.  
Request the driver at the time of the conecting the Upgrade Jig and the PC with the USB cable.  
Install the Driver (CDM20812).
3. Install .NET Framework 3.0 service pack1.  
To work EPFlash.exe (application for rewriting the HDMI u-co), request to be installed the .NET Framework 3.0 service pack1 on the PC.  
For installation of .NET Framework, Internet connection is required.

To confirm if .NET Framework 3.0 Service Pack 1 has been installed on your PC or not, select Settings > Control Panel > Add or Remove Programs. This confirmation method may be different, depending on the PC. Refer to the operation manual of the PC you use on how to execute Add or Remove Programs.

Connect as shown in the figure below.  
 Insert the FFC with its contact surface facing the  $\Delta$  mark.

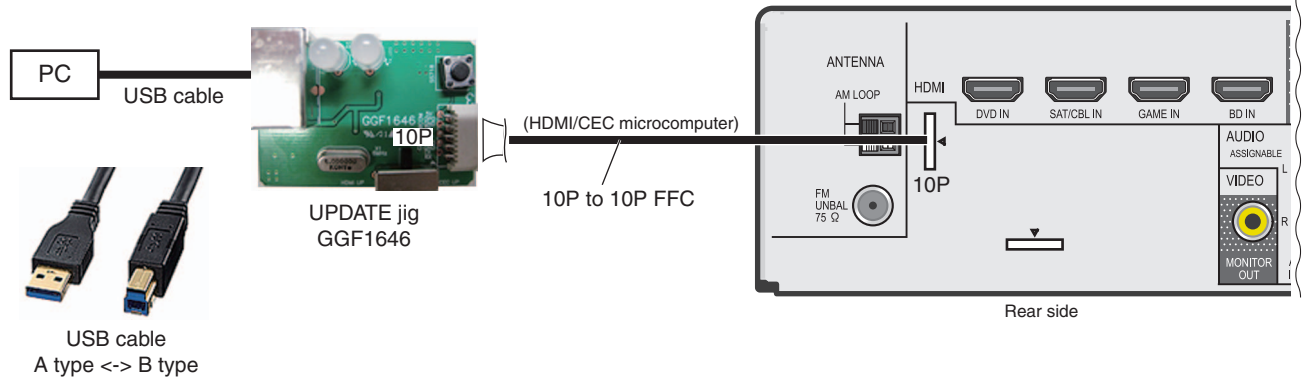

## Microcomputers update

### [Procedures]

#### ■ for MAIN microcomputer

1. Unplug the AC cord.  
 Connect the FFC cable. ( MAIN microcomputer )  
 Start up application FlashSta on the PC.

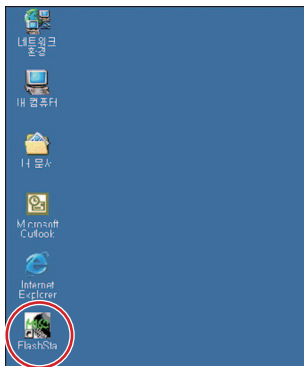

2. Plug the AC cord. (STANDBY mode)  
 For updating of the MAIN microcomputer, proceed with the following steps in STANDBY mode.

3. Press the OK button.

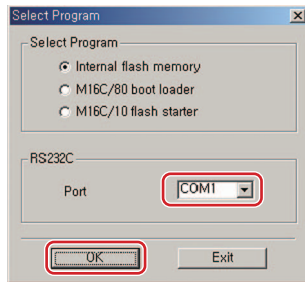

Select for COM port.

#### [ if the following messages are displayed ]



Please push the cancel button and press the JIG's RESET button.  
 And confirm a connection of FFC.  
 Please return to procedure 1.

4. Select the update file and enter ID.

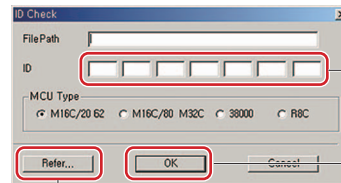

- ② Enter ID.  
 Enter "fff" in all field.
- ③ Press OK button to go to next step.

#### ① Selection of upgrade file

#### ① Select the update file

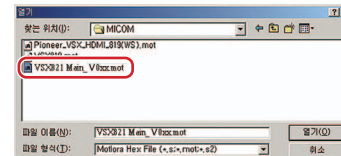

Select "FY14Slim310\_Main Ver\*\*\*.mot" file to update the MCU.

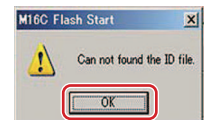

Press the OK button.

#### ② Enter ID.

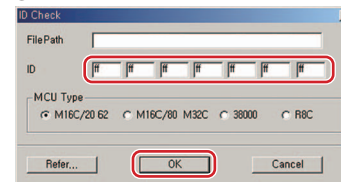

Press the OK button.

5. Set speed update and update the MCU.

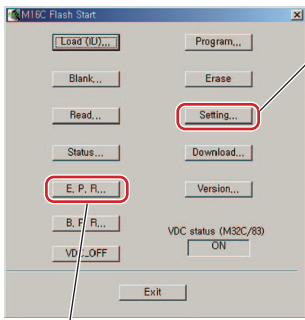

① Set speed of update.

① Set speed of update. Set Baud rate to 38400.

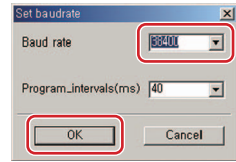

Press the OK button.

② Update the MCU.

E.P.R=>Erase+Program+Read

② Update the MCU

Press the E.P.R ... button

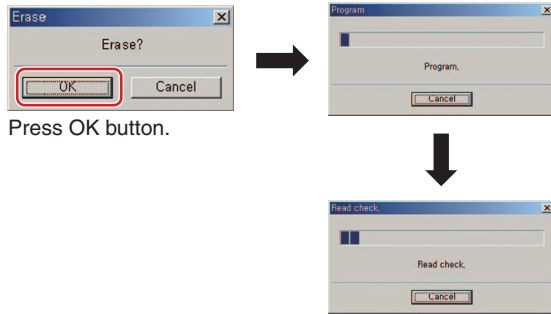

Press OK button.

6. Update Finished MAIN microcomputer.

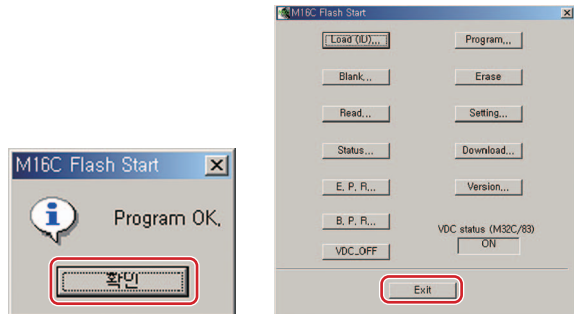

Press the OK button.

Press the Exit button. Please wait for until this window disappears.

If the following messages are displayed, shut the update program down, and start the update again from step 1.



Push the JIG's RESET button during 1 sec. Press the OK button.

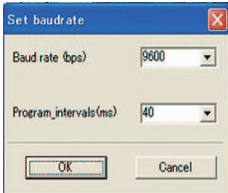

Select the 9600 of the Board rate then press the OK button

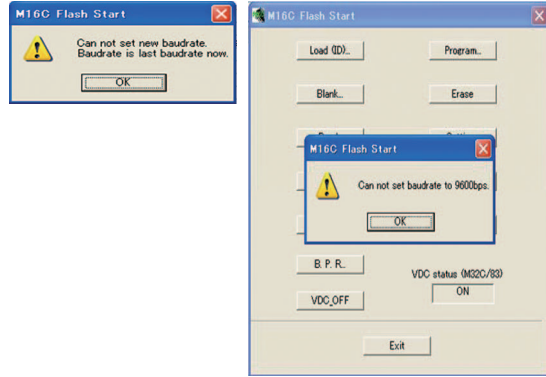

7. Unplug the AC cord. Disconnect the FFC cable.

for HDMI & CEC (SUB) microcomputer

1. Unplug the AC cord. Start up the application EPFlash on the PC.

When the PC and the Upgrade Jig is connecting, the COM PORT is set automatically.

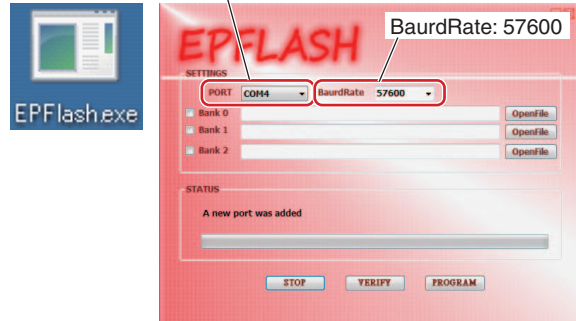

2. Select "HDMI UP" on the Upgrade Jig.

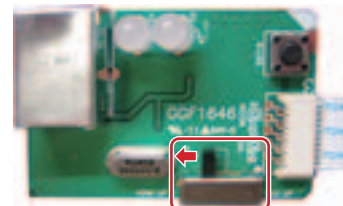

Connect the PC and the Upgrade Jig. Connect the FFC cable. (HDMI microcomputer)

3. Holding down the tact switch (RESET) of the Upgrade Jig in AC OFF state. Release the tact switch after AC ON, power ON (2-3 seconds later).

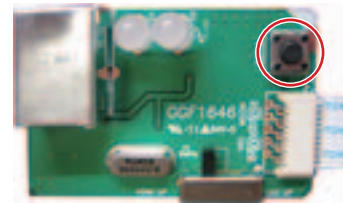

4. Select the update file. Press the "OpenFile" button.



Be chosen automatically to Bank 2 when you choose file of H00 in Bank 0.

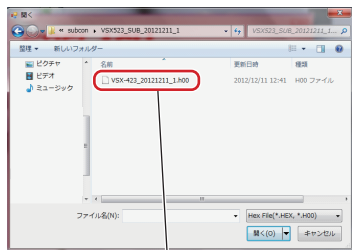

Select "VSX-S310\_\*\*\*\*\*.h00" file to update MCU.

5. Press the "PROGRAM" button to update the firmware.

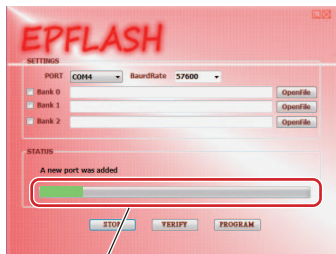

Rate of the progression is appeared.

6. Update Finished HDMI microcomputer.

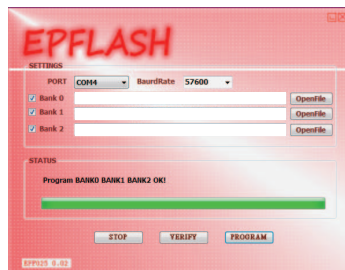

End the application EPFlash.

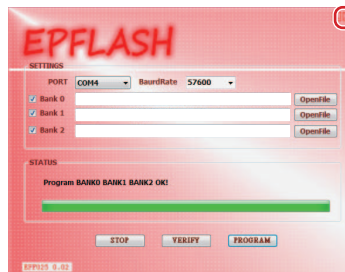

If a message of "Program BANK0 BANK1 BANK2 OK!" is indicated, let update is the normalcy end, and EPFLASH down.

If a message except the above is indicated, does AC OFF, and confirm a PC, Upgrade Jig, connection of FFC Cable, and start the update again from step 1.

7. Turn the unit off. (STANDBY mode)

Unplug the AC cord, and be around one minute, and Disconnect the FFC cable.

Check to the software virsion of MAIN, HDMI & CEC (SUB) microcomputers

1. Make sure that the main unit is in STANDBY mode.

Press and hold the AUTO SURROUND/STREAM DIRECT key on the unit for 5 seconds, then press the CD key on the Remote Control simultaneously to display each UCOM version.

Each time the iPod iPhone DIRECT CONTROL key on the unit is pressed, then indications on the FL display change as follows:

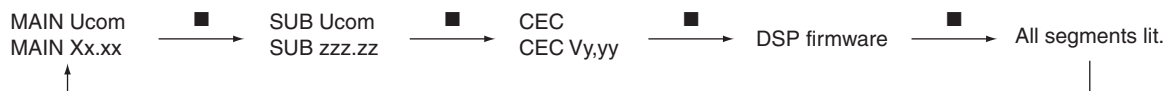

2. Turn the unit off.

■ = iPod iPhone DIRECT CONTROL

## ■ DSP firmware update

### [Procedures]

1. Select TV function, and, with Signal select as OPTICAL1 then set the unit to STBY\_Off mode.
2. Press and hold the AUTO SURROUND/STREAM DIRECT key on the unit for 5 seconds, then press the BD key on the Remote Control simultaneously to enter DSP UpDate mode. ("DSP UP" is displayed.)
3. When "PLAY" is displayed, playback of the .wav file starts. (Play the file only once. NEVER repeat playback.) ("PLAY" is displayed.)
4. After playback is finished and "ENTER" is displayed, press the iPod iPhone DIRECT CONTROL key on the front panel. ("ENTER" is displayed.)
5. "WRITING" is automatically displayed.
6. After writing is completed, "COMPLETE" is displayed.
7. Turn the unit off then confirm that the version has been updated.

A

B

C

D

E

F





5



6



7



8



A



B



C



D



E



F



5



6

VSX-S510-K



7





8



65

# 9. EXPLODED VIEWS AND PARTS LIST

NOTES: ● Parts marked by "NSP" are generally unavailable because they are not in our Master Spare Parts List.

- The  mark found on some component parts indicates the importance of the safety factor of the part. Therefore, when replacing, be sure to use parts of identical designation.
- Screws adjacent to  mark on product are used for disassembly.
- For the applying amount of lubricants or glue, follow the instructions in this manual. (In the case of no amount instructions, apply as you think it appropriate.)

## 9.1 PACKING SECTION

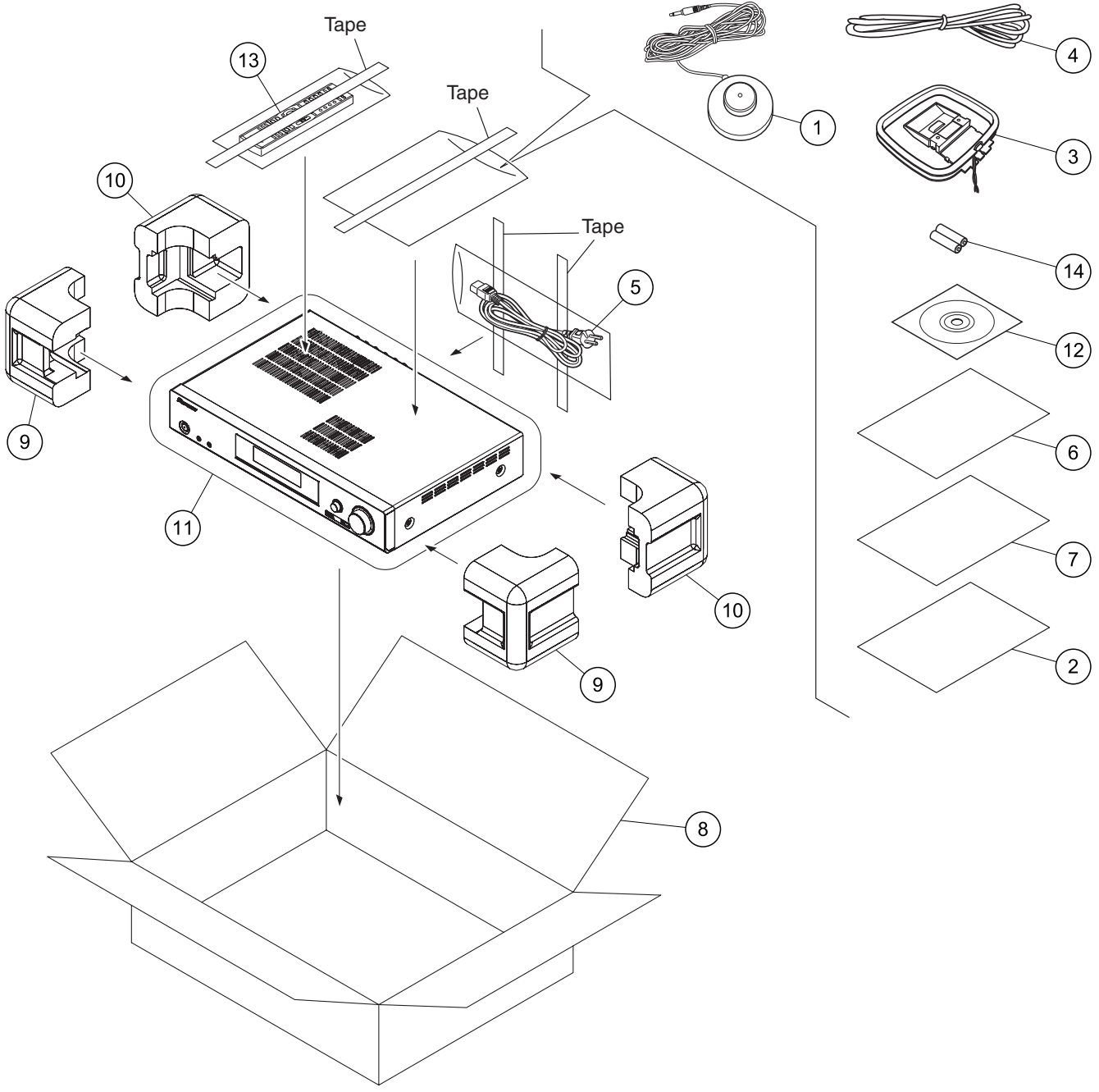

**(1) PACKING SECTION PARTS LIST**

<b>Mark No.</b>	<b>Description</b>	<b>Part No.</b>	<b>Mark No.</b>	<b>Description</b>	<b>Part No.</b>
	1 Setup Microphone	APM7011	11	PE Sheet	6327040059000-IL
NSP	2 Warranty Card	ARY7158	12	Operating Instructions (CD-ROM)	6517000001550-IL
	3 AM Loop Antenna	E601019000010-IL	13	Remote Control Unit (AXD7719)	8300771900010-IL
	4 FM Wire Antenna	E605010140010-IL	NSP 14	AAA Size IEC R03 Dry Cell Batteries x2	•••••
⚠	5 Power Cord	L068250160020-IL			
	6 Speaker Caution Sheet	5227000001050-IL			
	7 Quick Start Guide	5707000008480-IL			
	8 Gift Box	See Contrast table (2)			
	9 Cushion Snow S510 F	6230213544000-IL			
	10 Cushion Snow S510 R	6230213554000-IL			

**(2) CONTRAST TABLE**

VSX-S510-K, VSX-S510-S, VSX-S310-K and VSX-S310-S are constructed the same except for the following:

<b>Mark No.</b>	<b>Symbol and Description</b>	<b>VSX-S510-K</b>	<b>VSX-S510-S</b>	<b>VSX-S310-K</b>	<b>VSX-S310-S</b>
8	Gift Box	6007212530000-IL	6007212530010-IL	6007212530020-IL	6007212530030-IL

# 9.2 EXTERIOR SECTION

VSX-S510 only

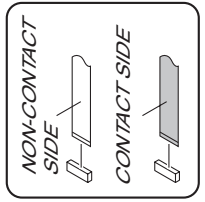

A  
B  
C  
D  
E  
F

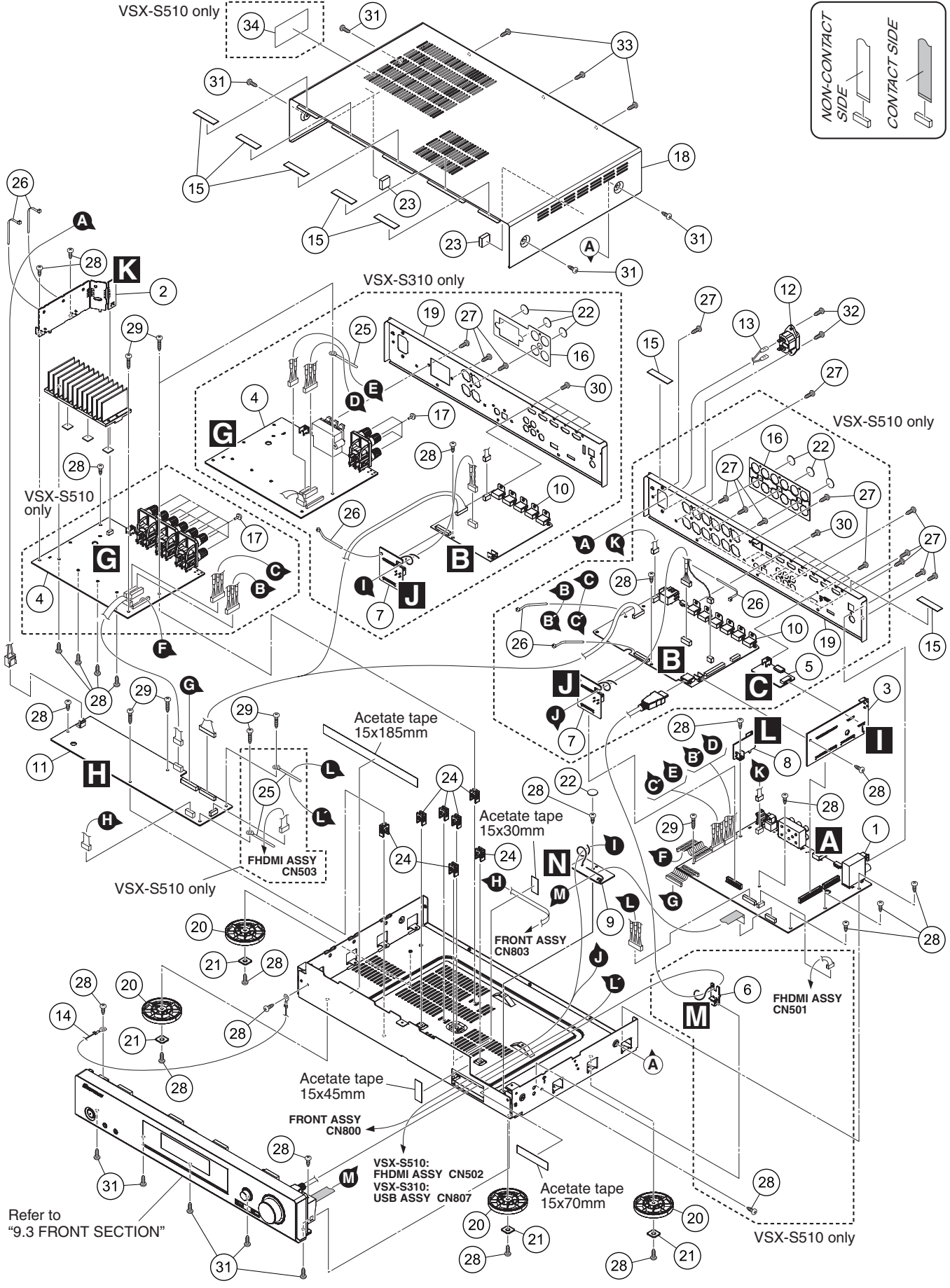

**(1) EXTERIOR SECTION PARTS LIST**

<b>Mark No.</b>	<b>Description</b>	<b>Part No.</b>	<b>Mark No.</b>	<b>Description</b>	<b>Part No.</b>
	1 MAIN ASSY	See Contrast table (2)	21	Cushion	4050211605000-IL
	2 AMP GUARD ASSY	7028074123010-IL	22	Cushion	4050211745000-IL
	3 SIDE CNT ASSY	See Contrast table (2)	23	Cushion	4050214835000-IL
	4 DAMP ASSY	See Contrast table (2)	24	Supporter	4070001601010-IL
	5 BT ASSY	See Contrast table (2)	25	Clamp MTG	4330000310000-IL
	6 CABLE ASSY	See Contrast table (2)	26	Clamp (Binder)	4330040343010-IL
	7 BRIDGE ASSY	See Contrast table (2)	27	Screw	BBT30P100FTB
	8 MAIN GUARD ASSY	7028074115010-IL	28	Screw	BBZ30P080FTC
	9 CLAMP ASSY	See Contrast table (2)	29	Screw	BBZ30P180FTC
	10 DMAIN ASSY	See Contrast table (2)	30	Screw	BSZ30P040FTB
⚠	11 POWER TRANS ASSY	See Contrast table (2)	31	Screw	See Contrast table (2)
⚠	12 Socket Power AC	G430040560021-IL	32	Screw	CBZ30P080FTB
⚠	13 CN Wire	L000191020070-IL	33	Screw	See Contrast table (2)
	14 Ring TER Wire	8410600010090-IL	34	License Label S510	See Contrast table (2)
	15 Sheet	1210210235000-IL			
	16 Speaker Sheet	See Contrast table (2)			
	17 Bushing (PLS)	2410040353010-IL			
	18 Cabinet S510	See Contrast table (2)			
	19 Back Chassis	See Contrast table (2)			
	20 Foot	See Contrast table (2)			

**(2) CONTRAST TABLE**

VSX-S510-K, VSX-S510-S, VSX-S310-K and VSX-S310-S are constructed the same except for the following:

<b>Mark No.</b>	<b>Symbol and Description</b>	<b>VSX-S510-K</b>	<b>VSX-S510-S</b>	<b>VSX-S310-K</b>	<b>VSX-S310-S</b>
	1 MAIN ASSY	7028074101010-IL	7028074101010-IL	7028074101050-IL	7028074101050-IL
	3 SIDE CNT ASSY	7028074124010-IL	7028074124010-IL	7028074124050-IL	7028074124050-IL
	4 DAMP ASSY	7028074111010-IL	7028074111010-IL	7028074111050-IL	7028074111050-IL
	5 BT ASSY	7028074112010-IL	7028074112010-IL	Not used	Not used
	6 CABLE ASSY	7028074113010-IL	7028074113010-IL	Not used	Not used
	7 BRIDGE ASSY	7028074114010-IL	7028074114010-IL	7028074114050-IL	7028074114050-IL
	9 CLAMP ASSY	7028074117010-IL	7028074117010-IL	7028074117050-IL	7028074117050-IL
	10 DMAIN ASSY	70280732310C0-IL	70280732310C0-IL	7028073351090-IL	7028073351090-IL
⚠	11 POWER TRANS ASSY	8208001050010-IL	8208001050010-IL	8208001050030-IL	8208001050030-IL
	16 Speaker Sheet	1210211542000-IL	1210211542000-IL	1210212422000-IL	1210212422000-IL
	18 Cabinet S510	3007211926100-IL	3007211926110-IL	3007211926100-IL	3007211926110-IL
	19 Back Chassis	3207214816000-IL	3207214816010-IL	3207214816100-IL	3207214816110-IL
	20 Foot	4007210661000-IL	4007210661000-IL	4000210661000-IL	4000210661000-IL
	31 Screw	B020230083B10-IL	BBZ30P080FTC	B020230083B10-IL	BBZ30P080FTC
	33 Screw	BBT30P100FTB	BBZ30P080FTC	BBT30P100FTB	BBZ30P080FTC
	34 License Label S510	5507000014190-IL	5507000014190-IL	Not used	Not used

# 9.3 FRONT SECTION

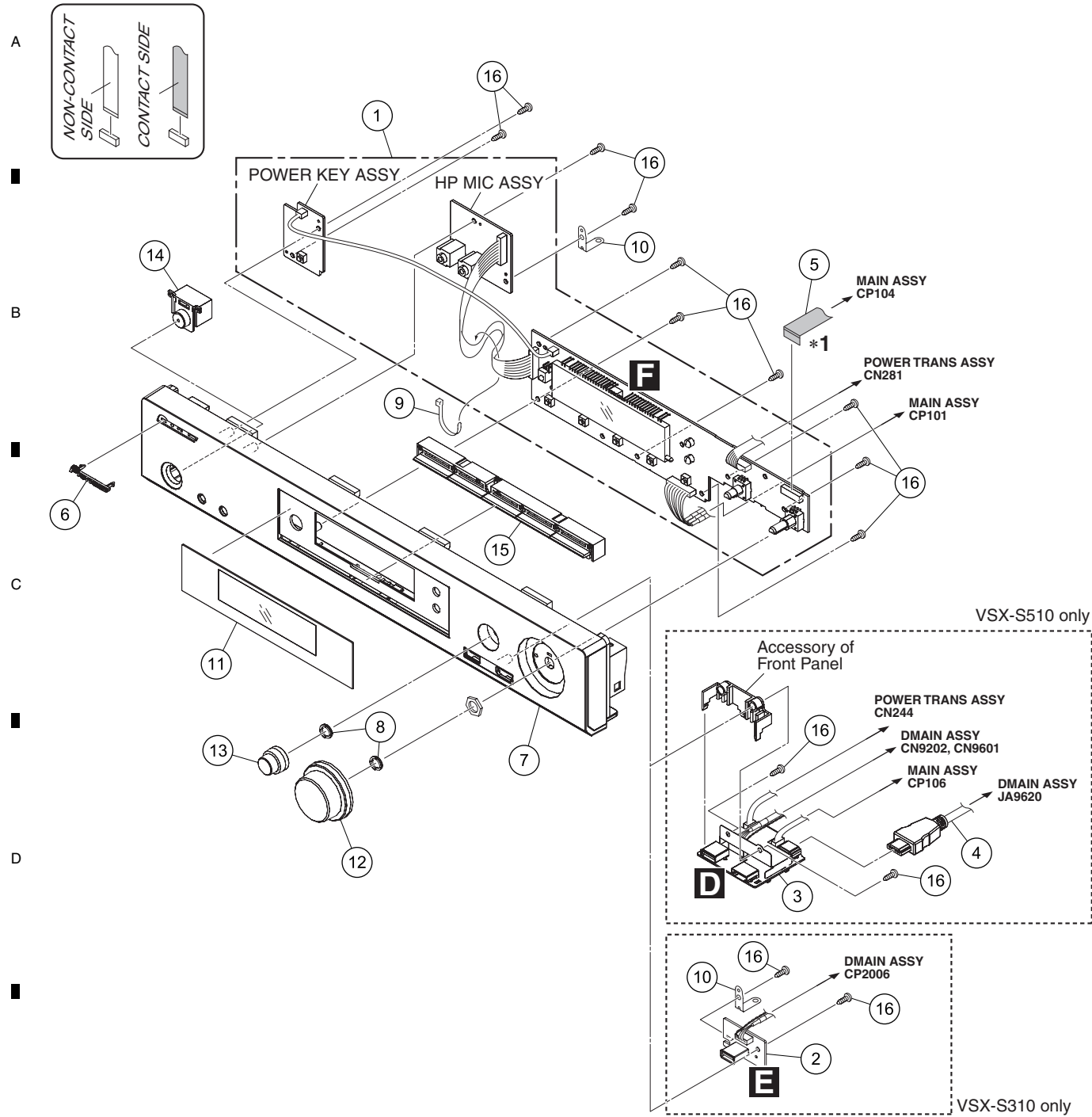

**Note \*1:** Connect the Cable Flat Card 1.0mm to the FRONT ASSY with the side reinforced by narrow tape.

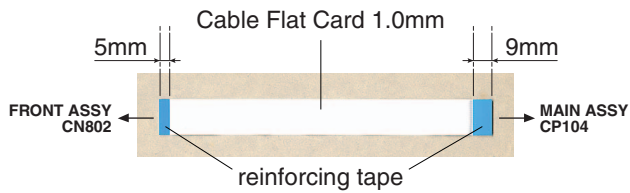

**(1) FRONT SECTION PARTS LIST**

<b>Mark No.</b>	<b>Description</b>	<b>Part No.</b>	<b>Mark No.</b>	<b>Description</b>	<b>Part No.</b>
1	FRONT ASSY	See Contrast table (2)	11	Window	See Contrast table (2)
2	USB ASSY	See Contrast table (2)	12	VOL Knob	See Contrast table (2)
3	FHDMI ASSY	See Contrast table (2)	13	Input Knob	See Contrast table (2)
4	Cable HDMI 360mm	See Contrast table (2)	14	Button	See Contrast table (2)
5	Cable Flat Card 1.0mm	N711151512180-IL	15	5Key Button	5090215311000-IL
6	Pioneer Badge	See Contrast table (2)	16	Screw	BBZ30P080FTC
7	Front Panel	See Contrast table (2)			
8	Spring	3720210276000-IL			
9	Clamp (Binder)	4330040343010-IL			
10	Plate	4470212856000-IL			

**(2) CONTRAST TABLE**

VSX-S510-K, VSX-S510-S, VSX-S310-K and VSX-S310-S are constructed the same except for the following:

<b>Mark No.</b>	<b>Symbol and Description</b>	<b>VSX-S510-K</b>	<b>VSX-S510-S</b>	<b>VSX-S310-K</b>	<b>VSX-S310-S</b>
1	FRONT ASSY	7028074121010-IL	7028074121010-IL	7028074121050-IL	7028074121050-IL
2	USB ASSY	Not used	Not used	7028074116050-IL	7028074116050-IL
3	FHDMI ASSY	7028074131010-IL	7028074131010-IL	Not used	Not used
4	Cable HDMI 360mm	L304361190050-IL	L304361190050-IL	Not used	Not used
6	Pioneer Badge	XAM3006	VAM1129	XAM3006	VAM1129
7	Front Panel	3067216041200-IL	3067216041300-IL	3067216041000-IL	3067216041100-IL
11	Window	5077213582010-IL	5077213582010-IL	5077213582000-IL	5077213582000-IL
12	VOL Knob	5080212811000-IL	5088212818000-IL	5080212811000-IL	5087212811100-IL
13	Input Knob	5080212821000-IL	5088212828000-IL	5080212821000-IL	5087212821100-IL
14	Button	5090213741100-IL	5097213741000-IL	5090213741100-IL	5097213741000-IL

# 10. SCHEMATIC DIAGRAM

## 10.1 MAIN ASSY (1/3)

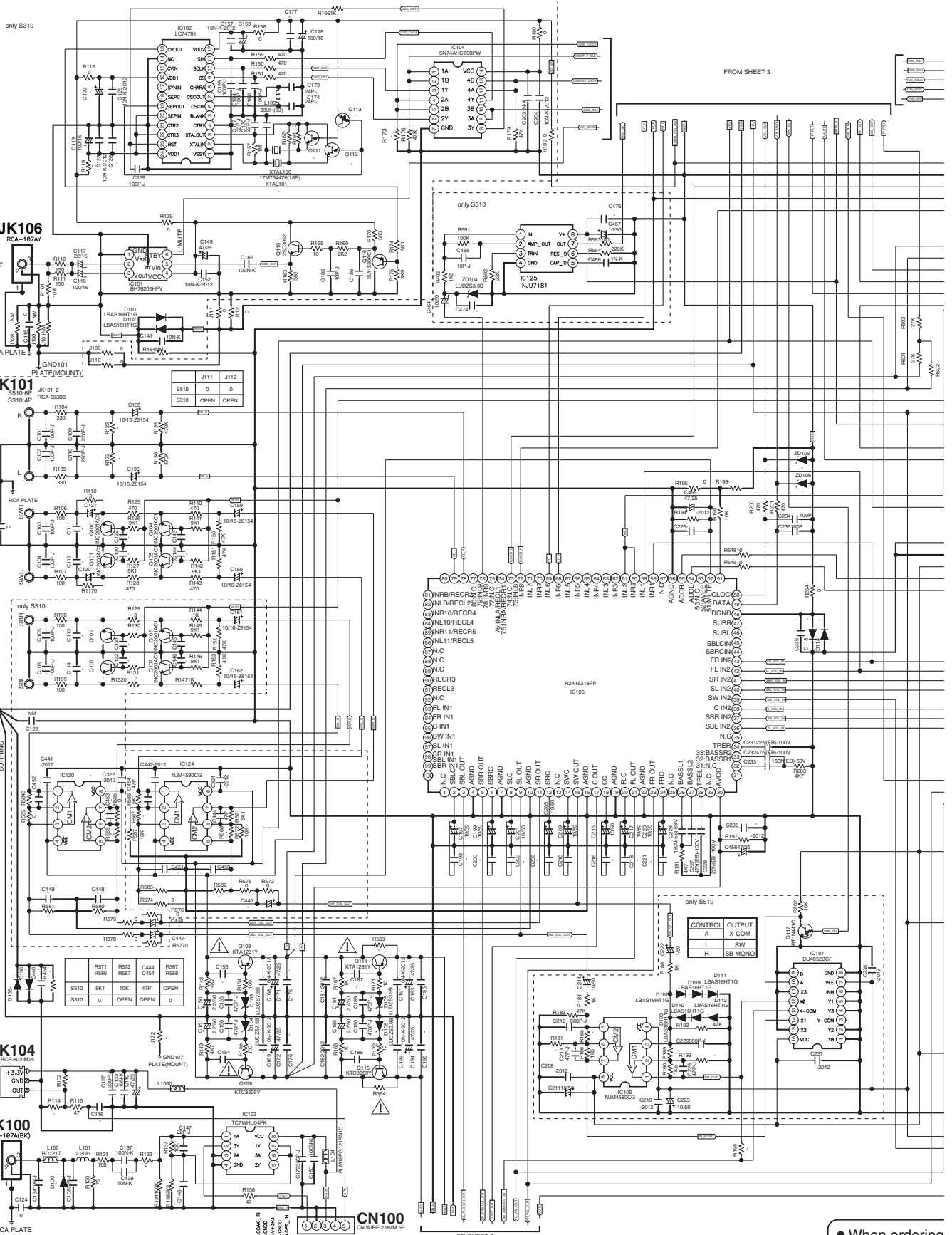

**B** 4/6 CN1802 (VSX-S510)  
**B** 1/3 CP2008 (VSX-S310)

**VSX-S510-K**

• When ordering  
 • The ⚠ mark is  
 Therefore, when

**A** 1/3



A  
B  
C  
D  
E  
F

**A/1/3 MAIN ASSY (1/3)**  
**(VSX-S510 : 7028074101010-IL)**  
**(VSX-S310 : 7028074101050-IL)**

The  mark found on some component parts indicates the importance of the safety factor of the part. Therefore when replacing be sure to use parts of identical designation

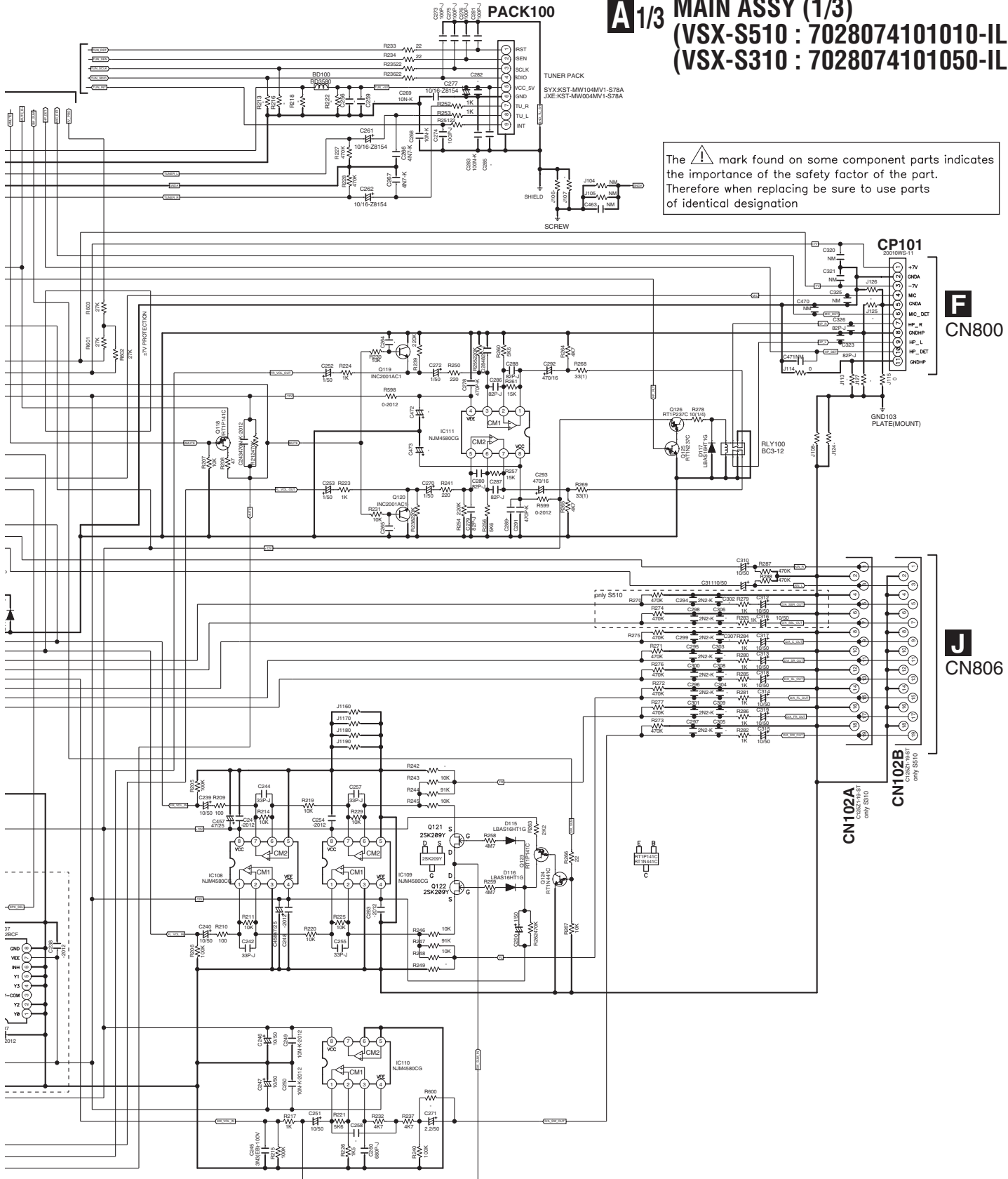

● When ordering service parts, be sure to refer to "EXPLODED VIEWS and PARTS LIST" or "PCB PARTS LIST".  
 ● The  mark found on some component parts indicates the importance of the safety factor of the part. Therefore, when replacing, be sure to use parts of identical designation.

# 10.2 MAIN ASSY (2/3)

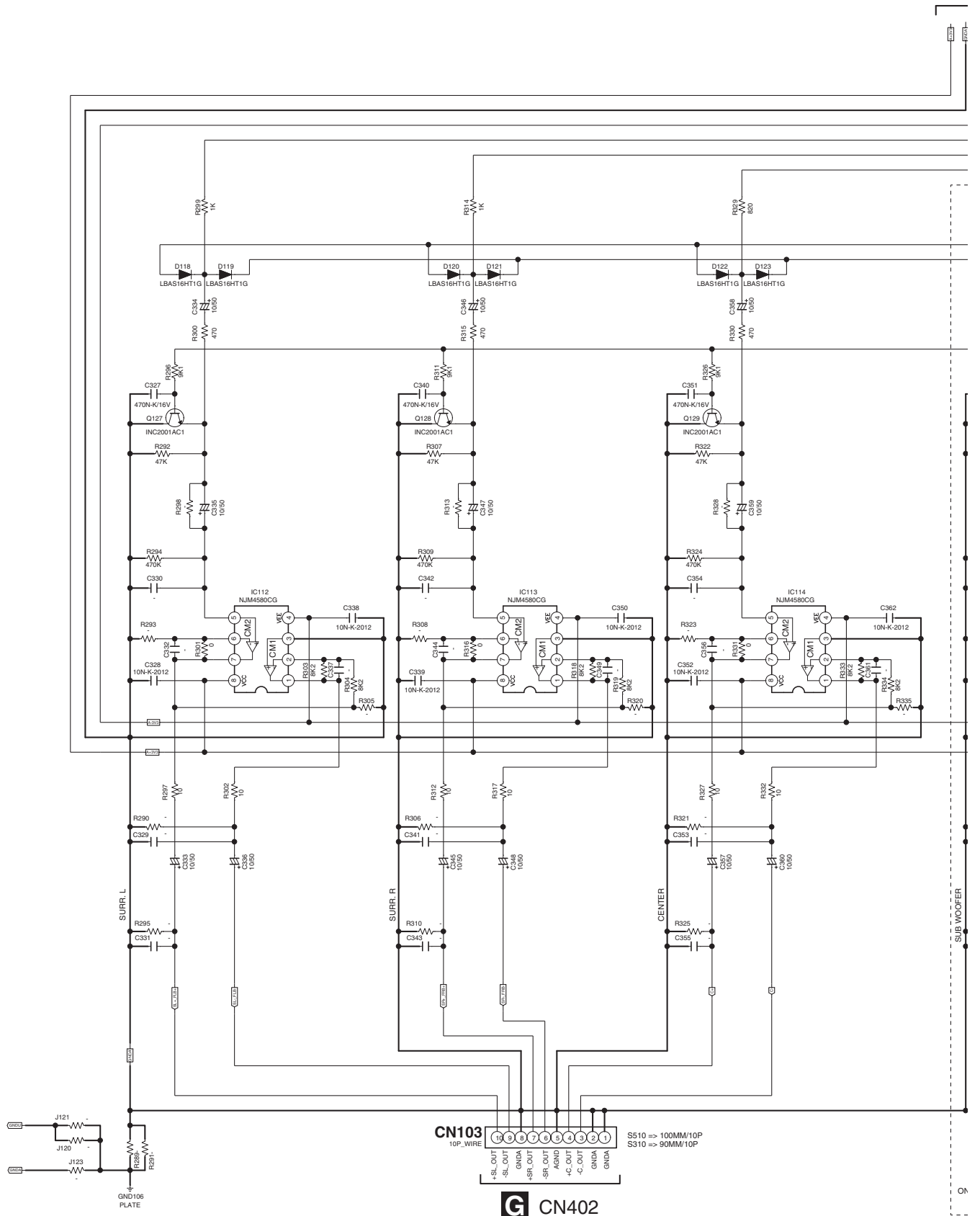

CN103  
10P\_WIRE

G CN402

# A2/3 MAIN ASSY (2/3)

(VSX-S510 : 7028074101010-IL)  
 (VSX-S310 : 7028074101050-IL)

The  mark found on some component parts indicates the importance of the safety factor of the part. Therefore when replacing be sure to use parts of identical designation

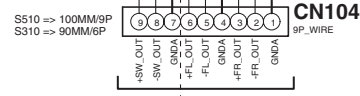
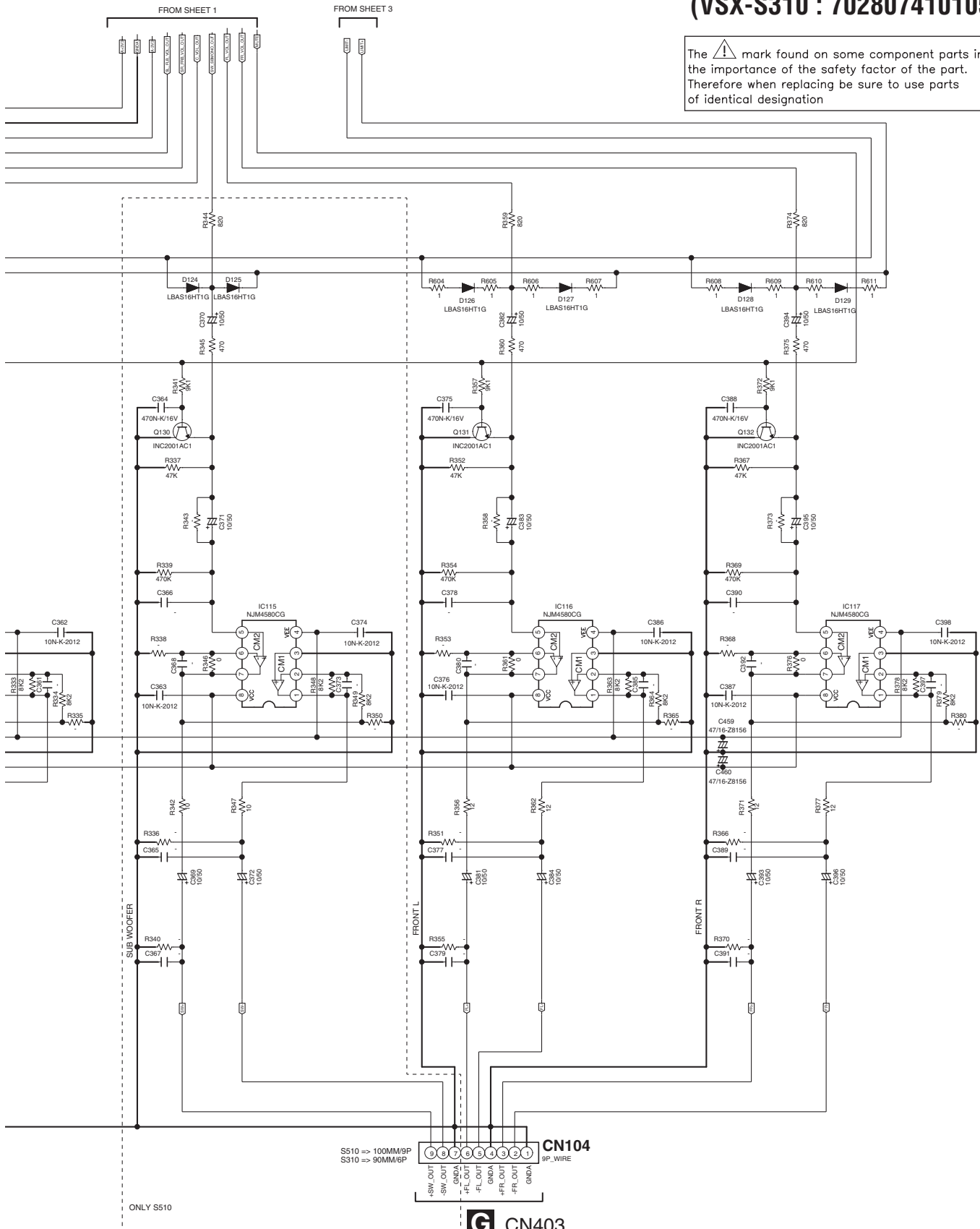

**G** CN403

VSX-S510-K

# 10.3 MAIN ASSY (3/3)

A  
B  
C  
D  
E  
F

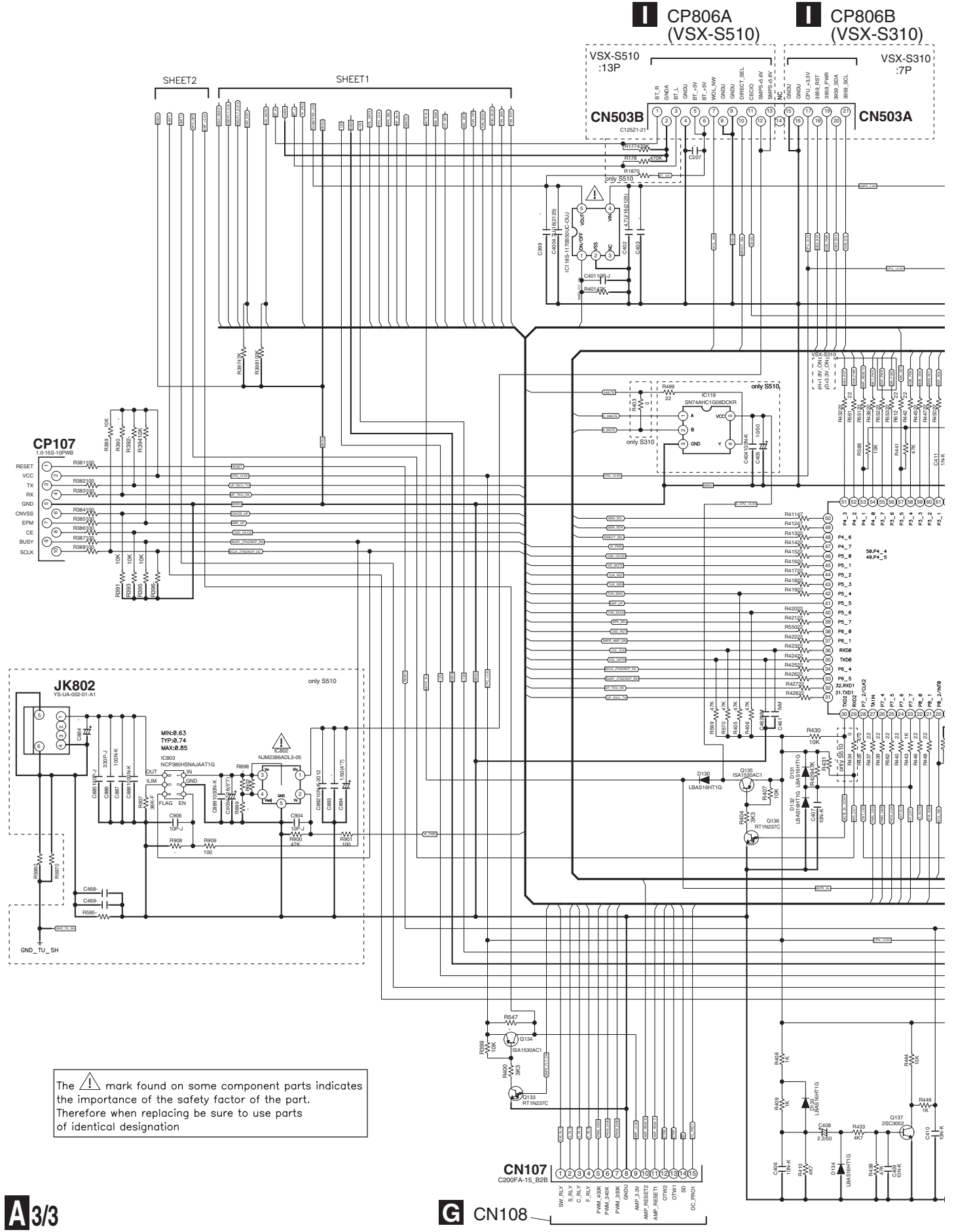

The mark found on some component parts indicates the importance of the safety factor of the part. Therefore when replacing be sure to use parts of identical designation

1

2

3

4

### CP806B (VSX-S310)

### CP807

# A 3/3 MAIN ASSY (3/3) (VSX-S510 : 7028074101010-IL) (VSX-S310 : 7028074101050-IL)

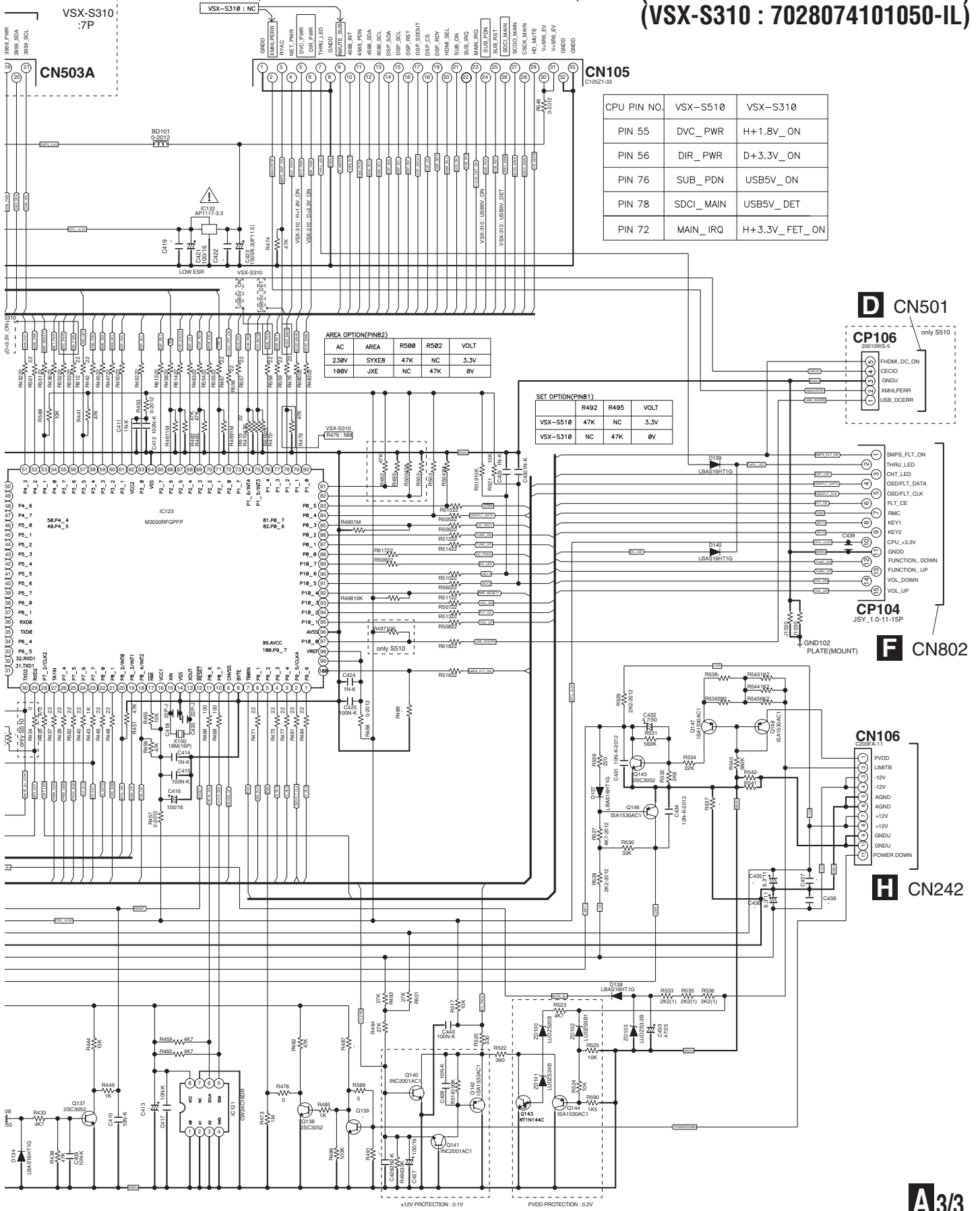

**CN105**  
C15271-33

CPU PIN NO.	VSX-S510	VSX-S310
PIN 55	DVC_PWR	H+1.8V_ON
PIN 56	DIR_PWR	D+3.3V_ON
PIN 76	SUB_PDN	USB5V_ON
PIN 78	SDCI_MAIN	USB5V_DET
PIN 72	MAIN_IRQ	H+3.3V_FET_ON

**AREA OPTION(PIN82)**

AC	AREA	R500	R502	VOLT
230V	SYXEB	47K	NC	3.3V
100V	JXE	NC	47K	0V

**SET OPTION(PIN81)**

	R492	R495	VOLT
VSX-S510	47K	NC	3.3V
VSX-S310	NC	47K	0V

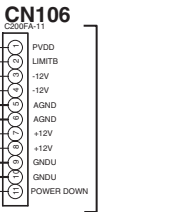
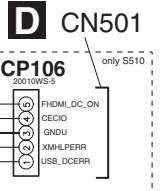



# B<sup>1/6</sup> DMAIN ASSY (1/6) (VSX-S510 : 70280732310C0-IL) A

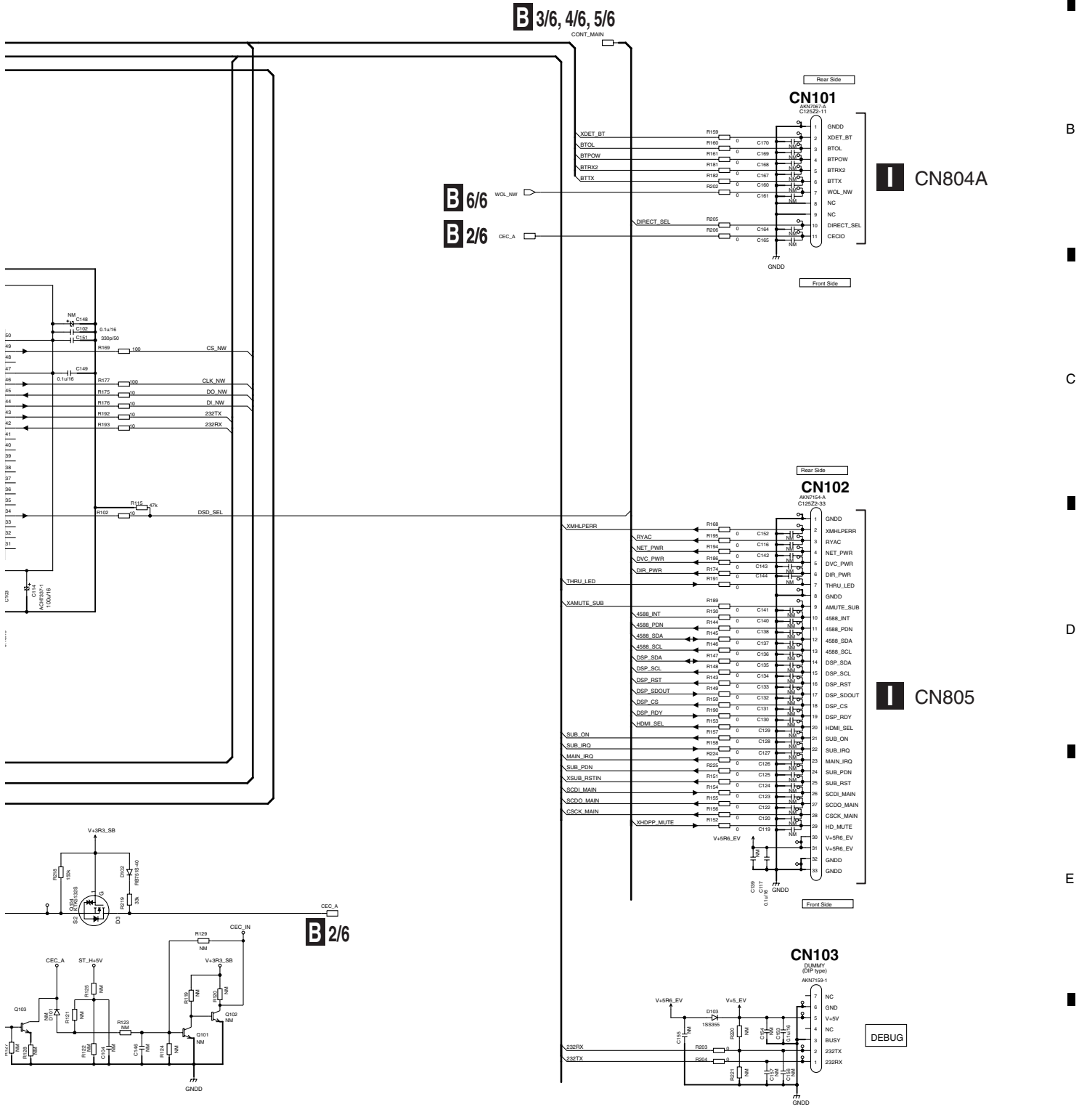

B

C

D

E

F

# 10.5 DMAIN ASSY (2/6) (VSX-S510)

1 2 3 4

A  
B  
C  
D  
E  
F

**JA9601**

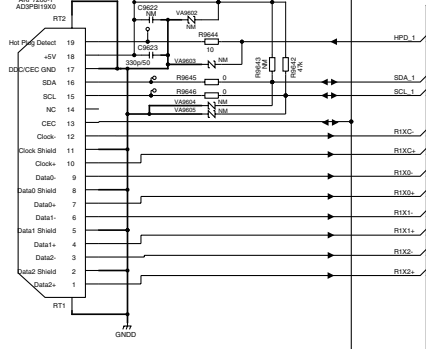

**JA9603**

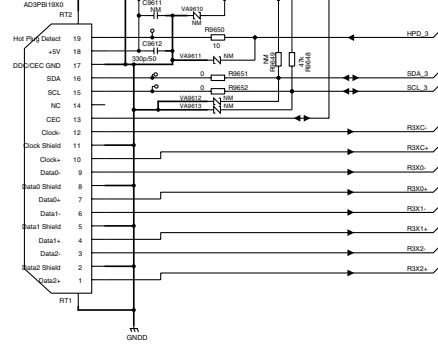

**JA9602**

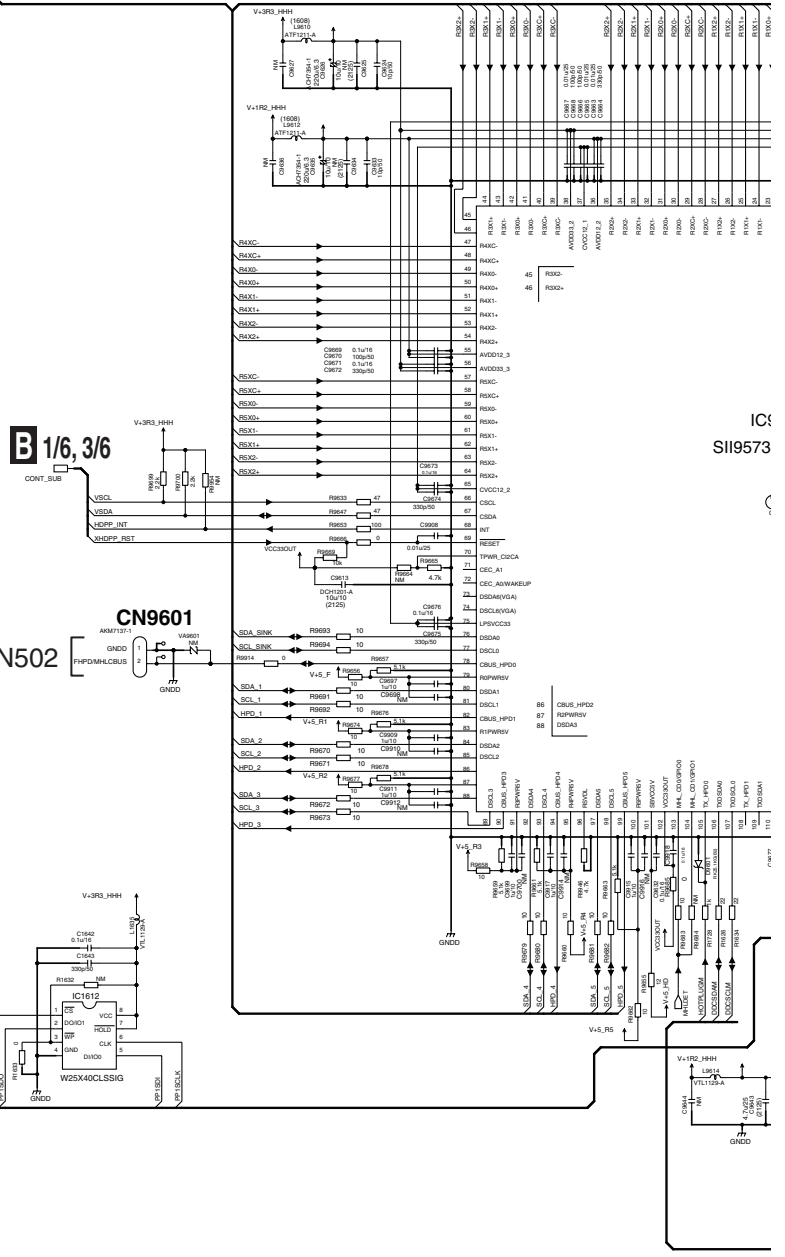
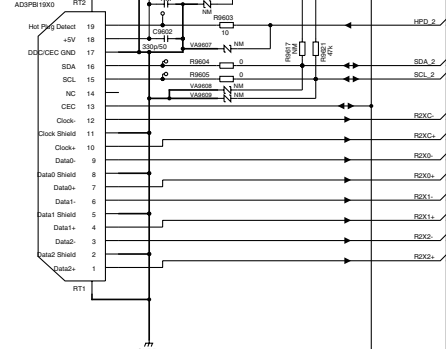

**B** 1/6, 3/6

**D** CN502

**CN9601**

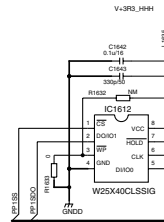

**B** 2/6

VSX-S510-K

1 2 3 4



# B<sup>2/6</sup> DMAIN ASSY (2/6) (VSX-S510 : 70280732310C0-IL)

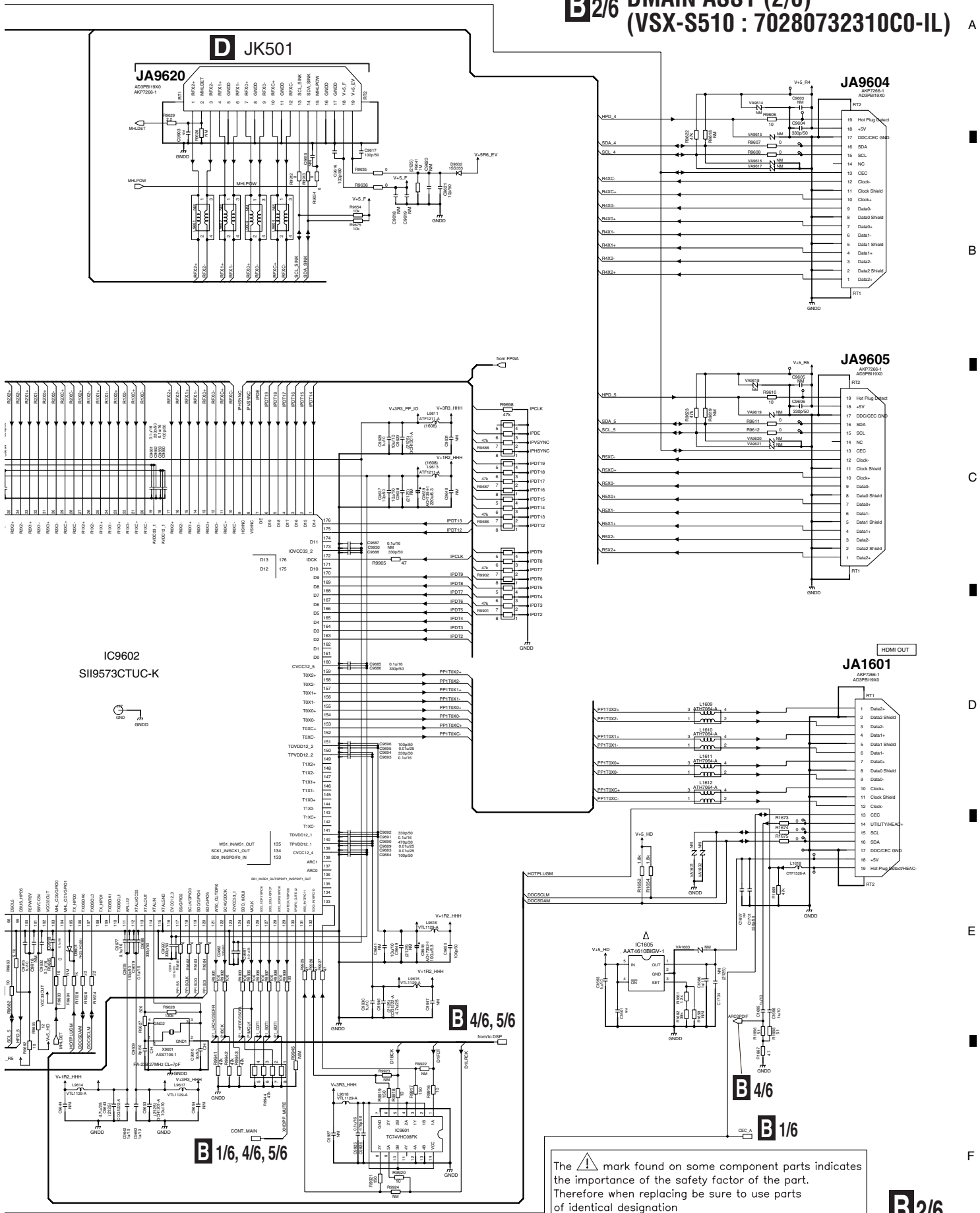

The **!** mark found on some component parts indicates the importance of the safety factor of the part. Therefore when replacing be sure to use parts of identical designation

# 10.6 DMAIN ASSY (3/6) (VSX-S510)

1 2 3 4

A  
B  
C  
D  
E  
F

**H** CN243

**CN9501**  
AKM7156-1

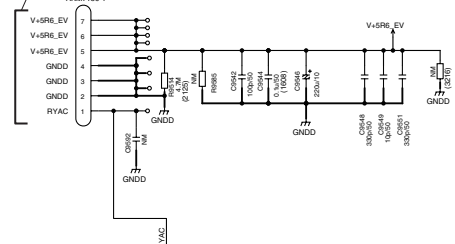

The mark found on some component parts indicates the importance of the safety factor of the part. Therefore when replacing be sure to use parts of identical designation

All 1u/10 is DCH1246-A.

**B** 1/6, 4/6, 5/6

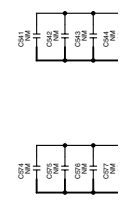
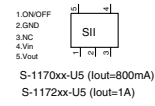
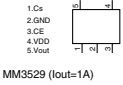
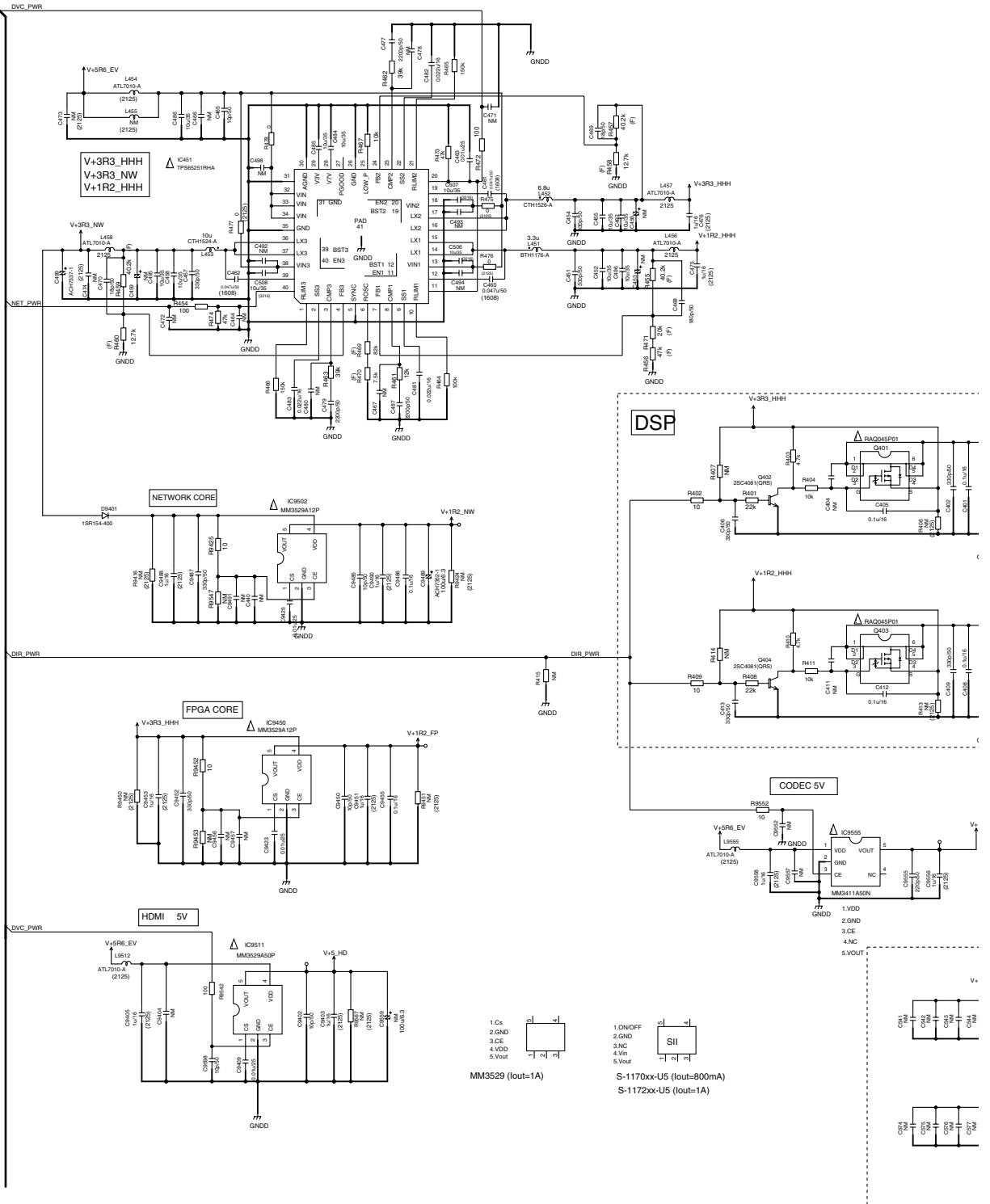

**B** 3/6

VSX-S510-K

1 2 3 4

# B3/6 DMAIN ASSY (3/6) (VSX-S510 : 70280732310C0-IL)

ites

## B 6/6

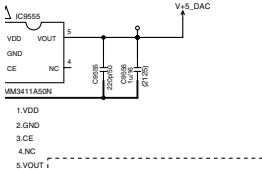
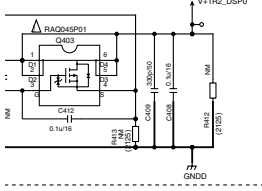
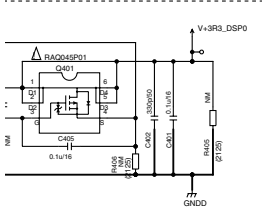
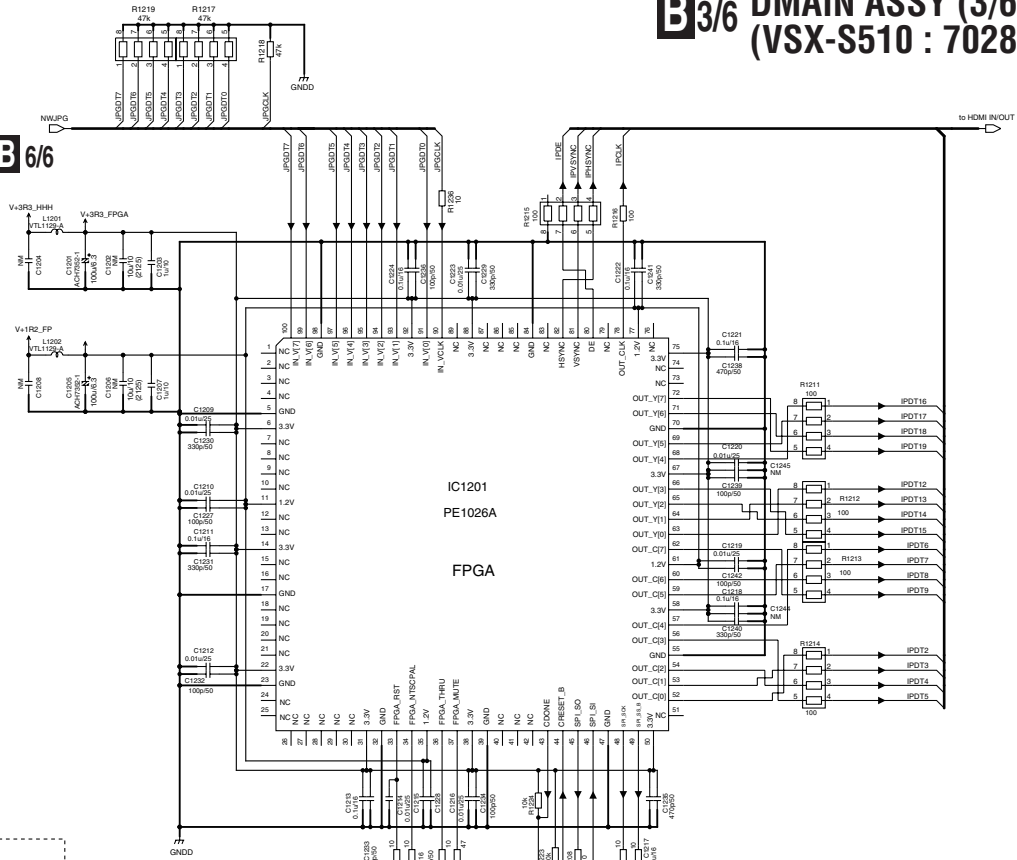

## B 1/6, 2/6

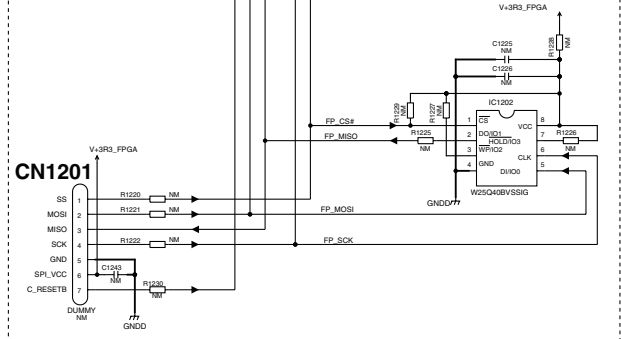

Proto Only

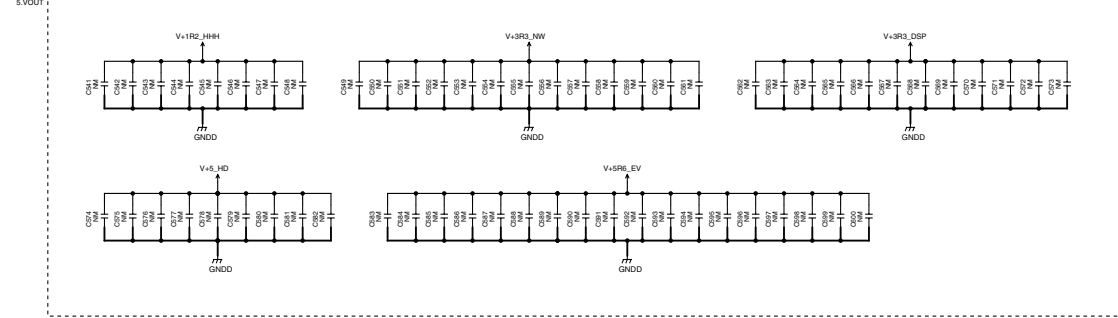

# 10.7 DMAIN ASSY (4/6) (VSX-S510)

1 2 3 4

A  
B  
C  
D  
E  
F

MASTER CLOCK SELECTOR

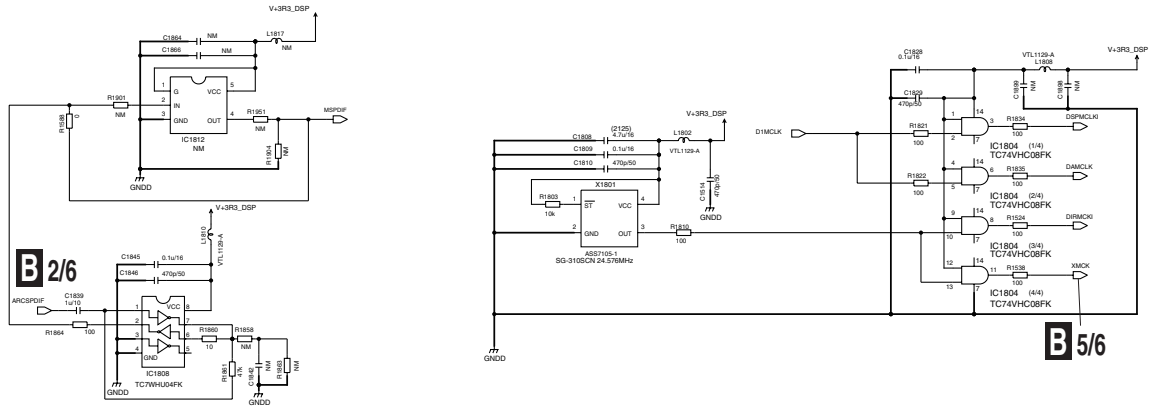

B 2/6

B 5/6

J CN802

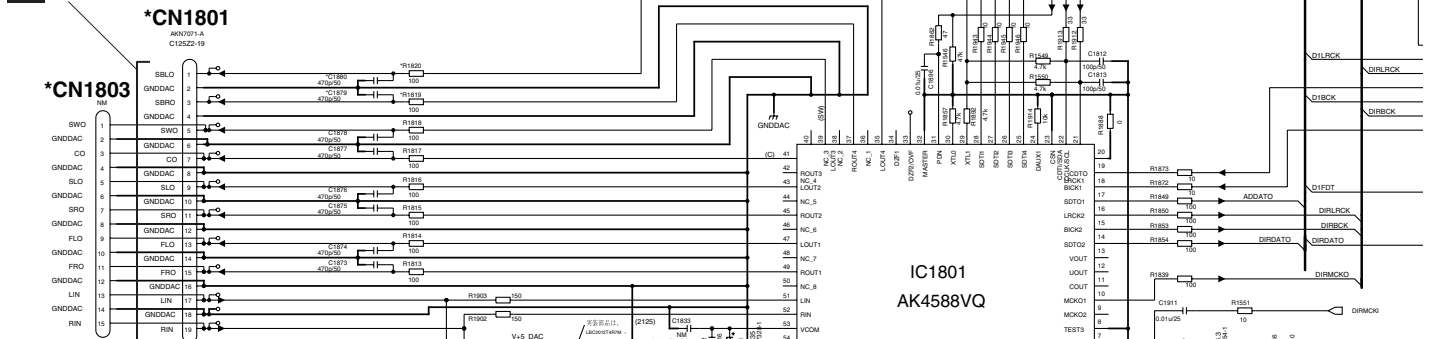

B 2/6, 5/6

B 1/6, 3/6, 5/6

IC1801  
AK4588VQ

CN1802

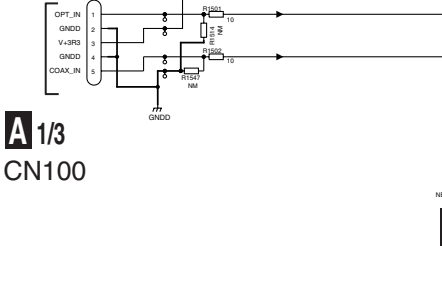

A 1/3  
CN100

B 6/6

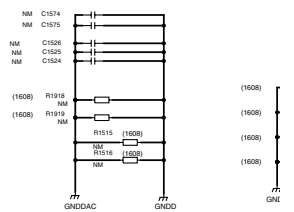

B 4/6

1 2 3 4

# B 4/6 DMAIN ASSY (4/6) (VSX-S510 : 70280732310C0-IL)

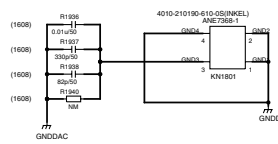
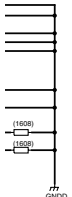
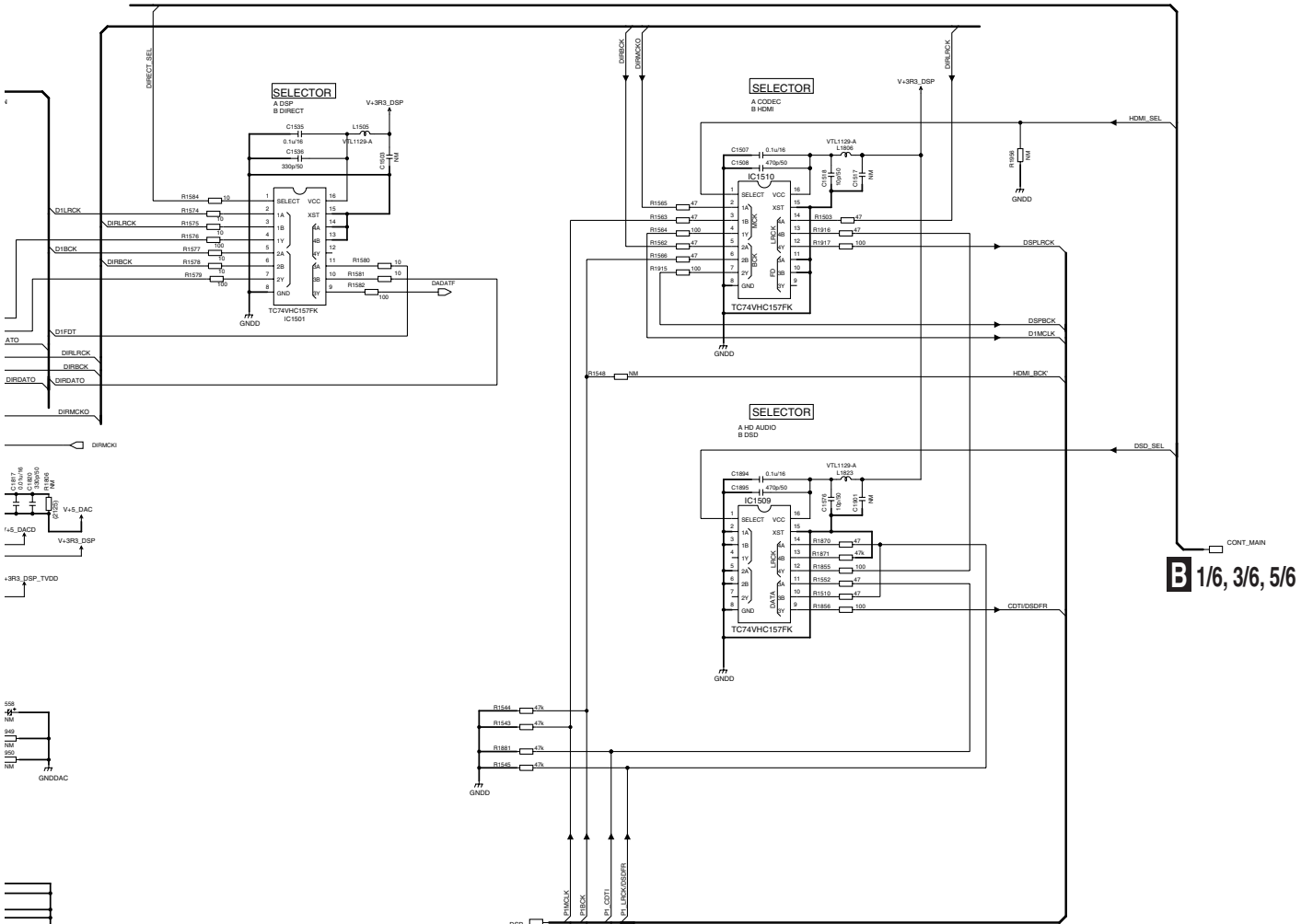
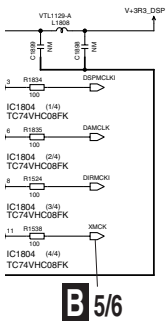

**B 2/6, 5/6**

HDMI PCM DATA		HDMI DSD DATA	
HFDI	FLFR	HFDI	FL
CDTI	C/SW	HDURCK	FR
SDTI	S/LSR		
BDTI	SEL_SBR		

VSX-S510-K

**B 4/6**

# 10.8 DMAIN ASSY (5/6) (VSX-S510)

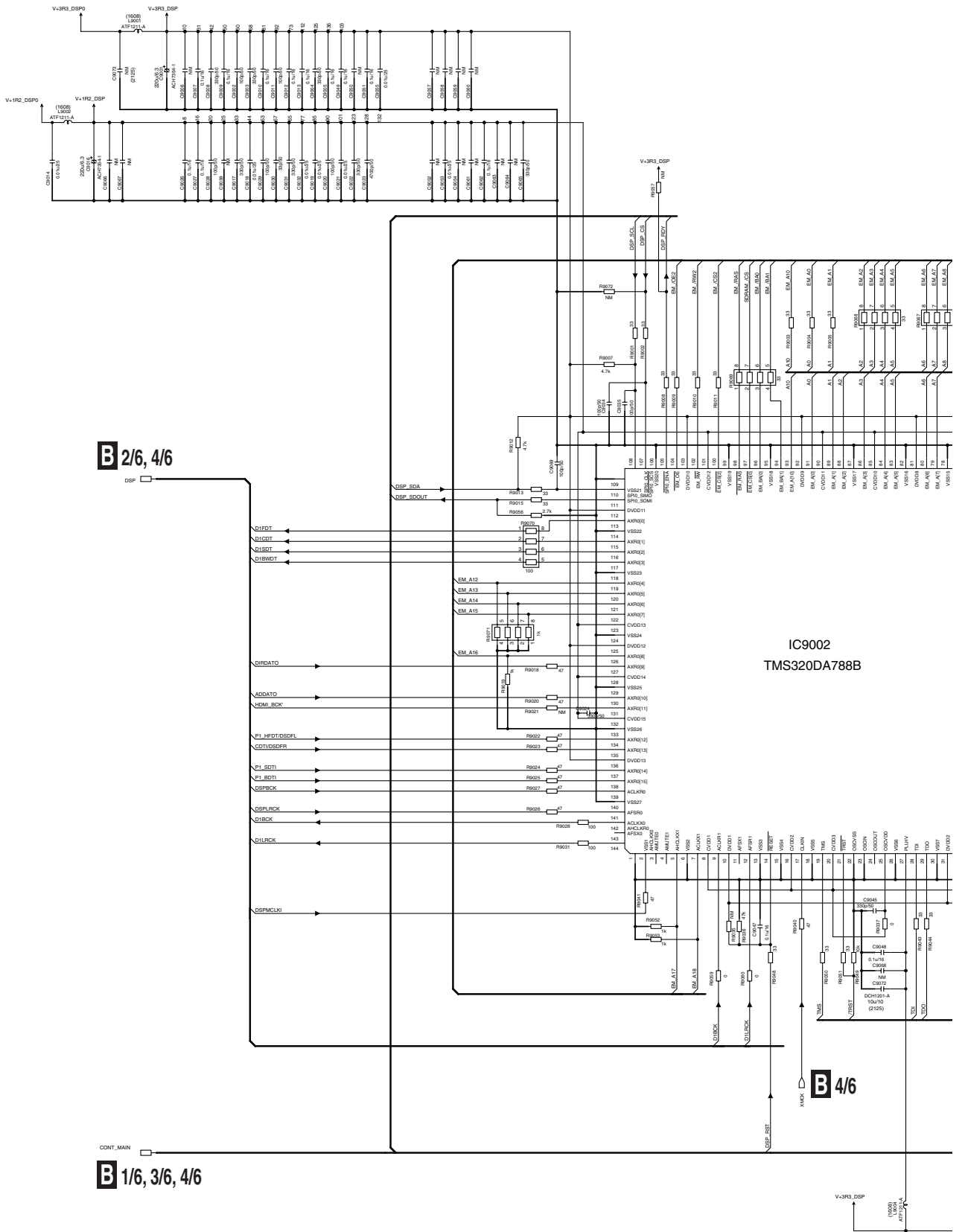

# B5/6 DMAIN ASSY (5/6) (VSX-S510 : 70280732310C0-IL) A

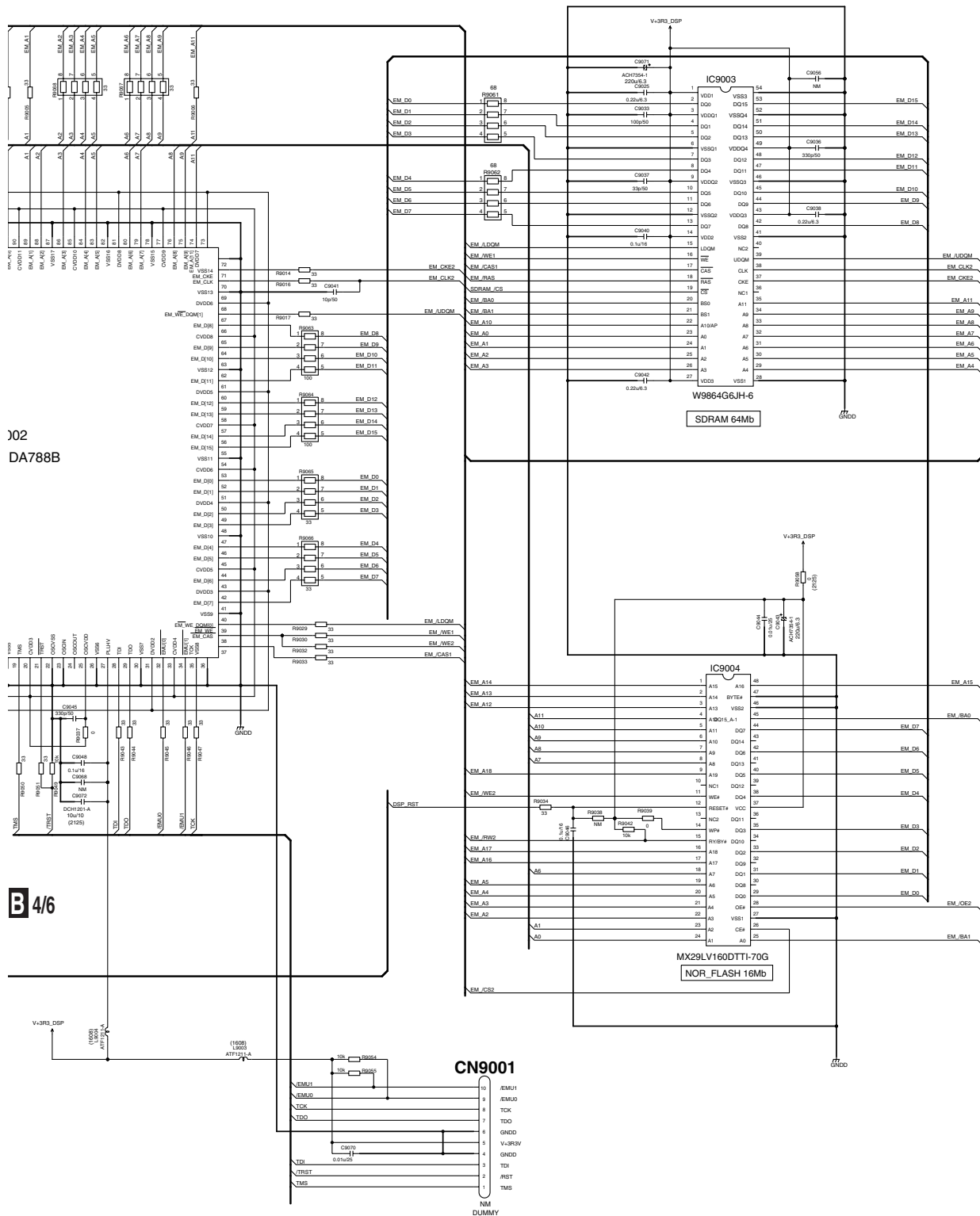

J02  
DA788B

B 4/6

# 10.9 DMAIN ASSY (6/6) (VSX-S510)

1

2

3

4

A

B

C

D

E

F

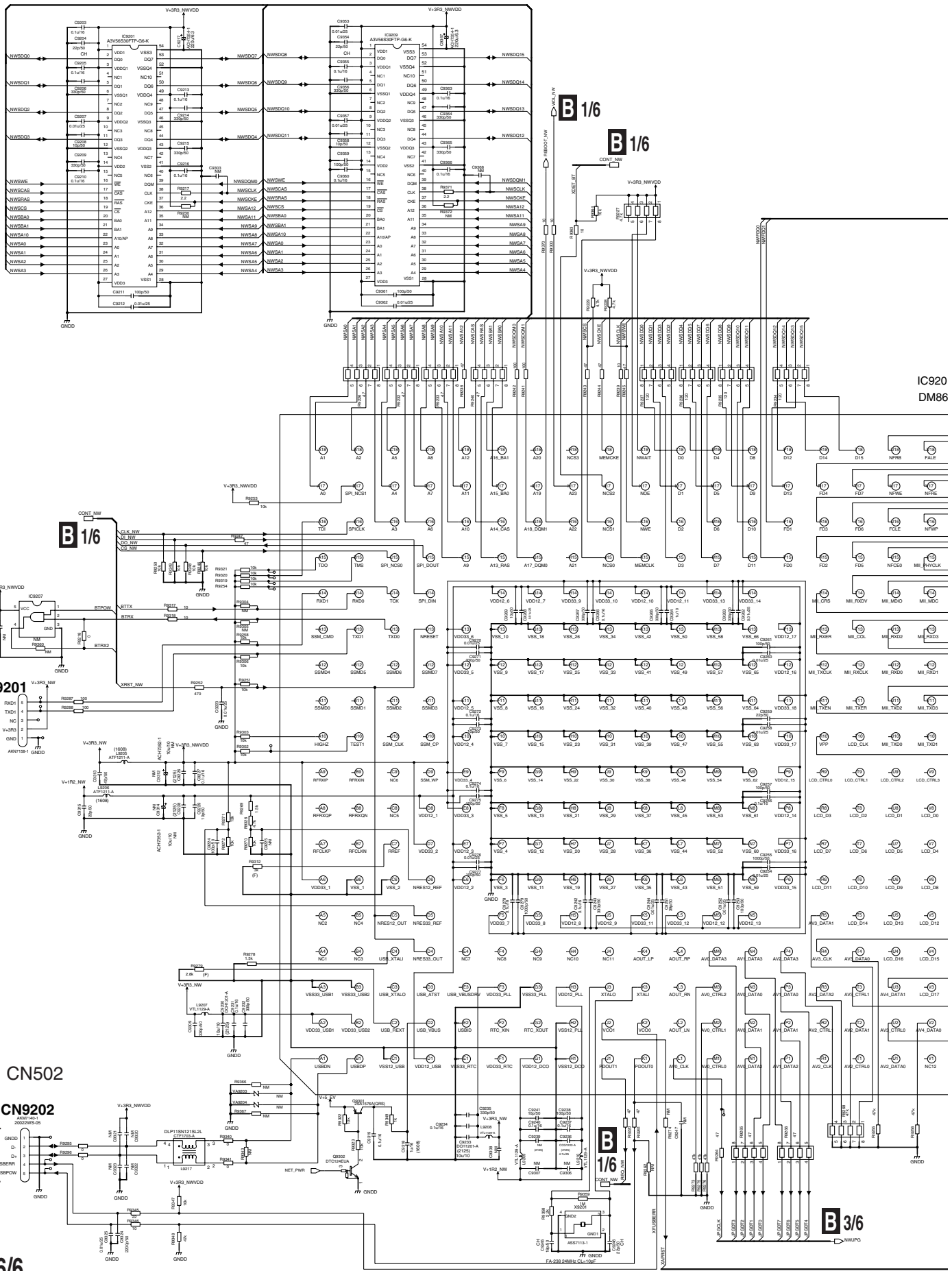

B 6/6

1

2

3

4



**B6/6** DMAIN ASSY (6/6)  
(VSX-S510 : 70280732310C0-IL)

A  
B  
C  
D  
E  
F

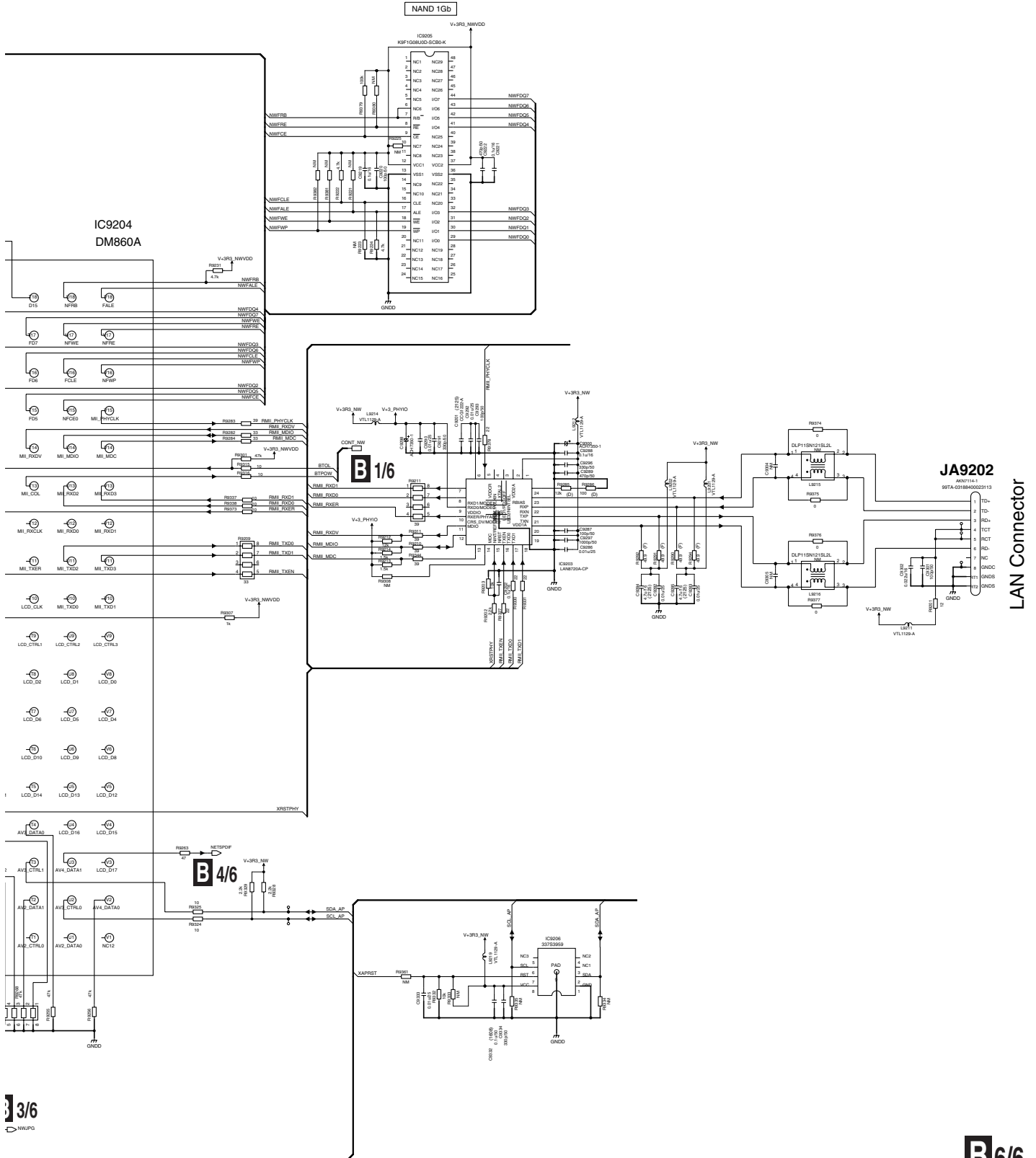

# 10.10 DMAIN ASSY (1/3) (VSX-S310)

A  
B  
C  
D  
E  
F

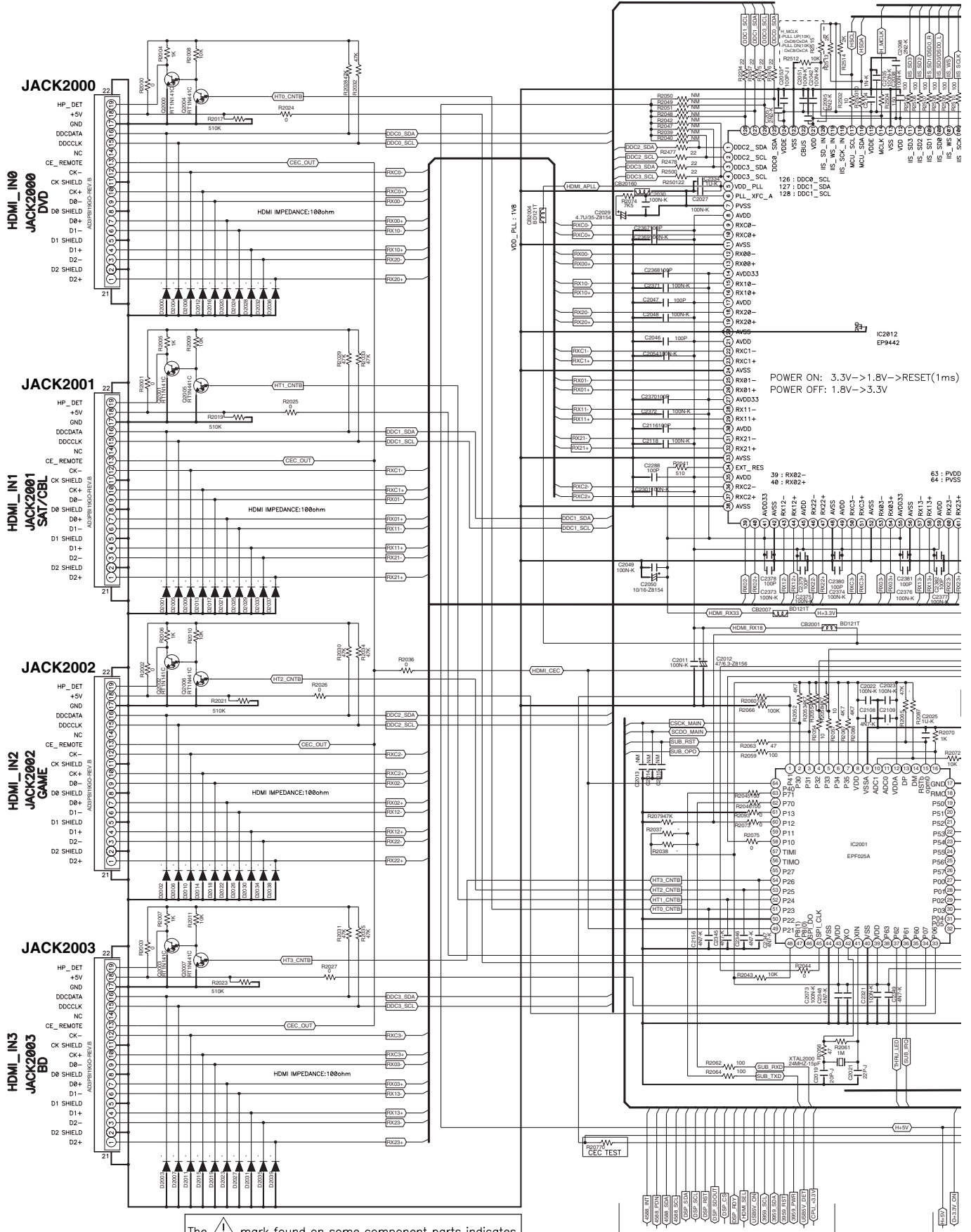

The ⚠ mark found on some component parts indicates the importance of the safety factor of the part. Therefore when replacing be sure to use parts of identical designation

1

2

3

4



# 10.11 DMAIN ASSY (2/3) (VSX-S310)

TO DMAIN\_1

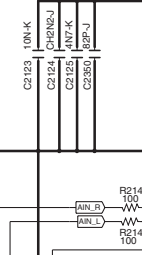
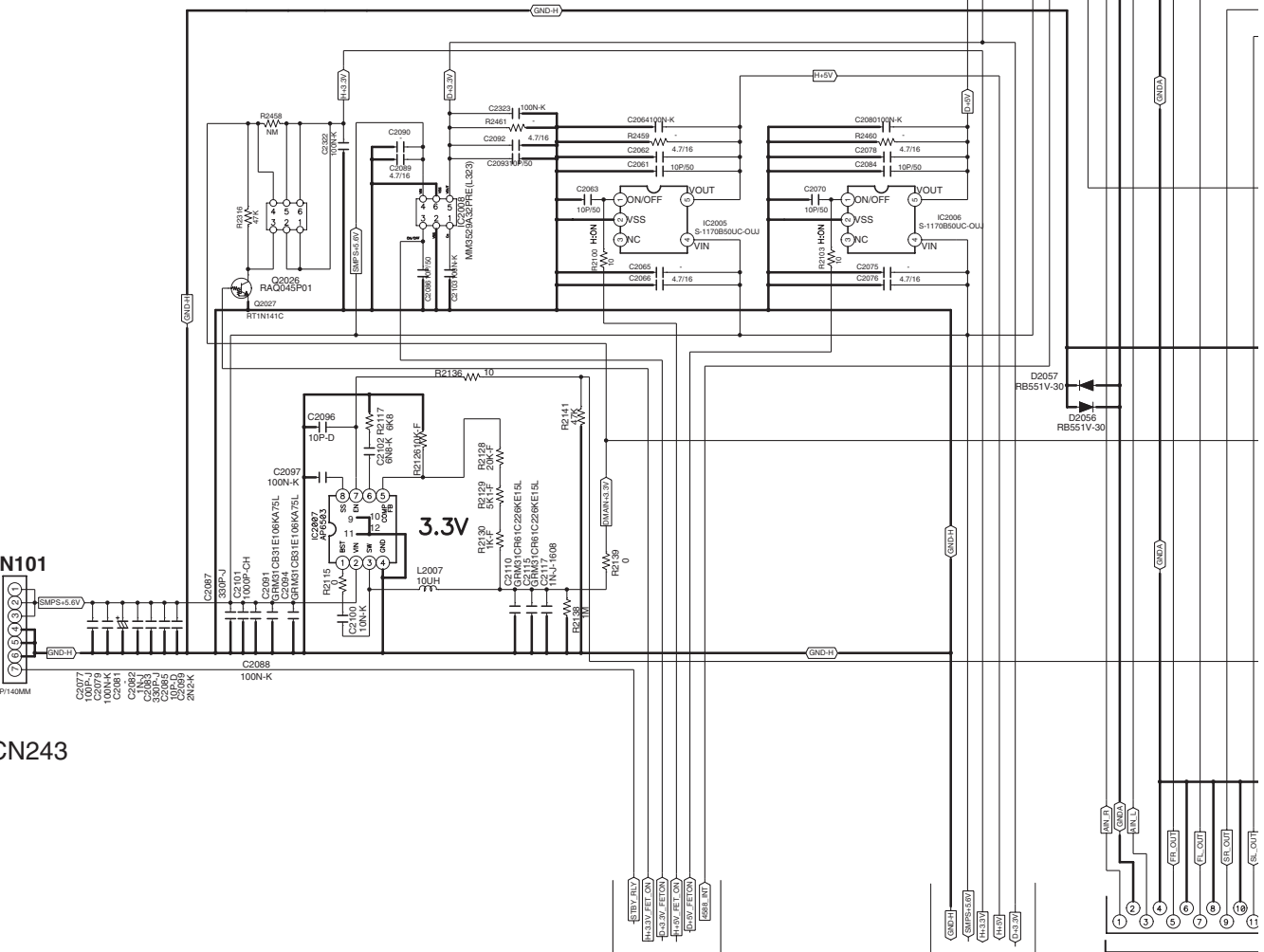

CN101

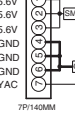

CN243

TO DMAIN\_1

TO DMAIN\_1

J C

# B2/3 DMAIN ASSY (2/3) (VSX-S310 : 7028073351090-IL)

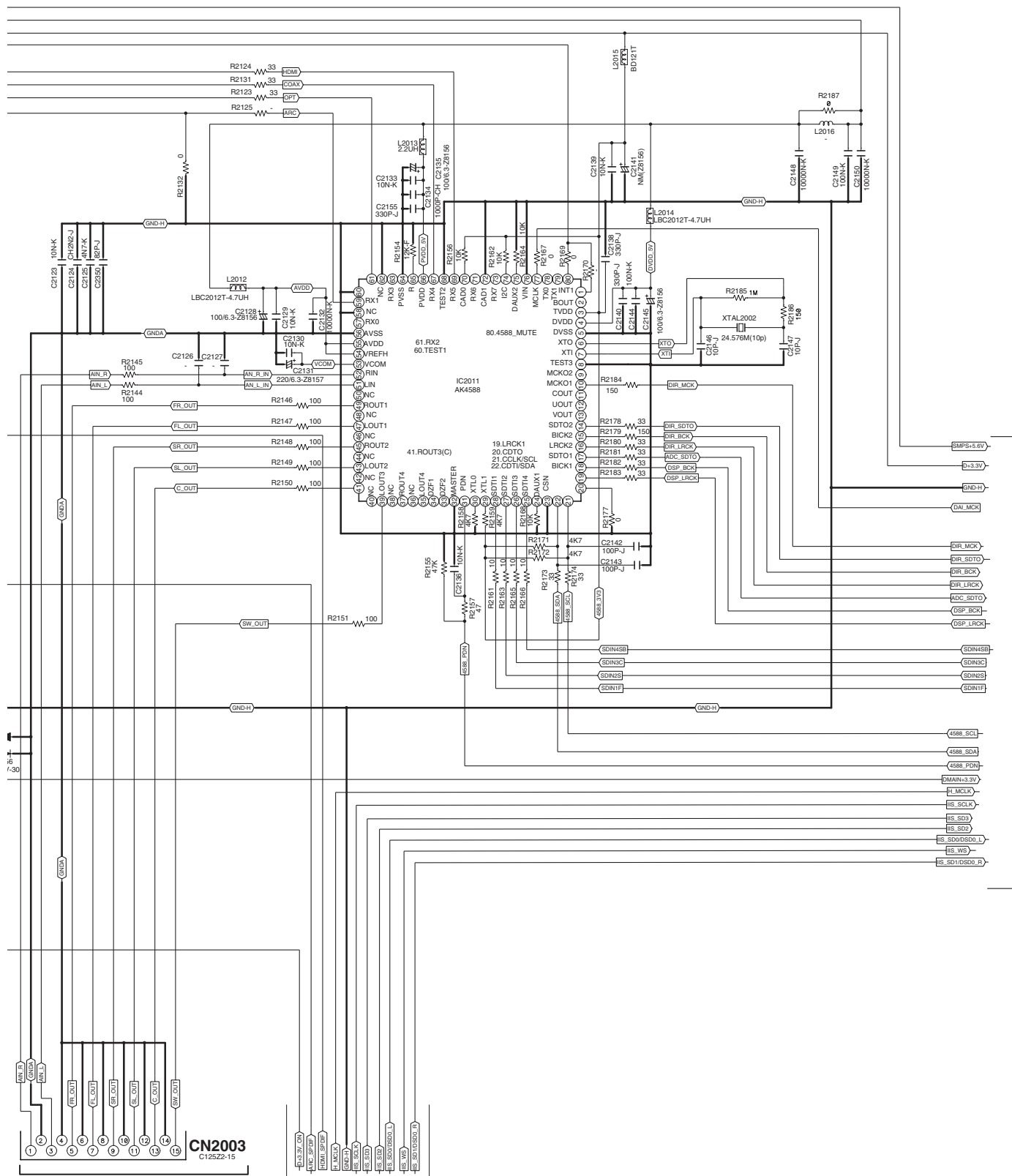

**J** CN802

FROM DMAIN\_1

TO DMAIN\_3

VSX-S510-K

**B2/3**

10.12 DMAIN ASSY (3/3) (VSX-S310)

B3/3 DMAIN ASSY (3/3) (VSX-S310 : 7028073351090-IL)

A B C D E F

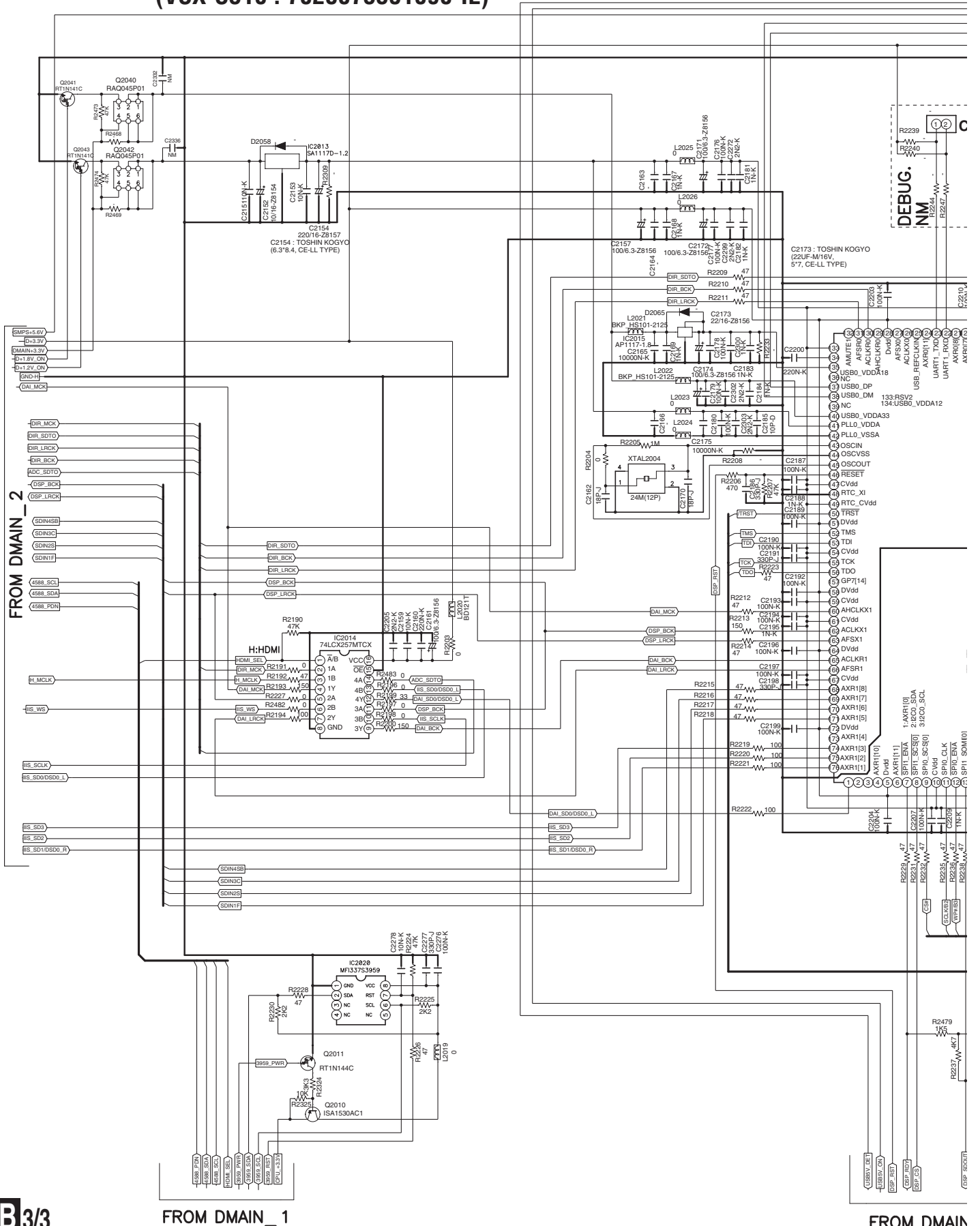

B3/3

FROM DMAIN\_1

FROM DMAIN

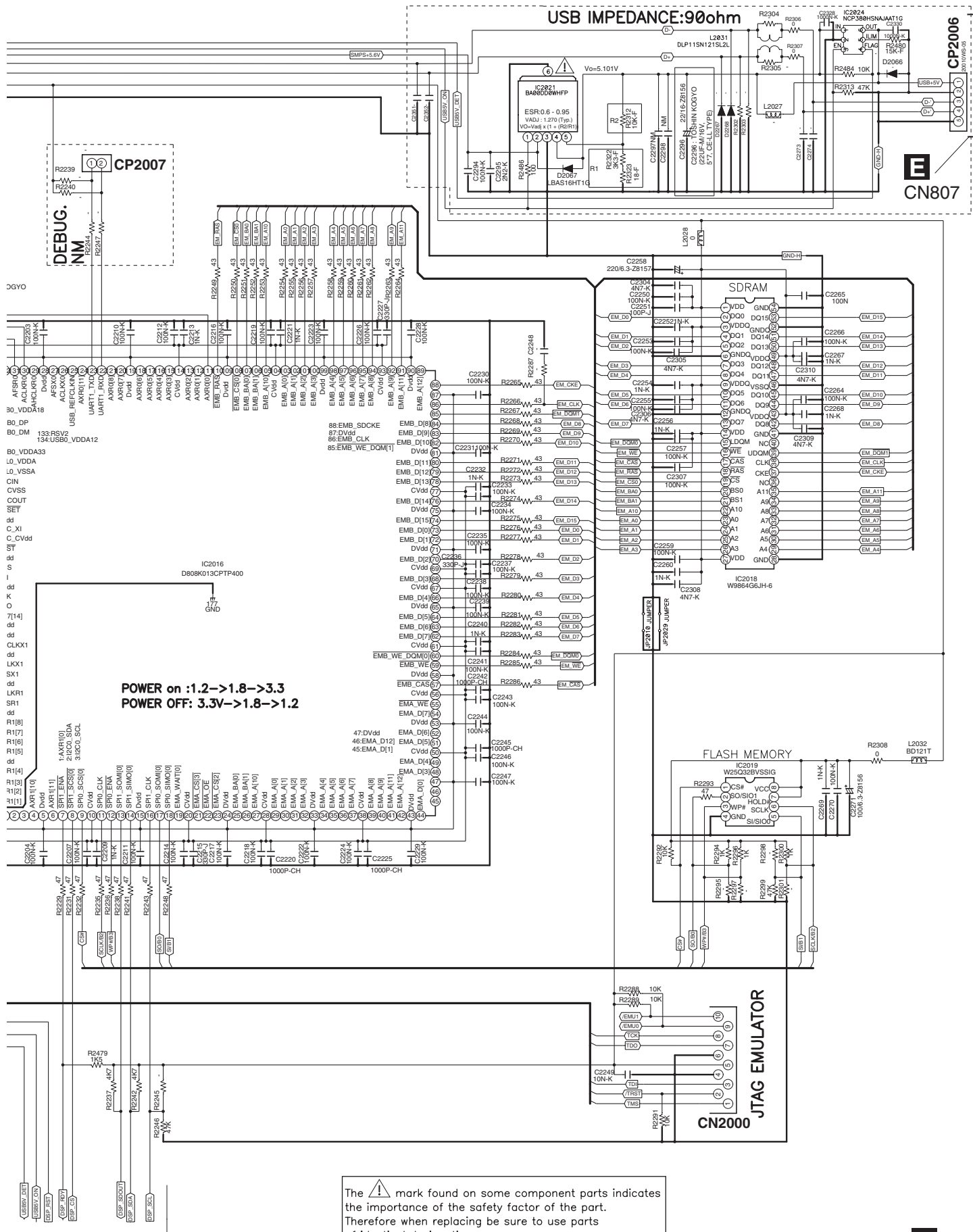

The mark found on some component parts indicates the importance of the safety factor of the part. Therefore when replacing be sure to use parts of identical designation

FROM DMAIN\_1

VSX-S510-K

# 10.13 BT ASSY

## C BT ASSY (VSX-S510 : 7028074112010-IL)

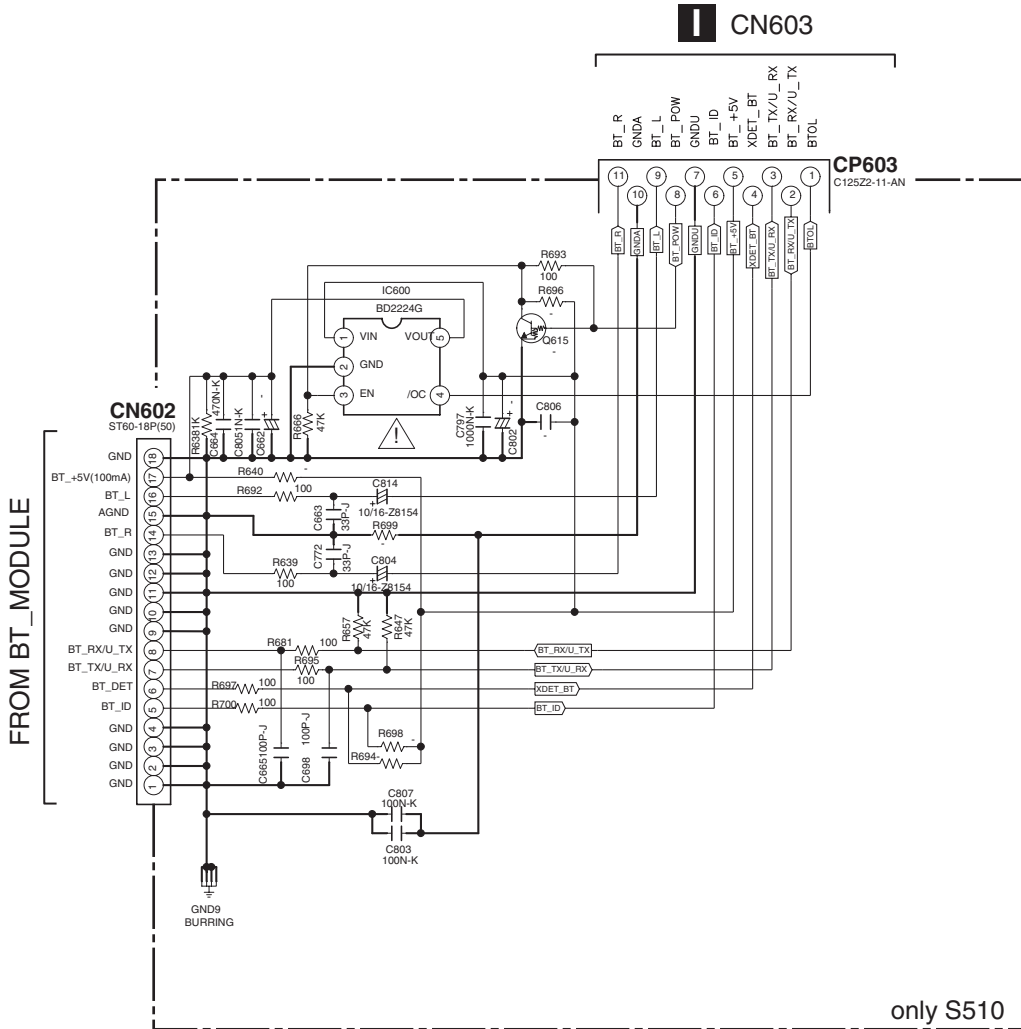





5



6



7



8



A



B



C



D



E



F



5



6

VSX-S510-K



7





8

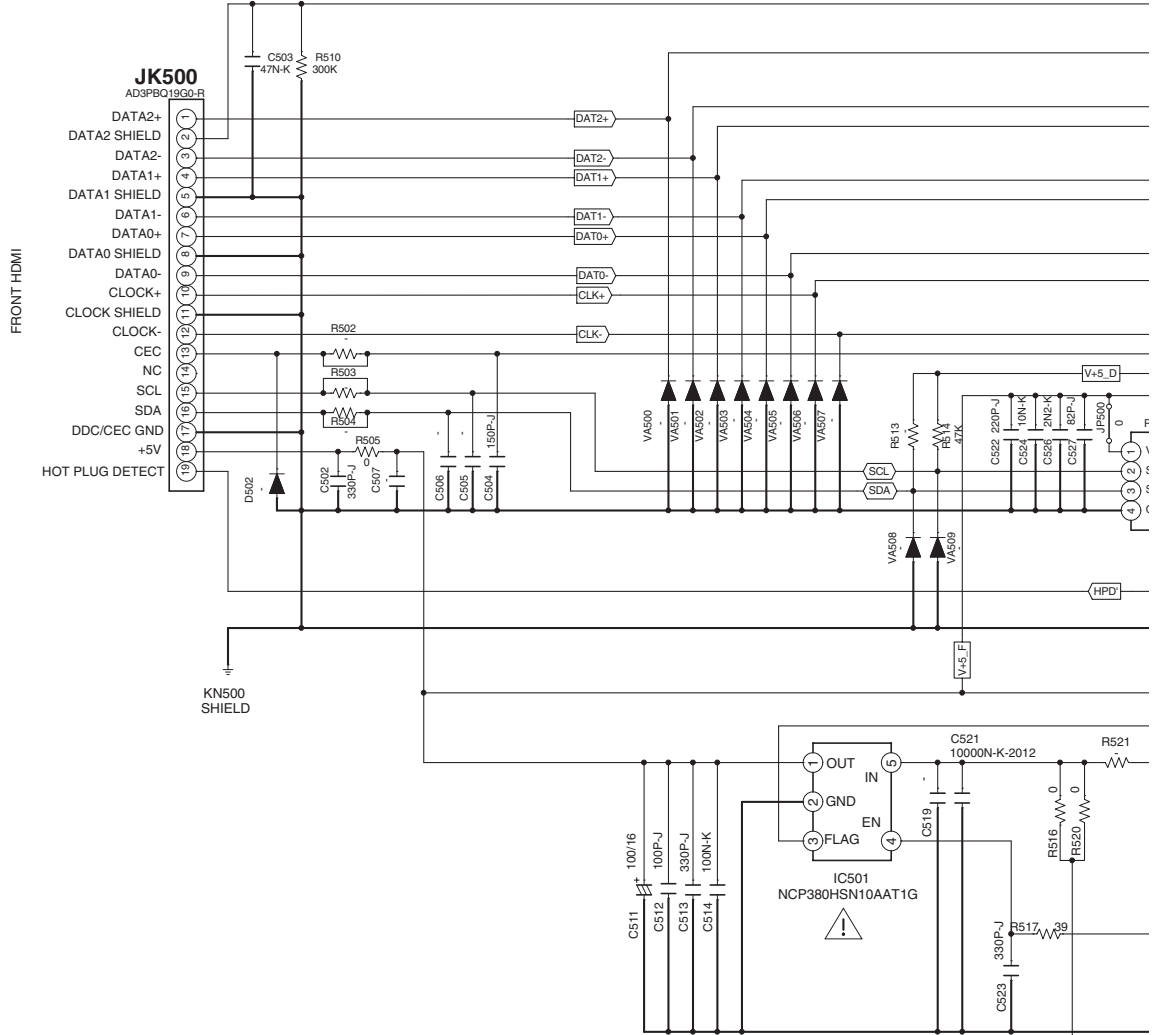

# 10.14 FHDMI ASSY

## F-HDMI (MHL)



The  mark found on some component parts indicates the importance of the safety factor of the part. Therefore when replacing be sure to use parts of identical designation

## FY14 F-USB

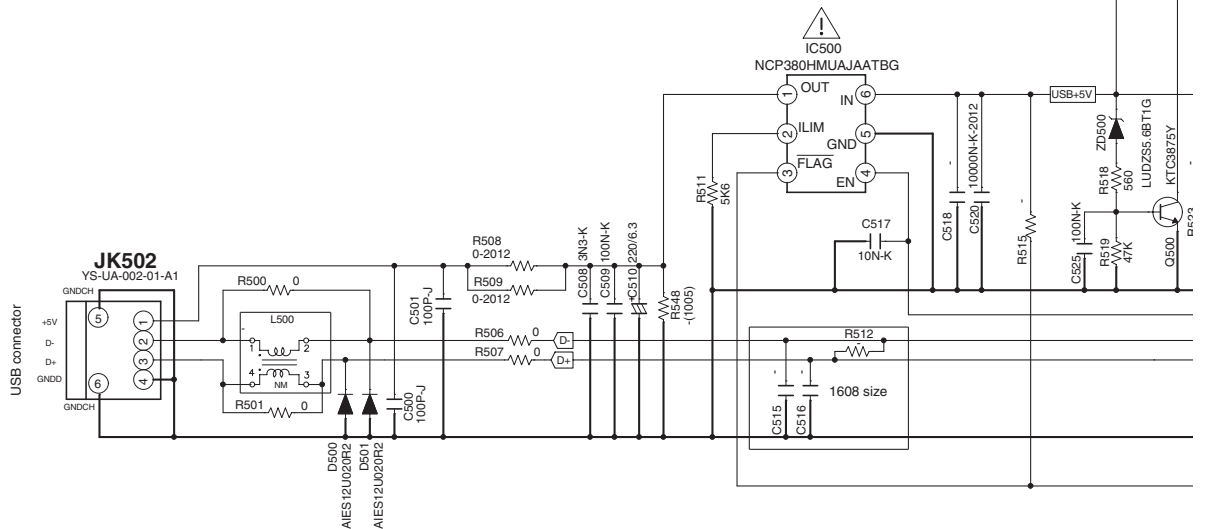

**D** FHDMI ASSY  
(VSX-S510 : 7028074131010-IL)

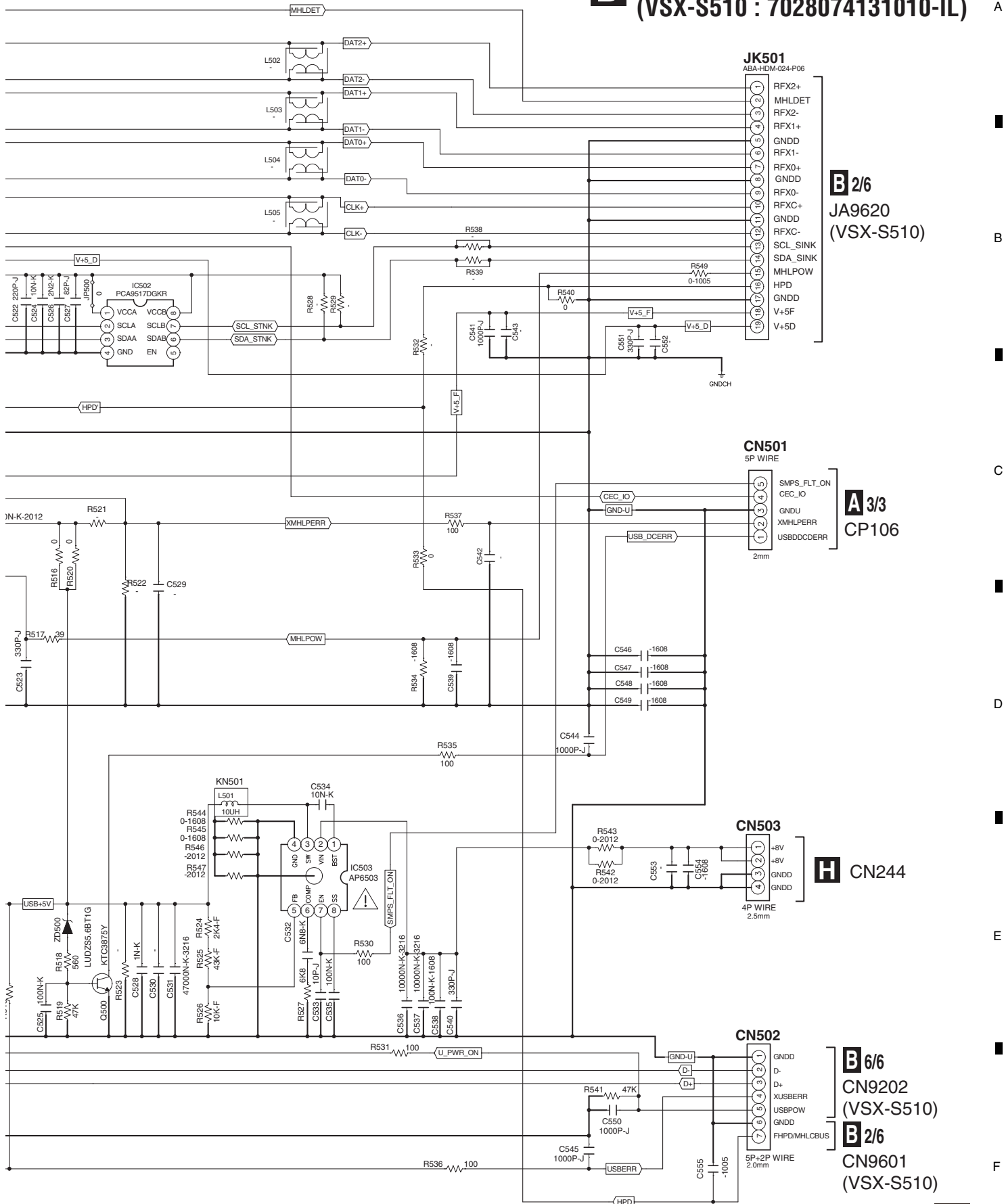

**B** 2/6  
JA9620  
(VSX-S510)

**A** 3/3  
CP106

**H** CN244

**B** 6/6  
CN9202  
(VSX-S510)  
**B** 2/6  
CN9601  
(VSX-S510)

# 10.15 USB ASSY and FRONT ASSY

## FRONT ASSY

OPTION		
R_NO	VSX-S510	VSX-
LED 806,801 (LED806A,801A)	KD-32CNBLE-ZD (BLUE)	HL-58 RED 5F
R853, R854	338-J	398-

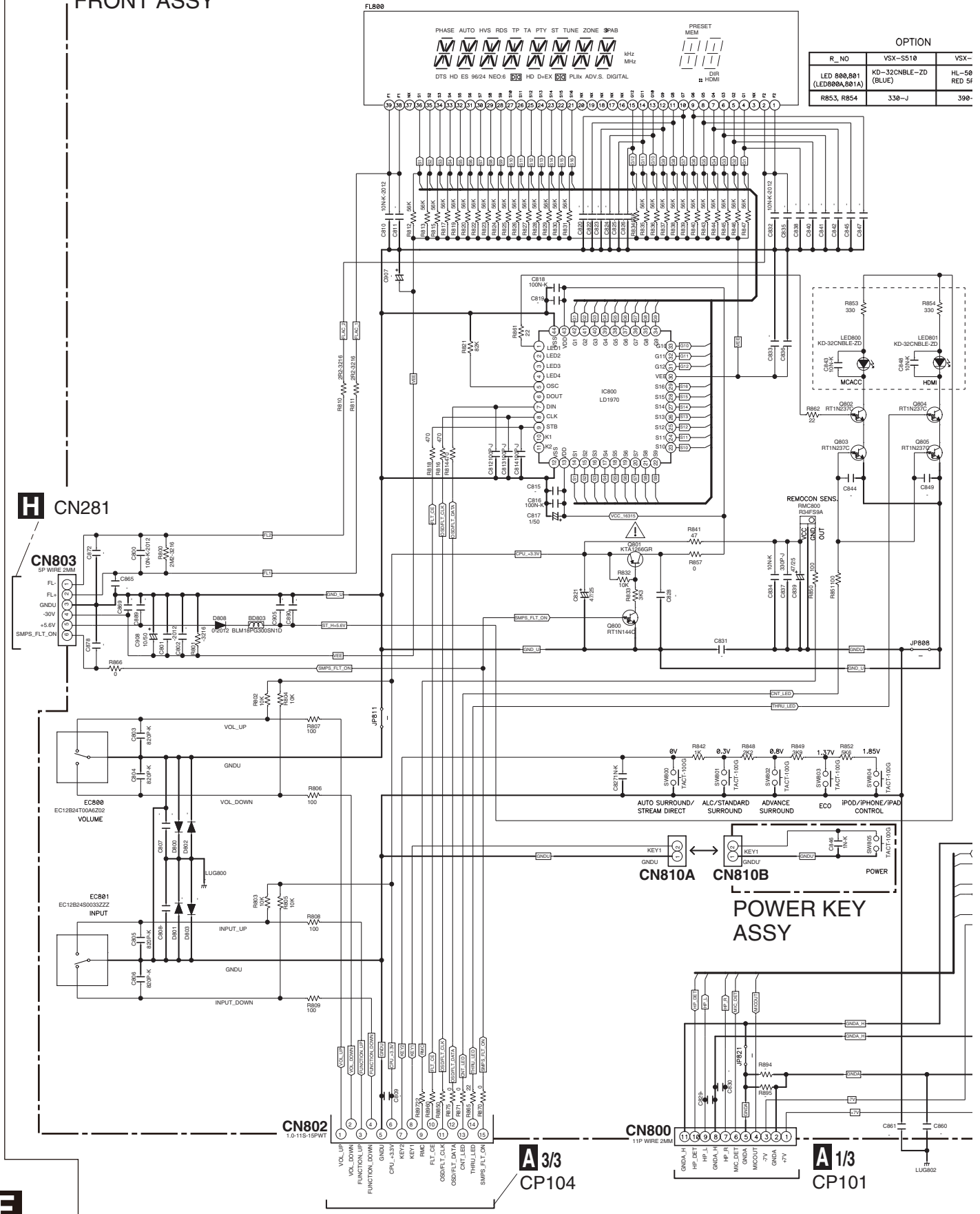

OPTION

	VSX-S510	VSX-S310
101 11A)	KD-32CNBLE-ZD (BLUE)	HL-58CDU RED SPI
14	338-J	390-J

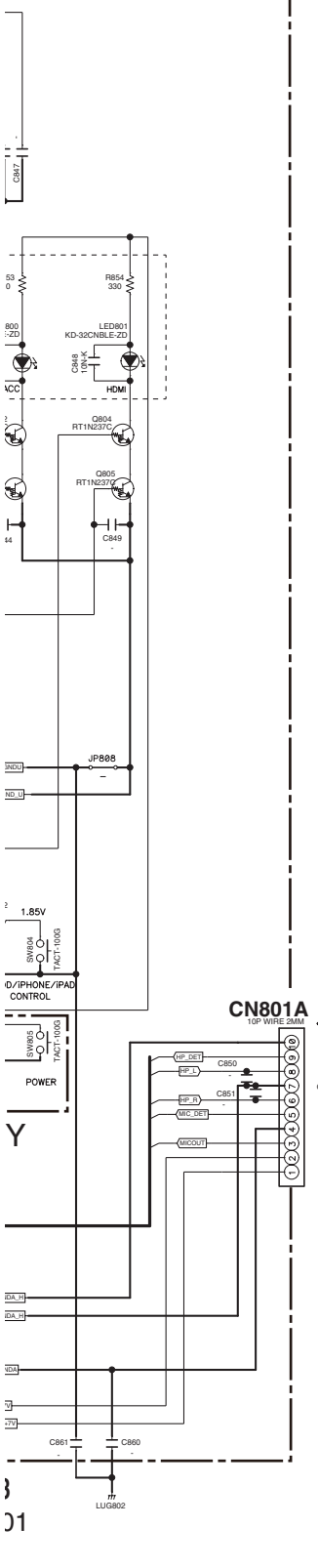

**E** USB ASSY  
(VSX-S310 : 7028074116050-IL)

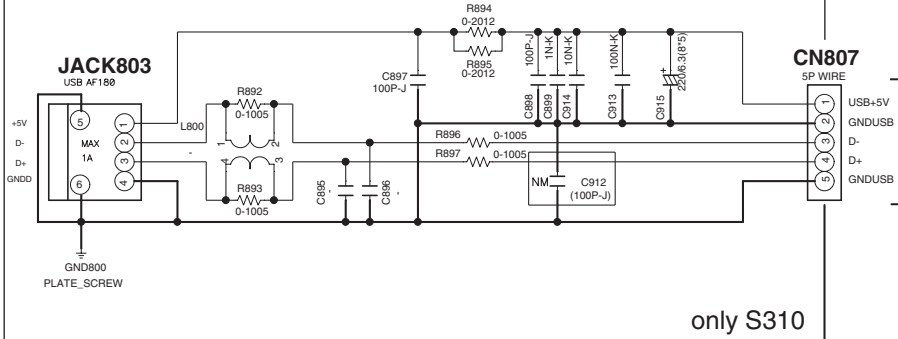

only S310

**B** 3/3  
CP2006  
(VSX-S310)

**F** FRONT ASSY  
(VSX-S510 : 7028074121010-IL)  
(VSX-S310 : 7028074121050-IL)

HP MIC ASSY

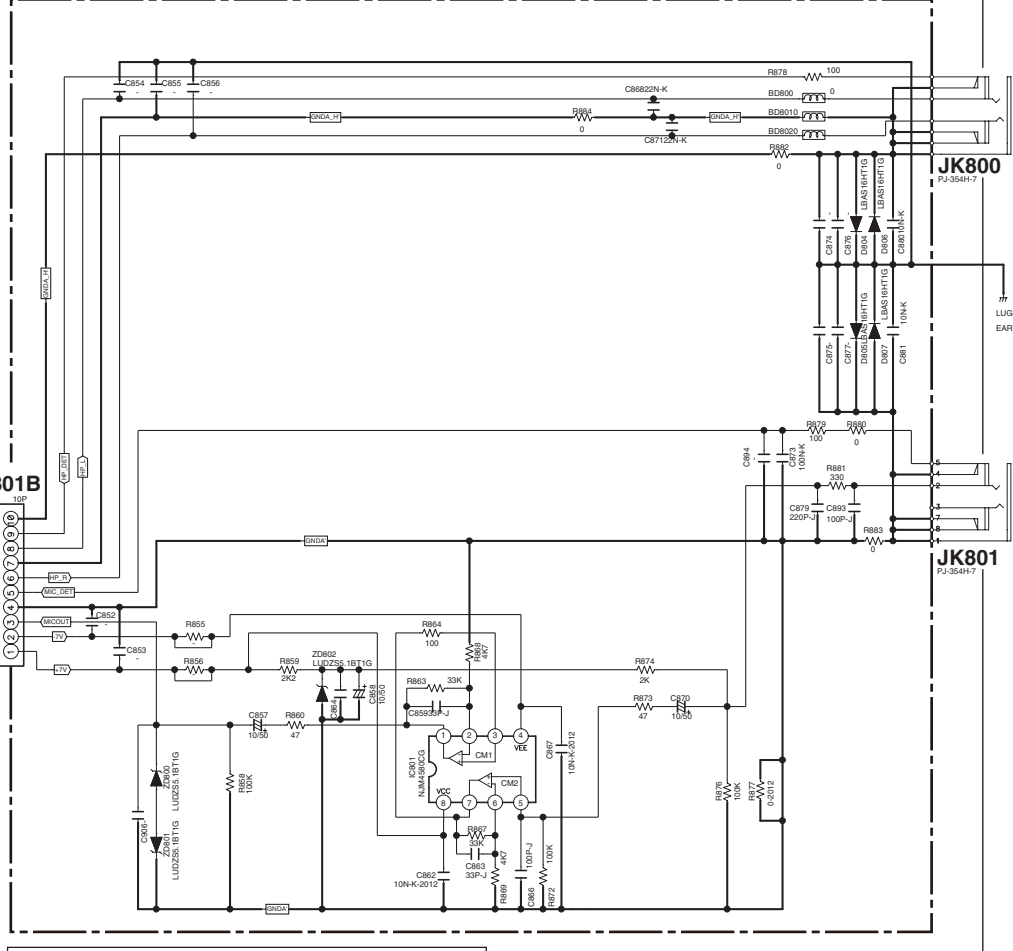

The mark found on some component parts indicates the importance of the safety factor of the part. Therefore when replacing be sure to use parts of identical designation



# 10.16 DAMP ASSY

1 2 3 4

A

**H**  
CN241

MODE OPTION

R.NO	AD MODE	BD MODE
R635, R676, R755	100-160B	OPEN
R763, R765, R767	OPEN	0-160B

B

C

**A** 2/3  
CN103

**A** 2/3  
CN104

D

**A** 3/3  
CN107

E

F

**K**  
CP809

**G**

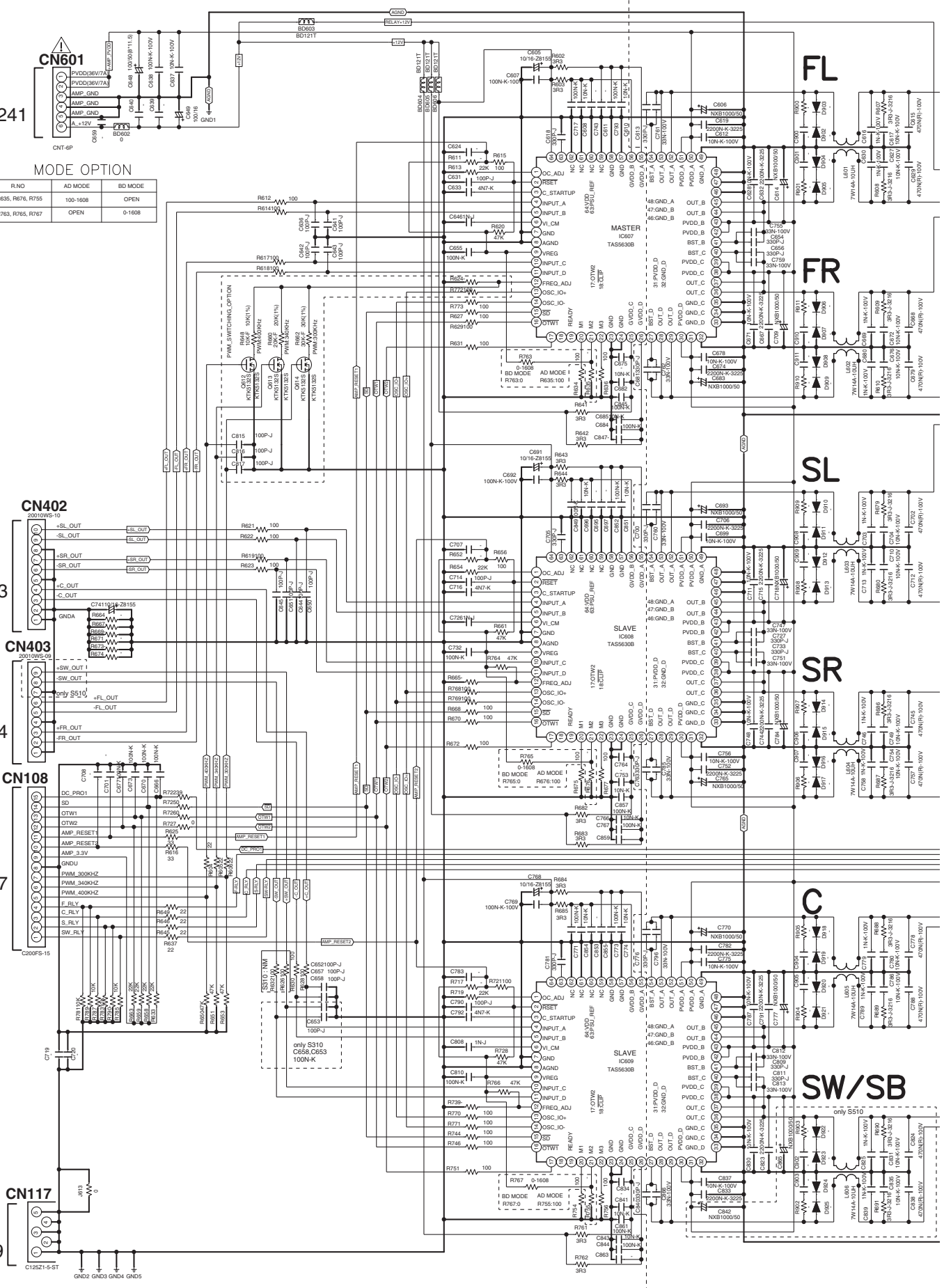

VSX-S510-K

1 2 3 4

**G DAMP ASSY**  
**(VSX-S510 : 702807411010-IL)**  
**(VSX-S310 : 702807411050-IL)**

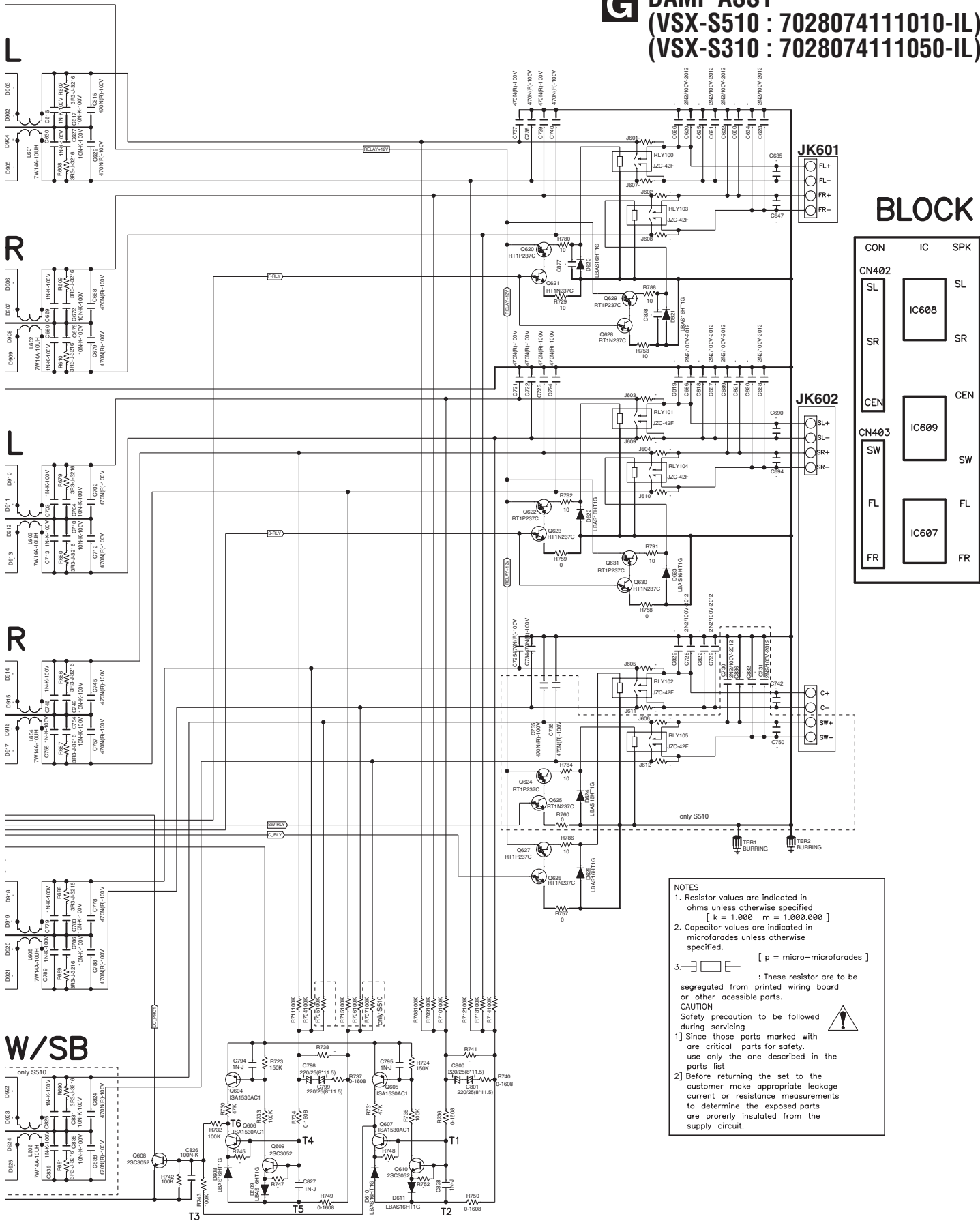

**BLOCK**

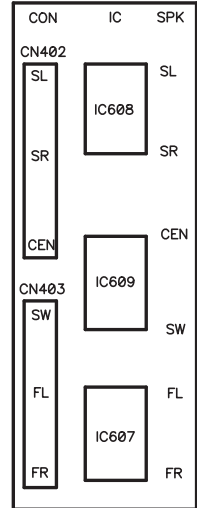

**NOTES**

1. Resistor values are indicated in ohms unless otherwise specified.  
 [ k = 1,000 m = 1,000,000 ]
2. Capacitor values are indicated in microfarads unless otherwise specified.  
 [ p = micro-microfarads ]
3. : These resistor are to be segregated from printed wiring board or other accessible parts.

**CAUTION**  
 Safety precaution to be followed during servicing

- 1) Since those parts marked with are critical parts for safety, use only the one described in the parts list
- 2) Before returning the set to the customer make appropriate leakage current or resistance measurements to determine the exposed parts are properly insulated from the supply circuit.

# 10.17 POWER TRANS ASSY

1 2 3 4

A

B

C

D

E

F

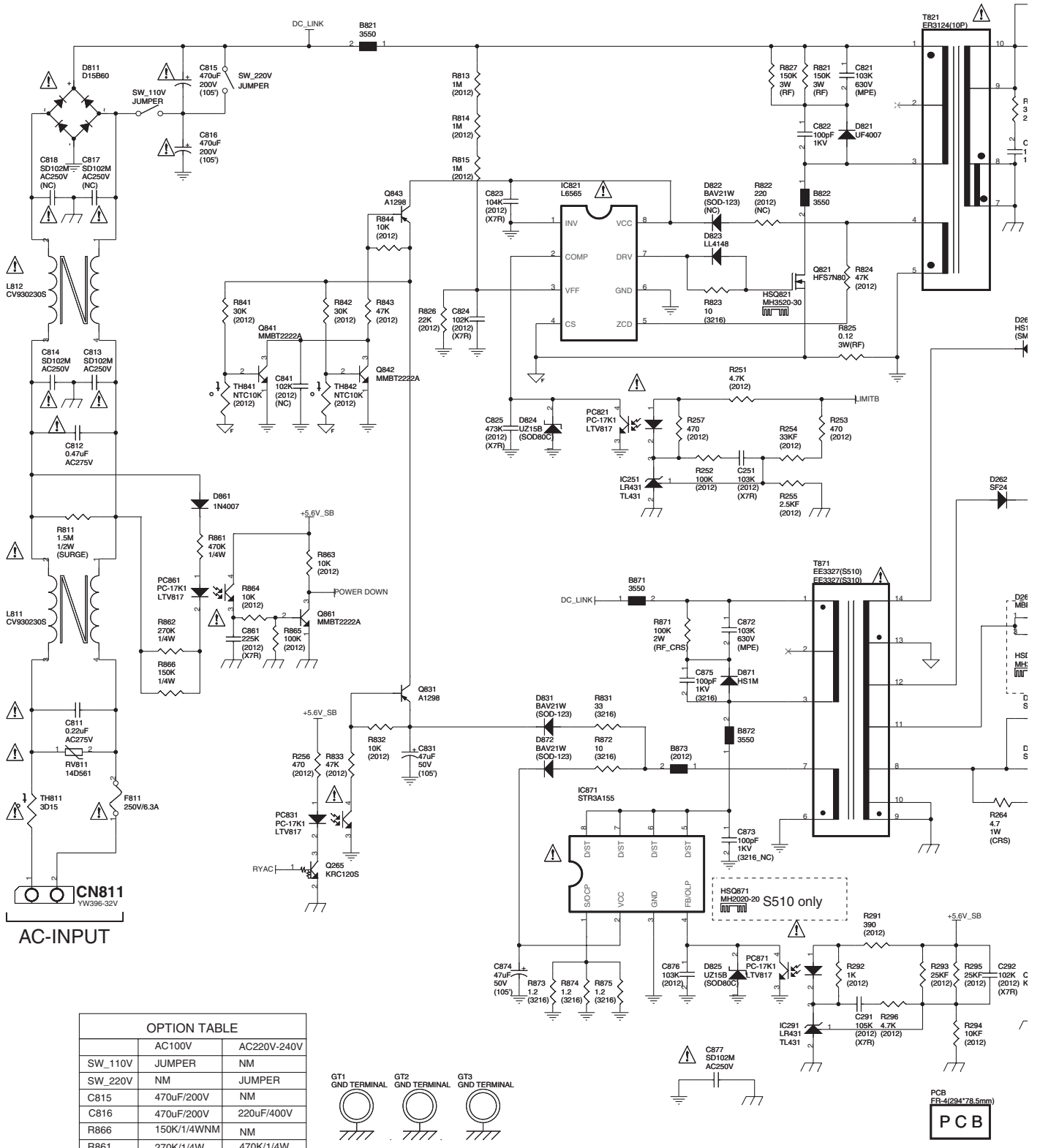

OPTION TABLE		
	AC100V	AC220V-240V
SW_110V	JUMPER	NM
SW_220V	NM	JUMPER
C815	470uF/200V	NM
C816	470uF/200V	220uF/400V
R866	150K/1/4WNM	NM
R861	270K/1/4W	470K/1/4W

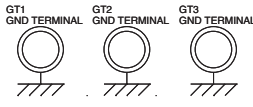

⚠ : To reduce the risk of electric shock, leakage current or resistance measurement shall be carried out before the appliance returned to the customer



1 2 3 4



# POWER TRANS ASSY

(VSX-S510 : 8208001050010-IL)  
 (VSX-S310 : 8208001050030-IL)

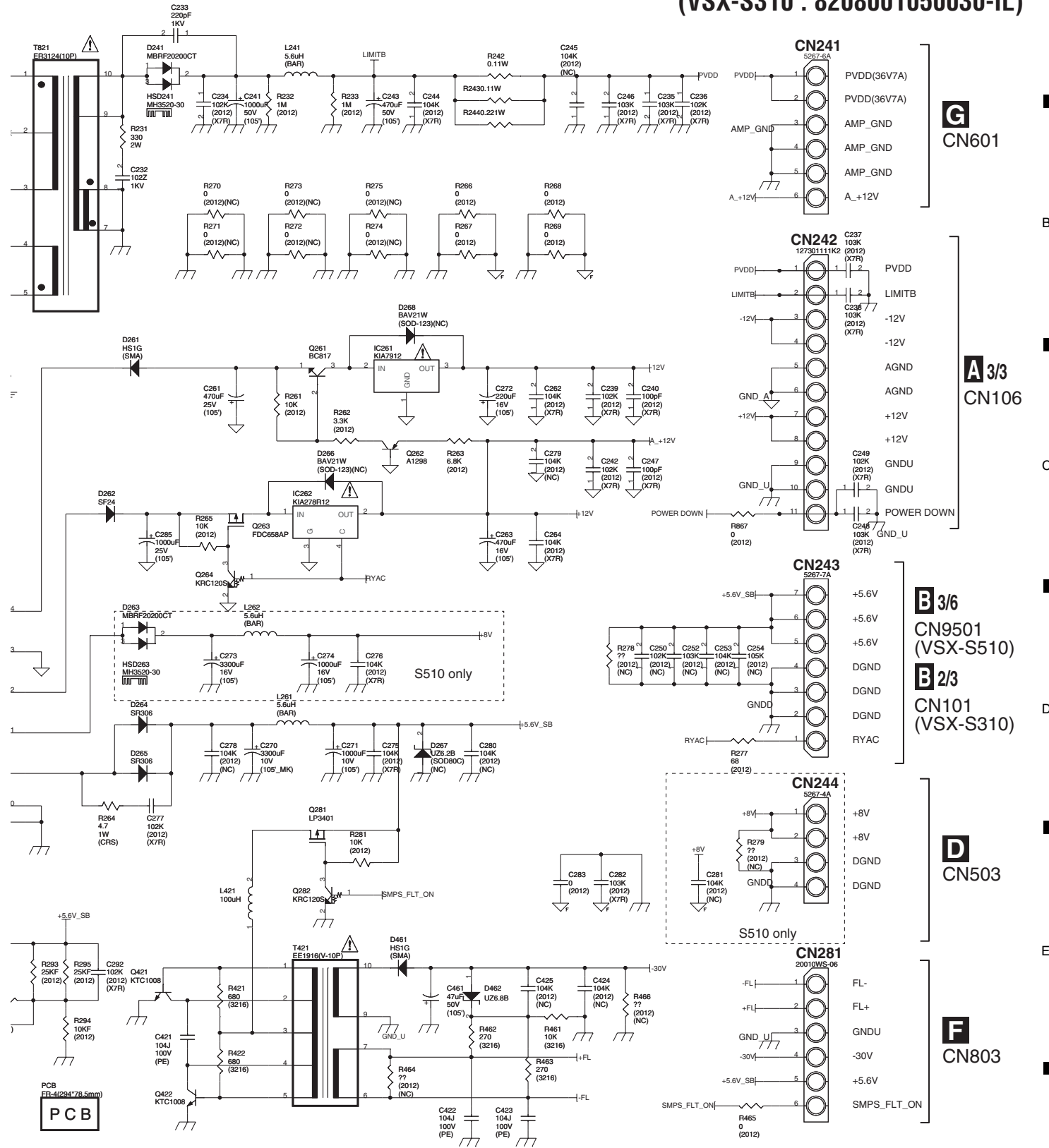

**G** CN601

**A** 3/3 CN106

**B** 3/6 CN9501 (VSX-S510)  
**B** 2/3 CN101 (VSX-S310)

**D** CN503

**F** CN803

# 10.18 SIDE CNT ASSY

1 2 3 4

A  
B  
C  
D  
E  
F

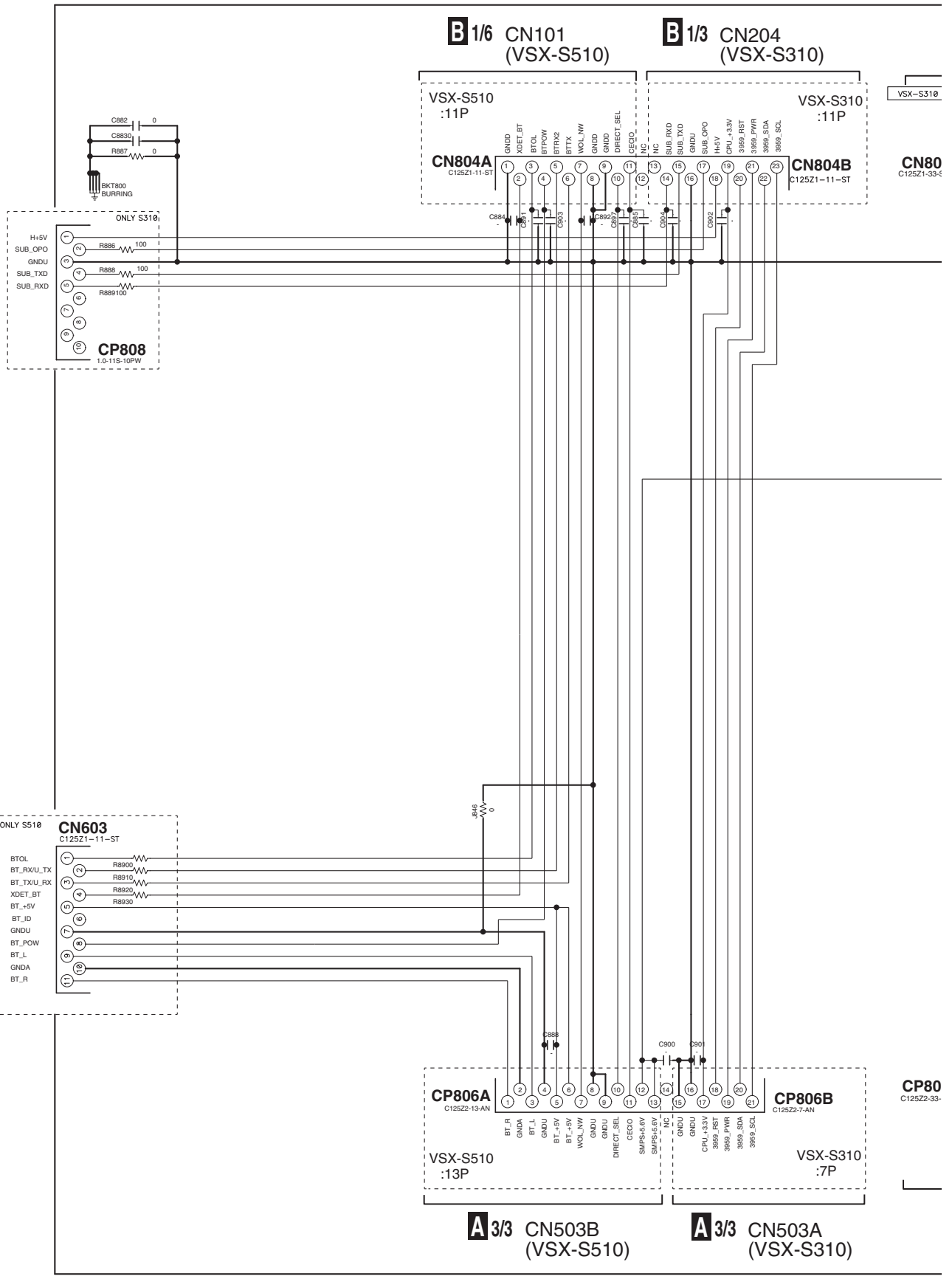

1 2 3 4

**I** SIDE CNT ASSY  
 (VSX-S510 : 7028074124010-IL)  
 (VSX-S310 : 7028074124050-IL)

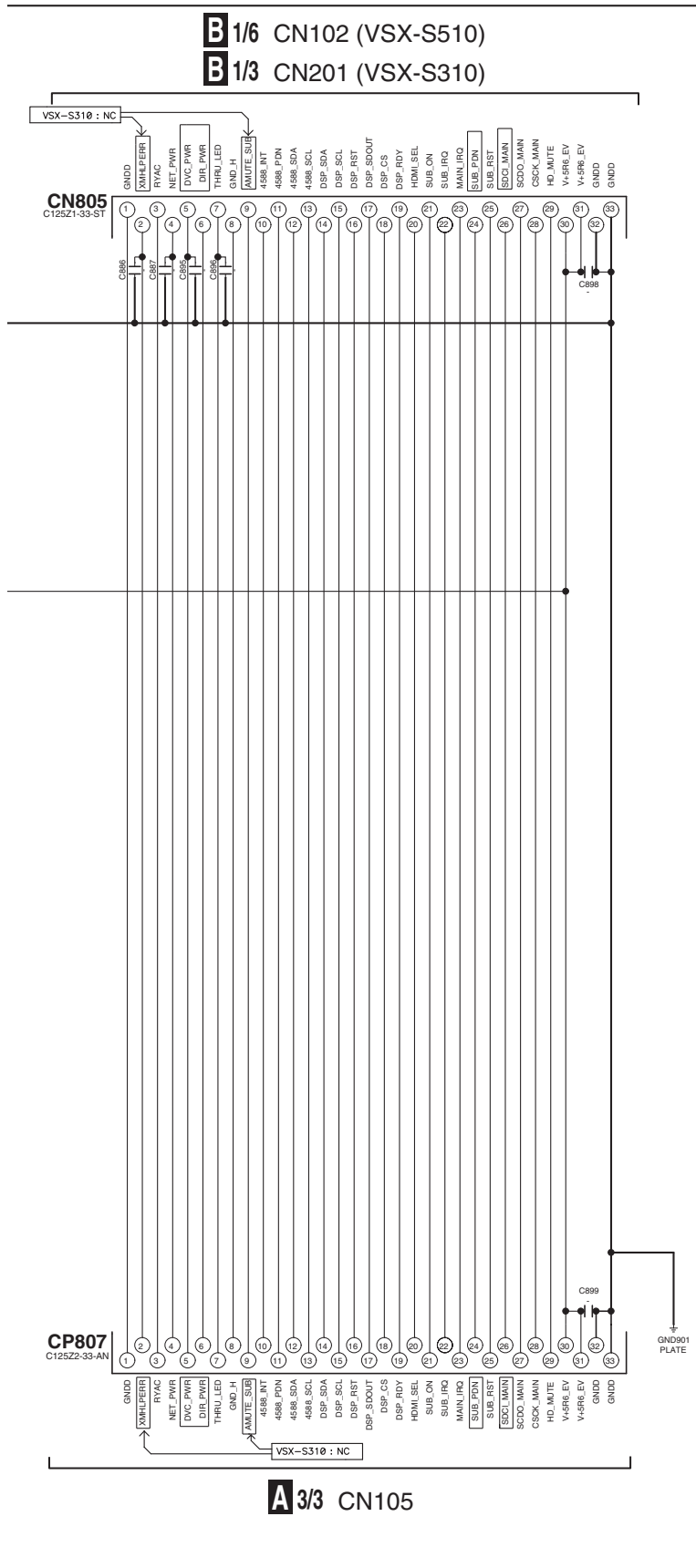

The  mark found on some component parts indicates the importance of the safety factor of the part. Therefore when replacing be sure to use parts of identical designation

10.19 BRIDGE, AMP GUARD, MAIN GUARD,CABLE and CLAMP ASSYS

A

B

C

D

E

F

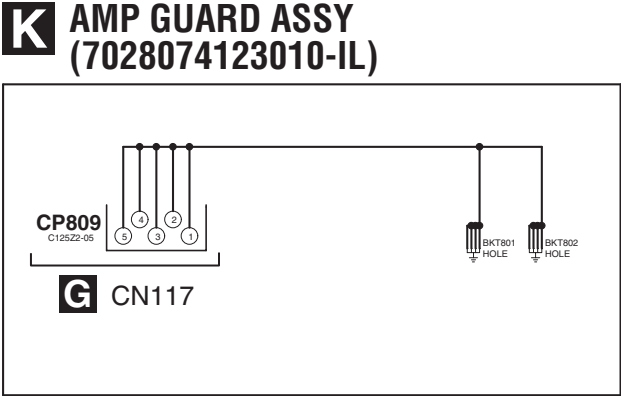
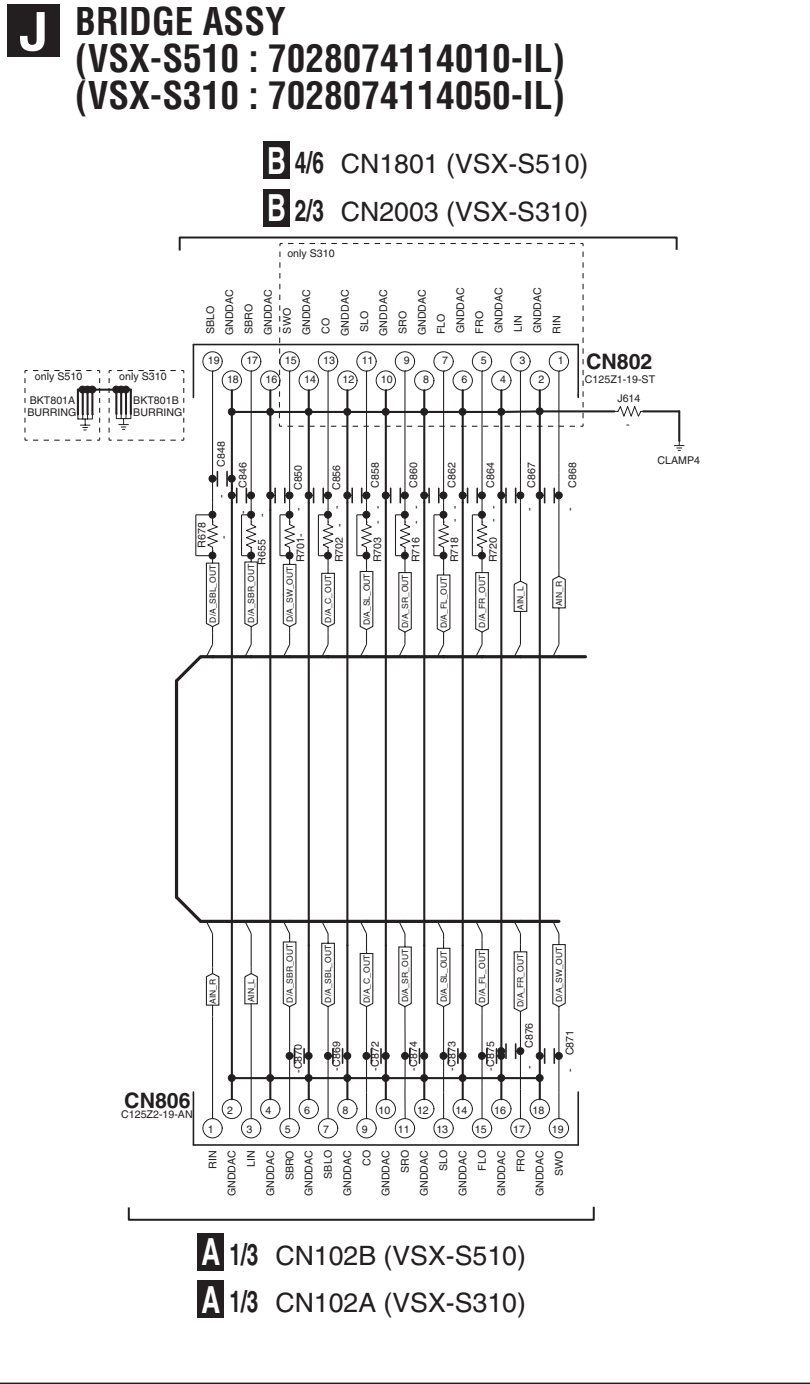

**J K**

A

**L** MAIN GUARD ASSY  
(7028074115010-IL)



GND7  
HOLE

B

**M** CABLE ASSY  
(VSX-S510 : 7028074113010-IL)



BKT2  
BURRING

CLAMP5

only S510

C

**N** CLAMP ASSY  
(VSX-S510 : 7028074117010-IL)



CLAMP1

only S510

D

**N** CLAMP ASSY  
(VSX-S310 : 7028074117050-IL)



CLAMP2 CLAMP3

only S310

E

F



**SIDE A**

**NOTE FOR PCB DIAGRAMS :**

1. The parts mounted on this PCB include all necessary parts for several destinations. For further information for respective destinations, be sure to check with the schematic diagram.

2. View point of PCB diagrams.

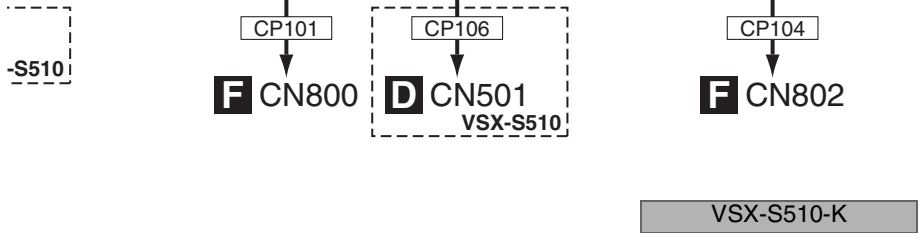
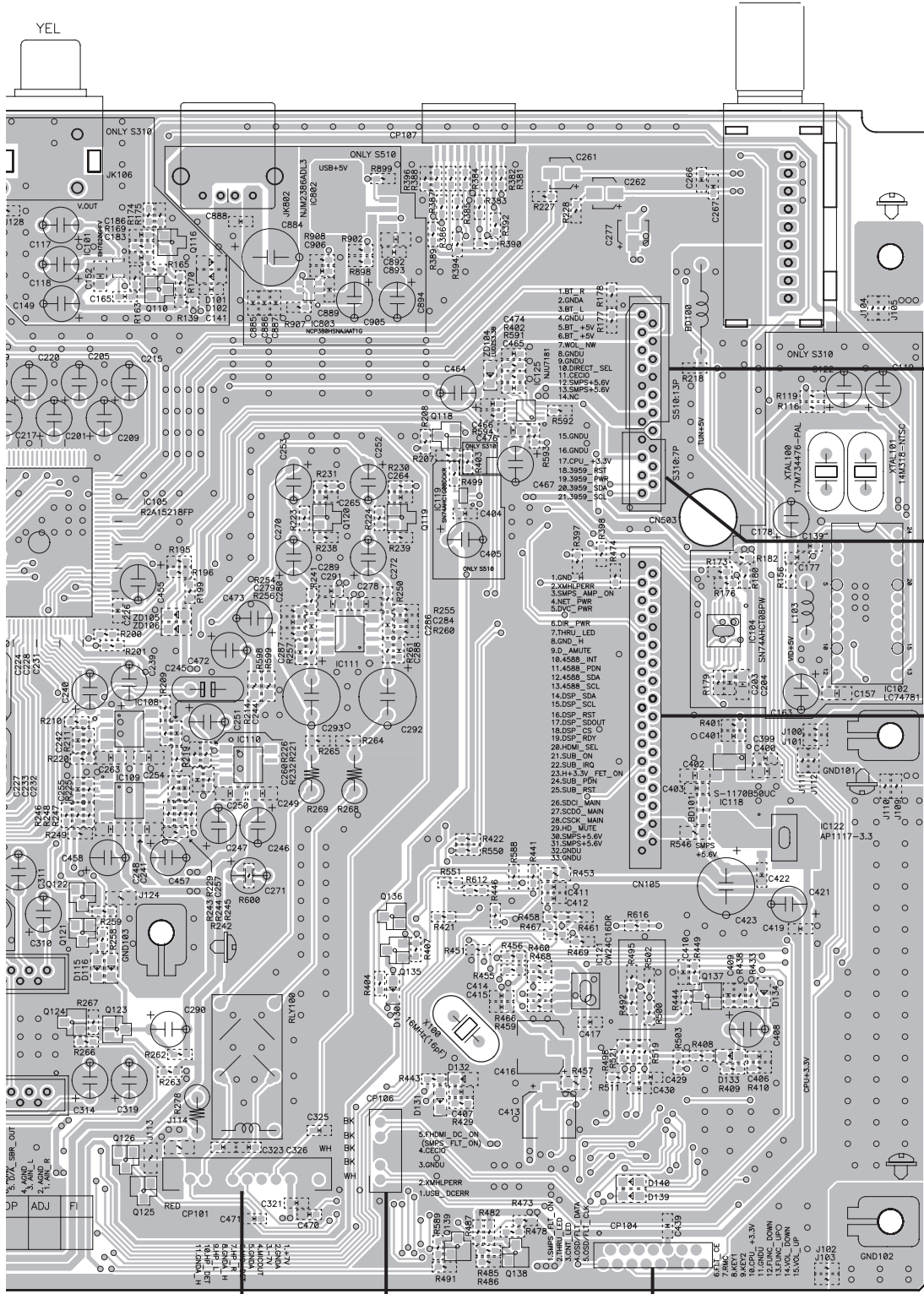
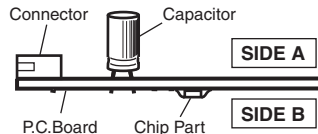

VSX-S510-K

**A**

SIDE B

MAIN ASSY

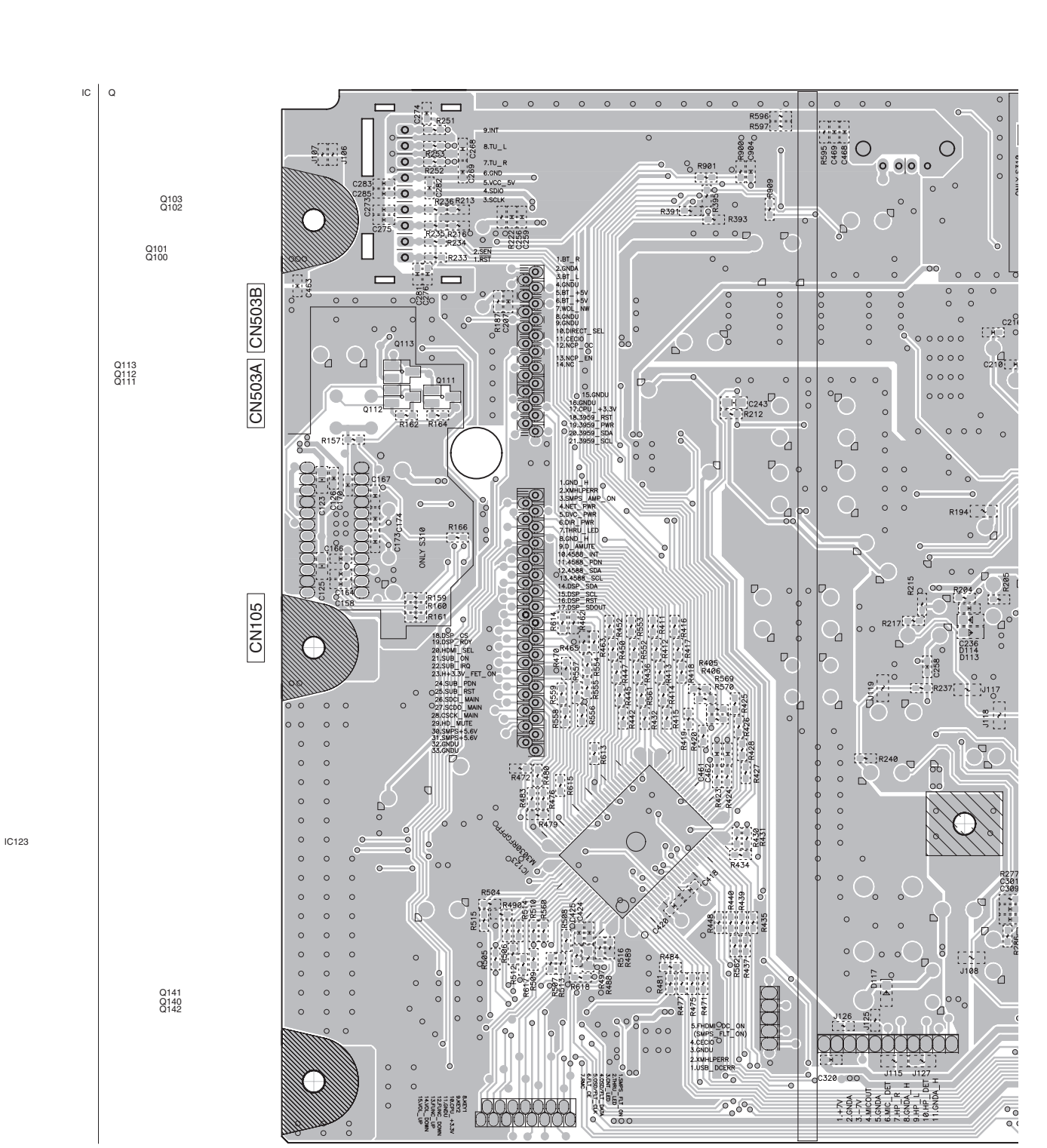

A

112

VSX-S510-K



SIDE B

A  
B  
C  
D  
E  
F

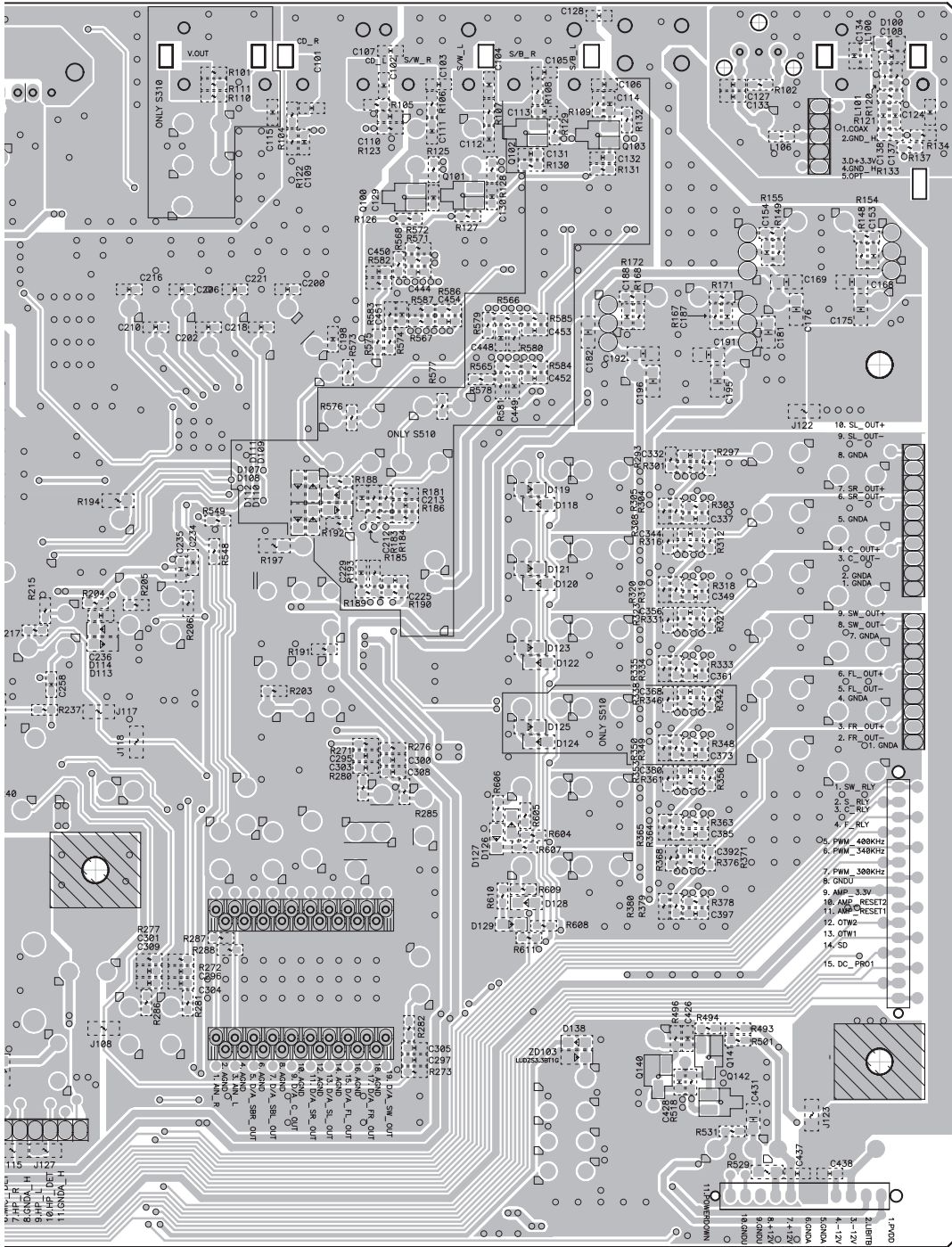

101

CN102A  
CN102B

CN106

VSX-S510-K

A

## 11.2 DMAIN ASSY (VSX-S510)

SIDE A

**B** DMAIN ASSY

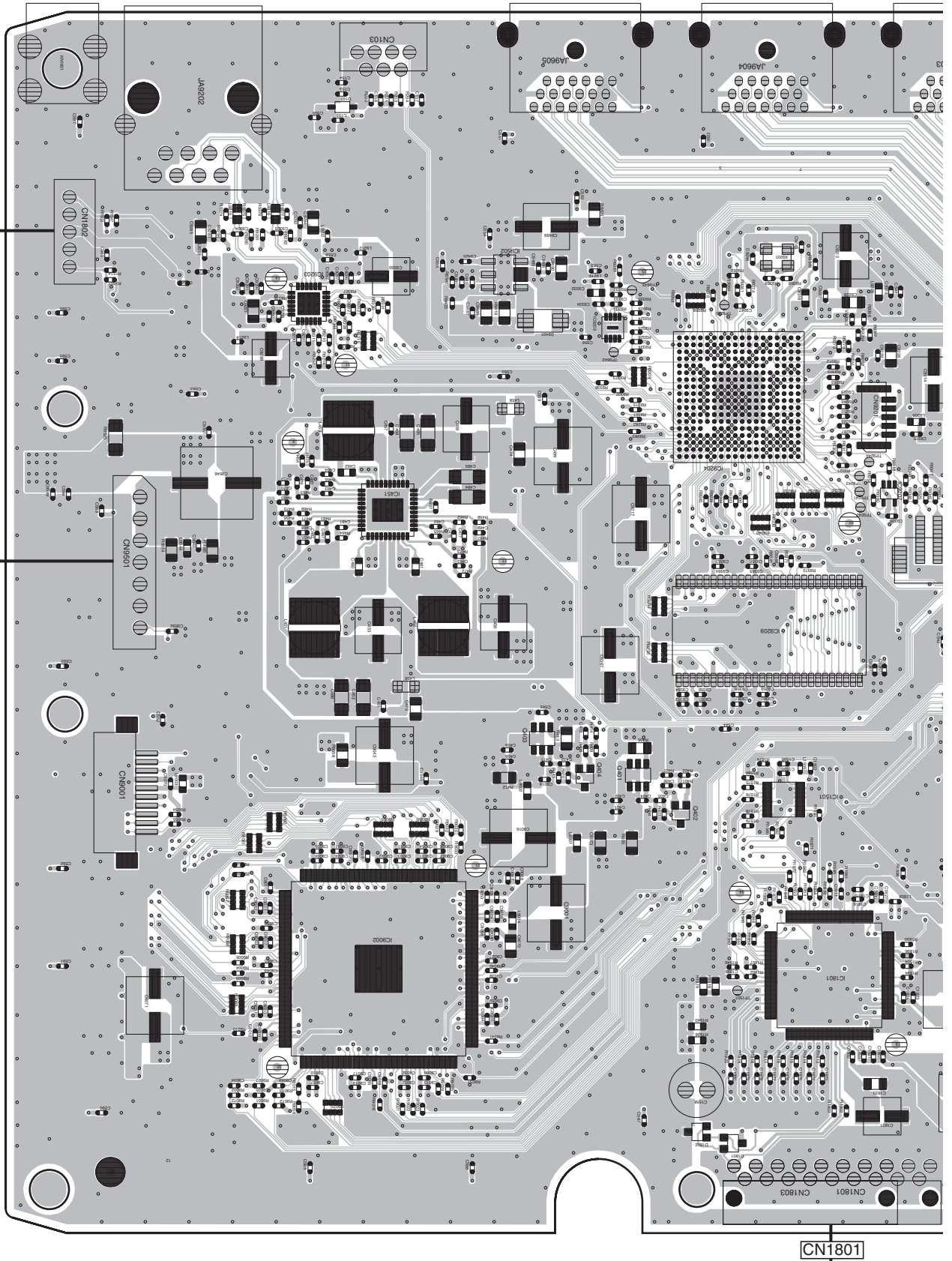

**B**

**SIDE A**

A

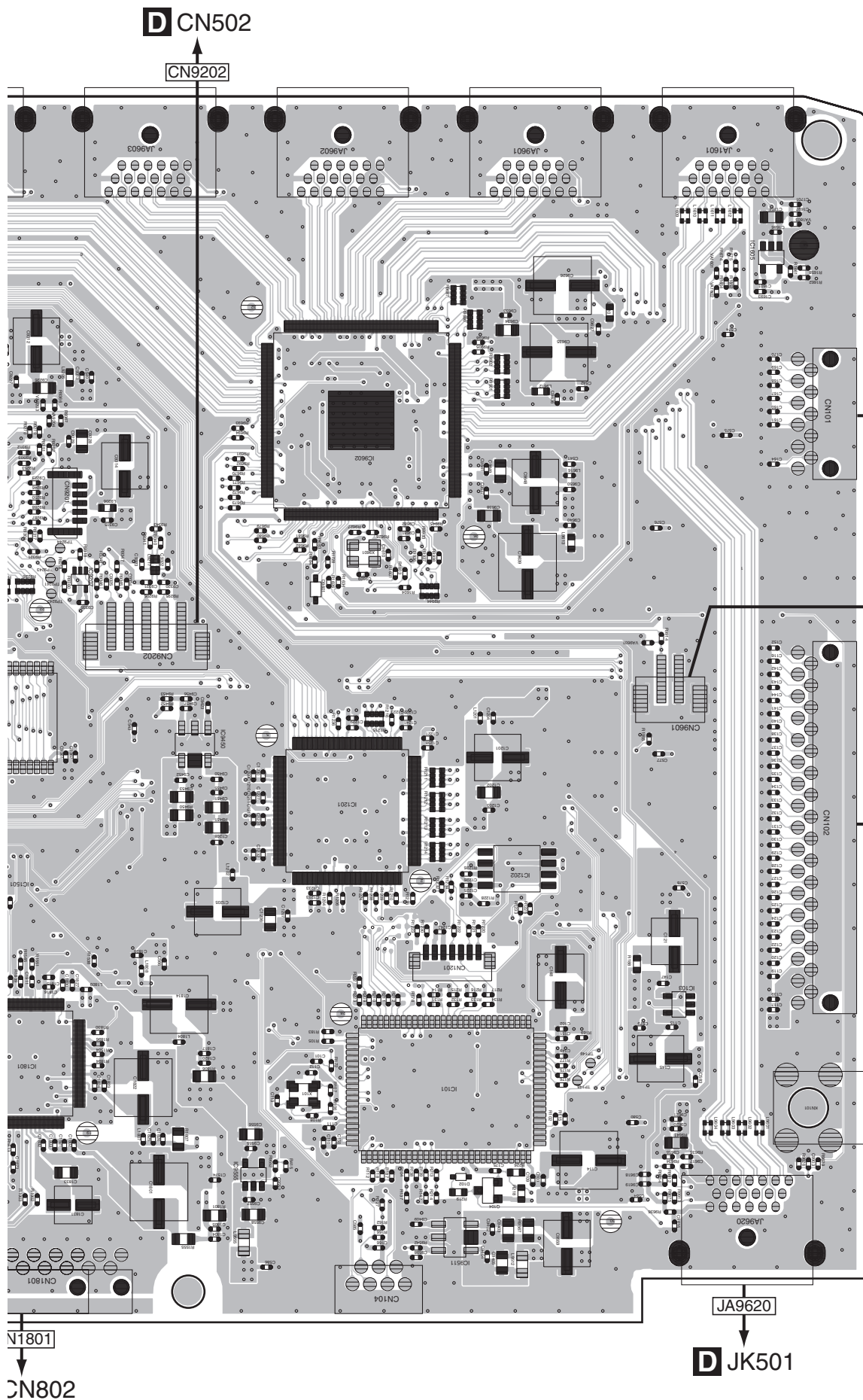

- Q IC
- IC1605
- IC9502
- IC9203
- IC9206
- IC9602
- IC9204
- IC9207
- IC451
- IC9209
- IC9450
- IC1201
- Q403
- Q404
- Q401
- Q402
- IC103
- IC9002
- IC1801
- IC101
- IC9555
- Q104
- IC9511

B

C

D

E

F

**B**

SIDE B

# B DMAIN ASSY

CN9202

CN101

CN9601

CN102

JA9620

CN1801

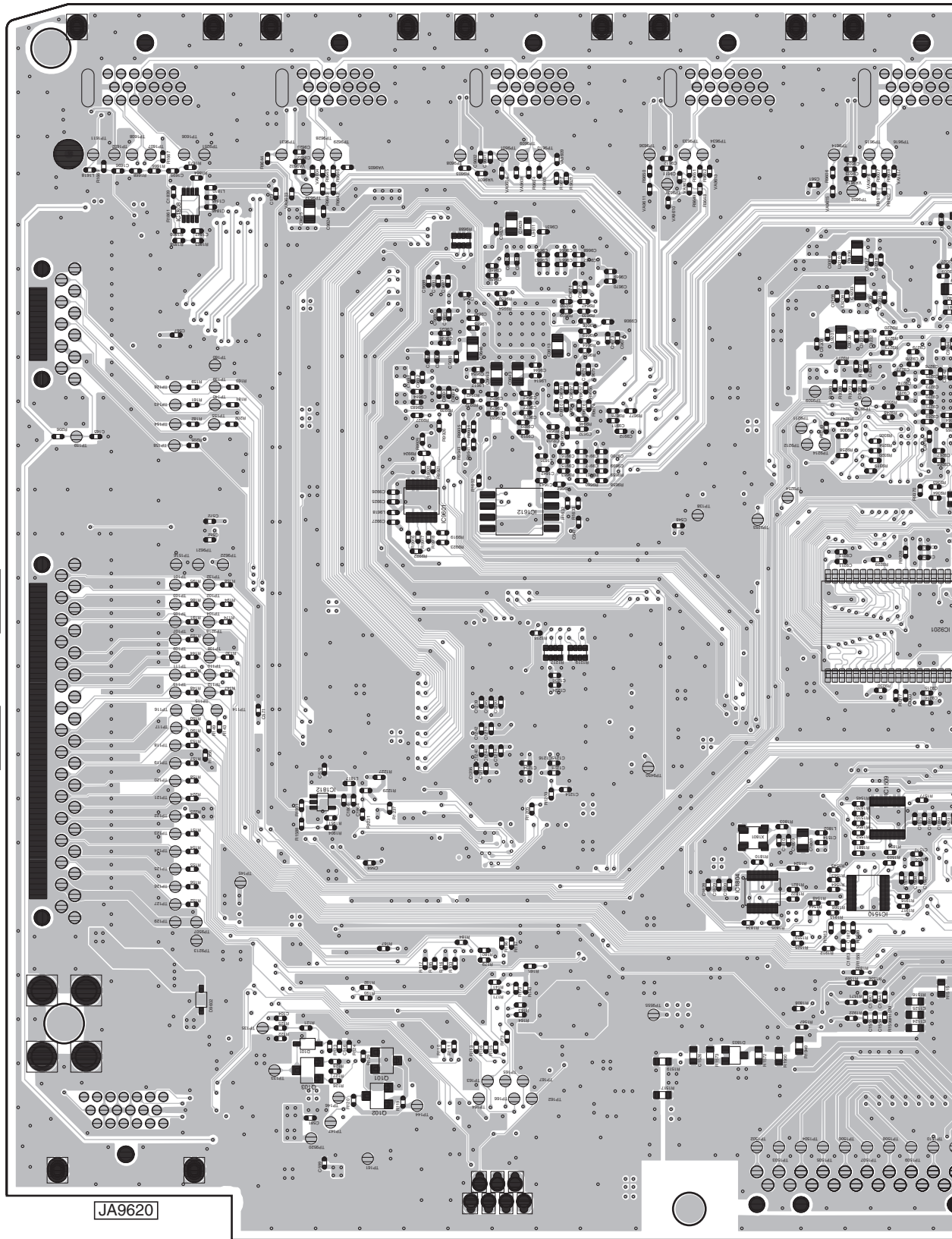

B

**SIDE B**

A

B

C

D

E

F

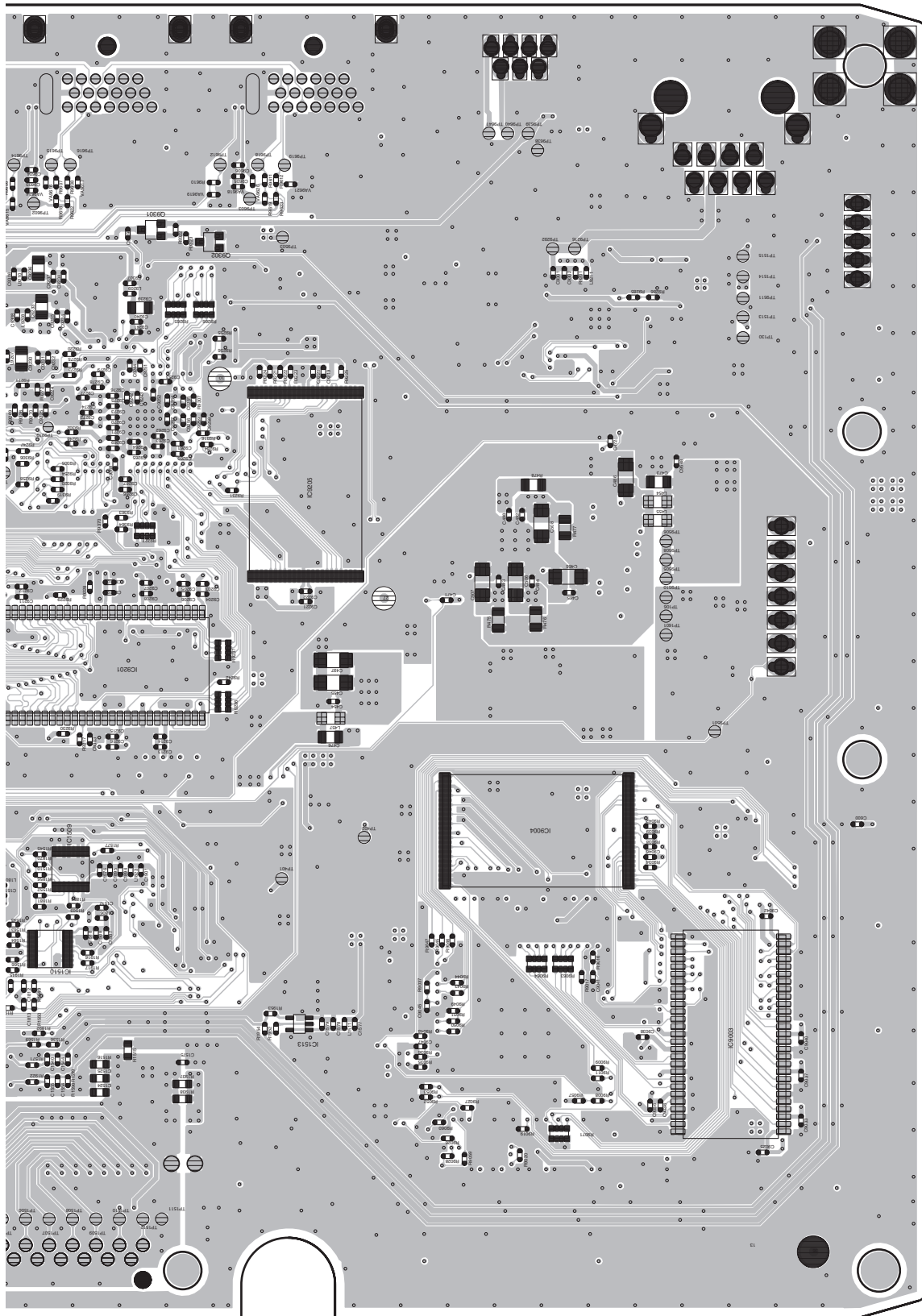

CN1802

CN9501

CN1801

VSX-S510-K

**B**

# 11.3 DMAIN ASSY (VSX-S310) and BT ASSY (VSX-S510)

**SIDE A**

**B** DMAIN ASSY

A  
B  
C  
D  
E  
F

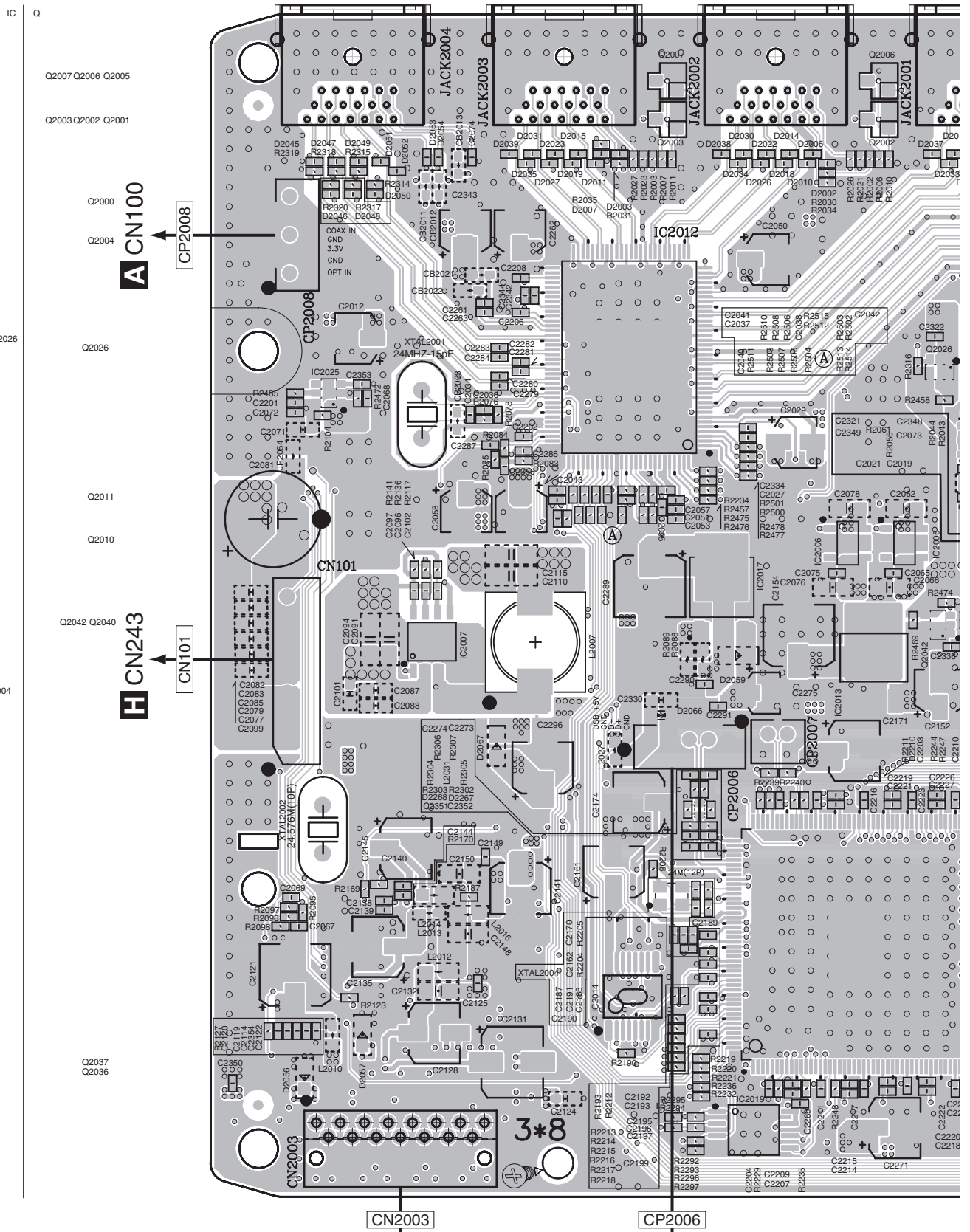

1 2 3 4

SIDE A

A  
B  
C  
D  
E  
F

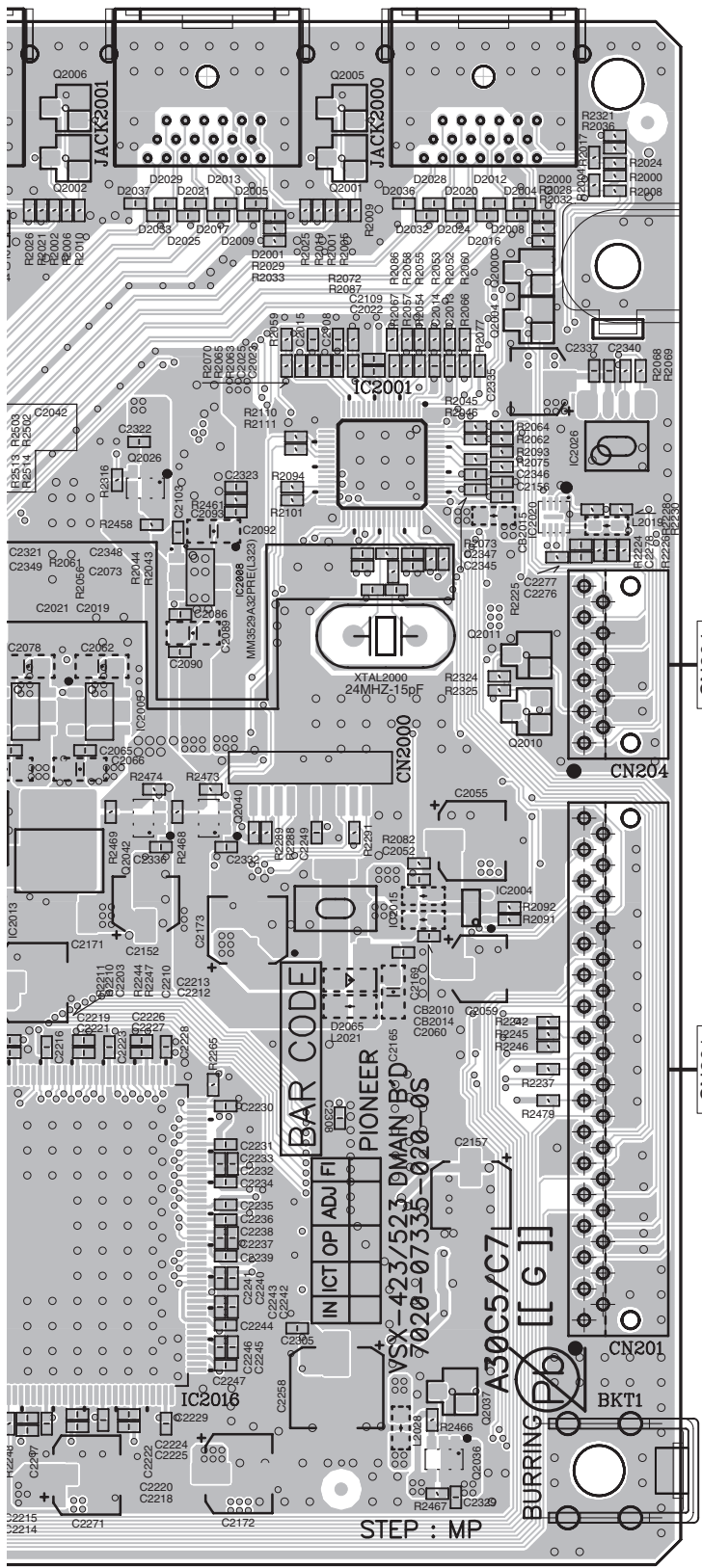

CN204  
CN804B

CN201  
CN805

C BT ASSY

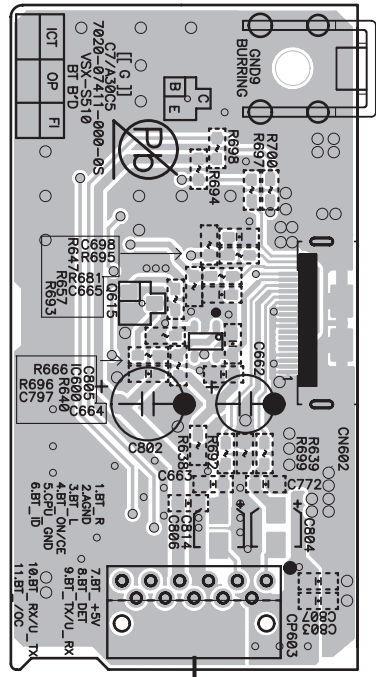

B C

**SIDE B**

**C BT ASSY**

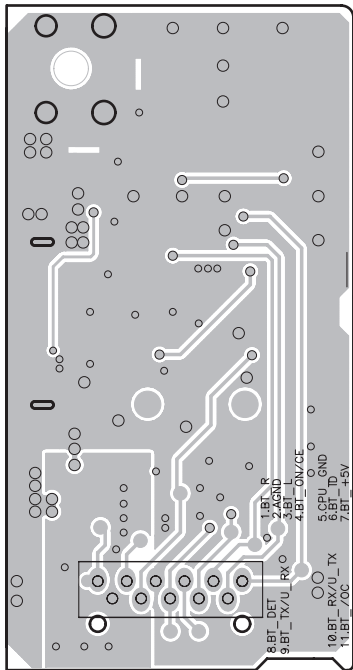

CP603

**B DMAIN ASSY**

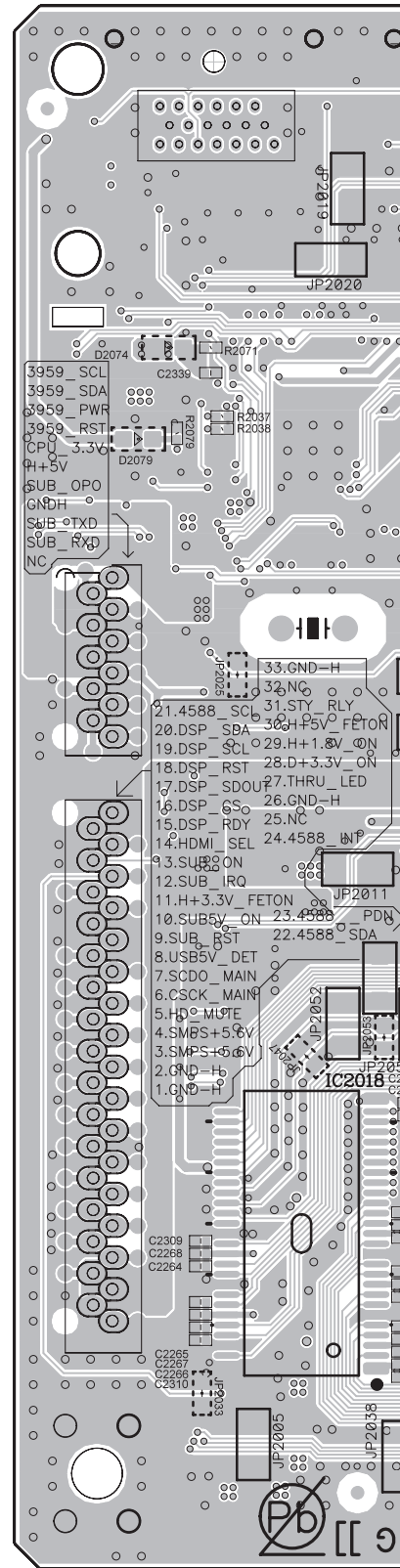



SIDE B

SY

A

B

C

D

E

F

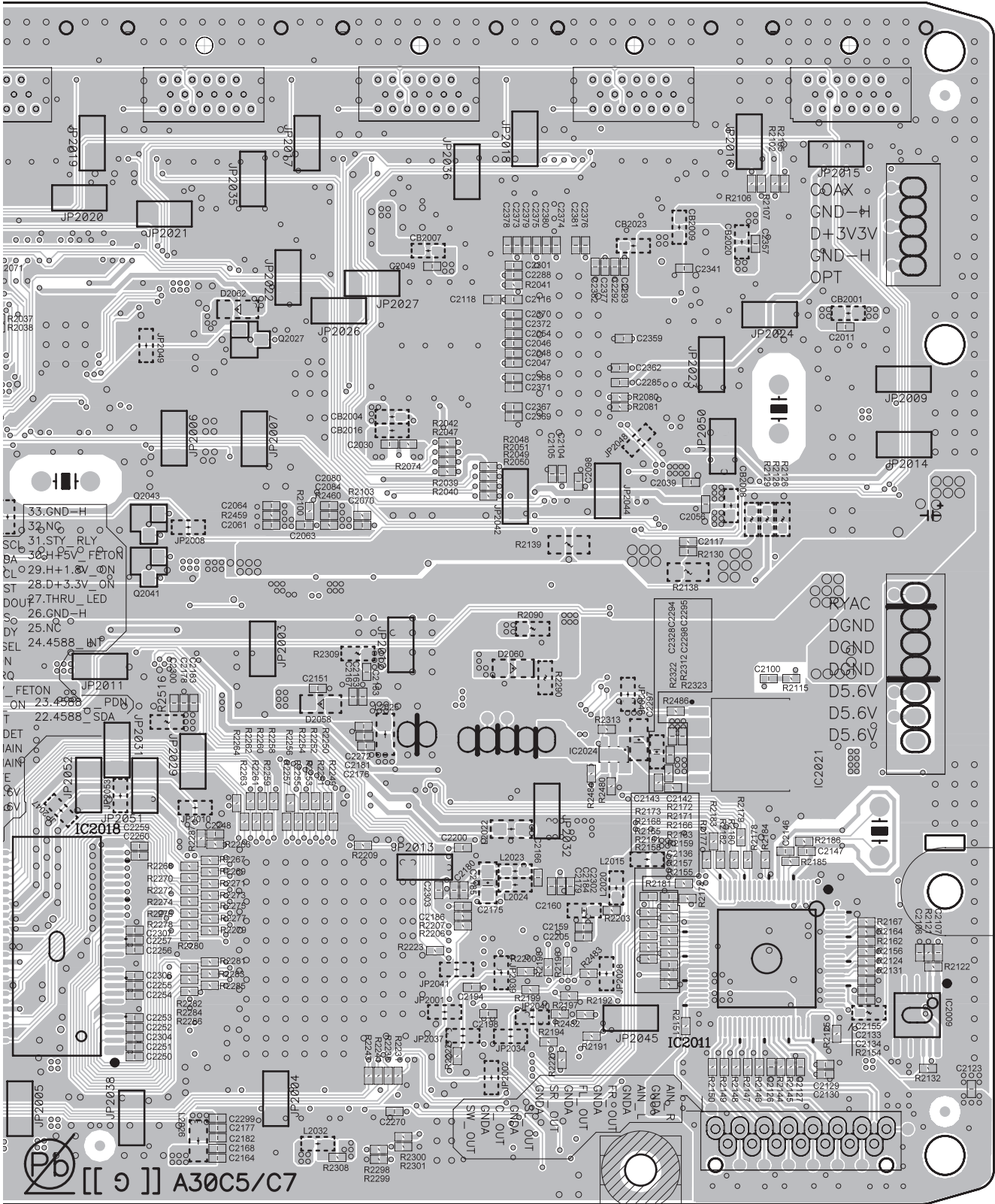

CP2008

CN101

CP2006

CN2003

VSX-S510-K

B

# 11.4 FHDMI ASSY (VSX-S510) and USB ASSY (VSX-S310)

**SIDE A**

**SIDE A**

## **D** FHDMI ASSY

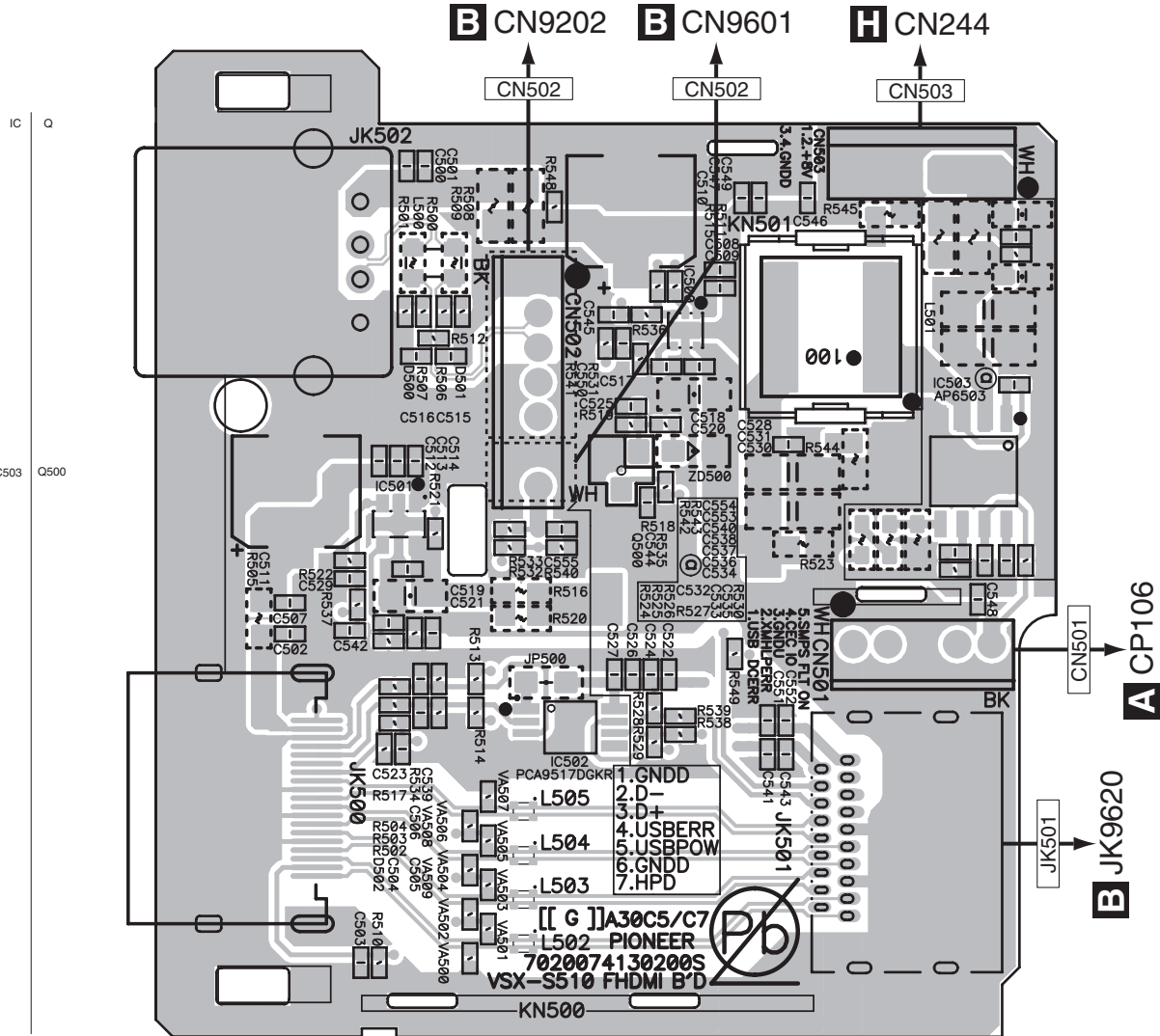

## **E** USB ASSY

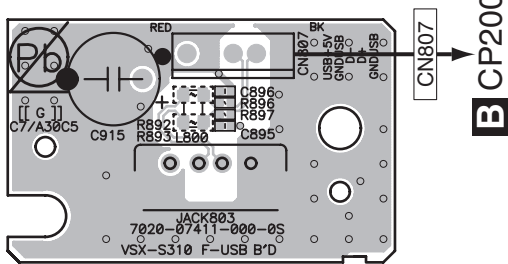

**D E**

**D E**

SIDE B

SIDE B

### D FHDMI ASSY

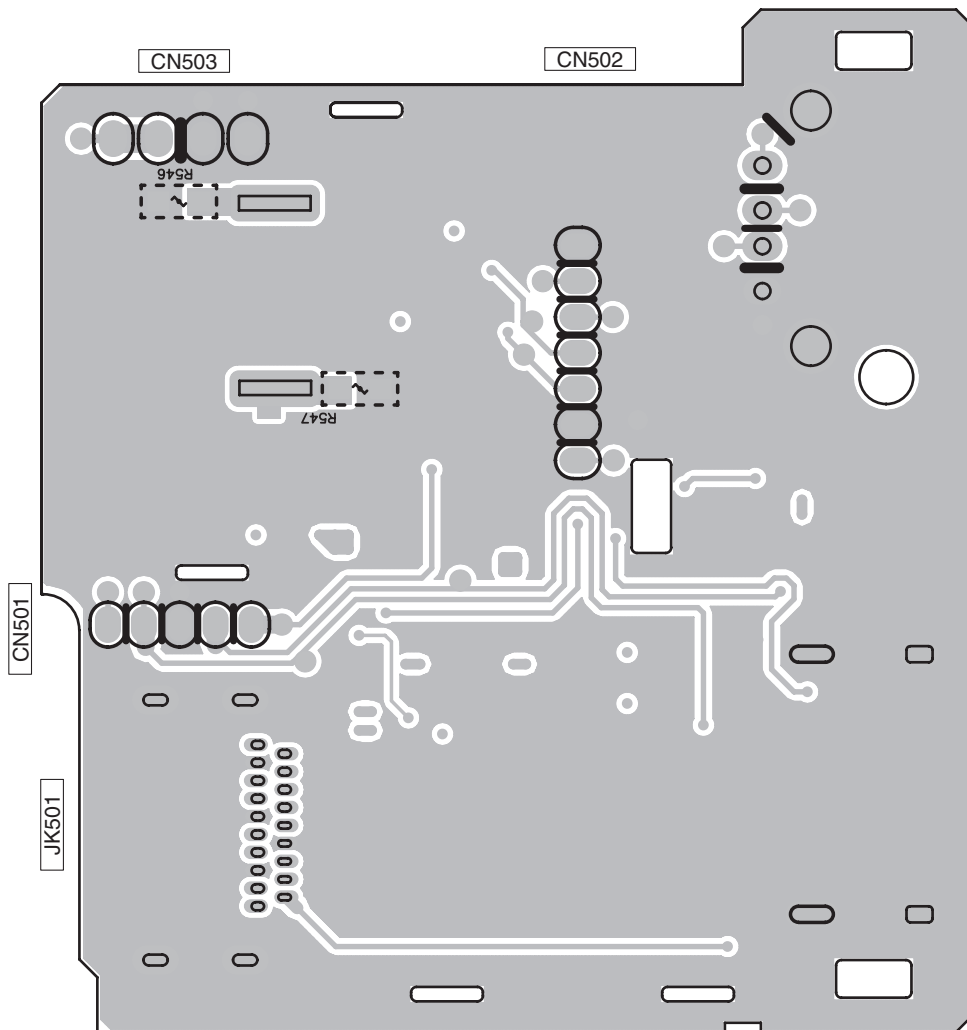

### E USB ASSY

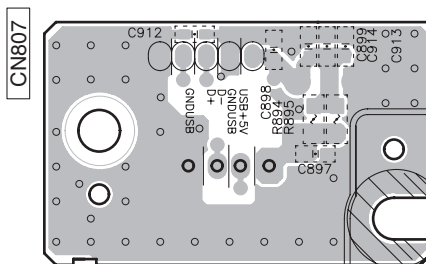

D E

D E

# 11.5 FRONT ASSY

**SIDE A**

## **F** FRONT ASSY

## POWER KEY ASSY

### HP MIC ASSY

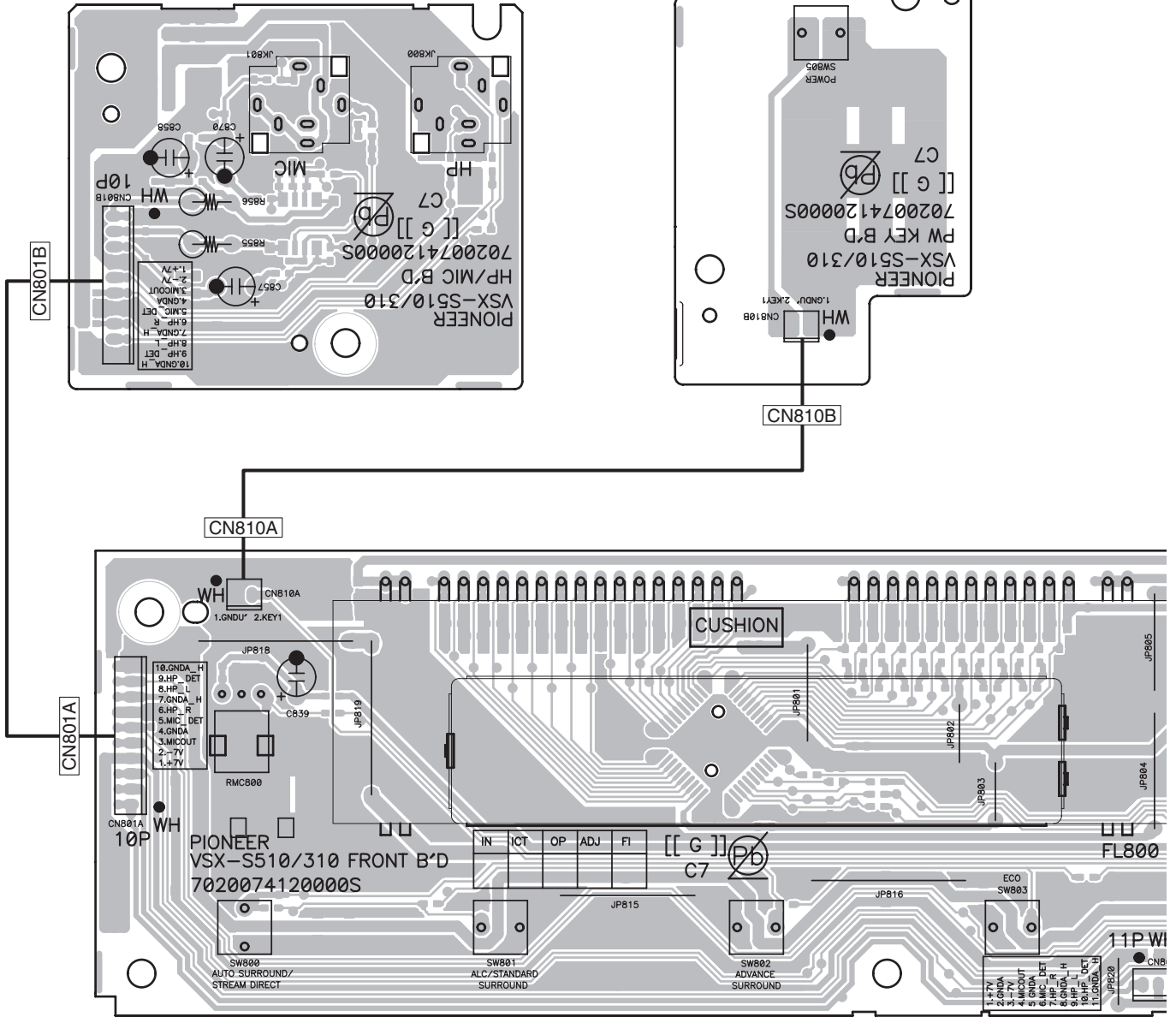

Q

IC



**SIDE A**

A

B

C

D

E

F

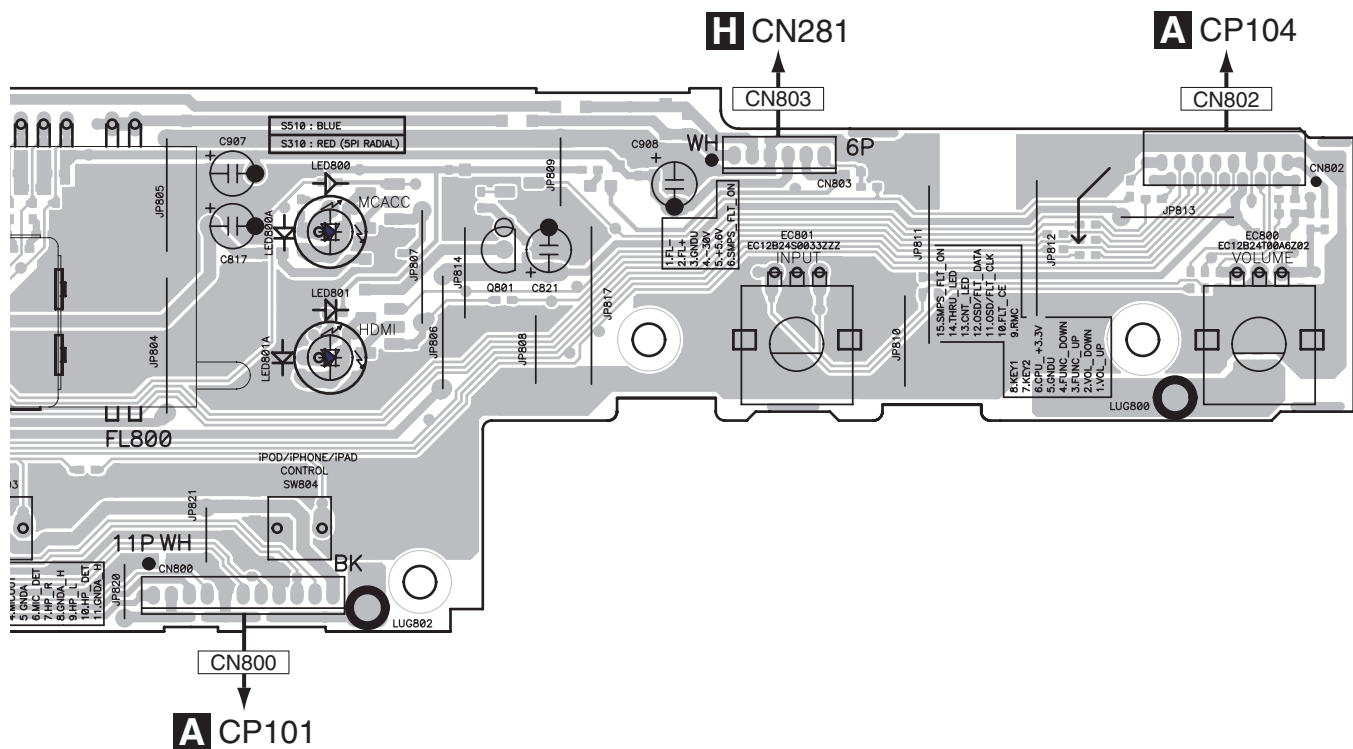

Q801

SIDE B

F FRONT ASSY

A  
B  
C  
D  
E  
F

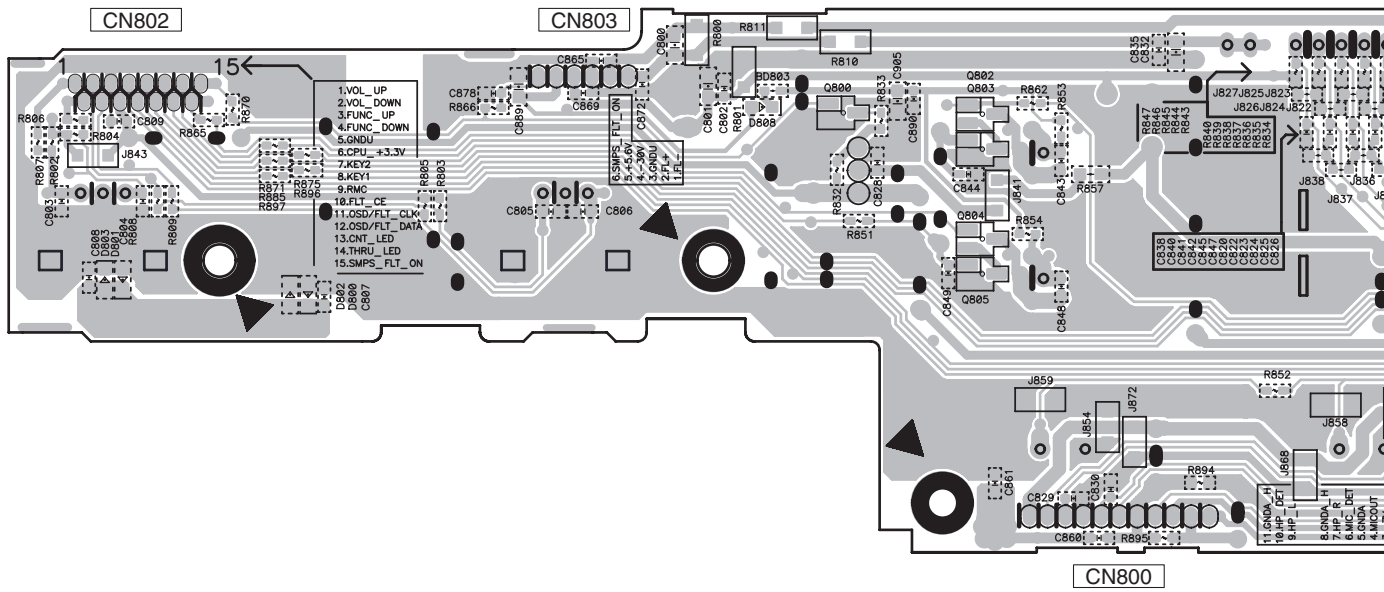

SIDE B

A

### POWER KEY ASSY

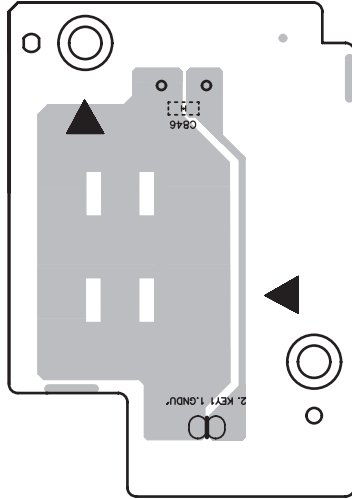

CN810B

### HP MIC ASSY

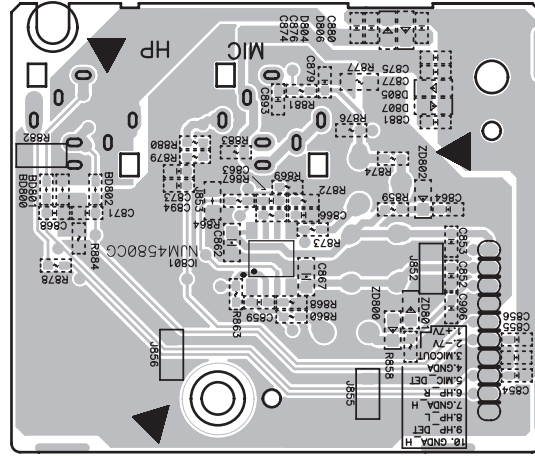

CN801B

IC  
IC801

B

C

CN810A

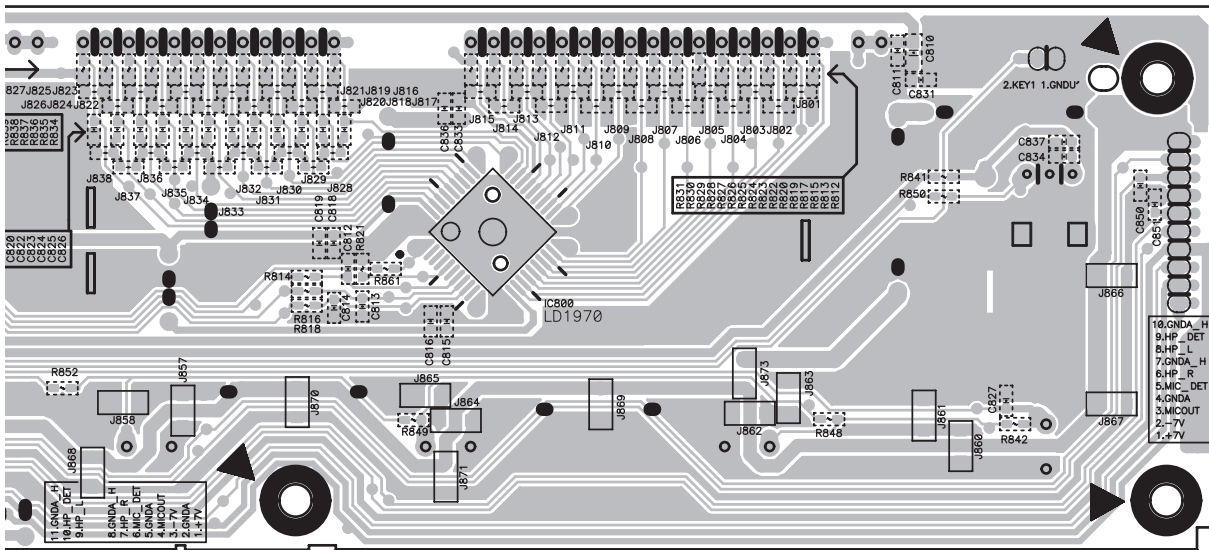

CN801A

IC800

D

E

F

# 11.6 DAMP ASSY

SIDE A

**G** DAMP ASSY

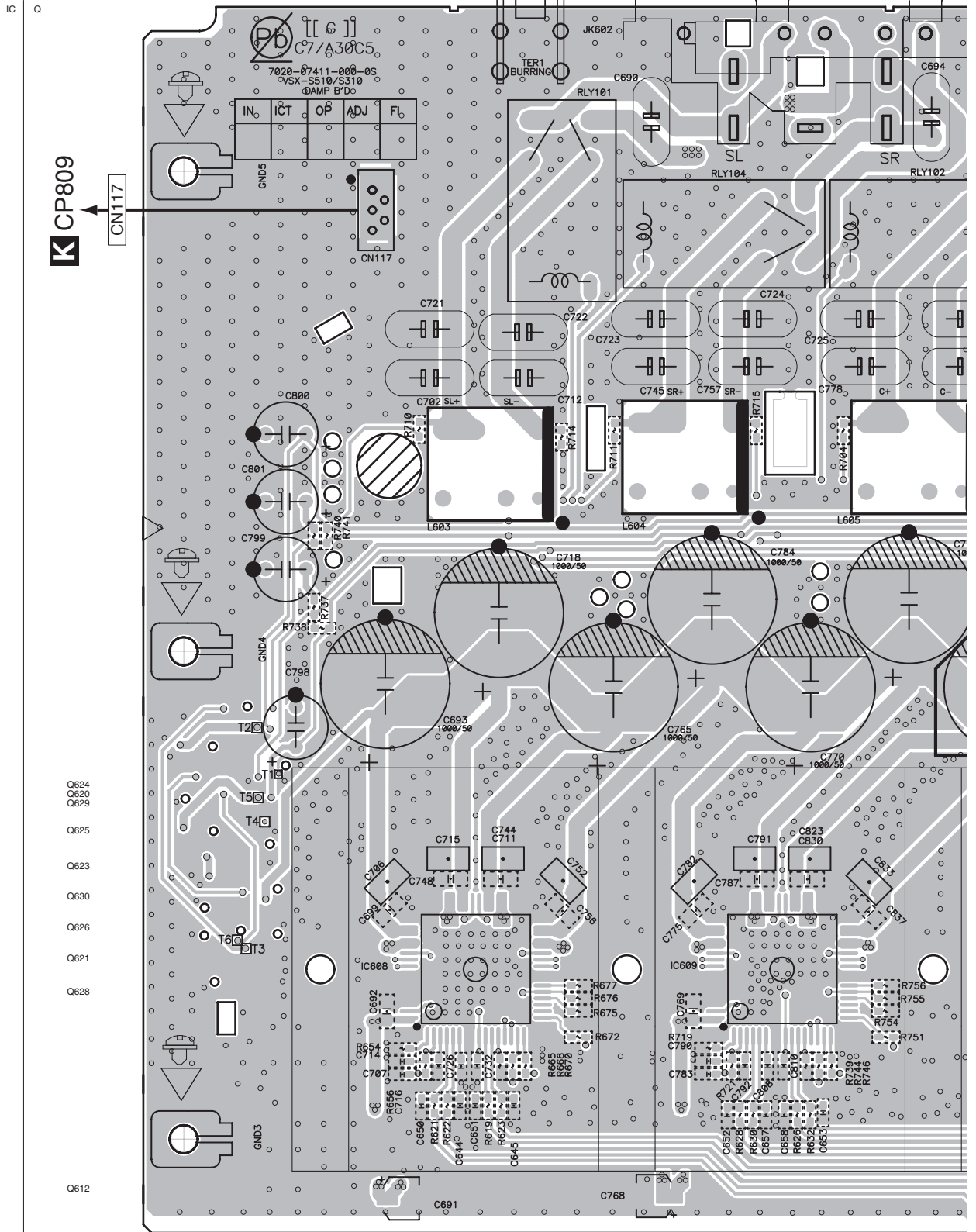

Q624  
Q620  
Q629  
  
Q625  
  
Q623  
  
Q630  
  
Q626  
  
Q621  
  
Q628  
  
Q612

IC608 IC609 IC607





**SIDE A**

A  
B  
C  
D  
E  
F

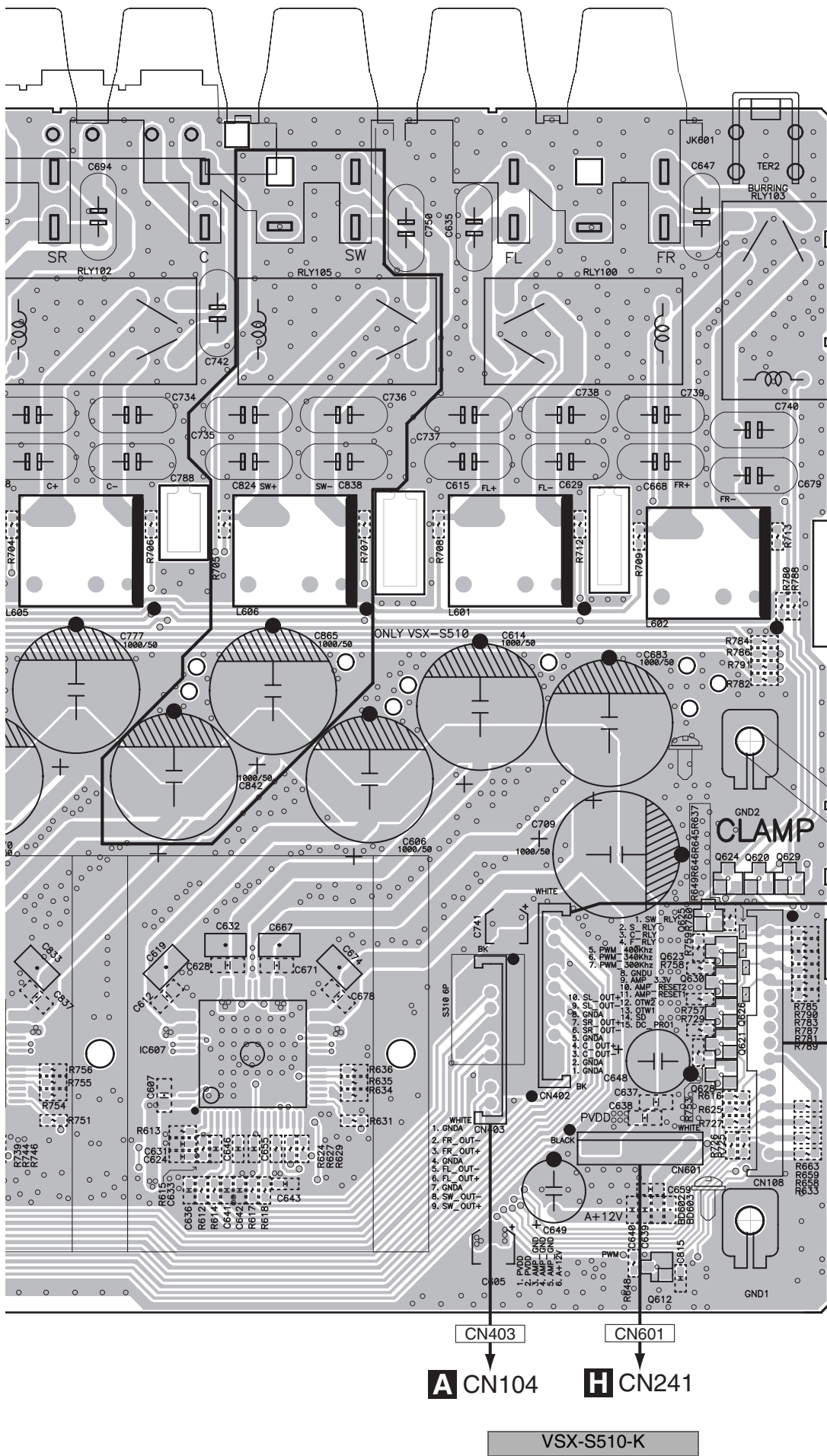

**A** CN104      **H** CN241

VSX-S510-K

**G**

SIDE B

# G DAMP ASSY

A  
B  
C  
D  
E  
F

IC Q  
Q607  
Q610  
Q606  
Q609  
Q604  
Q605  
Q608  
Q613  
Q614

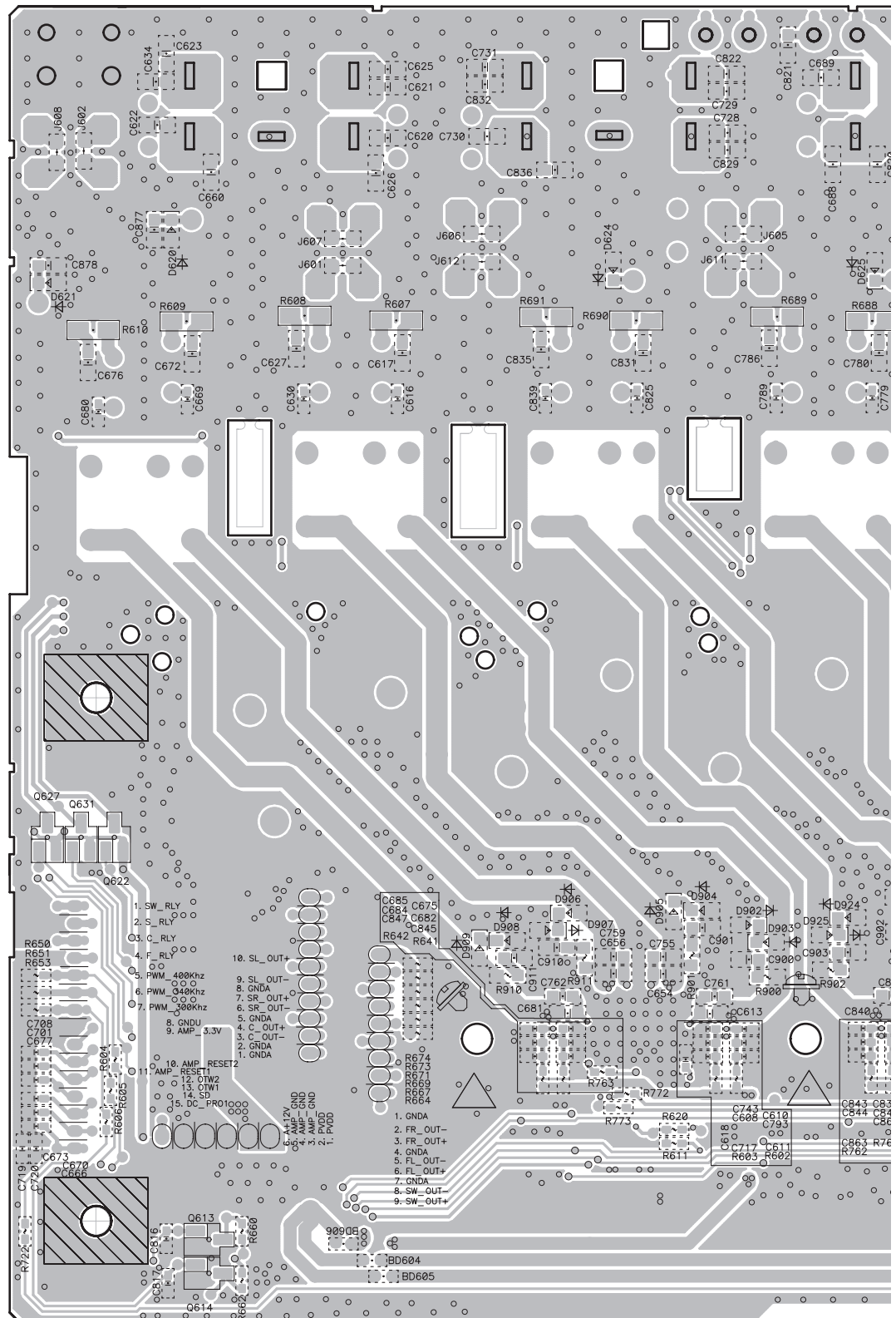

CN601 CN402 CN403



SIDE B

A

B

C

D

E

F

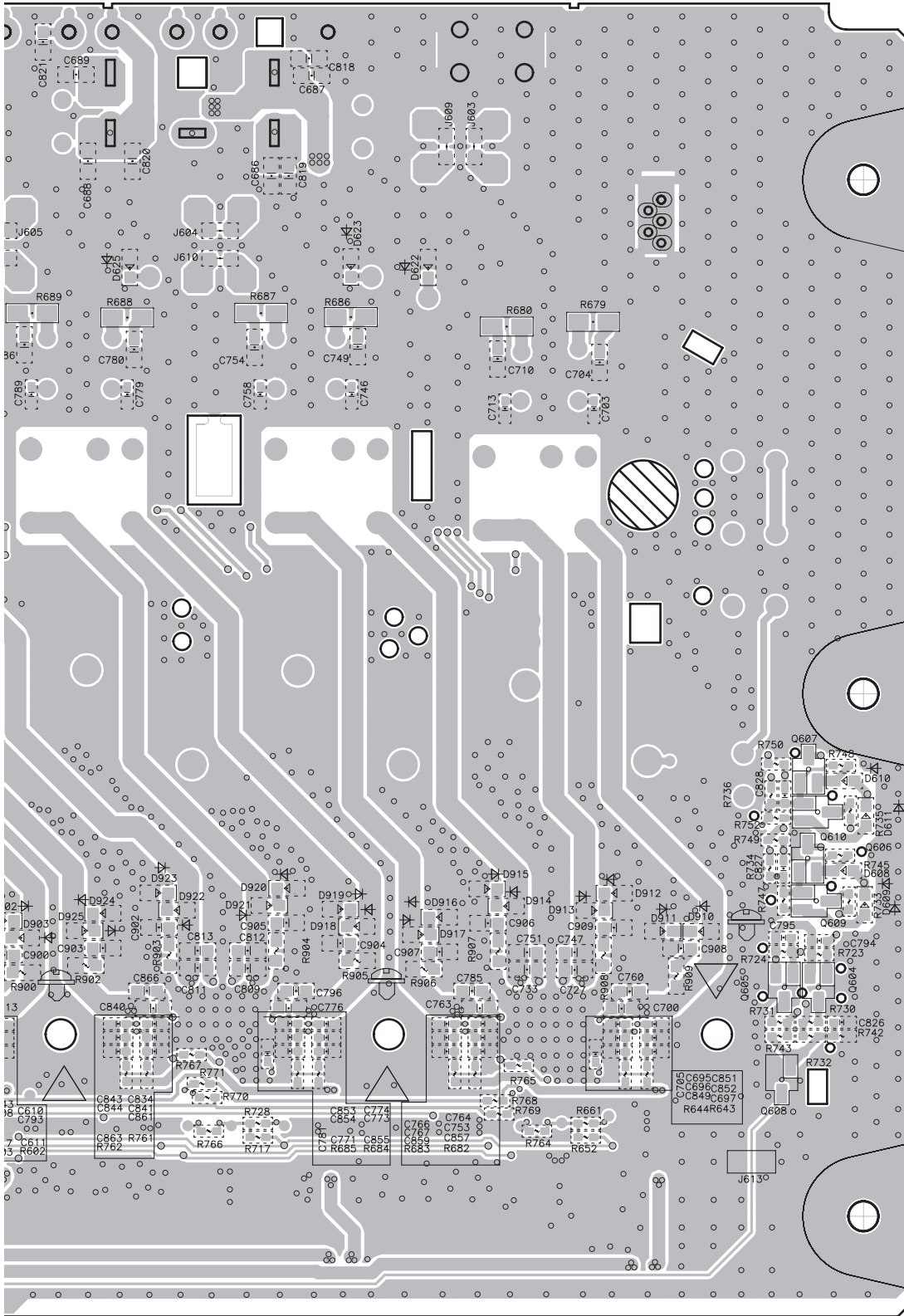

CN117



# 11.7 POWER TRANS ASSY

**SIDE A**

## POWER TRANS ASSY

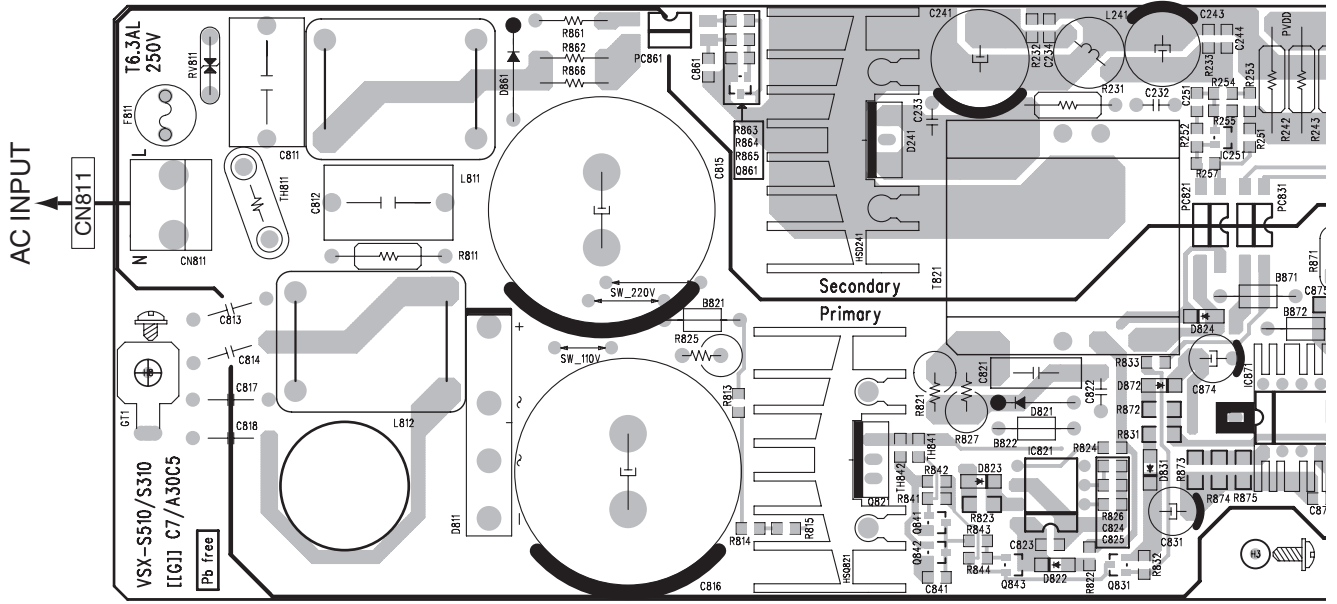

**SIDE B**

## POWER TRANS ASSY

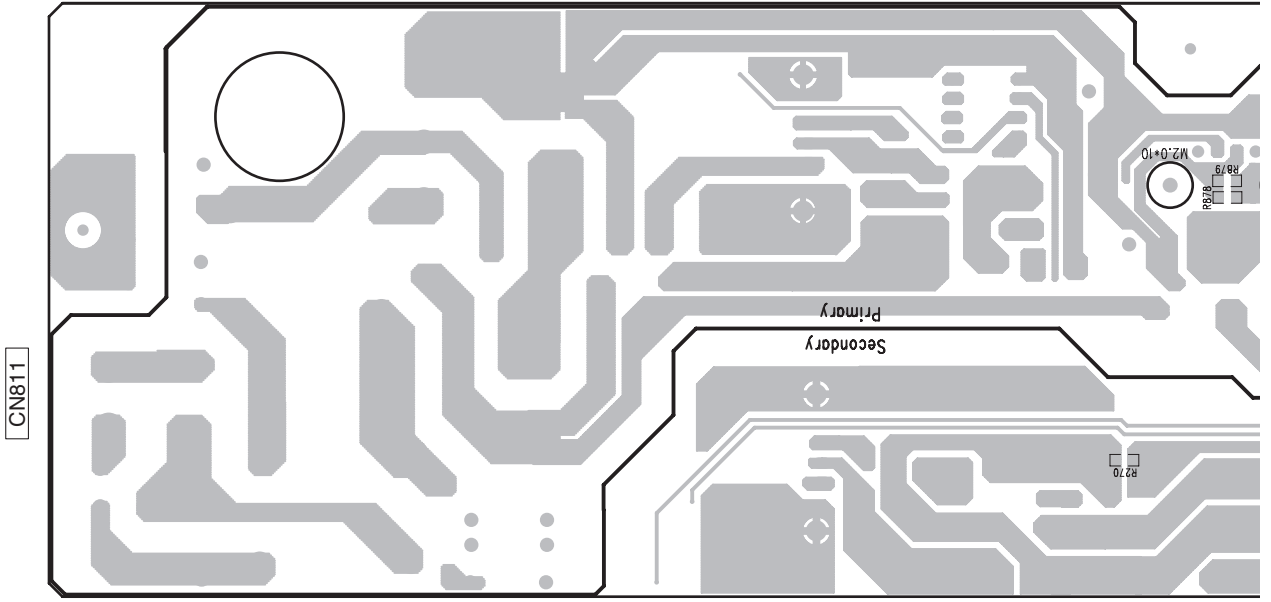

**SIDE A**

A

B

C

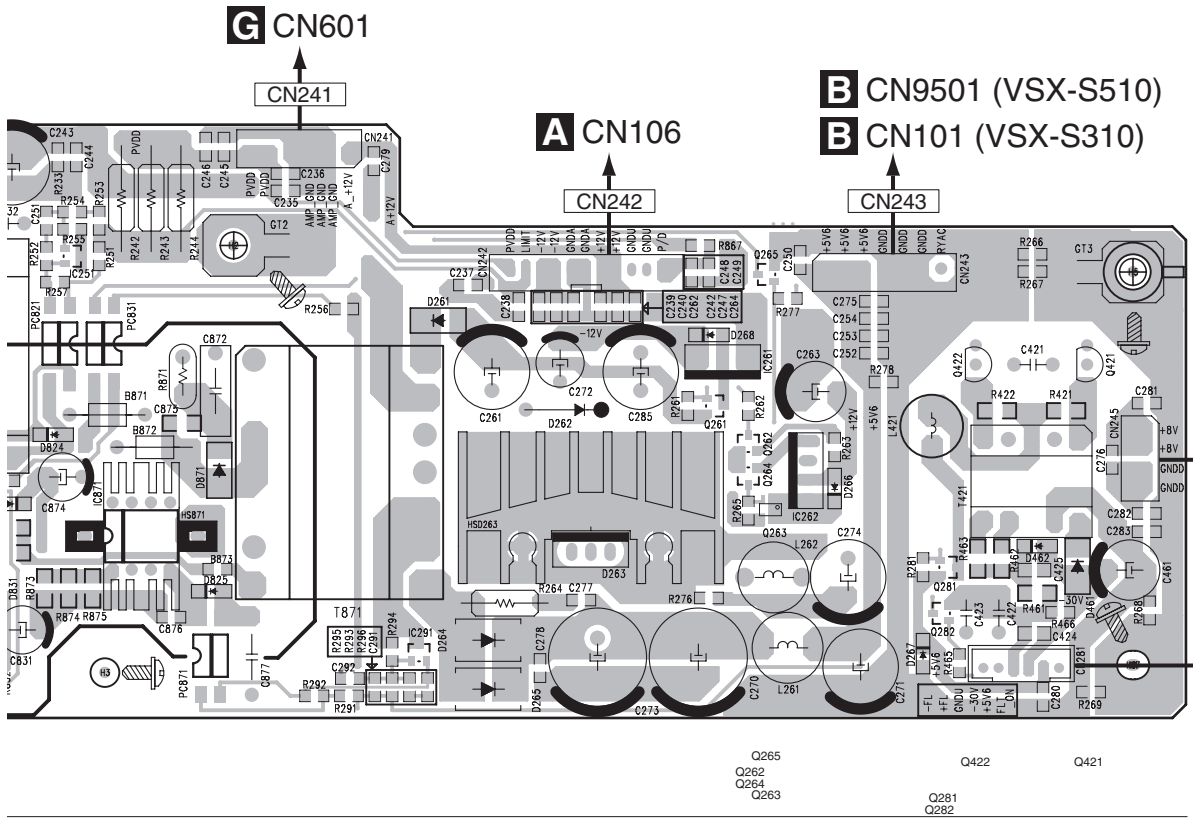

**SIDE B**

D

E

F

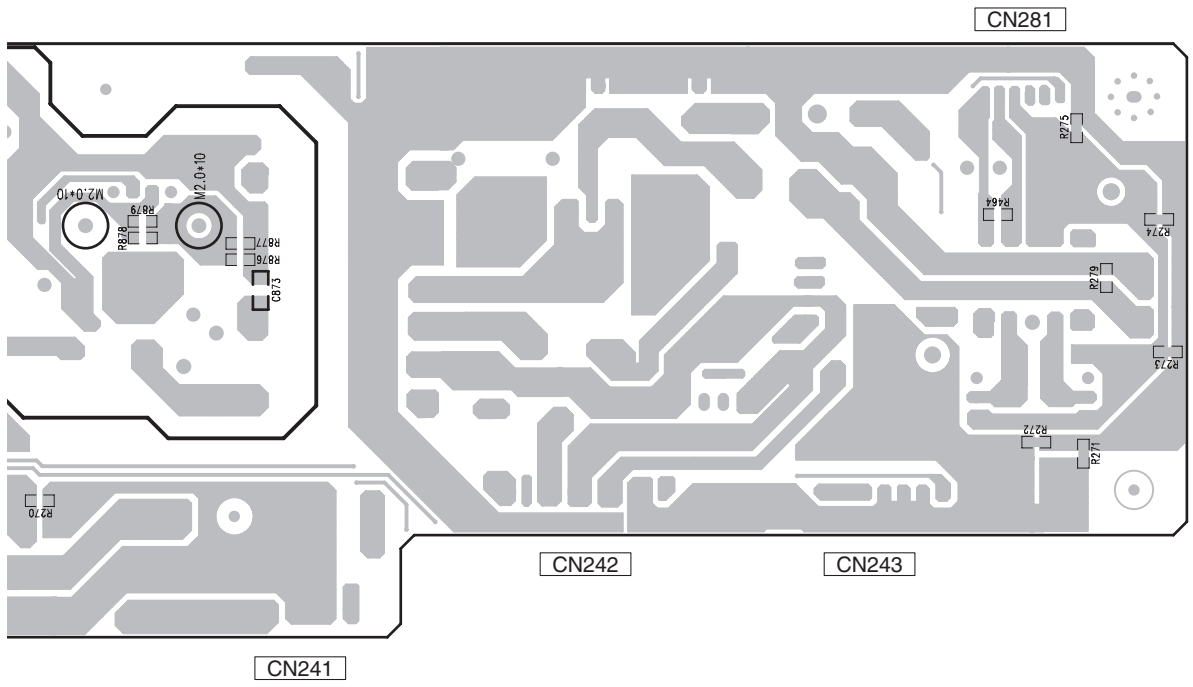

# 11.8 SIDE CNT ASSY and BRIDGE ASSY

**SIDE A**

## SIDE CNT ASSY

**C** CP603

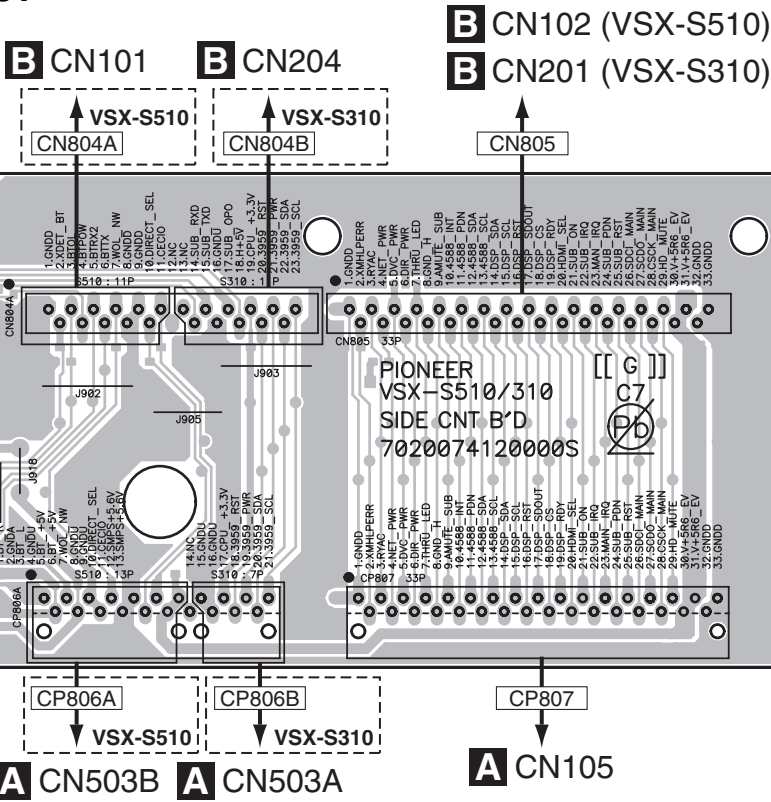

**SIDE B**

## SIDE CNT ASSY

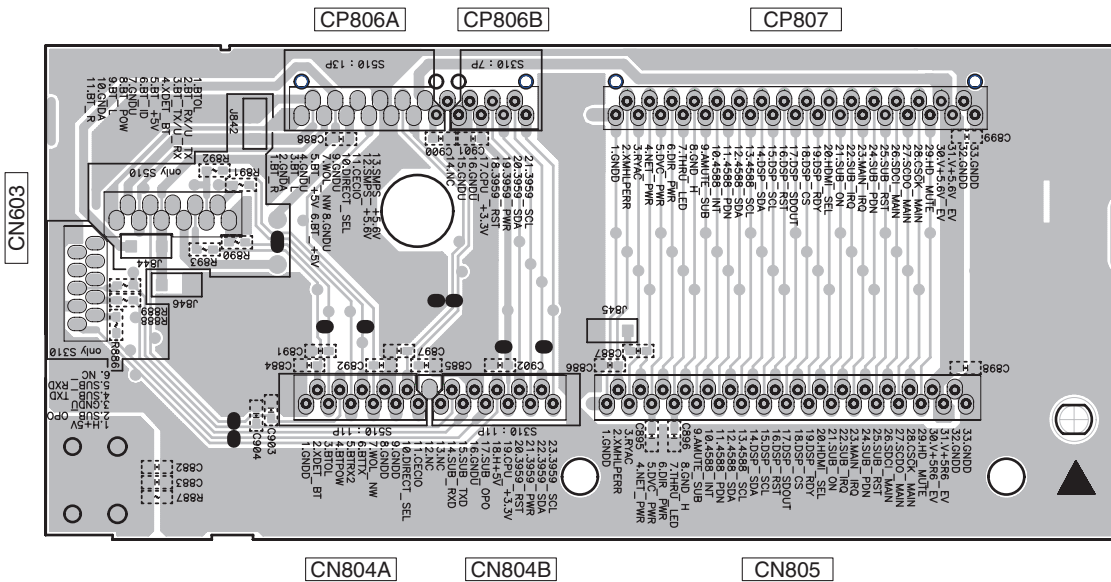

**SIDE A**

**J BRIDGE ASSY**

**A** CN102B (VSX-S510)  
**A** CN102A (VSX-S310)

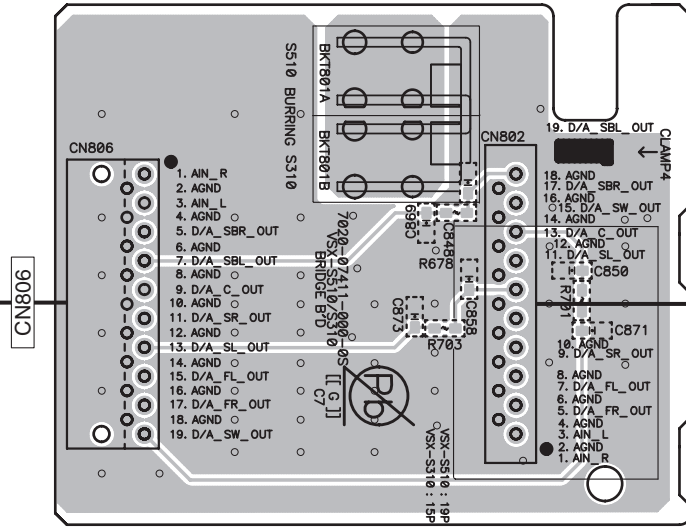

**B** CN1801 (VSX-S510)  
**B** CN2003 (VSX-S310)

**SIDE B**

**J BRIDGE ASSY**

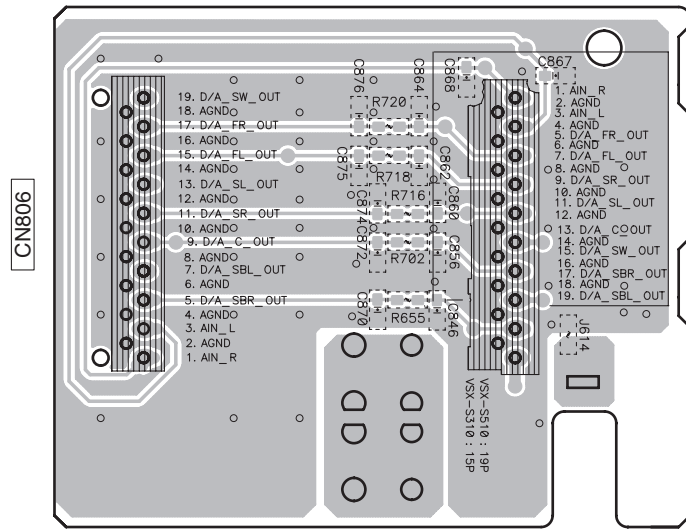

VSX-S510-K

**J**

11.9 AMP GUARD, MAIN GUARD, CABLE (VSX-S510) and CLAMP ASSYS

**SIDE A**

**K AMP GUARD ASSY**

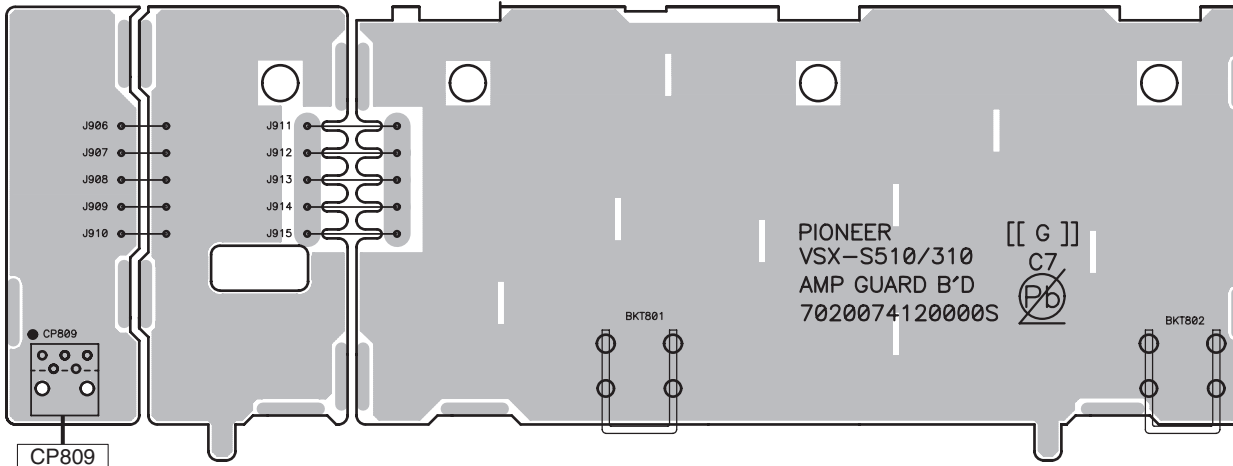

**G CN117**

**L MAIN GUARD ASSY**

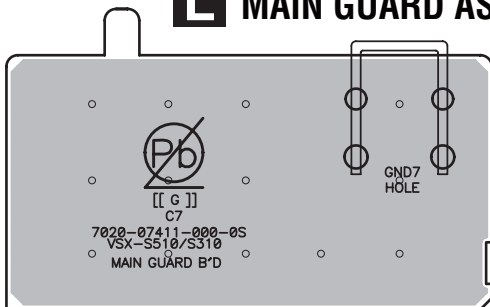

**SIDE B**

**L MAIN GUARD ASSY**

**K AMP GUARD ASSY**

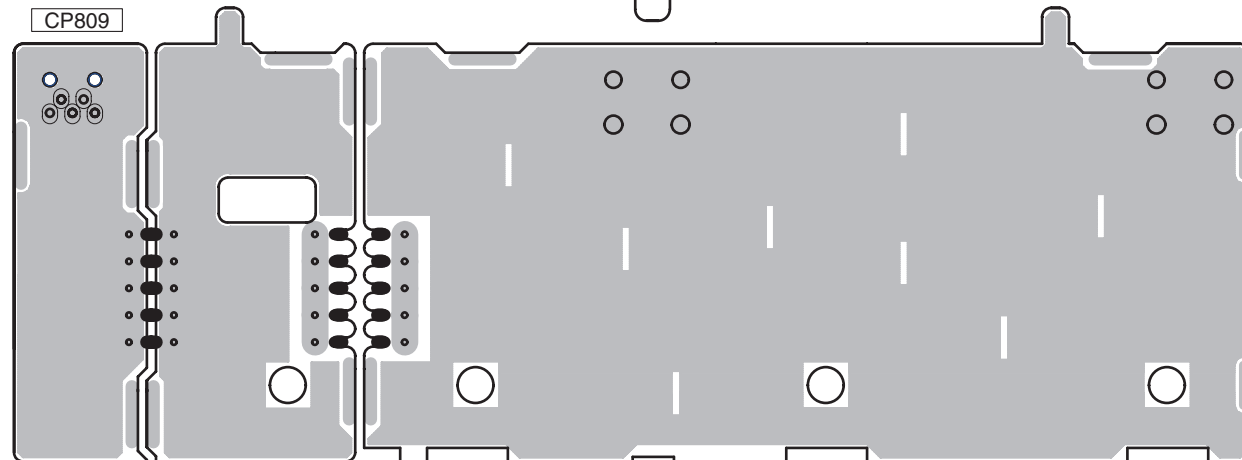

**K L**



**SIDE A**

**M CABLE ASSY**

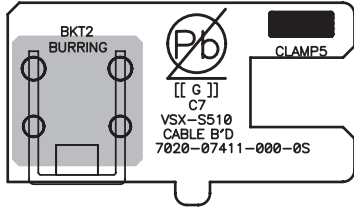

**N CLAMP ASSY (VSX-S310)**

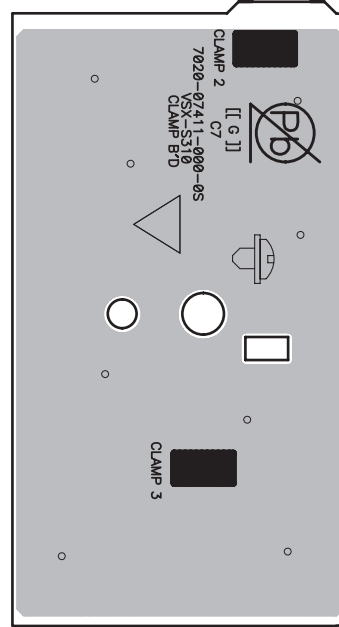

**N CLAMP ASSY (VSX-S510)**

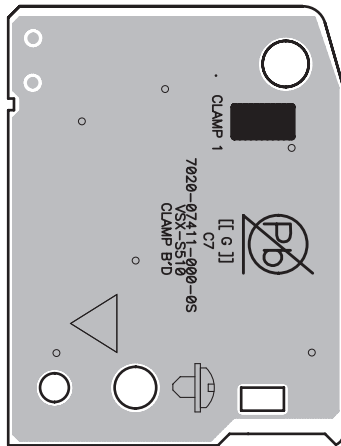

**SIDE B**

**N CLAMP ASSY (VSX-S510)**

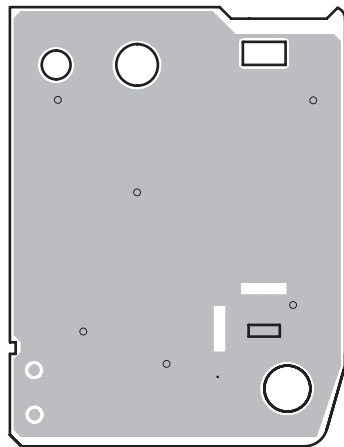

**N CLAMP ASSY (VSX-S310)**

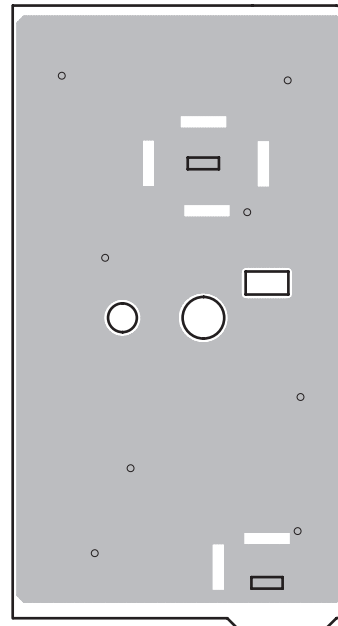

**M CABLE ASSY**

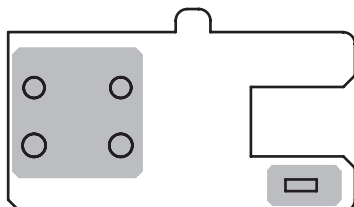

# 12. PCB PARTS LIST

NOTES: ● Parts marked by "NSP" are generally unavailable because they are not in our Master Spare Parts List.

● The  $\Delta$  mark found on some component parts indicates the importance of the safety factor of the part. Therefore, when replacing, be sure to use parts of identical designation.

● When ordering resistors, first convert resistance values into code form as shown in the following examples.

Ex.1 When there are 2 effective digits (any digit apart from 0), such as 560 ohm and 47 k ohm (tolerance is shown by J = 5%, and K = 10%).

$560 \Omega \rightarrow 56 \times 10^1 \rightarrow 561 \dots\dots\dots RD1/4PU \boxed{5} \boxed{6} \boxed{1} J$   
 $47 \text{ k}\Omega \rightarrow 47 \times 10^3 \rightarrow 473 \dots\dots\dots RD1/4PU \boxed{4} \boxed{7} \boxed{3} J$   
 $0.5 \Omega \rightarrow R50 \dots\dots\dots RN2H \boxed{R} \boxed{5} \boxed{0} K$   
 $1 \Omega \rightarrow 1R0 \dots\dots\dots RS1P \boxed{1} \boxed{R} \boxed{0} K$

Ex.2 When there are 3 effective digits (such as in high precision metal film resistors).

$5.62 \text{ k}\Omega \rightarrow 562 \times 10^1 \rightarrow 5621 \dots\dots\dots RN1/4PC \boxed{5} \boxed{6} \boxed{2} \boxed{1} F$

<b>Mark No.</b>	<b>Description</b>	<b>Part No.</b>	<b>Mark No.</b>	<b>Description</b>	<b>Part No.</b>
-----------------	--------------------	-----------------	-----------------	--------------------	-----------------

## LIST OF ASSEMBLIES

NSP	1..MAIN ASSY (VSX-S510) 2..MAIN ASSY	7025HK1301010-IL 7028074101010-IL	NSP	1.. DAMP ASSY (VSX-S310) 2..DAMP ASSY 2..BRIDGE ASSY	7025HK1302012-IL 7028074111050-IL 7028074114050-IL
NSP	1..MAIN ASSY (VSX-S310) 2..MAIN ASSY	7025HK1302010-IL 7028074101050-IL	NSP	2..MAIN GUARD ASSY 2..USB ASSY 2..CLAMP ASSY	7028074115010-IL 7028074116050-IL 7028074117050-IL
NSP	1..FRONT ASSY (VSX-S510) 2..FRONT ASSY 2..AMP GUARD ASSY 2..SIDE CNT ASSY	7025HK1301011-IL 7028074121010-IL 7028074123010-IL 7028074124010-IL	NSP	1..DMAIN ASSY (VSX-S510) 2..DMAIN ASSY	7025HK1301013-IL 70280732310C0-IL
NSP	1..FRONT ASSY (VSX-S310) 2..FRONT ASSY 2..AMP GUARD ASSY 2..SIDE CNT ASSY	7025HK1302011-IL 7028074121050-IL 7028074123010-IL 7028074124050-IL	NSP	1..DMAIN ASSY (VSX-S310) 2..DMAIN ASSY	7025HK1302013-IL 7028073351090-IL
NSP	1.. DAMP ASSY (VSX-S510) 2..DAMP ASSY 2..BT ASSY 2..CABLE ASSY 2..BRIDGE ASSY 2..MAIN GUARD ASSY 2..CLAMP ASSY	7025HK1301012-IL 7028074111010-IL 7028074112010-IL 7028074113010-IL 7028074114010-IL 7028074115010-IL 7028074117010-IL	NSP	1..POWER TRANS ASSY (VSX-S510) 1..POWER TRANS ASSY (VSX-S310)	8208001050010-IL 8208001050030-IL

## **A** MAIN ASSY

70280741010-IL and 7028074101050-IL are constructed the same except for the following:

Mark	Symbol and Description	70280741010-IL	7028074101050-IL
	IC101	J127380010060-IL	J127762060010-IL
	IC102	Not used	J170747810010-IL
	IC104	J040405200060-IL	J040740800240-IL
	IC106	J121458000050-IL	Not used
	IC115	J121458000050-IL	Not used
	IC119	SN74AHC1G08DCK	Not used
	IC122	J126111733230-IL	Not used
	IC124	J121458000050-IL	Not used
	IC125	J121718100010-IL	Not used
	IC802	J126238600050-IL	J126111733230-IL
	JA106 Ter,rca 1pin	Not used	G600107AY000Y-IL
	JA802 Cn,plug Contact	G480400201010-IL	Not used
	X101 Crystal	Not used	E80017R734410-IL

## **F** FRONT ASSY

7028074121010-IL and 7028074121050-IL are constructed the same except for the following:

Mark	Symbol and Description	7028074121010-IL	7028074121050-IL
	D800	K500036000160-IL	K500052009011-IL
	D801	K500036000160-IL	K500052009011-IL

## **G** DAMP ASSY

7028074111010-IL and 7028074111050-IL are constructed the same except for the following:

Mark	Symbol and Description	7028074111010-IL	7028074111050-IL
	RY105 Relay	G680060103010-IL	Not used
	C842	D041102087010-IL	Not used
	C865	D041102087010-IL	Not used

## **I** SIDE CNT ASSY

7028074124010-IL and 7028074124050-IL are constructed the same except for the following:

Mark	Symbol and Description	7028074124010-IL	7028074124050-IL
	CN603 Cn,wafer	L109012511120-IL	Not used
	CN805 Cn,wafer	L109012511120-IL	L109012513320-IL

**Mark No. Description** \_\_\_\_\_ **Part No.** \_\_\_\_\_

**Mark No. Description** \_\_\_\_\_ **Part No.** \_\_\_\_\_

**A** **A MAIN ASSY**

**B** **DMAIN ASSY (VSX-S310)**

**SEMICONDUCTORS**

**SEMICONDUCTORS**

	IC 103	TC7WHU04FK
	IC 105	J084152180010-IL
	IC 106,108-117,124	J121458000050-IL
	IC 107	J040405200060-IL
⚠	IC 118	S-1170B50UC-OIJ
	IC 119	SN74AHC1G08DCK
	IC 121	J000241600170-IL
⚠	IC 122	J126111733230-IL
	IC 123	J020303020040-IL
B	IC 125	J121718100010-IL
⚠	IC 802	J126238600050-IL
	IC 803	J127380010060-IL
⚠	Q 108,114	J5001281Y0010-IL
⚠	Q 109,115	J5023209Y0010-IL

	IC 2001	J020025A00640-IL
⚠	IC 2004	NJM2831F33
⚠	IC 2005,2006	S-1170B50UC-OIJ
	IC 2007	J048650300010-IL
⚠	IC 2008	MM3529A32P
	IC 2011	AK4588VQ
	IC 2012	J046944201280-IL
⚠	IC 2013	J126111712070-IL
	IC 2014	J040742570040-IL
⚠	IC 2015	J126111718230-IL
	IC 2016	D808K013DPTP400
⚠	IC 2017	J126108600080-IL
	IC 2018	J001986466010-IL
	IC 2019	J005253200060-IL
	IC 2020	J044337395930-IL

**MISCELLANEOUS**

	JA 100	TER,RCA 1PIN	G600107A0000Y-IL
	JA 104	MODULE	E100802000250-IL
	JA 802	CN,PLUG CONTACT	G480400201010-IL
	RY 100	RELAY	G680240202030-IL
	X 100	CRYSTAL	E80016R000030-IL

⚠	IC 2021	BA00DD0WHFP
	IC 2024	J127380010060-IL
	IC 2026	J000240160080-IL
	Q 2026,2036,2040,2042	J543608000010-IL

**CAPACITORS**

	C 423	D040102081070-IL
--	-------	------------------

**MISCELLANEOUS**

	X 2000,2001 CRYSTAL	E80024R000030-IL
	X 2002 CRYSTAL	E80024R576040-IL

**B** **DMAIN ASSY (VSX-S510)**

**C** **BT ASSY (VSX-S510)**

**SEMICONDUCTORS**

**SEMICONDUCTORS**

⚠	IC 103	NJM2831F33
	IC 1201	J003400010230-IL
D	IC 1501,1509,1510	TC74VHC157FK
	IC 1513	TC7SH08FUS1
⚠	IC 1605	AAT4610BIGV-1
	IC 1612	J005254001010-IL
	IC 1801	AK4588VQ
	IC 1804,9601	TC74VHC08FK
	IC 1808	TC7WHU04FK
	IC 9002	J080320788010-IL
	IC 9003	J001986466010-IL
	IC 9004	J005291607010-IL
	IC 9201,9209	A3V56S30FTP-G6
E	IC 9205	J0059F1008020-IL
	IC 9206	J044337395930-IL
⚠	IC 9450,9502	MM3529A12P
⚠	IC 9511	MM3529A50P
⚠	IC 9555	MM3411A50N
	IC 9602	SI19573CTUC
	Q 401	J543608000010-IL
	Q 403	RAQ045P01

	IC 600	BD2224G
--	--------	---------

**D** **FHDMI ASSY (VSX-S510)**

**SEMICONDUCTORS**

	IC 500	J127380010010-IL
	IC 501	J127380100050-IL
	IC 502	PCA9517DGK
	IC 503	J048650300010-IL

**MISCELLANEOUS**

	JA 502	CN,PLUG CONTACT	G480400201010-IL
--	--------	-----------------	------------------

**E** **USB ASSY (VSX-S310)**

**MISCELLANEOUS**

	JA 803	CN,PLUG CONTACT	G480040000180-IL
--	--------	-----------------	------------------

**MISCELLANEOUS**

	JA 1601,9601-9605 CN.WAFER	L109100190160-IL
F	JA 9202 JACK,MODULAR	G4060RJ450230-IL

Mark No. Description Part No.

## **F** FRONT ASSY

### SEMICONDUCTORS

IC 800	J127197044010-IL
IC 801	J121458000050-IL
⚠ Q 801	J5001266G0050-IL
D 800,801	K500036000160-IL

### MISCELLANEOUS

JA 800,801 JACK,D3.5	G401PJ354H71Y-IL
S 800-805 SWITCH	G180501000010-IL
S 810 SW,ENCODER	G121122400060-IL
S 811 SW,ENCODER	G121122400330-IL
800 CUSHION	4050214865000-IL
801 TAPE	1220211629000-IL
802 HOLDER	4320211196000-IL
U 800 DISPLAY,FLT	K530126600011-IL
U 801 MODULE,REMOCON	E940348003810-IL

## **G** DAMP ASSY

### MISCELLANEOUS

RY 100-105 RELAY	G680060103010-IL
600-602 SHEET (HEAT)	1210211399000-IL
604-607 SCREW	B020030081B10-IL

### CAPACITORS

C 606,614,683,693	D041102087010-IL
C 709,718,765,770	D041102087010-IL
C 777,784,842,865	D041102087010-IL

## **H** POWER TRANS ASSY

POWER TRANS ASSY has no service parts.

## **I** SIDE CNT ASSY

### MISCELLANEOUS

CN 603,804,805 CN,WAFER	L109012511120-IL
-------------------------	------------------

## **J** BRIDGE ASSY

BRIDGE ASSY has no service parts.

## **K** AMP GUARD ASSY

AMP GUARD ASSY has no service parts.

## **L** MAIN GUARD ASSY

MAIN GUARD ASSY has no service parts.

Mark No. Description Part No.

## **M** CABLE ASSY (VSX-S510)

CABLE ASSY has no service parts.

## **N** CLAMP ASSY

CLAMP ASSY has no service parts.