

Rane Corp. (425)355-6000
 106698 DES MAIN PE 17
 ACTION: NEW LAYOUT, SKH 18JAN03

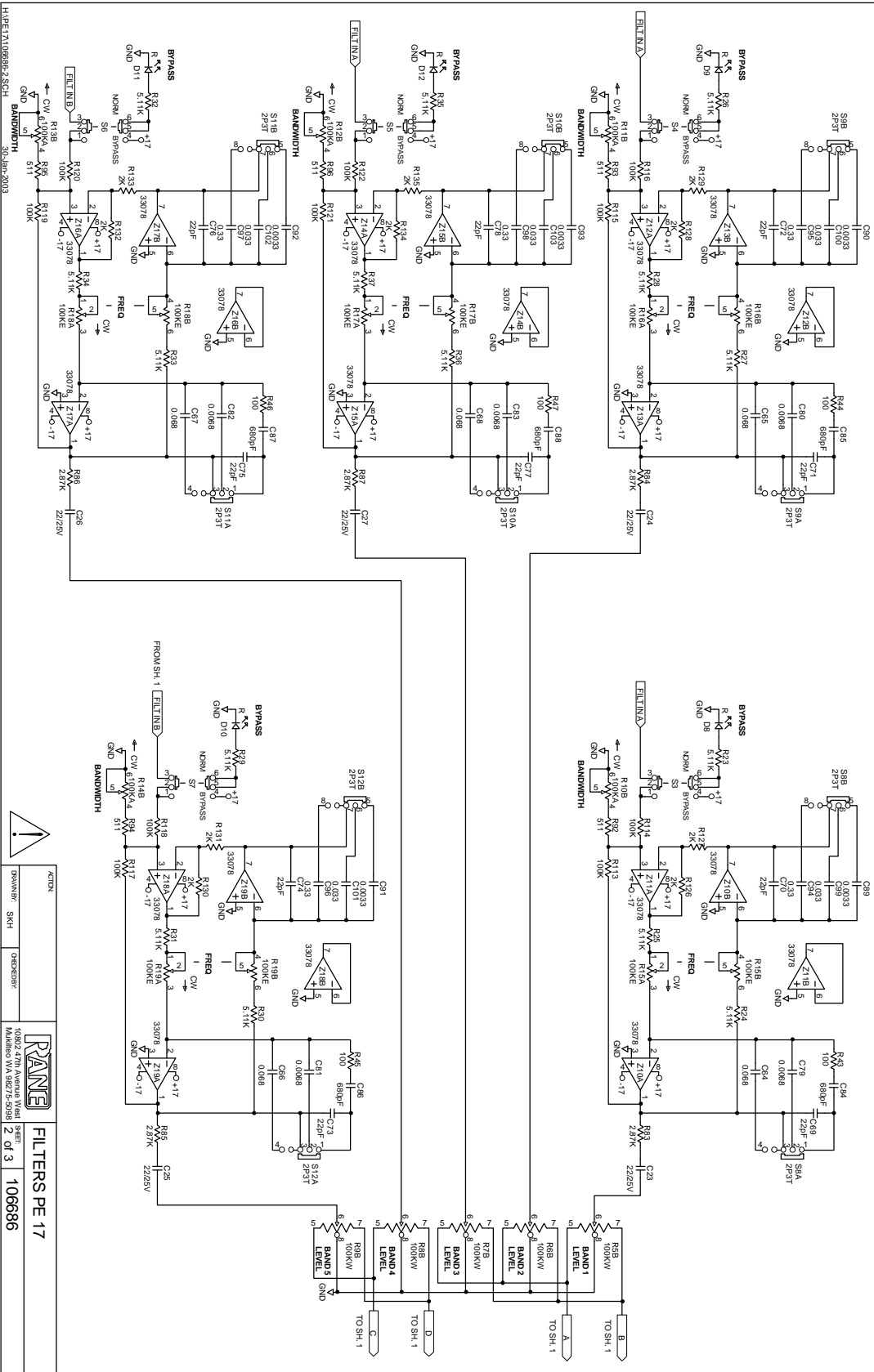

HPE17A086862.SCH 30.Jan.2003



ACTION: DRAWING: SKW CHECKED:

PANE FILTERS PE 17
 10862 27th Avenue West
 Hudson, WA 98275-5881 Z of 3 106686

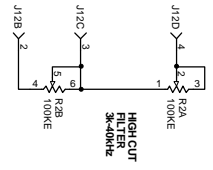
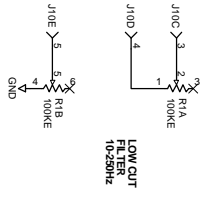
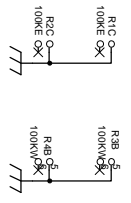
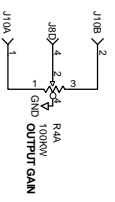
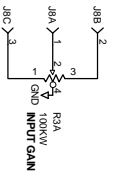
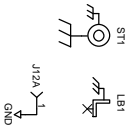

HPE11106886-3.SCH 30-Jan-2003



ACTION		DRAWN BY: SKH		CHECKED BY:		 10802 47th Avenue West Tukwila WA 98175-3898		SHEET 3 of 3		SLIDER PE 17 106686	
--------	--	---------------	--	-------------	--	--	--	-----------------	--	------------------------	--